



User's Guide

Service Center

USA

AVC Tech, INC.
777 Mark Street,
Wood Dale, IL 60191
Tel : 800-568-0060 or 630-595-0123
Fax :800-784-9422 or 630-595-2345
e-mail :peterlee@hyundaimonitor.com

GERMANY

Hyundai Imagequest Europe GMBH
Geheimrat Hummel Platz 2
65239, Hochheim, Germany
Tel : 49 6146 904 418
Fax : 49 6146 904 410
E-mail: service@hyundaiq.de
URL: www.hyundaiit.com

NEWZEALAND

Vantex Technology Distribution Ltd
635 Great South Road,
Penrose, Auckland.
Tel : 64 9 571 0775
Fax : 64 9 571 0776
e-mail : kimmw@vantex.co.nz

AUSTRALIA

Thomas Electronics ESG Pty Ltd.
3 Sheridan Close
Milperra, NSW 2214, Australia
Tel : 61 2 8723 6528
Fax : 61 2 8723 6588
E-mail: leanne_crawford@thomas.com.au

JAPAN

Hyundai ImageQuest Japan., Ltd
7th FL, Dai-Bldg, 1-3-3
Uchisaiwai - Cho Chiyoda - Ku
Tokyo, Japan 100-0011
Tel : 81 03 5157 2286
Fax : 81 03 5157 2268
E-mail: pjkim@hyundaiq.co.jp

Digital LCD TV

MODELS : E260D | E320D | E370D | E420D | E460D
E261D | E321D | E371D | E421D | E461D

Table of Contents

General Information

Important Tip/Image Sticking Precaution	1
Safety Precaution	2
Contents of the Package	6
Products Sold Separately	6
Parts Names and Functions	7
Remote Control	11

Connections

Connecting Indoor/Outdoor TV Antenna(UHF/VHF)	13
Connecting Antenna input Connection to External Equipments	13
Before Connecting the Video/Audio Connections to External Devices... ..	14
How to Connect a DTV Receiver or DVD Player	14
How to Connect a VCR, Cable Receiver, Camcorder, Game Player	15
How to Connect to a PC	15
Scart Connection to the External Input/Output	16
HDMI Connection (For HDMI model only)	17
How to Set the OSD Screen	18

Picture Setup

How to Select the Picture Mode	19
How to Set the Desired Picture	19
How to Set the Desired Picture in PC, DVI, HDMI Input Modes	20
How to Set Image Adjust in PC Mode	20
How to Select a Color Tone	21
How to Set the Display Size	21
How to Set Noise Reduction(NR)	22
How to Set Film Mode	22

Sound Setup

How to Select the Audio Mode	23
How to Adjust the Desired Audio Mode	23
How to Select Auto Volume.....	24
How to Select Sound Mode.....	24
How to Select Surround	25

Channel Setup

How to Select Auto Store	26
How to Select Manual Store	26
How to Set the Program Edit(Add/Delete,Sort,Name)	27

How to Fine Tune	28
------------------------	----

PIP Setup

How to Set PIP	28
----------------------	----

Function Setup

How to Reset	30
How to Set Clock, Sleep Time, ON/OFF Time	30
Choosing the your Language	31
How to Set OSD Tone	32
How to Set Teletext in ATV	32
Selecting Teletext Display Options in ATV Mode	33
How to Set Key-Lock	33

DTV Setup

How to Search Automatically	34
How to Search Manually	34
How to Check Channel State	35
How to Use the Guide (EPG : Electronic Program Guide)	36
How to Select Channel List	37
How to Set Favorite Channel	37
How to Use Channel List Mode	38
How to Lock Channel	38
How to Set the Channel Order	39
How to Delete Channel	39
How to Add Channel	40
How to Factory Set	40
How to Day Light Saving Time(Summer Time)	41
How to TV/RADIO switching	41
How to Subtitle / Audio	42
How to Select Channel / Information	42
How to Set Teletext in DTV	43

Appendix

Troubleshooting	44
Product Specifications	46

Image Sticking Precaution

When watching a still Image within motion pictures and Wide/Panorama/Zoom/ /4:3 screen/14:9

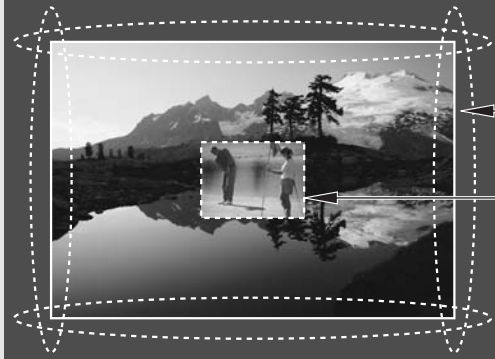

Wide,Panorama,Zoom,4:3,14:9, screen

Box still image

1. Note :

- When the central area of the screen and the screen edges are fixed, the different brightness level of the edges may cause image retentions on the edges when watching for a long time
- This phenomenon happens also to products from other manufacturers. Please avoid watching a still image for a long time.
- If you watch a still image for a long time, this may damage your TV.

* This matter does not come under the warranty.

Safety Precaution

The contents of this section are provided for the safety of users and their property. Please read the instructions carefully before using.

Outdoor Antenna Grounding

If an outside antenna or cable system is connected to the TV, be sure the antenna or cable system is grounded so as to provide some protection against voltage surges and built-up static charges. Section 810 of the National Electrical Code, ANSI/NFPA No.70-1984, provides information about proper grounding of the mast and supporting structure, grounding of the lead-in wire to an antenna discharge unit, size of grounding conductors, location of antenna discharge unit, connection to grounding electrodes, and requirements for the grounding electrode.

Example of Grounding According to National Electrical Code Instruction

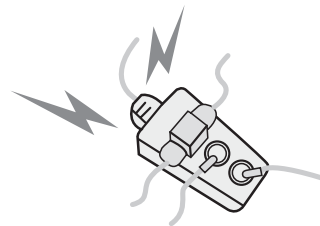
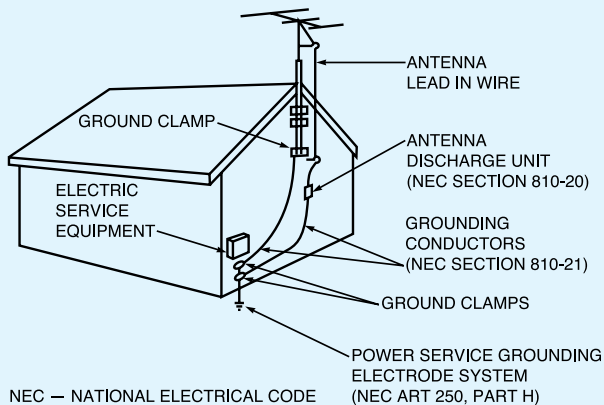

Do not connect multiple electrical appliances to a single outlet.

- It may cause a fire due to overheating from the outlet.



Make sure to remove the speakers before moving the TV with speakers mounted on it.

- When the speakers are detached from the unit while carrying it, this may cause damage to the unit or personal injury.

Do not use or store a flammable spray or inflammable things near the TV.

- They may cause explosion or fire.

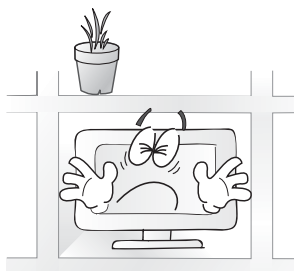
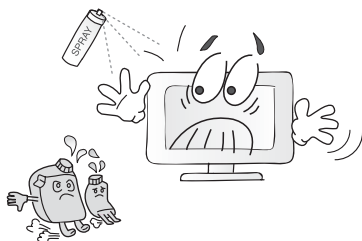

Do not install the TV in a bookshelf, closet, or a place with poor air circulation.

- Fire may be caused due to the rise of internal temperature.

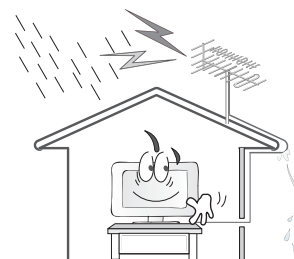

Any necessary action such as making the antenna cable loop at the entrance of the building should be taken to prevent rainwater on the outdoor antenna cable from possibly running indoor.

- If raindrop gets into the TV, it may cause a fire or an electric shock.

Safety PrecautionContinued from previous page

The contents of this section are provided for the safety of users and their property.
Please read the instructions carefully before using.

ENGLISH

If there is a persistent accumulation of dusts or water on the plug, please make sure to wipe it off using a dry cloth.
- It may cause a fire or an electric shock.

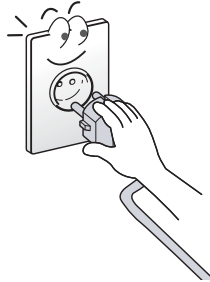

Firmly plug in the power cord so that it does not pull out.
- An unstable connection may cause fire.

Do not use a damaged power cord or plug, or loose outlet.
- It may cause electric shock or fire.

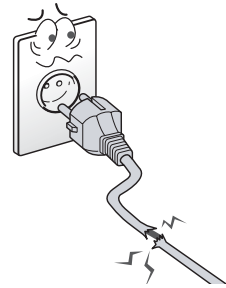

Do not put a water bowl, vase, candle, bug repellent, smoke, cigarette, plants, or heavy thing on the TV.

- It may cause electric shock or fire and also heavy things may cause injury when they fall.

Do not install in a place where there is oil, smoke, excessive humidity, or where water may be sprinkled on it.
- This may cause electric shock or fire.

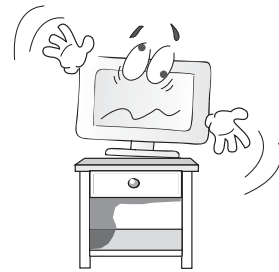

Do not install on an unstable place or small support.

- This may cause the TV to fall, resulting in serious injury especially to children.

Never attempt to open, fix, or modify your TV.

- When there is a need for fixing, call a service center. Fire or electric shock may be caused.



Do not put a metallic object like chopstick, wire, or puncher or inflammables like paper or a match in a vent, headphone jack, or AV jacks of the TV.

- Electric shock or fire may be caused.

When the TV produces abnormal noise, burning smell, or smoke, unplug the TV immediately and call a service center.

- Electric shock or fire may be caused.



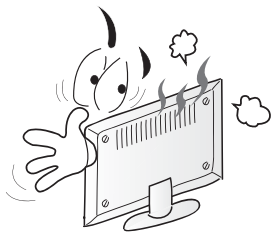

Please avoid touching the panel at the rear of TV as it is producing high temperature.
 - Direct contact with the hot surface may cause physical burns.



Do not place any heat sources such as radiators and heat registers, etc. near the TV.
 - It may cause a fire.

Do not block ventilating slits with a table cloth.

- Blocking the ventilation slits may produce internal heat increase, resulting in a fire.

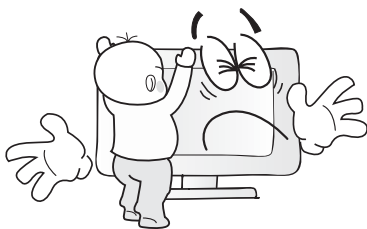

Do not allow children to climb or play on the TV.
 - This may cause the TV to fall resulting in serious injury.

Do not place toys and cookies, etc. on the TV, which may attract children's attention.
 - This may cause the TV to fall, resulting in serious injury.

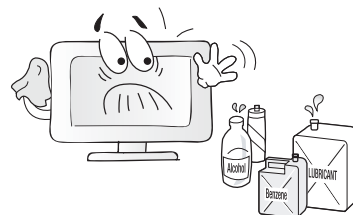
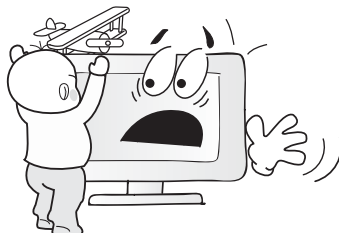

When cleaning the TV, make sure to disconnect the power plug and use a dry, soft cloth for a cleanup.

- Please avoid using chemicals such as wax, benzene, alcohol, thinner, mosquito spray, air freshener, lubricant or synthetic detergent.

Unplug when you do not use your TV for a long time.

- If dust is stacked on the TV, electric shock or fire may be caused from heat, fire, or deterioration of insulation.

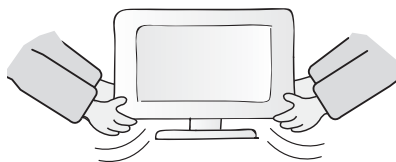
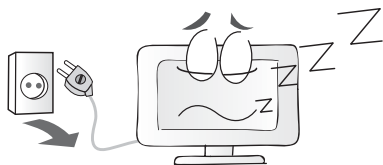

When moving the TV, two or more people are advised to carry it.
 - This may cause damage to the unit or personal injury.

Never touch the power plug or outlet with wet hands.

- This may cause electric shock.

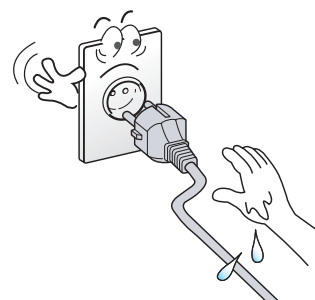

Safety PrecautionContinued from previous page

The contents of this section are provided for the safety of users and their property.
Please read the instructions carefully before using.

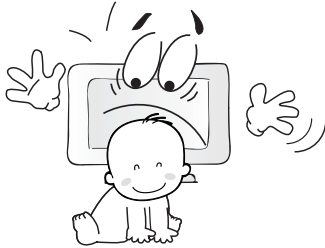

Do not install the product on the floor.
- This may cause the TV to fall resulting in serious injury.

Unplug the product during lightning or thunderstorms and never touch the antenna cable.
- It may cause a fire or an electric shock.

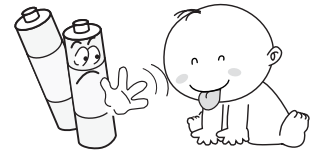
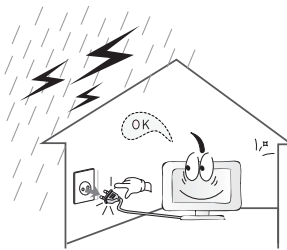

Keep the remote control batteries out of sight and out reach of children.
- If your child swallows a battery, see your doctor immediately.

When replacing batteries, make sure to match the batteries to the (+) and (-) marks in the battery compartment.

- Mismatching of polarities may result in internal damage to batteries, fire due to leakage or contamination.

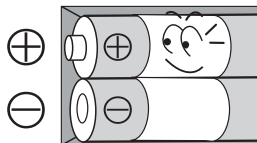
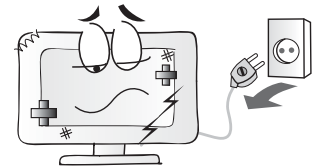
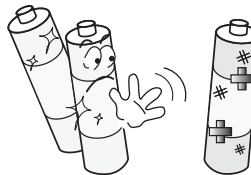

Always use the standard batteries and avoid using old batteries together with new ones.

- Otherwise it may result in internal damage to batteries, fire due to leakage or contamination.

In the event of damaging or dropping the product, switch off the power and remove the plug.

- Using a damaged product may cause an electric shock or a fire.
- Contact your local service center.

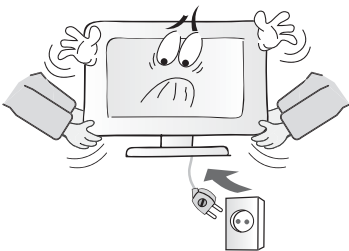

Before moving the product, ensure to switch off the power and unplug all the electrical cords and the external connection cords such as an antenna cable and other source connections, etc.

- Electrical cords may be damaged, resulting in a fire or an electrical shock.

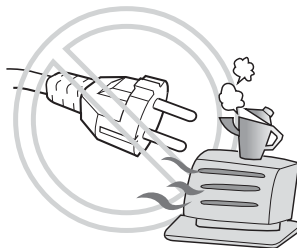

Ensure the power cord doesn't trail across any hot objects like a heater.

- This may cause a fire or an electric shock.

Consult a service center or customer service for inside cleaning about once a year.

- When dust is piled inside the TV for a long time, fire or malfunction may be caused.



Contents of the Package

When opening the package, please ensure to check the following accessories.

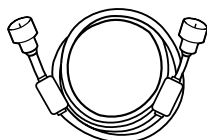

Antenna Cable
(coaxial cable)

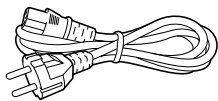

Power Cord

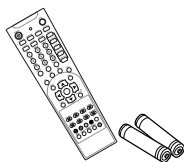

Remote Control &
2 batteries (1.5V AAA)

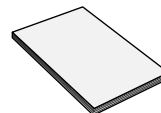

User's Guide

Products Sold Separately

If you want to purchase the following accessories, consult a service center, electronics shops, or parts seller.

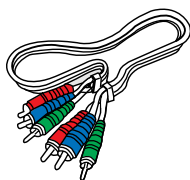

Component(Y, Pb, Pr) cable

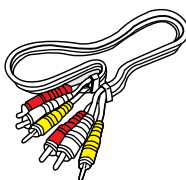

Composite(Video & Audio) cable

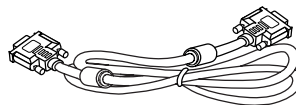

DVI PC video(digital) cable

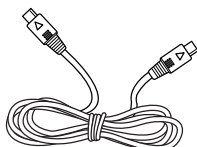

S-video cable

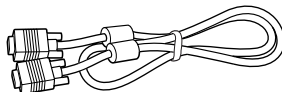

PC signal cable

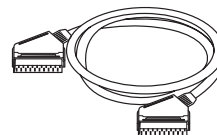

Scart cable



HDMI cable



Audio Cable (DVI/DVD)



Audio Cable (PC)

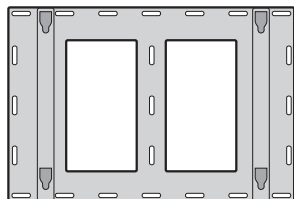

Wall mounting frame

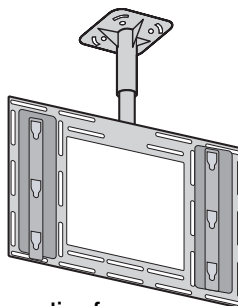

Wall mounting frame

Parts Names and Functions

Front View - E260D/E320D/E370D/E420D/E460D MODEL

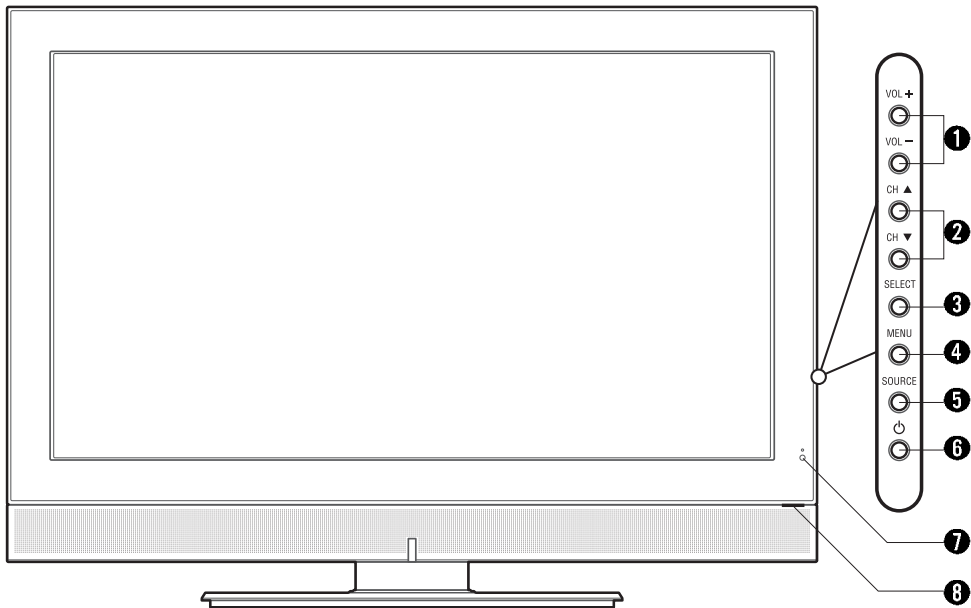

* This product image may be a bit different from the actual product.

❶ Volume buttons

Use these buttons to adjust sound levels. These buttons also serve as the cursors of Select/Adjust in Menu mode.

❷ Channel buttons

Use these buttons to change channels. These buttons also serve as the cursors of Down and Up buttons in Menu mode.

❸ Select button

Use this button to select each item from the menu mode.

❹ Menu button

Use this button to display or exit from the menu mode.

❺ Source button

Use this button to switch among inputs connected to the TV.

❻ Power button

Use this button to turn on or off the TV.

❼ Remote sensor and power LED.

- Point the remote control toward LED.
- It displays standby or operation status.

- Power Indicator Status -

Indicator	Status
Red	Standby
Green	Power on

❼ Power switch (For 37"/42"/46" model only)

Use this switch to turn on/off power.

Rear View - E260D/E320D/E370D/E420D/E460D MODEL

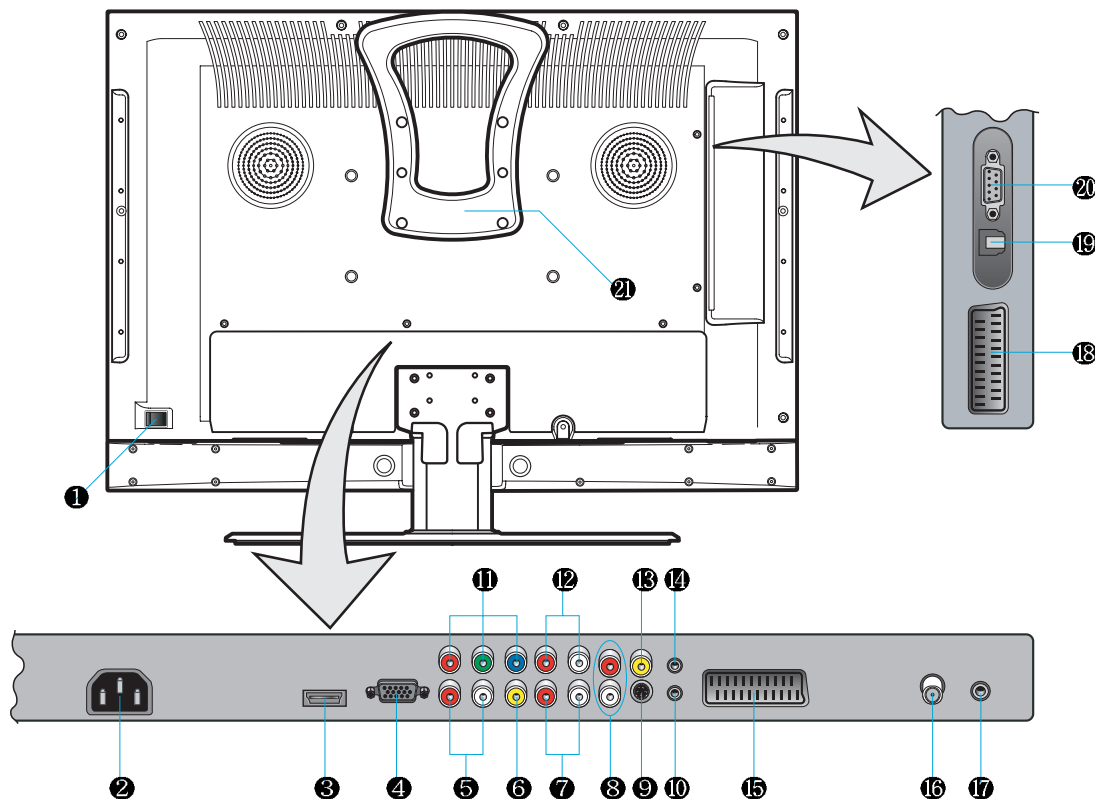

* This product image may be a bit different from the actual product.

- ❶ Power switch (For 26"/32" model only)
 - ❷ Power (AC) input terminal
 - ❸ HDMI input terminal
 - ❹ D-SUB input terminal
 - ❺ D-SUB Audio input terminal
 - ❻ Video (CVBS) output terminal
 - ❼ Audio (CVBS) output terminal
 - ❽ Audio (CVBS/S-Video) input terminal
 - ❾ S-Video input terminal
 - ❿* Extend an RS-232 input for ATV communication
 - ⓫ Component Video input terminal
 - ⓬ Component Audio input terminal
 - ⓭ Video (CVBS) input terminal
 - ⓮* Upgrade terminal
 - ⓯ Full Scart input terminal
 - ⓰ Antenna input terminal
 - ⓱ Digital Audio output terminal for coaxial cable
 - ⓲ Half Scart input terminal
 - ⓳ SPDIF Optical audio output terminal
 - ⓴* Extend an RS-232 input for DTV communication
 - ⓵ Handler (only for 26 inch)
- ✓ ⓫*⓬*⓴* - it's for technical service do not use at home.

Front View - E261D/E321D/E371D/E421D/E461D MODEL

ENGLISH

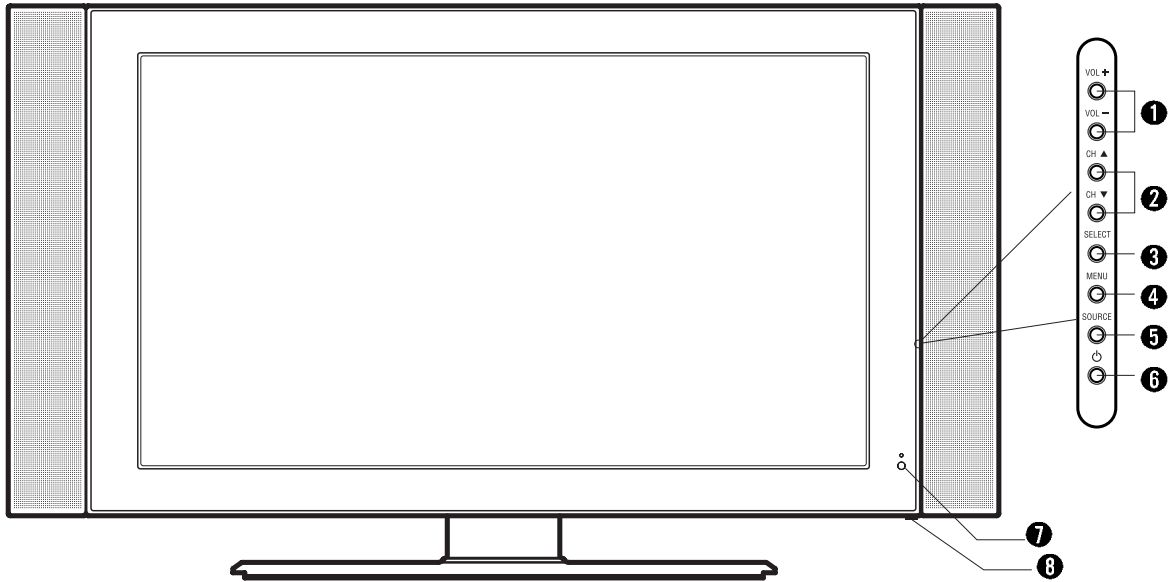

* This product image may be a bit different from the actual product.

❶ Volume buttons

Use these buttons to adjust sound levels. These buttons also serve as the cursors of Select/Adjust in Menu mode.

❷ Channel buttons

Use these buttons to change channels. These buttons also serve as the cursors of Down and Up buttons in Menu mode.

❸ Select button

Use this button to select each item from the menu mode.

❹ Menu button

Use this button to display or exit from the menu mode.

❺ Source button

Use this button to switch among inputs connected to the TV.

❻ Power button

Use this button to turn on or off the TV.

❼ Remote sensor and power LED.

- Point the remote control toward LED.
- It displays standby or operation status.

- Power Indicator Status -

Indicator	Status
Red	Standby
Green	Power on

❽ Power switch (For 37"/42"/46" model only)

Use this switch to turn on/off power.

Rear View - E261D/E321D/E371D/E421D/E461D MODEL

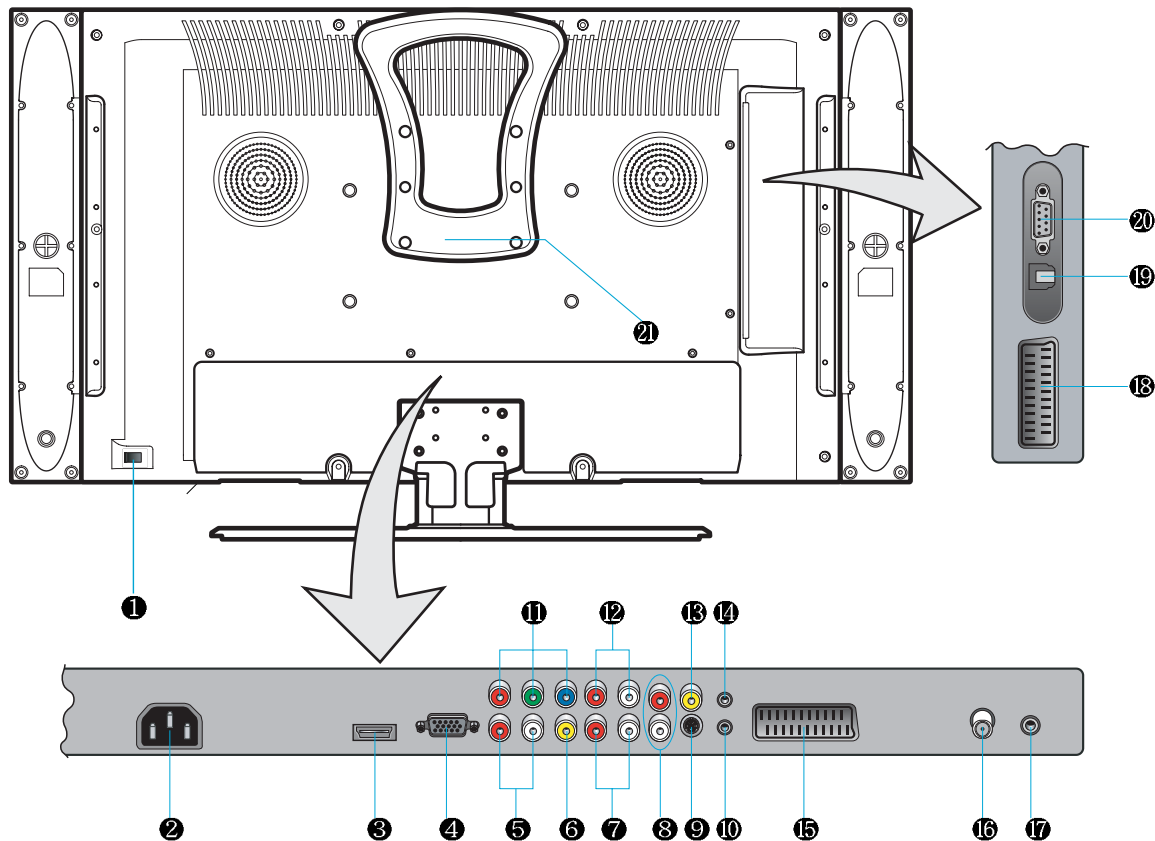

* This product image may be a bit different from the actual product.

- ❶ Power switch (For 26"/32" model only)
 - ❷ Power (AC) input terminal
 - ❸ HDMI input terminal
 - ❹ D-SUB input terminal
 - ❺ D-SUB Audio input terminal
 - ❻ Video(CVBS) output terminal
 - ❼ Audio(CVBS) output terminal
 - ❽ Audio(CVBS/S-Video) input terminal
 - ❾ S-Video input terminal
 - ❿* Extend an RS-232 input for ATV communication
 - ⓫ Component Video input terminal
 - ⓬ Component Audio input terminal
 - ⓭ Video(CVBS) input terminal
 - ⓮* Upgrade terminal
 - ⓯ Full Scart input terminal
 - ⓰ Antenna input terminal
 - ⓱ Digital Audio output terminal for coaxial cable
 - ⓲ Half Scart input terminal
 - ⓳ SPDIF Optical audio output terminal
 - ⓴* Extend an RS-232 input for DTV communication
 - ⓵ Handler (only for 26 inch)
- ✓ ❿*⓮*⓴* - it's for technical service do not use at home.

Remote Control

ENGLISH

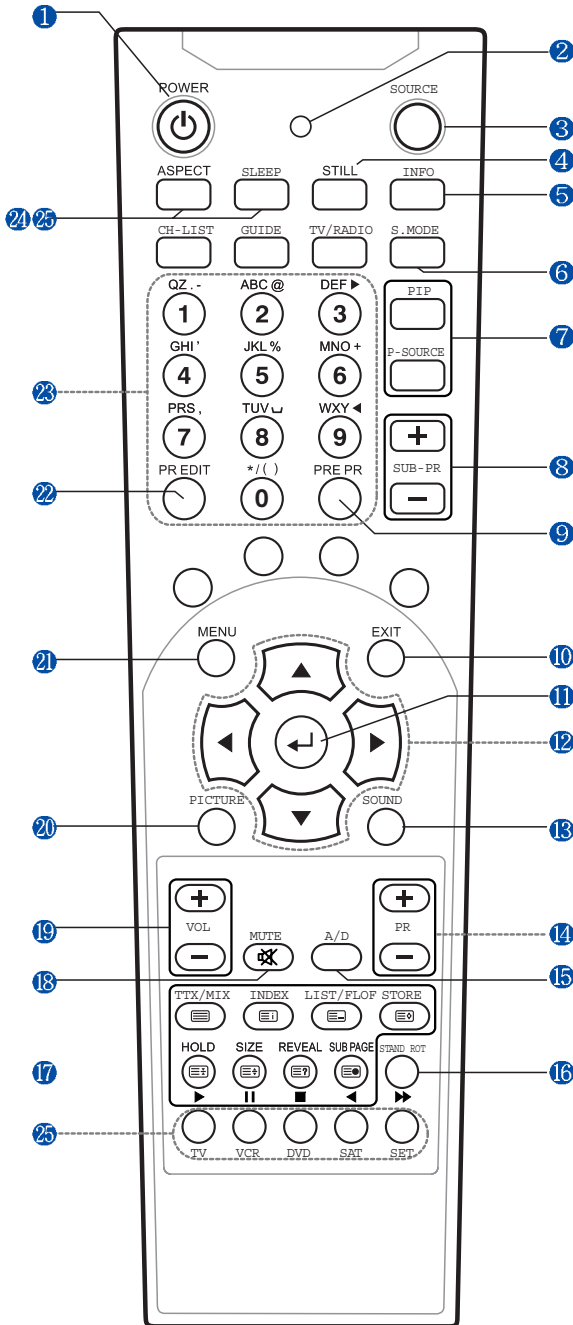

1. POWER/STANDBY

2. POWER LED

3. SOURCE

Use this button to select External Input.

4. STILL

5. INFORMATION

Use this button to display resolution or various programs.

6. S-MODE

7. PIP FUNCTIONS

- PIP : Use this button for PIP On/Off.

- PIP SOURCE : Use this button to select the input source of sub-picture.

8. PIP CHANNEL SELECTION

9. PREVIOUS PROGRAM

10. EXIT

11. MENU SELECTION

Use this button to select menu items.

12. LEFT/RIGHT MOVE/ADJUST

- Use these buttons to move between menu items or adjust each item.

- Use UP/DOWN buttons to select Analog TV channels.

13. SOUND MODE

Use this button to call the OSD on the screen.

14. PROGRAM SELECTION

15. A/D TV

Use this button to switch the input source from analog to digital.

16. AUTO SWIVEL ADJUST (Option)

17. Use this buttons to use other manufacturer's DVD or VCR.

18. MUTE

19. VOLUME

20. PICTURE MODE

21. MENU

Use this button to call the OSD on the screen.

22. PROGRAM EDIT

23. NUMERIC KEYS

24. ASPECT RATIO

Use this button to change the picture size.

25. Other external device selection(Option)

Teletext & Fastext Function

(See pages 36 for more details.)

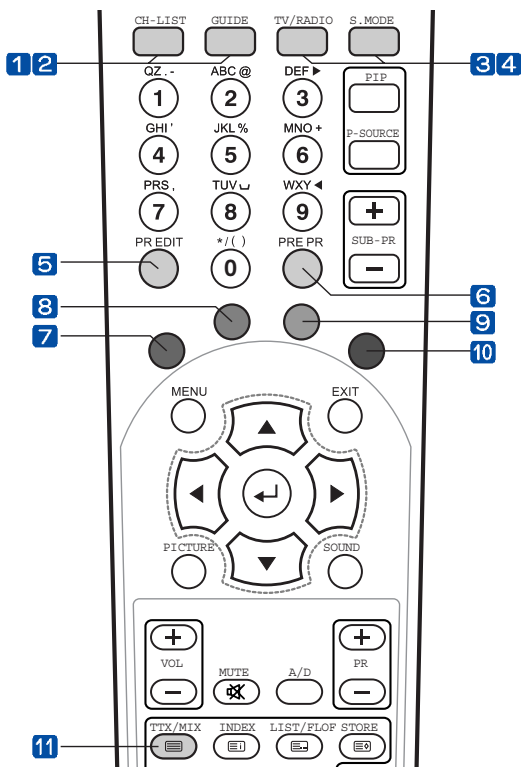

1. CH. LIST

To watch the channel list for Digital TV. Press key to confirm or press EXIT to return to previous channels.

2. GUIDE (EPG-Electronic Program Guide)

To watch the program information. Press once more to return to normal mode.

3. TV-RADIO

To switch between the TV channel and radio channel for Digital TV.

4. S.MODE

To adjust the subtitle and audio condition/status of the current channel for Digital TV

5. WHITE rubber

DTV : To add a new channel to the Channel List menu.

6. ORANGE rubber

DTV : To see variant channel lists for user's convenience in the Channel List menu.

7. RED rubber

- DTV : To setup favorite channel lists in the Channel List menu.
- ATV : To delete a channel in the Program Edit menu.

8. GREEN rubber

- DTV : To lock favorite channel lists in the channel list menu.
- ATV : To sort channels in the Program Edit menu.

9. YELLOW rubber

- DTV : To move favorite channel lists in the channel list menu.
- ATV : To edit channel names in the Program Edit menu.

10. BLUE rubber

DTV : To delete a channel from the channel List menu. To show extended program information in the EPG menu.

11. TTX/MIX

To see Teletext Service Data for Analog TV and Digital TV.

How to Insert Batteries in the Remote Controller

* Battery type :1.5V/AAA

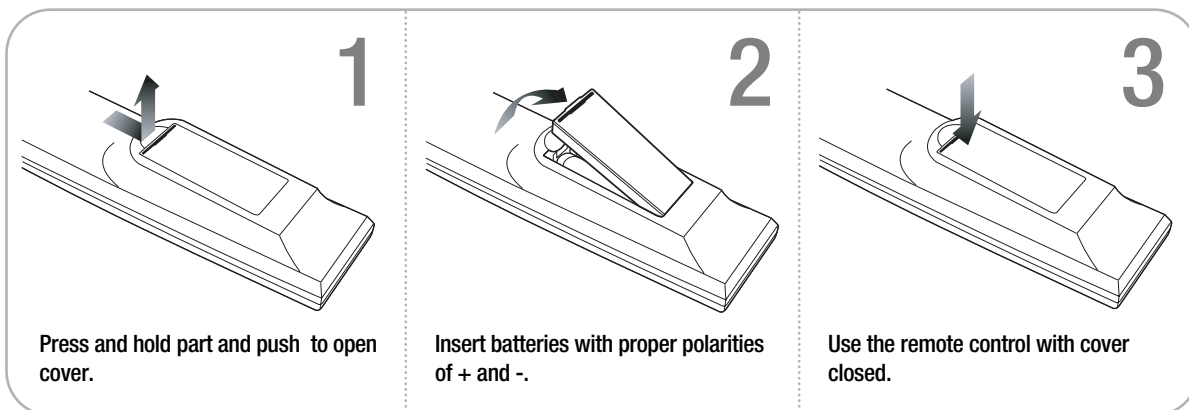

Press and hold part and push to open cover.

Insert batteries with proper polarities of + and -.

Use the remote control with cover closed.

Connecting Indoor/Outdoor TV Antenna(UHF/VHF)

- Antenna or Cable service without cable box connections
- For on optimum picture quality, adjust the direction of antenna if needed.

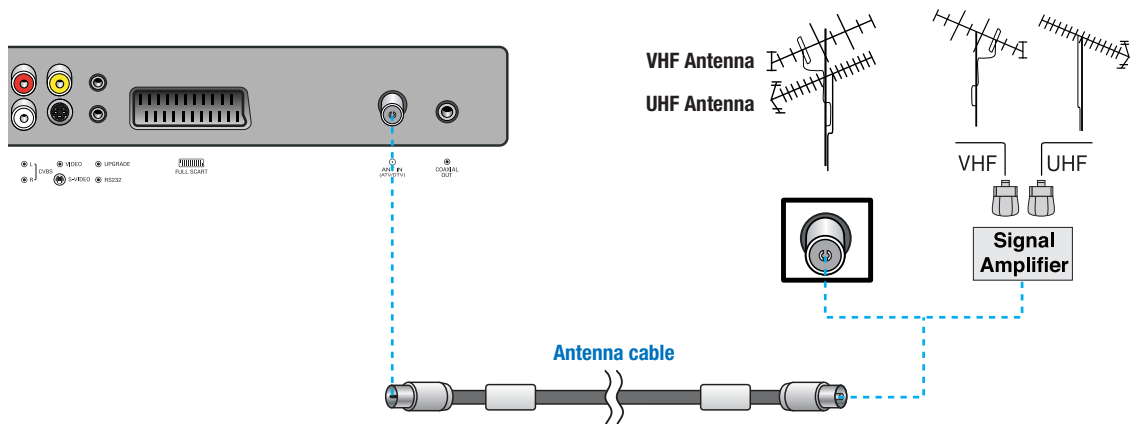

- ✓ When inserting a 75 Ω ohm coaxial cable into the input connection, ensure the wire tip not to bend.
- ✓ If you experience poor signal reception, we recommend you purchase a signal amplifier for better picture quality.

Connecting Antenna Input Connection to External Equipments

1. Connect an antenna cable to VCR/Cable/Satellite Receiver with the antenna input.
2. Use a coaxial cable to connect VCR/Cable/Satellite Receiver's antenna output to the antenna input on your TV.

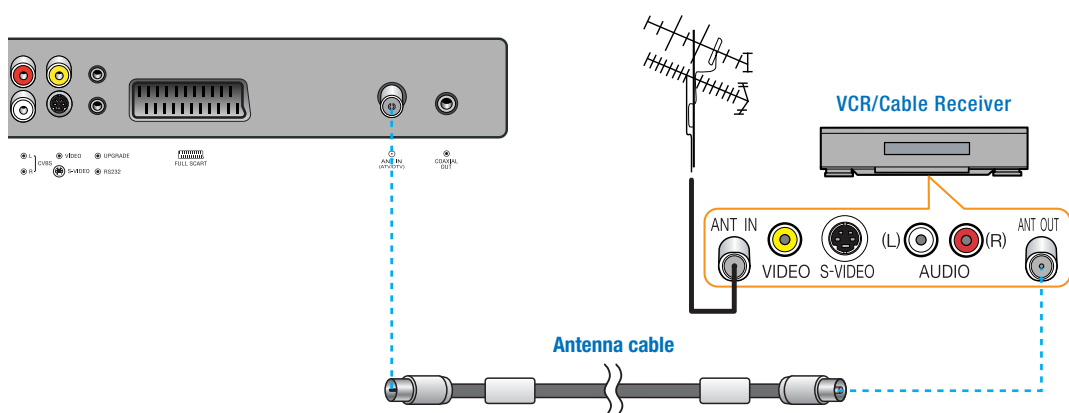

Before Connecting the Video/Audio Connections to External Devices...

Please make sure to read the following instruction to enjoy the best picture quality.
Best picture quality is displayed in the following order.

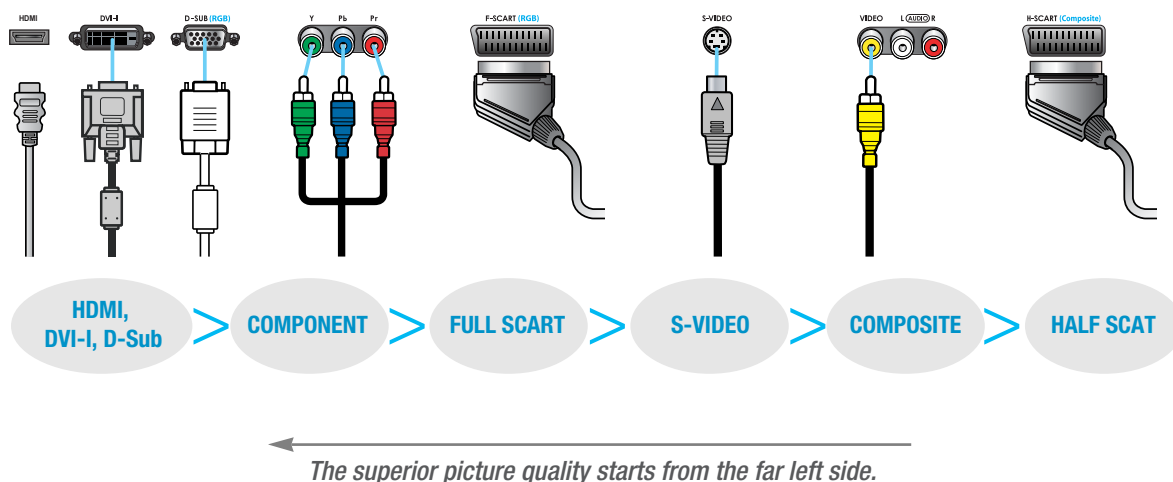

How to Connect a DTV Receiver or DVD Player

1. Connect the Video cable (Y, Pb, Pr) between output terminals (Y, Pb, Pr) of DTV receiver or DVD player and the input terminals (Y, Pb, Pr) of DTV/DVD (576i/576p/720p/1080i) on the rear of TV.
(Connect the jacks to terminals in the same color.)
2. Connect the Audio cable between Audio output terminals of DTV receiver or DVD player and Audio input terminal for DTV/DVD Audio on the rear of TV. (Connect the jacks to terminals in the same color.)

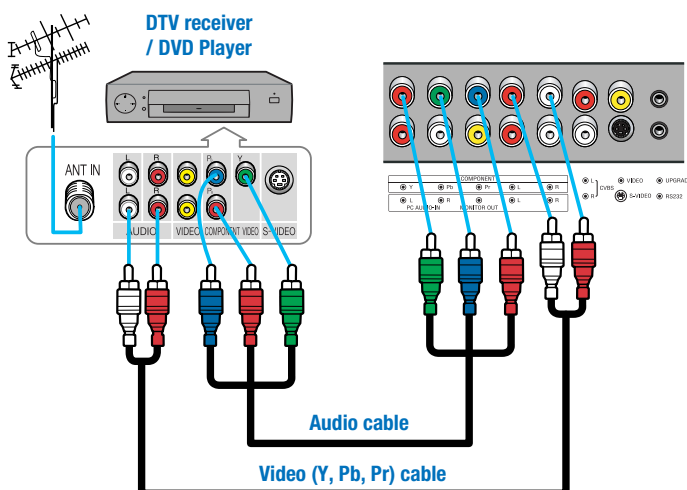

- ✓ Output terminal mark (Y, Pb, and Pr) of DVD player may be indicated as Y, B-Y, R-Y/Y-Cb-Cr /Y-Pb-Pr according to the type of DVD player models.
- ✓ If your DVD player or Set Top Box supports HDMI/DVI or D-SUB, see Connecting to a PC (page 13) for connection. You can enjoy more clearer picture quality.

How to Connect a VCR, Cable Receiver, Camcorder, Game Player

1. Connect the Video cable or S-Video cable between Video/S-Video output terminals of VCR or Cable receiver and Video/S-Video input terminal of TV. (Connect the jacks to terminals in the same color.)
2. Connect the Audio cable (Left: white, Right: red) between Audio output terminals of VCR or cable receiver and Audio input terminal of TV. (Connect the jacks to terminals in the same color.)

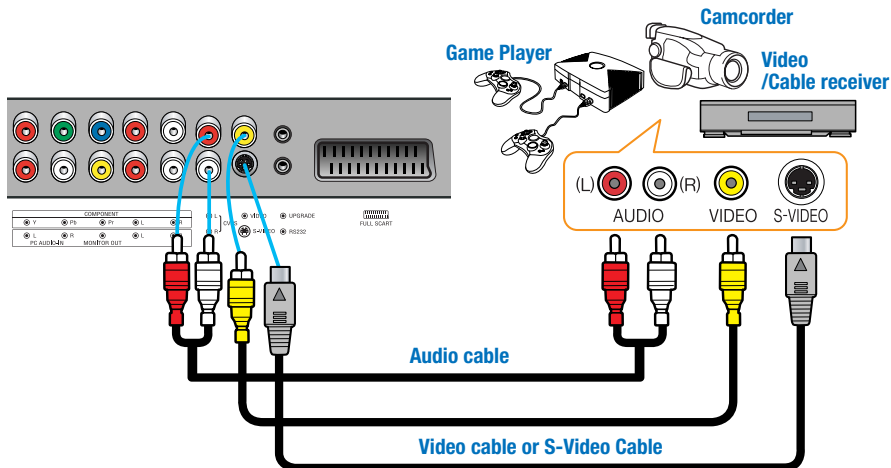

✓ To enjoy a better picture quality, use the S-Video cable rather than the composite cable.

How to Connect to a PC

1. Connect the PC signal cable (15-pin D-sub) between the output terminal of PC and the D-sub input terminal of TV.
2. Connect the Audio cable between Audio output terminal of PC and Audio input terminal for PC on the rear of TV. (Connect the jacks to terminals in the same color.)

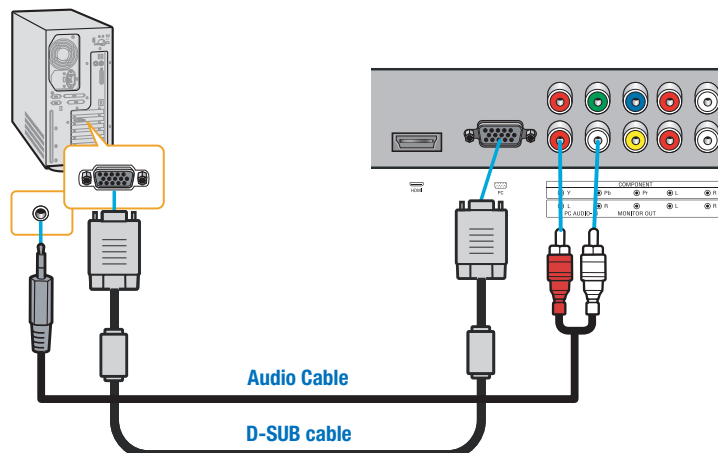

- ✓ If you use DVI/HDMI connection, you can enjoy better picture quality.
- ✓ This product supports Plug-and-Play function.
- ✓ We recommend the above method if the DVD player or set top box supports DTV signal with DVI or HDMI cable for better picture quality.
- ✓ If you input an unsupported resolution in PC or DVI/HDMI mode, the screen won't be displayed properly.
- ✓ DTV Timing is not guaranteed on the PC D-Sub mode

HDMI Connection (For HDMI model only)

HDMI*¹ (High Definition Multi media Interface) is the first all digital consumer electronics A/V interface that supports uncompressed standard. The HDMI terminal supports both video and audio information.

To the HDMI™ input terminal, you can connect an EIA/CEA-861/861*² compliant consumer electronic device, such as a Set Top Box or DVD player with HDMI or DVI output terminal.

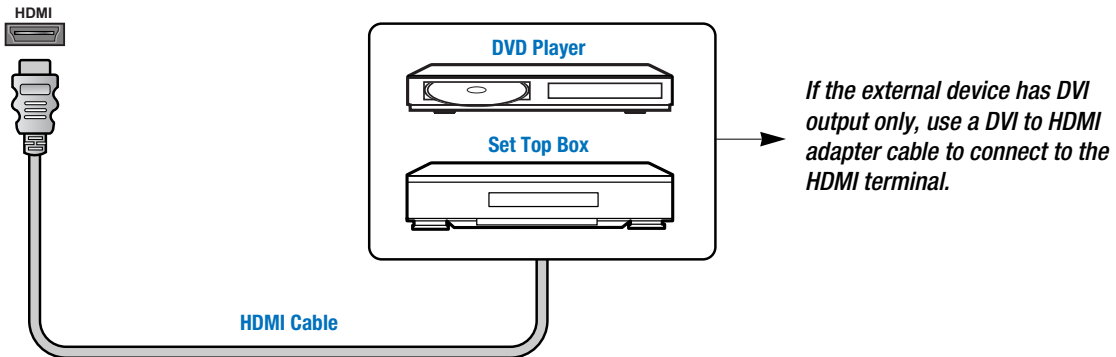

► Compatible VIDEO Signal

Model	Resolution	Vertical frequency
1080i	1,920 x 1,080i	50
576p	720 x 576p	50
	640 x 576p	50
720p	1280 x 720p	50

- This input terminal is not intended for use with computers.

► Compatible sampling frequency of AUDIO signal through HDMI (L.PCM) : 48kHz / 44.1kHz / 32 kHz

↳ Notes :

- This HDMI connector is Type A.
- If you connect an equipment without a digital output terminal, connect to the COMPONENT VIDEO, S VIDEO or VIDEO input terminal on the TV so you can enjoy an analog signal.
- The DIGITAL IN terminal can only be used with 1080i, 720p or 576p picture signals. Set the Digital Set -Top -Box DIGITAL OUT terminal Output setting to 1080i, 720p or 576p. For detailed information, refer to the Digital Set -Top -Box instruction manual. If you cannot display the picture because your Digital Set -Top -Box does not have a DIGITAL OUT terminal Output setting, use the component Video Input (or the S Video Input or Video Input). In this case the picture will be displayed as an analog signal.

*1. HDMI, the HDMI logo and High-Definition Multimedia Interface are trademarks or registered trademarks of HDMI Licensing LLC.

*2. EIA/CEA-861/861B profiles compliance covers profiles for transmission of uncompressed digital video including high bandwidth digital content protection.

How to Set the OSD Screen

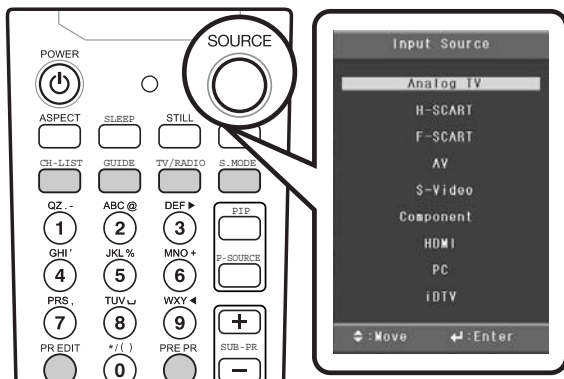

F-SCART - For supporting composite video and RGB video signals. SCART connectors is used with many European video equipments.

AV : For supporting the color shade(chrominance) and brightness(luminance) information into one video signal.

S-VIDEO : For supporting better resolution than composite video, which carries the signals together.

Component : For supporting greater color accuracy than composite video or S-VIDEO by splitting chrominance into one video signal.

HDMI : High Definition Multi media Interface that supports both video and audio information.

PC : For supporting Personal Computer connection.

iDTV : Digital Terrestrial broadcasting for supporting DVB-T System.

ANALOG TV - Terrestrial broadcasting for supporting analog PAL/SECAM system.

H-SCART - Basically the same as Full SCART in function but not supporting RGB Video signals.

Different OSD Menu

You can confirm OSD menu of three different types.

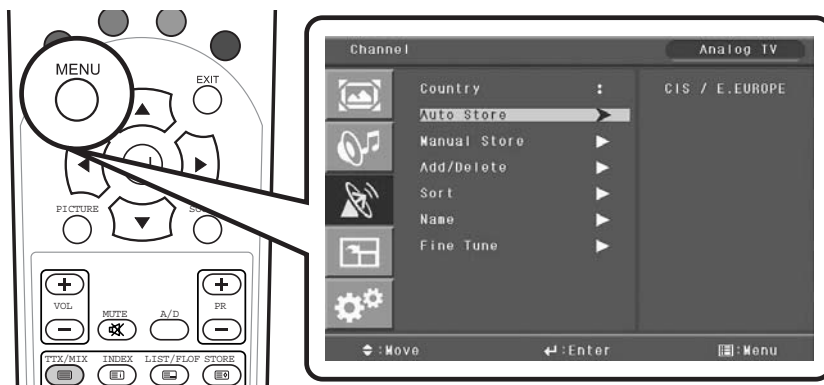

✓ In case of the source in ATV



✓ In case of the source in iDTV

How to Select the Picture Mode

Users can automatically adjust the picture mode according to the input mode.

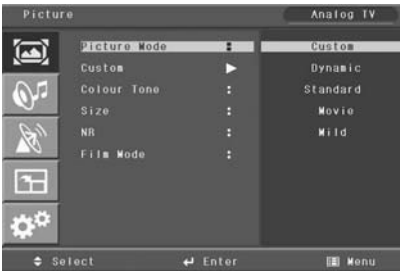

- 1 Press MENU button.
Menu items appear on the screen.
- 2 Press \downarrow button to select "Picture" Icon.
"PICTURE MODE" is highlighted.
- 3 Press \leftarrow / \rightarrow or \downarrow buttons to select "Picture mode".
- 4 The menu changes in the following order.
CUSTOM \rightarrow DYNAMIC \rightarrow STANDARD \rightarrow MOVIE \rightarrow MILD
- 5 Press EXIT button to TV viewing or press MENU button to return to the previous menu.

- ◆ CUSTOM : When the user wants to set the values directly.
- ◆ DYNAMIC : Clear display
- ◆ STANDARD : Most video contents are appropriate to this mode.
- ◆ MOVIE : When watching a movie
- ◆ MILD : Soft display.

✓ In the custom's mode, the users can adjust their desired brightness, contrast, colour, Tint, sharpness and backlight.

How to Set the Desired Picture

Users can manually adjust their desired picture



- 1 Press MENU button.
Menu items appear on the screen.
- 2 Press \downarrow button to select "Picture" Icon.
"PICTURE MODE" is highlighted.
- 3 Press \uparrow / \downarrow buttons to move to "Custom" and press \leftarrow / \rightarrow or \downarrow buttons to select "CUSTOM".
- 4 Select required option by pressing the \uparrow / \downarrow or button, then Press \leftarrow / \rightarrow button to adjust.
- 5 Press EXIT button to TV viewing or press MENU button to return to the previous menu.

- ◆ BRIGHTNESS : Adjust the brightness of the entire picture.
- ◆ CONTRAST : Adjust the brightness and darkness of the object and backgrounds.
- ◆ COLOUR : Adjust colors into deeper or lighter colors.(not operational in pc mode)
- ◆ TINT : Adjust colors naturally.(not operational in pc iDTV and component mode)
- ◆ SHARPNESS : Adjust the clarity of object outlines.(not operational in pc iDTV and component mode)
- ◆ PHASE : To remove the picture shaking.
To eliminate the Shake of picture(operational in component and iDTV Mode)
- ◆ BACKLIGHT : Adjust the brighten or darken of the screen.

How to Set the Desired Picture in PC, HDMI Input Modes

Users can adjust Color as users want.



- 1 Press MENU button.
Menu items appear on the screen.
- 2 Press \downarrow button to select "Picture" Icon.
picture mode is highlighted.
- 3 Press \leftarrow / \rightarrow or \downarrow buttons to select to "picture mode".
- 4 The menu changes in the following order.
→ CUSTOM → HIGH → MIDDLE → LOW
- 5 After selecting Color Tone, then the menu changes in the following order.
→ CUSTOM → COOL2 → COOL1 → NORMAL → WARM1 → WARM2
- 6 If you choose "CUSTOM" in "COLOR TONE" you can adjust R.G.B.
- 7 Press EXIT button to TV viewing or press MENU button to return to the previous menu.

- ◆ CUSTOM : When the user wants to set the degree of RGB directly.
- ◆ COOL : For cool colors with bluish tone.
- ◆ NORMAL : For a general Color Tone.
- ◆ WARM : For warm colors with reddish tone.

How to Set Image Adjust in PC Mode



- 1 Press MENU button.
Menu items appear on the screen.
- 2 Press \downarrow button to select "Picture" Icon.
"PICTURE MODE" is highlighted.
- 3 Press \uparrow / \downarrow buttons to move to "PC" and Press \leftarrow / \rightarrow or \downarrow buttons to select to "pc"
- 4 "AUTO ADJUST" is high lighted.
- 5 Press \downarrow button to execute the "AUTO ADJUST"
- 6 Select required option by pressing the \leftarrow / \rightarrow or \downarrow buttons, then press \leftarrow / \rightarrow button to adjust
- 7 Press EXIT button to TV viewing or press NEW button to return to the previous menu

- ◆ Auto ADJUST : Horizontal/vertical positions are automatically adjusted.
- ◆ PHASE : To eliminate the shake of the picture.
- ◆ H-POSITION : To adjust the horizontal position of the picture.
- ◆ V-POSITION : To adjust the vertical position of the picture.
- ◆ FREQUENCY : To eliminate the shake of picture.

How to Select a Color Tone

Users can adjust Color as users want.

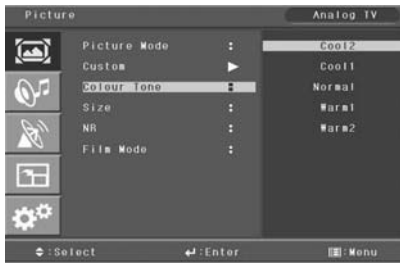

- 1 Press MENU button.
Menu items appear on the screen.
- 2 Press \leftarrow button to select "Picture" Icon.
"PICTURE MODE" is highlighted.
- 3 Press \blacktriangle / \blacktriangledown buttons to move to "COLOR TONE".
- 4 Press \leftarrow / \rightarrow or \leftarrow buttons to select "COLOR TONE".
- 5 Press \blacktriangle / \blacktriangledown buttons, then the menu changes in the following order.
→ COOL2 → COOL1 → NORMAL → WARM1 → WARM2
- 6 Press EXIT button to TV viewing or press MENU button to return to the previous menu.

- ◆ COOL : For cool colors with bluish tone.
- ◆ NORMAL : For a general Color Tone.
- ◆ WARM : For warm colors with reddish tone.

How to Set the Display Size

Users can adjust the display scale as they want



- 1 Press MENU button.
Menu items appear on the screen.
- 2 Press \leftarrow button to select "Picture" Icon.
"PICTURE MODE" is highlighted.
- 3 Press \blacktriangle / \blacktriangledown buttons to move to "SIZE".
- 4 Press \leftarrow / \rightarrow or \leftarrow buttons and press \blacktriangle / \blacktriangledown then the mode change in the following order.
COMPONENT Input : → WIDE → PANORAMA → ZOOM → 4:3 → 14:9
PC/HDMI inputs : → WIDE → 4:3 →
Under other inputs : → AUTOSIZE → WIDE → PANORAMA → ZOOM
→ 4:3 → 14:9 →
- 5 Press EXIT button to TV viewing or press MENU button to return to the previous menu.

- ◆ AUTO SIZE - Screen size adjust automatically by screen signal.
- ◆ WIDE - General broadcast picture is adjusted to 16:9.
- ◆ PANORAMA - Picture enlarged to 16:9 format, letter box format.
- ◆ ZOOM - Zoom in 16:9 in vertical direction
- ◆ 4:3 - 4:3 general picture size
- ◆ 14:9 - 14:9 picture size

How to Set Noise Reduction(NR)

User can eliminate noises on the screen in Video mode

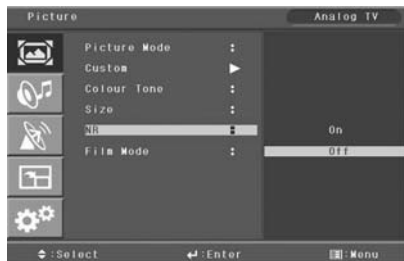

- 1 Press MENU button.
Menu items appear on the screen.
- 2 Press \downarrow button to select "Picture" Icon.
"PICTURE MODE" is highlighted.
- 3 Press \uparrow / \downarrow buttons to move to "NR".
- 4 Press \leftarrow / \rightarrow buttons to select to "NR".
- 5 Press \uparrow / \downarrow or \downarrow buttons to set **ON/OFF**.
- 6 Press EXIT button to TV viewing or press MENU button to return to the previous menu.

How to Set Film Mode

Set Film Mode to receive a crisp, clear picture without flickering.

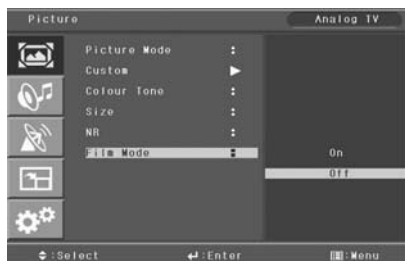

- 1 Press MENU button.
Menu items appear on the screen.
- 2 Press \downarrow button to select "Picture" Icon.
"PICTURE MODE" is highlighted.
- 3 Press \uparrow / \downarrow buttons to move to "FILM MODE".
- 4 Press \leftarrow / \rightarrow or \downarrow buttons to select to "FILM MODE".
- 5 Press \uparrow / \downarrow or \downarrow buttons to set **ON/OFF**.
- 6 Press EXIT button to TV viewing or press MENU button to return to the previous menu.

✓ During the reproduction of a DVD or VCR it can come to a distortion of the picture edges. Usually it happens due to a low quality film edition. In case you experience this, please switch in the menu the function "film mode" to "ON".
 ✓ You may experience tearing effects on the flowing texts during general broadcasting. If you come across this symptom, select 'OFF' in the Film Mode.

How to Select the Audio Mode

Users can adjust sound mode automatically as they want.

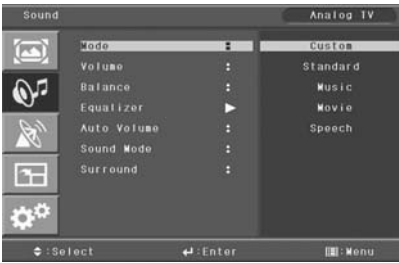

- 1 Press MENU button.
Menu items appear on the screen.
- 2 Press ▲ / ▼ buttons to move to “SOUND” icon.
- 3 Press ⏏ button to select “SOUND” icon.
“MODE” is highlighted.
- 4 Press ◀ / ▶ or ⏏ buttons, to select to “SOUND MODE” then the menu changes in the following order.
CUSTOM → STANDARD → MUSIC → MOVIE → SPEECH →
- 5 Press EXIT button to TV viewing or press MENU button to return to the previous menu.

- ◆ CUSTOM : When the user wants to set the values directly.
- ◆ STANDARD : For the general sound. Most audio contents are appropriate to this mode.
- ◆ MUSIC : For enjoying original sound.
- ◆ MOVIE : Grandiose sound.
- ◆ SPEECH : Clear sound.

➔ How To Directly Select Sound : Press Sound button.

Users can select custom CUSTOM → STANDARD → MUSIC → MOVIE → NEWS in order.

How to Adjust the Desired Audio Mode

Users can adjust sound mode automatically as they want.

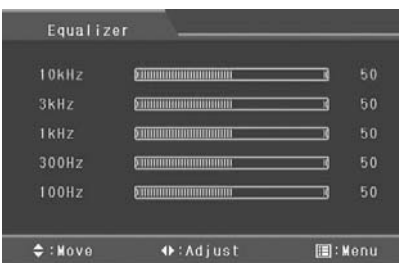
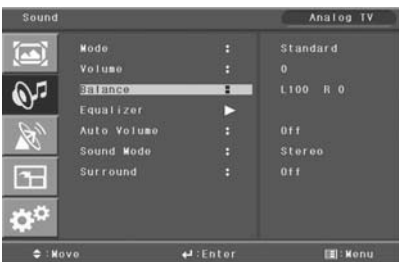

- 1 Press MENU button.
Menu items appear on the screen.
- 2 Press ▲ / ▼ buttons to move to “SOUND” icon.
- 3 Press ⏏ button to select “SOUND” icon.
“MODE” is highlighted.
- 4 Press ▲ / ▼ buttons to move to “Balance or Equalizer”.
- 5 Press ⏏ buttons to select “Balance or Equalizer”.
Balance or Equalizer menu appears.
- 6 Select required option by pressing the ▲ / ▼ buttons, then Press ◀ / ▶ buttons to adjust.
- 7 Press EXIT button to TV viewing or press MENU button to return to the previous menu

- ◆ BALANCE : Adjusts the balance of left and right speakers.
- ◆ EQUALIZER : Adjusts the audio output signal in the desired band.

How to Select Auto Volume

This function will automatically give a similar volume size to each channel.



- 1 Press MENU button.
Menu items appear on the screen.
- 2 Press ▲ / ▼ buttons to move to "SOUND" icon.
- 3 Press ◀ button to select "SOUND" icon.
"MODE" is highlighted.
- 4 Press ▲ / ▼ buttons to move to "AUTO VOLUME" .
- 5 Press ◀ / ▶ or ◀ button to select "ON/OFF".
- 6 Press ▲ / ▼ or ◀ buttons to set to "ON/OFF".
- 7 Press EXIT button to TV viewing or press MENU button to return to the previous menu

How to Select Sound Mode

Depending on the particular program being broadcast, you can select stereo or mono.

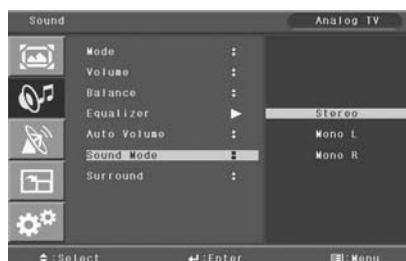

- 1 Press MENU button.
Menu items appear on the screen.
- 2 Press ◀ button to select "SOUND" Icon.
"MODE" is highlighted.
- 3 Press ▲ / ▼ buttons to move to "SOUND MODE".
- 4 Press ◀ / ▶ or ◀ buttons to select to "SOUND MODE".
- 5 Press ▲ / ▼ buttons to select to "MONO" or "STEREO".
- 6 Press exit button to TV viewing or press MENU button to return to the previous menu

➤ How To Directly Select S. MODE : Press S. MODE button.

To select "MONO" or "STEREO".

- ◆ Choose "STEREO" for channels that are broadcasting in STEREO.
- ◆ Choose "MONO" for channels that are broadcasting in MONO, or if you are having difficulty receiving a STEREO signal.

✓ If the signal reception conditions deteriorate, setting to Mono will make sound conditions better.

✓ If you select Mono L or R you could listen one sound signal by both speakers.

How to Select Surround

This function processes multi-channel surround sound through two speakers.

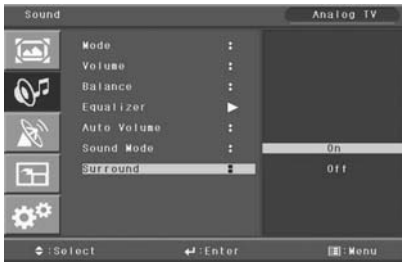

- 1 Press MENU button.
Menu items appear on the screen.
- 2 Press **↵** button to select "SOUND" Icon.
"MODE" is highlighted.
- 3 Press **▲** / **▼** buttons to move to "SURROUND".
- 4 Press **◀** / **▶** or **↵** buttons to select to "SURROUND".
- 5 Press **▲** / **▼** or **↵** buttons to set to "ON/OFF".
- 6 Press EXIT button to TV viewing or press MENU button to return to the previous menu.

✓ *You can enjoy the most suitable surround effect in Stereo-mode.*

How to Select Auto Store

Auto store enables to search/store channels of countries where the user is located automatically.



- 1 Press MENU button.
Menu items appear on the screen.
- 2 Press ▲ / ▼ buttons to move to “CHANNEL” icon.
- 3 Press ⏏ button to select “CHANNEL” Icon.
“COUNTRY” is highlighted.
- 4 Press ◀ / ▶ or ⏏ buttons to select “COUNTRY”
- 5 Press ▲ / ▼ or ⏏ buttons to set “YOUR COUNTRY”.
- 6 Press ▲ / ▼ buttons to move to “AUTO STORE”.
- 7 Press ◀ / ▶ or ⏏ buttons to select “AUTO STORE”.
Auto store menu appears, and “START” is highlighted.
- 8 Press ◀ / ▶ buttons to select “START” or “STOP”, then Press ⏏ to store.
- 9 Press EXIT button to TV viewing or press MENU button to return to the previous menu.

How to Select Manual Store

Manual store enables to searching channels which the user want manually.



- 1 Press MENU button.
Menu items appear on the screen.
- 2 Press ▲ / ▼ Buttons to move to “CHANNEL” icon.
- 3 Press ⏏ button to select “CHANNEL” Icon.
“COUNTRY” is highlighted.
- 4 Press ▲ / ▼ Buttons to move to “MANUAL STORE”.
- 5 Press ◀ / ▶ or ⏏ button to select “MANUAL STORE”.
Manual program menu appears, then “PROG.” is highlighted.
- 6 Press ◀ / ▶ buttons to select program No.
- 7 Select required option by pressing the ▲ / ▼ button, then Press ◀ / ▶ or ▲ / ▼ buttons to set or adjust.
- 8 To store the setting, press ▲ / ▼ buttons, move to “Store” and press ⏏ button to store and finish.

How to Set the Program Edit(Add/Delete, Sort, Name)

Program edit enables users to edit the searched programs.

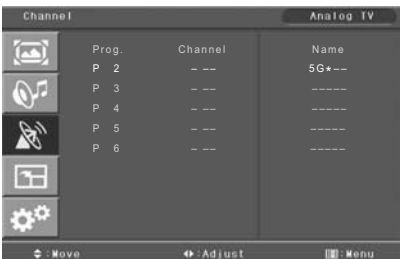
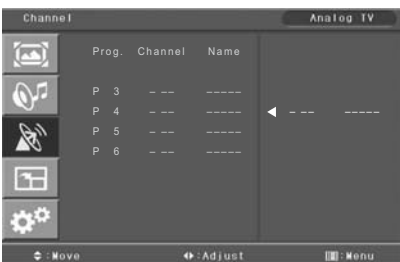
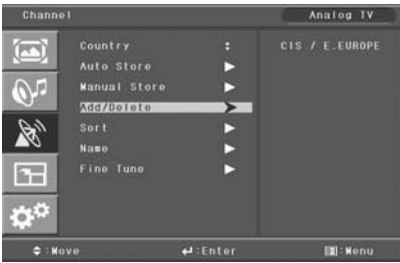

- 1 Press MENU button.
Menu items appear on the screen.
- 2 Press ▲ / ▼ Buttons to move to "CHANNEL" icon.
- 3 Press ↵ buttons to select "CHANNEL" Icon.
"COUNTRY" is highlighted.
- 4 Press ▲ / ▼ Buttons to move to "add/delete, sort,name".
- 5 Press ↵ button to select "add/delete".
The program table appears on the screen. One program table contains five programs.
- 6 Press ▲ / ▼ Buttons to move the program list, and press ◀ / ▶ buttons to move the menu list select "added" or "Erased"

☞ *Sorting the Stored Channels*

- a. Place to ↵ buttons to select and ▲ / ▼ buttons to choose the swapping PR number.
- b. To store the setting, press ▲ / ▼ or ↵ buttons.

☞ *Assigning Names to Channel*

- press ↵ button to select and ▲ / ▼ Buttons to set to "NAME"
- a. Place the cursor on NAME and Select a letter (A~Z), a number (0~9) or blank space.
 - b. To store the setting, press the ↵ button once again.

- 7 Press EXIT button to TV viewing or press MENU button to return to the previous menu.

How to fine tune

if the reception is clear, you do not have to fine tune, as this is done automatically during the search and store operation. If the signal is weak or distorted, you may have to fine tune the channel manually.



- 1 Press Menu button.
Menu items appear on the screen.
- 2 Press \downarrow button to select "channel" icon
"country" is highlighted.
- 3 Press \uparrow / \downarrow buttons to move to "fine tune".
- 4 Press \leftarrow / \rightarrow \downarrow or buttons to select to "fine tune".
- 5 Press \uparrow / \downarrow or \leftarrow / \rightarrow buttons to adjust "to fine tune".
- 6 Press EXIT button to TV viewing or press MENU button to return to the previous menu.

How to Set PIP

This is to set PIP(Picture In Picture).

You can watch two programs or source at the same time.

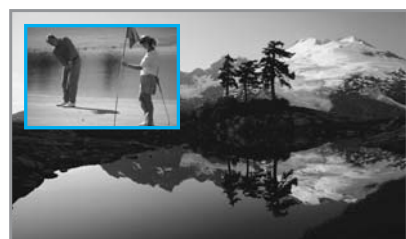

<PIP>

- 1 Press Menu button.
Menu items appear on the screen.
 - 2 Press \uparrow / \downarrow buttons to move to "PIP" icon.
 - 3 Press \downarrow button to select "PIP".
"PIP" is highlighted.
 - 4 Press \leftarrow / \rightarrow or \downarrow buttons to select "PIP".
New Menu items appear, then "OFF" is highlighted.
 - 5 Press \uparrow / \downarrow or \downarrow buttons to select to "ON/OFF".
- ➔ How to Directly Turn PIP FUNCTION ON/OFF : Press PIP button.

After setting this, go to step 6 to set the SOURCE.

- 6 Press \uparrow / \downarrow buttons to move to "INPUT SOURCE" and Press \leftarrow / \rightarrow or \downarrow buttons.
- 7 Press \uparrow / \downarrow button, then source changes.
➔ see the refer supported PIP table.

➔ How To Directly Change Sub Source : Press SOURCE button.

*In case of PIP mode, go to step 8
if you need to set the "SIZE" of Sub picture.*

- 8 Press \uparrow / \downarrow buttons to move to "Size" and Press \leftarrow / \rightarrow or \downarrow button.
- 9 Press \uparrow / \downarrow button, then mode will changes in order below.
➔ SMALL ➔ LARGE ➔

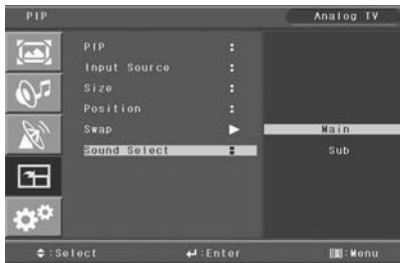
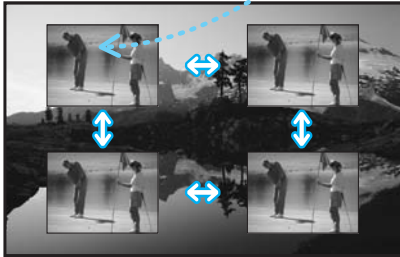
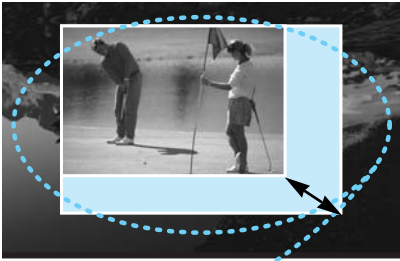

In case of PIP mode, go to step 10 if you need to set the "Position" of Sub picture.

10 Press ▲ / ▼ buttons to move to "Position" and Press ◀ / ▶ or ↵ button.

11 Press ▲ / ▼ button, then the mode will change the following order.
 → RIGHT BOTTOM → RIGHT TOP → LEFT TOP → LEFT BOTTOM →

In case of PIP mode, go to step 12 if you need to set the "SWAP" of Main and sub pictures.

12 Press ▲ / ▼ buttons to move to "Swap" and Press ↵ button.

In case of PIP mode, go to step 13 if you need to set the "Sound Select" of Main and sound

13 Press ▲ / ▼ buttons to move to "Sound select" and ◀ / ▶ or ↵ button.

14 Press ▲ / ▼ button, then source changes.
 → MAIN → SUB →

Supported PIP Table

PIP : 0 → Supported, X → Not Supported

Main \ Sub	PC	HDMI	COMPONENT	S-Video	AV	FSCRT	HSCRT	Analog TV	iDTV
PC	X	X	X	0	0	0	0	0	X
HDMI	X	X	X	0	0	0	0	0	X
COMPONENT	X	X	X	0	0	0	0	0	X
AV	0	0	0	X	X	X	X	X	0
S-Video	0	0	0	X	X	X	X	X	0
FSCRT	0	0	0	X	X	X	X	X	0
HSCRT	0	0	0	X	X	X	X	X	0
Analog TV	0	0	0	X	0	X	X	X	X
iDTV	X	X	X	0	0	0	0	0	X

How to Reset



- 1 Press MENU button.
Menu items appear on the screen.
- 2 Press \leftarrow button to select "Set up" Icon.
"Reset" is highlighted.
- 3 Press \leftarrow / \rightarrow \leftarrow or buttons to select to "RESET".
- 4 Press \leftarrow buttons to choose to "RESET".
- 5 Press EXIT button to TV viewing or press MENU button to return to the previous menu.

✓ When you select "Reset" user setting value will initialize except channel value.

How to Set Clock, Sleep Time, ON/OFF Time

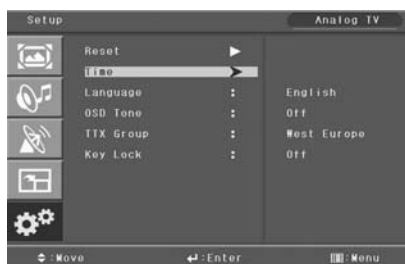

- 1 Press Menu button.
Menu items appear on the screen.
- 2 Press \leftarrow button to select "SET-UP" Icon.
"RESET" is highlighted.
- 3 Press \uparrow / \downarrow buttons to move to "TIME".
- 4 Press \leftarrow / \rightarrow or \leftarrow buttons to select "TIME".
Time menu appears, then "CLOCK" is highlighted.
- 5 Press \leftarrow / \rightarrow buttons to move between Hour, Minute and Press \uparrow / \downarrow buttons to set Hour, Minute.

✓ When the power supply(AC main power) is cut off, the clock is reset to the value before the Time set.



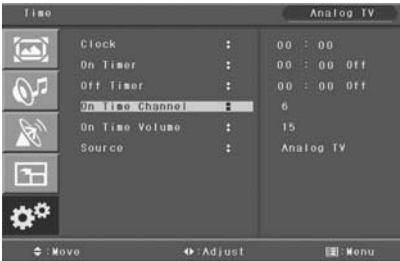
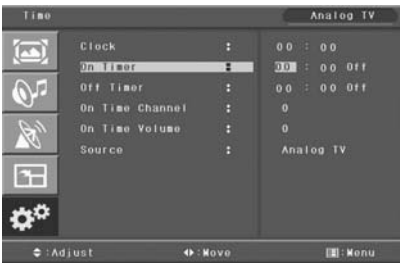

Go to step 6 if you need to set the "ON or OFF TIME".

- 6 Press ▲/▼ buttons to move to "ON or OFF TIME".
- 7 Press ◀/▶ or ↵ buttons to select "ON or OFF TIME".
- 8 Press ◀/▶ buttons to move between Hour, Minute and on/off and Press ▲/▼ buttons to set Hour, Minute and on/off

go to step 9 if you need to set the "ON TIME CHAMEL" or "ON TIME VOLUM"

- 9 Press ▲/▼ buttons to move to on time channel or Volume.
- 10 Press ◀/▶ buttons to adjust on time channel or Volume.

go to step 11 if you need to set the "SOURCE"

- 11 Press ▲/▼ buttons to move to "SOURCE"
- 12 Press ◀/▶ or ↵ buttons to select to "SOURCE"
- 13 Press ◀/▶ or ↵ buttons to set to "SOURCE"

Choosing the Your Languages

Using the TV for the first time, users must select their preferred language preference in order to display main menus and sub menus, etc.



- 1 Press MENU button.
Menu items appear on the screen.
- 2 Press ↵ button to select "SET UP" Icon.
"RESET" is highlighted.
- 3 Press ▲/▼ button to move to Language and press ◀/▶ or ↵ button to select to Language .
→ ENGLISH → FRANÇAIS → DEUTSCHLAND → ITALIANO → ESPAÑOL
→ NEDERLAND → SUOMI →
- 4 Press EXIT button to TV viewing or press MENU button to return to the previous menu.

How to set osd tone



- 1 Press MENU button.
Menu items appear on the screen.
- 2 Press \leftarrow button to select "set up" icon
"RESET" is highlighted.
- 3 Press \blacktriangle / \blacktriangledown buttons to move to "osd tone"
- 4 Press \leftarrow / \rightarrow or \leftarrow buttons to select to "osd tone".
- 5 Press \blacktriangle / \blacktriangledown or \leftarrow buttons to set to "on/off".

How to Set Teletext in ATV







*You can use Teletext service in analog TV mode.
If it is included in you receiving channels.*



- 1 Press "TTX/MIX" button and wait.
If the "*" sign pops up left upside of the screen as the following picture, wait until the teletext service menu is displayed "*" means it provides teletext service. So wait a moment.
- 2 Select your interesting item with numeric keys.

Selecting Teletext Display Options in ATV Mode

When users have displayed a teletext page, they can have various options to suit their requirements.

DISPLAY(ACTION)	BUTTON
<ul style="list-style-type: none"> • Hidden Text (Answers to Quiz Games, for Example) • The Normal Screen 	 REVEAL REVEAL AGAIN
<ul style="list-style-type: none"> • A Second Page • Normal screen 	 SUB PAGE SUB PAGE AGAIN
<ul style="list-style-type: none"> • Double-Size Letters in the : <ul style="list-style-type: none"> - Upper half of the screen - Lower half of the screen • Normal Screen : 	 SIZE - ONCE - TWICE - THREE TIMES
Stops the automatic page change which will occur if teletext page consists of 2 or more sub pages. The stop symbol is displayed at the top left-hand corner of the screen.	 HOLD HOLD AGAIN
<ul style="list-style-type: none"> • FLOF ──────────▶ INDEX (Full Level One Facility) • TOP ──────────▶ INFO. (Table of Page) 	 INDEX
<ul style="list-style-type: none"> • To Store Page 	 STORE
<ul style="list-style-type: none"> • Return to List or FLOF mode 	 LIST/FLOF

How to Set Key-Lock

User can lock the control buttons on the front bottom of the TV.

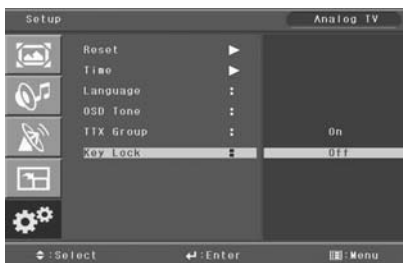

- 1 Press MENU button.
Menu items appear on the screen.
- 2 Press ▲ / ▼ button to move to "SET UP" Icon.
- 3 Press ⏴ button to select "SET UP" Icon.
"RESET" is highlighted
- 4 Press ▲ / ▼ buttons to move to "KEY LOCK".
- 5 Press ⏴ / ⏵ or ⏴ buttons to select to "KEY LOCK".
- 6 Press ▲ / ▼ or ⏴ buttons to set to ON/OFF.
- 7 Press EXIT button to TV viewing or press MENU button to return to the previous menu.

How to Search Automatically

This function can be used to get the latest program data while the receiver is still in use. Through this function, the receiver searches for all the available program and saves them in the memory.



- 1 Press MENU button.
Menu items appear on the screen.
- 2 Press ▲ / ▼ Buttons to move to “DTV CHANNEL” icon.
- 3 Press ⏏ button to select “DTV CHANNEL” Icon.
“AUTO SCAN” is highlighted.
- 4 Press ⏏ buttons to select “AUTO SCAN”
Automatic Scan menu appears, then auto scan activates.
While searching, you can see the following menu on the screen.

When scanning is finished, you can see the following information on the screen. After the scanning process, the first program of the last scanned channel will be displayed on the back screen
- 5 Press EXIT button to TV viewing or press MENU button to return to the previous menu.

✓ Now you have completed all steps needed for watching programs. If you could not see the program after finishing these procedures, please contact your engineer or representative.

✓ If you press the MENU or EXIT button in the middle of AUTO SCAN, the first stored channel will be displayed, and the AUTO SCAN stops.

How to Search Manually

You can edit parameters of certain channels and scan them.



- 1 Press MENU button.
Menu items appear on the screen.
- 2 Press ▲ / ▼ Buttons to move to “DTV CHANNEL” icon.
- 3 Press ⏏ button to select “DTV CHANNEL” Icon.
“AUTO SCAN” is highlighted.
- 4 Press ▲ / ▼ Buttons to move to “MANUAL SCAN”.
- 5 Press ⏏ buttons to select “MANUAL SCAN”
MANUAL Scan menu appears.
- 6 Press ▲ / ▼ buttons to move to “Channel”.
- 7 Press ◀ / ▶ buttons to select a channel or press ⏏ button and choose them directly with using the numeric keys.
- 8 Press ▲ / ▼ buttons to move to “Tx Mode”.
- 9 Press ◀ / ▶ buttons, then mode changes in order below.
→ Auto → 8K → 2K →
- 10 Press ▲ / ▼ buttons to move to “Bandwidth”.



- 11 Press ◀ / ▶ buttons to select “Bandwidth”, and set the proper value for the selected Channel.
- 12 Press Up and Down buttons to move to “Scan”.
- 13 Press ↵ buttons to store all the entered channel data. Then you can get the following menu showing the scanning process. After scanning process, the first channel of scanned channel will be displayed.
- 14 Press EXIT button to TV viewing or press MENU button to return to the previous menu.

✓ If the scan fails, please check whether your entered values are correct or not and the signal reception sensitivity is good or bad.

How to Check Channel State

Users can check parameters of certain channels and scan them.



- 1 Press MENU button. Menu items appear on the screen.
- 2 Press ▲ / ▼ Buttons to move to “DTV CHANNEL” icon.
- 3 Press ↵ button to select “DTV CHANNEL” Icon. “AUTO SCAN” is highlighted.
- 4 Press ▲ / ▼ Buttons to move to “CHANNEL STATE” icon.
- 5 Press ↵ buttons to select “CHANNEL STATE” Tuner State menu appears.
- 6 Press ▲ / ▼ buttons to select the channel you want.
- 7 Press EXIT button to TV viewing or press MENU button to return to the previous menu.



- ◆ Level : Indicating selected network signal strength level.
- ◆ Quality : Indicating signal to noise ratio.

✓ When the channel is selected, you can check the reception status of the signal. If the reception signal status is bad, adjust antenna to get the following result.

- ◆ Tuner : Lock
- ◆ FEC : 1/2, 2/3, 3/4, 5/6 or 7/8
- ◆ Level : over 30%
- ◆ Quality : over 40%

How to Use the Guide (EPG : Electronic Program Guide)

Users can check the channel information on the channels of the transponder they are watching.

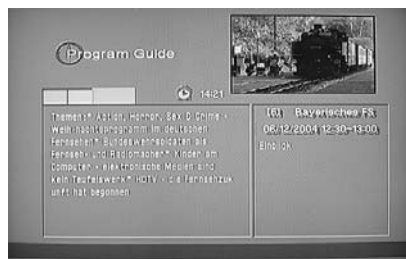

- 1 Press MENU button.
Menu items appear on the screen.
- 2 Press ▲ / ▼ Buttons to move to “DTV CHANNEL” icon.
Press ◀ button to select “DTV CHANNEL” Icon.
“AUTO SCAN” is highlighted.
- 3 Press ▲ / ▼ Buttons to move to “GUIDE”.
- 4 Press ◀ buttons to select “GUIDE”
Program Guide menu appears.
- 5 Press ▲ / ▼ buttons to select Channel, you can see the current or next program information of the selected channel.
➔ Press “GREEN” button. The current or next program information would be converted to the next or current program information respectively.
➔ Press “YELLOW” button. You can see the program schedule list of the selected channel.
- 6 If you want to see the program information of a program in the schedule list, Press ▲ / ▼ buttons to select the program. You will see the information in the right window.
➔ Press “BLUE” button. You will see extended information of the selected program.
- 7 Press EXIT button to TV viewing or press MENU button to return to the previous menu.

✓ supported by 7 language : English, French, German, Italian, Spanish, Dutch, Suomi

How to Select Channel List

Users can change the current channel to any other channel they want.

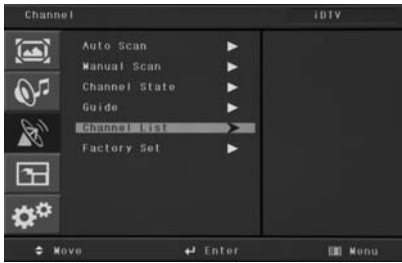

- 1 Press MENU button.
Menu items appear on the screen.
- 2 Press ▲ / ▼ buttons to move to “DTV CHANNEL” icon.
- 3 Press ⏏ button to select “DTV CHANNEL” Icon.
“AUTO SCAN” is highlighted.
- 4 Press ▲ / ▼ buttons to move to “CHANNEL LIST”.
- 5 Press ⏏ buttons to select “CHANNEL LIST”
Channel List menu will appear, detailed information of the selected channel will be displayed in the right section (Name of network, frequency, bandwidth, etc).
- 6 Press ◀ / ▶ (page up/down) or ▲ / ▼ buttons (scroll up/down) buttons to select the channel you want
- 7 Press ⏏ buttons, The selected channel appears on the screen.
- 8 Press EXIT button to TV viewing or press MENU button to return to the previous menu.

How to Set Favorite Channel

Users can store frequently watched channels to quickly access a preferred channel.



- 1 Press MENU button.
Menu items appear on the screen.
- 2 Press ▲ / ▼ buttons to move to “DTV CHANNEL” icon.
- 3 Press ⏏ button to select “DTV CHANNEL” Icon.
“AUTO SCAN” is highlighted.
- 4 Press ▲ / ▼ buttons to move to “CHANNEL LIST”.
- 5 Press ⏏ button to select “CHANNEL LIST”
- 6 Press ◀ / ▶ (page up/down) or ▲ / ▼ buttons (scroll up/down) buttons to select the channel you want
➔ Press RED button, then Favorite State menu appears.
- 7 Press ▲ / ▼ buttons to move to favorite state list of 1~5.
➔ Press WHITE button. You can rename them for their convenience.
- 8 Press ⏏ button. You favorite state list will be stored. An apple symbol will occur on the ALL LIST MENU.
- 9 Press EXIT button to TV viewing or press MENU button to return to the previous menu.

How to Use Channel List Mode

Users can see variant channel lists which may enable them to edit and select channels more conveniently.



- 1 Press CH. LIST button.
Channel list appears on the screen.
- 2 Press "ORANGE" button, then you can see "Channel List Mode" window.
- 3 Select required option by pressing the ▲/ ▼ buttons, then Press ◀/ ▶ buttons to select you want.
- 4 Press ↵ buttons.
You will see the following mode.

◆ **Favorite Mode** : You can see favorite 1 ~ 5 channel list.

◆ **Alphabet Mode** : You can see the channel alphabetical listed.

- ABC : If you want to see all channels listed in alphabetic order, select 'ABC'.

- ETC : If you want to see channels without numeric or alphabetic initials.

◆ **Network Mode** : You can see the channel list in network style.

- 5 Press EXIT button to TV viewing or press MENU button to return to the previous menu.

How to Lock Channel

This menu enables users to prevent children from viewing programs unsuitable for their age.



- 1 Press CH. LIST button.
Channel list menu appears on the screen.
- 2 Press ▲/ ▼ or ◀/ ▶ buttons to select the channel you want to lock.
- 3 Press "GREEN" button.
Then the selected channel is locked.
- 4 Press MENU, EXIT or ↵ button to finish the process.
- 5 Without entering you password, you cannot watch a locked channel's program.
The original password is programmed to 0-0-0-0. Please refer to 38 page "How to Factory Set" for changing the password.

✓ If you want to cancel the channel lock, go to the channel list and select the channel and press GREEN.

How to Set the Channel Order

Users can organize the number or sequence of the channels.



- 1 Press CH. LIST button.
Channel list menu appears on the screen.
- 2 Press ▲ / ▼ or ◀ / ▶ buttons to select the channel you want to move.
- 3 Press “YELLOW” buttons.
- 4 Press ▲ / ▼ or ◀ / ▶ buttons to move to the position you want to move.
- 5 Press ↵ buttons, the channels will move automatically to the programmed position.
- 6 Press MENU, EXIT or ↵ button to finish the process.

How to Delete Channel

Users can delete channels from the channel list.



- 1 Press CH. LIST button.
Channel list menu appears on the screen.
- 2 Press ▲ / ▼ or ◀ / ▶ buttons to select the channel you want to remove.
- 3 Press BLUE buttons.
Then, you need to confirm the deletion.
If you definitely want to delete, press ↵ buttons. If not, press EXIT.
You can find the deleted list in left window.
- 4 Press MENU, EXIT or ↵ button to finish the process.

How to Add Channel

Users add channels they want.



- 1 Press CH. LIST button.
Channel list menu appears on the screen.
- 2 Press WHITE buttons.
The Add Digital Channel window will appear.
- 3 Select the channels with ◀ / ▶ buttons or numeric keys.
- 4 Select required option by pressing the ▲ / ▼ buttons, then Press numeric keys to enter the proper value.
- 5 Press MENU, EXIT or ↵ button to finish the process.

✓ The above mentioned VIDEO PID, AUDIO PID, PCR PID are very important for optimal terrestrial signal reception. We recommend you to get professional advices where available. You can't setup "VIDEO PID" for RADIO channels.

How to Factory Set

The status of the Digital-TV will return to factory default parameters by using this function.



- 1 Press MENU button.
Menu items appear on the screen.
- 2 Press ▲ / ▼ Buttons to move to "DTV CHANNEL" icon.
- 3 Press ↵ button to select "DTV CHANNEL" Icon.
"AUTO SCAN" is highlighted.
- 4 Press ▲ / ▼ Buttons to move to "FACTORY SET".
- 5 Press ↵ buttons to select "FACTORY SET"
"Factory Set" is highlighted.
- 6 Press ↵ button to select "Factory Set".
A window will appear, asking you to confirm.
- 7 When the menu asks you to confirm the reset, press ↵ if you want to reset or press EXIT key if you want to void the reset.

✓ When you forgot your new password, please consult the shop where you bought the TV or the nearest dealer.
✓ After choosing Factory Set, reset the power.

Setting DayLight Saving Time(Summer Time)

Users can use this menu when they want to change a TV channel to a Radio channel or vice versa.



- 1 Press ▲/ ▼ buttons to select "DL Saving"
- 2 Press ◀/ ▶ buttons to select.
Then it will change "YES" or "NO"

YES : Set for daylight saving function activated. The current time automatically moves on hour ahead.

NO : Set for daylight saving function deactivated. The current time automatically moves on hour behind.

✓ Without current local time setting, this menu cannot be processed.

How to TV/RADIO switching

Users can use this menu when they want to change a TV channel to a Radio channel or vice versa.



➔ Press "TV/RADIO" button.



Avoid listening to the radio for a long time, without changing the screen image. It can cause "Image Sticking".

Check "Image Retention Effect (Image Sticking)" at the beginning of the manual.

✓ it will convert to Black screen after 5-10 seconds for remove after image.

How to Subtitle / Audio

Users can adjust the subtitle and audio condition/status of the current channel.



- 1 Press "S.MODE" button.
Subtitle and audio related window will be displayed on the screen.
 - 2 Select required option by pressing the ▲ / ▼ buttons, then Press ◀ / ▶ buttons to select you want.
- If Dig. Output is supported, you can select MPEG Stereo or Dolby Digital/AC3.

✓ These subtitle and audio parameters are workable only when the receiving channel supports these functions

How to Select Channel / Information

Brief information is displayed, such as current channel type, name, local start/end time, guide information, current time, fav/normal mode, Audio mode and Audio ID.



- ➔ Press "INFO" button.
The information bar will pop-up.

✓ If you have no information : Check if your local time settings are correct or information is not sent by the channel provider.

How to Set Teletext in DTV

You can use Teletext service in iDTV mode.

The  icon on the screen means your TV is receiving Teletext service.



- 1 Press "TTX/MIX" button and wait.
If the "*" sign pops up left upside of the screen as the following picture, wait until the teletext service menu is displayed "*" means it provides teletext service. So wait a moment.
- 2 Select your interesting item with numeric keys.

Troubleshooting

Symptom Possible solution

How can I install an antenna?	Refer to page 13.
TV screen is not clear after installing an indoors antenna.	Indoors antenna may experience poor reception due to surrounding buildings. Please install an outdoors antenna or wireless antenna.
How can I view cable broadcasting?	Please install a cable broadcasting receiver (Converter).

Symptom Possible solution

Neither picture nor sound comes up.	Check whether power is on. Check whether the power is cut or whether the power cord is properly connected. Try to plug another product's power cord to the same outlet to check the outlet itself.
Picture turns on slowly after power is on.	This symptom is not a malfunction. This delay is designed to prevent the distorted and noisy picture when the power is on. However, if the picture does not appear more than 5 minutes after the power is on, call a service center.
Picture is distorted or frozen while watching digital broadcasting.	This symptom may be caused by weak reception. Contact your local station or cable company.
Input Source information only appears on black screen.	Check whether your TV is properly connected to external devices.
Poor reception on some channels.	Check whether you selected proper channels. Try re-orienting your antenna. Ensure LNA is activated.
Black and white on some channels.	Check other channels for black and white screen. Adjust colour.
TV won't turn on.	Ensure the power cord is plugged.
Screen is too bright or too dark.	Adjust brightness.
Auto On does not work.	Ensure to use the remote control or power button on the product to turn off your TV. If you unplug the power cord, the stand-by consumption power becomes 0 (zero), which causes the programmed time to be erased.

Troubleshooting

After setting the time, I turned TV off and turn it on. The programmed information has been erased.

Ensure to use the remote control or power button on the product to turn off your TV. If you unplug the power cord, the stand-by consumption power becomes 0 (zero), which causes the programmed time to be erased.

Symptom Possible solution

Too much noise occurs.	Check whether the audio setting is in the Stereo mode. In the Stereo mode, the sound may be distorted in areas with poor reception or located far away from a TV broadcasting station.
No sound while viewing a cable channel	Make sure audio or audio/video components are securely inserted into the appropriate jacks. Check other channels for sound. Check the volume settings on the cable broadcasting receiver.
Picture is OK but sound does not come out.	Try to press volume up/volume down buttons of your remote control.
One of the speakers does not produce sound.	Select sound balance and make proper adjustment. (Page 23) Check the speaker connection cables.

Symptom Possible solution

Remote control won't work.	Check whether there is a blocking object between the remote control and PDP. Make sure your PDP is Power On. (Normally, the LED on the front panel is red.) Check whether batteries are inserted with proper polarities(+, -). When the batteries are worn out, replace them.
Where does the S-Video cable plug in for audio output?	Connect the two Audio jacks from the S-Video cable to the left and right ports on the Composite.
Strange noises are heard.	Ticking noises during or after watching are caused by the change of ambient environment such as humidity and temperature, which is characterized by plastic products. Strange ticking noises occur because a signal is suddenly transmitted to the PDP panel. So, It is not a malfunction.
I tried to use the TV screen as a PC monitor but it doesn't work.	Adjust the resolution referring to the standard signal mode table. Check the specification of your video card installed in your PC. If your video card does not work in the supported hardware, try upgrading the video card's driver.

Product Specifications

Model		E260D	E320D/E370D	E420D/E460D	
Input	Full-Scart	1 (A/V)	1 (A/V)	1 (A/V)	
	Half-Scart	1 (A/V)	1 (A/V)	1 (A/V)	
	S-Video	1 (A/V audio common)	1 (A/V audio common)	1 (A/V audio common)	
	Video (RCA)	1 (Audio included)	1 (Audio included)	1 (Audio included)	
	Component(Y/Cb/Cr)	1 (Audio included)	1 (Audio included)	1 (Audio included)	
	Antenna	1	1	1	
	PC Connection jack	D-SUB	D-SUB	D-SUB	
	Max. resolution	1366 X 768 @ 75 Hz	1366 X 768 @ 75 Hz	1366 X 768 @ 75 Hz	
Video Output	Audio	L/R	L/R	L/R	
	DVI-HDCP / HDMI	1	1	1	
		1 (Audio included)	1 (Audio included)	1 (Audio included)	
	Audio Output	Digital SPDIF Optical	1	1	1
		Digital SPDIF Coaxial	1	1	1
		Subwoofer	1	1	1
	TV/Video	Color system	PAL/SECAM L	PAL/SECAM L	PAL/SECAM L
		Sound system	FM, NICAM	FM, NICAM	FM, NICAM
Video system		Component, S-Video, Composite, PC, DVI/HDMI	Component, S-Video, Composite, PC, DVI/HDMI	Component, S-Video, Composite, PC, DVI/HDMI	
Power	Supply	AC 100 - 240 V, 50/60 Hz	AC 100 - 240 V, 50/60 Hz	AC 100 - 240 V, 50/60 Hz	
	Consumption power	Typical 120W	Typical 150W	Typical 225W	
	Stand-by power	Typical 3W	Typical 3W	Typical 3W	
Dimension (W x D x H mm - Stand included)		684 x 194 x 541.5	E320D : 806x 229 x 617 E370D : 939x350 x728	E420D : 1057 x 350 x 796 E460D : 1143 x 350 x845	
	Weigh (Stand included)	12.6 Kg	E320D : 17.0 Kg E370D : 26.6Kg	E420D : 32.6 Kg E460D : 31.0Kg	
Control type		Remote control, Key control	Remote control, Key control	Remote control, Key control	

- The above specifications may be subject to change without prior notice.

Product Specifications

Model		E261D	E321D/E371D	E421D/E461D
Input	Full-Scart	1 (A/V)	1 (A/V)	1 (A/V)
	Half-Scart	1 (A/V)	1 (A/V)	1 (A/V)
	S-Video	1 (A/V audio common)	1 (A/V audio common)	1 (A/V audio common)
	Video (RCA)	1 (Audio included)	1 (Audio included)	1 (Audio included)
	Component(Y/Cb/Cr)	1 (Audio included)	1 (Audio included)	1 (Audio included)
	Antenna	1	1	1
	PC Connection jack	D-SUB	D-SUB	D-SUB
	Max. resolution	1366 X 768 @ 75 Hz	1366 X 768 @ 75 Hz	1366 X 768 @ 75 Hz
	Audio	L/R	L/R	L/R
DVI-HDCP / HDMI	1	1	1	
Video Output		1 (Audio included)	1 (Audio included)	1 (Audio included)
Audio Output	Digital SPDIF Optical	1	1	1
	Digital SPDIF Coaxial	1	1	1
	Subwoofer	1	1	1
TV/Video	Color system	PAL/SECAM L	PAL/SECAM L	PAL/SECAM L
	Sound system	FM, NICAM	FM, NICAM	FM, NICAM
	Video system	Component, S-Video, Composite, PC, DVI/HDMI	Component, S-Video, Composite, PC, DVI/HDMI	Component, S-Video, Composite, PC, DVI/HDMI
Power	Supply	AC 100 - 240 V, 50/60 Hz	AC 100 - 240 V, 50/60 Hz	AC 100 - 240 V, 50/60 Hz
	Consumption power	Typical 120W	Typical 150W	Typical 225W
	Stand-by power	Typical 3W	Typical 3W	Typical 3W
Dimension (W x D x H mm - Stand included)	815 x 194 x 476.5		E321D : 965x 229 x 551	E421D : 1057 x 350 x 796
			E371D : 1090x310 x627	E461D : 1143 x 350 x845
Weigh (Stand included)	12.6 Kg		E321D : 17.0 Kg	E421D : 32.6 Kg
			E371D : 26.6Kg	E461D : 31.0Kg
Control type		Remote control, Key control	Remote control, Key control	Remote control, Key control

- The above specifications may be subject to change without prior notice.

Free Manuals Download Website

<http://myh66.com>

<http://usermanuals.us>

<http://www.somanuals.com>

<http://www.4manuals.cc>

<http://www.manual-lib.com>

<http://www.404manual.com>

<http://www.luxmanual.com>

<http://aubethermostatmanual.com>

Golf course search by state

<http://golfingnear.com>

Email search by domain

<http://emailbydomain.com>

Auto manuals search

<http://auto.somanuals.com>

TV manuals search

<http://tv.somanuals.com>