

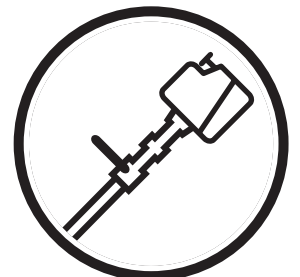

Operator's manual
125BT 141B 155B
165BT

Please read the operator's manual carefully and make sure you understand the instructions before using the machine.



English

KEY TO SYMBOLS

Symbols

WARNING! The machine can be a dangerous tool if used incorrectly or carelessly, which can cause serious or fatal injury to the operator or others.



Please read the operator's manual carefully and make sure you understand the instructions before using the machine.



Always wear:

- Approved hearing protection
- Protective goggles or a visor



This product is in accordance with applicable EC directives.



Always wear approved protective gloves.



Wear sturdy, non-slip boots.



The blower can forcibly throw objects that can bounce back. This can result in serious eye injuries.



The blower operator must ensure that no people or animals come closer than 10 metres. When several operators are working at the same site a safety distance of at least 10 metres must be in effect.



Noise emission to the environment according to the European Community's Directive. The machine's emission is specified in chapter Technical data and on label.



Other symbols/decals on the machine refer to special certification requirements for certain markets.

Switch off the engine by moving the stop switch to the STOP position before carrying out any checks or maintenance.

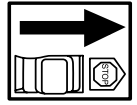

Always wear approved protective gloves.



Regular cleaning is required.

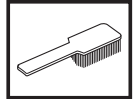

Visual check.



Protective goggles or a visor must be worn.



CONTENTS

Contents

KEY TO SYMBOLS

Symbols 2

CONTENTS

Contents 3

Note the following before starting: 3

SAFETY INSTRUCTIONS

Personal protective equipment 4

Machine's safety equipment 4

Checking, maintaining and servicing the machine's safety equipment 5

General safety precautions 6

General working instructions 7

WHAT IS WHAT?

What is what? 9

WHAT IS WHAT?

What is what? 10

ASSEMBLY

Assembly of the blower 11

FUEL HANDLING

Fuel 12

Fuelling 12

STARTING AND STOPPING

Starting and stopping 13

MAINTENANCE

Carburettor 14

Muffler 14

Cooling system 14

Spark plug 15

Air filter 15

Maintenance schedule 16

TECHNICAL DATA

Technical data 17

EC-declaration of conformity 18

EC-declaration of conformity 19

Note the following before starting:

Please read the operator's manual carefully.

Long-term exposure to noise can result in permanent hearing impairment. So always use approved hearing protection.



WARNING! Under no circumstances may the design of the machine be modified without the permission of the manufacturer. Always use genuine accessories. Non-authorized modifications and/or accessories can result in serious personal injury or the death of the operator or others.



WARNING! A blower is a dangerous tool if used carelessly or incorrectly and can cause serious, even fatal injuries. It is extremely important that you read and understand the contents of this Operator's manual.

Husqvarna AB has a policy of continuous product development and therefore reserves the right to modify the design and appearance of products without prior notice.

SAFETY INSTRUCTIONS

Personal protective equipment



WARNING! You must use approved personal protective equipment whenever you use the machine. Personal protective equipment cannot eliminate the risk of injury but it will reduce the degree of injury if an accident does happen. Ask your dealer for help in choosing the right equipment. Please read the operator's manual carefully and make sure you understand the instructions before using the machine.



WARNING! Listen out for warning signals or shouts when you are wearing hearing protection. Always remove your hearing protection as soon as the engine stops.

- Gloves should be worn when necessary.



- Wear hearing protection that provides adequate noise reduction.



- Always wear approved eye protection. If you use a visor then you must also wear approved protective goggles. Approved protective goggles must comply with standard ANSI Z87.1 in the USA or EN 166 in EU countries. Visors must comply with standard EN 1731.

Blows from branches or objects that are thrown can damage the eyes.

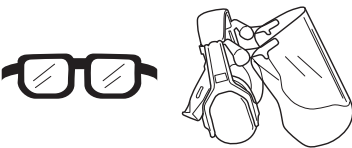

- Wear sturdy, non-slip boots.



- Wear clothes made of a strong fabric and avoid loose clothing that can catch on twigs and branches. Always wear heavy, long pants. Do not wear jewellery, shorts sandals or go barefoot. Secure hair so it is above shoulder level.

- A breathing mask should be used when there is a risk of dust.

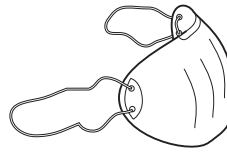

- Always have a first aid kit nearby.



Machine's safety equipment

This section describes the machine's safety equipment, its purpose, and how checks and maintenance should be carried out to ensure that it operates correctly. See the "What is what?" section to locate where this equipment is positioned on your machine.

The life span of the machine can be reduced and the risk of accidents can increase if machine maintenance is not carried out correctly and if service and/or repairs are not carried out professionally. If you need further information please contact your nearest service workshop.



WARNING! Never use a machine that has faulty safety equipment! Carry out the inspection, maintenance and service routines listed in this section.

Stop switch

Use the stop switch to switch off the engine.

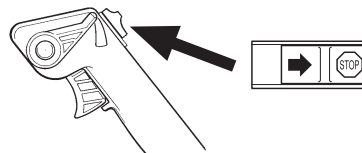

Quick release

(141B, 155B, 165BT)

At the front is an easily accessible, quick release. Use this if the engine catches fire or in any other emergency situation that requires you to free yourself from the machine and harness.

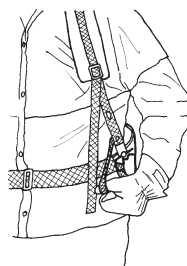

SAFETY INSTRUCTIONS

Vibration damping system

Your machine is equipped with a vibration damping system that is designed to minimize vibration and make operation easier.

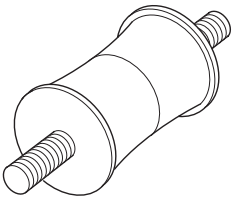

The machine's vibration damping system reduces the transfer of vibrations.



WARNING! Overexposure to vibration can lead to circulatory damage or nerve damage in people who have impaired circulation. Contact your doctor if you experience symptoms of overexposure to vibration. Such symptoms include numbness, loss of feeling, tingling, pricking, pain, loss of strength, changes in skin colour or condition. These symptoms normally appear in the fingers, hands or wrists. The risk increases at low temperatures.

Muffler

The muffler is designed to keep noise levels to a minimum and to direct exhaust fumes away from the user.



In countries that have a warm and dry climate there is a significant risk of fire. We therefore fit certain mufflers with a spark arrestor mesh. Check whether the muffler on your machine is fitted with this kind of mesh.

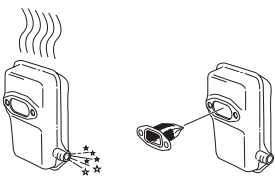

For mufflers it is very important that you follow the instructions on checking, maintaining and servicing your machine. See instructions under the heading Checking, maintaining and servicing the machine's safety equipment.



WARNING! Mufflers fitted with catalytic converters get very hot during use and remain so for some time after stopping. This also applies at idle speed. Contact can result in burns to the skin. Remember the risk of fire!



WARNING! Bear in mind that:

Engine exhaust fumes contain carbon monoxide, which can cause carbon monoxide poisoning. For this reason you should not start or run the machine indoors, or anywhere that is poorly ventilated.

The exhaust fumes from the engine are hot and may contain sparks which can start a fire. Never start the machine indoors or near combustible material!



WARNING! The inside of the muffler contain chemicals that may be carcinogenic. Avoid contact with these elements in the event of a damaged muffler.

Checking, maintaining and servicing the machine's safety equipment



WARNING! All servicing and repair work on the machine requires special training. This is especially true of the machine's safety equipment. If your machine fails any of the checks described below you must contact your service agent. When you buy any of our products we guarantee the availability of professional repairs and service. If the retailer who sells your machine is not a servicing dealer, ask him for the address of your nearest service agent.



WARNING! Never use a machine with faulty safety equipment. The machine's safety equipment must be checked and maintained as described in this section. If your machine fails any of these checks contact your service agent to get it repaired.

Stop switch

- Start the engine and make sure the engine stops when you move the stop switch to the stop setting.

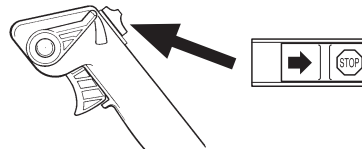

SAFETY INSTRUCTIONS

Vibration damping system

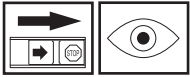

- Regularly check the vibration damping units for cracks or deformation.

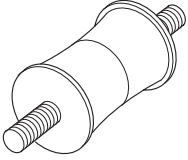

- Check that the vibration damping element is undamaged and securely attached.

Muffler



- Never use a machine that has a faulty muffler.



- Regularly check that the muffler is securely attached to the machine.

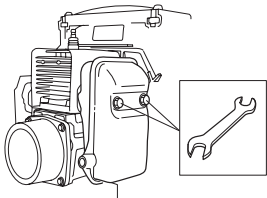

- If the muffler on your machine is fitted with a spark arrestor mesh this must be cleaned regularly. A blocked mesh will cause the engine to overheat and may lead to serious damage.

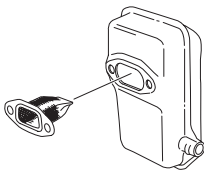

- Never use a muffler with a defective spark arrestor mesh.

Quick release

(141B, 155B, 165BT)

Check that the harness straps are correctly positioned. Once the harness and machine have been adjusted, check that the harness quick release works correctly.

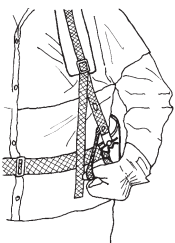

General safety precautions

IMPORTANT INFORMATION

The only accessories you can use with this engine unit are those we recommend in the "Technical data chapter".

Never use the machine if you are tired, if you have drunk alcohol, or if you are taking medication that could affect your vision, your judgement or your co-ordination.

Wear personal protective equipment. See instructions under the heading Personal protective equipment.

Never use a machine that has been modified in any way from its original specification.

Never use a machine that is faulty. Carry out the checks, maintenance and service instructions described in this manual. Some maintenance and service measures must be carried out by trained and qualified specialists. See instructions under the heading Maintenance.

All covers and guards must be fitted before starting. Make sure the spark plug cap and HT lead are not damaged. Otherwise you could get an electric shock.

The blower operator must ensure that no people or animals come closer than 10 metres. When several operators are working at the same site a safety distance of at least 10 metres must be in effect.

Starting



- Never start the machine indoors. Exhaust fumes can be dangerous if inhaled.
- Observe the surroundings and ensure that no people or animals can come into contact with the blower.
- Place the machine on the ground, press the machine body against the ground with your left hand (NOTE! Not with your foot). Then grasp the starter handle with your right hand and pull the cord.

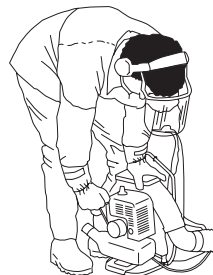

Fuel safety



- Always use a fuel container with an anti-spill valve.
- Never refuel the machine while the engine is running. Always stop the engine and let it cool for a few minutes before refuelling.
- Make sure there is plenty of ventilation when refuelling or mixing fuel (petrol and 2-stroke oil).
- Avoid all skin contact with fuel. Fuel is a skin irritant and may even cause skin changes.

SAFETY INSTRUCTIONS

- Move the machine at least 3 m from the refuelling point before starting it.

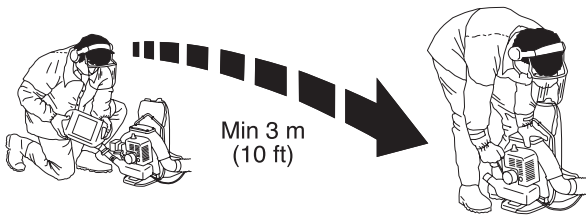

- Never start the machine:
 - If you have spilt fuel on it. Wipe off the spillage and allow remaining fuel to evaporate.
 - If you have spilt fuel on yourself or your clothes, change your clothes. Wash any part of your body that has come in contact with fuel. Use soap and water.
 - If the machine is leaking fuel. Check regularly for leaks from the fuel cap and fuel lines.

Transport and storage

- Store and transport the machine and fuel so that there is no risk of any leakage or fumes coming into contact with sparks or naked flames, for example, from electrical machinery, electric motors, electrical relays/switches or boilers.
- When storing and transporting fuel always use approved containers intended for this purpose.
- When storing the machine for long periods the fuel tank must be emptied. Contact your local petrol station to find out where to dispose of excess fuel.
- Ensure the machine is cleaned and that a complete service is carried out before long-term storage.



WARNING! Take care when handling fuel. Bear in mind the risk of fire, explosion and inhaling fumes.

Adjusting the harness



WARNING! The harness must always be worn when working with the machine. Failure to do so means you will be unable to manoeuvre safely and this can result in injury to yourself or others. Never wear a harness with a defective quick release.

Quick release

(141B, 155B, 165BT)

At the front is an easily accessible, quick release. Use this if the engine catches fire or in any other emergency situation that requires you to free yourself from the machine and harness.

- Pull out the red strap.

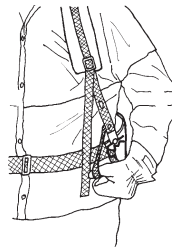

- The hip strap and one shoulder strap will then be automatically released at the same time and the harness and engine unit will slide to the ground.

Spreading the load on your shoulders

A well-adjusted harness and machine makes work much easier. Adjust the harness for the best working position. Tension the side straps so that the weight is evenly distributed across both shoulders.



General working instructions

IMPORTANT! This section considers basic safety rules when working with blowers. If you encounter a situation where you are uncertain how to proceed you should ask an expert. Contact your dealer or your service workshop. Avoid all usage which you consider to be beyond your capability.

Show consideration to persons in your surroundings by avoiding using the machine at unsuitable times, such as late in the evening or early in the morning. Read through and follow the simple directions so that you disturb your surroundings as little as possible.

- Use the blower with the lowest possible throttle. It is seldom necessary to use full throttle, and many work procedures can be done at half throttle. A lower throttle means less noise and less dust, and it is also easier to keep control over the rubbish collected together/moved.

SAFETY INSTRUCTIONS

- Use a rake or a brush to release rubbish stuck to the ground.
- Hold the opening of the blower as close to the ground as possible.
- Observe your surroundings. If anyone approaches your work area, set the throttle control to the lowest throttle until the person is at a safe distance. Direct the blower away from people, animals, play areas, and cars etc.
- Clean up afterwards. Make sure that you have not blown rubbish into someone's garden.

Basic safety rules



- No unauthorised persons or animals may be present in the working area, which is 10 metres.
- The powerful currents of air can move objects at such a speed that they can bounce back and cause serious eye injuries.

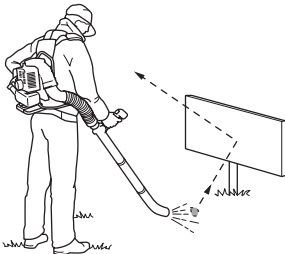

- Do not direct the air jet towards people or animals.
- Stop the engine before assembling or dismantling accessories or other parts.
- Do not use the machine in bad weather, such as dense fog, heavy rain, strong wind, intense cold, etc. Working in bad weather is tiring and can lead to dangerous conditions, e.g. slippery surfaces.
- Make sure you can move and stand safely. Check the area around you for possible obstacles (roots, rocks, branches, ditches, etc.) in case you have to move suddenly. Take great care when working on sloping ground.
- Never put the machine down with the engine running unless you have it in clear sight.
- Engine exhaust fumes contain carbon monoxide, which can cause carbon monoxide poisoning. For this reason you should not start or run the machine indoors, or anywhere that is poorly ventilated.
- The blower must not be used while on a ladder or scaffolding.

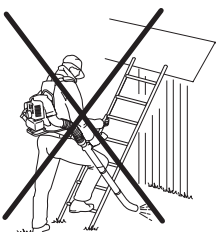

- **CAUTION!** Do not use the machine unless you are able to call for help in the event of an accident.

Basic working techniques

- Adjust the harness so that the machine is easy to carry.



WARNING! Watch out for thrown objects. Always wear eye protection. Stones, rubbish, etc. can be thrown up into the eyes causing blindness or serious injury. Keep unauthorised persons at a distance. Children, animals, onlookers and helpers should be kept outside the safety zone of 10 m. Stop the machine immediately if anyone approaches.



WARNING! Always stop the engine before cleaning.

- The speed of the air jet is controlled with the throttle. Select the speed that best suits the application. To avoid holding your finger on the throttle all the time when using the blower, the required throttle can be set with the throttle adjuster (D). Full throttle is obtained when the throttle adjuster is pushed in fully.

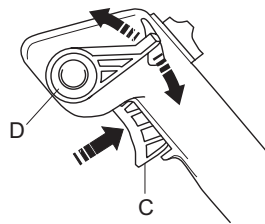

- Make sure that the air intake is not blocked by leaves or rubbish. This will reduce the machine's air blowing capacity and increase the engine's working temperature, which can lead to engine failure. Stop the engine and remove the object.

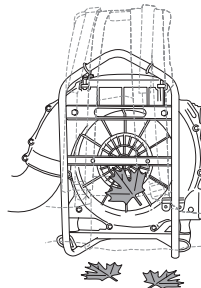

- Be aware of the wind direction. Work with the wind to make your work easier.
- Using the blower to move large piles is time consuming and creates unnecessary noise.

WHAT IS WHAT?

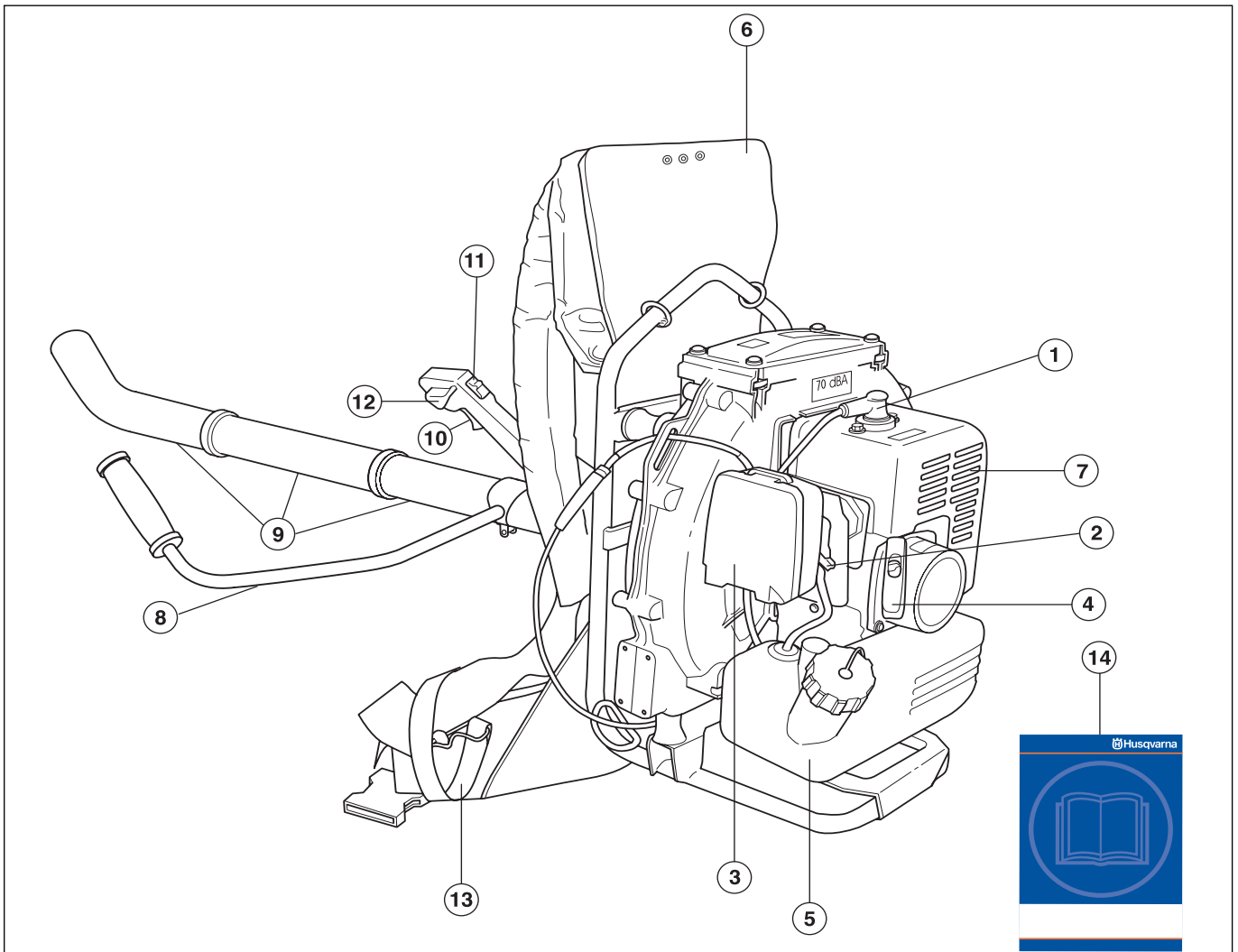

What is what?

- | | |
|------------------|----------------------|
| 1 Spark plug | 8 Handlebar |
| 2 Choke control | 9 Blow pipe |
| 3 Air filter | 10 Throttle control |
| 4 Starter handle | 11 Stop switch |
| 5 Fuel tank | 12 Throttle adjuster |
| 6 Harness | 13 Safety strap |
| 7 Muffler | 14 Operator's manual |

WHAT IS WHAT?

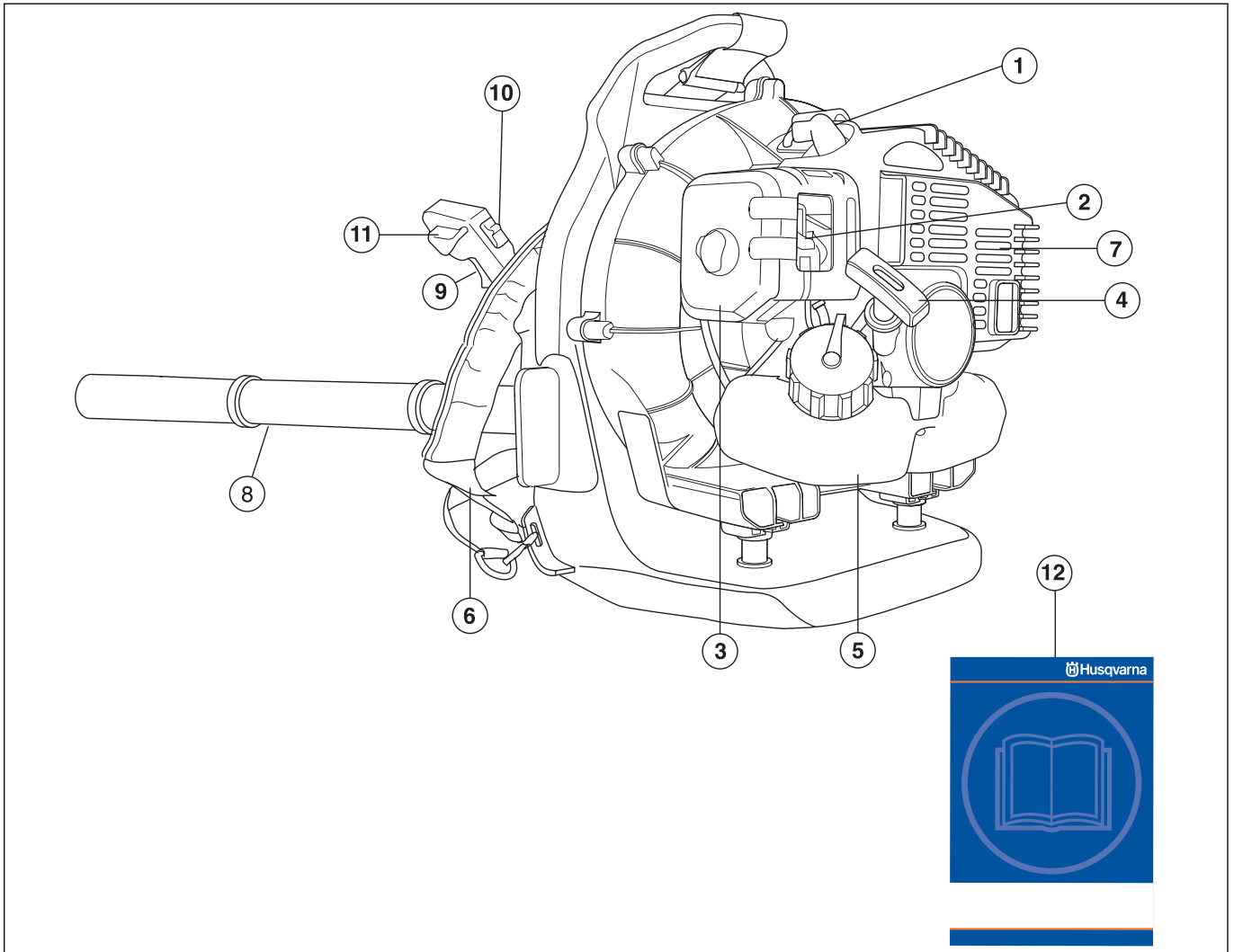

What is what?

- | | |
|------------------|----------------------|
| 1 Spark plug | 7 Muffler |
| 2 Choke control | 8 Blow pipe |
| 3 Air filter | 9 Throttle control |
| 4 Starter handle | 10 Stop switch |
| 5 Fuel tank | 11 Throttle adjuster |
| 6 Harness | 12 Operator's manual |

ASSEMBLY

Assembly of the blower

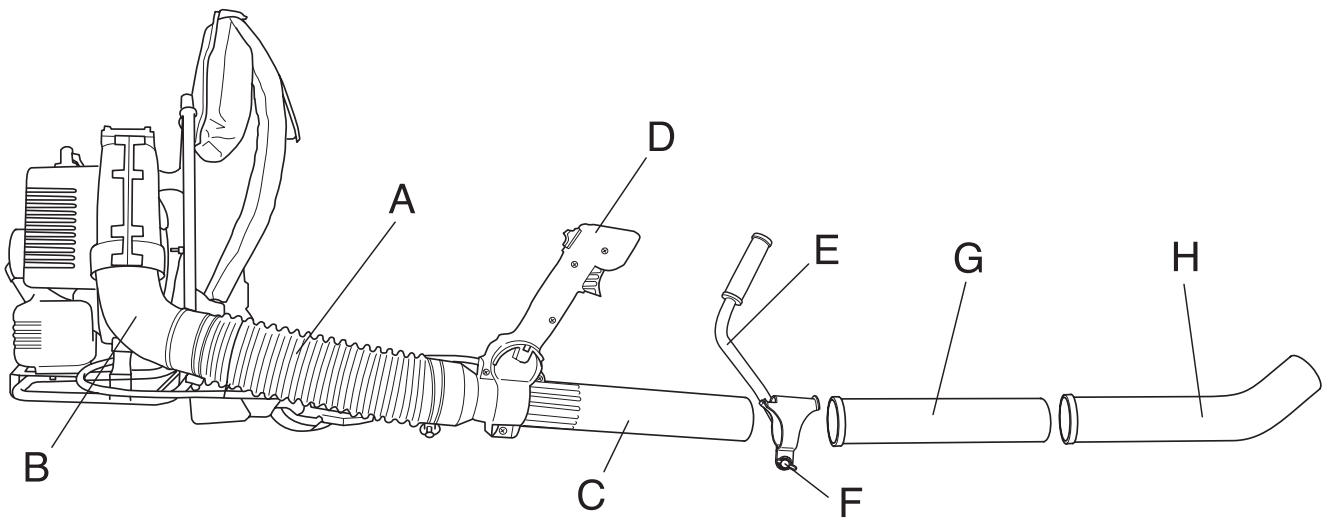

- 1 Connect the flexible hose (A) to the fan's outlet tube (B) with a hose clamp.
- 2 Connect the operating tube (C) to the flexible hose with a hose clamp.
- 3 Fit the control handle (D) on the operating tube (C).
- 4 Fit the handlebar (E) on the operating tube and tighten the screw (F). (**141B, 155B, 165BT**)
- 5 Connect the intermediate tube (G) and air nozzle (H). Push the tubes together and turn them so that they lock together.

CAUTION! The operating tube can be turned round its axis to direct the air jet.

FUEL HANDLING

Fuel

CAUTION! The machine is equipped with a two-stroke engine and must always be run using a mixture of petrol and two-stroke engine oil. It is important to accurately measure the amount of oil to be mixed to ensure that the correct mixture is obtained. When mixing small amounts of fuel, even small inaccuracies can drastically affect the ratio of the mixture.



WARNING! Always ensure there is adequate ventilation when handling fuel.

Petrol



CAUTION!

Always use a good quality petrol/oil mixture (at least 90 octane). If your machine is equipped with a catalytic converter (see chapter on Technical data) always use a good quality unleaded petrol/oil mixture. Leaded petrol will destroy the catalytic converter and it will no longer serve its purpose.



- The lowest recommended octane rating is 90. If you run the engine on a petrol with a lower octane rating than 90 this can cause knocking. This leads to an increased engine temperature, which can result in serious engine damage.
- When working at continuous high revs a higher octane rating is recommended.

Two-stroke oil

- For best results and performance use HUSQVARNA two-stroke oil, which is specially formulated for our two-stroke engines. Mixture 1:50 (2%).
- If HUSQVARNA two-stroke oil is not available, you may use another two-stroke oil of good quality that is intended for air cooled engines. Contact your dealer when selecting an oil. Mixing ratio 1:33 (3%).
- Never use two-stroke oil intended for water-cooled outboard engines, sometimes referred to as outboard oil.
- Never use oil intended for four-stroke engines.

Petrol, litre	Two-stroke oil, litre	
	2% (1:50)	3% (1:33)
5	0,10	0,15
10	0,20	0,30
15	0,30	0,45
20	0,40	0,60

Mixing

- Always mix the petrol and oil in a clean container intended for fuel.
- Always start by filling half the amount of the petrol to be used. Then add the entire amount of oil. Mix (shake) the fuel mixture. Add the remaining amount of petrol.
- Mix (shake) the fuel mixture thoroughly before filling the machine's fuel tank.

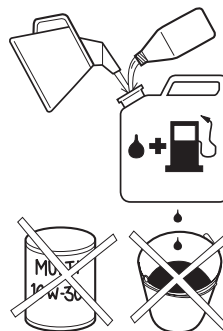

- Do not mix more than one month's supply of fuel at a time.
- If the machine is not used for some time the fuel tank should be emptied and cleaned.

Fuelling



WARNING! Taking the following precautions, will lessen the risk of fire:

Do not smoke or place hot objects near fuel.

Always shut off the engine before refuelling.

Always stop the engine and let it cool for a few minutes before refuelling.

When refuelling, open the fuel cap slowly so that any excess pressure is released gently.

Tighten the fuel cap carefully after refuelling.

Always move the machine away from the refuelling area before starting.

- Move the machine at least 3 m from the refuelling point before starting it.

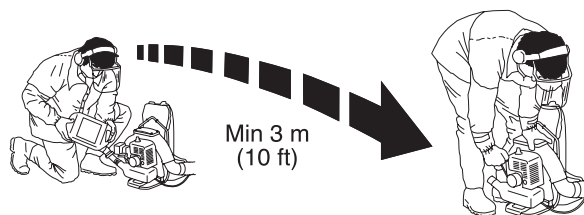

- Clean the area around the fuel cap. Contamination in the tank can cause operating problems.
- Ensure that the fuel is well mixed by shaking the container before filling the tank.

STARTING AND STOPPING

Starting and stopping



WARNING! Always move the machine away from the refuelling area before starting. Place the machine on a flat surface.

Make sure no unauthorised persons are in the working area, otherwise there is a risk of serious personal injury. The safety distance is 10 metres.

The machine may only be started in its complete design. If the machine is started without all the guards fitted there is a risk of personal injuries.

Cold engine

Ignition:

Set the stop switch to the start position.

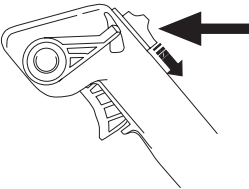

Choke: Set the choke control in the choke position.

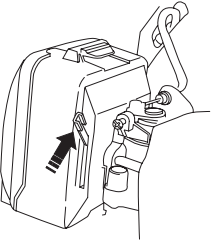

Air purge: Press the air purge diaphragm repeatedly until fuel begins to fill the diaphragm. The diaphragm need not be completely filled.

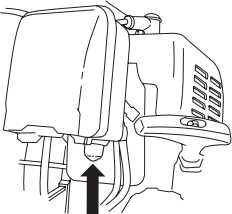

Warm engine

Use the same starting procedure as for a cold engine but without setting the choke control in the choke position.

Starting

Hold the body of the machine on the ground using your left hand (CAUTION! Not with your foot!).

Grip the starter handle, slowly pull out the cord with your right hand until you feel some resistance (the starter pawls grip), now quickly and powerfully pull the cord.

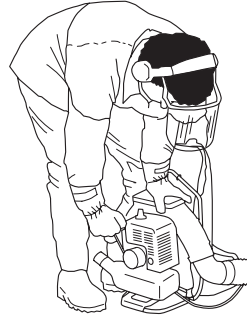

Reset the choke when the engine fires, repeat pulling the cord until the engine starts. **Never twist the starter cord around your hand.**

CAUTION! Do not pull the starter cord all the way out and do not let go of the starter handle when the cord is fully extended. This can damage the machine.

Stopping

The engine is stopped by moving the stop switch to the stop position.

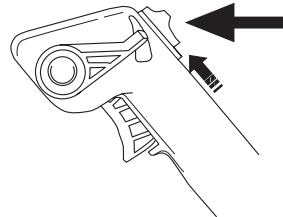

MAINTENANCE

Carburettor

Your Husqvarna product has been designed and manufactured to specifications that reduce harmful emissions. After the engine has used 8-10 tanks of fuel the engine will be run-in. To ensure that it continues to run at peak performance and to minimise harmful exhaust emissions after the running-in period, ask your dealer/service workshop (who will have a rev counter at their disposal) to adjust your carburettor.



WARNING! The machine may only be started in its complete design. If the machine is started without all the guards fitted there is a risk of personal injuries.

Function



The carburettor governs the engine's speed via the throttle control. Air and fuel are mixed in the carburettor. The air/fuel mixture is adjustable. Correct adjustment is essential to get the best performance from the machine.

Adjusting the carburettor means that the engine is adapted to local operating conditions, e.g. climate, altitude, petrol and the type of 2-stroke oil.

Fine adjustment of the idle speed T

Adjust the idle speed using the idle adjustment screw T, if it is necessary to readjust.

The T-screw regulates the throttle setting at idle speed. If the T-screw is turned clockwise this gives a higher idle speed; turning it anti-clockwise gives a lower idle speed. The idle speed is correctly adjusted when the engine will run smoothly in every position.

Rec. idle speed See the Technical data section.

Muffler



The muffler is designed to reduce the noise level and to direct the exhaust gases away from the operator. The exhaust gases are hot and can contain sparks, which may cause fire if directed against dry and combustible material.

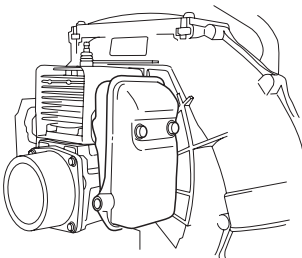

Some mufflers are equipped with a special spark arrest screen. If your machine is fitted with this type of screen it should be cleaned regularly. This is done using a wire brush. On mufflers without a catalytic converter the screen should be cleaned weekly, or replaced if necessary. On mufflers fitted

with a catalytic converter the screen should be checked and cleaned monthly. **If the screen is damaged it should be replaced.** If the screen is frequently blocked, this can be a sign that the function of the catalytic converter is impaired.

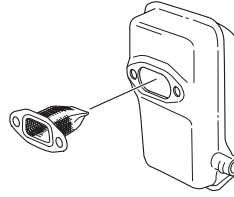

CAUTION! Never use a machine with a defective muffler.

Cooling system



To keep the working temperature as low as possible the machine is equipped with a cooling system.

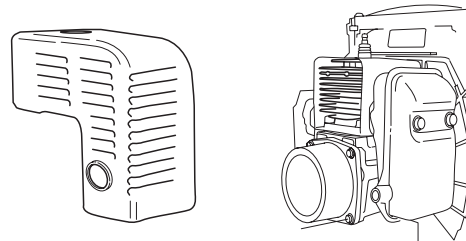

The cooling system consists of:

- 1 Air intake on the starter.
- 2 Fins on the flywheel.
- 3 Cooling fins on the cylinder.
- 4 Cylinder cover (directs cold air over the cylinder).

Clean the cooling system with a brush once a week, more often in demanding conditions. A dirty or blocked cooling system results in the machine overheating which causes damage to the piston and cylinder.

MAINTENANCE

Spark plug



The spark plug condition is influenced by:

- Incorrect carburettor adjustment.
- An incorrect fuel mixture (too much or incorrect type of oil).
- A dirty air filter.

These factors cause deposits on the spark plug electrodes, which may result in operating problems and starting difficulties.

If the machine is low on power, difficult to start or runs poorly at idle speed: always check the spark plug first before taking any further action. If the spark plug is dirty, clean it and check that the electrode gap is 0.5/0,6 mm. The spark plug should be replaced after about a month in operation or earlier if necessary.

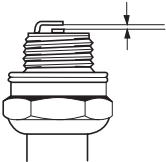

CAUTION! Always use the recommended spark plug type! Use of the wrong spark plug can damage the piston/cylinder.

Air filter

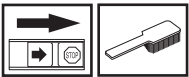

The air filter must be regularly cleaned to remove dust and dirt in order to avoid:

- Carburettor malfunctions
- Starting problems
- Loss of engine power
- Unnecessary wear to engine parts.
- Excessive fuel consumption.

Clean the filter every 25 hours, or more regularly if conditions are exceptionally dusty.

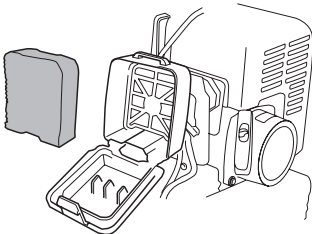

Cleaning the air filter

Remove the air filter cover and take out the filter. Wash it clean in warm, soapy water.

Ensure that the filter is dry before refitting it.

An air filter that has been in use for a long time cannot be cleaned completely. The filter must therefore be replaced with a new one at regular intervals. **A damaged air filter must always be replaced.**

If the machine is used in dusty conditions the air filter should be soaked in oil. See instructions under the heading Oiling the air filter.

Oiling the air filter

Always use HUSQVARNA filter oil, art. no. 531 00 92-48. The filter oil contains a solvent to make it spread evenly through the filter. You should therefore avoid skin contact.

Put the filter in a plastic bag and pour the filter oil over it. Knead the plastic bag to distribute the oil. Squeeze the excess oil out of the filter inside the plastic bag and pour off the excess before fitting the filter to the machine. Never use common engine oil. This would drain through the filter quite quickly and collect in the bottom.

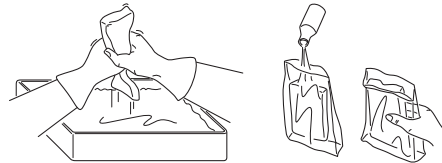

MAINTENANCE

Maintenance schedule

Below you will find some general maintenance instructions. If you need further information please contact your service workshop.

Daily maintenance

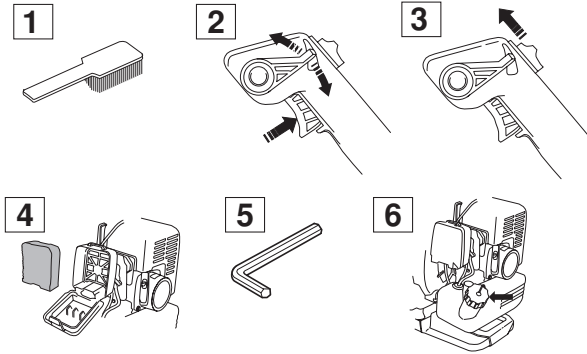

- 1 Clean the outside of the machine.
- 2 Check that the throttle control functions safely.
- 3 Check that the stop switch works correctly.
- 4 Clean the air filter. Replace if necessary.
- 5 Check that nuts and screws are tight.
- 6 Check that there are no fuel leaks.

Weekly maintenance

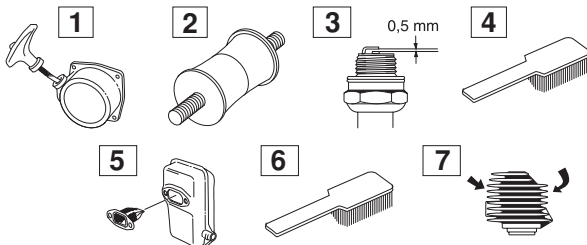

- 1 Check the starter and starter cord.
- 2 Check that the vibration damping elements are not damaged.
- 3 Clean the outside of the spark plug. Remove it and check the electrode gap. Adjust the gap to 0.5/0,6 mm or replace the spark plug.
- 4 Clean the cooling fins on the flywheel.
- 5 Clean or replace the spark arrestor mesh on the muffler (only applies to mufflers without a catalytic converter).
- 6 Clean the carburettor compartment.
- 7 Clean the cooling fins on the cylinder and check that the air intake near the starter is not blocked.

Monthly maintenance

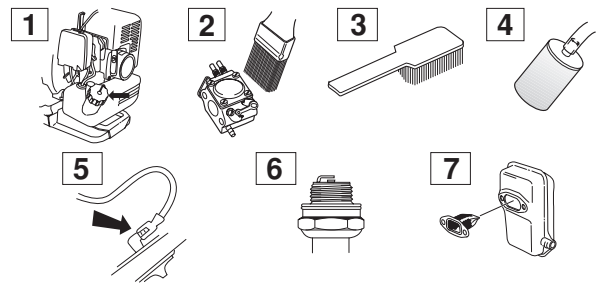

- 1 Clean the fuel tank.
- 2 Clean the outside of the carburettor and the space around it.
- 3 Clean the fan and the area around it.
- 4 Check the fuel filter and the fuel hose. Replace if necessary.
- 5 Check all cables and connections.
- 6 Replace the spark plug.
- 7 Check and clean the spark arrestor mesh on the muffler (only applies to mufflers fitted with a catalytic converter).

TECHNICAL DATA

Technical data

Technical data	125BT	141B	155B	165BT
Engine				
Cylinder displacement, cm ³	25,4	40,2	48,7	59,2
Cylinder bore, mm	34	40	44	47,1
Stroke, mm	28	32	32	34
Idle speed, rpm	3300	2500	2500	3000
Recommended max. speed:	7800	7500	7500	7500
Max. engine output, acc. to ISO 8893, kW/ rpm	0,7/7800	2,0/7500	2,2/7500	2,4/7500
Catalytic converter muffler	No	No	No	No
Ignition system				
Type of ignition system	Electronic	Electronic	Electronic	Electronic
Spark plug	NGK BPMR6A	NGK BPMR 7A	NGK BPMR 7A	NGK BPMR 7A
Electrode gap, mm	0,5	0,6	0,6	0,6
Fuel and lubrication system				
Manufacturer/type of carburettor	Walbro, membran	Walbro, membran	Walbro, membran	Walbro, membran
Fuel tank capacity, litre	0,5	1,6	2,1	2,2
Weight				
Weight without fuel, cutting attachment and guard, kg	5,0	9,9	10,2	12,3
Noise emissions				
(see note 1)				
Sound power level, measured dB(A)	101,3	103,5	106,7	104,6
Sound power level, guaranteed L _{WA} dB(A)	102	104	107	112
Noise levels				
(see note 2)				
Equivalent noise pressure level at the operator's ear, measured according to EN/ISO 11806 and ISO 7917, dB(A), min./max.:	92	89	92	97
Vibration levels				
Vibration levels at handles, measured according to EN/ISO 11806 and ISO 7916, m/s ²				
At idle, left/right handles:	-/1,2	1,2/1,2	1,2/1,0	1,2/1,2
At max. speed, left/right handles:	-/1,2	1,2/1,2	1,2/1,7	1,2/1,2

Note 1: Noise emissions in the environment measured as sound power (L_{WA}) in conformity with EC directive 2000/14/EC.

Note 2: Equivalent sound pressure level is calculated as the time-weighted energy total for sound pressure levels under various working conditions with the following time distribution: 1/2 idling and 1/2 max speed.

NOTE! The noise pressure level at operator's ear and vibrations on the handles are measured with all the approved cutting attachments for the machine. The table indicates the lowest and highest values.

TECHNICAL DATA

EC-declaration of conformity

(Applies to Europe only)

We, Husqvarna AB, S-561 82 Huskvarna, Sweden, tel: +46 36-146500, declare under sole responsibility that the blowers Husqvarna141B and 155 from 2000's serial numbers and onwards (the year is clearly stated in plain text on the type plate with subsequent serial number), are in conformity with the following standards or other normative documents following the provisions in the COUNCIL'S DIRECTIVES:

of June 22, 1998 "relating to machinery" **98/37/EC**, annex IIA.

of May 3, 1989 "relating to electromagnetic compatibility" **89/336/EEC**, and applicable supplements.

of May 8, 2000 "relating to the noise emissions in the environment" **2000/14/EC**.

For information relating to noise emissions, see the chapter Technical data. The following standards have been applied: **EN292-2, CISPR 12:1997, EN ISO 11806**.

SMP Svensk Maskinprovning AB, Fyrisborgsgatan 3, SE-754 50 Uppsala, Sweden, has performed voluntary type examination on behalf of Husqvarna AB. The certificates are numbered: SEC/00/759 - 141B, SEC/00/760 - 155B

Huskvarna January 3, 2002



Bo Andréasson, Development manager

TECHNICAL DATA

EC-declaration of conformity

(Applies to Europe only)

We, Husqvarna AB, S-561 82 Huskvarna, Sweden, tel: +46 36-146500, declare under sole responsibility that the blowers Husqvarna 125BT and 165BT from 2004's serial numbers and onwards (the year is clearly stated in plain text on the type plate with subsequent serial number), are in conformity with the following standards or other normative documents following the provisions in the COUNCIL'S DIRECTIVES:

of June 22, 1998 "relating to machinery" **98/37/EC**.

of May 3, 1989 "relating to electromagnetic compatibility" **89/336/EEC**, and applicable supplements.

of May 8, 2000 "relating to the noise emissions in the environment" **2000/14/EC**.

For information relating to noise emissions, see the chapter Technical data. The following standards have been applied: **EN292-2, CISPR 12:1997, EN ISO 11806**.

Huskvarna January 5, 2004



Bo Andréasson, Development manager



www.husqvarna.com

1140211-26

Free Manuals Download Website

<http://myh66.com>

<http://usermanuals.us>

<http://www.somanuals.com>

<http://www.4manuals.cc>

<http://www.manual-lib.com>

<http://www.404manual.com>

<http://www.luxmanual.com>

<http://aubethermostatmanual.com>

Golf course search by state

<http://golfingnear.com>

Email search by domain

<http://emailbydomain.com>

Auto manuals search

<http://auto.somanuals.com>

TV manuals search

<http://tv.somanuals.com>