

Operator's manual
356BT X-series



English

Please read the operator's manual carefully and make sure you understand the instructions before using the machine.

INTRODUCTION

Dear Customer,

Congratulations on your choice to buy a Husqvarna product! Husqvarna is based on a tradition that dates back to 1689, when the Swedish King Karl XI ordered the construction of a factory on the banks of the Husqvarna River, for production of muskets. The location was logical, since water power was harnessed from the Huskvarna River to create the water-powered plant. During the more than 300 years of being, the Husqvarna factory has produced a lot of different products, from wood stoves to modern kitchen appliances, sewing machines, bicycles, motorcycles etc. In 1956, the first motor driven lawn mowers appeared, followed by chain saws in 1959, and it is within this area Husqvarna is working today.

Today Husqvarna is one of the leading manufacturers in the world of forest and garden products, with quality as our highest priority. The business concept is to develop, manufacture and market motor driven products for forestry and gardening as well as for building and construction industry. Husqvarna's aim is also to be in the front edge according to ergonomics, usability, security and environmental protection. That is the reason why we have developed many different features to provide our products within these areas.

We are convinced that you will appreciate with great satisfaction the quality and performance of our product for a very long time to come. The purchase of one of our products gives you access to professional help with repairs and service whenever this may be necessary. If the retailer who sells your machine is not one of our authorised dealers, ask for the address of your nearest service workshop.

It is our wish that you will be satisfied with your product and that it will be your companion for a long time. Think of this operator's manual as a valuable document. By following its' content (using, service, maintenance etc) the life span and the second-hand value of the machine can be extended. If you will sell this machine, make sure that the buyer will get the operator's manual.

Thank you for using a Husqvarna product.

Husqvarna AB has a policy of continuous product development and therefore reserves the right to modify the design and appearance of products without prior notice.

KEY TO SYMBOLS

Symbols

WARNING! The machine can be a dangerous tool if used incorrectly or carelessly, which can cause serious or fatal injury to the operator or others.



Please read the operator's manual carefully and make sure you understand the instructions before using the machine.



Always wear:

- Hearing protection
- Approved eye protection



This product is in accordance with applicable EC directives.



Gloves should be worn when necessary.



The blower can forcibly throw objects that can bounce back. This can result in serious eye injuries if the recommended safety equipment is not used.



The blower operator must ensure that no people or animals come closer than 15 metres.



When several operators are working at the same site a safety distance of at least 15 metres must be in effect.

A breathing mask should be used when there is a risk of dust.



Noise emission to the environment according to the European Community's Directive. The machine's emission is specified in chapter Technical data and on label.



Other symbols/decals on the machine refer to special certification requirements for certain markets.

Switch off the engine by moving the stop switch to the STOP position before carrying out any checks or maintenance.

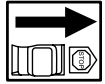

Always wear protective gloves.



Regular cleaning is required.

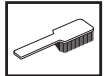

Visual check.



Protective goggles or a visor must be worn.



CONTENTS

Contents

INTRODUCTION	
Dear Customer,	2
KEY TO SYMBOLS	
Symbols	3
CONTENTS	
Contents	4
Note the following before starting:	4
SAFETY INSTRUCTIONS	
Personal protective equipment	5
Machine's safety equipment	5
Checking, maintaining and servicing the machine's safety equipment	6
General safety precautions	7
General working instructions	9
WHAT IS WHAT?	
What is what on the blower?	11
ASSEMBLY	
Assembling the blow pipe and control handle	12
FUEL HANDLING	
Fuel	14
Fuelling	15
STARTING AND STOPPING	
Starting and stopping	16
MAINTENANCE	
Carburettor	17
Muffler	17
Cooling system	18
Spark plug	18
Air filter	18
Maintenance schedule	20
TECHNICAL DATA	
Technical data	21
EC-declaration of conformity	22

Note the following before starting:

Please read the operator's manual carefully.



WARNING! Long-term exposure to noise can result in permanent hearing impairment. So always use approved hearing protection.



WARNING! Under no circumstances may the design of the machine be modified without the permission of the manufacturer. Always use genuine accessories. Non-authorized modifications and/or accessories can result in serious personal injury or the death of the operator or others.



WARNING! A blower is a dangerous tool if used carelessly or incorrectly and can cause serious, even fatal injuries. It is extremely important that you read and understand the contents of this Operator's manual.

Husqvarna AB has a policy of continuous product development and therefore reserves the right to modify the design and appearance of products without prior notice.

The machine is only designed for blowing lawns, pathways, asphalt roads and the like.

SAFETY INSTRUCTIONS

Personal protective equipment



WARNING! You must use approved personal protective equipment whenever you use the machine. Personal protective equipment cannot eliminate the risk of injury but it will reduce the degree of injury if an accident does happen. Ask your dealer for help in choosing the right equipment. Please read the operator's manual carefully and make sure you understand the instructions before using the machine.



WARNING! Listen out for warning signals or shouts when you are wearing hearing protection. Always remove your hearing protection as soon as the engine stops.

- Gloves should be worn when necessary.



- Wear hearing protection that provides adequate noise reduction.

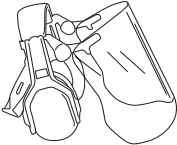

- Always wear approved eye protection. If you use a visor then you must also wear approved protective goggles. Approved protective goggles must comply with standard ANSI Z87.1 in the USA or EN 166 in EU countries. Blows from branches or objects that are thrown can damage the eyes.

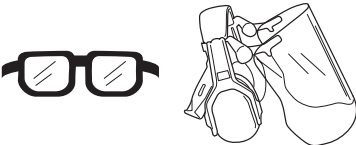

- Wear sturdy, non-slip boots.



- Wear clothes made of a strong fabric and avoid loose clothing that can catch on twigs and branches. Always wear heavy, long pants. Do not wear jewellery, shorts sandals or go barefoot. Secure hair so it is above shoulder level.
- A breathing mask should be used when there is a risk of dust.

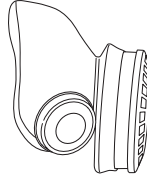

- Always have a first aid kit nearby.

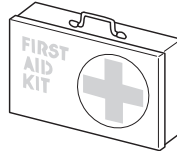

Machine's safety equipment

This section describes the machine's safety equipment, its purpose, and how checks and maintenance should be carried out to ensure that it operates correctly. See the "What is what?" section to locate where this equipment is positioned on your machine.



WARNING! Never use a machine that has faulty safety equipment! Carry out the inspection, maintenance and service routines listed in this section.

Stop switch

Use the stop switch to switch off the engine.

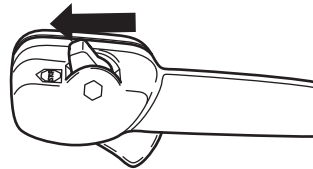

SAFETY INSTRUCTIONS

Vibration damping system

Your machine is equipped with a vibration damping system that is designed to minimize vibration and make operation easier.

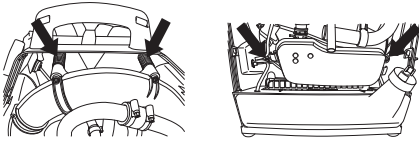

WARNING! Overexposure to vibration can lead to circulatory damage or nerve damage in people who have impaired circulation. Contact your doctor if you experience symptoms of overexposure to vibration. Such symptoms include numbness, loss of feeling, tingling, pricking, pain, loss of strength, changes in skin colour or condition. These symptoms normally appear in the fingers, hands or wrists. The risk increases at low temperatures.

Muffler

The muffler is designed to keep noise levels to a minimum and to direct exhaust fumes away from the user.

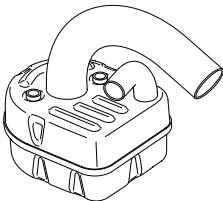

In countries that have a warm and dry climate there is a significant risk of fire. Consequently, we have equipped the muffler with a spark arrestor mesh mounted inside the muffler.

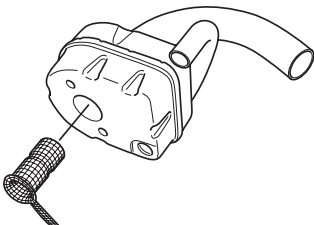

For mufflers it is very important that you follow the instructions on checking, maintaining and servicing your machine. See instructions under the heading Checking,

maintaining and servicing the machine's safety equipment.



WARNING!

Bear in mind that: Engine exhaust fumes contain carbon monoxide, which can cause carbon monoxide poisoning. For this reason you should not start or run the machine indoors, or anywhere that is poorly ventilated.

The exhaust fumes from the engine are hot and may contain sparks which can start a fire. Never start the machine indoors or near combustible material!



WARNING! The inside of the muffler contain chemicals that may be carcinogenic. Avoid contact with these elements in the event of a damaged muffler.

Checking, maintaining and servicing the machine's safety equipment



WARNING! All servicing and repair work on the machine requires special training. This is especially true of the machine's safety equipment. If your machine fails any of the checks described below you must contact your service agent. When you buy any of our products we guarantee the availability of professional repairs and service. If the retailer who sells your machine is not a servicing dealer, ask him for the address of your nearest service agent.

Stop switch

- Start the engine and make sure the engine stops when you move the stop switch to the stop setting.

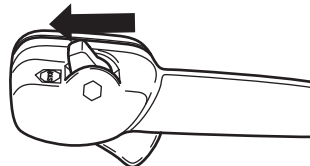

SAFETY INSTRUCTIONS

Vibration damping system

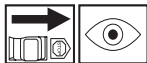

- Check the vibration damping units regularly for cracks or deformation. Replace them if damaged.

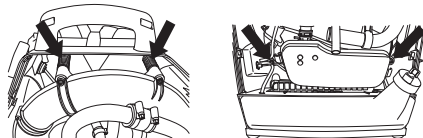

- Check that the vibration damping element is undamaged and securely attached.

Muffler



- Never use a machine that has a faulty muffler.

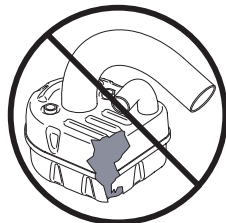

- Regularly check that the muffler is securely attached to the machine.

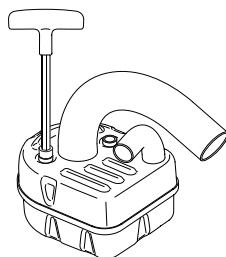

- The muffler on your machine is equipped with a spark arrestor mesh; this must be cleaned regularly. See the heading Muffler in the Maintenance chapter. A

blocked mesh will cause the engine to overheat and may lead to serious damage.

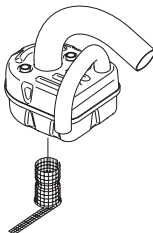

- Never use a muffler with a defective spark arrestor mesh.



WARNING! Never use a machine with faulty safety equipment. The machine's safety equipment must be checked and maintained as described in this section. If your machine fails any of these checks contact your service agent to get it repaired.

General safety precautions

General

- Never use the machine if you are tired, if you have drunk alcohol, or if you are taking medication that could affect your vision, your judgement or your coordination.
- Wear personal protective equipment. See instructions under the heading "Personal protective equipment".
- Never use a machine that has been modified in any way from its original specification.
- Never use a machine that is faulty. Carry out the checks, maintenance and service instructions described in this manual. Some maintenance and service measures must be carried out by trained and qualified specialists. See instructions under the heading Maintenance.
- All covers and guards must be fitted before starting. Ensure that the spark plug cap and ignition lead are undamaged to avoid the risk of electric shock.
- The blower operator must ensure that no people or animals come closer than 15 metres. When several operators are working at the same site a safety distance of at least 15 metres must be in effect.



WARNING! This machine produces an electromagnetic field during operation. This field may under some circumstances interfere with active or passive medical implants. To reduce the risk of serious or fatal injury, we recommend persons with medical implants to consult their physician and the medical implant manufacturer before operating this machine.

SAFETY INSTRUCTIONS

Starting

- Never start the machine indoors. Exhaust fumes can be dangerous if inhaled.
- Observe the surroundings and ensure that no people or animals can come into contact with the blower.
- Place the machine on the ground, press the machine body against the ground with your left hand (NOTE! Not your foot). Now grasp the starter handle with your right hand and then pull quickly and firmly.



Fuel safety



- Always use a fuel container with an anti-spill valve.
- Never refuel the machine while the engine is running. Always stop the engine and let it cool for a few minutes before refuelling.
- Make sure there is plenty of ventilation when refuelling or mixing fuel (petrol and 2-stroke oil).
- Avoid all skin contact with fuel. Fuel is a skin irritant and may even cause skin changes.
- Move the machine at least 3 m from the refuelling point before starting it.

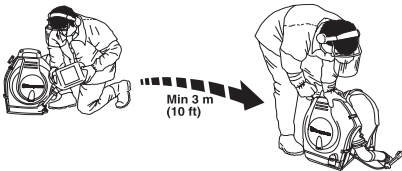

- Never start the machine:
 - If you have spilt fuel on it. Wipe off the spillage and allow remaining fuel to evaporate.
 - If you have spilt fuel on yourself or your clothes, change your clothes. Wash any part of your body that has come in contact with fuel. Use soap and water.
 - If the machine is leaking fuel. Check regularly for leaks from the fuel cap and fuel lines.

Transport and storage

- Store and transport the machine and fuel so that there is no risk of any leakage or fumes coming into contact

with sparks or naked flames, for example, from electrical machinery, electric motors, electrical relays/ switches or boilers.

- When storing and transporting fuel always use approved containers intended for this purpose.
- When storing the machine for long periods the fuel tank must be emptied. Contact your local petrol station to find out where to dispose of excess fuel.
- Ensure the machine is cleaned and that a complete service is carried out before long-term storage.
- Secure the machine during transport.



WARNING! Take care when handling fuel. Bear in mind the risk of fire, explosion and inhaling fumes.

Adjusting the harness



WARNING! The harness must always be worn when working with the machine. Failure to do so means you will be unable to manoeuvre safely and this can result in injury to yourself or others.

A correctly adjusted harness and machine significantly facilitates the work. Adjust the harness to give the best working position.



Tighten the side straps so that the pressure is evenly distributed across the shoulders.

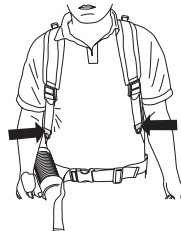

SAFETY INSTRUCTIONS

Place the hip strap over the hip and not too far down on the stomach. Tighten the hip strap so that you feel the weight of the blower resting on your hip.



General working instructions

IMPORTANT! This section considers basic safety rules when working with blowers. If you encounter a situation where you are uncertain how to proceed you should ask an expert. Contact your dealer or your service workshop. Avoid all usage which you consider to be beyond your capability.

Show consideration to persons in your surroundings by avoiding using the machine at unsuitable times, such as late in the evening or early in the morning. Read through and follow the simple directions so that you disturb your surroundings as little as possible.

- Use the blower with the lowest possible throttle. It is seldom necessary to use full throttle, and many work procedures can be done at half throttle. A lower throttle means less noise and less dust, and it is also easier to keep control over the rubbish collected together/moved.
- Use a rake or a brush to release rubbish stuck to the ground.
- Hold the opening of the blower as close to the ground as possible.
- Observe your surroundings. Direct the blower away from people, animals, play areas, and cars etc.
- Clean up afterwards. Make sure that you have not blown rubbish into someone's garden.

Basic safety rules



- No unauthorised persons or animals may be present in the working area, which is 15 metres.

- The powerful currents of air can move objects at such a speed that they can bounce back and cause serious eye injuries.

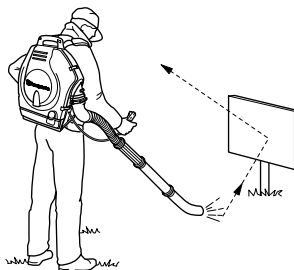

- Do not direct the air jet towards people or animals.
- Stop the engine before assembling or dismantling accessories or other parts.
- Do not use the machine in bad weather, such as dense fog, heavy rain, strong wind, intense cold, etc. Working in bad weather is tiring and can lead to dangerous conditions, e.g. slippery surfaces.
- Make sure you can move and stand safely. Check the area around you for possible obstacles (roots, rocks, branches, ditches, etc.) in case you have to move suddenly. Take great care when working on sloping ground.



- Never put the machine down with the engine running unless you have it in clear sight.
- Engine exhaust fumes contain carbon monoxide, which can cause carbon monoxide poisoning. For this reason you should not start or run the machine indoors, or anywhere that is poorly ventilated.
- The blower must not be used while on a ladder or scaffolding.

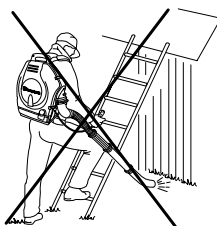

- **CAUTION!** Do not use the machine unless you are able to call for help in the event of an accident.

SAFETY INSTRUCTIONS

Basic working techniques



WARNING! Watch out for thrown objects. Always wear eye protection. Stones, rubbish, etc. can be thrown up into the eyes causing blindness or serious injury. Keep unauthorised persons at a distance. Children, animals, onlookers and helpers should be kept outside the safety zone of 15 m. Stop the machine immediately if anyone approaches.



WARNING! Always stop the engine before cleaning.

- The speed of the air jet is regulated by means of the throttle. Select the speed best suited for respective tasks. You can set the throttle position using the "stop switch" and by doing so not need to hold your finger on the throttle all the time you are using the blower. Full throttle is obtained when the control is held back fully.

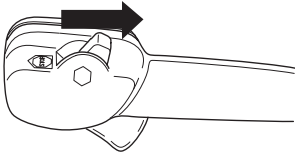

- Check that the air intake is not blocked, for example, by leaves or rubbish. A clogged air intake reduces the machine's blowing capacity and increases the engine's working temperature, which can result in engine failure. Stop the engine and remove the object.

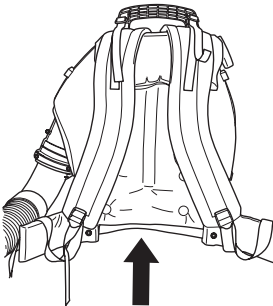

- Be aware of the wind direction. Work with the wind to make your work easier.
- Using the blower to move large piles is time consuming and creates unnecessary noise.
- When work is finished the machine should be stored vertically.

WHAT IS WHAT?

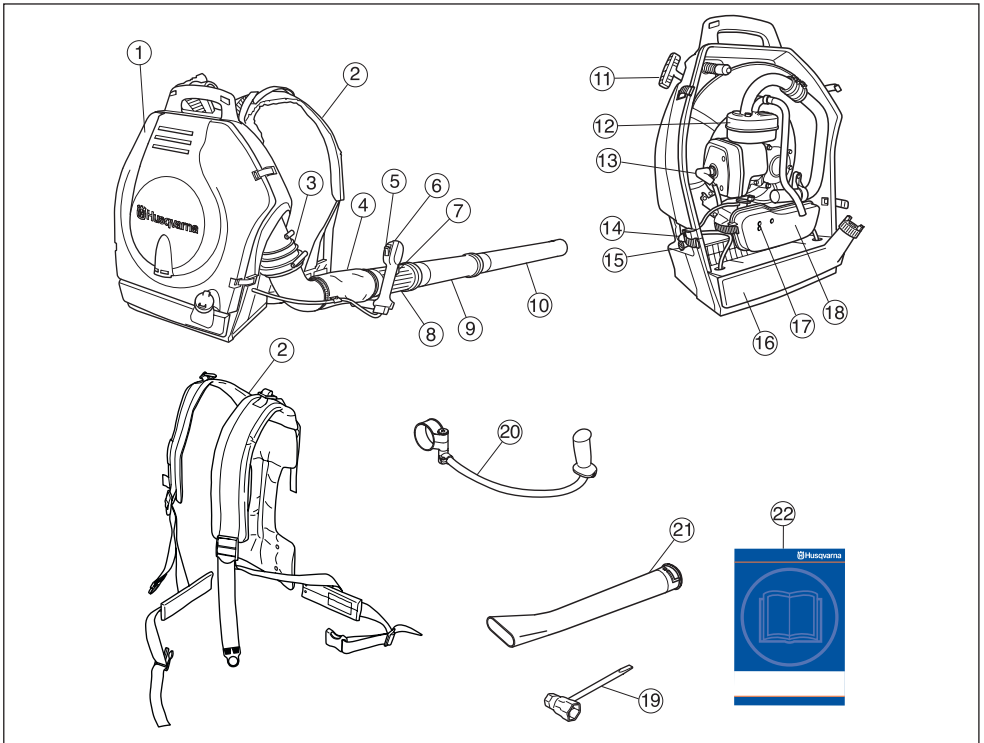

What is what on the blower?

- | | |
|----------------------------------------------|--------------------------------|
| 1 Outer cover | 12 Muffler |
| 2 Harness | 13 Spark plug |
| 3 Outlet pipe | 14 Air purge |
| 4 Bellows with guard | 15 Choke control |
| 5 Stop switch with throttle position setting | 16 Fuel tank |
| 6 Control handle/Operating handle | 17 Adjuster screws carburettor |
| 7 Throttle control | 18 Air filter |
| 8 Control pipe | 19 Combination spanner |
| 9 Intermediate pipe | 20 Handlebar (Accessory) |
| 10 Blow pipe | 21 Flat nozzle (Accessory) |
| 11 Starter handle | 22 Operator's manual |

ASSEMBLY

Assembling the blow pipe and control handle

- Loosen the two screws on the fan's outlet pipe and remove the two wear ring halves located on the outlet pipe.

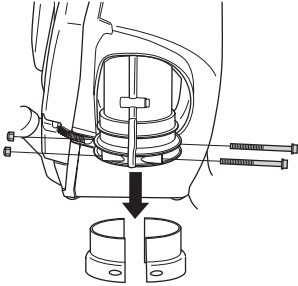

- Place these on the pipe bend so that the guide on the wear ring halves aligns with the slot on the pipe bend.

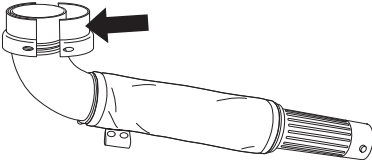

- Refit the pipe bend with the wear halves in the fan's outlet pipe. Make sure the holes in the wear ring halves align with the screws that are used to secure the halves in the pipe bend.

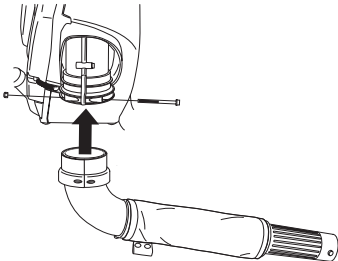

- Also pay attention to the stops located on the pipe bend and the fan's outlet pipe. Ensure that the stop on the pipe bend comes in front of the stop on the outlet pipe.

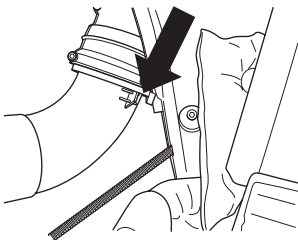

- Refit the bolts and tighten well. Check that the control pipe is in the right position and can rotate equally in both directions.

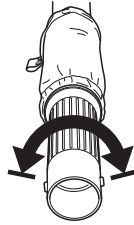

- Disassemble the knob from the control handle and push the holder on to the control pipe.

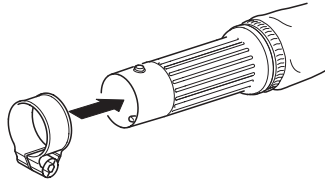

- Assemble the knob and adjust position and angle to achieve comfortable working position, tighten the knob. Attach the cabling in the cover.

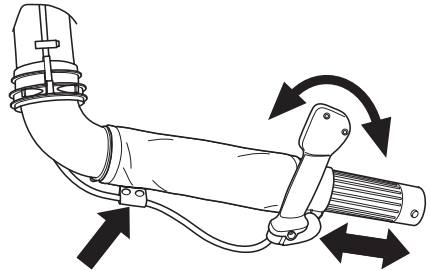

Connect the intermediate pipe and air nozzle. Push the pipes together and turn them so they lock in relation to one another.

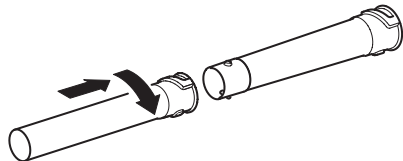

ASSEMBLY

Accessories

Handlebar

Disassemble the intermediate pipe. Disassemble the knob from the holder and push the holder on to the holder pipe. Assemble the knob and tighten.

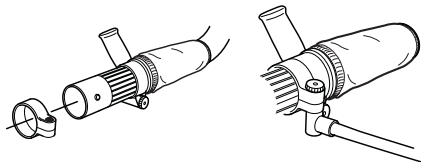

Assemble the intermediate pipe.

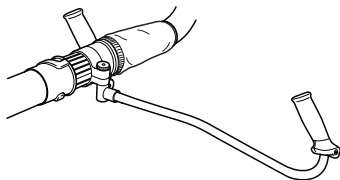

Flat nozzle

- If higher air speed is required, the round blow pipe is replaced by the flat nozzle.

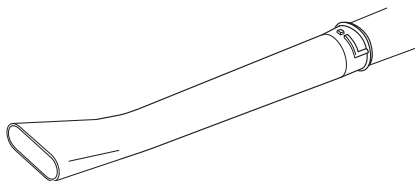

FUEL HANDLING

Fuel

CAUTION! The machine is equipped with a two-stroke engine and must always be run using a mixture of petrol and two-stroke oil. It is important to accurately measure the amount of oil to be mixed to ensure that the correct mixture is obtained. When mixing small amounts of fuel, even small inaccuracies can drastically affect the ratio of the mixture.



WARNING! Always ensure there is adequate ventilation when handling fuel.

Petrol



CAUTION! Always use a good quality petrol/oil mixture (at least 90 octane).



- The lowest recommended octane rating is 90. If you run the engine on a petrol with a lower octane rating than 90 this can cause knocking. This leads to an increased engine temperature, which can result in serious engine damage.
- When working at continuous high revs a higher octane rating is recommended.

Two-stroke oil

- For best results and performance use HUSQVARNA two-stroke oil, which is specially formulated for our two-stroke engines. Mixture 1:50 (2%).
- If HUSQVARNA two-stroke oil is not available, you may use another two-stroke oil of good quality that is intended for air cooled engines. Contact your dealer when selecting an oil. Mixing ratio 1:33 (3%).
- Never use two-stroke oil intended for water-cooled outboard engines, sometimes referred to as outboard oil.
- Never use oil intended for four-stroke engines.

Petrol, litre	Two-stroke oil, litre	
	2% (1:50)	3% (1:33)
5	0,10	0,15
10	0,20	0,30
15	0,30	0,45
20	0,40	0,60

Mixing

- Always mix the petrol and oil in a clean container intended for fuel.
- Always start by filling half the amount of the petrol to be used. Then add the entire amount of oil. Mix (shake) the fuel mixture. Add the remaining amount of petrol.
- Mix (shake) the fuel mixture thoroughly before filling the machine's fuel tank.



- Do not mix more than one month's supply of fuel at a time.
- If the machine is not used for some time the fuel tank should be emptied and cleaned.

Fuelling



WARNING! Taking the following precautions, will lessen the risk of fire:

Do not smoke or place hot objects near fuel.

Always shut off the engine before refuelling.

Always stop the engine and let it cool for a few minutes before refuelling.

When refuelling, open the fuel cap slowly so that any excess pressure is released gently.

Tighten the fuel cap carefully after refuelling.

Always move the machine away from the refuelling area before starting.

- Move the machine at least 3 m from the refuelling point before starting it.

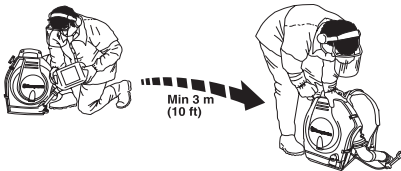

- Clean the area around the fuel cap. Contamination in the tank can cause operating problems.
- Ensure that the fuel is well mixed by shaking the container before filling the tank.

STARTING AND STOPPING

Starting and stopping



WARNING! Always move the machine away from the refuelling area before starting. Place the machine on a flat surface.

Make sure no unauthorised persons are in the working area, otherwise there is a risk of serious personal injury. The safety distance is 15 metres.

The machine may only be started in its complete design. If the machine is started without all the guards fitted there is a risk of personal injuries.

Cold engine

Ignition: Set the stop switch to the start position.

Start position is achieved by moving the stop switch slightly backwards until the stop switch clicks into start position.

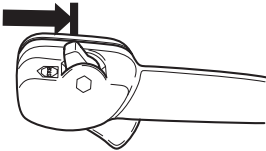

It is not allowed to set the stop switch in full throttle position.

Choke: Set the choke control in the choke position.

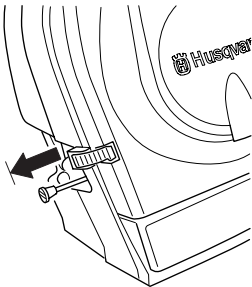

Primer bulb: Press the air purge repeatedly until fuel begins to fill the bulb. The bulb need not be completely filled.

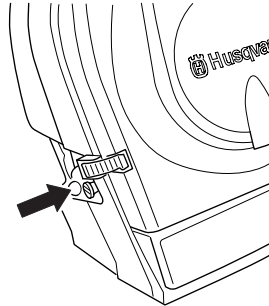

Warm engine

Use the same starting procedure as for a cold engine but without setting the choke control in the choke position.

Starting

Hold the body of the machine on the ground using your left hand (CAUTION! Not with your foot!). Grip the starter handle, slowly pull out the cord with your right hand until you feel some resistance (the starter pawls grip), now quickly and powerfully pull the cord.

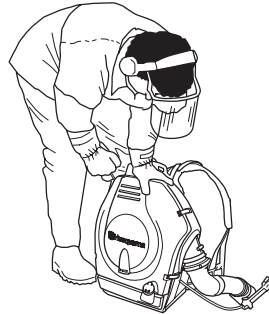

Never twist the starter cord around your hand.

Repeat pulling the cord until the engine starts. When the engine starts, return choke control to run position.

CAUTION! Do not pull the starter cord all the way out and do not let go of the starter handle when the cord is fully extended. This can damage the machine.

Stopping

The engine is stopped by moving the stop switch to the stop position.

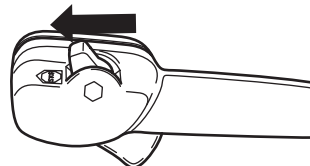

MAINTENANCE

Carburettor

Your Husqvarna product has been designed and manufactured to specifications that reduce harmful emissions. After the engine has used 8-10 tanks of fuel the engine will be run-in. To ensure that it continues to run at peak performance and to minimise harmful exhaust emissions after the running-in period, ask your dealer/ service workshop (who will have a rev counter at their disposal) to adjust your carburettor.

Function



The carburettor governs the engine's speed via the throttle control. Air and fuel are mixed in the carburettor. The air/fuel mixture is adjustable. Correct adjustment is essential to get the best performance from the machine.

Adjusting the carburettor means that the engine is adapted to local operating conditions, e.g. climate, altitude, petrol and the type of 2-stroke oil.

The carburettor has three adjustment controls:

- L = Low speed jet
- H = High speed jet
- T = Idle adjustment screw

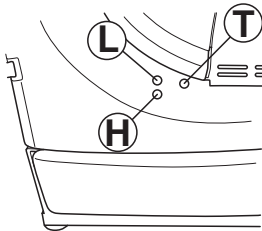

The L and H-jets are used to adjust the supply of fuel to match the rate that air is admitted, which is controlled with the throttle. If they are screwed clockwise the air/fuel ratio becomes leaner (less fuel) and if they are turned anti-clockwise the ratio becomes richer (more fuel). A lean mixture gives a higher engine speed and a rich mixture gives a lower engine speed.

The T-screw regulates the throttle setting at idle speed. If the T-screw is turned clockwise this gives a higher idle speed; turning it anti-clockwise gives a lower idle speed.

Basic setting

The basic carburettor settings are adjusted during testing at the factory. The basic setting is richer than the optimal setting and should be maintained for the first few hours the machine is in use. The carburettor should then be finely adjusted. Fine adjustment should be carried out by a skilled technician.

Adjustment of the idle speed

Before any adjustments are made, make sure that the air filter is clean and the air filter cover is fitted.

Adjust the idle speed screw T clockwise respectively anti-clockwise until an idle speed of 2300 rpm is reached.

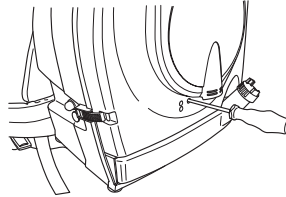

Muffler

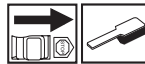

The muffler is designed to reduce the noise level and to direct the exhaust gases away from the operator. The exhaust gases are hot and can contain sparks, which may cause fire if directed against dry and combustible material.

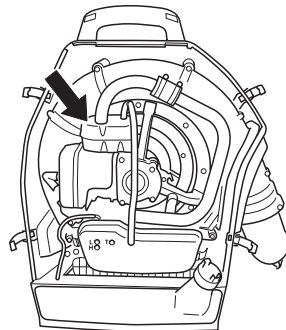

The muffler is equipped with a special spark arrestor mesh. The spark arrestor mesh should be cleaned once a month. This is best done with a wire brush.

To remove the spark arrestor mesh proceed as follows:

Remove the screws to the capillary tube and exhaust pipe.

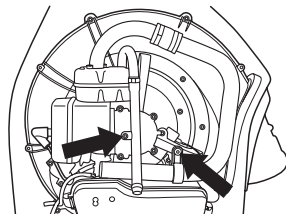

MAINTENANCE

Loosen the muffler's 2 screws and remove the muffler.

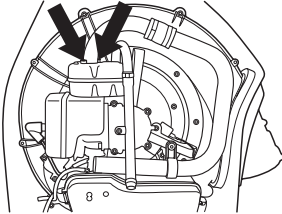

Pull out the spark arrestor mesh and clean using a wire brush. Replace the spark arrestor mesh if it is defective.

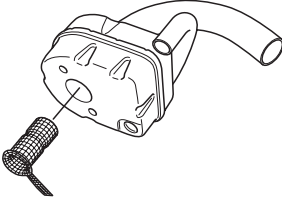

CAUTION! Never use a machine with a defective muffler.



WARNING! The muffler gets very hot during use and remain so for some time after stopping. This also applies at idle speed. Contact can result in burns to the skin. Remember the risk of fire!

Cooling system

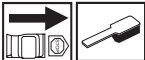

To keep the working temperature as low as possible the machine is equipped with a cooling system.

The cooling system consists of:

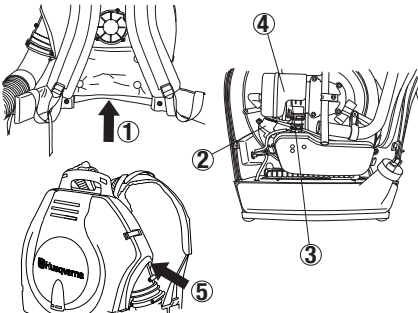

- 1 Air intake on the underside of the blower.
- 2 Nozzle for cooling the cylinder
- 3 Cooling fins on the cylinder.
- 4 Cooling air conductor (directs cold air over the cylinder).
- 5 Air intake on the underside of the blower.

5 Emergency cooling nozzle

Clean the cooling system with a brush once a week, more often in demanding conditions. A dirty or blocked cooling system results in the machine overheating which causes damage to the piston and cylinder. Check that the nozzles are not blocked.

Spark plug



The spark plug condition is influenced by:

- Incorrect carburettor adjustment.
- An incorrect fuel mixture (too much or incorrect type of oil).
- A dirty air filter.

These factors cause deposits on the spark plug electrodes, which may result in operating problems and starting difficulties.

If the machine is low on power, difficult to start or runs poorly at idle speed: always check the spark plug first before taking any further action. If the spark plug is dirty, clean it and check that the electrode gap is 0.5 mm. The spark plug should be replaced after about a month in operation or earlier if necessary.

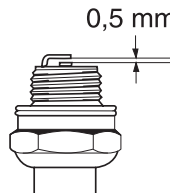

CAUTION! Always use the recommended spark plug type! Use of the wrong spark plug can damage the piston/cylinder.

Air filter



The air filter must be regularly cleaned to remove dust and dirt in order to avoid:

- Carburettor malfunctions
- Starting problems
- Loss of engine power
- Unnecessary wear to engine parts.
- Excessive fuel consumption.

MAINTENANCE

Clean the filter every 40 hours, or more regularly if conditions are exceptionally dusty.

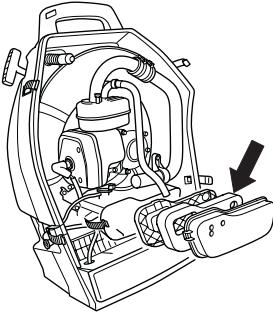

Avoid contact with hot surfaces on muffler, cylinder etc. Contact can result in burns to the skin.

Cleaning the air filter

Dismantle the outer cover with the help of the four fasteners holding the outer cover.

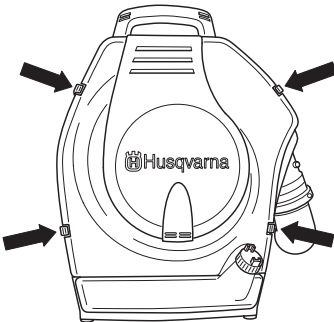

Loosen the two fasteners holding the air filter cowling and remove the filter. Wash the filter clean in warm, soapy water.

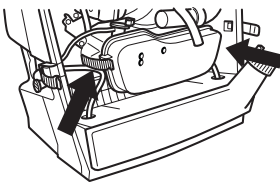

The air filter is fitted in the air filter cowling.

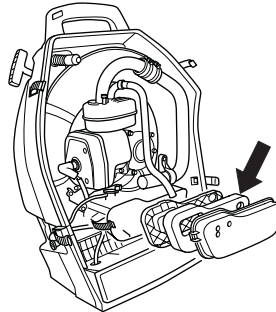

Ensure that the filter is soaked in oil before refitting it.

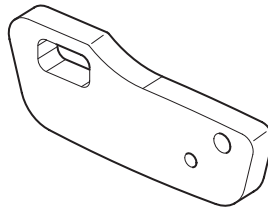

An air filter that has been in use for a long time cannot be cleaned completely. The filter must therefore be replaced with a new one at regular intervals. **A damaged air filter must always be replaced.**

Oiling the air filter

Always use HUSQVARNA filter oil, art. no. 531 00 60-76. The filter oil contains a solvent to make it spread evenly through the filter. You should therefore avoid skin contact.

Put the filter in a plastic bag and pour the filter oil over it. Knead the plastic bag to distribute the oil. Squeeze the excess oil out of the filter inside the plastic bag and pour off the excess before fitting the filter to the machine. Never use common engine oil. This would drain through the filter quite quickly and collect in the bottom.

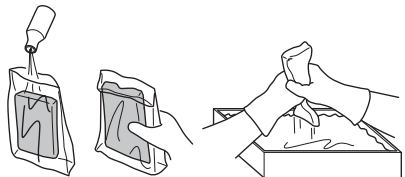

MAINTENANCE

Maintenance schedule

Below you will find some general maintenance instructions. If you need further information please contact your service workshop.

Daily maintenance

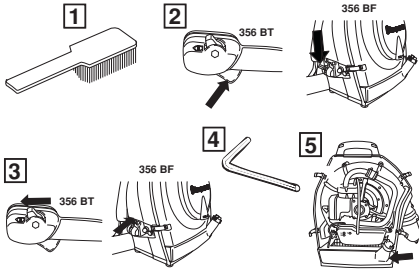

- 1 Clean the outside of the machine.
- 2 Check that the throttle control functions safely.
- 3 Check that the stop switch works correctly.
- 4 Check that nuts and screws are tight.
- 5 Check that there are no fuel leaks.

Weekly maintenance

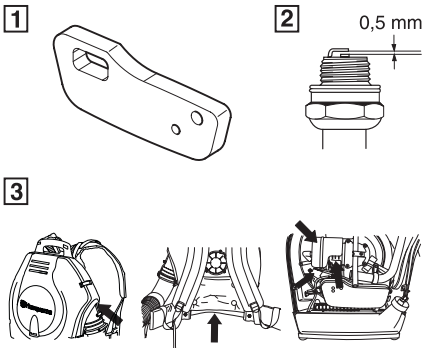

- 1 Clean the air filter. Replace if necessary.
- 2 Clean the outside of the spark plug. Remove and check the electrode gap. Adjust the gap to 0.5 mm or change the spark plug.
- 3 Clean the cooling system.

Monthly maintenance

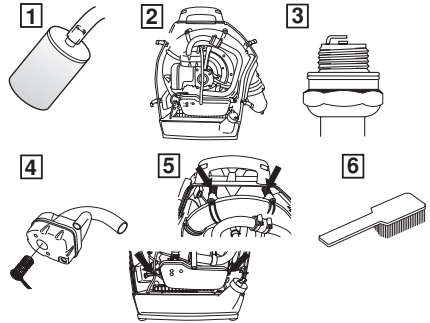

- 1 Check the fuel filter and the fuel hose. Replace if necessary.
- 2 Check all cables and connections.
- 3 Replace the spark plug. Check that the spark plug is fitted with a suppressor.
- 4 Check and clean the spark arrester mesh on the muffler.
- 5 Check that the vibration damping elements are not damaged.
- 6 Clean the fuel tank.

TECHNICAL DATA

Technical data

Technical data	356BT_x
Engine	
Cylinder displacement, cm ³	51,7
Cylinder bore, mm	44
Stroke, mm	34
Idle speed, rpm	2300
Max. engine output, acc. to ISO 8893, kW/ rpm	2,4/6000
Catalytic converter muffler	No
Speed-regulated ignition system	Yes
Ignition system	
Spark plug	NGK BPMR 7A
Electrode gap, mm	0,5
Fuel and lubrication system	
Fuel tank capacity, litre	1,5
Weight	
Weight without fuel, kg	10,4
Noise emissions	
(see note 1)	
Sound power level, measured dB(A)	99
Sound power level, guaranteed L _{WA} dB(A)	100
Noise levels	
(see note 2)	
Equivalent sound pressure level at the operator's ear, measured according to EN15503 dB(A)	91
Vibration levels	
(see note 3)	
Equivalent vibration levels (a _{h_v,eq}) at handles, measured according to EN15503, m/s ²	3,9
Fan performance	
Max. air velocity with standard nozzle, m/s:	79
Air flow with standard nozzle, m ³ /min	13,3
Max air velocity with flat nozzle (Accessory), m/s:	90
Air flow with flat nozzle (accessory), m ³ /min:	13,0

Note 1: Noise emissions in the environment measured as sound power (L_{WA}) in conformity with EC directive 2000/14/EC. Reported sound power level for the machine has been measured with the original cutting attachment that gives the highest level. The difference between guaranteed and measured sound power is that the guaranteed sound power also includes dispersion in the measurement result and the variations between different machines of the same model according to Directive 2000/14/EC.

Note 2: The equivalent sound pressure level value is calculated with a work cycle of a duration of 1/7 for idling and 6/7 for racing. Reported data for equivalent sound pressure level for the machine has a typical statistical dispersion (standard deviation) of 1 dB(A).

Note 3: The equivalent vibration level value is calculated with a work cycle of a duration of 1/7 for idling and 6/7 for racing. Reported data for equivalent vibration level has a typical statistical dispersion (standard deviation) of 1 m/s².

TECHNICAL DATA

EC-declaration of conformity (Applies to Europe only)

Husqvarna AB, SE-561 82 Huskvarna, Sweden, tel +46-36-146500, declares under sole responsibility that the blowers **Husqvarna 356 BT X-series** with serial numbers dating 2009 and onwards (the year is clearly stated on the rating plate, followed by the serial number), comply with the requirements of the COUNCIL'S DIRECTIVE:

- of May 17, 2006 "relating to machinery" **2006/42/EC**
- of December 15, 2004 "relating to electromagnetic compatibility" **2004/108/EC**.
- of May 8, 2000 "relating to the noise emissions in the environment" **2000/14/EC**. Conformity assessment according to Annex V.

For information relating to noise emissions, see the chapter Technical data. The following standards have been applied: **EN ISO 12100-2/A1:2009, CISPR 12:2001, EN15503:2009**

SMP Svensk Maskinprovning AB, Fyrisborgsgatan 3, SE-754 50 Uppsala, Sweden, has performed voluntary type examination on behalf of Husqvarna AB. The certificates are numbered:

SEC/09/2203, 01/012/003

Huskvarna December 29, 2009



Bo Jonsson, Development manager (Authorized representative for Husqvarna AB and responsible for technical documentation.)

Original instructions

1153191-26



2010-05-18

Free Manuals Download Website

<http://myh66.com>

<http://usermanuals.us>

<http://www.somanuals.com>

<http://www.4manuals.cc>

<http://www.manual-lib.com>

<http://www.404manual.com>

<http://www.luxmanual.com>

<http://aubethermostatmanual.com>

Golf course search by state

<http://golfingnear.com>

Email search by domain

<http://emailbydomain.com>

Auto manuals search

<http://auto.somanuals.com>

TV manuals search

<http://tv.somanuals.com>