

PiranhaMAX 165, 175, 176i, 195c, & 196ci Installation and Operations Manual

532030-1_A



HUMMINBIRD®

PiranhaMAX

Download from www.Somanuals.com. All Manuals Search And Download.

Thank You!

Thank you for choosing Humminbird®, the #1 name in Fishfinders. Humminbird® has built its reputation by designing and manufacturing top-quality, thoroughly reliable marine equipment. Your Humminbird® accessory is designed for trouble-free use in even the harshest marine environment. In the unlikely event that your Humminbird® accessory does require repairs, we offer an exclusive Service Policy - free of charge during the first year after purchase, and available at a reasonable rate after the one-year period. For complete details, see the separate warranty card included with your accessory. We encourage you to read this operations manual carefully in order to get full benefit from all the features and applications of your Humminbird® product.

Contact our Customer Resource Center at **1-800-633-1468** or visit our Web site at **humminbird.com**.

The following models are covered in this manual:

- **PiranhaMAX 165** - Single Beam, 240 V x 160 H Monochrome Display
- **PiranhaMAX 175** - Dual Beam, 240 V x 160 H Monochrome Display
- **PiranhaMAX 176i** - Dual Beam, 240 V x 160 H Monochrome Display
- **PiranhaMAX 195c** - Dual Beam, 320 V x 240 H Transmissive Color Display
- **PiranhaMAX 196ci** - Dual Beam, 320 V x 240 H Transmissive Color Display

WARNING! *This device should not be used as a navigational aid to prevent collision, grounding, boat damage, or personal injury. When the boat is moving, water depth may change too quickly to allow time for you to react. Always operate the boat at very slow speeds if you suspect shallow water or submerged objects.*

WARNING! *Disassembly and repair of this electronic unit should only be performed by authorized service personnel. Any modification of the serial number or attempt to repair the original equipment or accessories by unauthorized individuals will void the warranty.*

WARNING! *Do not travel at high speed with the unit cover installed. Remove the unit cover before traveling at speeds above 20 mph.*

WARNING! *This product contains chemicals known to the State of California to cause cancer and/or reproductive harm.*

NOTE: Some features discussed in this manual require a separate purchase, and some features are only available on international models. Every effort has been made to clearly identify those features. Please read the manual carefully in order to understand the full capabilities of your model.

NOTE: The illustrations in this manual may not look the same as your product, but your unit will function in the same way.

NOTE: To purchase accessories for your control head, visit our web site at humminbird.com or contact our Customer Resource Center at **1-800-633-1468**.

NOTE: The procedures and features described in this manual are subject to change without notice. This manual was written in English and may have been translated to another language. Humminbird® is not responsible for incorrect translations or discrepancies between documents.

ROHS STATEMENT: Product designed and intended as a fixed installation or part of a system in a vessel may be considered beyond the scope of Directive 2002/95/EC of the European Parliament and of the Council of 27 January 2003 on the restriction of the use of certain hazardous substances in electrical and electronic equipment.

ATTENTION INTERNATIONAL CUSTOMERS: Products sold in the U.S. are not intended for use in the international market. Humminbird® international units provide international features and are designed to meet country and regional regulations. Languages, maps, time zones, units of measurement, and warranty are examples of features that are customized for Humminbird® international units purchased through our authorized international distributors.

To obtain a list of authorized international distributors, please visit our Web site at humminbird.com or contact our Customer Resource Center at **(334) 687-6613**.

Humminbird®, Fish ID+™, Structure ID®, and WhiteLine™ are trademarked by or registered trademarks of Johnson Outdoors Marine Electronics, Inc.

Baekmuk Batang, Baekmuk Dotum, Baekmuk Gulim, and Baekmuk Headline are registered trademarks owned by Kim Jeong-Hwan.

© 2012 Johnson Outdoors Marine Electronics, Inc. All rights reserved.

Table of Contents

Installation Overview	1
Fixed Control Head Installation	2
Determine Where to Mount	2
Connect the Power Cable to the Boat	2
Assemble the Control Head Base	4
Route the Control Head Cables Under the Deck	5
Attach the Control Head to the Base	6
Attach the Cables to the Control Head	7
Transom Transducer Installation Overview	8
Transom Transducer Installation	9
Locate the Transducer Mounting Position	9
Prepare the Mounting Location	10
Assemble and Mount the Transducer	12
Route the Cable	16
Test and Finish the Installation	18
PiranhaMAX Portable Case Assembly	20
Assemble the Control Head Base	21
Assemble the Base and Handle	22
Attach the Control Head to the Base and Handle	23
Route the Cables	24
Assemble the Portable Case	27
Charge and Install the Battery	27
Assemble the Transducer Mounting Bracket	28
Stow the Portable Transducer and Battery Charger into the Portable Case	29
Installing the Portable Case on the Boat	30
Connect the Transducer and Power Cables to the Portable Case	30
Attach the Portable Case to the Boat	31
Mounting the Portable Transducer	32
Test the Transducer Prior to Installation	32
Mount the Portable Transducer on the Boat	32

Table of Contents

Moving the Portable Fishfinder	34
Power ON and OFF	35
PiranhaMAX Sonar Technology	36
Single Beam Sonar	37
Dual Beam Sonar.	37
What You See on the Display	38
How GPS Works	39
The PiranhaMAX Control Head	40
Key Functions	41
POWER/MENU Key	41
UP and DOWN Arrow Keys	41
CHECK/ENTER Key.	42
How to Use the Menu System	43
Set Up the Control Head	45
Contrast (<i>PiranhaMAX 165, 175, and 176i models only</i>)	46
Fish ID+™ (<i>Sonar View only</i>).	46
Bottom View (<i>Sonar View only</i>).	46
Reset	48
Language (<i>International Models only</i>).	48
Units - Distance (<i>Units submenu</i>).	48
Units - Speed (<i>Units submenu</i>).	48
Units - Temp (<i>International Models only, Units submenu</i>).	48
Units - Depth (<i>International Models only, Units submenu</i>)	48
Views	49
Display a View	49
Status View	50
Sonar View	51

Table of Contents

Sonar Menu	52
View	53
Depth Range	53
Sensitivity	53
Zoom	54
Chart Speed	54
Filter	55
Light	55
Beam Select	55
Track View (<i>PiranhaMAX 176i and 196ci only</i>)	56
Track Menu (<i>PiranhaMAX 176i and 196ci only</i>)	57
View	58
Zoom	58
COG Vector	58
Clear Track	58
Delete	58
Delete All	59
Light	59
Alarms	60
Maintenance	62
Troubleshooting	64
PiranhaMAX 165 Specifications	66
PiranhaMAX 175/176i/195c/196ci Specifications	67
Contact Humminbird®	69

***NOTE:** Entries in this Table of Contents which list (*International Only*) are only available on products sold outside of the U.S. by our authorized International Distributors. It is important to note that products sold in the U.S. are not intended for resale in the international market. To obtain a list of authorized International Distributors, please visit our Web site at humminbird.com or contact our Customer Resource Center at 1-800-633-1468 to locate the distributor nearest you.*

Installation Overview

Before you start installation, we encourage you to read these instructions carefully in order to get the full benefit from your PiranhaMAX.

There are three basic installation tasks that you must perform for the PiranhaMAX:

- Installing the Control Head
- Installing the Transducer
- Testing the complete installation and locking the transducer position.

NOTE: In addition to the hardware supplied with your transducer, you will need a powered hand drill and various drill bits, various hand tools, including a ruler or straightedge, a level, a 12" plumb line (weighted string or monofilament line), marker or pencil, safety glasses and dust mask, and marine-grade silicone sealant.

NOTE: If you have purchased a PiranhaMAX Portable unit, proceed to **PiranhaMAX Portable Case Assembly** for installation instructions. If you are planning a fixed installation, proceed to **Fixed Control Head Installation**.

Fixed Control Head Installation

1. Determine Where to Mount

Begin the installation by determining where to mount the control head. Consider the following to determine the best location:

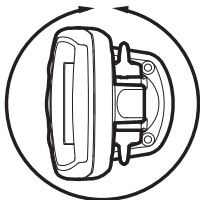

Figure 1

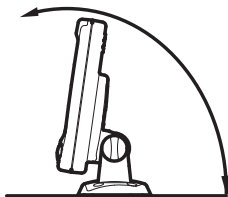

Figure 2

- To check the location planned for the control head, test run the cables for the power and transducer. See ***Transom Transducer Installation*** in order to plan the location of the transducer and cable route.
- The mounting surface should be stable enough to protect the control head from excessive wave shock and vibration, and should provide visibility while in operation.
- Your PiranhaMAX uses a tilt and swivel mounting base. The mounting area should allow sufficient room for the unit to pivot and swivel freely, and for easy removal and installation (Figures 1 and 2).

2. Connect the Power Cable to the Boat

A 6' long power cable is included to supply power to the control head. You may shorten or lengthen the cable using 18 gauge multi-stranded copper wire.

CAUTION! Some boats have 24 or 36 Volt electric systems, but the control head **MUST** be connected to a 12 VDC power supply.

The control head power cable can be connected to the electrical system of the boat at two places: a fuse panel usually located near the console, or directly to the battery.

NOTE: Make sure that the power cable is not connected to the control head at the beginning of this procedure.

NOTE: Humminbird® is not responsible for over-voltage or over-current failures. The control head must have adequate protection through the proper selection and installation of a 1 amp fuse.

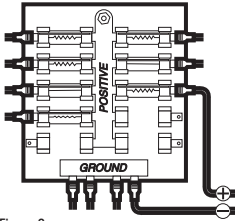

Figure 3

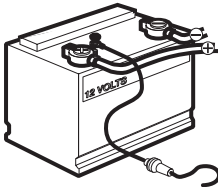

Figure 4

- 1a. If a fuse terminal is available, use crimp-on type electrical connectors (not included) that match the terminal on the fuse panel. Attach the black wire to ground (-), and the red wire to positive (+) 12 VDC power (Figure 3). Install a 1 amp fuse (not included) for protection of the unit. Humminbird® is not responsible for over-voltage or over-current failures.

or...

- 1b. If you need to wire the control head directly to a battery, obtain and install an inline fuse holder and a 1 amp fuse (not included) for the protection of the unit (Figure 4). Humminbird® is not responsible for over-voltage or over-current failures.

NOTE: In order to minimize the potential for interference with other marine electronics, a separate power source (such as a second battery) may be necessary.

3. Assemble the Control Head Base

Your control head base will have a tilt and swivel mount. See the instructions below to assemble and mount the control head base.

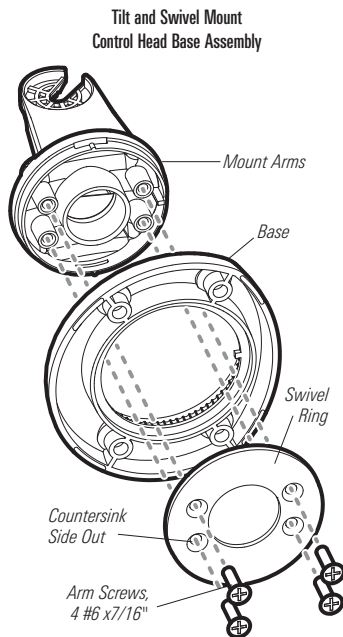

Figure 5

To assemble a tilt and swivel mount:

1. Insert the mount arms into the base. Then, hold the mount arms in place as you turn the base upside down.
2. Insert the swivel ring into the base, with the countersink holes for the arm screws facing out.
3. Secure the mount arms with the four #6 screws provided (Figure 5).
Hand tighten only!
4. Set the assembled control head base in place on the mounting surface. Mark the four mounting screw locations with a pencil or punch.
5. Set the base aside, and drill the four mounting screw holes using a 9/64" bit.
6. Proceed to ***Route the Control Head Cables Under the Deck.***

4. Route the Control Head Cables Under the Deck

Use the following steps to route the control head cables under the deck.

NOTE: Under the deck cable routing is not always possible. If this is not an option, the cables should be routed and secured above deck.

NOTE: See *Transom Transducer Installation* in order to plan the location of the transducer and cable route.

Tilt and Swivel Mount
Control Head Base

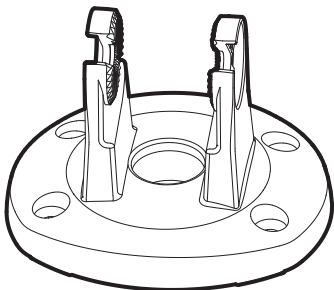

Tilt and Swivel Mount:

- 1a. Mark and drill a 3/4" hole as shown in Figure 6. Route the cables through the hole. The cables will exit through the center hole on the control head base.
- 1b. If the cables cannot be routed directly beneath the control head base, mark and drill a 3/4" hole that will allow you to run the cables close to the control head base.

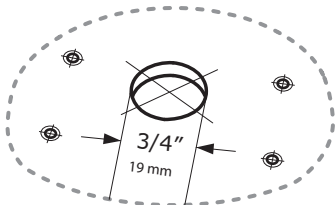

Figure 6

5. Attach the Control Head to the Base

Follow these steps to attach the control head to the already-assembled base:

NOTE: The transducer cable and power cable should be routed prior to securing the mounting bracket to the deck.

1. Apply marine-grade silicone sealant to the drilled holes for the mounting bracket.
2. Place the mounting bracket on the mounting surface, aligning with the drilled holes.
3. Insert the four #8 Phillips countersink wood screws into the mounting holes. **Hand tighten only!**

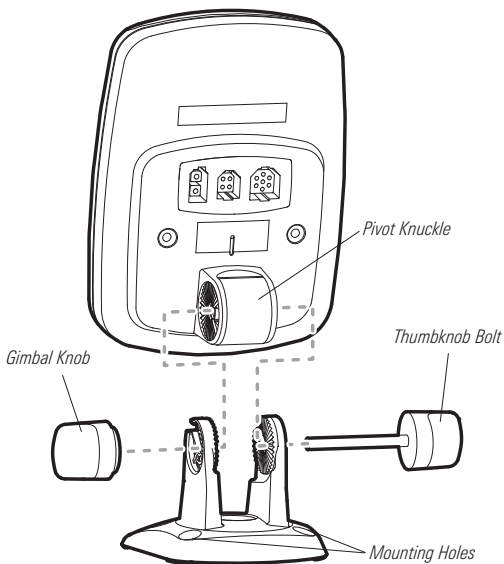

Figure 7

4. Insert the thumbknob bolt through the pivot knuckle on the control head (Figure 7).

5. Align the pivot knuckle with the mount base arms and slide into place, twisting slightly if necessary, until the unit is firmly seated.
6. Rotate the control head to the desired angle and hand tighten the thumbknob bolt.
7. Thread the gimbal knob onto the pivot bolt and tighten.

6. Attach the Cables to the Control Head

Follow these steps to attach the power and transducer cables to the control head:

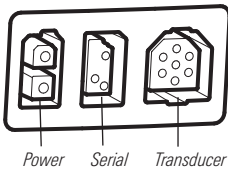

Figure 8

1. Matching the cable plugs to the shape and orientation of the sockets, insert the transducer and power cables into the correct sockets on the control head (Figure 8).

NOTE: The serial port is for authorized service personnel use only. Do not connect a cable to this port. The serial port does not require a port cover.

2. With the control head in place, tilt and/or swivel the unit through its full range to make sure there is enough cable slack for the unit to move freely. Hand tighten the thumbknob bolt when you achieve the desired position for the control head.

You are now ready to install the transducer. Proceed to ***Transom Transducer Installation Overview***.

Transom Transducer Installation Overview

Following are instructions for transom mount installation. The transom mount installation provides the least loss of signal since the transducer is mounted outside the hull. This installation also allows adjustment of both running angle and depth after the transducer is mounted, which enables you to tune the installation for best results.

NOTE: Due to the wide variety of hulls, only general instructions are presented in this installation guide. Each boat hull represents a unique set of requirements that should be evaluated prior to installation. It is important to read the instructions completely and understand the mounting guidelines before beginning installation.

NOTE: When drilling holes in fiberglass hulls, it is best to start with a smaller bit and use progressively larger drill bits to reduce the chance of chipping or flaking the outer coating.

NOTE: If you cannot find a transom mount location that will work for your boat hull, a different mounting technique or transducer type should be considered. See the FAQ (Frequently Asked Questions) section of our Web site at humminbird.com or call our Customer Resource Center at **1-800-633-1468**.

Transom Transducer Installation

1. Locate the Transducer Mounting Position

Turbulence: You must first determine the best location on the transom to install the transducer. It is very important to locate the transducer in an area that is relatively free of turbulent water.

Consider the following to find the best location with the least amount of turbulence:

Areas of Possible Turbulence

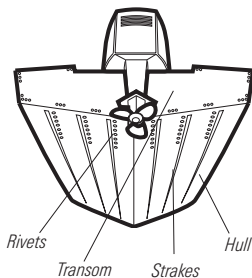

Figure 9

- As the boat moves through the water, turbulence is generated by the weight of the boat and the thrust of the propeller(s) - either clockwise or counter-clockwise. This turbulent water is normally confined to areas immediately aft of ribs, strakes or rows of rivets on the bottom of the boat, and in the immediate area of the propeller(s). Clockwise propellers create more turbulence on the port side. On outboard or inboard/outboard boats, it is best to locate the transducer at least 15" to the side of the propeller(s) (Figure 11).

Stepped Hull

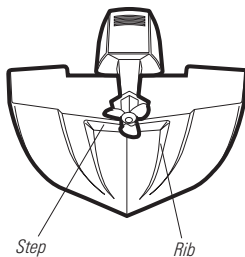
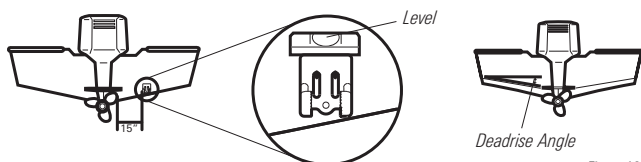

Figure 10

- The best way to locate turbulence-free water is to view the transom while the boat is moving. This method is recommended if maximum high-speed operation is a high priority. If this is not possible, select a location on the transom where the hull forward of this location is smooth, flat and free of protrusions or ribs (Figure 9).
- On boats with stepped hulls, it may be possible to mount the transducer on the step. Do not mount the transducer on the transom behind a step to avoid popping the

transducer out of the water at higher speeds. The transducer must remain in the water for the control head to maintain the sonar signal (Figure 10).

- If the transom is behind the propeller(s), it may be impossible to find an area clear from turbulence, and a different mounting technique or transducer type should be considered, such as an Inside the Hull Transducer.
- If you plan to trailer your boat, do not mount the transducer too close to trailer bunks or rollers to avoid moving or damaging the transducer during loading and unloading of the boat.
- If high speed operation is critical, you may want to consider using an In-Hull transducer instead of this Transom Mount transducer.



Find a turbulence-free location at least 15" from the propeller(s) and not in line with trailer bunks or rollers. (Figure 11).

Figure 12

NOTE: The hydrodynamic shape of your transducer allows it to point straight down without deadrise adjustment (Figure 12).

NOTE: If you cannot find a transom mount location that will work for your high-speed application, please visit the FAQ (Frequently Asked Questions) section of our Web site at humminbird.com or call our Customer Resource Center at 1-800-633-1468.

2. Prepare the Mounting Location

After determining the mounting location for the transducer, follow the steps below to position and mount the transducer bracket.

Positioning the Mounting Bracket

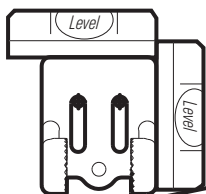
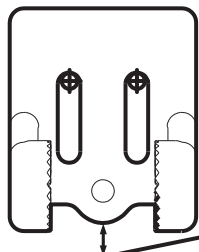

Figure 13

Boat Hull Types Require Different Mounting Positions



1/8" for aluminum
1/4" for fiberglass

Figure 14

Using the Mounting Bracket to Mark the Initial Drill Holes

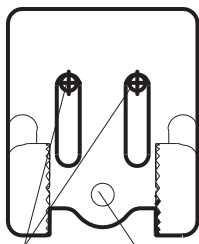

Mark Initial
Drill Holes

3rd hole

Figure 15

1. Make sure that the boat is level on the trailer, both from port to starboard and from bow to stern, by placing your level on the deck of the boat, first in one direction, then in the other.
2. Hold the mounting bracket against the transom of the boat in the location you have selected (Figure 13). Align the bracket horizontally, using the level. Make sure that the lower screw hole protrusion does not protrude past the bottom of the hull, and there is at least 1/4" clearance between the bottom of the bracket and the bottom of the transom for fiberglass boats, and 1/8" clearance for aluminum boats (Figure 14).

NOTE: If you have a flat-bottomed aluminum boat, some additional adjustment may be needed to accommodate the rivets on the bottom of the boat (i.e. the gap may need to be a little smaller than 1/8"). This will help you to avoid excessive turbulence at high speeds.

NOTE: If your propeller moves clockwise as the boat moves forward (as you're facing the stern of the boat from behind), mount the transducer on the starboard side, and align the bottom right corner of the mounting bracket with the bottom of the boat. If your propeller moves counterclockwise as the boat moves forward (as you're facing the stern of the boat from behind), mount the transducer on the port side, and align the bottom left corner of the mounting bracket with the bottom of the boat.

3. Continue to hold the bracket on the transom of the boat, and use a pencil or marker to mark where to drill the two mounting holes. Mark the drill holes near the top of each slot, making sure that your mark is centered in the slot (Figure 15).

NOTE: The third hole should not be drilled until the angle and height of the transducer is finalized, which you will not do until a later procedure.

- Make sure that the drill bit is perpendicular to the actual surface of the transom, NOT parallel to the ground, before you drill. Using a 5/32" bit, drill the two holes only to a depth of approximately 1".

NOTE: On fiberglass hulls, it is best to use progressively larger drill bits to reduce the chance of chipping or flaking the outer coating.

3. Assemble and Mount the Transducer

In this procedure, you will assemble the transducer using the hardware provided, then mount it and make adjustments to its position without locking it in place.

NOTE: You will initially assemble the transducer and the mounting bracket by matching the two ratchets to a numbered position on the transducer knuckle. Further adjustments may be necessary.

- If you already know your transom angle, refer to the chart below for the initial position to use to set the ratchets (Figure 16). If your transom is angled at 14 degrees (a common transom angle for many boats) use position 1 for the ratchets. In either case, go to step 2.

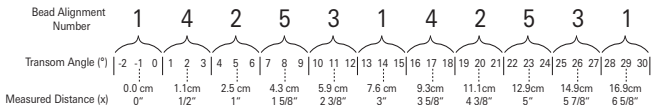

Figure 16

or...

- If you do not know your transom angle, measure it using a plumb line (weighted nylon string or monofilament line) exactly 12 inches long. Hold the top of the plumb line against the top of the transom with your finger, and wait until the line hangs straight down (Figure 17). Using a ruler, measure the distance from the **bottom** of the plumb line to the back of the transom, then use the chart (Figure 16).

NOTE: It is important to take your measurement in the location shown in Figure 17, from exactly 12 inches down from the top of the transom.

Measuring the Transom Angle

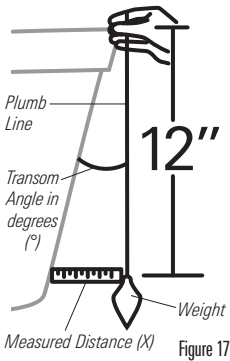

2. Place the two ratchets, one on either side of the transducer knuckle, so that the beads on each ratchet line up with the desired position number on the knuckle (Figure 18a). If you are setting the ratchets at position 1, the beads on each ratchet will line up with the rib on the transducer knuckle to form one continuous line on the assembly (Figure 18b).

NOTE: The ratchets are keyed. Make sure that the square teeth on each ratchet face the square teeth on the transducer knuckle, and the triangular teeth face outward.

Hold the ratchets on the transducer knuckle with one hand and fit the mounting bracket over them until it snaps into place with the other hand. Refer to the illustration (Figure 18d).

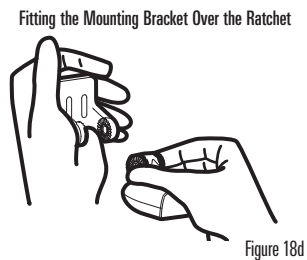
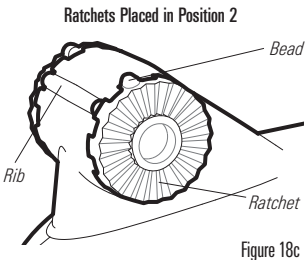
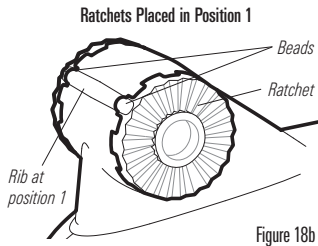
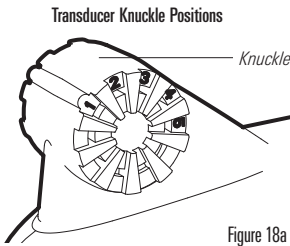

Inserting the Pivot Bolt

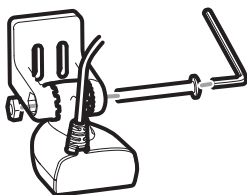

Figure 19

Mounting the Assembly to the Transom

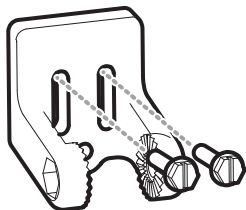

Figure 20

- Put the pivot bolt through the assembly to hold it in position and loosely install the nut, but do NOT tighten the nut at this time (Figure 19).

CAUTION! Do not use a high speed driver on this combination of fasteners. Hand tighten only.

- Align the mounting bracket transducer assembly with the drilled holes in the transom. With a 5/16" socket driver, mount the assembly to the transom using the two #10 - 1" long screws provided (Figure 20). **Hand tighten only!**

NOTE: Make sure that the mounting screws are snug, but do not fully tighten the mounting screws at this time to allow the transducer assembly to slide for adjustment purposes.

- Adjust the initial angle of the transducer from back to front by rotating the transducer until the side seam on the transducer is almost parallel with the bottom of the boat, one click at a time in either direction (Figure 21 and 22).

Adjusting the Initial Transducer Angle

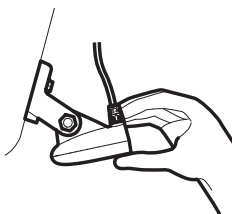

Figure 21

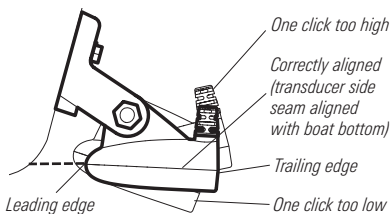

Figure 22

Adjusting the Transducer
Mounting Position

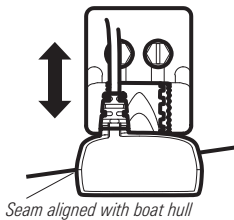

Figure 23

Leveling the Mounting
Assembly Horizontally

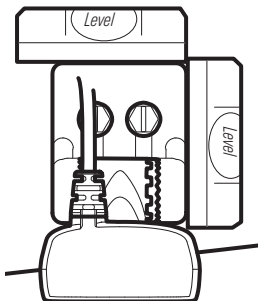

Figure 24

6. Adjust the transducer assembly vertically, until the seam on the leading edge of the transducer (the edge closest to the transom of the boat) is level and just slightly below the hull (Figure 23).

NOTE: The transducer has a natural downward slant of 4-5 degrees from leading edge (closest to the boat transom) to trailing edge (farthest away from the boat). Looking at the back of the transducer, the seam should be slightly below the bottom of the hull.

7. Continue to adjust until the bracket is also level from port to starboard (horizontally level as you look at the transducer from behind the boat [Figure 24]).

8. Mark the correct position on the transom by tracing the silhouette of the transducer mounting bracket with a pencil or marker.

9. Tighten the pivot bolt, using the pivot screw and nut to lock the assembly. **Hand tighten only!**

CAUTION! Do not use a high speed driver on this combination of fasteners. Hand tighten only.

10. Hand-tighten the two mounting screws.

NOTE: You will drill the third mounting hole and finalize the installation after you route the cable and test and finish the installation in the following procedures.

4. Route the Cable

The transducer cable has a low profile connector, which must be routed to the point where the control head is mounted. There are several ways to route the transducer cable to the area where the control head is installed. The most common procedure routes the cable through the transom into the boat.

NOTE: *Your boat may have a pre-existing wiring channel or conduit that you can use for the transducer cable.*

1. Unplug the other end of the transducer cable from the control head. (The transducer cable was connected in the earlier section **Attach the Cables to the Control Head**). Make sure that the cable is long enough to accommodate the planned route by running the cable over the transom.

CAUTION! *Do not cut or shorten the transducer cable, and try not to damage the cable insulation. Route the cable as far as possible from any VHF radio antenna cables or tachometer cables to reduce the possibility of interference. If the cable is too short, extension cables are available to extend the transducer cable up to a total of 50'. For assistance, contact the Customer Resource Center at humminbird.com or call 1-800-633-1468 for more information.*

NOTE: *Allow enough slack in the cable for slight movement at the pivot point. It is best to route the cable to the side of the transducer so the transducer will not damage the cable during movement.*

- 2a. If you are routing the cable over the transom of the boat, secure the cable by attaching the cable clamp to the transom, drilling 9/64" diameter holes for the #8 x 5/8" wood screws, then skip directly to step 5 to connect the cable.

or...

- 2b. If you will be routing the cable through a hole in the transom, drill a 5/8" diameter hole above the waterline. Route the cable through this hole, then fill the hole with marine-grade silicone sealant and proceed to the next step immediately.

Routing the Cable

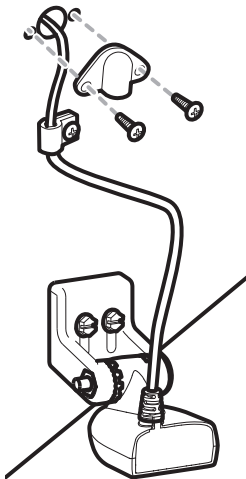

Figure 25

Storing Excess Cable



Figure 26

3. Place the escutcheon plate over the cable hole and use it as a guide to mark the two escutcheon plate mounting holes. Remove the plate, drill two 9/64" diameter x 5/8" deep holes, and then fill both holes with marine-grade silicone sealant. Place the escutcheon plate over the cable hole and attach with two #8 x 5/8" wood screws. **Hand tighten only!**
4. Route and secure the cable by attaching the cable clamp to the transom. Drill one 9/64" diameter x 5/8" deep hole, then fill hole with marine-grade silicone sealant, then attach the cable clamp using a #8 x 5/8" screw. **Hand tighten only!**

***NOTE:** If there is excess cable that needs to be gathered at one location (as shown in the illustration), dress the cable routed from both directions so that a single loop is left extending from the storage location. Doubling the cable up from this point, form the cable into a coil. Storing excess cable using this method can reduce electronic interference (Figure 26).*

5. Plug the cable connector back into the control head. The slots are keyed to prevent reversed installation, so be careful not to force the connector into the holder.

Your control head is now ready for operation.

5. Test and Finish the Installation

Once you have installed both the control head and the transom transducer, and have routed all the cables, you must perform a final test before locking the transducer in place. Testing should be performed with the boat in the water.

1. Press POWER once to turn the control head on. If the unit does not power up, make sure that the connector is fully plugged into the terminal slot and that power is available.
2. If all connections are correct and power is available, the Humminbird® control head will enter Normal operation.
3. If the bottom is visible on-screen with a digital depth readout, the unit is working properly. Make sure that the boat is in water greater than 2' but less than the depth capability of the unit, and that the transducer is fully submerged, since the sonar signal cannot pass through air.

NOTE: *The transducer must be submerged in water for reliable transducer detection.*

4. If the unit is working properly, gradually increase the boat speed to test high-speed performance. If the unit functions well at low speeds, but begins to skip or miss the bottom at higher speeds, the transducer requires adjustment.
5. If you have the correct angle set on the transducer, yet lose a bottom reading at high speed, adjust the height and the running angle in small increments to give you the ideal transducer position for your boat. First, adjust the height in small increments (Figure 23).

NOTE: *The deeper the transducer is in the water, the more likely that a rooster tail of spray will be generated at high speeds, so make sure that the transducer is as high as it can be and still be submerged in the water.*

If you are still not getting good high speed readings, you may need to disassemble the transducer mounting assembly and re-position the ratchets (Figures 18a - 18d).

If you do change the transducer position, re-trace the position of the mounting bracket before proceeding.

NOTE: It is often necessary to make several incremental transducer adjustments before optimum high speed performance is achieved. Due to the wide variety of boat hulls, however, it is not always possible to obtain high speed depth readings.

6. Once you have reached a consistently good sonar signal at the desired speeds, you are ready to lock down the transducer settings. Remove the transducer from the bracket (after noting where the ratchets are assembled), then re-align the mounting bracket against the transom of the boat to match the traced silhouette. Check the bracket position with the level again to make sure it is still level, then mark the third mounting hole using a pencil or marker. Unscrew and remove the mounting screws and the transducer bracket and set aside.
7. Drill the third mounting hole, using a 5/32" drill bit. Use a marine-grade silicone sealant to fill all three drilled mounting holes, especially if the holes penetrated the transom wall.

NOTE: On fiberglass hulls, it is best to use progressively larger drill bits to reduce the chance of chipping or flaking the outer coating.

Fully Tighten All Three
Mounting Screws

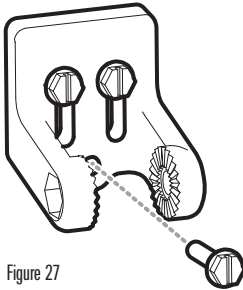

Figure 27

8. Re-position the transducer bracket against the transom of the boat, then hand-install all three screws. Make sure that the transducer location has not changed, then fully tighten all three mounting screws (Figure 27). **Hand tighten only!** Re-install the transducer to the mounting bracket, making sure to assemble the ratchets in the same location they had before. (See Figures 18a - 18d and Figure 21 - 22). If you have performed the preceding procedures correctly, the transducer should be level and at the right height for optimal operation.

PiranhaMAX Portable Case Assembly

It is important to perform the PiranhaMAX portable case assembly tasks in order, referring to the step-by-step procedures that represent the following main assembly tasks:

- Assembling the PiranhaMAX mount
- Assembling the base and handle
- Assembling the control head to the base and handle
- Routing the cables in the base
- Assembling the portable case
- Charging and installing the battery
- Assembling the transducer mounting bracket
- Stowing the portable transducer and battery charger into the portable case.

When you are done, the control head and the transducer will be part of the portable case assembly, and you will be ready to take your portable case to the boat for final setup.

***NOTE:** In addition to the hardware supplied with your installation kit, you will need a hammer, Phillips screwdriver, socket wrench, and a rope or bungee cord.*

1. Assemble the Control Head Base

Your control head base will have a tilt and swivel mount. See the instructions below to assemble and mount the control head base.

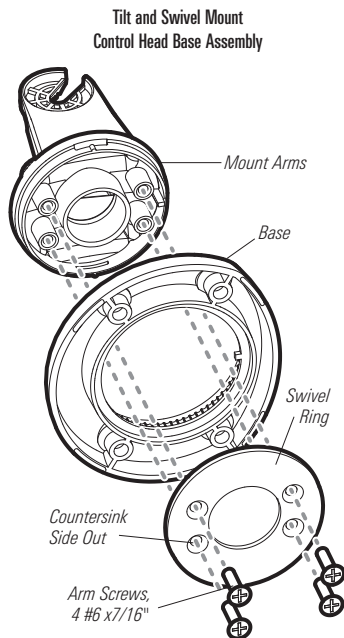

Figure 28

To assemble a tilt and swivel mount:

1. Insert the mount arms into the base. Then, hold the mount arms in place as you turn the base upside down.
2. Insert the swivel ring into the base, with the countersink holes for the arm screws facing out.
3. Secure the mount arms with the four #6 screws provided (Figure 28). **Hand tighten only!**

2. Assemble the Base and Handle

In this procedure, you will install the PiranhaMAX mount and handle to the base of the portable case.

Punching Holes

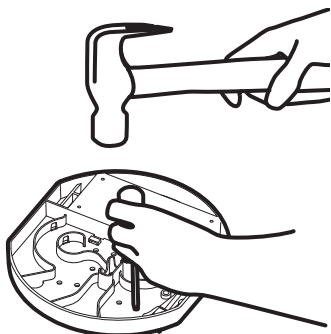

Figure 29

1. Turn the base upside down. Punch out the mounting holes labeled "C" with a hammer and a screwdriver (or an awl) as shown in the illustration ***Punching Holes***.
2. Turn the base right side up. Line up the PiranhaMAX mount with the holes you punched out in step 1.
3. Using a socket wrench and a Phillips screwdriver, secure the PiranhaMAX mount to the base with the four included 3/4" screws, lock washers, and nuts. **Hand tighten only!**

Attaching the Mount to the Base

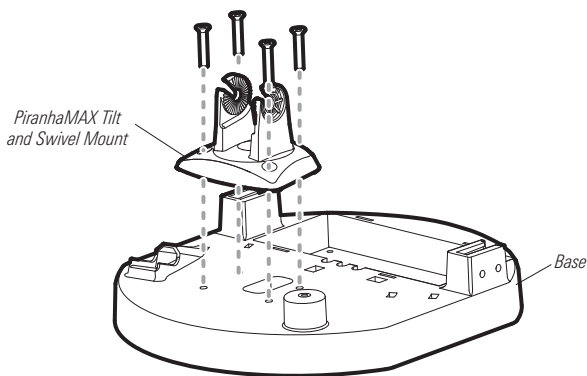

Figure 30

4. Install the handle onto the base, so that the curved part of the handle faces towards the back of the base, towards the battery well. Use the four included #8-32 x 7/16" screws, two on each side, to attach the handle to the base (see the illustrations *Installing the Handle Onto the Base* and *Sliding in the Handle*). **Hand tighten only!**

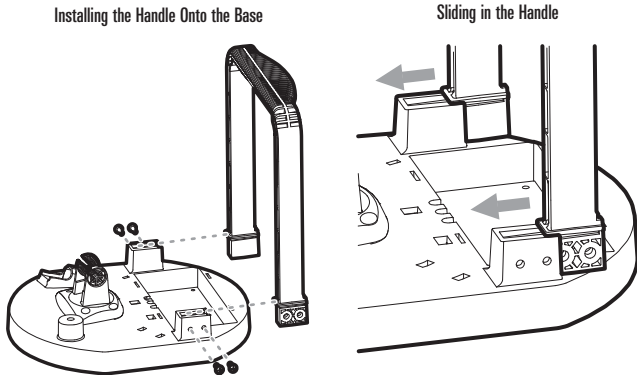

Figure 31

NOTE: The handle is keyed so that it only fits onto the base in one direction.

3. Attach the Control Head to the Base and Handle

In this procedure you will install the control head onto the base assembly.

1. Insert the thumbknob bolt through the pivot knuckle on the control head.
2. Align the pivot knuckle with the mount arms and slide into place, twisting slightly if necessary, until the unit is firmly seated.
3. Rotate the control head to the desired angle and hand tighten the thumbknob bolt.
4. Thread the gimbal knob onto the pivot bolt and tighten.

Attaching the Control Head to the Base and Handle

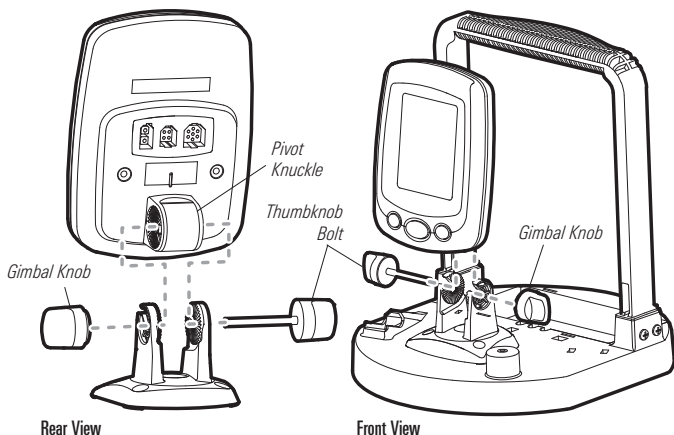

Figure 32

4. Route the Cables

In this procedure, you will route the power and transducer jumper cables on the underside of the base, and attach the tie-down straps that will be used to secure the battery to the base in a later procedure.

1. Turn the base upside down, then thread the two included hook and loop battery tie-down straps from the bottom of the base up through each side of the battery well, using the strap holes (see the illustration ***Attaching the Battery Tie-Down Straps***).

Attaching the Battery Tie-Down Straps

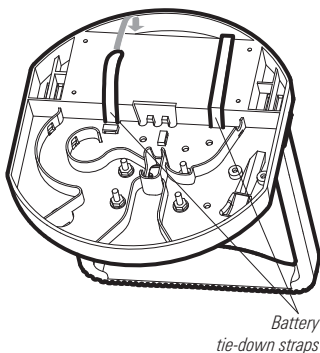

Figure 33

2. Route the power cable from the mount DOWN through the center hole of the base. Route the transducer jump cable UP through the base and mount. (Figure 34)
3. Connect the cables to the control head. The slots for the plugs are keyed to prevent reverse installation, and insertion should be easy. Do not to force the connectors into the control head. (Figure 35)
4. Pull the power cable through the opening in the long side of the cable well and insert it into the battery well (see the illustration *Installing the Cables Onto the Base*).
5. Route the transducer jumper cable (see the illustration *Installing the Cables Onto the Base*) out the long side of the cable well and follow the arrows on the base.

Pulling the Cables Through the Base

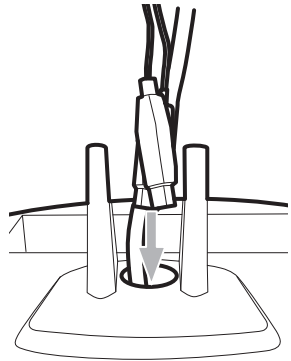

Figure 34

Connecting the Cables to the Control Head

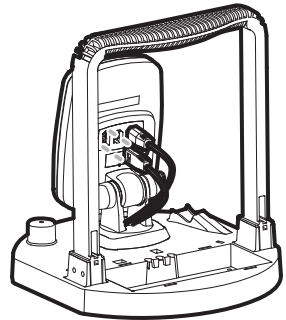

Figure 35

Installing the Cables Onto the Base

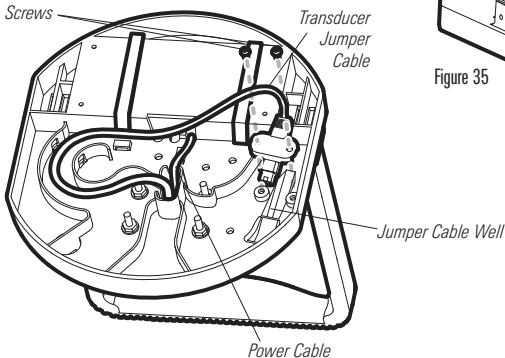

Figure 36

6. Fit the transducer jumper cable connector down into the jumper cable well and snap it into place. Insert the two #6-32 x 1/4" screws included to secure the transducer jumper connector and tighten using a Phillips screwdriver. **Hand tighten only!**
7. Secure all cables to the base, using the included zip ties, at the mount points shown in the illustration (see the illustration *Tying Down the Cables*).

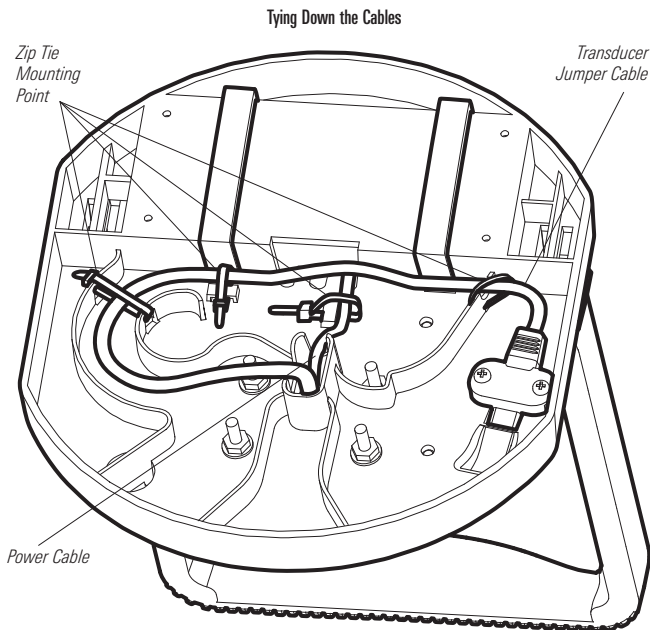

Figure 37

8. Turn the base right side up and pull up gently on the battery tie-down straps to remove the slack.

NOTE: You will need to perform more assembly procedures, as well as charge the battery for 8 hours, before you install the battery into the portable case. See **Charge and Install the Battery** for more information.

5. Assemble the Portable Case

In this procedure, you will install the base assembly into the portable case.

1. Unzip the largest opening on the front of the portable case.
2. Insert the base assembly into the portable case, so that the PiranhaMAX control head is facing out of the case. For best results, pull the case over one shoulder of the handle at a time.
3. Adjust the case so that you can easily grab the handle, through the fabric handhold inset, from the outside top of the portable case.

Installing the Base into the Case



Pulling the Case over the Handle



Holding the Portable Case



Figure 38

6. Charge and Install the Battery

In this procedure you will charge and then install and secure the battery.

1. Charge the battery, using the included battery charger, until it is fully charged as indicated by the LED on the charger. Charging usually requires 8 continuous hours but may vary depending on your configuration.

NOTE: Some international models may not include a battery or battery charger.

2. Open the bottom back zipper on the portable case, and install the battery in the battery well. While holding the tie-down straps out of the way, make sure the power cable is fitted snugly into the slot in the well so that the battery does not rest on it (see the illustration **Installing the Battery**).

Installing the Battery

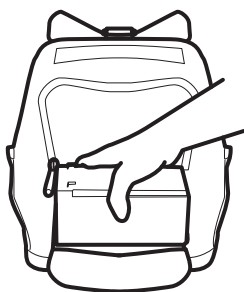

Tying Down the Battery

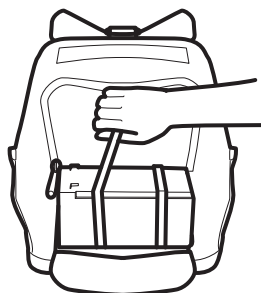

Figure 39

3. Pull the two battery tie-down straps over the top of the battery and connect both ends of each strap over the top, making sure that the straps are pulled tight around the battery and that the battery is seated securely in the battery well.
4. Zip up the back opening.

NOTE: Do NOT connect the power cable to the battery at this time. You should wait until just before fishing to connect the power cable to the battery.

7. Assemble the Transducer Mounting Bracket

In this procedure you will assemble the portable transducer mounting bracket.

1. Line up the two ratchet pieces at position 1 so that the beads are aligned with the rib on the transducer. See illustrations.

Transducer Knuckle Positions

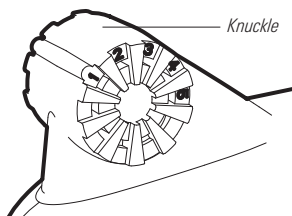

Ratchets Placed in Position 1

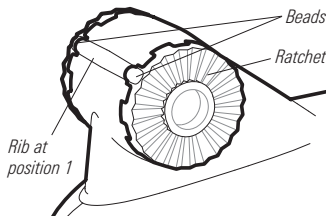
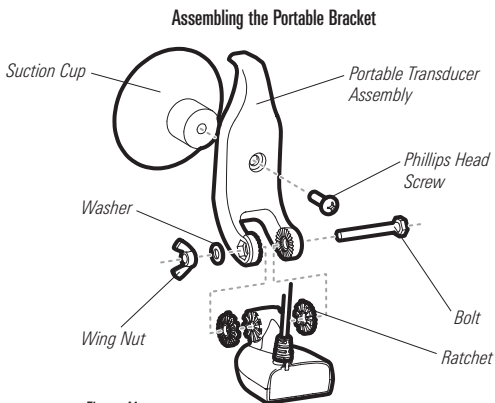
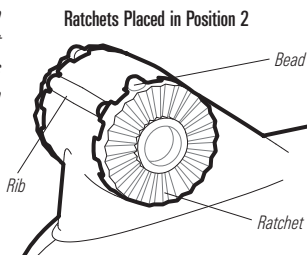

Figure 40

2. Assemble the other transducer parts as shown (see the illustration *Assembling the Portable Bracket* below). **Hand tighten only!**



NOTE: If you are unable to ratchet the transducer so that it rests below the water and points straight down, you can disassemble it and align the beads with a different number until you reach a position that allows the proper alignment.



8. Stow the Portable Transducer and Battery Charger into the Portable Case

1. Load the portable transducer into the carrying compartment (upper zip opening on the back of the portable case) and close the zipper.
2. Turn the portable case around so that you can access the front, and load the battery charger into the zip pocket on the left as you face the front of the portable case.
3. Make sure all the zippers are closed.

Installing the Portable Case on the Boat

Since the portable case has a large non-skid mounting surface, it may be attached to almost any surface.

In this section, you will route the cables on the boat, connect the transducer and power cables to the portable case, and attach the portable case to a dry and convenient location on your boat.

1. Connect the Transducer and Power Cables to the Portable Case

1. Make sure the large opening in the front of the portable case is unzipped; you may want to roll up the flap and secure it with the provided strap and clip while you're working.
2. Plug the transducer cable into the jumper port in the portable case to the left of the control head, as you face the front of the bag (see the illustration *Plugging in the Transducer*).

Plugging in the Transducer

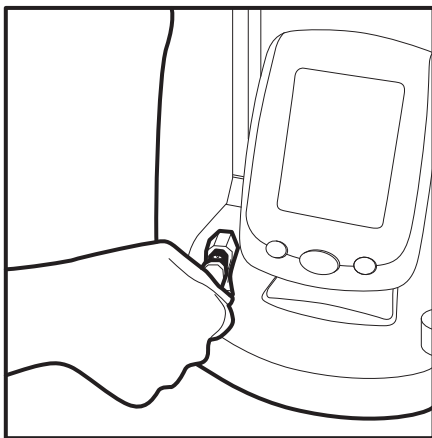

3. Turn the portable case around so that you can access the back, and open the back zipper. Connect the spade clip on the red wire of the power cable to the red terminal on the battery, and the spade clip on the black wire of the power cable to the black terminal on the battery. Make sure that the spade clips are snugly attached to the terminals (see the illustration *Connecting the Spade Clips*).
4. Make sure the back battery door and side pockets are zipped, but leave the front of the bag unzipped for easy access during installation.

Connecting the Spade Clips



Figure 43

2. Attach the Portable Case to the Boat

1. Attach the portable case to a surface on the boat by threading rope or bungee cord (not provided) through the D-rings on either side of the portable case.

NOTE: Humminbird® recommends that you do NOT position the portable case on the bottom of the boat, or in a location where it can be splashed by or immersed in water, as the portable case is water resistant, but not waterproof.

Mounting the Portable Transducer

Once your Portable fishfinder is fully assembled (see the *Portable Case Assembly* section for more information), it takes just a few easy steps before you are ready to fish:

- Test the transducer prior to installation
- Mount the portable transducer on the boat

1. Test the Transducer Prior to Installation

Prior to installation, test the transducer to make sure that no damage occurred during shipping.

1. Hold the transducer in the water over the side of the boat to confirm proper operation. If the transducer is working properly, you should be able to see the bottom on the control head display.

2. Mount the Portable Transducer on the Boat

Perform the procedures in this section to install the transducer on your boat.

NOTE: *The suction cup mount is designed for quick, easy installation and removal, NOT for high speed operation. If you intend to operate your boat at any speed faster than trolling speeds, remove the suction cup transducer from the water.*

It is important that the mounting position allows the transducer to rest beneath the surface of the water, pointing straight down. You can mount the transducer anywhere on the side of the boat if your boat remains stationary. If you are trolling, it is best to mount the transducer on the transom of the boat.

Your portable transducer is designed to be installed and adjusted without the use of tools. Mounting the transducer to the boat is a simple yet important operation. A poor mounting location will affect the overall performance of the Humminbird® unit, so follow the mounting instructions carefully. It is important that the mounting position allows the transducer to rest beneath the surface of the water, pointing straight down. You can mount the transducer anywhere on the side of the boat if your boat remains stationary.

NOTE: If you are trolling, it is best to mount the transducer on the transom of the boat.

1. Mount the transducer so that it points straight down and so that the transducer itself is submerged in the water (see the illustration *Portable Transducer Mount*).

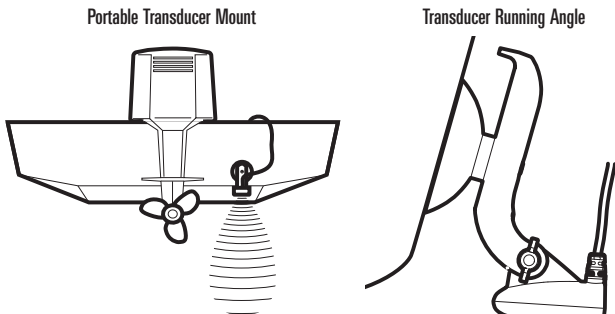

Figure 44

2. Adjust the running angle so that the transducer is parallel to and below the surface of the water (see the illustration *Transducer Running Angle*).
3. Hand-tighten the wing nut so that the transducer will not rotate.

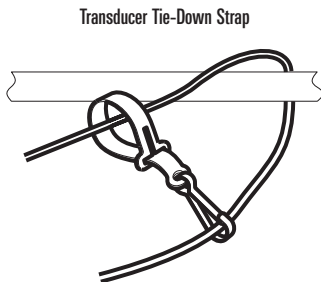

Figure 45

4. Secure the transducer cable in case of accidental release when the boat is moving, since a loose transducer can cause damage to itself, your boat, or become tangled in the propeller. Attach the tie-down strap to the transducer cable around an immovable object such as a rail or fitting, as shown in the illustration (see the illustration *Transducer Tie-Down Strap*).

5. When you have finished using the transducer, unplug the transducer cable from the transducer jumper port on the base, then coil the cable around the assembly.

Moving the Portable Fishfinder

You should take the portable case with you when you leave the boat and will not be using it. Perform the following steps to make your unit mobile:

1. With the boat engine off, loosen all cable retainers/clips holding the transducer.
2. Remove the case from the surface mount.
3. Remove the transducer from the surface where it has been mounted, wipe it dry, and stow it in the portable case rear pocket.
4. Unplug the power cable when not in use.

Power ON and OFF

Use the following instructions to power on your PiranhaMAX unit:

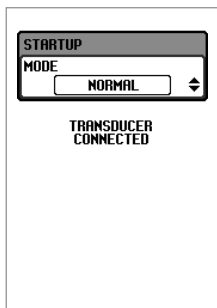

- **Power On:** Press the POWER/MENU key until the PiranhaMAX powers on, then release the key.
- **Start-Up Menu:** When the PiranhaMAX powers on, the Start-Up menu temporarily appears. From this menu, select either Normal or Simulator.
 - For on the water use, select **Normal**.
 - To learn how to use the system with simulated data, select **Simulator**.
- **Power Off:** Press and hold the POWER/MENU key until the unit powers off.

***NOTE:** International units powered on for the first time will first display setup menu options such as Language, Units - Distance, Units - Speed, etc. for initial system setup.*

***NOTE:** If Simulator Mode is selected from the Start-Up Menu and a transducer is plugged in, some menu setting changes will be saved in memory even after the unit is powered down. Menu setting changes will not be saved when a transducer is not connected.*

To Make a Selection from the Start-Up Menu:

1. Press the UP or DOWN Arrow key to select Normal or Simulator.
2. Press the CHECK/ENTER key to confirm your selection.

***NOTE:** See **Key Functions** and **How to Use the Menu System** for more information.*

PiranhaMAX Sonar Technology

The PiranhaMAX is the easiest to use fishfinder ever. For most anglers, all you'll ever need to do is power on and fish! The PiranhaMAX automatically determines depth and makes adjustments to keep the bottom and fish visible on the display.

The PiranhaMAX uses sonar technology to send sound waves from the transducer into the water. The returned "echoes" are plotted on the display, creating a very accurate picture of the underwater world, including distance to underwater objects such as the bottom, fish, and structure.

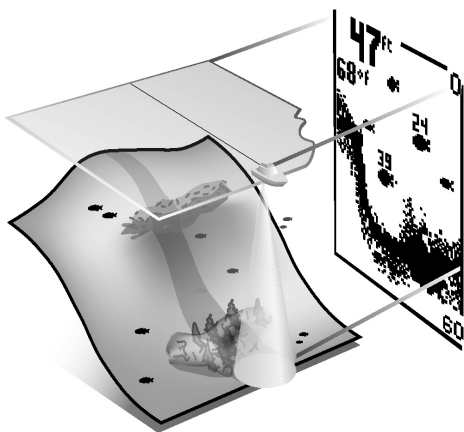

Your PiranhaMAX will have Single or Dual Beam sonar. Find the correct sonar description that applies to your unit.

Single Beam Sonar

The **PiranhaMAX 165** uses a 200 kHz single beam sonar system with a 28° area of coverage. Boat speed, wave action, bottom hardness, water conditions and transducer installation can all affect depth capability.

Dual Beam Sonar

The **PiranhaMAX 175, 176i, 195c, and 196ci** use a 200/455 kHz dual beam sonar system with a 28° area of coverage. Dual Beam sonar is optimized to show the greatest bottom definition using a narrow (16°) beam yet can still indicate fish found in the wide (28°) beam when the Fish ID+™ feature is turned on. Dual Beam is ideal for a wide range of conditions - from shallow to very deep water in both fresh and salt water. Boat speed, wave action, bottom hardness, water conditions, and transducer installation can all affect depth capability.

What You See on the Display

The PiranhaMAX displays underwater information in an easy-to-understand format. The top of the display corresponds to the water surface at the transducer, and the bottom of the display corresponds to the Depth Range automatically selected for the current water depth. The Bottom Contour varies as the depth under the boat changes. Digital readouts provide precise information for depth, fish, and water temperature.

As the boat moves, terrain and bottom composition variations are displayed. Fish, baitfish, and thermoclines (underwater temperature changes) are displayed when detected. Underwater conditions vary greatly, so some experience and interpretation is needed to realize all the benefits of the PiranhaMAX - use the following illustrations as a guide to the most common conditions and practice using your PiranhaMAX over known bottom types.

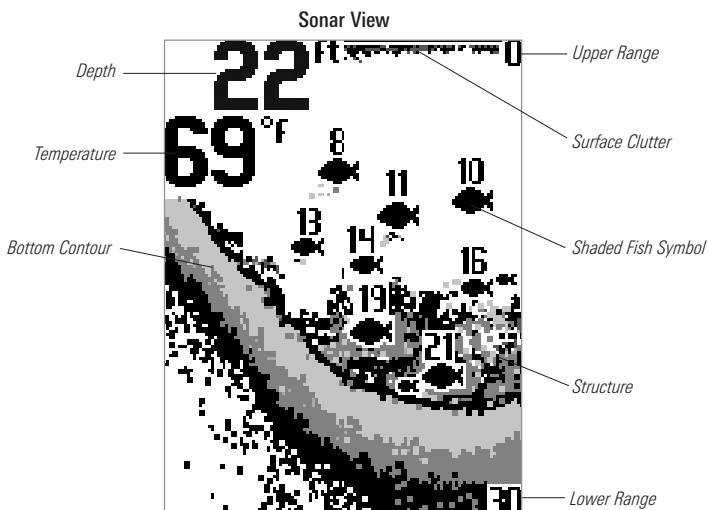

How GPS Works

If your PiranhaMAX model includes GPS (Global Positioning System), it will use GPS and sonar to determine your current track, display it on a grid, and provide detailed underwater information.



GPS uses a constellation of satellites that continually send radio signals to the earth. The GPS receiver on your boat receives signals from satellites that are visible to it. Based on time differences between each received signal, the GPS receiver determines its distance to each satellite. With distances known, the GPS receiver mathematically triangulates its own position. With 5 updates per second, the GPS receiver then calculates its velocity and bearing.

GPS was originally intended for military use; however, civilians may also take advantage of its highly accurate position capabilities, typically within +/- 4.5 meters, depending on conditions. This means that 95% of the time, the GPS receiver will read a location within +/- 4.5 meters of your actual position. Your GPS Receiver also uses information from WAAS (the Wide Area Augmentation System), EGNOS (the European Geostationary Navigation Overlay Service), and MSAS (the MTSAT Satellite Augmentation System) satellites if they are available in your area.

PiranhaMAX models that include GPS currently support the following GPS functionality:

- View current track (breadcrumb trail)
- View precision speed and heading
- Save waypoints. Your Fishfinder can store over 500 waypoints.

See **Track View** for more information.

The PiranhaMAX Control Head

Your PiranhaMAX unit interface is easy to use. A combination of keys and special features allows you to control what you see on the display. Refer to the following illustration, and see *Key Functions* for more information.

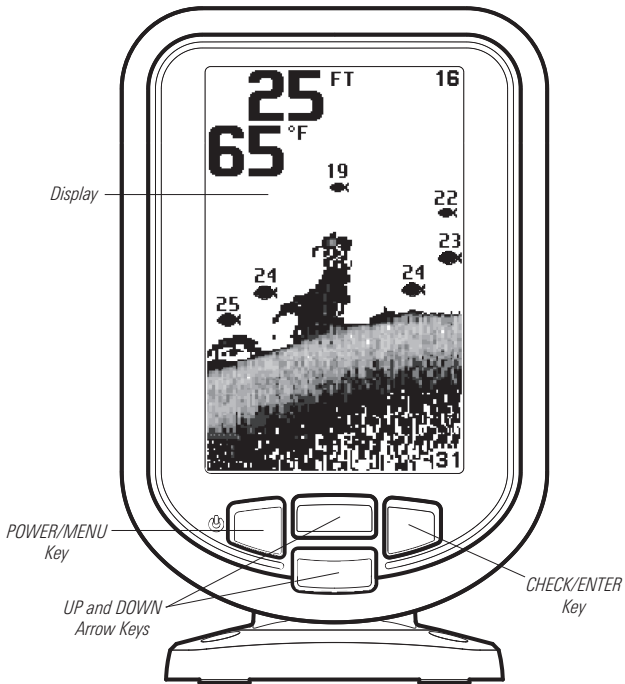

Key Functions

Your Fishfinder has a set of easy to use keys that give you flexibility and control over your fishing experience.



POWER/MENU Key

The **POWER/MENU key** is used to power the PiranhaMAX on and off. It is also used to open and close the menu system.

- **Menus:** Press the POWER/MENU key in any view to open the menu for that view. Each menu provides frequently-used menu settings that correspond with the current view.
- **Menu Option Settings:** Press the POWER/MENU key to confirm a menu option setting. The changes will be activated and saved immediately.
- **Exit:** In an active menu, press the POWER/MENU key to return to the previous submenu in the menu system. In an inactive menu, press the POWER/MENU key to exit the menu and return to the current view.

***NOTE:** See [How to Use the Menu System](#) for more information.*

***NOTE:** Each time the POWER/MENU key is pressed, the backlight momentarily illuminates for easy viewing at night. Adjust the [LIGHT](#) menu setting to keep the backlight on (see [Sonar Menu: Light](#)).*



UP and DOWN Arrow Keys

The **UP and DOWN Arrow Keys** have multiple functions, which depend on the view, menu, or situation.



- **Menu Selection:** Press the UP or DOWN Arrow keys to highlight a menu option.
- **Menu Option Settings:** Press the UP or DOWN Arrow keys to adjust a menu setting in an active menu.
- **Track View (PiranhaMAX 176i and 196ci only):** Press the UP or DOWN Arrow keys to adjust the zoom scale in Track View.
- **Sonar View:** Press the UP or DOWN Arrow keys to adjust the Sensitivity in Sonar View.



CHECK/ENTER Key

The **CHECK/ENTER Key** has multiple functions, which depend on the view, menu, or situation.

- **Menu Activation:** Press the CHECK/ENTER key after selecting a menu option to activate the menu or open a submenu.
*NOTE: See **How to Use the Menu System** for more information.*
- **Menu Option Settings:** Press the CHECK/ENTER key to confirm a menu option setting. The changes will be activated and saved immediately.
- **Mark Waypoints (PiranhaMAX 176i and 196ci only):** Press the CHECK/ENTER key while in Sonar View or Track View to mark the boat's current position as a waypoint.

How to Use the Menu System

Review the instructions below to understand how to use the menu system.



1. Open the Menu System

Press the POWER/MENU key.



2. Select a Menu Option

Press the UP or DOWN Arrow key to select a menu option.

NOTE: Available menu options will be determined by the view currently displayed on-screen. See **Views** for more information.

The menu name will be highlighted, indicating the menu is active, but the menu option is inactive.

Inactive Menu Option

When the menu option is gray, the menu option is inactive.

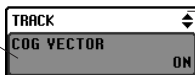

When the menu name is white, the menu is currently selected.



3. Activate a Menu Option and Adjust Settings

Activate a Menu Option: Press the CHECK/ENTER key to activate the selected menu option.

The menu option will be highlighted, indicating the menu option is active and changes can be made to the menu setting.

Active Menu Option

When the menu option is white, the menu option is active.

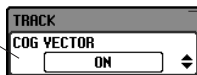

When the menu name is gray, the menu is currently inactive.

Adjust a Menu Setting: After a menu is selected, press the UP or DOWN Arrow keys to adjust the menu setting. Press the CHECK/ENTER key or the POWER/MENU key to confirm the selection. Menu settings are saved and removed from the screen automatically after several seconds.

***NOTE:** In Normal operating mode, most menu settings saved to memory will not return to their default values when the unit is turned off. Some menu settings, such as Light, Depth Range, and Zoom will return to their default settings after the unit is powered off.*

Open a Submenu: Press the CHECK/ENTER key to open a submenu. From the opened submenu, repeat steps 2 and 3 to make a menu selection.



4. Close a Menu

Press the POWER/MENU key until the menu system is closed.

Set Up the Control Head

Use the Setup Menu to customize the settings of your PiranhaMAX unit.

- **Set Sonar View Display Settings:** Use the Setup Menu to set the Contrast, Bottom View, and how fish are displayed on-screen.
- **Set Units of Measurement:** From the Setup Menu, open the Units submenu to set the units of measurement for distance and speed. See *To Open the Units Submenu* for instructions.
- **International Units** will have menu options such as Language and Units of Measurement for depth, speed, distance, and temperature.

NOTE: Menu options are determined by your Humminbird® model. See the following pages for full menu descriptions.

NOTE: If Simulator Mode is selected from the Start-Up Menu and a transducer is plugged in, some menu setting changes will be saved in memory even after the unit is powered down. Menu setting changes will not be saved when a transducer is not connected.

To Open the Setup Menu:

1. Press the POWER/MENU key.
2. Press the UP or DOWN Arrow key to select SETUP and press the CHECK/ENTER key.

*NOTE: See **How to Use the Menu System** for more information.*

To Open the Units Submenu:

1. Press the POWER/MENU key.
2. Press the UP or DOWN Arrow key to select SETUP and press the CHECK/ENTER key.
3. Select UNITS and press the CHECK/ENTER key.

*NOTE: See **How to Use the Menu System: Open a Submenu** for more information.*

CONTRAST 3
1 5

Contrast *(PiranhaMAX 165, 175, and 176i models only)*

Settings: 1 to 5; Default = 3, Setting Saved in Memory





Contrast accents the light and dark parts of the sonar data to provide greater definition.

FISH ID +
ON

Fish ID+™ *(Sonar View only)*

Settings: On, Off; Default = On, Setting Saved in Memory

Fish ID+™ uses advanced signal processing to interpret sonar returns, and will display a Fish Symbol when very selective requirements are met. To turn on fish symbols, select On. A select number of possible fish returns will be displayed with their associated depth. To turn off fish symbols so that only raw sonar returns are displayed on the view, select Off.

Single Beam	 Raw Sonar, Fish ID+™ Off	 19 200 kHz Fish ID+™ On
Dual Beam	 Raw Sonar, Fish ID+™ Off	 19 200/455 kHz Fish ID+™ On

NOTE: Returns from the 200 kHz beam and the 455 kHz beam are shown with shaded fish symbols.

BOTTOM VIEW
INVERSE

Bottom View *(Sonar View only)*

Settings: PiranhaMAX 165, 175, and 176i: Structure ID, Black, WhiteLine, Inverse; PiranhaMAX 195c and 196ci: Structure ID, WhiteLine; Default = Structure ID, Setting Saved in Memory

Bottom View selects the method used to represent the bottom and structure on the display.

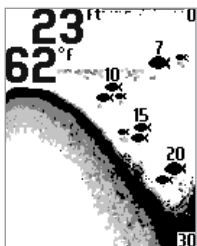

Structure ID[®] represents weak returns as light pixels and strong returns as dark pixels. This has the benefit of ensuring that strong returns will be clearly visible on the display.



Black (Bottom Black [monochrome models only]) displays all pixels below the bottom contour as black, regardless of signal strength. This has the benefit of providing a high contrast between the bottom and other sonar returns on the display.

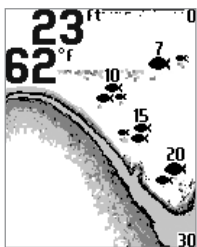

WhiteLine[™] highlights the strongest sonar returns in white resulting in a distinctive outline. This has the benefit of clearly defining the bottom on the display.

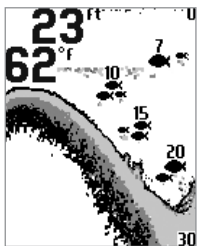

Inverse (monochrome models only) is a method where weak returns are shown with dark pixels and strong returns with lighter pixels. This has the benefit of ensuring that weak signals will be clearly visible on the display.



Reset

Settings: Select **CONFIRM** and press the **CHECK/ENTER** key to activate.

Use this menu choice with caution!

Reset restores **ALL** menu settings to their factory defaults.

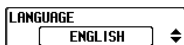

Language *(International Models only)*

Settings Vary; Default = English, Setting Saved in Memory

Language selects the display language for menus.

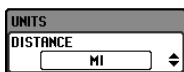

Units - Distance *(Units submenu)*

Settings: Domestic Models: Miles (MI), Nautical Miles; International Models: Nautical Miles, Kilometers, Miles (MI); Default = Miles/Kilometers, Setting Saved in Memory

Units - Distance selects the units of measure for all distance-related readouts.

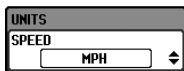

Units - Speed *(Units submenu)*

Settings: Domestic Models: MPH, Knots (KTS); International Models: MPH, Knots (KTS), KPH; Default = MPH/KPH, Setting Saved in Memory

Units - Speed selects the units of measure for speed-related readouts.

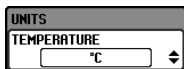

Units - Temperature

(International Models only, Units submenu)

Settings: °C (Celsius), °F (Fahrenheit); Default = °C (Celsius), Setting Saved in Memory

Units - Temperature selects the units of measure for all temperature-related readouts.

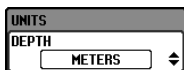

Units - Depth *(International Models only, Units submenu)*

Settings: Feet, Meters, Fathoms; Default = Meters, Setting Saved in Memory

Units - Depth selects the units of measure for all depth-related readouts.

Views

The sonar and navigation information from your Fishfinder are displayed on the screen in a variety of easy-to-read views.

- **Default View:** When you first power up the control head, Sonar View will be the default view.
- **Available Views:** The available views on your PiranhaMAX unit will vary with the model. See the following pages for more information.

Display a View

Use the instructions below to select a view to display on your PiranhaMAX control head.

To Display a View:

1. Press the POWER/MENU key.
2. Press the UP or DOWN Arrow key to select VIEW and press the CHECK/ENTER key.
3. Select a view and press the CHECK/ENTER key.

Status View

Status View displays current data, including the unit model number, serial number, and battery status.

- **PiranhaMAX models that include GPS** will also display GPS data, such as GPS Fix, latitude and longitude, average satellite strength (CNO Avg.), and HDOP (the Horizontal Dilution of Precision). HDOP is a GPS system parameter which depends on the current satellite configuration.
- **Status Menu:** From the Status Menu, you can change the view displayed on-screen. See *Views* for more information.

Status View (PiranhaMAX 176i)

STATUS	
MODEL	176i
SERIAL	96385990205
BATTERY	13.2v
GPS FIX	30
HDOP	10.00
CNO AVG	35
NORTH	31.84616°
WEST	085.14693°

Sonar View

Sonar View presents a historical log of sonar returns. The most recent sonar returns are charted on the right side of the display. As new information is received, the historical information scrolls left across the display.

- **Upper and Lower Depth Range numbers** indicate the distance from the surface of the water to a depth range sufficient to show the bottom.
- **Sensitivity:** Press the UP or DOWN Arrow keys to adjust the Sensitivity. (See *Sonar Menu: Sensitivity*)
- **Zoom:** See *Sonar Menu: Zoom* to adjust the magnification of the view. The **Zoom Level**, or magnification, will be displayed on the screen.
- **Sonar Menu:** To access related Sonar and Setup menu options, see *Sonar Menu*.
- **Mark Waypoints (PiranhaMAX 176i and 196ci only):** Press the CHECK/ENTER key to mark the current position of the boat as a waypoint. Waypoints are saved in numerical order.

NOTE: Waypoints are saved to the unit even after it is powered off. Tracks are not saved after the unit is powered off.

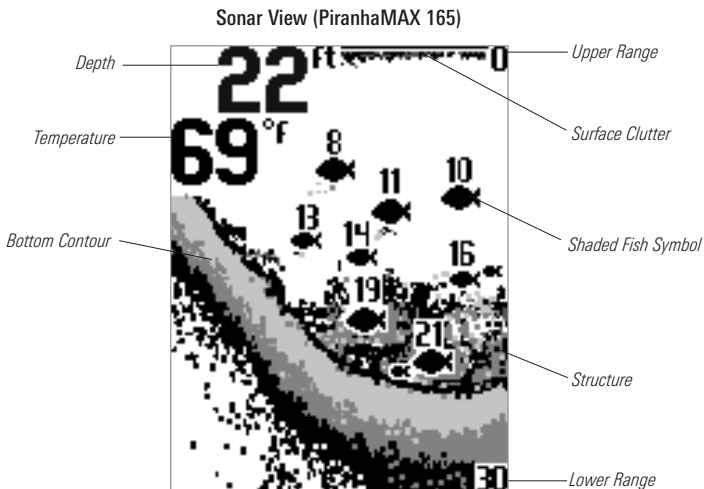

Sonar Menu

Sonar Menu provides a shortcut to your most frequently-used settings in Sonar View. Sonar View must be displayed on the screen in order to open the Sonar Menu.

From the Sonar Menu you can perform the following:

- **Customize the Sonar View Display:** Set the Depth Range, Chart Speed, Zoom level, etc.

NOTE: Menu options are determined by your Humminbird® model. See the following pages for full menu descriptions.

- **Access Sonar Setup Menu Options:** Open the Setup submenu to set the Contrast, Bottom View, and Fish ID+™ settings. See ***Set Up the Control Head*** for full menu descriptions.
- **Set Sonar Alarms:** Open the Alarms submenu to set sonar alarms, such as Depth and Fish ID. See ***Alarms*** for more information.

To Open the Sonar Menu:

1. With the Sonar View on-screen, press the POWER/MENU key once to open the Sonar Menu.

*NOTE: See ***How to Use the Menu System*** for more information.*

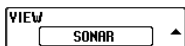

View

Settings: Sonar, Track (PiranhaMAX 176i and 196ci only), Status;
Default = Sonar

View selects a view to be displayed on the screen.



Depth Range

Settings: Auto, 15 ft - 600 ft, 5 m - 184 m (International Models
only); Default = Auto

Depth Range sets the deepest depth range that will be displayed by the unit.

Auto: When in automatic, the lower range will be adjusted by the unit to follow the bottom.

Manual: You can adjust the Depth Range to lock the unit on a particular depth.

NOTE: In manual operation, if the depth is greater than the depth range setting, the bottom will not be visible on the display. Select AUTO to return to automatic operation.

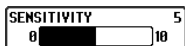

Sensitivity

Settings: 0 - 10; Default = 5, Setting Saved in Memory

Sensitivity controls how much detail is shown on the display.

Increasing the sensitivity shows more sonar returns from small baitfish and suspended debris in the water; however, the display may become too cluttered. When operating in very clear water or greater depths, increased sensitivity shows weaker returns that may be of interest.

Decreasing the sensitivity eliminates the clutter from the display that is sometimes present in murky or muddy water. If Sensitivity is adjusted too low, the display may not show many sonar returns that could be fish.

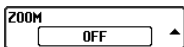

Zoom

Settings: Off, Auto, Manual Ranges; Default = Off

Zoom provides a magnified view of the bottom and structure.

Auto: Select Auto to magnify the area around the bottom in order to reveal fish and structure close to the bottom that may not be visible during normal operation. When ZOOM is set to Auto, the upper and lower Depth Ranges are automatically adjusted to keep the area above and below the bottom on the display. Select Off to return to normal operation.

Manual: There is also a series of manual ranges which can be selected. The manual depth ranges are determined by the present depth conditions.

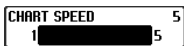
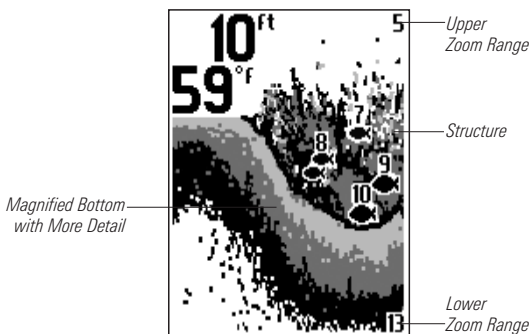
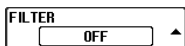

Chart Speed

Settings: 1 - 5, where 1 = Slow, 5 = Fast; Default = 5, Setting Saved in Memory

Chart Speed determines the speed at which the sonar information moves across the display, and consequently the amount of detail shown.

A **faster** speed shows more information and is preferred by most anglers; however, the sonar information moves across the display quickly. A **slower** speed keeps the information on the display longer, but the bottom and fish details become compressed and may be difficult to interpret.



Filter

Settings: On, Off; Default = Off, Setting Saved in Memory

Filter adjusts the sonar filter to limit interference on the display from sources such as your boat engine, turbulence, or other sonar devices.

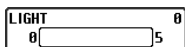

Light

Settings: 0 - 5; Default = 0

Light adjusts the brightness of the display. Use a higher backlight setting for night fishing.

NOTE: Continuous backlight operation will significantly decrease the battery life for PiranhaMAX Portables.

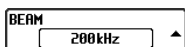

Beam Select

Settings: PiranhaMAX 165: 200 kHz; PiranhaMAX 175, 176i, 195c, and 196ci: 200 kHz, 455 kHz; Default = 200 kHz

Beam Select sets which sonar returns from the transducer will be displayed on the screen. The available beam frequencies are determined by your PiranhaMAX model.

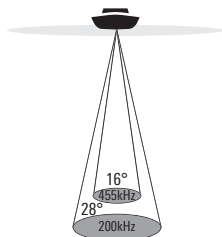

- When set to 200 kHz, only the returns from the 200 kHz (28°) wide beam will be displayed in the Sonar View.
- When set to 455 kHz, only the returns from the 455 kHz (16°) narrow beam will be displayed in the Sonar View.

❖ 28 Degree Total Coverage

❖ Bottom Coverage = 1 x Depth



Track View *(PiranhaMAX 176i and 196ci only)*

Track View displays the current track (also known as the position history or breadcrumb trail) showing where the boat has been, along with saved waypoints.

- **Digital Readouts:** The digital readouts in this view are fixed.
- **Zoom:** Press the UP and DOWN Arrow keys to adjust the scale of the view. The zoom scale will be displayed on the screen. (See **Track Menu: Zoom**)
- **Mark Waypoints:** Press the CHECK/ENTER key to mark the current position of the boat as a waypoint. Waypoints are saved in numerical order.
NOTE: Waypoints are saved to the unit even after it is powered off. Tracks are not saved after the unit is powered off.
- **North-Up:** True North is shown at the top of the display.
- **COG (Course Over Ground) Vector** displays the projected path of the boat. See **Track Menu: COG Vector** to turn this option on or off.
- **Track Menu:** To access related Track and Setup menu options, see **Track Menu**.

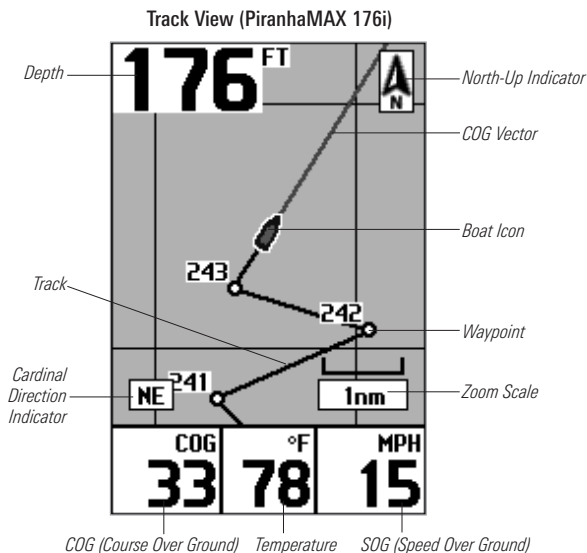

Track Menu *(PiranhaMAX 176i and 196ci only)*

Track Menu provides a shortcut to your most frequently-used settings in Track View. Track View must be displayed on the screen in order to open the Track Menu.

From the Track Menu you can perform the following:

- **Customize the Track View Display:** Turn the COG Vector on or off, delete waypoints, start a new track, etc.

NOTE: Menu options are determined by your Humminbird® model. See the following pages for full menu descriptions.

- **Access Control Head Settings :** Open the Setup submenu to change display settings on your control head (see ***Set Up the Control Head***). To set alarms for your control head, open the Alarms submenu (see ***Alarms***).

To Open the Track Menu:

1. With the Track View on-screen, press the POWER/MENU key once to open the Track Menu.

*NOTE: See ***How to Use the Menu System*** for more information.*

View

Settings: Sonar, Track, Status; Default = Sonar

View selects the current view displayed on the screen.

Zoom

Settings: Off, Manual Ranges; Default = Off

Zoom adjusts the scale of the Track View. The zoom scale is indicated on the display as you adjust the setting.

COG Vector

Settings: Off, On; Default = On

COG (Course Over Ground) Vector displays a line, extending from the bow of the boat, that projects your current course and shows where the boat will go if you continue on your present course.

Clear Track

Settings: Select CONFIRM and press the CHECK/ENTER key to activate.

Clear Track deletes the current track on the display and starts a new track at the current position.

Delete

Settings: See details below.

Delete erases a saved waypoint from the control head. Waypoints are saved in numerical order. To delete a saved waypoint, use the UP and DOWN Arrow keys to select the waypoint you want to delete and press the CHECK/ENTER key.

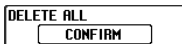

Delete All

Settings: Select **CONFIRM** and press the **CHECK/ENTER** key to activate.

Use this menu choice with caution!

Delete All allows you to delete all saved waypoints at one time.



Light

Settings: 0 - 5; Default = 0

Light adjusts the brightness of the display. Use a higher backlight setting for night fishing.

***NOTE:** Continuous backlight operation will significantly decrease the battery life for PiranhaMAX Portables.*

Alarms

Alarms are based on the limits you set for a device, such as battery voltage, depth, and more. Set the alarms that apply to your PiranhaMAX installation and configuration. See the Alarms table for a complete list of PiranhaMAX alarms.

To Set an Alarm:

1. Press the POWER/MENU key.
2. Select SETUP and press the CHECK/ENTER key.
3. Select ALARMS and press the CHECK/ENTER key.
4. Select an alarm and press the CHECK/ENTER key to activate the menu.
5. Press the UP or DOWN Arrow key to select an alarm setting.
6. Press the POWER/MENU key or the CHECK/ENTER key to confirm the selection.
7. **Close:** Press the POWER/MENU key until the menu system is closed.

***NOTE:** When an alarm is triggered, you can silence it by opening the Alarms menu and turning the alarm off.*

Menu	Alarm Name	Alarm Description	Range
Sonar Menu: Alarms	Mute	Mute controls the audible sound made when an alarm is triggered.	On, Off; Default = Off
	Battery	Battery Alarm sounds when the input battery voltage is equal to or less than the menu setting.	Off, 8.5V – 13.5V; Default = Off
	Fish	Fish Alarm sounds when the fishfinder detects fish that correspond to the alarm setting.	Off, All, Large/Medium, Large; Default = Off
	Depth	Depth Alarm sounds when the depth is equal to or less than the alarm setting.	Off, 3 – 99 feet or 1 – 30 meters*; Default = Off
Track Menu: Alarms (PMax 176i, 196ci only)	Mute	Mute controls the audible sound made when an alarm is triggered.	On, Off; Default = Off
	Battery	Battery Alarm sounds when the input battery voltage is equal to or less than the menu setting.	Off, 8.5V – 13.5V; Default = Off
	Depth	Depth Alarm sounds when the depth is equal to or less than the alarm setting.	Off, 3 – 99 feet or 1 – 30 meters*; Default = Off

* International models only.

Maintenance

Your Humminbird® fishfinder is designed to provide years of trouble free operation with very little maintenance. Use the following procedures to ensure your Humminbird® continues to deliver top performance.

Control Head Maintenance

It is important to consider the following precautions when using your Humminbird® control head:

- Chemicals, such as those found in bug spray and sunscreen, may cause permanent damage to the control head screen. Such damage is not covered by the warranty.
- NEVER leave the control head in a closed car or trunk. The high temperatures generated in hot weather can damage the electronics.

Use the following information to keep the control head and screen clean.

- **Screen:** To clean the control head screen, use a mild soap (such as a non-abrasive liquid hand soap) and warm water. Wipe the screen dry with a soft cloth. Be careful to avoid scratching the screen. If water spots remain, use a solution of water and vinegar.

***WARNING!** Do not use a chemical glass cleaner on the screen. Chemicals in the solution may cause cracking in the lens of the unit.*

***NOTE:** Do not wipe the screen while dirt or grease is on the screen.*

- **Control Head:** If the control head comes into contact with salt spray, wipe the affected surfaces with a cloth dampened with fresh water.

Transducer Maintenance

Use the following information to maintain the transducer operation.

- If your boat remains in the water for long periods of time, algae and other marine growth can reduce the effectiveness of the transducer. Periodically clean the face of the transducer with liquid detergent.

***NOTE:** To clean the transducer, you may need to pivot the transducer up in the bracket.*

- If your boat remains out of the water for a long period of time, it may take some time to wet the transducer when it is returned to the water. Small air bubbles can climb to the surface of the transducer and interfere with proper operation. These bubbles dissipate with time, or you can wipe the face of the transducer with your fingers after the transducer is in the water.

PiranhaMAX Portable Case Maintenance

- If the portable case comes into contact with salt spray, wipe the affected surfaces with a lint-free cloth, then apply a commercially available anti-corrosive treatment to all exposed electrical contacts.
- If the portable case bag becomes dirty, clean the bag with mild soap, water, and a soft rag or brush and then hang it up to dry.

How to Remove Water from the Portable Case

Open the front zipper and pull the case down to allow water to exit the case. If needed, remove the case from the plastic base and air-dry it. Follow recommended maintenance procedures for salt spray exposure if needed.

Troubleshooting

Do not attempt to repair the PiranhaMAX yourself. There are no user-serviceable parts inside, and special tools and techniques are required for assembly to ensure the waterproof integrity of the housing. Repairs should be performed only by authorized Humminbird® technicians.

Many requests for repair received by Humminbird® involve units that do not actually need repair. These units are returned “no problem found.” If you have a problem with your PiranhaMAX, use the following troubleshooting guide before calling the Customer Resource Center or sending your unit in for repair.

1. Nothing happens when I turn the unit on.

Check the power cable connection at both ends. Be sure the cable is connected correctly to a reliable power source — red lead to positive, black lead to negative or ground. Ensure the power available is between 10 and 20 VDC. If the unit is wired through a fuse panel, ensure the panel is powered. Often accessory fuse panels are controlled by a separate switch or the ignition switch.

Also, often a fuse can appear to be good when it is not. Check the fuse with a tester or replace it with a fuse known to be good.

Check the power connection to the PiranhaMAX. It is possible to force the power cable connector into the cable holder incorrectly. If the connector is reversed, the unit will not work. Examine the contacts on the back of the unit to ensure there is no corrosion.

2. There is no transducer detected.

The PiranhaMAX has the ability to detect and identify that a transducer is connected. When powering on, if a message indicates “transducer not connected”, make sure that an appropriate transducer connector is plugged into the unit. In addition, inspect the transducer cable from end to end for breaks, kinks, or cuts in the outer casing of the cable. Also make sure that the transducer is fully submerged in water. If the transducer is connected to the unit through a switch, temporarily connect it directly to the unit and try again. If none of these actions identifies an obvious problem, the transducer itself is probably at fault. Be sure to include the transducer if returning the unit for repair.

3. There is no bottom reading visible on the display.

If the loss of bottom information occurs only at high boat speeds, the transducer needs adjusting – see your PiranhaMAX Installation Guide for details. Also, in very deep water, it may be necessary to increase the sensitivity setting manually to maintain a graphic depiction of the bottom. If you are using a transducer switch to connect two transducers to the PiranhaMAX, make sure that the switch is in the correct position to connect a transducer that is in the water. (If a trolling motor transducer is selected and the trolling motor is out of the water, no sonar information appears.) If none of these actions solves

the problem, inspect the transducer cable from end to end for breaks, kinks, or cuts in the outer casing of the cable. If the transducer is connected to the unit through a switch, temporarily connect it directly to the unit and try again. If none of these actions identifies an obvious problem, the transducer itself may be at fault. Be sure to include the transducer if returning the unit for repair.

4. When in very shallow water, I get gaps in the bottom reading and inconsistent digital depth indication.

The PiranhaMAX will work reliably in water 3 feet (90 cm) or deeper. Remember that the depth is measured from the transducer, not from the surface of the water.

5. The unit comes on before I press the POWER-MENU key, and won't turn off.

Check the transducer cable — if the outer jacket of the cable has been cut and the cable is in contact with bare metal, you will need to repair the cut with electrical tape. If there is no problem with the cable, disconnect the transducer from the unit and see if the problem is corrected, to confirm the source of the problem.

6. I get gaps in the reading at high speeds.

Your transducer needs adjusting. If the transducer is transom-mounted, there are two adjustments available to you: height, and running angle. Make small adjustments and run the boat at high speeds to determine the effect. It may take several tries to optimize high-speed operation. This can also be a result of air or turbulence in the transducer location caused by rivets, ribs, etc.

7. My unit loses power at high speeds.

Your PiranhaMAX has over-voltage protection that turns the unit off when input voltage exceeds 20 VDC. Some outboard motors do not effectively regulate the power output of the engine's alternator and can produce voltage in excess of 20 Volts when running at high RPMs.

8. The display begins to fade out. Images are not as sharp as normal.

Check the input voltage. The PiranhaMAX will not operate on input voltages below 10 VDC.

9. The display shows many black dots at high speeds and high sensitivity settings.

You are seeing noise or interference caused by one of several sources. Noise can be caused by electronic devices. Turn off any nearby electronics and see if the problem goes away. Noise can also be caused by the engine. If engine noise is causing the interference, the problem will intensify at higher RPMs. Increase the engine speed with the boat stationary to isolate this cause. Propeller cavitation can also appear as noise on the display. If the transducer is mounted too close to the propeller, the turbulence generated can interfere with the sonar signal. Make sure that the transducer is mounted at least 15" (380 mm) from the propeller.

PiranhaMAX 165 Specifications

Depth Capability	600 ft (183 m)
Power Output	200 Watts (RMS) 800 Watts (PTP)
Operating Frequency	200 kHz Single Beam
Area of Coverage	28° @ -10 dB in 200 kHz
Target Separation	2 1/2 Inches (63.5 mm)
Power Requirement	10-20 VDC
LCD Matrix	240 V x 160 H
Transducer	XNT-9-28-T (includes built-in temperature probe)
Transducer Cable Length	20 ft (6 m)

NOTE: Product specifications and features are subject to change without notice.

NOTE: Humminbird® verifies maximum stated depth in saltwater conditions, however actual depth performance may vary due to transducer installation, water type, thermal layers, bottom composition, and slope.

PiranhaMAX 175/176i/195c/196ci Specifications

Depth Capability	.200 kHz Beam: 600 ft (183 m) 455 kHz Beam: 320 ft (98 m)
Power Output	.200 Watts (RMS) 1600 Watts (PTP)
Operating Frequency	.200 kHz and 455 kHz Dual Beam
Area of Coverage	.28° @ -10 dB in 200 kHz 16° @ -10 dB in 455 kHz
Target Separation	.2 1/2 Inches (63.5 mm)
Power Requirement	.10-20 VDC
LCD Matrix	.240 V x 160 H – (PiranhaMAX 175/176i) 320 V x 240 H – (PiranhaMAX 195c/196ci)
Transducer	.XNT-9-28-T (includes built-in temperature probe)
Transducer Cable Length	.20 ft (6 m)

NOTE: Product specifications and features are subject to change without notice.

NOTE: Humminbird® verifies maximum stated depth in saltwater conditions, however actual depth performance may vary due to transducer installation, water type, thermal layers, bottom composition, and slope.

Environmental Compliance Statement: *It is the intention of Johnson Outdoors Marine Electronics, Inc. to be a responsible corporate citizen, operating in compliance with known and applicable environmental regulations, and a good neighbor in the communities where we make or sell our products.*

WEEE Directive: *EU Directive 2002/96/EC "Waste of Electrical and Electronic Equipment Directive (WEEE)" impacts most distributors, sellers, and manufacturers of consumer electronics in the European Union. The WEEE Directive requires the producer of consumer electronics to take responsibility for the management of waste from their products to achieve environmentally responsible disposal during the product life cycle.*

WEEE compliance may not be required in your location for electrical & electronic equipment (EEE), nor may it be required for EEE designed and intended as fixed or temporary installation in transportation vehicles such as automobiles, aircraft, and boats. In some European Union member states, these vehicles are considered outside of the scope of the Directive, and EEE for those applications can be considered excluded from the WEEE Directive requirement.



This symbol (WEEE wheelee bin) on product indicates the product must not be disposed of with other household refuse. It must be disposed of and collected for recycling and recovery of waste EEE. Johnson Outdoors Marine Electronics, Inc.

■ *will mark all EEE products in accordance with the WEEE Directive. It is our goal to comply in the collection, treatment, recovery, and environmentally sound disposal of those products; however, these requirements do vary within European Union member states. For more information about where you should dispose of your waste equipment for recycling and recovery and/or your European Union member state requirements, please contact your dealer or distributor from which your product was purchased.*

Contact Humminbird®

Contact the Humminbird® Customer Resource Center
in any of the following ways:

By Telephone:

(Monday - Friday 8:00 a.m. to 4:30 p.m. Central Standard Time):

1-800-633-1468

By e-mail:

(typically we respond to your e-mail within three business days):

service@humminbird.com

For direct shipping, our address is:

Humminbird

Service Department

678 Humminbird Lane

Eufaula, AL 36027 USA



Free Manuals Download Website

<http://myh66.com>

<http://usermanuals.us>

<http://www.somanuals.com>

<http://www.4manuals.cc>

<http://www.manual-lib.com>

<http://www.404manual.com>

<http://www.luxmanual.com>

<http://aubethermostatmanual.com>

Golf course search by state

<http://golfingnear.com>

Email search by domain

<http://emailbydomain.com>

Auto manuals search

<http://auto.somanuals.com>

TV manuals search

<http://tv.somanuals.com>