



Product Guide

May 2010



IBM System x3620 M3

Product Overview

CONTENTS	
Product Overview	1
Selling Features	2
Key Features	4
Key Options	11
x3620 M3 Images	13
x3620 M3 Specifications	14
The Bottom Line	17
Server Comparison	18
For More Information	19
Legal Information	19

Cost-effective 2U storage server packed with innovation

Suggested Uses: Departmental and file/print servers, online gaming, messaging, video/photo sharing, email, transaction processing, blog hosting, and search engines; for large enterprise, mid-market, SMBs, and emerging markets.

In today's tough economic environment, your challenge is to do more with less—serve more Web pages, handle more secure connections, support more e-mail users, and do it all on a tight budget. You need to reduce the costs of doing business and improve the service you deliver to your customers while lowering your overall risk. The **dual-socket IBM® System x3620 M3** can reduce your costs with its new energy-smart design and budget-conscious features. It can improve service with reduced operational complexity and increased management functionality. It can lower your IT risk with the resiliency that comes from hot-swap/redundant features. And like all IBM servers, the x3620 M3 offers you the trust that comes from the IBM global reach, service and support.

The x3620 M3 is a game-changing rack server that uses significantly less power than previous generations, with unified systems management tools; high reliability, availability, and serviceability features; and broad system flexibility, housed in a compact 2U mechanical package.

The x3620 M3 features **Intel® Xeon® 5600 Series 6-core and 4-core**, and **5500 Series 4-core** processors, with up to **12MB** of shared **L3 cache**, to provide you with the computing power you need to match your business needs and growth. The new line of Intel processors delivers unprecedented intelligent performance with features like adaptive performance for applications and environments, Turbo Boost Technology and Hyper-Threading Technology, and integrated power gates and automated power management.

The x3620 M3 supports up to **12 DIMMs / 96GB** of RDIMM **1333MHz DDR3** memory and provides **Chipkill™ ECC** (Error Checking and Correcting) protection—for high performance and reliability. For even higher levels of availability, the x3620 M3 also offers **memory mirroring**. **Two** integrated high-speed **Gigabit Ethernet** ports are included, as are **three** high-performance **PCIe** adapter slots. The x3620 M3 offers an optional **embedded hypervisor** to manage your virtual workloads.

Some System x3620 M3 models support up to **8 hot-swap 3.5-inch Serial-Attached SCSI (SAS)** or **Serial-Attached ATA (SATA)** HDDs with an internal storage capacity of **16TB**. Other models support up to **4 simple-swap SATA drives**, with a storage capacity of up to **8TB**. The server includes *firmware* RAID-0/1 standard, and offers a choice of several IBM ServeRAID® storage controllers that provide broad levels of *hardware*-based **RAID solutions**. To meet your backup needs, the x3620 M3 supports a choice of internal **tape drives**, as well as the internal **RDX Removable Disk Backup System**.

The ultra-dense **2U** form factor allows businesses to increase their computing power and spread their workload without outgrowing their current data center. Up to 21 of these **2U** servers can be installed in a single 42U rack, for a total of up to **42** processors, **252** processor cores (and **504** threads), offering tremendous deployment flexibility.

Standard in the x3620 M3 is the **Integrated Management Module (IMM)** that enables the user to manage and control the server easily—both locally and remotely. The IMM offers a high level of manageability that is designed to keep costs down and the system up—even when network usage increases. The IMM helps maximize network availability by increasing uptime, as do **Active Memory™** protection, **hot-swap/redundant SAS or SATA** HDDs, hot-swap/redundant ultra-efficient **power supplies** and redundant **fan modules**; integrated **RAID**; **temperature-controlled fans**; **IPMI 2.0** support, including **highly secure remote power control** and **Serial over LAN**; as well as **text-console redirect over LAN**.

Another improvement with the new generation of X-Architecture is the replacement of old BIOS with a new generation **Unified Extensible Firmware Interface (UEFI)**. UEFI provides a more intuitive user interface and understandable event logs and better management.

With the inclusion of unique IBM service and support features such as the IMM, **IBM Systems Director 6.1**, **IBM Systems Director Active Energy Manager™**, **IBM ToolsCenter**, **IBM ServerGuide™**, and support for the optional Virtual Media Key for remote presence capability, the x3620 M3 is designed for superior uptime.

If you need highly manageable, dual-socket/multi-core computing power in a budget rack-dense package, the x3620 M3 is the ideal system.

Selling Features

Price/Performance

The x3620 M3 offers numerous features to boost performance and reduce costs:

- Up to **two 6-core** or **4-core** Xeon 5600 Series or **4-core** Xeon 5500 Series processors and **12MB** or **4MB** of cache per processor, offer superior performance capable of tackling the toughest jobs. **64-bit extensions** provide the flexibility to run 32-bit and 64-bit applications concurrently. Xeon 5600 series processors offer up to **43%** better performance than the previous-generation 5500 series processors (depending on workload).
- **Low-voltage processors** (available via the Configure To Order process) draw less energy and produce less waste heat than high-voltage processors, thus helping to reduce data center energy costs. Selected **4-core** Xeon 5600 Series processors use only **40W** and selected **6-core** processors consume only **60W**. This is less than half the wattage consumed by 130W processors.
- **Twelve** DIMMs of registered **1333MHz DDR3** ECC memory with **Chipkill¹** protection (optional) provide speed, high availability, and a memory capacity of up to **96GB**.
- x3620 M3 servers using the **L5640** (via CTO) and **X56xx** processors support 2 DIMMs per channel (2DPC) at 1333MHz (using 1.5V DIMMs).
- **Two x8** ("by 8") **PCIe Gen 2** and **one x4 PCIe Gen 2 adapter slot** offer investment protection by supporting high-performance adapters, such as 10Gb Ethernet, Fibre Channel and InfiniBand cards, none of which will run in older 33MHz and 66MHz conventional PCI slots.
- The optional integrated **3Gbps ServeRAID-BR10i v2** controller, or the **6Gbps ServeRAID-M1015**, **ServeRAID-M5014**, or **ServeRAID-M5015** controller, provide high-performance RAID support for SAS/SATA drives.
- Up to **8 3.5-inch hot-swap SAS/SATA** hard disk drives offer high-performance and high capacity, with high availability. Up to **4 3.5-inch simple-swap SATA** drives offer high capacity and quick servicing
- The integrated **dual-port Gigabit Ethernet** controller with **IPMI 2.0** provide high-speed network communications.
- A **high degree of device integration**—including hot swap SAS/SATA HDDs, multiple hardware-based ServeRAID options, Gigabit Ethernet ports, systems management and video controllers—lowers costs and frees up valuable adapter slots.

Flexibility

The x3620 M3 has the ability to grow with your application requirements, thanks to

- A choice of **4-core** or **6-core** processors with **2.13** to **2.66GHz** clock rates, up to **6.4 gigatransfers per second**, and **80W** or **95W** maximum power draw. (Two additional choices, **40W** and **60W**, are available via CTO.)
- A choice of either standard **1.5V** DIMMs, or **1.35V** DIMMs² that consume **20%** less energy.
- Up to **96GB** of high-speed registered **DDR3** system memory.
- **Three available high-performance PCIe** adapter slots in all models.
- Upgrading to one of several **ServeRAID** controllers provides up to **512MB** of battery-backed cache to enable higher-performance hardware RAID support, and allows the x3620 M3 to offer **five** RAID levels standard: **RAID-0/1/10/5/50** (and optionally **6/60** with **Self-Encrypting Disk**).
- The **five USB 2.0** ports (two front, two rear, one internal) are up to **40X** faster³ than older **USB 1.1** ports. This provides speedy access to external HDDs (non-arrayed), optical drives, tape drives, and other USB devices. Two ports are on the front of the unit and two are on the back. The internal port supports an internal tape or IBM RDX Removable Disk Backup System, and a flash drive with embedded hypervisor can be support via another internal USB port.
- A choice of up to **eight 3.5-inch hot-swap SAS/SATA** HDDs or **four 3.5-inch simple-swap SATA** drives and **one** internal tape drive or RDX Removable Disk Backup System, offer a variety of storage options. The **SATA** models provide a maximum of **16.0TB** of internal storage, while the **SAS** models support up to **4.8TB**.

¹ All models require Chipkill-enabled DIMMs (provided standard) for Chipkill protection.

-
- Alternatively, direct-attach, network-attached storage (NAS), or iSCSI or Fibre Channel-attached storage can be attached using IBM **System Storage**[®] servers.
-

Manageability / Security

Powerful systems management features simplify local and remote management of the x3620 M3:

- The x3620 M3 includes an **Integrated Management Module (IMM)** to monitor server availability, perform Predictive Failure Analysis, etc., and trigger IBM **Systems Director** alerts. The IMM performs the functions of both the Baseboard Management Controller (**BMC**) of earlier systems and the advanced **Remote Supervisor Adapter II** and is upgradeable to **remote presence/cKVM**.
- An optional **Virtual Media Key** provides additional systems management capabilities, including Web-based out-of-band control; virtual floppy and optical drive support; Windows “blue screen” error capture; LDAP and SSL support; and remote redirection of keyboard, PCI video and text, and mouse (cKVM). And it does all this without consuming a valuable adapter slot.
- **Text Console Redirection** support allows the administrator to remotely view x3620 M3 text messages over Serial or LAN.
- Integrated industry-standard Unified Extensible Firmware Interface (**UEFI**) next-generation BIOS. New capabilities include:
 - Human readable event logs — no more beep codes
 - Complete out-of-band coverage by the Advance Settings Utility to simplify remote setup
 - A complete setup solution, allowing adapter configuration functions to be moved into UEFI
 - Consistent firmware management across an entire product line
- Industry-standard **AES NI** support for faster, stronger encryption (in 5600 Series processors only).
- Integrated **IPMI 2.0** support alerts IBM Systems Director to anomalous environmental factors, such as voltage and thermal conditions. It also supports **highly secure remote power control** using data encryption.
- **IBM Systems Director 6.1x** is included for proactive systems management. IBM Systems Director comes with a portfolio of tools, including **IBM Systems Director Active Energy Manager**, **IBM Service and Support Manager**, and others. In addition, IBM Systems Director offers extended systems management tools for additional server management and increased availability. When a problem is encountered, IBM Systems Director can issue administrator alerts via e-mail, pager, and other methods.
- **IBM Systems Director Active Energy Manager**, an IBM-exclusive, is designed to take advantage of new system power management features, by providing actual realtime energy monitoring and reporting features.

Availability and Serviceability

The System x3620 M3 provides many features to simplify serviceability and increase system uptime:

- x3620 M3 servers offer **Chipkill** ECC memory protection⁴ (when using x4 DIMMs). Chipkill memory is up to **16X** better than standard ECC memory at correcting memory errors. This can help reduce downtime caused by memory errors.
- The x3620 M3 offers **memory mirroring** for redundancy in the event of a non-correctable memory failure
- **Toolless cover removal** provides easy access to upgrades and serviceable parts. Similarly, the Virtual Media Key and the **ServeRAID** controller can be installed and replaced without tools. This means less time (and therefore less money) spent servicing the x3620 M3. Additionally, **hot-swap/redundant HDDs** and **power supplies, redundant fan modules**, as well as **mirrored** memory, mean greater system uptime while these components are being serviced.
- The **external LED panel** and helps to quickly lead the technician to failed components. This simplifies servicing, speeds up problem resolution and helps improve network availability.
- **Optional integrated 3Gbps or 6Gbps** RAID controller to enhance system availability and data protection without using a PCIe slot.
- **IPMI 2.0** supports highly secure remote system power control using data encryption. This

² 1.35V DIMMs available in Q3/10.

³ Data transfer rates may be less than the maximum possible.

⁴ Chipkill protection is supported with x4 DDR3 DIMMs, but not x8 DIMMs.

allows an administrator to restart a server without having to visit it in person, saving travel time and getting the server back up and running quickly and securely. It also adds new features to those provided by IPMI 1.5, including **VLAN** support, **Serial over LAN**, enhanced authentication and encryption algorithms (**RMCP+** and **AES**) and a **firmware firewall**.

- **Temperature-controlled fans** adjust to compensate for changing thermal characteristics. At the lower speeds they draw less power and suffer less wear. Equally important in a crowded data center, temperature-controlled fans produce less ambient noise in the data center than if they were constantly running at full speed.
- The **three-year (parts and labor) limited onsite warranty**⁵ helps afford you peace of mind and greater investment protection than a one-year warranty does.

Key Features



High-Performance / High-Efficiency Xeon 5600 / 5500 Processors

The x3620 M3 supports up to two high-performance Intel **Xeon 5600 Series** or **5500 Series** processors, allowing you to upgrade to a second processor as your business needs require. The x3620 M3 offers a choice of processor clock rates, memory access speeds and energy draw, including:

- **95W 6-core Xeon 5600 models X5650** running at 2.66GHz with reduced power draw and impressive performance/watt (only **15.83W** per core; **6.4GTps** QPI speed), **12MB** of L3 processor cache, **1333MHz** memory access, 2 threads per core, and Intel Turbo Boost and Hyper Threading technology
- **80W 4-core Xeon 5600 models E5620 or E5630** running at 2.4 or 2.53GHz, respectively, with reduced power draw and impressive performance/watt (**20W** per core; **5.86GTps** QPI speed), **12MB** of L3 processor cache, **1066MHz** memory access, 2 threads per core, and Intel Turbo Boost and Hyper Threading technology
- **80W 4-core Xeon 5500 models E5506 or E5507** running at 2.13 or 2.26GHz, respectively, with reduced power draw and impressive performance/watt (**20W** per core; **4.8GTps** QPI speed), **4MB** of L3 processor cache, and **800MHz** memory access

Also available, via configure-to-order (CTO):

- **60W 6-core Xeon 5600 low-voltage model L5640** running at 2.26GHz with low power draw and impressive performance/watt (only **10W** per core; **5.86GTps** QPI speed), and **12MB** of shared **L3** cache, **1333MHz** memory access, 2 threads per core, and Intel Turbo Boost and Hyper Threading technology (CTO only)
- **40W 4-core Xeon 5600 low-voltage model L5630** running at 2.13GHz, with extremely low power draw and amazing performance/watt (only **10W** per core; **5.86GTps** QPI speed), **12MB** of L3 processor cache, **1066MHz** memory access, 2 threads per core, and Intel Turbo Boost technology

With the Xeon 5500 and 5600 Series processors, Intel has diverged from its traditional Symmetric Multiprocessing (SMP) architecture to a Non-Uniform Memory Access (NUMA) architecture. The processors are connected through serial coherency links called QuickPath Interconnect (QPI). QPI is capable of 6.4, 5.6 or 4.8 GTps (gigatransfers per second), depending on the processor model.

4-core Xeon processors contain *four complete processor cores*. Each 5600 Series processor contains one **12MB L3** cache shared by all the cores. The shared cache is dynamically allocated among the cores as needed. The multiple cores appear to software as multiple physical processors. Four- and six-core processors offer considerably higher performance than a same-speed Xeon processor with 2 cores.

Turbo Boost Technology increases performance by translating the temperature, power and current head room into higher frequency. It will dynamically increase by 133MHz for short and regular intervals until the upper limit is met or the maximum possible upside for the number of active cores is reached. The maximum frequency is dependent on the number of active cores. The amount of time the processor spends in the Turbo Boost Technology state depends on the workload and operating environment, providing the performance you need, when and where you need it. For example, a **2.66GHz 6-core X5650** processor with **3-6** cores active can run the cores at **2.93GHz**. With only **one** or **two** cores active, the same processor can run those cores at **3.06GHz**. Similarly, a **2.4GHz 4-core E5620** processor can run at **2.53GHz** or even **2.66GHz**. When the inactive cores are needed again, they are dynamically turned back on and the processor frequency is adjusted accordingly.

In processors implementing **Intel Hyper-Threading Technology**, each core has two threads capable of running an independent process. Thus, a 6-core processor can run **12** threads

⁵ For terms and conditions or copies of the IBM Statement of Limited Warranty, call 800-772-2227 in the U.S. In Canada call 800-426-2255. Telephone support may be subject to additional charges. For warranties including onsite labor, a technician is sent after IBM attempts to resolve the problem remotely. International warranty service is available in any country in which this product is sold.

concurrently.

Intelligent Power Capability powers individual processor elements on and off as needed, to reduce power draw.

Execute Disable Bit functionality can help prevent certain classes of malicious buffer overflow attacks when combined with a supporting operating system.

Intel's **Virtualization Technology (VT)** integrates hardware-level virtualization hooks that allow operating system vendors to better utilize the hardware for virtualization workloads.

DDR3 Memory with Chipkill ECC Protection

The x3620 M3 ships with registered double data rate III (DDR3) memory and provides Active Memory features, including advanced **Chipkill** memory protection (using x4 DIMMs), for **up to 16X** better error correction than standard ECC memory. In addition to offering better performance than DDR2 or fully-buffered memory, DDR3 memory also uses less energy. DDR2 memory already offered up to 37% lower energy use than fully buffered memory. Now, a generation later, DDR3 memory is even more efficient, using up to **15% less energy** than DDR2 memory.

The x3620 M3 currently supports up to **96GB** of 1.5V **RDIMM** (registered DIMM) memory in **12** DIMM slots. The x3620 M3 also supports either standard **1.5V** DIMMs, or **1.35V** DIMMs that consume **20%** less energy. Redesign in the architecture of the Xeon 5500 and 5600 Series processors bring radical changes in the way memory works in these servers. For example, the Xeon 5500 and 5600 Series processors **integrate the memory controller inside the processor**, resulting in two memory controllers in a 2-socket system. Each memory controller has three memory channels. Depending on the type of memory, population of memory, and processor model, the memory may be clocked at **1333MHz**, **1066MHz** or **800MHz**.

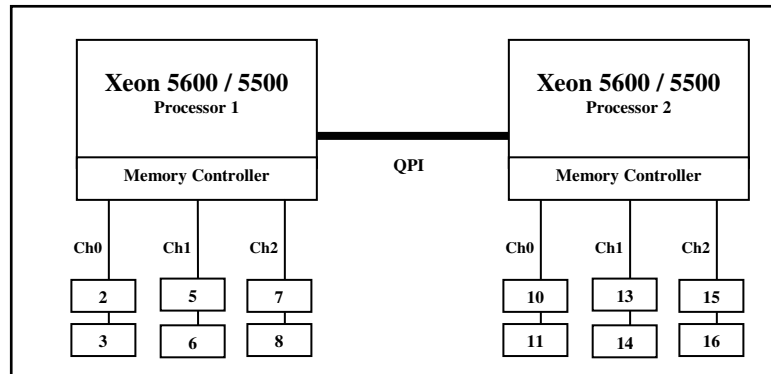
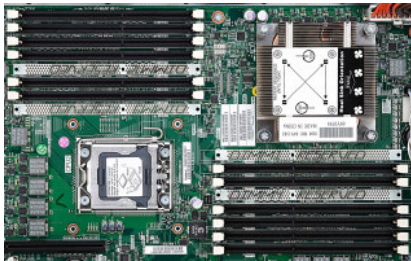
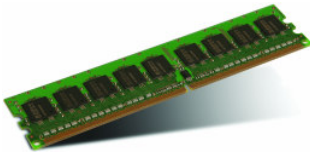

Notes: Adding a second processor not only doubles the amount of memory available for use, but also doubles the number of memory controllers, thus doubling the system memory bandwidth. If you add a second processor, but no additional memory for the second processor, the second processor would have to access the memory from the first processor "remotely," resulting in longer latencies and lower performance. The latency to access remote memory is almost **75% higher** than local memory access. So, the goal should be to always populate both processors with memory.

The **L5640** and **X56xx** processor models support up to 1333MHz memory clock speed. With new single-rank and dual-rank RDIMMs, **L5640** and **Xi56xx** processors support 2 DIMMs per channel (2DPC) at 1333MHz using 1.5V DIMMs. The **E562x**-and-up and **L56xx** models support a maximum of **1066MHz** clock speed (and thus memory access rate), and the **E550x** models support **800MHz** clock speed.

Running memory at 1333MHz (where supported) versus 1066MHz offers up to **9%** better performance, while memory running at 1066MHz produces up to **28%** better performance than memory running at 800MHz. Xeon 5500/5600 Series processors access memory with almost **50% lower latency** than the earlier 5400 Series processors. That can result in faster processing of latency-sensitive workloads.

Regardless of memory *speed*, the Xeon 5500/5600 platform represents a significant improvement in memory *bandwidth* over the previous Xeon 5400 platform. At 1333MHz, the improvement is almost **500%** over the previous generation. This huge improvement is mainly due to the dual integrated memory controllers and faster DDR3 1333MHz memory. Throughput at 800MHz is **25 gigabytes per second (GBps)**; at 1066MHz it's **32GBps**; and at 1333MHz it's **35GBps**. This improvement translates into improved application performance and scalability.

Memory interleaving refers to how physical memory is interleaved across the physical DIMMs. A balanced system provides the best interleaving. A Xeon 5500/5600 Series processor-based system is balanced when all memory channels on a socket have the same amount of memory.

The 5500 and 5600 Series processors support single-, dual-, and quad-rank memory. A memory rank is simply a segment of memory that is addressed by a specific address bit.

- A typical memory DIMM description is 4GB 2Rx4 DIMM
- The 2R designator is the rank count for this particular DIMM (2R = dual-rank)
- The x4 designator is the data width of the rank

It is important to ensure that DIMMs with the appropriate number of ranks are populated in each channel for optimal performance. Whenever possible, **use dual-rank DIMMs** in the system. Dual-rank DIMMs offer better interleaving and hence better performance than single-rank DIMMs. For instance, a system populated with six 2GB *dual*-rank DIMMs outperforms a system populated with six 2GB *single*-rank DIMMs by 7% for SPECjbb2005. Dual-rank DIMMs are also better than quad-rank DIMMs because **quad-rank DIMMs will cause the memory speed to be down-clocked**.

Another important guideline is to populate equivalent ranks per channel. For instance, **mixing one single-rank DIMM and one dual-rank DIMM in a channel should be avoided**.

Notes: It is important to populate all three memory channels in each processor. The relative memory bandwidth decreases as the number of channels populated decreases. This is because the bandwidth of all the memory channels is utilized to support the capability of the processor. So, as the channels are decreased, the burden to support the requisite bandwidth is increased on the remaining channels, causing them to become a bottleneck. If 1.5V and 1.35V DIMMs are mixed, *all* DIMMs will run at 1.5V.

In addition to Chipkill error correction, the x3620 M3 offers an additional level of IBM Active Memory protection: **memory mirroring**.

Memory mirroring works much like disk mirroring. The total memory is divided into three channels: a primary channel, a backup channel, and an unused channel. Data is *written concurrently to both the primary and backup channels*. If a DIMM fails in one of the DIMMs in the primary channel, it is instantly disabled and the mirrored memory in the backup channel becomes active (primary) until the failing DIMM is replaced. One-third of total memory is available for use at any one time with mirroring enabled. (**Note:** Due to the double writes to memory, performance is affected.) Because the third channel is disabled with mirroring active, there is no point in populating it with memory.

Mirroring is handled at the hardware level; no operating system support is required.

DDR3 memory is currently available in **1GB, 2GB, 4GB** and **8GB** RDIMMs. DIMMs can be installed individually (not in pairs). However, for performance reasons, in a 2-processor system, it's best to install a DIMM per processor.

Maximum memory capacity and speed in 2-processor configurations include:

Memory Frequency	DIMMs per Channel	Max. Memory Capacity	5600 Series	5500 Series
1333MHz	1 (6 DIMMs)	48GB RDIMM	X5650, L5640 and above	N/A
1333MHz	2 ⁶ (12 DIMMs)	96GB RDIMM	X5650, L5640 and above	N/A
1066MHz	2 (12 DIMMs)	96GB RDIMM	E5620, L5630 and above	N/A
800MHz	2 (12 DIMMs)	96GB RDIMM	N/A	E5506, E5507
800MHz-1333MHz	2 (8 DIMMs)	64GB RDIMM	All	All

Integrated Virtualization

All models of the x3620 M3 support a **USB 2.0 Flash Key** installed preloaded with **VMware ESXi 4.0**. ESXi is an embedded version of VMware ESX 4.0, fully contained on the flash drive and requiring no disk space—not an “ESX Lite.” Rather than management through a Service Console based on a Linux operating system, ESXi relies on aggregate management tools, including VirtualCenter, the Remote Command Line interface and the introduction of CIM for standards-based and agentless hardware monitoring.

⁶ 2 DIMMs per channel at 1333MHz is supported only with 1.5V RDIMMs.

VMware ESXi includes all the performance, scalability and compatibility features of ESX, including full **VMFS** support across FC SAN, iSCSI SAN, and NAS, and **4-way VSMP**. Because it runs from flash memory, it's extremely fast and ideal for diskless configurations. It also offers enhanced security, because it runs without an operating system-based console and is updated/patched much like firmware. Licensing works the same as for "standard" ESX.

Disk Controllers

The x3620 M3 **simple-swap** models include *firmware* RAID-0/1 (in other words, without hardware assist) standard, and support an optional **ServeRAID-BR10i v2**, **ServerRAID-M1015**, **ServerRAID-M5014**, or **ServerRAID-M5015** SAS/SATA controller, to enhance system performance, availability and data protection. **Hot-swap** models include either a **ServerRAID-M1015**, **ServerRAID-M5014**, or **ServerRAID-M5015** controller standard (model-specific). They can be upgraded to other ServeRAID controllers. The supported ServeRAID controllers include:

The 3Gbps⁷ (x4 PCIe) **ServerRAID-BR10i v2** controller offers hardware **RAID-0/1/1E** support (no cache) for up to 4 HDDs.

The **6Gbps (x8 PCIe) ServerRAID-M1015 SAS/SATA** controller supports **RAID-0/1/10** (no cache) for up to 16 drives (limited by available bays to 8). The **IBM ServeRAID M1000 Series Advance Feature Key** adds **RAID-5** with **SED** support.

The **6Gbps (x8 PCIe) ServerRAID-M5014 SAS/SATA** controller offers enhanced performance with **256MB** of cache memory (with optional battery backup), and supports **RAID-0/1/10/5/50** for up to 16 drives (limited by available bays to 8).

The **6Gbps (x8 PCIe) ServerRAID-M5015 SAS/SATA** controller offers enhanced performance with **512MB** of cache memory and battery backup included, and supports **RAID-0/1/10/5/50** for up to 16 drives (limited by available bays to 8).

The **IBM ServeRAID M5000 Series Advance Feature Key** adds **RAID-6/60** with **SED** support to the ServeRAID-M5014 and M5015. The **IBM ServeRAID M5000 Series Battery Key** adds **battery backup** support to the M5014.

Drive Bays

The x3620 M3 supports up to **9** or **5** drive bays in all (model-specific). Models include either **8 hot-swap** or **4 simple-swap 3.5-inch** drive bays, plus **one 5.25-inch** bay for either an optional **optical** drive, a **tape drive**, or an **RDx Removable Disk Backup System**. The hot-swap bays support either SATA or SAS HDDs. The simple-swap bays support only SATA drives.

Hot-swap drives may be inserted or removed through the front of the server without powering off the system. **Simple-swap** drives can be inserted or removed through the front of the server as well; however, the system power must first be turned off.

For additional storage, a direct-attach, NAS or SAN external expansion option can be added, using an optional controller.

No diskette drive is supplied with any model; an external USB floppy drive may be used, if needed.

Flexible Internal Storage

The x3620 M3 offers flexibility with either **4** or **8 2.5"** HDD bays (model-dependent), supporting high-performance drives that provide high density/high reliability and allow you to scale up as your business grows. (Hot-swap models require a RAID controller.)

3.5-inch Hot-Swap SAS

- **15,000 RPMs** — 300, 450, or **600GB (4.8TB)** maximum capacity, with **8** bays

3.5-inch Hot-Swap SATA

- **7,200 RPMs** — 250 or 500GB, 1 or **2TB (16.0TB)** maximum capacity, with **8** bays

3.5-inch Simple-Swap SATA

- **7,200 RPMs** — 250 or 500GB, 1 or **2TB (8.0TB)** maximum capacity, with **4** bays

The hot-swap drives use the Converged Tray for interchangeability with other IBM System x[®] systems. If you need more storage space, terabyte capacities are possible with external IBM System Storage direct-attach, NAS and SAN offerings.



⁷ Data transfer rates depend on many factors and are often less than the maximum possible.



High-Performance Adapter Slots

The x3620 M3 provides **three PCIe** (PCI Express) **Gen 2** I/O slots for long-term investment protection. **PCI Express** Gen 2 is the next-generation of high-performance, low-latency, serial I/O bus. Each slot is capable of supporting Gen 1 or Gen 2 adapters.

- One **x16/x8** (x16 physical/x8 electrical) **full-height, half-length (8Gbps)**
- One **x8/x8** (x8 physical/x8 electrical) **full-height, half-length (8Gbps)**
- One **x16/x4** (x16 physical/x4 electrical) **low profile (4Gbps)** — for ServeRAID cards, only

Dual-Port Gigabit Ethernet Controller

The x3620 M3 includes **one dual-port** integrated **Intel 82575** Gigabit Ethernet controller standard, for up to 10X higher maximum throughput than a 10/100 Ethernet controller and failover support.

The controller also supports **IPMI 2.0**, plus **Wake on LAN®** and **PXE** (Preboot Execution Environment) flash interface. Optional PCI adapters offering failover and load balancing between adapters are available for added throughput and increased system availability.

10 Gigabit Ethernet Integrated Virtual Fabric Adapter for IBM

The Emulex Virtual Fabric Adapter (part number 49Y4200 with special riser card, supported by CTO) is an industry-leading performance and scalability per watt, dual-port network adapter for 10Gbps Ethernet (10GbE) networks. It offers the benefits and flexibility of I/O convergence in a single end-to-end solution. Protocol offload for stateless TCP/IP and TCP Chimney provide maximum bandwidth with minimum use of CPU resources. It achieves line rate 10Gbps performance with support for TCP/IP stateless offloads and TCP Offload Engine (TOE) support. TOE reduces system processor utilization, providing increased system performance and reducing overall system power requirements.

The adapter is based on the Emulex OneConnect Universal Converged Network Adapter (UCNA) platform that also includes the capability for future upgrades to Fibre Channel over Ethernet (FCoE) and iSCSI protocol offloads. By using a common infrastructure for Ethernet and storage networks, data centers can reduce capital expense (CapEx) for adapters, switches and cables, and operational expense (OpEx) for power, cooling and IT administration.

End-to-end data protection with hardware parity, CRC, ECC and other advanced error checking and correcting ensure that data is safe from corruption.

Integrated dual 10Gbps Ethernet ports:

- IPv4/IPv6 TCP, UDP checksum offload; Large Send Offload (LSO); Large Receive Offload; Receive Side Scaling (RSS); IPV4 TCP Chimney Offload
- VLAN insertion and extraction
- Jumbo frames up to 9000 Bytes
- Preboot eXecutive Environment (PXE) 2.0 network boot support
- Interrupt coalescing
- Load balancing and failover support including adapter fault tolerance (AFT), switch fault tolerance (SFT), adaptive load balancing (ALB), teaming support and IEEE 802.3ad

Note: You must have either one SFP+ transceiver or one SFP+ direct-attached cable for *each* of the two 10Gb ports on the adapter.

Ultra-Efficient Cooling

Strategically located fans, combined with efficient airflow paths, provide highly effective system cooling for the x3620 M3. The base server with one power supply includes **four** fan modules, for redundant cooling. Each module includes **2** back-to-back fans with counter-rotating blades. In addition, each power supply also contains a fan.

The system contains **two cooling zones**. **Zone 1** (incorporating one fan module) cools the PCIe slots, **Zone 2** (three fan modules) cools both processors and all the DIMMs.

The fans automatically adjust speeds in response to changing thermal requirements depending on the zone and internal temperatures. When the temperature inside the server increases, the fans speed up to maintain the proper ambient temperature. When the temperature returns to a normal operating level, the fans return to their default speed.

Why not simply run the fans at 100% capacity all the time? For several good reasons: to reduce the ambient noise, reduce the wear-and-tear on the fans and reduce the server power draw. The reduction in ambient noise and power draw may be relatively minor for a single server, but put dozens or hundreds in a data center and it can make a big difference.

In addition, the server uses **hexagonal ventilation holes** in the chassis. Hexagonal holes can be

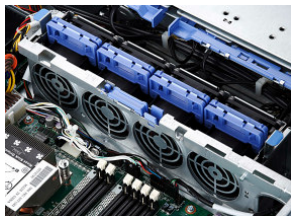

grouped more densely than round holes, providing greater airflow through the system cover.

This cooling scheme is important because newer, more powerful processors generate a significant amount of heat, and heat must be controlled for the system to function properly.

Hot-Swap/Redundant Components

System availability is maximized through the extensive use of hot-swap and redundant components, including:

- **Redundant memory protection** (with **Chipkill** protection, and **memory mirroring** enabled)
 - **Hot-swap, redundant hard disk drives** (with **RAID** protection)—model-specific
 - **Optional hot-swap, redundant power supplies**
-

Other Features

- **Five USB 2.0 ports** — Provides flexibility to add high-speed external devices. The USB 2.0 specification supports up to 480Mbps transfer rates. (**Note:** Not all USB 2.0 devices are capable of achieving this rate.) Two ports are provided on the front of the server, two on the back, plus one USB connector reserved for an internal tape drive, RDX Removable Disk Backup System, or USB flash memory key containing an embedded hypervisor is supported via another internal USB port. For pre-boot and normal drive use, use the external ports.
 - **Toolless slides** — Allows quick rack installation and quicker upgrade and servicing of the server.
 - **Toolless chassis** — The cover can be opened without tools, and many components can be removed and replaced without tools, including the CD-RW/DVD combo drive, hot-swap drives, and PCIe adapters, as well as the integrated ServeRAID card, embedded hypervisor key, and Virtual Media Key. This can save a servicer significant time.
-

Extensive System Support Features

The IBM services and technical support portfolio provides world-class, consistent, high-quality service and support. The x3620 M3 server offers a number of tools and services designed to make ownership a positive experience. From the start, IBM programs make it easier for you to plan for, configure and purchase System x or xSeries servers, get them running and keep them running long-term. These features include IBM Express Portfolio, IBM ServerProven[®], IBM Standalone Solutions Configuration Tool, IBM System x and BladeCenter Power Configurator, IBM ServerGuide, IBM Systems Director Service and Support Manager, Product Customization Services and extensive technical support offerings.



The IBM **ServerProven** program provides the confidence that specific options and operating systems have been tested on the server and are officially supported to work together. It is updated frequently to ensure that the latest compatibility information is always at your fingertips.

The IBM **Standalone Solutions Configuration Tool** (SSCT) is a downloadable tool that simplifies the often complex chore of configuring a full rack of servers (including blade servers) and confirming that you have all the cables, power distribution units, KVM (keyboard, video and mouse) switch boxes and other components you need, as well as the proper airflow clearances, electrical circuits and other environmental conditions.

IBM System x and BladeCenter Power Configurator helps IT managers plan for data center power needs, by providing the following information for specific configurations of System x and BladeCenter systems: *power input* (watts), *PDU sizing* (amps), *heat output* (BTUs), *airflow requirements through chassis* (CFM), *VA rating*, *leakage current* (mA), and *peak inrush current* (amps).

IBM ServerGuide (installed from CD) simplifies the process of installing and configuring System x and xSeries servers. ServerGuide goes beyond mere hardware configuration by assisting with the automated installation of the Microsoft Windows Server[®] 2003 and 2008 operating systems, device drivers and other system components, with minimal user intervention. (Drivers are also included for support of Novell NetWare, Red Hat Linux and SUSE LINUX.) This focus on deployment helps you reduce both your total cost of ownership and the complexity that administrators and technical personnel face.

IBM Systems Director Service and Support Manager (previously called IBM Electronic Service Agent[™]) is an innovative "call home" feature that allows System x and BladeCenter servers to automatically report hardware problems to IBM support, which can even dispatch onsite service if necessary to those customers entitled to onsite support under the terms of their warranty or an IBM Maintenance Agreement. Service and Support Manager resides on a server and provides electronic support and problem management capabilities through a highly secure electronic dialogue between your systems and IBM. It monitors networked servers for hardware errors and it can perform hardware and software inventories and report inventory changes to IBM. All information sent to IBM is stored in a highly secure database and used for improved problem

determination.

Additional services include hardware warranty upgrades and factory-installed **Product Customization Services** (PCS), such as asset tagging, hardware integration, software imaging and operating systems personalization.

IBM offers extensive **technical support** by phone and via the Web. Support options include links to forums/newsgroups, problem submission, online shopping support, service offerings, device drivers for all IBM product lines, software downloads and even upcoming technical seminar worldwide schedules and registration. Also available are remote installation, configuration and usage support for System x and xSeries hardware and software, as well as onsite custom services to provide the level of expertise you require.

IBM Maintenance and Technical Support solutions can help you get the most out of your IT investment by reducing support costs, increasing availability and simplifying management with integrated support for your multiproduct, multivendor hardware and software environment. For more information on hardware maintenance, software support, solution support and managed support, visit <http://ibm.com/services/maintenance>.

Advanced Systems Management Capabilities

The x3620 M3 has a high level of systems management capabilities that are well-suited to remote locations as well as to stand-alone environments. Features include UEFI, IMM, IBM ToolsCenter, IBM Systems Director Active Energy Manager, Automatic Server Restart, Wake on LAN® support, PXE support, text console redirect, Predictive Failure Analysis, and IBM Systems Director.

The **Integrated Management Module (IMM)** provides industry-standard **Intelligent Platform Management Interface (IPMI) 2.0**-compliant systems management. It provides a number of important system functions, including:

- Monitoring of system and battery voltage, system temperature, fans, power supplies, processor and DIMM status
- Fan speed control
- Product ID and Family ID detection
- Highly secure remote power on/off
- System reset control
- NMI/SMI detection and generation
- System diagnostic LED control (power, HDD, activity, alerts, heartbeat)
- IPMI over LAN
- Serial Over LAN
- Proxy server support
- LAN messaging and alerting
- Text console redirection over LAN
- Predictive Failure Analysis for system fans
- Web-based out-of-band control
- SSL (Secure Socket Layer) and LDAP (Lightweight Directory Access Protocol) support
- Enhanced authentication and encryption algorithms (RMCP+ and AES)
- VLAN support
- Local update of IMM firmware
- Firmware firewall
- Support for IPMI v2.0 compliant management software (e.g., xCAT)
- Other mandatory and optional IPMI IMM functions

The IMM alerts IBM Systems Director to anomalous environmental factors, such as voltage and thermal conditions—even if the server has failed.

The x3620 M3 also supports an optional IBM Virtual Media Key for additional systems management capabilities, including:

- Latest OS failure screen capture
- Graphical console redirection over LAN
- Remote virtual floppy and CD-ROM
- High-speed remote redirection of PCI video, keyboard and mouse

IBM **ToolsCenter** consolidates 42 needed tools for managing servers individually into an

integrated suite of 8 tools. They are organized by function: deployment, updates, configuration and diagnostics. Tools are now simpler to access and use with a single webpage for access, a common look and feel and a common command line interface for the scripting tools. The ToolsCenter **Bootable Media Creator** offers significantly more functionality than past tools with the ability to add more tools to the bootable image and to automatically download the bootable environment if needed. Bootable Media Creator allows you to create bootable CDs, DVD, and USB keys for updates customized to your systems.

IBM developed **IBM Systems Director Active Energy Manager** to put control of system power-saving features at the fingertips of administrators. Active Energy Manager is designed to take advantage of new features, such as monitoring power usage and balancing the performance of the system according to available power input. It provides the ability to plan and predict power consumption based on your hardware configuration. It also helps enable you to reduce the infrastructure required for redundancy, by using fewer servers on smaller power feeds and potentially lowering your overall data center support costs. It does this by inventorying all components, then adding up the total power draw and tracking the usage. It also includes power management features to help administrators manage or reduce power usage.

Automatic Server Restart (ASR) helps reduce downtime by restarting the server automatically in the event of a system lockup. ASR technology is a combination of hardware circuitry tied into the server's system reset function and a device driver. As long as the server continues running, the ASR watchdog timer will keep being reset, but if the operating system crashes or the hardware freezes somehow the ASR software will be unable to reset the hardware timer. If the timer is not reset within five minutes, it automatically triggers the ASR hardware, which immediately restarts the server (and logs an ASR event with IBM Systems Director). These features are designed so that *no more than five minutes can pass before the server is restarted*.

Wake on LAN permits the server to be remotely powered on if it has been shut off. Once powered up, the server can be controlled across the network, using the **Preboot Execution Environment (PXE)**.

Like Wake on LAN, PXE is system firmware. It enables software such as the optional **IBM Remote Deployment Manager** to take control of a system before the BIOS, operating system or applications are loaded (using Wake on LAN/PXE) and lets an administrator perform many low-level tasks remotely that would otherwise require a visit to each system. These tasks may include such things as formatting a hard disk drive, updating system firmware, or deploying a Windows or Linux operating system.

Text Console Redirection support allows the administrator to remotely view x3620 M3 text messages over serial or LAN. An optional upgrade to the Virtual Media Key adds graphical console redirection.

Predictive Failure Analysis (PFA) is designed to allow the system to detect impending failure of supported components (memory, HDDs, and the onboard battery) *before* actual failure, and alert the administrator through IBM Systems Director. This gives you the ability to *replace* the failing component *before* it fails, resulting in increased uptime.

IBM Systems Director software for advanced workgroup management is included with the x3620 M3. IBM Systems Director comes with a portfolio of tools, including **IBM Systems Director Active Energy Manager™**, **Service and Support Manager**, and others. *System Availability* (a no-charge download) and *Capacity Manager* (sold separately) are available as add-ons for additional server management and increased availability. IBM Systems Director provides a single uniform graphical interface for all of these systems management functions.

IBM Systems Director enables you to customize thresholds and monitor system components (for things like temperature, voltage regulation, etc.) to help maximize uptime.

Key Options

IBM options for System x servers help you take your servers to a higher level

You rely on System x options to supply a complete solution for your business needs. Options help you create an optimized server system to meet your data protection, storage and availability needs. Every IBM option is designed and tested for peak performance and flexibility, helping to maximize your return on investment. The combination of System x servers and options lets you keep your fingers on the pulse of your e-business.

Processors —Intel Xeon processors provide high clock rates, 4 to 6 cores, 64-bit extensions, and advanced features for performance, availability and power management. Large cache size, combined with fast **1333MHz**, **1066MHz** or **800MHz** memory access and an integrated memory controller reduce memory latency and facilitate the movement of data. (**Note:** System performance depends not only on the number of processors in the server but also on the frequency and functionality of each processor.) Adding a second processor may be a cost-effective way to achieve significant performance improvements.

Memory — Memory is a major factor in systems application performance. Adding more memory

to a System x server is one of the most effective ways to increase application performance. For best performance in a server with a **4-core** processor, there should be twice as much memory as for a 2-core processor. A **6-core** processor should have three times as much memory as a 2-core processor.

Hard Disk Drives — IBM hard disk drives help you improve the transaction and cost performance of your System x servers. The choice of hard disk drives can be a critical aspect of maximizing the I/O throughput of the system. 3.5-inch **SAS** hard disk drives are available for the x3620 M3 with capacities of up to **600GB** at **15,000** RPMs. 3.5-inch **SATA** HDDs are available in capacities up to **2TB** at **7,200** RPMs.

Power Supply — The optional second power supply for the x3620 M3 enables redundancy for hot-swap power. In addition, its **92%-efficient** design helps lower your energy bill for power and cooling.

Virtual Media Key — The x3620 M3 includes a plethora of systems management features built-in; however, sometimes additional management capability is needed. In those situations, the Virtual Media Key not only offers powerful new features, it does so without taking up a valuable PCIe adapter slot, instead using a dedicated connector on the motherboard.

ServeRAID Controllers — System x servers using ServeRAID technology allow companies to build a reliable foundation for business-critical computing. IBM ServeRAID technology allows an array consisting of multiple physical hard disk drives to be treated as one logical drive. ServeRAID technology also allows data to be stored redundantly, across multiple hard disk drives—enhancing both the integrity and the availability of the data. SAS and SATA ServeRAID controllers offer enhanced performance due to onboard processors and cache. Because IBM ServeRAID controllers can help significantly improve data transfer rates, this technology is extremely effective when implementing demanding, transaction-oriented applications. By employing the advanced fault tolerance of IBM ServeRAID technology, companies can effectively implement networked business systems that require large amounts of storage space for data and applications that must be available for their businesses to continue operating.

The **ServeRAID-BR10iI v2 SAS/SATA Controller** offers **RAID-0/1/1E** support, with up to **3Gbps** per SAS port. The IBM **ServeRAID-M1015**, x8 PCIe and **6Gbps**, offers RAID-0/1/10; optionally RAID-5 with **SED** support. The IBM **ServeRAID-M5014**, x8 PCIe and **6Gbps**, provides **256MB** cache and RAID-0/1/10/5/50; optionally RAID-6/60 with SED, and battery backup). The IBM **ServeRAID-M5015**, x8 PCIe and **6Gbps**, has **512MB** cache and RAID-0/1/10/5/50; optionally RAID-6/60 with SED, and battery backup. The **IBM ServeRAID M1000 Series Advance Feature Key** adds **RAID-5** and **SED** support to the ServeRAID-M1015. Similarly, the **IBM ServeRAID M5000 Series Advance Feature Key** adds **RAID-6/60** with **SED** support to the M5014 and M5015. The **IBM ServeRAID M5000 Series Battery Key** adds **battery backup** support to the M5014.

External Storage — The IBM **System Storage EXP810** and **EXP3000** expansion units, as well as the **DS3000**, **DS4000**, and **DS8000** series storage subsystems and **N3000**, **N5000**, **N6000**, and **N7000** NAS systems comprise a powerful and broad shared storage family with integrated management software designed to meet midrange and enterprise needs.

IBM System x3620 M3 Images

Front View

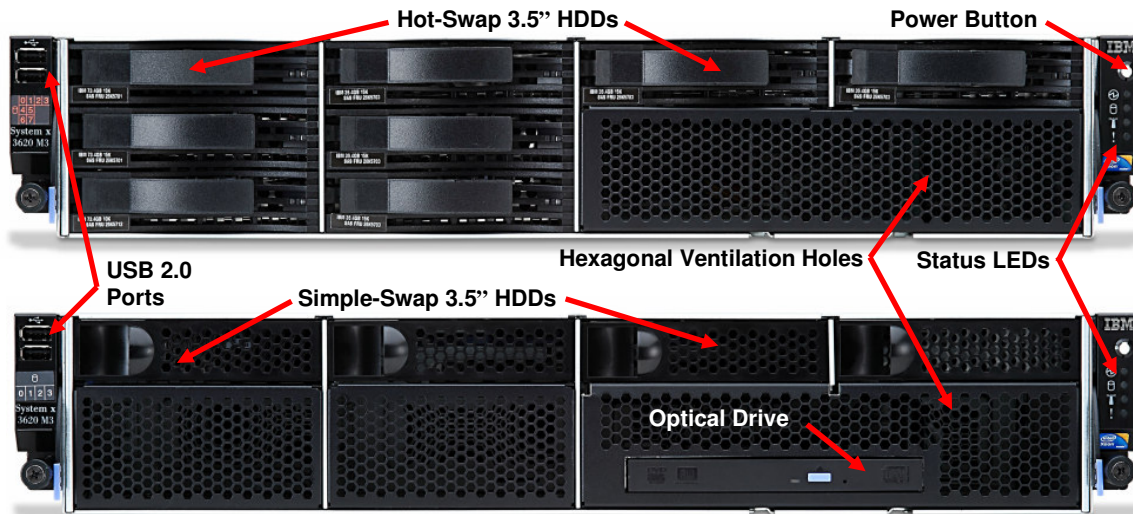

Inside View

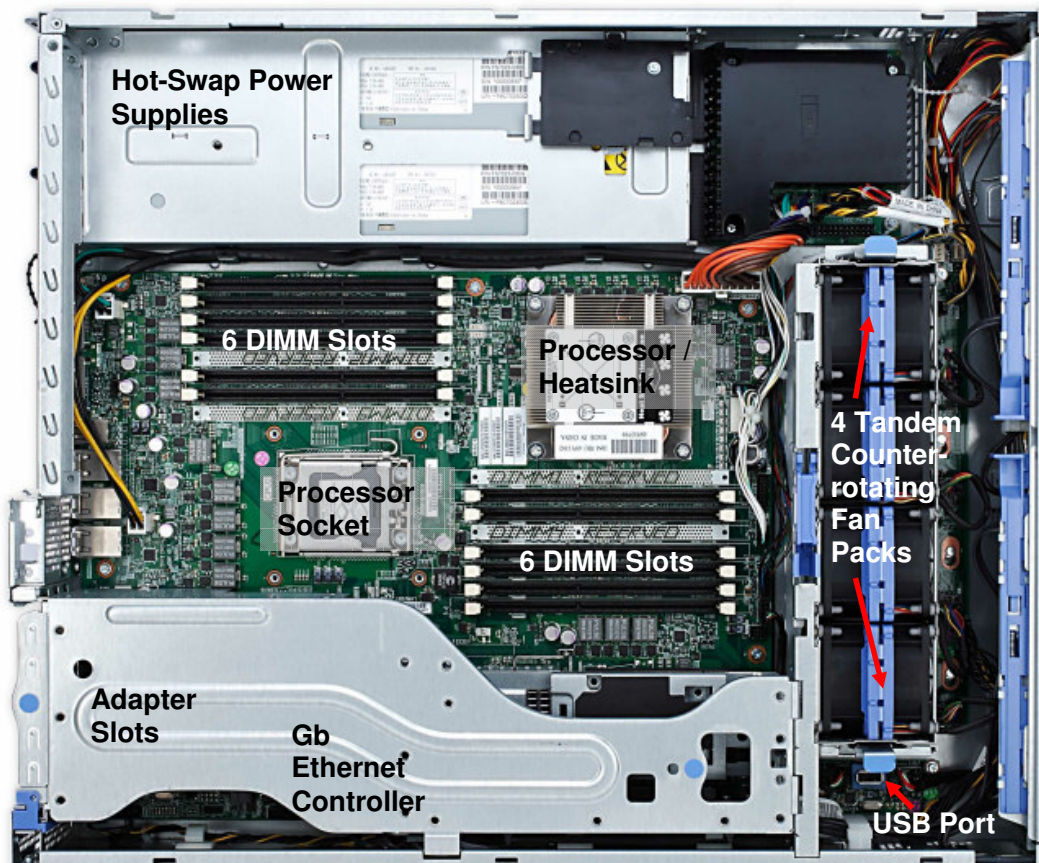

A cost-optimized storage-rich alternative to traditional enterprise 2U dual-socket servers

Rear View

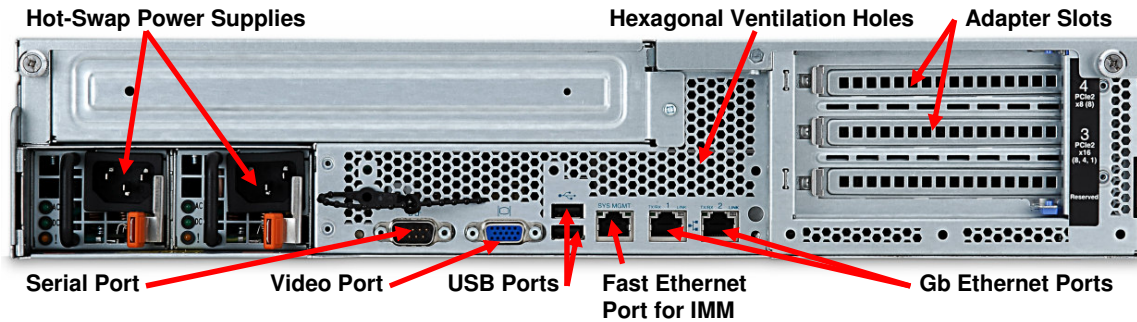

IBM System x3620 M3 Specifications				
Machine type	7376-22x, 32x, 42x, 52x, 62x			
Form factor	2U			
Processor types (standard)	6-Core Xeon (L56xx/X56xx) 2.66GHz X5650 (62x); L5640, X5670 processors supported via CTO	4-Core Xeon (E56xx/L56xx) 2.4GHz E5620 (42x), 2.53GHz E5630 (52x); L5630 processor supported via CTO	4-Core Xeon (E55xx) 2.13GHz E5506 (22x), 2.26GHz E5507 (32x)	
Maximum processor power draw	95W —62x (X5670 processor supported via CTO)	80W —22x, 32x, 42x, 52x (E5640 via CTO)	60W —L5640 via CTO	40W —L5630 via CTO
QuickPath Interconnect (QPI) speed (gigatransfers per second)	6.4GTps (62x plus E5640, L5630, X5670 via CTO)	5.86GTps (42x, 52x, plus E5640, L5630, L5640 via CTO)		4.8GTps (22x, 32x)
# of processors standard / maximum	1 / 2			
Hyper Threading Technology supported	Yes (2 threads per core) — 42x, 52x, 62x, plus E5640, L5630, L5640, X5670 via CTO		No — 22x, 32x	
Turbo Boost Technology supported	Yes — 42x, 52x, 62x, plus E5640, L5630, L5640, X5670 via CTO		No — 22x, 32x	
Internal L3 cache	12MB (1 shared 12MB cache)—42x, 52x, 62x, plus E5640, L5630, L5640, X5670 via CTO		4MB (1 shared 4MB cache)—22x, 32x	
Chipset	Intel 5520			
BIOS type	Unified Extensible Firmware Interface (UEFI)			
Standard memory ⁸ (96GB maximum)	12GB (3 x 4GB) — 62x	4GB (1 x 4GB) — 32x, 42x, 52x	2GB (1 x 2GB) — 22x	
# of DIMM sockets total / available	12 / 9 — 62x		12 / 11 — All other models	
Memory voltage standard	1.5V			
Memory type standard	Registered PC3-10600 (DDR III ECC (Chipkill protection standard)—Dual-rank x4			
Maximum memory access speed	1333MHz (62x)	1066MHz (42x, 52x)	800MHz (22x, 32x)	

⁸ Maximum memory and disk capacity may require the replacement of standard components with the largest supported component available.

Memory interleaving	Yes (two-way using pairs of DIMMs)		
DIMM types / capacities supported	PC3-10600 1333MHz RDIMM 1GB single -rank x8, 1.5V; 2GB single -rank x4 , 1.5V; 2GB dual-rank x8 1.5V; 4GB dual-rank x4 1.5V; 8GB dual-rank x4 1.5V	PC3L-10600⁹ 1333MHz RDIMM 2GB dual-rank x8 1.35V; 4GB dual-rank x4 1.35V; 8GB dual-rank x4 1.35V	PC3L-8500R 1066MHz RDIMM 8GB dual-rank x4 1.35V
Supports 1333MHz with 2 DIMMs per channel	L5640 and X56xx processors support 2DPC at 1333MHz		
Online hot-spare memory supported	No		
Memory mirroring supported / # of DIMM sockets reserved for mirroring	Yes / 1 channel (2 slots per processor) active, 1 spare, 1 unused		
Storage technology	Hot-swap SAS/SATA, simple-swap SATA		
# of HDD drive bays total / available	8 / 8 (3.5-inch) hot-swap , with internal backup drive (32x, 42x, 52x, 62x)	4 / 4 (3.5-inch) simple-swap , with internal backup drive (22x)	
# of 5.25" bays total / available	1 / 1		
Maximum drive capacity	3.5-inch HS SATA II 16.0TB (8 x 2TB), plus internal backup drive	3.5-inch SS SATA II 8.0TB (4 x 2TB), with internal tape drive	3.5-inch HS SAS 4.8TB (8 x 600GB), plus internal backup drive
Drive capacities supported	3.5-inch HS SATA II 250GB, 500GB, 1TB, 2TB – 7.2K	3.5-inch SS SATA II 250GB, 500GB, 1TB, 2TB – 7.2K	3.5-inch HS SAS 300, 450, 600GB — 15K
# of HDDs standard	None (all models open bay)		
# of optical drives standard	None (optional)		
# of diskette drives standard	None (optional via USB)		
Internal backup supported	One USB or SATA tape drive (DDS Gen 5, DDS Gen 6) or USB RDX Removable Disk Backup System		
Integrated disk controller	Chipset		
# of disk drives supported per port	1		
RAID controllers Standard	None (firmware RAID only)—22x	ServeRAID-M1015 (no cache)—RAID-0/1/10; optional RAID-5 with SED, 6Gbps; supports 8 drives—32x, 42x	ServeRAID-M5014 (256MB cache) —RAID-0/1/10/5/50; optional RAID-6/60 with SED, optional battery; 6Gbps; supports 8 drives—52x ServeRAID-M5015 (512MB battery-backed cache) —RAID-0/1/10/5/50; optional RAID-6/60 with SED; 6Gbps ; supports 8 drives—62x
Optional RAID controllers	ServeRAID-BR10il v2 (no cache)—RAID-0/1/1E, 3Gbps ; supports 4 drives—22x	ServeRAID-M5014 —32x, 42x	ServeRAID-M5015 —32x, 42x, 52x
External disk drives supported	None		
# of adapter slots total / available	3 / 3		
# of PCIe x16/x8 Gen 2 slots (8GBps)	1 (full-height/half-length)		
# of PCIe x8/x8 Gen 2 slots (8GBps)	1 (full-height/half-length)		
# of PCIe x16/x4 Gen 2 slots (4GBps)	1 (low-profile)		

⁹ 1.35V DIMMs available in Q3/10.

A cost-optimized storage-rich alternative to traditional enterprise 2U dual-socket servers

# of PCI-X/133 slots (1GBps)	None	
# of 33MHz legacy PCI slots	None	
# of video ports	1 (rear)	
Video controller	Matrox G200eV (in IMM) standard (NVIDIA FX580 optional)	
Video memory	16MB DDR3 SDRAM	
Maximum video resolutions	1280x1024 at 60Hz (32 bits)	1600x1200 at 85Hz (16 bits)
Gigabit Ethernet controller	Intel 82575	
Fabric acceleration standard	None	
# of Gigabit Ethernet ports	2	
Emulex 10GbE Integrated Virtual Fabric Adapter for IBM	2 ports available via CTO	
# of RS485 ports	None	
# of serial ports	1 (rear)	
# of parallel ports	None (USB-attached)	
# of mouse ports	None (USB-attached)	
# of keyboard ports	None (USB-attached)	
# of USB 2.0 ports	5 (2 front, 2 rear, 1 internal for an optional tape drive, IBM RDX Removable Disk Backup System, plus a USB flash memory key containing an embedded hypervisor is supported via another internal USB port)	
Integrated systems management controller	Yes (IMM)	
Optional systems management adapter	Virtual Media Key (optional)	
Light path diagnostics support	No	
Predictive Failure Analysis (PFA) support	Memory, HDDs, and the onboard battery	
Power supply size	675W universal, autoswitching, hot-swap; 92% efficiency	
# of power supplies standard / maximum	1 / 2	
Hot-swap/redundant power supported	Yes (with two power supplies installed)	
# of fans modules standard / maximum	4 / 4 (2 fans per module)	
Hot-swap/redundant fans supported	Redundant-only	
Heat emitted (minimum/maximum)	663 – 2,305 BTUs; 194 - 675 Watts	
Rack mount method	Rail	
Maximum altitude	7,000 ft; 2,133 m	
Operating temperature range	50 – 95° F; 10 – 35° C (up to 3,000 ft / 914.4 m)	50 – 90° F; 10 – 32° C (3,000 ft to 7,000 ft / 914.4m to 2,133m)
Dimensions (HWD) / weight	3.4" (86.5mm) H 19.2" (488.0mm) W 29.5" (749.4mm) D	35.9 (minimum) – 49.5 lb (maximum) 16.3 – 22.45 kg
Operating systems supported	Microsoft Windows Server 2008 / 2008 R2 (Standard/Enterprise/Web/Datacenter), 64-bit; Microsoft Windows Server 2003 R2 (Standard/Enterprise/Web/Datacenter), 64-bit; Microsoft SBS 2003 R2 (Standard/Premium); RHEL 5 U4 64-bit, with and without Xen; SLES 11 64-bit with and without Xen, 32-bit without Xen; SLES 10 SP3 64-bit with and without Xen; VMware ESX Server 4.0, ESXi 4.0 / 4.0 U1	

Length of limited warranty	3 years (parts and labor) ¹⁰
----------------------------	---

The Bottom Line

The IBM System x3620 M3 is an extremely energy efficient, powerful system, incorporating significantly redesigned management tools and abundant IBM-unique innovations:

Price/Performance

- **High-throughput processors** — Up to two **2.66GHz 6-core** or **2.13GHz to 2.53GHz 4-core** Xeon **5600** Series processors; or two **2.13GHz to 2.26GHz 4-core** Xeon **5500** Series processors
- **Energy-efficient low-voltage processors** — **40W 4-core** and **60W 6-core** Xeon 5600 Series processors (via the CTO process)
- **Hyper Threading Technology** for up to **12** processor cores and **24** threads total (processor-specific)
- **Turbo Boost Technology** for a performance boost when not all cores are in use (processor-specific)
- **64-bit extensions** (EM64T)
- **Large cache** — **12MB** or **4MB** of L3 processor cache (processor-specific)
- **Fast memory** — Registered **PC3-10600 DDR III ECC** DIMMs standard, operating at **1333MHz**, **1066MHz** or **800MHz** (depending on processor model and memory configuration); supports 2 DIMMs per channel at 1333MHz (5600 Series only)
- **Fast disk technology** — Supports high-performance **6Gbps SAS** drives that provide high density/high reliability and allow you to scale up as your business grows.
- **Fast communications** — Integrated **dual Gigabit Ethernet** controllers standard, with **failover** support
- **Fast I/O** — Three **PCIe** adapter slots (2 **x8** and 1 **x4**)

Flexibility

- **Large memory capacity** — Up to **96GB** of registered DDR3 DIMMs, in **12** DIMM slots
- Up to **8 3.5-inch hot-swap SAS/SATA** HDDs or **4 simple-swap SATA** HDDs
- **Choice of disk storage** — Up to **16.0TB** of internal hot-swap/simple-swap SATA storage, **4.8TB** of internal hot-swap SAS storage
- **High-performance external expansion** — **Five** 480Mbps **USB 2.0** ports (two front, two rear, one internal for an optional tape drive, IBM RDX Removable Disk Backup System), plus a flash memory USB key containing an embedded hypervisor support
- Slotless hardware-based **3Gbps RAID-0/1/1E**, or **6Gbps RAID-0/1/10** or **RAID-0/1/10/5/50** standard
- **Three available** adapter slots:
 - One x16/x8¹¹ PCIe** Gen 2 slots (8GBps)
 - One x8/x8¹² PCIe** Gen 2 slots (8GBps)
 - One x16/x4¹³ PCIe** Gen 2 slot (4GBps)—requires a non-I/O card
- Choice of optional **DVD-RW** drive, or **tape** drive, or **RDX Removable Disk Backup System**

Manageability, Serviceability and Availability

- **IBM Systems Director** systems management software, including (among others):
 - IBM Systems Director Active Energy Manager
 - IBM Service and Support Manager
- **Integrated Management Module (IMM):**
 - IPMI 2.0** compliance, including highly secure remote power control
 - Text console redirection** systems management standard
 - Optional **Virtual Media Key** daughter card (no slot required)
 - Supports **LDAP** and **SSL** industry standards

¹⁰ For terms and conditions or copies of the IBM Statement of Limited Warranty, call 800-772-2227 in the U.S. In Canada call 800-426-2255. IBM makes no representation or warranty regarding third-party products or services including those designated as ServerProven or ClusterProven. Telephone support may be subject to additional charges. For warranties including onsite labor, a technician is sent after IBM attempts to resolve the problem remotely. International warranty service is available in any country in which this product is sold.

¹¹ The **x16/x8** slot can accept x1, x4, x8, or **x16** Gen 1 or Gen 2 adapters running at x1, x4, x8, or **x8** throughput, respectively.

¹² The **x8/x8** slot can accept x1, x4, or x8 Gen 1 or Gen 2 adapters running at x1, x4, or x8 throughput, respectively.

¹³ The **x16/x4** slot can accept x1, x4, **x8**, or **x16** Gen 1 or Gen 2 adapters running at x1, x4, **x4**, or **x4** throughput, respectively.

- **Active Memory protection:**
 - Advanced **Chipkill** ECC memory protection support
 - Memory mirroring**
- Integrated **ServeRAID** controller — enhances system availability and serviceability
- A choice of **hot-swap SAS/SATA** HDDs or **simple-swap SATA** HDDs for quicker servicing than with fixed drives
- **Ultra-efficient cooling**
- Optional **hot-swap/redundant power supplies**
- **Front-panel status** LEDs
- **Toolless chassis** and **toolless slide** design

Server Comparison Chart

The following table shows the suggested uses for the respective IBM System x rack-optimized servers, including comparisons of the uses for which each server is best suited:

		Important	Nice to Have	Can do without	Rack-Optimized Servers														
					Best Better Good														
		Requirements				Rack-Optimized Servers													
Theme	Key Workloads	Scalability	Floating Point Performance	Memory Throughput	Integer Performance	I/O and Storage	Density	High Availability	Systems Management	Security	Distributed Deployment								
												x3250 M3	x3550 M3	x3620 M3	x3650 M3	x3690 X5	x3755 X5	x3850 X5	x3950 X5
HPC	Cluster / HPC																		
	Modeling & Simulation																		
	High Performance DB																		
	Business Intelligence																		
Web 2.0 / Web 3D	Search																		
	Content																		
	Communities																		
	Commerce																		
	Collaboration																		
Business Applications	ERP/SCM																		
	CRM																		
	Hosted Client																		
	Point of Sale																		
	Branch Office																		
Infrastructure Applications	Virtualization																		
	Business Continuity																		
	Database																		
	Email/Collaboration																		
	Security																		
	Web Serving																		
File & Print																			



For More Information

IBM System x Servers
IBM Systems Director Service and Support Manager
IBM System x and BladeCenter Power Configurator
Standalone Solutions Configuration Tool
Configuration and Options Guide
ServerProven Program
Technical Support
Other Technical Support Resources

<http://ibm.com/systems/x>
<http://ibm.com/support/electronic>
<http://ibm.com/systems/bladecenter/powerconfig>
<http://ibm.com/servers/eserver/xseries/library/configtools.html>
<http://ibm.com/servers/eserver/xseries/cog>
<http://ibm.com/servers/eserver/serverproven/compat/us>
<http://ibm.com/server/support>
<http://ibm.com/servers/eserver/techsupport.html>

Legal Information

© IBM Corporation 2010

IBM Systems and Technology Group
Dept. U2SA
3039 Cornwallis Road
Research Triangle Park, NC 27709

Produced in the USA
May 2010
All rights reserved

For a copy of applicable product warranties, write to: Warranty Information, P.O. Box 12195, RTP, NC 27709, Attn: Dept. JDJA/B203. IBM makes no representation or warranty regarding third-party products or services including those designated as ServerProven or ClusterProven. Telephone support may be subject to additional charges. For onsite labor, IBM will attempt to diagnose and resolve the problem remotely before sending a technician.

IBM, the IBM logo, ibm.com, Active Energy Manager, Active Memory, Chipkill, OnForever, ServeRAID, ServerGuide, ServerProven, System Storage, System x, Systems Director Active Memory Manager, Wake on LAN, and X-Architecture are trademarks of IBM Corporation in the United States, other countries, or both. If these and other IBM trademarked terms are marked on their first occurrence in this information with a trademark symbol (® or ™), these symbols indicate U.S. registered or common law trademarks owned by IBM at the time this information was published. Such trademarks may also be registered or common law trademarks in other countries. A current list of IBM trademarks is available at <http://ibm.com/legal/copytrade.shtml>.

Intel and Xeon are trademarks or registered trademarks of Intel Corporation or its subsidiaries in the United States and other countries.

Linux is a registered trademark of Linus Torvalds.

Microsoft, Windows, Windows Server, and the Windows logo are trademarks or registered trademarks of Microsoft Corporation.

Other company, product and service names may be trademarks or service marks of others.

IBM reserves the right to change specifications or other product information without notice. References in this publication to IBM products or services do not imply that IBM

intends to make them available in all countries in which IBM operates. IBM PROVIDES THIS PUBLICATION "AS IS" WITHOUT WARRANTY OF ANY KIND, EITHER EXPRESS OR IMPLIED, INCLUDING THE IMPLIED WARRANTIES OF MERCHANTABILITY AND FITNESS FOR A PARTICULAR PURPOSE. Some jurisdictions do not allow disclaimer of express or implied warranties in certain transactions; therefore, this statement may not apply to you.

This publication may contain links to third party sites that are not under the control of or maintained by IBM. Access to any such third party site is at the user's own risk and IBM is not responsible for the accuracy or reliability of any information, data, opinions, advice or statements made on these sites. IBM provides these links merely as a convenience and the inclusion of such links does not imply an endorsement.

Information in this presentation concerning non-IBM products was obtained from the suppliers of these products, published announcement material or other publicly available sources. IBM has not tested these products and cannot confirm the accuracy of performance, compatibility or any other claims related to non-IBM products. Questions on the capabilities of non-IBM products should be addressed to the suppliers of those products.

MB, GB and TB = 1,000,000, 1,000,000,000 and 1,000,000,000,000 bytes, respectively, when referring to storage capacity. Accessible capacity is less; up to 3GB is used in service partition. Actual storage capacity will vary based upon many factors and may be less than stated.

Performance is in Internal Throughput Rate (ITR) ratio based on measurements and projections using standard IBM benchmarks in a controlled environment. The actual throughput that any user will experience will depend on considerations such as the amount of multiprogramming in the user's job stream, the I/O configuration, the storage configuration and the workload processed. Therefore, no assurance can be given that an individual user will achieve throughput improvements equivalent to the performance ratios stated here.

Maximum internal hard disk and memory capacities may require the replacement of any standard hard drives and/or memory and the population of all hard disk bays and memory slots with the largest currently supported drives available. When referring to variable speed CD-ROMs, CD-Rs, CD-RWs and DVDs, actual playback speed will vary and is often less than the maximum possible.

XSO03105-USEN-00

Free Manuals Download Website

<http://myh66.com>

<http://usermanuals.us>

<http://www.somanuals.com>

<http://www.4manuals.cc>

<http://www.manual-lib.com>

<http://www.404manual.com>

<http://www.luxmanual.com>

<http://aubethermostatmanual.com>

Golf course search by state

<http://golfingnear.com>

Email search by domain

<http://emailbydomain.com>

Auto manuals search

<http://auto.somanuals.com>

TV manuals search

<http://tv.somanuals.com>