

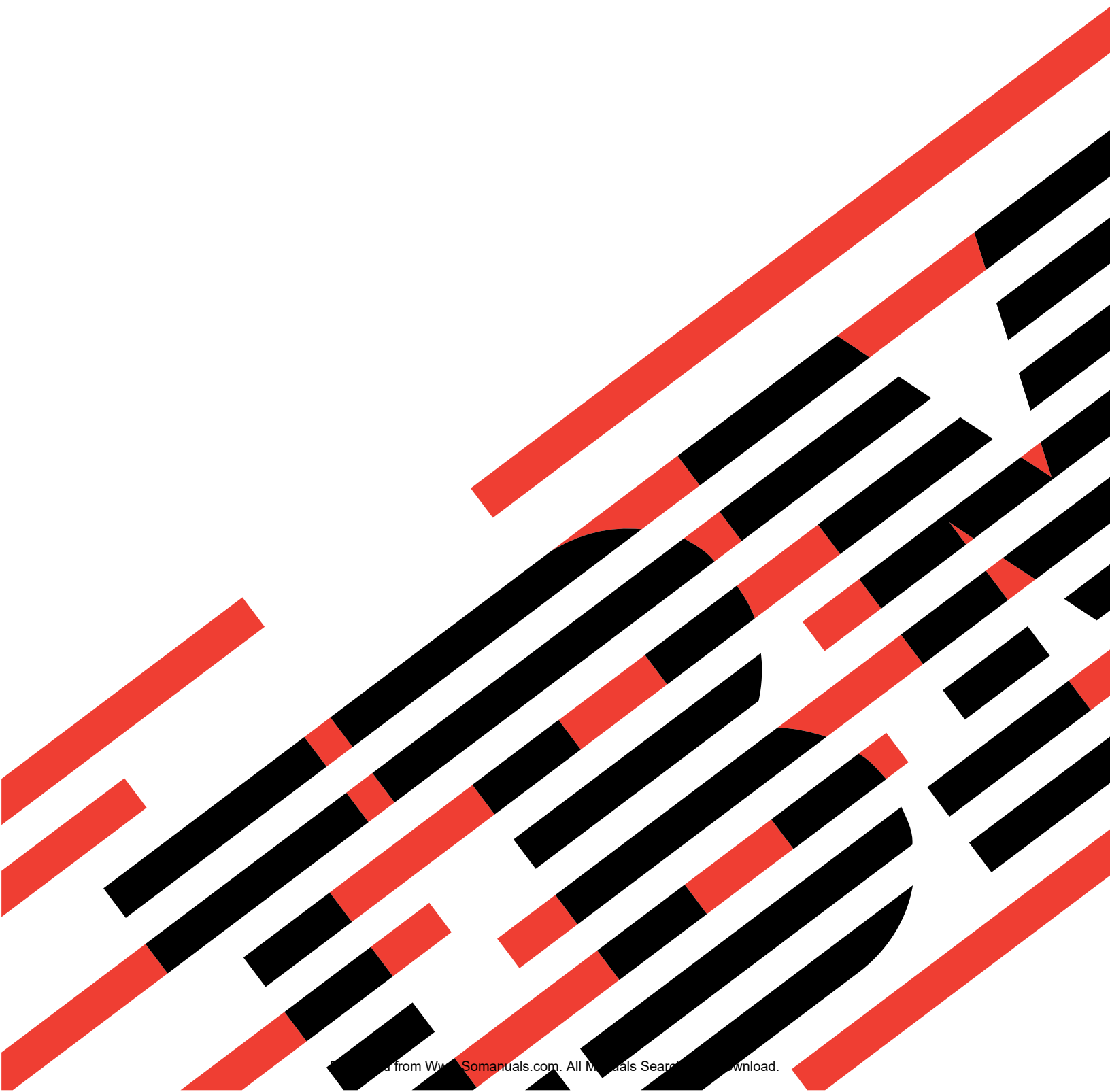

IBM xSeries 350 Type 8682

# Hardware Maintenance Manual







@server

IBM xSeries 350 Type 8682

Hardware Maintenance Manual

:

**Note:** Before using this information and the product it supports, be sure to read the general information under "Notices" on page 160

**Sixth Edition (September 2003)**

INTERNATIONAL BUSINESS MACHINES CORPORATION PROVIDES THIS PUBLICATION "AS IS" WITHOUT WARRANTY OF ANY KIND, EITHER EXPRESS OR IMPLIED, INCLUDING, BUT NOT LIMITED TO, THE IMPLIED WARRANTIES OF MERCHANTABILITY OR FITNESS FOR A PARTICULAR PURPOSE. Some states do not allow disclaimer of express or implied warranties in certain transactions, therefore, this statement may not apply to you.

This publication could include technical inaccuracies or typographical errors. Changes are periodically made to the information herein; these changes will be incorporated in new editions of the publication. IBM may make improvements and/or changes in the product(s) and/or the program(s) described in this publication at any time.

This publication was developed for products and services offered in the United States of America. IBM may not offer the products, services, or features discussed in this document in other countries, and the information is subject to change without notice. Consult your local IBM representative for information on the products, services, and features available in your area.

Requests for technical information about IBM products should be made to your IBM reseller or IBM marketing representative.

© **Copyright International Business Machines Corporation 2000. All rights reserved.**

US Government Users Restricted Rights – Use, duplication or disclosure restricted by GSA ADP Schedule Contract with IBM Corp.

---

## About this manual

This manual contains diagnostic information, a Symptom-to-FRU index, service information, error codes, error messages, and configuration information for the IBM® @server™ xSeries™ 350 Type 8682 server.

**Important:** This manual is intended for trained servicers who are familiar with IBM xSeries products. Before servicing an IBM product, be sure to review “Safety information” on page 127.

---

## Important safety information

Be sure to read all caution and danger statements in this book before performing any of the instructions.

Leia todas as instruções de cuidado e perigo antes de executar qualquer operação.

在安装本产品之前，请仔细阅读 **Safety Information** (安全信息)。

安裝本產品之前，請先閱讀「安全資訊」。

Prenez connaissance de toutes les consignes de type Attention et

Danger avant de procéder aux opérations décrites par les instructions.

Lesen Sie alle Sicherheitshinweise, bevor Sie eine Anweisung ausführen.

Accertarsi di leggere tutti gli avvisi di attenzione e di pericolo prima di effettuare qualsiasi operazione.

製品の設置の前に、安全情報をお読みください。

본 제품을 설치하기 전에 안전 정보를 읽으십시오.

Lea atentamente todas las declaraciones de precaución y peligro ante de llevar a cabo cualquier operación.

**WARNING:** Handling the cord on this product or cords associated with accessories sold with this product, will expose you to lead, a chemical known to the State of California to cause cancer, and birth defects or other reproductive harm. **Wash hands after handling.**

**ADVERTENCIA:** El contacto con el cable de este producto o con cables de accesorios que se venden junto con este producto, pueden exponerle al plomo, un elemento químico que en el estado de California de los Estados Unidos está considerado como un causante de cancer y de defectos congénitos, además de otros riesgos reproductivos. **Lávese las manos después de usar el producto.**

---

## Online support

You can download the most current diagnostic, BIOS flash, and device driver files from <http://www.ibm.com/pc/support>.



---

# Contents

<b>About this manual</b> . . . . .	iii
Important safety information . . . . .	iii
Online support . . . . .	iii
<b>General checkout</b> . . . . .	1
Checkout procedure . . . . .	2
<b>General information</b> . . . . .	3
Features and specifications . . . . .	3
Server features . . . . .	5
Reliability, availability, and serviceability . . . . .	6
Start the server . . . . .	8
Controls and indicators . . . . .	9
Information LED panel . . . . .	9
<b>Diagnostics</b> . . . . .	11
Diagnostic tools overview . . . . .	11
POST . . . . .	11
POST beep codes . . . . .	12
POST error messages . . . . .	12
Event/error logs . . . . .	12
Small computer system interface messages . . . . .	12
ServerGuide error symptoms . . . . .	12
Diagnostic programs and error messages . . . . .	13
Text messages . . . . .	14
Starting the diagnostic programs . . . . .	14
Viewing the test log . . . . .	15
Diagnostic error message tables . . . . .	15
Light path diagnostics . . . . .	16
Power supply LEDs . . . . .	16
Diagnostic panel LEDs . . . . .	18
Light Path Diagnostics . . . . .	19
Power checkout . . . . .	20
Recovering BIOS . . . . .	20
Replacing the battery . . . . .	21
Temperature checkout . . . . .	23
Diagnosing errors . . . . .	23
Troubleshooting the Ethernet controller . . . . .	23
Network connection problems . . . . .	23
Ethernet controller troubleshooting chart . . . . .	24
Ethernet controller messages . . . . .	25
Novell NetWare or IntraNetWare server ODI driver messages . . . . .	25
Network driver interface specification 2.01 (OS/2) driver messages . . . . .	28
NDIS 4.0 (Windows NT) driver messages . . . . .	29
UNIX messages . . . . .	30
<b>Configuring the server</b> . . . . .	33
Using the Configuration/Setup Utility program . . . . .	33
Starting the Configuration/Setup Utility program . . . . .	33
Choices available from the Configuration/Setup main menu . . . . .	34
Using passwords . . . . .	37
Power-on password . . . . .	38
Administrator password . . . . .	38

Using the SCSISelect utility program . . . . .	39
Starting the SCSISelect utility program . . . . .	39
Choices available from the SCSISelect menu. . . . .	40
<b>Installing options . . . . .</b>	<b>41</b>
Expanded view of the xSeries 350. . . . .	41
Component locations. . . . .	42
System board component locations . . . . .	42
System board LED locations . . . . .	46
Diagnostic panel LEDs . . . . .	47
Memory board component locations . . . . .	48
Advanced System Management Interconnect board component locations	49
Before you begin . . . . .	50
System reliability considerations . . . . .	50
Working inside the server with the power on . . . . .	50
Handling static-sensitive devices . . . . .	51
Removing the server top cover and bezel . . . . .	53
Working with adapters . . . . .	54
Installing a hot-plug adapter . . . . .	55
Cabling example for the ServeRAID adapter . . . . .	56
Installing internal drives. . . . .	59
Internal drive bays . . . . .	59
Hard disk drive component locations . . . . .	60
Installing a hot-swap hard disk drive . . . . .	62
Installing memory-module kits . . . . .	63
Installing a microprocessor kit . . . . .	66
Changing jumper positions . . . . .	69
Three-pin jumper blocks . . . . .	69
Installing a hot-swap power supply . . . . .	70
Installing a 3-Pack Ultra160 Hot-Swap Expansion Kit . . . . .	71
Replacing a hot-swap fan . . . . .	73
Completing the installation. . . . .	74
Installing the server top cover and bezel . . . . .	74
Updating the server configuration . . . . .	75
Connecting external options . . . . .	75
Input/output ports . . . . .	76
Parallel port . . . . .	76
Viewing or changing the parallel-port assignments . . . . .	76
Parallel port connector . . . . .	77
Video port. . . . .	77
Keyboard port . . . . .	78
Auxiliary-device (pointing device) port . . . . .	79
Ultra160 SCSI ports . . . . .	79
SCSI cabling requirements . . . . .	80
Setting SCSI IDs . . . . .	80
SCSI connector pin-number assignments . . . . .	80
Serial ports . . . . .	81
Viewing or changing the serial-port assignments . . . . .	82
Serial-port connectors . . . . .	82
Universal Serial Bus ports . . . . .	82
USB cables and hubs . . . . .	82
USB-port connectors. . . . .	83
Ethernet port. . . . .	83
Configuring the Ethernet controller. . . . .	83
Failover for redundant Ethernet . . . . .	83
Ethernet port connector. . . . .	86



Advanced System Management ports . . . . .	87
Cabling the server. . . . .	88
<b>FRU information (service only) . . . . .</b>	<b>89</b>
LED switch card . . . . .	89
Four-fan housing . . . . .	90
Dual fan mount assembly with cable . . . . .	91
Service processor card assembly . . . . .	92
PCI switch card. . . . .	93
Power backplane assembly . . . . .	94
System board assembly with backerplate . . . . .	95
<b>Symptom-to-FRU index . . . . .</b>	<b>97</b>
Beep symptoms . . . . .	97
No beep symptoms . . . . .	100
Diagnostic panel error LEDs . . . . .	101
Diagnostic error codes . . . . .	103
Error symptoms . . . . .	108
Power supply LED errors. . . . .	110
POST error codes . . . . .	110
ServeRAID . . . . .	116
I2C bus fault messages . . . . .	117
SCSI error codes . . . . .	118
Temperature error messages . . . . .	118
Fan error messages . . . . .	119
Power error messages. . . . .	119
System shutdown . . . . .	120
Voltage related system shutdown. . . . .	120
Temperature related system shutdown . . . . .	121
DASD checkout . . . . .	121
CPU checkout. . . . .	121
Undetermined problems . . . . .	122
<b>Parts listing, Type 8682. . . . .</b>	<b>123</b>
System . . . . .	123
Keyboards . . . . .	125
Power cords . . . . .	125
<b>Related service information . . . . .</b>	<b>127</b>
Safety information . . . . .	127
General safety . . . . .	127
Electrical safety . . . . .	128
Safety inspection guide . . . . .	129
Handling electrostatic discharge-sensitive devices . . . . .	130
Grounding requirements . . . . .	130
Safety notices (multi-lingual translations) . . . . .	131
Problem determination tips . . . . .	160
Notices . . . . .	160
Trademarks. . . . .	161



---

## General checkout

The server diagnostic programs are stored in upgradable read-only memory (ROM) on the system board. These programs are the primary method of testing the major components of the server: The system board, Ethernet controller, video controller, RAM, keyboard, mouse (pointing device), diskette drive, serial ports, hard drives, and parallel port. You can also use them to test some external devices. See “Diagnostic programs and error messages” on page 13

Also, if you cannot determine whether a problem is caused by the hardware or by the software, you can run the diagnostic programs to confirm that the hardware is working properly.

When you run the diagnostic programs, a single problem might cause several error messages. When this occurs, work to correct the cause of the first error message. After the cause of the first error message is corrected, the other error messages might not occur the next time you run the test.

A failed system might be part of a shared DASD cluster (two or more systems sharing the same external storage device(s)). Prior to running diagnostics, verify that the failing system is not part of a shared DASD cluster.

A system might be part of a cluster if:

- The customer identifies the system as part of a cluster.
- One or more external storage units are attached to the system and at least one of the attached storage units is additionally attached to another system or unidentifiable source.
- One or more systems are located near the failing system.

If the failing system is suspected to be part of a shared DASD cluster, all diagnostic tests can be run except diagnostic tests which test the storage unit (DASD residing in the storage unit) or the storage adapter attached to the storage unit.

### Notes:

1. For systems that are part of a shared DASD cluster, run one test at a time in looped mode. Do not run all tests in looped mode, as this could enable the DASD diagnostic tests.
2. If multiple error codes are displayed, diagnose the first error code displayed.
3. If the computer hangs with a POST error, go to the “Symptom-to-FRU index” on page 97
4. If the computer hangs and no error is displayed, go to “Undetermined problems” on page 122
5. Power supply problems, see “Symptom-to-FRU index” on page 97
6. Safety information, see “Safety information” on page 127
7. For intermittent problems, check the error log; see “POST error messages” on page 12

---

## Checkout procedure

### 1. IS THE SYSTEM PART OF A CLUSTER?

**YES.** Schedule maintenance with the customer. Shut down all systems related to the cluster. Run storage test.

**NO.** Go to step 2.

### 2. IF THE SYSTEM IS NOT PART OF A CLUSTER:

- Power-off the computer and all external devices.
- Check all cables and power cords.
- Set all display controls to the middle position.
- Power-on all external devices.
- Power-on the computer.
- Record any POST error messages displayed on the screen. If an error is displayed, look up the first error in the "POST error codes" on page 110
- Check the information LED panel System Error LED; if on, see "Diagnostic panel error LEDs" on page 101
- Check the System Error Log. If an error was recorded by the system, see "Symptom-to-FRU index" on page 97
- Start the Diagnostic Programs. See "Diagnostic programs and error messages" on page 13
- Check for the following responses:
  - a. One beep.
  - b. Readable instructions or the Main Menu.

### 3. DID YOU RECEIVE BOTH OF THE CORRECT RESPONSES?

**NO.** Find the failure symptom in "Symptom-to-FRU index" on page 97

**YES.** Run the Diagnostic Programs. If necessary, refer to "Diagnostic programs and error messages" on page 13

If you receive an error, go to "Symptom-to-FRU index" on page 97

If the diagnostics completed successfully and you still suspect a problem, see "Undetermined problems" on page 122

---

## General information

The IBM xSeries 350 server is a high-performance server with the capability of microprocessor upgrade to a symmetric multiprocessing (SMP) server. It is ideally suited for networking environments that require superior microprocessor performance, efficient memory management, flexibility, and large amounts of reliable data storage.

Performance, ease of use, reliability, and expansion capabilities were key considerations during the design of the server. These design features make it possible for you to customize the system hardware to meet your needs today, while providing flexible expansion capabilities for the future.

The xSeries 350 server comes with a three-year limited warranty and 90-Day IBM Start Up Support. If you have access to the World Wide Web, you can obtain up-to-date information about the server model and other IBM server products at the following World Wide Web address: <http://www.ibm.com/eserver/xseries/>

---

## Features and specifications

The following provides a summary of the features and specifications for the xSeries 350 server.

- **Microprocessor:**
  - Intel Pentium III Xeon
  - 32 KB of level-1 cache
  - 1 MB or 2 MB Level-2 cache depending upon model
  - 100 MHz front-side bus (FSB)
  - Supports up to four microprocessors
- **Memory:**
  - Maximum: 16GB
  - Type: ECC, SDRAM, Registered DIMMs
  - 16 slots, 4-way interleaved
- **Drives standard:**
  - Diskette: 1.44 MB
  - CD-ROM: 40X IDE
- **Expansion bays:**

Hot-swap drives: Three standard slim-high, three optional slim-high
- **Active PCI expansion slots:**
  - One 33 MHz/32-bit
  - Three 66 MHz/64-bit
  - Two 33 MHz/64-bit
- **Hot-swap power supplies:**

270 W (115-230 V ac)

  - Minimum: One
  - Maximum: Three
- **Redundant cooling:**
  - Six hot-swap fans
- **Video:**
  - S3 video controller
  - Compatible with SVGA and VGA
  - 8 MB video memory

- **Size (4 U)**
  - Height: 178 mm (7 in.) (4 U)
  - Depth: 711.2 mm (28 in.)
  - Width: 482.6 mm (19 in.)
  - Weight: 34.9 kg (77 lb.) to 50.4 kg (111 lb.) depending upon configuration
- **Integrated functions:**
  - Advanced System Management processor with Light Path Diagnostics
  - Dual channel Ultra160 SCSI controller (one internal and one external channel) (non-RAID)
  - One 10BASE-T/100BASE-TX AMD Ethernet controller
  - Two serial ports
  - One parallel port
  - Two universal serial bus ports
  - Keyboard port
  - Mouse port
  - Video port
- **Acoustical noise emissions:**
  - Sound power, idling: 6.3 bel maximum
  - Sound power, operating: 6.3 bel maximum
  - Sound pressure, operating: 48 dBa maximum
- **Environment:**
  - Air temperature:
    - Server on: 10° to 35°C (50° to 95°F). Altitude: 0 to 914 m (3000 ft.)
    - Server on: 10° to 32°C (50° to 89.6°F). Altitude: 914 m (3000 ft.) to 2133 m (7000 ft.)
    - Server off: 10° to 43°C (50° to 110°F). Maximum altitude: 2133 m (7000 ft.)
  - Humidity:
    - Server on: 8% to 80%
    - Server off: 8% to 80%
- **Heat output:**

Approximate heat output in British Thermal Units (BTU) per hour

  - Minimum configuration: 461 BTU (0.14 kilowatts per hour)
  - Maximum configuration: 1796 BTU (0.53 kilowatts per hour)
- **Electrical input:**
  - Sine-wave input (50-60 Hz) required
  - Input voltage low range:
    - Minimum: 90 V ac
    - Maximum: 137 V ac
  - Input voltage high range:
    - Minimum: 180 V ac
    - Maximum: 265 V ac
  - Input kilovolt-amperes (kVA) approximately:
    - Minimum: 0.08 kVA
    - Maximum: 0.52 kVA

---

## Server features

The unique design of the server takes advantage of advancements in symmetric multiprocessing (SMP), data storage, and memory management. The server combines:

- Impressive performance using an innovative approach to SMP

The server supports up to four Pentium III Xeon processors. The server comes with at least one processor installed; you can install additional processors to enhance performance and provide SMP capability.

- Large data-storage and hot-swap capabilities

All models of the server support up to three standard and three optional 26 mm (1-inch) slim-high 3.5-inch hot-swap hard disk drives in the hot-swap bays. This *hot-swap* feature enables you to remove and replace hard disk drives without turning off the server.

- Active PCI (hot-plug) adapter capabilities

The server has six *hot-plug* slots for PCI adapters. With operating system support, you can replace failing hot-plug PCI adapters without turning off the server. If the *hot-add* feature is supported by the operating system and the PCI adapter, you can also add PCI adapters in these slots without turning off the server.

- Redundant cooling and power capabilities

The redundant cooling and hot-swap capabilities of the fans in the server enable continued operation if one of the fans fails. You can also replace a failing fan without turning off the server.

The server comes standard with one 270-watt power supply. Install three 270-watt power supplies to ensure redundancy and hot-swap capability for a typical configuration. (See "Installing a hot-swap power supply" on page 70 for instructions.)

- 100 MHz front-side bus (FSB)

The FSB is the processor external bus. This bus is the interface between the processors and the system board. The FSB is also known as the processor/host bus.

- Large system memory

The memory bus in the server supports up to 16 GB of system memory. The memory controller provides error correcting code (ECC) support for up to 16 industry-standard, 3.3 V, 168-pin, 8-byte, PCI, PC100 registered, dual inline memory modules (DIMMs). The memory controller also provides Chipkill™ memory protection. Chipkill memory protection is a technology that protects the system from a single chip failure on a DIMM.

- System-management capabilities

The server comes with an Advanced System Management Processor on the system board. This processor enables you to manage the functions of the server locally and remotely. The Advanced System Management Processor also provides system monitoring, event recording, and dial-out alert capability.

**Note:** The Advanced System Management Processor is sometimes referred to as the service processor.

- Integrated network environment support

The server comes with an Ethernet controller on the system board. This Ethernet controller has an interface for connecting to 10-Mbps or 100-Mbps networks. The server automatically selects between 10BASE-T and 100BASE-TX. The controller

provides full-duplex (FDX) capability, which enables simultaneous transmission and reception of data on the Ethernet local area network (LAN).

- Redundant network-interface card (NIC)

The addition of an optional, redundant network-interface card (NIC) provides a failover capability to a redundant Ethernet connection. If a problem occurs with the primary Ethernet connection, all Ethernet traffic associated with this primary connection is automatically switched to the redundant NIC. This switching occurs without data loss and without user intervention.

- IBM ServerGuide™ CDs

The ServerGuide CDs included with xSeries servers provide programs to help you set up the server and install the network operating system (NOS). The ServerGuide program detects the hardware options installed, and provides the correct configuration program and device drivers. In addition, the ServerGuide CDs include a variety of application programs such as IBM Update Connector™ to help keep the server basic input/output system (BIOS) and microcode updated.

**Note:** The latest level of BIOS for the server is also available through the World Wide Web. Refer to “Recovering BIOS” on page 20 for the appropriate World Wide Web addresses and bulletin-board telephone numbers.

The server is designed to be cost-effective, powerful, and flexible. It uses peripheral component interconnect (PCI) bus architecture to provide compatibility with a wide range of existing hardware devices and software applications.

As always, the IBM server meets stringent worldwide certifications for power, electromagnetic compatibility (EMC), and safety. See “Related service information” on page 127 for additional information.

---

## Reliability, availability, and serviceability

Three of the most important features in server design are reliability, availability, and serviceability (RAS). These factors help to ensure the integrity of the data stored on the server; that the server is available when you want to use it; and that should a failure occur, you can easily diagnose and repair the failure with minimal inconvenience.

The following is an abbreviated list of the RAS features that the server supports.

- Cooling fans with speed-sensing capability (hot-swap)
- Error correcting code (ECC) FSBs
- ECC L2 cache
- ECC memory
- Fast power-on self-test (POST)
- 45°C (113°F) normal operating temperature for hard disk drives
- Parity checking on the small computer system interface (SCSI) bus and PCI buses
- Power Managed - Advanced Configuration and Power Interface (ACPI) level
- System management monitoring via Intra-Integrated Circuit (I2C) bus
- Ambient temperature monitoring
- Automatic error retry/recovery
- Automatic restart after a power failure
- Built-in temperature/fan/voltages monitoring
- Chipkill memory protection
- Fault-resistant startup
- Hot-swap drive bays



- Hot-swap hard disk drives
- Active PCI (hot-plug) adapter slots
- Information and diagnostic LED panels
- Menu-driven setup, system configuration, SCSISelect configuration, and diagnostic programs
- Memory scrubbing and Predictive Failure Analysis® (PFA) (background and real time)
- Microcode and diagnostic levels available
- NIC failover support
- Power and temperature monitoring
- Power-supply redundancy monitoring
- Predictive Failure Analysis (PFA) alerts
- Redundant Ethernet capabilities (with optional adapter)
- Redundant hot-swap cooling
- Redundant and hot-swap power supplies
- Remote Connect
- Remote system problem-determination support
- System auto-configuring from a configuration menu
- Upgradable POST, BIOS, diagnostics, and Advanced System Management Processor microcode
- Wake on LAN® capability
- Windows NT® failover support
- Alert on LAN™ capability
- Backup BIOS switching by jumper
- Error codes and messages
- Integrated service processor subsystem provides control for remote system management
- Processor serial number access
- Standard cables present detection
- System error logging (POST and Advanced System Management Processor)
- Vital Product Data (VPD) on microprocessors, system board, power supplies, hot-swap-drive backplane, and power backplane

---

## Start the server

Use the following procedure to start the server.

1. Turn on all external devices, such as the monitor.

**Note:** After you plug the power cord into an outlet, wait 20 seconds before pressing the power control button. During this time, the system-management processor is initializing and the power control button does not respond.

2. Press the power control button on the front of the server. The power-on light comes on and the power-on self-test (POST) begins.
  - If the server is turned on and a power failure occurs, the server will start automatically when power is restored.
  - The server can also be turned on by the Advanced System Management Processor.

When you turn off the server, observe the following precaution:

### Statement 5



#### CAUTION:

The power control button on the device and the power switch on the power supply do not turn off the electrical current supplied to the device. The device also might have more than one power cord. To remove all electrical current from the device, ensure that all power cords are disconnected from the power source.

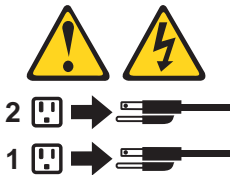

The server can be turned off as follows:

- You can turn off the server by pressing the power-control button on the front of the server.

**Note:** After turning off the server, wait at least five seconds before pressing the power-control button to turn on the server again.

- You can disconnect the server power cords from the electrical outlets to shut off all power to the server.

**Note:** Wait about 15 seconds after disconnecting the power cords for the system to stop running. Watch for the system-power light on the information LED panel to stop blinking.

The following section describes the controls and indicators on the server.

---

## Controls and indicators

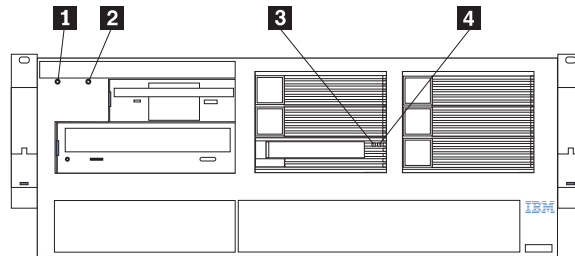

- 1 Power-control button:** Press this button to manually turn on or off the server.
- 2 Reset button:** Press this button to reset the server and run the power-on self-test (POST).
- 3 Hard-disk drive activity light:** Each hot-swap drive has a hard-disk drive activity light. When this green light is flashing, the drive is being accessed.
- 4 Hard-disk drive status light:** Each hot-swap drive has a hard-disk drive status light. With a ServeRAID™ installation, if this amber light is on continuously, it means that the drive has failed.

---

## Information LED panel

The information panel on the front of the server contains status lights.

The following illustration shows the server information panel.

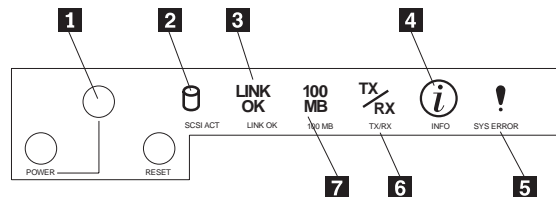

- 1 System power:** When this green light is on, system power is present in the server. When this light flashes, the server is in standby mode (the system power supply is turned off and ac current is present). When this light is off, either a power supply, AC power, or a light has failed. The power light is located above and between the power-control button and the reset button.  
**Attention:** If this light is off, it does not mean there is no electrical current present in the server. The light might be burned out. To remove all electrical current from the server, you must unplug the server power cords from the electrical outlets.
- 2 Hard disk drive activity light:** This green light is on when there is activity on a hard disk drive.
- 3 Ethernet-link status light:** When this green light is on, there is an active connection on the Ethernet port. The Ethernet transmit/receive activity light is also located on the Ethernet (RJ-45) connector on the rear of the server.
- 4 Information light:** When this amber light is on, the server power supplies

are nonredundant or some other noncritical event has occurred. Check the diagnostic LED panel for more information (see “Diagnostic panel LEDs” on page 18).

- 5** **System error light:** This amber light is on when a system error occurs. A light on the diagnostics LED panel will also be on to further isolate the error. (For more information, see “Diagnostic panel LEDs” on page 18)
- 5** **Ethernet transmit/receive activity light:** When this green light is on, there is activity between the server and the network. The Ethernet transmit/receive activity light is also located on the Ethernet (RJ-45) connector on the rear of the server.
- 7** **Ethernet speed 100 Mbps:** When this green light is on, the Ethernet speed is 100 Mbps. When the light is off, the Ethernet speed is 10 Mbps.

---

## Diagnosics

This section provides basic troubleshooting information to help you resolve some common problems that might occur with the server.

If you cannot locate and correct the problem using the information in this section, refer to “Symptom-to-FRU index” on page 97 for more information.

---

### Diagnostic tools overview

The following tools are available to help you identify and resolve hardware-related problems:

- **POST beep codes, error messages, and error logs**

The power-on self-test (POST) generates beep codes and messages to indicate successful test completion or the detection of a problem. See “POST” for more information.

- **Diagnostic programs and error messages**

The server diagnostic programs are stored in upgradable read-only memory (ROM) on the system board. These programs are the primary method of testing the major components of the server. See “Diagnostic programs and error messages” on page 13 for more information.

- **Light Path Diagnostics**

The server has light-emitting diodes (LEDs) to help you identify problems with server components. These LEDs are part of the light-path diagnostics that are built into the server. By following the *path of lights*, you can quickly identify the type of system error that occurred. See “Light path diagnostics” on page 16 for more information.

- **Error symptoms**

These charts list problem symptoms, along with suggested steps to correct the problems. See “Diagnosing errors” on page 23 for more information.

---

## POST

When you turn on the server, it performs a series of tests to check the operation of server components and some of the options installed in the server. This series of tests is called the power-on self-test or POST.

If POST finishes without detecting any problems, a single beep sounds, the first screen of the operating system or application program appears.

If POST detects a problem, more than one beep sounds and an error message appears on the screen. See “POST beep codes” on page 12 and “POST error messages” on page 12 for more information.

**Notes:**

1. If you have a power-on password or administrator password set, you must type the password and press Enter, when prompted, before POST will continue.
2. A single problem might cause several error messages. When this occurs, work to correct the cause of the first error message. After you correct the cause of the first error message, the other error messages usually will not occur the next time you run the test.

## POST beep codes

POST generates beep codes to indicate successful completion or the detection of a problem.

- One beep indicates the successful completion of POST.
- More than one beep indicates that POST detected a problem. For more information, see “Beep symptoms” on page 97

## POST error messages

POST error messages occur during startup when POST finds a problem with the hardware or detects a change in the hardware configuration. For a list of POST errors, see “POST error codes” on page 110

## Event/error logs

The POST error log contains the three most recent error codes and messages that the system generated during POST. The System Event/Error Log contains all error messages issued during POST and all system status messages from the Advanced System Management Processor.

To view the contents of the error logs, start the Configuration/Setup Utility program (see “Starting the Configuration/Setup Utility program” on page 33); then, select **Event/Error Logs** from the main menu.

---

## Small computer system interface messages

If you receive a SCSI error message, see “SCSI error codes” on page 118

**Note:** If the server does not have a hard disk drive, ignore any message that indicates that the BIOS is not installed.

You will get these messages only when running the SCSI Select Utility.

---

## ServerGuide error symptoms

Look for symptoms in the left column of the following chart. Probable solutions appear in the right column.

Setup	Action
<i>Setup and Installation CD</i> won't start.	<ul style="list-style-type: none"><li>• Be sure the system is a supported eServer with a startable (bootable) CD-ROM drive.</li><li>• If the startup (boot) sequence settings have been altered, be sure the CD-ROM is first in the boot sequence.</li><li>• If more than one CD-ROM drive is installed, be sure that only one drive is set as the primary drive. Start the CD from the primary drive.</li></ul>
ServeRAID program cannot view all installed drives – or – cannot install NOS.	<ul style="list-style-type: none"><li>• Be sure there are no duplicate SCSI IDs or IRQ assignments.</li><li>• Be sure that the hard disk drive is connected properly.</li></ul>
The <i>Operating System Installation</i> program continuously loops.	Free up more space on the hard disk.
ServerGuide won't start <i>your</i> NOS CD.	Be sure the NOS CD you have is supported by ServerGuide. See the <i>Setup and Installation</i> CD label for a list of NOS versions supported.
Can't install NOS – option is grayed out.	Either there is no logical drive defined (ServeRAID systems) or the ServerGuide system partition is not present. Run the setup and configuration program.

TechConnect CD	Action
Can't start TechConnect® CD.	Be sure you're starting the CD on a system with Microsoft® Windows® installed.
Can't view publications from TechConnect CD, or text is unreadable.	Be sure you have the Adobe reader installed (available from the TechConnect CD).

Diskette Factory CD	Action
Get "time out" or "Unknown host" errors	Be sure you have access to the Internet through FTP directly.

---

## Diagnostic programs and error messages

The server diagnostic programs are stored in upgradable read-only memory (ROM) on the system board. These programs are the primary method of testing the major components of the server.

Diagnostic error messages indicate that a problem exists; they are not intended to be used to identify a failing part. Troubleshooting and servicing of complex problems that are indicated by error messages should be performed by trained service personnel.

Sometimes the first error to occur causes additional errors. In this case, the server displays more than one error message. Always follow the suggested action instructions for the *first* error message that appears.

The following sections contain the error codes that might appear in the detailed test log and summary log when running the diagnostic programs.

The error code format is as follows:

fff-ttt-iii-date-cc-text message

where:

- fff** is the three-digit function code that indicates the function being tested when the error occurred. For example, function code 089 is for the microprocessor.
- ttt** is the three-digit failure code that indicates the exact test failure that was encountered.
- iii** is the three-digit device ID.
- date** is the date that the diagnostic test was run and the error recorded.
- cc** is the check digit that is used to verify the validity of the information.
- text message** is the diagnostic message that indicates the reason for the problem.

## Text messages

The diagnostic text message format is as follows:

Function Name: Result (test specific string)

where:

### Function Name

is the name of the function being tested when the error occurred. This corresponds to the function code (fff) given in the previous list.

### Result

can be one of the following:

#### Passed

This result occurs when the diagnostic test completes without any errors.

**Failed** This result occurs when the diagnostic test discovers an error.

#### User Aborted

This result occurs when you stop the diagnostic test before it is complete.

#### Not Applicable

This result occurs when you specify a diagnostic test for a device that is not present.

#### Aborted

This result occurs when the test could not proceed because of the system configuration.

#### Warning

This result occurs when a possible problem is reported during the diagnostic test, such as when a device that is to be tested is not installed.

### Test Specific String

This is additional information that you can use to analyze the problem.

## Starting the diagnostic programs

You can press F1 while running the diagnostic programs to obtain Help information. You also can press F1 from within a help screen to obtain online documentation from which you can select different categories. To exit Help and return to where you left off, press Esc.

To start the diagnostic programs:

1. Turn on the server and watch the screen.

**Note:** To run the diagnostic programs, you must start the server with the highest level password that is set. That is, if an administrator password is set, you must enter the administrator password, not the power-on password, to run the diagnostic programs.

2. When the message F2 for Diagnostics appears, press F2.
3. Type in the appropriate password; then, press Enter.
4. Select either **Extended** or **Basic** from the top of the screen.
5. When the Diagnostic Programs screen appears, select the test you want to run from the list that appears; then, follow the instructions on the screen.



**Notes:**

- a. If the server stops during testing and you cannot continue, restart the server and try running the diagnostic programs again.
- b. The keyboard and mouse (pointing device) tests assume that a keyboard and mouse are attached to the server.
- c. If you run the diagnostic programs with no mouse attached to the server, you will not be able to navigate between test categories using the **Next Cat** and **Prev Cat** buttons. All other functions provided by mouse-selectable buttons are also available using the function keys.
- d. You can run the USB interface test and the USB external loopback test only if there are no USB devices attached.
- e. You can view server configuration information (such as system configuration, memory contents, interrupt request (IRQ) use, direct memory access (DMA) use, device drivers, and so on) by selecting **Hardware Info** from the top of the screen.

When the tests have completed, you can view the Test Log by selecting **Utility** from the top of the screen.

If the hardware checks out OK but the problem persists during normal server operations, a software error might be the cause. If you suspect a software problem, refer to the information that comes with the software package.

## Viewing the test log

The test log will not contain any information until after the diagnostic program has run.

**Note:** If you already are running the diagnostic programs, begin with step 3

To view the test log:

1. Turn on the server and watch the screen.  
If the server is on, shut down the operating system and restart the server.
2. When the message F2 for Diagnostics appears, press F2.  
If a power-on password or administrator password is set, the server prompts you for it. Type in the appropriate password; then, press Enter.
3. When the Diagnostic Programs screen appears, select **Utility** from the top of the screen.
4. Select **View Test Log** from the list that appears; then, follow the instructions on the screen.

The system maintains the test-log data while the server is powered on. When you turn off the power to the server, the test log is cleared.

## Diagnostic error message tables

For descriptions of the error messages that might appear when you run the diagnostic programs, see "Diagnostic error codes" on page 103. If diagnostic error messages appear that are not listed in those tables, make sure that the server has the latest levels of BIOS, Advanced System Management Processor, ServeRAID, and diagnostics microcode installed.

---

## Light path diagnostics

The server has LEDs to help you identify problems with some server components. These LEDs are part of the light path diagnostics built into the server. By following the *path* you can quickly identify the type of system error that occurred.

Status LEDs are located on the following components:

- Information panel
- Hard disk drive trays
- Power supply
- Diagnostic panel
- System board

### Power supply LEDs

The ac and dc power LEDs on the power supply provide status information about the power supply. See “Installing a hot-swap power supply” on page 70 for the location of these LEDs.

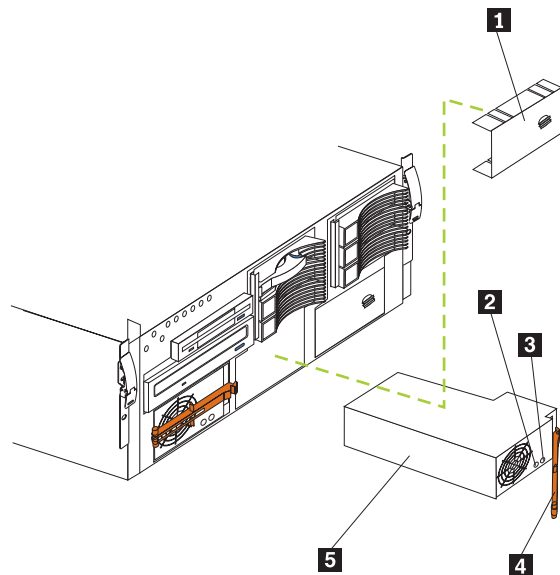

- 1** Filler panel
- 2** AC power light
- 3** DC power light
- 4** Power supply handle
- 5** Power supply

The following table describes the ac and dc power LEDs.

AC power LED	DC power LED	Description and action
On	On	The power supply is on and operating correctly.
On	Off	<p>There is a dc power problem.</p> <p>Possible causes:</p> <ol style="list-style-type: none"> <li>1. The server is not turned on (the power LED is blinking on the front of the server). <b>Action:</b> Press the power-control button to start the server.</li> <li>2. The power supply has failed. <b>Action:</b> Replace the power supply.</li> </ol>
Off	Off	<p>There is an ac power problem.</p> <p>Possible causes:</p> <ol style="list-style-type: none"> <li>1. There is no ac power to the power supply. <b>Actions:</b> Verify that: <ul style="list-style-type: none"> <li>• The electrical cord is properly connected to the server.</li> <li>• The electrical outlet functions properly.</li> </ul> </li> <li>2. The power supply has failed. <b>Action:</b> Replace the power supply.</li> </ol>

## Diagnostic panel LEDs

The following illustration shows the LEDs on the diagnostics panel inside the server. See Table 1 on page 19 for information on identifying problems using these LEDs.

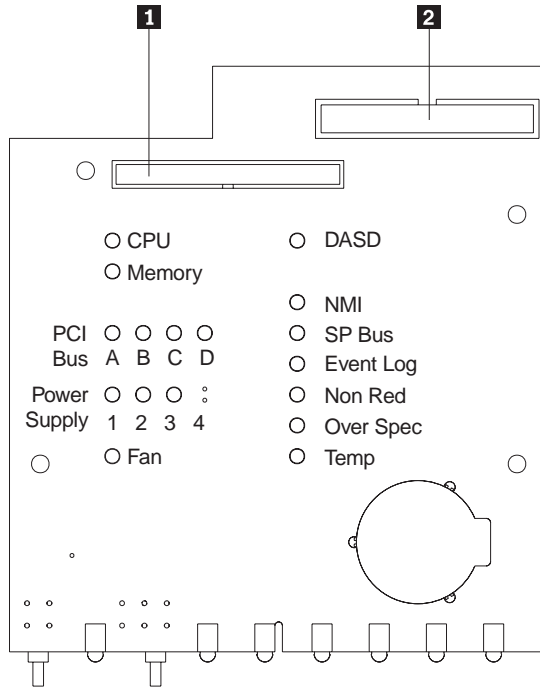

- 1** System board connector
- 2** Diskette drive connector

The meanings of these LEDs are as follows:

<b>CPU</b>	Microprocessor fault
<b>Memory</b>	Memory fault
<b>PCI Bus A (PCIA)</b>	PCI bus A fault
<b>PCI Bus B (PCIB)</b>	PCI bus B fault
<b>PCI Bus C (PCIC)</b>	PCI bus C fault
<b>PCI Bus D (PCID)</b>	Not implemented at this time
<b>Power supply 1</b>	Power supply number 1 failure
<b>Power supply 2</b>	Power supply number 2 failure
<b>Power supply 3</b>	Power supply number 3 failure
<b>FAN</b>	Fan failure
<b>DASD</b>	Hard disk drive fault
<b>NMI</b>	Nonmaskable interrupt
<b>SP Bus</b>	Service processor failure
<b>Event Log</b>	Not implemented at this time.
<b>NON RED</b>	Nonredundant power mode
<b>OVER SPEC</b>	Over specification
<b>TEMP</b>	System temperature failure

**Notes:**

1. The server does not support replaceable voltage regulator modules (VRMs).
2. The server supports a maximum of three PCI buses.
3. The server supports a maximum of three power supplies.

**Light Path Diagnostics**

You can use the light path diagnostics built into the server to quickly identify the type of system error that occurred. The server is designed so that LEDs remain illuminated when the server shuts down, as long as the power supplies are operating properly. This feature helps you to isolate the problem if an error causes the server to shut down.

If the system error LED (on the information LED panel) is not lit and no diagnostics panel LEDs are lit, it means that the light path diagnostics have not detected a system error.

If the system error LED (on the information LED panel) is lit, it means that a system error was detected. Check to see which of the LEDs on the diagnostics panel inside the server are lit and refer to the following table:

Table 1. Light Path Diagnostics

LED on	Cause
None	<ol style="list-style-type: none"> <li>1. The system error log is 75% or more full or a PFA alert was logged. (See “Diagnostic panel error LEDs” on page 101)</li> <li>2. Bad, missing, or mis-installed processor terminator.</li> </ol>
CPU	One of the microprocessors has failed. (See “Diagnostic panel error LEDs” on page 101)
Memory	A memory error occurred. (See “Diagnostic panel error LEDs” on page 101)
PCIA	An error occurred on PCI bus A. An adapter in PCI slot 1, or the system board, caused the error. (See “Diagnostic panel error LEDs” on page 101)
PCIB	An error occurred on PCI bus B. An adapter in PCI slot 2, 3, or 4, or the system board, caused the error. (See “Diagnostic panel error LEDs” on page 101)
PCIC	An error occurred on PCI bus C. An adapter in PCI slot 5 or 6, or the system board, caused the error. (See “Diagnostic panel error LEDs” on page 101)
PCID	Not implemented at this time.
PS1	The first power supply has failed. (See “Diagnostic panel error LEDs” on page 101)
PS2	The second power supply has failed. (See “Diagnostic panel error LEDs” on page 101)
PS3	The third power supply has failed. (See “Diagnostic panel error LEDs” on page 101)
Fan	<p>One of the fan assemblies has failed or is operating too slowly.</p> <p><b>Note:</b> A failing fan can also cause the TEMP and/or DASD LEDs to be on; see “Diagnostic panel error LEDs” on page 101.</p>
DASD	A hot-swap hard disk drive has failed on SCSI channel B (see “Diagnostic panel error LEDs” on page 101).
NMI	<p>A nonmaskable interrupt occurred. (The PCIA, PCIB, PCIC, or Memory LED will probably also be on; see “Diagnostic panel error LEDs” on page 101.)</p> <p><b>Note:</b> The NMI LED can only be reset by completely removing power from system.</p>
SP	The service processor has failed. (See “Diagnostic panel error LEDs” on page 101)
Event Log	Not implemented at this time.
Non Red	System is operating in non-redundant power mode. (See “Diagnostic panel error LEDs” on page 101)

Table 1. Light Path Diagnostics (continued)

LED on	Cause
Over Spec	The server is drawing more power than the power supplies are rated for. (See "Diagnostic panel error LEDs" on page 101)
Temp	The system temperature has exceeded the maximum rating. (See "Diagnostic panel error LEDs" on page 101)

---

## Power checkout

Power problems can be difficult to troubleshoot. For instance, a short circuit can exist anywhere on any of the power distribution busses. Usually a short circuit will cause the power subsystem to shut down because of an overcurrent condition.

A general procedure for troubleshooting power problems is as follows:

1. Power off the system and disconnect the AC cord(s).
2. Check for loose cables in the power subsystem. Also check for short circuits, for instance if there is a loose screw causing a short circuit on a circuit board.
3. Remove adapters and disconnect the cables and power connectors to all internal and external devices until system is at minimum configuration required for power on (see "Minimum operating requirements" on page 122).
4. Reconnect the AC cord and power on the system. If the system powers up successfully, replace adapters and devices one at a time until the problem is isolated. If system does not power up from minimal configuration, replace FRUs of minimal configuration one at a time until the problem is isolated.

To use this method it is important to know the minimum configuration required for a system to power up (see page 122). For specific problems, see "Power error messages" on page 119

---

## Recovering BIOS

If the BIOS code in the server has become corrupted, such as from a power failure during a flash update, you can recover the BIOS using the recovery boot block and a BIOS flash diskette.

**Note:** You can obtain a BIOS flash diskette from one of the following sources:

- Use the ServerGuide program to make a BIOS flash diskette.
- Download a BIOS flash diskette from the World Wide Web. Go to <http://www.pc.ibm.com/support/>, select IBM Server Support, and make the selections for the server.

The flash memory of the server consists of a primary page and a backup page. The J14 jumper controls which page is used to start the server. If the BIOS in the primary page is corrupted, you can use the backup page to start the server; then boot the BIOS Flash Diskette to restore the BIOS to the primary page.

To recover the BIOS:

1. Turn off the server and peripheral devices and disconnect all external cables and power cords; then, remove the cover.
2. Locate jumper J14 on the processor board (see "System board jumpers" on page 44).
3. Move J14 to pins 1 and 2 to enable secondary boot block page.

4. Insert the BIOS flash diskette into the diskette drive.
5. Restart the server.
6. The system begins the power-on self-test (POST). Select 1 – Update POST/BIOS from the menu that contains various flash (update) options.
7. When you are asked if you would like to move the current POST/BIOS image to the backup ROM location, type **N**.  
**Attention:** Typing Y will copy the corrupted BIOS into the secondary page.
8. When you are asked if you would like to save the current code to a diskette, select **N**.
9. You will be asked to choose which language you wish to use. Select your language (0-7) and press **Enter** to accept your choice. You will be prompted to remove the diskette and press **Enter** to restart the system. Remove the flash diskette from the diskette drive.  
**Attention:** Do not press **Enter** to reboot the system at this time.
10. Power-off the server.
11. Move jumper J14 back to pins 2 and 3 to return to normal startup mode.
12. Restart the server. The system should start up normally.

---

## Replacing the battery

The following notes describe information that you must consider when replacing the battery in the server.

- When replacing the battery, you must replace it with a lithium battery of the same type from the same manufacturer.
- To order replacement batteries, call 1-800-772-2227 within the United States, and 1-800-465-7999 or 1-800-465-6666 within Canada. Outside the U.S. and Canada, call your IBM reseller or IBM marketing representative.
- After you replace the battery, you must reconfigure the system and reset the system date and time.
- To avoid possible danger, read and follow the following safety statement.

### Statement 2



#### CAUTION:

**When replacing the lithium battery, use only IBM Part Number 33F8354 or an equivalent type battery recommended by the manufacturer. If your system has a module containing a lithium battery, replace it only with the same module type made by the same manufacturer. The battery contains lithium and can explode if not properly used, handled, or disposed of.**

#### *Do not:*

- Throw or immerse into water
- Heat to more than 100°C (212°F)
- Repair or disassemble

**Dispose of the battery as required by local ordinances or regulations.**

Complete the following steps to replace the battery:

1. Read the information in “Before you begin” on page 50

2. Follow any special handling and installation instructions supplied with the battery.
3. Turn off the server and all attached devices and disconnect all external cables and power cords (see "Safety information" on page 127); then remove the top cover.
4. Locate the battery on the system board (see "System board component locations" on page 42).
5. Remove adapters as necessary so you can access the battery. (See "Working with adapters" on page 54)
6. Lift and remove the plastic dividers by pressing the latches on the top ends of the dividers toward the dividers and lifting the dividers from the server.
7. Remove the battery:
  - a. Use one finger to lift the battery clip over the battery.
  - b. Use one finger to slightly slide the battery toward the rear of the server. The spring mechanism behind the battery will push it out toward you as you slide it forward.
  - c. Use your thumb and index finger to pull the battery from under the battery clip.
  - d. Ensure that the battery clip is touching the base of the battery socket by pressing gently on the clip.

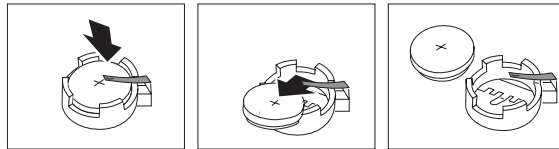

8. Insert the new battery:
  - a. Tilt the battery so that you can insert it into the front of the socket, under the battery clip.
  - b. As you slide it under the battery clip, press the battery down into the socket.

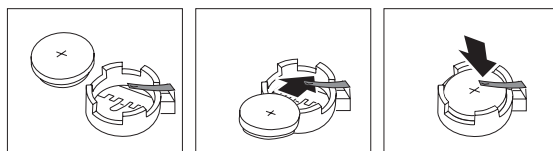

9. Reinstall any adapters that you removed.
10. Insert the plastic dividers into the divider guides.
11. Reinstall the top cover.

**Note:** You must wait approximately 20 seconds after you plug the power cord of the server into an electrical outlet before the power control button becomes active.

12. Start the Configuration/Setup Utility program and set configuration parameters as needed. Refer to "Using the Configuration/Setup Utility program" on page 33



---

## Temperature checkout

Proper cooling of the system is important for proper operation and system reliability. For a typical eServer, you should make sure:

- Each of the drive bays has either a drive or a filler panel installed
- Each of the power supply bays has either a power supply or a filler panel installed
- The top cover is in place during normal operation
- There is at least 50 mm (2 inches) of ventilated space at the sides of the server and 100 mm (4 inches) at the rear of the server
- The top cover is removed for no longer than 30 minutes while the server is operating
- The processor housing cover covering the processor and memory area is removed for no longer than ten minutes while the server is operating
- A removed hot-swap drive is replaced within two minutes of removal
- Cables for optional adapters are routed according to the instructions provided with the adapters (ensure that cables are not restricting air flow)
- The fans are operating correctly and the air flow is good
- A failed fan is replaced within 48 hours

In addition, ensure that the environmental specifications for the system are met. See “Features and specifications” on page 3

**Note:** The speed of the fans will increase if:

- One fan fails.
- Ambient temperature gets too high.

For more information on specific temperature error messages, see “Temperature error messages” on page 118

---

## Diagnosing errors

To find solutions to problems that have definite symptoms, see “Error symptoms” on page 108

If you cannot find the problem there, go to “Starting the diagnostic programs” on page 14 to test the server.

If you have just added new software or a new option and the server is not working, do the following before using the error symptoms table:

- Remove the software or device that you just added.
- Run the diagnostic tests to determine if the server is running correctly.
- Reinstall the new software or new device.

## Troubleshooting the Ethernet controller

This section provides troubleshooting information for problems that might occur with the 10/100 Mbps Ethernet controller.

### Network connection problems

If the Ethernet controller cannot connect to the network, check the following:

- Make sure that the cable is installed correctly.

The network cable must be securely attached at all connections. If the cable is attached but the problem persists, try a different cable.

If you set the Ethernet controller to operate at 100 Mbps, you must use Category 5 cabling.

If you directly connect two workstations (without a hub), or if you are not using a hub with X ports, use a crossover cable.

**Note:** To determine whether a hub has an X port, check the port label. If the label contains an X, the hub has an X port.

- Determine if the hub supports auto-negotiation. If not, try configuring the integrated Ethernet controller manually to match the speed and duplex mode of the hub.
- Check the Ethernet controller lights on the operator information panel.  
These lights indicate whether a problem exists with the connector, cable, or hub.
  - The Ethernet Link Status light illuminates when the Ethernet controller receives a LINK pulse from the hub. If the light is off, there might be a defective connector or cable, or a problem with the hub.
  - The Ethernet Transmit/Receive Activity light illuminates when the Ethernet controller sends or receives data over the Ethernet Network. If the Ethernet Transmit/Receive Activity light is off, make sure that the hub and network are operating and that the correct device drivers are loaded.
  - The Ethernet Speed 100 Mbps light illuminates when the Ethernet controller LAN speed is 100 Mbps.
- Make sure that you are using the correct device drivers, supplied with the server.
- Check for operating system-specific causes for the problem.
- Make sure that the device drivers on the client and server are using the same protocol.
- Test the Ethernet controller.

How you test the Ethernet controller depends on which operating system you are using (see the Ethernet controller device driver README file).

### Ethernet controller troubleshooting chart

You can use the following troubleshooting chart to find solutions to 10/100 Mbps Ethernet controller problems that have definite symptoms.

Table 2. Ethernet troubleshooting chart

Ethernet controller problem	Suggested Action
The server stops running when loading device drivers.	<p>The PCI BIOS interrupt settings are incorrect.</p> <p>Check the following:</p> <ul style="list-style-type: none"> <li>• Determine if the interrupt (IRQ) setting assigned to the Ethernet controller is also assigned to another device in the Configuration/Setup Utility program.</li> </ul> <p>Although interrupt sharing is allowed for PCI devices, some devices do not function well when they share an interrupt with a dissimilar PCI device. Try changing the IRQ assigned to the Ethernet controller or the other device. For example, for NetWare Versions 3 and 4 it is recommended that disk controllers not share interrupts with LAN controllers.</p> <ul style="list-style-type: none"> <li>• Make sure that you are using the most recent device driver available from the World Wide Web.</li> <li>• Run the network diagnostic program.</li> </ul>

Table 2. Ethernet troubleshooting chart (continued)

Ethernet controller problem	Suggested Action
Ethernet Link Status light does not light.	Check the following: <ul style="list-style-type: none"> <li>• Make sure that the hub is turned on.</li> <li>• Check all connections at the Ethernet controller and the hub.</li> <li>• Check the cable. A crossover cable is required unless the hub has an X designation.</li> <li>• Use another port on the hub.</li> <li>• If the hub does not support auto-negotiation, manually configure the Ethernet controller to match the hub.</li> <li>• If you manually configured the duplex mode, make sure that you also manually configure the speed.</li> <li>• Run diagnostics on the LEDs.</li> </ul>
The Ethernet Transmit/Receive Activity light does not light.	Check the following: <p><b>Note:</b> The Ethernet Transmit/Receive Activity LED illuminates only when data is sent to or by this Ethernet controller.</p> <ul style="list-style-type: none"> <li>• Make sure that you have loaded the network device drivers.</li> <li>• The network might be idle. Try sending data from this workstation.</li> <li>• Run diagnostics on the LEDs.</li> <li>• The function of this LED can be changed by device driver load parameters. If necessary, remove any LED parameter settings when you load the device drivers.</li> </ul>
Data is incorrect or sporadic.	Check the following: <ul style="list-style-type: none"> <li>• Make sure that you are using Category 5 cabling when operating the server at 100 Mbps.</li> <li>• Make sure that the cables do not run close to noise-inducing sources like fluorescent lights.</li> </ul>
The Ethernet controller stopped working when another adapter was added to the server.	Check the following: <ul style="list-style-type: none"> <li>• Make sure that the cable is connected to the Ethernet controller.</li> <li>• Make sure that the PCI system BIOS is current.</li> <li>• Reseat the adapter.</li> <li>• Determine if the interrupt (IRQ) setting assigned to the Ethernet adapter is also assigned to another device in the Configuration/Setup Utility program.</li> </ul> <p>Although interrupt sharing is allowed for PCI devices, some devices do not function well when they share an interrupt with a dissimilar PCI device. Try changing the IRQ assigned to the Ethernet adapter or the other device.</p>
The Ethernet controller stopped working without apparent cause.	Check the following: <ul style="list-style-type: none"> <li>• Run diagnostics for the Ethernet controller.</li> <li>• Try a different connector on the hub.</li> <li>• Reinstall the device drivers. Refer to the operating-system documentation and to the ServerGuide information.</li> </ul>

## Ethernet controller messages

The integrated Ethernet controller might display messages from the following device drivers:

- Novell NetWare or IntraNetWare Server ODI
- NDIS Adapter for level 2.01 (OS/2®)
- NDIS Adapter for level 4.0 Microsoft Windows NT
- SCO UNIX® LLI

### Novell NetWare or IntraNetWare server ODI driver messages

This section provides explanations of the error messages for the Novell NetWare or IntraNetWare server ODI driver, and suggested actions to resolve each problem.

Table 3. Novell NetWare or IntraNetWare ODI driver messages for the Ethernet controller

PCNTNW-NW-026	<p><b>The MSM is unable to parse a required custom keyword.</b></p> <p><b>Explanation:</b> The user entered an incorrect parameter keyword.  <b>Action:</b> Reload the driver using the correct keyword.</p>
PCNTNW-NW-054	<p><b>The adapter did not respond to the initialization command.</b></p> <p><b>Explanation:</b> The adapter did not respond when the driver tried to initialize it.  <b>Action:</b> Verify that the Ethernet controller is enabled. If the Ethernet controller is enabled, go to "Starting the diagnostic programs" on page 14 to run the diagnostic programs.</p>
PCNTNW-NW-058	<p><b>The adapter did not respond to the initialization command.</b></p> <p><b>Explanation:</b> The interrupt request (IRQ) setting might not be valid or the EEPROM information might be incorrect.  <b>Action:</b> Make sure the IRQ settings are correct in the Configuration/Setup Utility program. for information on setting the interrupt requests. If the IRQ settings are correct, go to "Starting the diagnostic programs" on page 14 to run the diagnostic programs.</p>
PCNTNW-NW-066	<p><b>The cable might be disconnected from the adapter.</b></p> <p><b>Explanation:</b> The cable might be disconnected from the server Ethernet port.  <b>Action:</b> Verify that a cable is connected to the Ethernet port.</p>
PCNTNW-NW-071	<p><b>The matching virtual adapter could not be found.</b></p> <p><b>Explanation:</b> You tried to load another instance of the driver with a different I/O address. This new adapter could not be found.  <b>Action:</b> Verify that you installed an IBM 10/100 Fault Tolerant Adapter and make sure that the adapter is seated correctly. If the adapter is seated correctly, go to "Starting the diagnostic programs" on page 14 to run the diagnostic programs.</p>
PCNTNW-NW-072	<p><b>A resource tag is unavailable.</b></p> <p><b>Explanation:</b> The driver tried to allocate some resources that were not available.  <b>Action:</b> Add more memory, or free some memory resources in the server. Then, restart the server.</p>
PCNTNW-NW-073	<p><b>Unable to allocate memory</b></p> <p><b>Explanation:</b> The driver failed to allocate the memory needed for normal operation.  <b>Action:</b> Add more memory, or free some memory resources in the server. Then, restart the server.</p>
PCNTNW-NW-074	<p><b>The hardware interrupt cannot be set.</b></p> <p><b>Explanation:</b> An attempt was made to initialize a given hardware interrupt. The attempt was not successful.  <b>Action:</b> Verify that the Ethernet controller is enabled. If the Ethernet controller is enabled, go to "Starting the diagnostic programs" on page 14 to run the diagnostic programs. If you have an Ethernet adapter installed, make sure that the adapter does not share an IRQ with any other device.</p>
PCNTNW-NW-075	<p><b>The Multiple Link Interface Driver (MLID) cannot be registered with the Link Support Layer (LSL).</b></p> <p><b>Explanation:</b> An error occurred while the driver was trying to register with the LSL.  <b>Action:</b> Check the version of the NetWare or IntraNetWare Operating System. Make sure that this driver is correct for the version of NetWare or IntraNetWare that you are using. Restart the server.</p>

Table 3. Novell NetWare or IntraNetWare ODI driver messages for the Ethernet controller (continued)

PCNTNW-NW-079	<p><b>The Multiple Link Interface Driver (MLID) did not initialize MSMTx Free Count.</b></p> <p><b>Explanation:</b> The MSMTx Free Count is not initialized correctly.  <b>Action:</b> Restart the server. If the problem persists, go to “Starting the diagnostic programs” on page 14 to run the diagnostic programs.</p>
PCNTNW-NW-086	<p><b>The driver parameter block is too small.</b></p> <p><b>Explanation:</b> The driver parameter block is too small.  <b>Action:</b> Restart the server. If the problem persists, go to “Starting the diagnostic programs” on page 14 to run the diagnostic programs.</p>
PCNTNW-NW-087	<p><b>The media parameter block is too small.</b></p> <p><b>Explanation:</b> The driver media parameter block is too small.  <b>Action:</b> Restart the server. If the problem persists, go to “Starting the diagnostic programs” on page 14 to run the diagnostic programs.</p>
PCNTNW-NW-091	<p><b>The hardware configuration conflicts.</b></p> <p><b>Explanation:</b> You tried to load a new frame type for the existing controller. The hardware assumptions made in doing so are incorrect. This error can also occur if you try to specify a mode (such as, redundancy) that conflicts with another specified mode.  <b>Action:</b> Make sure that the hardware configuration matches the software settings.</p>
PCNTNW-NW-126	<p><b>The group bit in the node address override was cleared.</b></p> <p><b>Explanation:</b> The IEEE address has a group bit that indicates that an address belongs to a group of stations. This bit is used only as a destination address; it cannot be used as a source address. You tried to enter a source address with this bit set. The driver cleared the group bit of the source address.  <b>Action:</b> None necessary, message is for information only.</p>
PCNTNW-NW-127	<p><b>The local bit in the node address override was set.</b></p> <p><b>Explanation:</b> The local bit in the IEEE address format indicates that the addresses are being managed locally. If you use the node address override capabilities of this driver to enter a new address, the local bit must be set. You entered an address without the local bit set. The driver has set the local bit.  <b>Action:</b> None necessary, message is for information only.</p>
PCNTNW-NW-164	<p><b>The device was not found.</b></p> <p><b>Explanation:</b> The driver cannot find an Ethernet controller in the server.  <b>Action:</b> Verify that the Ethernet controller is enabled. If the Ethernet controller is enabled, go to “Starting the diagnostic programs” on page 14 to run the diagnostic programs.</p>
PCNTNW-NW-165	<p><b>The device was not found at IOADDRESS.</b></p> <p><b>Explanation:</b> The Ethernet controller cannot be found at the I/O address specified.  <b>Action:</b> The Ethernet controller does not require a parameter for the I/O address. Remove the I/O address parameter.</p>
PCNTNW-NW-167	<p><b>PCI scan specified, device not found.</b></p> <p><b>Explanation:</b> The driver cannot locate the Ethernet controller on the PCI bus.  <b>Action:</b> Verify that the Ethernet controller is enabled. If the problem persists, go to “Starting the diagnostic programs” on page 14 to run the diagnostic programs.</p>
PCNTNW-NW-180	<p><b>The DMA parameter is not necessary for PCI device.</b></p> <p><b>Explanation:</b> The Ethernet controller does not require a DMA setting.  <b>Action:</b> None necessary, message is for information only.</p>

## Network driver interface specification 2.01 (OS/2) driver messages

This section provides explanations of the error messages for the NDIS 2.01 (OS/2) drivers, and suggested actions to resolve each problem.

Table 4. NDIS 2.01 (OS/2) driver messages for the Ethernet controller

PCNTND-1	<p><b>Unable to open the Protocol Manager.</b></p> <p><b>Explanation:</b> The NDIS stack is not configured correctly.  <b>Action:</b> Check and correct the configuration.</p>
PCNTND-6	<p><b>Out of memory while allocating buffers.</b></p> <p><b>Explanation:</b> The driver could not allocate the requested buffers.  <b>Action:</b> Check the system configuration. Edit the PROTOCOL.INI file to reduce the number of Tx buffers and Rx buffers specified for the driver.</p>
PCNTND-7	<p><b>A Protocol Manager device error occurred.</b></p> <p><b>Explanation:</b> The NDIS stack is not configured correctly.  <b>Action:</b> Check and correct the configuration.</p>
PCNTND-8	<p><b>Bad status for the Protocol Manager.</b></p> <p><b>Explanation:</b> The NDIS stack is not configured correctly in the PROTOCOL.INI file.  <b>Action:</b> Check and correct the configuration.</p>
PCNTND-9	<p><b>Cannot find the PROTOCOL.INI entry.</b></p> <p><b>Explanation:</b> The NDIS stack is not configured correctly in the PROTOCOL.INI file.  <b>Action:</b> Check and correct the configuration.</p>
PCNTND-10	<p><b>The Protocol Manager Input Output Control (IOCTL) failed.</b></p> <p><b>Explanation:</b> The NDIS stack is not configured correctly in the PROTOCOL.INI file.  <b>Action:</b> Check and correct the configuration.</p>
PCNTND-11	<p><b>Protocol Manager registration failed.</b></p> <p><b>Explanation:</b> The NDIS stack is not configured correctly.  <b>Action:</b> Check and correct the configuration.</p>
PCNTND-15	<p><b>Device not found.</b></p> <p><b>Explanation:</b> The driver cannot find an Ethernet controller in the server.  <b>Action:</b> Verify that the Ethernet controller is enabled. If the Ethernet controller is enabled, go to "Starting the diagnostic programs" on page 14 to run the diagnostic programs.</p>
PCNTND-16	<p><b>PCI scan specified, device not found.</b></p> <p><b>Explanation:</b> The driver cannot locate the Ethernet controller on the PCI bus.  <b>Action:</b> Verify that the Ethernet controller is enabled. If the Ethernet controller is enabled, go to "Starting the diagnostic programs" on page 14 to run the diagnostic programs.</p>
PCNTND-21	<p><b>The adapter failed the checksum test.</b></p> <p><b>Explanation:</b> The driver cannot find an Ethernet controller.  <b>Action:</b> Verify that the Ethernet controller is enabled. If the Ethernet controller is enabled, go to "Starting the diagnostic programs" on page 14 to run the diagnostic programs.</p>

Table 4. NDIS 2.01 (OS/2) driver messages for the Ethernet controller (continued)

PCNTND-23	<p><b>WARNING: PCNET IRQ found = xx</b></p> <p><b>Explanation:</b> The interrupt request (IRQ) setting (xx) in the PROTOCOL.INI file does not match the hardware IRQ setting.</p> <p><b>Action:</b> Remove the IRQ setting from the PROTOCOL.INI file or change the IRQ setting in the PROTOCOL.INI file to match the IRQ setting shown in the <b>PCI Slot/Device Information</b> selection of the Advanced Setup menu in the Configuration/Setup Utility program.</p>
PCNTND-24	<p><b>WARNING: PCNET IRQ does not match PROTOCOL.INI.</b></p> <p><b>Explanation:</b> The interrupt request (IRQ) setting in the PROTOCOL.INI file does not match the hardware IRQ setting.</p> <p><b>Action:</b> Remove the IRQ setting from the PROTOCOL.INI file or change the IRQ setting in the PROTOCOL.INI file to match the IRQ setting shown in the <b>PCI Slot/Device Information</b> selection of the Advanced Setup menu in the Configuration/Setup Utility program.</p>
PCNTND-25	<p><b>PCI scan specified, PCI bus not found!</b></p> <p><b>Explanation:</b> The driver cannot locate the PCI bus.</p> <p><b>Action:</b> Run the diagnostic programs.</p>
PCNTND-29	<p><b>WARNING: DMA number is not necessary for PCI device.</b></p> <p><b>Explanation:</b> The Ethernet controller does not require a DMA setting.</p> <p><b>Action:</b> Remove the DMA setting in the PROTOCOL.INI file.</p>
PCNTND-33	<p><b>PCNET device with specified IOBASE is already in use.</b></p> <p><b>Explanation:</b> The specified I/O address number is already in use by another Ethernet controller or device.</p> <p><b>Action:</b> Remove the I/O address setting in the PROTOCOL.INI file.</p>

### NDIS 4.0 (Windows NT) driver messages

This section contains the error messages for the NDIS 4.0 drivers. The explanation and recommended action are included with each message.

Table 5. NDIS (Windows NT) driver messages for the Ethernet controller

PermaNet™ Server:	<p><b>No Secondary Adapter Found. Grouping Mode is disabled.</b></p> <p><b>Explanation:</b> The failover option requires an adapter that is compatible with the device driver of the Ethernet controller on the system board. No such adapter was found.</p> <p><b>Action:</b> Make sure the correct adapter is installed.</p>
PermaNet Server:	<p><b>Problem Occurs on the Primary Adapter. Switching over to the Secondary Adapter.</b></p> <p><b>Explanation:</b> The system detected a problem with the primary Ethernet connection and has transferred all network traffic to the secondary Ethernet controller.</p> <p><b>Action:</b> identify the cause of the failure on the primary Ethernet connection. Restoring the operational state of the primary connection will cause the network traffic to automatically transfer to the primary Ethernet controller.</p>
PermaNet Server:	<p><b>Switching back to Primary Adapter.</b></p> <p><b>Explanation:</b> The primary Ethernet connection is now operating correctly. Network traffic will automatically transfer to the primary Ethernet controller.</p> <p><b>Action:</b> None needed, message is for information only.</p>

## UNIX messages

This section provides descriptions of the Ethernet error messages for the SCO UNIX LLI driver, and suggested actions to resolve each problem.

Table 6. UNIX LLI driver messages for the Ethernet controller

pnt0-2	<p><b>PCI search specified, PCI device not found!</b></p> <p><b>Explanation:</b> The driver cannot locate the Ethernet controller on the PCI bus.</p> <p><b>Action:</b></p> <ul style="list-style-type: none"> <li>• Run the NETCONFIG program to search for another Ethernet controller</li> <li>• Verify that the Ethernet controller is enabled. If the Ethernet controller is enabled, run the diagnostic programs.</li> </ul>
pnt0-6	<p><b>Cannot allocate memory for the adapter during an interrupt. Please check the Streams parameters.</b></p> <p><b>Explanation:</b> On a SunSoft Solaris system, this message indicates that the system is out of Streams memory blocks.</p> <p><b>Action:</b> Use the CRASH utility to increase the number of Streams memory blocks. Modify the interrupt request (IRQ) settings in the Configuration/Setup Utility program, or run the NETCONFIG program to match the hardware settings.</p>
pnt0-7	<p><b>Cannot allocate memory for the adapter during reset. Please check the Streams parameters.</b></p> <p><b>Explanation:</b> The system is out of Streams memory blocks.</p> <p><b>Action:</b> Use the CRASH utility to increase the number of Streams memory blocks.</p>
pnt0-11	<p><b>Device not found!</b></p> <p><b>Explanation:</b> The driver cannot find an Ethernet controller.</p> <p><b>Action:</b> Verify that the Ethernet controller is enabled. If the Ethernet controller is enabled, run the diagnostic programs.</p>
pnt0-12	<p><b>Device failed checksum test!</b></p> <p><b>Explanation:</b> The driver cannot find an Ethernet controller.</p> <p><b>Action:</b> Verify that the Ethernet controller is enabled. If the Ethernet controller is enabled, run the diagnostic programs.</p>
pnt0-13	<p><b>add_intr_handler failed! Interrupts already enabled.</b></p> <p><b>Explanation:</b> The interrupt request (IRQ) that was specified, or the IRQ that was found, conflicts with other devices in the server.</p> <p><b>Action:</b> Modify the hardware settings.</p>
pnt0-14	<p><b>Cannot locate hardware.</b></p> <p><b>Explanation:</b> The SunSoft Solaris driver cannot find any Ethernet controller.</p> <p><b>Action:</b> Verify that the Ethernet controller is enabled. If the Ethernet controller is enabled, run the diagnostic programs.</p>
pnt0-15	<p><b>No more devices to open.</b></p> <p><b>Explanation:</b> The SunSoft Solaris driver cannot find any more Ethernet controllers. <b>Action:</b> Verify that additional IBM 10/100 Fault Tolerant Adapters are present or replace the Ethernet adapter that fails to respond. If the problem persists, run the diagnostic programs.</p>
pnt0-17	<p><b>Device fault...Reset initiated!</b></p> <p><b>Explanation:</b> The SunSoft Solaris driver has been reset due to a device fault.</p> <p><b>Action:</b> Verify that additional IBM 10/100 Fault Tolerant Adapters are present or replace the Ethernet adapter that fails to respond. If the problem persists, run the diagnostic programs.</p>



Table 6. UNIX LLI driver messages for the Ethernet controller (continued)

pnt0-19	<p><b>IRQ found for PCnet hardware does not match space.c (or pnt.conf)!</b></p> <p><b>Explanation:</b> This is a warning message referring to the interrupt request (IRQ) that the SunSoft Solaris driver found in the system.  <b>Action:</b> Ignore this message if you are sure that this is what you want to do. Otherwise, run the NETCONFIG program to match the hardware settings</p>
pnt0-20	<p><b>add_intr_handler failed! Unknown interrupt type.</b></p> <p><b>Explanation:</b> The interrupt request (IRQ) that was specified, or the IRQ that was found, conflicts with other devices in the server. <b>Action:</b></p> <ul style="list-style-type: none"> <li>• Modify the hardware settings.</li> <li>• Run the NETCONFIG program to search for another Ethernet controller.</li> </ul>
pnt0-21	<p><b>add_intr_handler failed! Out of range interrupt number.</b></p> <p><b>Explanation:</b> The interrupt request (IRQ) that was specified, or the IRQ that was found, conflicts with other devices in the server. <b>Action:</b></p> <ul style="list-style-type: none"> <li>• Modify the hardware settings.</li> <li>• Run the NETCONFIG program to search for another Ethernet controller.</li> </ul>
pnt0-22	<p><b>add_intr_handler failed! Out of range IPL.</b></p> <p><b>Explanation:</b> The interrupt request (IRQ) that was specified, or the IRQ that was found, conflicts with other devices in the server.  <b>Action:</b> Modify the hardware settings. Run the NETCONFIG program to search for another Ethernet controller.</p>
pnt0-23	<p><b>add_intr_handler failed! Vector already occupied.</b></p> <p><b>Explanation:</b> The interrupt request (IRQ) that was specified, or the IRQ that was found, conflicts with other devices in the server.  <b>Action:</b> Modify the hardware settings.</p>
pnt0-24	<p><b>add_intr_handler failed! Vector already shared at different IPL.</b></p> <p><b>Explanation:</b> The interrupt request (IRQ) that was specified, or the IRQ that was found, conflicts with other devices in the server. <b>Action:</b></p> <ul style="list-style-type: none"> <li>• Modify the hardware settings.</li> <li>• Run the NETCONFIG program to search for another Ethernet controller.</li> </ul>
pnt0-26	<p><b>The DMA number is not necessary for PCI device.</b></p> <p><b>Explanation:</b> The IBM 10/100 Fault Tolerant Adapter does not require a DMA setting.  <b>Action:</b> Edit the SPACE.C file to delete the DMA parameter.</p>
pnt0-29	<p><b>The IRQ number is already in use.</b></p> <p><b>Explanation:</b> The specified I/O address is already in use.  <b>Action:</b> Run the NETCONFIG program to modify the hardware settings.</p>
pnt0-31	<p><b>I/O address is not necessary for the PCI device.</b></p> <p><b>Explanation:</b> The I/O address specified is not required.  <b>Action:</b> Remove the assigned I/O address specified for the Ethernet controller.</p>



---

## Configuring the server

In addition to the ServerGuide CDs, you can use the following configuration programs to customize your server hardware:

- **Configuration/Setup Utility**

The Configuration/Setup Utility program is part of the *basic input/output system (BIOS)* code that comes with the server. You can use this program to configure serial and parallel port assignments, change interrupt request (IRQ) settings, change the drive startup sequence, set the date and time, and set passwords. See “Using the Configuration/Setup Utility program” for more information.

- **SCSISelect Utility**

With the built-in SCSISelect Utility program, you can configure the devices attached to the integrated SCSI controller. Use this program to change default values, resolve configuration conflicts, and perform a low-level format on a SCSI hard disk drive. See “Using the SCSISelect utility program” on page 39 for more information.

- **ServeRAID programs**

The ServeRAID programs come with the optional ServeRAID adapters and with server models that have a ServeRAID adapter preinstalled. If a ServeRAID adapter has been installed in the server, you must use the ServeRAID configuration program to define and configure the disk-array subsystem before you install the operating system.

- **ServerGuide CDs**

The ServerGuide CDs include software setup and installation tools specifically designed for xSeries servers. You can use these CDs during the initial installation of the server to configure the server hardware and simplify the network operating system installation. The ServerGuide CDs also contain a collection of application programs, which you can install after the server is up and running.

---

## Using the Configuration/Setup Utility program

This section provides the instructions needed to start the Configuration/Setup Utility program and descriptions of the menu choices available.

### Starting the Configuration/Setup Utility program

To start the Configuration/Setup Utility program:

1. Turn on the server and watch the monitor screen.
2. When the message Press F1 for Configuration/Setup appears, press F1.

**Note:** If you have set both levels of passwords (user and administrator), you must enter the administrator password to access the full Configuration/Setup menu.

3. Follow the instructions that appear on the screen.

## Choices available from the Configuration/Setup main menu

From the Configuration/Setup Utility main menu, you can select settings that you want to change. The Configuration/Setup Utility main menu is similar to the following:

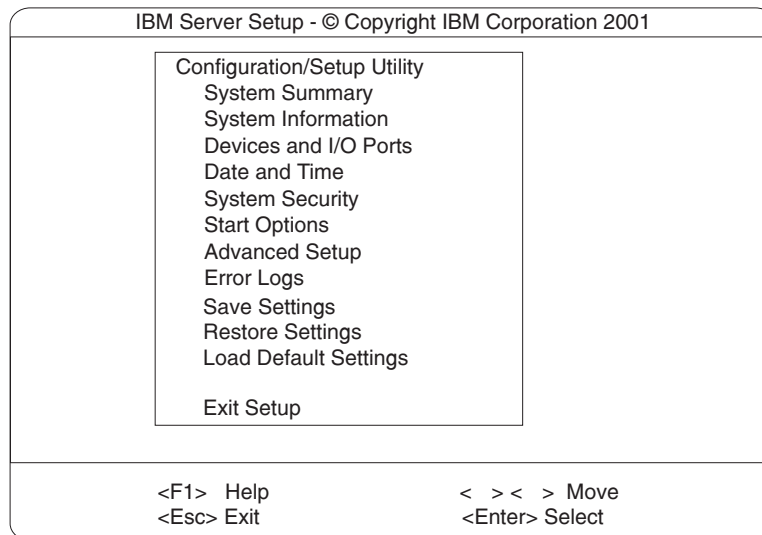

### Notes:

1. You can press F1 to display Help information for a selected menu item.
2. The choices on some menus might differ slightly, depending on the BIOS version in the server.

Descriptions of the choices available from the main menu are as follows:

- **System Summary**

Select this choice to display configuration information. This includes the type and speed of the microprocessors and the amount of memory installed.

Changes that you make to configuration settings appear on this summary screen. You cannot edit the fields.

This choice appears on both the full and limited Configuration/Setup Utility menus.

- **System Information**

Select this choice to display information about the server. Changes that you make on other menus might appear on this summary screen. You cannot edit any fields. The System Information choice appears only on the full Configuration/Setup Utility main menu.

- **Product Data**

Select this choice to view system information, such as the machine type and model, the server serial number, and the revision level or issue date of the BIOS stored in the flash electronically erasable programmable ROM (EEPROM).

- **System Card Data**

Select this choice to view vital product data (VPD) for some server components.

- **Devices and I/O Ports**

Select this choice to view or change the assignments for devices and input/output ports. This choice appears only on the full Configuration/Setup Utility main menu.

This choice also allows you to enable or disable the integrated SCSI, video, and Ethernet controllers.

- The default setting is Enable for all the controllers. If you select Disable, the system will not configure the disabled device and the operating system will not see the device. (This is equivalent to unplugging the device.)
  - If the on-board SCSI controller is disabled and no other controller and mass storage device are installed, operating system startup cannot occur.
  - If the video controller is disabled and no video adapter is installed, the server will have no video capability.
- Select **System Service Processor Settings** to view the interrupt-request setting (IRQ) used by the Advanced System Management Processor (system service processor). You can then use the arrow keys to select a new IRQ setting for the Advanced System Management Processor from the list of available choices.

- **Date and Time**

Select this choice to set the system date and time and to change the system time sent to the Advanced System Management Processor (service processor) when the server is started. This choice appears only on the full Configuration/Setup Utility main menu.

The system time is in a 24-hour format: hour:minute:second.

You can set a time delta to be added or subtracted from the system time that is sent to the service processor (Advanced System Management Processor) each time the server is started. Use the number keys to enter the hours and minutes and + or – to add or subtract from the system time. If you want the system clock time to be the same as the Advanced System Management Processor clock time, leave the value set at its default of 0.

- **System Security**

Select this choice to set passwords or a system owner's name. This choice appears only on the full Configuration/Setup Utility main menu.

You can implement two levels of password protection:

- **Power-on Password**

Select this choice to set or change a power-on password. See "Using passwords" on page 37 for more information.

- **Administrator Password**

Select this choice to set or change an administrator password.

**Attention:**

If an administrator password is set and then forgotten, it cannot be overridden or removed. You must replace the system board.

The administrator password provides access to all choices on the Configuration/Setup Utility main menu. You can set, change, or delete both the administrator and power-on passwords, and allow a power-on password to be changed by the user.

See "Using passwords" on page 37 for more information.

- **Start Options**

Select this choice to view or change the start options. This choice appears only on the full Configuration/Setup Utility main menu. Start options take effect when you start your server.

You can select keyboard operating characteristics, such as the keyboard speed. You also can specify whether the keyboard number lock starts on or off. You also can enable the server to run without a diskette drive, monitor, or keyboard.

The server uses a startup sequence to determine the device from which the operating system loads. For example, you can define a startup sequence that checks for a startable diskette in the diskette drive, then checks the hard disk drive in bay 1, and then checks a network adapter.

If the **Boot Fail Count** choice is enabled, you can restore the BIOS system defaults after three consecutive boot failures. If this choice is disabled, the BIOS system defaults can only be loaded from the Configuration/Setup Utility main menu.

You can enable a virus-detection test that checks for changes in the master boot record at startup.

- **Advanced Setup**

Select this choice to change values for advanced hardware features, such as cache control, and PCI configuration. This choice appears only on the full Configuration/Setup Utility main menu.

A warning message appears above the choices on this menu to alert you that the system might malfunction if these options are configured incorrectly. Follow the instructions on the screen carefully.

- **Processor Serial Number Access**

Select this choice to identify if the microprocessor serial number in the microprocessor is readable.

- **System Partition Visibility**

Select this choice to identify if the System Partition is visible. To make System Partition visible, set this value to **Visible**. To make System Partition invisible, set this value to **Hidden**.

- **Core Chipset Control**

Select this choice to modify settings that control features of the core chip set on the system board.

**Attention:** Do not make changes here unless directed to do so by an IBM authorized service representative.

- **PCI Slot/Device Information**

Select this choice to view and identify system resources used by PCI devices. PCI devices automatically communicate with the server configuration information. This usually results in automatic configuration of a PCI device.

**Attention:** You must use the menu selections to save custom settings for the PCI Slot/Device Information choice. The save, restore and load default settings choices on the main menu of the Configuration/Setup Utility do not save the PCI Slot/Device Information settings.

After making changes, select:

- **Save and exit the PCI Utility** to save the changes and return to the Advanced Setup choice.
- **Exit the PCI Utility without saving changes** to ignore the changes, restore the previous settings, and return to the Advanced Setup choice.

**PCI Device Control** allows you to enable or disable the PCI slots from this menu.

- The default setting is Enable for all the PCI slots. If you select Disable, the system will not configure the disabled device and the operating system will not see the device. (This is equivalent to unplugging the device.)

- **Cache Control**

Select this choice to enable or disable the microprocessor cache. In addition, you can define the microprocessor cache type as write-back (WB) or write-through (WT). Selecting write-back mode will provide the maximum system performance.

- **Memory Settings**

Select this choice to manually enable a bank of memory.

If a memory error is detected during POST or memory configuration, the server can automatically disable the failing memory bank and continue operating with reduced memory capacity. If this occurs, you must manually enable the memory bank after the problem is corrected. Select **Memory Settings** from the Advanced Setup menu, use the arrow keys to highlight the bank that you want to enable; then, use the arrow keys to select **Enable**.

- **Hot Swap PCI Slot Power Control**

Select this choice to manually force power on to any of the six Active PCI (hot-plug) slots. This is used for PCI adapters that do not have the presence detect pins that the system hot-plug controller uses to turn power on to a slot.

- **System Service Processor Settings**

Select this choice to view the interrupt-request setting (IRQ) used by the Advanced System Management Processor (system service processor). You can then use the arrow keys to select a new IRQ setting for the Advanced System Management Processor from the list of available choices.

- **Event Logs**

Select this choice to view or clear error logs.

- Select **POST Error Log** to view the three most recent error codes and messages that the system generated during POST.

Select **Clear error logs** from the POST Error Log menu to clear the error log.

- Select **System Event/Error Log** to view the system event/error log. The system event/error log contains all the system error and warning messages that the system has generated. You can use the arrow keys to move between pages in the system event/error log.

Select **Clear error logs** from the System Event/Error Log menu to clear the error or event log.

- **Save Settings**

Select this choice to save the customized settings.

- **Restore Settings**

Select this choice to delete the changes and restore the previous settings.

- **Load Default Settings**

Select this choice to cancel the changes and restore the factory settings.

- **Exit Setup**

If you have made any changes, the program will prompt you to save the changes or exit without saving the changes.

## Using passwords

The **System Security** choice appears only on the full Configuration/Setup Utility menu. After you select this choice, you can implement two levels of protection: power-on password and administrator password.

## Power-on password

After you set a power-on password, you can enable the unattended-start mode. This locks the keyboard and mouse, but allows the server to start the operating system. The keyboard and mouse remain locked until you enter the correct password.

You can use any combination of up to seven characters (A–Z, a–z, and 0–9) for the power-on password. Keep a record of the password in a secure place. If you forget the power-on password, you can regain access to the server by removing the battery and then installing the battery, or by overriding or bypassing the power-on password; see “Setting the password override jumper”

**Setting the password override jumper:** When a power-on password is set, POST does not complete until you enter the password. If you forget the power-on password, you can regain access to the server through either of the following methods:

- Enter the administrator password at the power-on prompt, if an administrator password has been set. (See “Administrator password” for details.) Start the Configuration/Setup Utility program and change the power-on password. See “Power-on password”
- Change the position of the jumper on J15 to bypass the power-on password check. You can then start the Configuration/Setup Utility program and change the power-on password. See “System board component locations” on page 42 for the location of J15.

### Notes:

1. Turn off the server, and disconnect all power cords before moving any jumpers.
2. Jumpers J19 and J3 are located on the same jumper block as jumper J15 on the system board. These jumpers are set to **Disabled**. Do not change the settings on these jumpers.

**Attention:** If you change the settings on these jumpers, the server will fail.

Table 7. Jumper J15 on the system board

Jumper name	Description
J15 Power-on password override	Changing the position of this jumper bypasses the power-on password check if the jumper has been moved since the server was last powered on. You do not need to move the jumper back to the default position after the password is overridden. The default position is a jumper on pins 1 and 2.  Changing the position of this jumper does not affect the administrator password check if an administrator password is set.

For more information on jumper locations, see “Changing jumper positions” on page 69

## Administrator password

Select this choice to set an administrator password. The administrator password provides access to all choices on the Configuration/Setup Utility main menu. You can set, change, or delete both the administrator and power-on passwords, and allow a power-on password to be changed by the user.

**Attention:** If an administrator password is set and then forgotten, it cannot be overridden or removed. You must replace the system board.



The following table provides a summary of the password features.

Table 8. Power-on and administrator password features

Type of password	Results
Power-on password	<ul style="list-style-type: none"> <li>• Enter the password to complete the system startup.</li> <li>• All choices are available on the Configuration/Setup Utility main menu.</li> </ul>
Administrator password	<ul style="list-style-type: none"> <li>• No password is required to start the system.</li> <li>• Enter the password to access the Configuration/Setup Utility program.</li> <li>• All choices are available on the Configuration/Setup Utility main menu.</li> </ul>
Administrator <i>and</i> power-on password	<ul style="list-style-type: none"> <li>• You can enter either password to complete the system startup.</li> <li>• The administrator password provides access to all choices on the Configuration/Setup Utility main menu. You can set, change, or delete both the administrator and power-on passwords, and allow a power-on password to be changed by the user.</li> <li>• The power-on password provides access to a limited set of choices on the Configuration/Setup Utility main menu. This limited access might include changing or deleting the power-on password.</li> </ul>

---

## Using the SCSISelect utility program

SCSISelect is a built-in, menu-driven configuration utility program that you can use to:

- View the default SCSI IDs
- Locate and correct configuration conflicts
- Perform a low-level format on a SCSI hard disk

The following sections provide the instructions needed to start the SCSISelect Utility and descriptions of the menu choices available.

**Note:** If the server has a RAID adapter installed, use the configuration method supplied with the RAID adapter to view or change SCSI settings for attached devices.

## Starting the SCSISelect utility program

To start the SCSISelect utility program:

1. Turn on the server.
2. When the <<< Press <CTRL><A> for SCSISelect Utility! >>> prompt appears, press Ctrl+A.

**Note:** If an administrator password has been set, a prompt appears asking you to enter the password to start the SCSISelect Utility program.

3. When prompted, select either channel A (internal) or channel B (external).
4. Use the arrow keys to select a choice from the menu.
  - Press Esc to return to the previous menu.
  - Press the F5 key to switch between color and monochrome modes (if the monitor permits).

5. Follow the instructions on the screen to change the settings of the selected items; then, press Enter.

## Choices available from the SCSISelect menu

The following choices appear on the SCSISelect Utility menu:

- **Configure/View Host Adapter Settings**

Select this choice to view or change the SCSI controller settings. To reset the SCSI controller to its default values, press F6; then, follow the instructions that appear on the screen.

You can view or change the following controller settings:

- **Host Adapter SCSI ID**

Select this choice to view the SCSI controller ID, normally 7.

- **SCSI Parity Checking**

Select this choice to view the assigned value of *Enabled*.

- **Host Adapter SCSI Termination**

Select this choice to view the assigned value of *Enabled*.

- **Boot Device Options**

Select this choice to configure startable device parameters. Before you can make updates, you must know the ID of the device whose parameters you want to configure.

- **SCSI Device Configuration**

Select this choice to configure SCSI device parameters. Before you can make updates, you must know the ID of the device whose parameters you want to configure.

**Note:** The Maximum Sync Transfer Rate represents the transfer rate for Ultra SCSI devices.

- The transfer rate for Ultra3 SCSI LVD devices is 160.0
- The transfer rate for Ultra2 SCSI LVD devices is 80.0
- The transfer rate for Fast SCSI devices is 20.0

- **Advanced Configuration Options**

Select this choice to view or change the settings for advanced configuration options.

- **SCSI Disk Utilities**

Select this choice to view the SCSI IDs that are assigned to each device or to format a SCSI device.

To use the utility program, select a drive from the list. Read the screens carefully before making a selection.

**Note:** If you press Ctrl+A before the selected drives are ready, an Unexpected SCSI Command Failure screen might appear. Restart the server and watch the SCSISelect messages as each drive spins up. After the drive that you want to view or format spins up, press Ctrl+A.

# Installing options

This chapter provides instructions to help you add options to the server.

## Expanded view of the xSeries 350

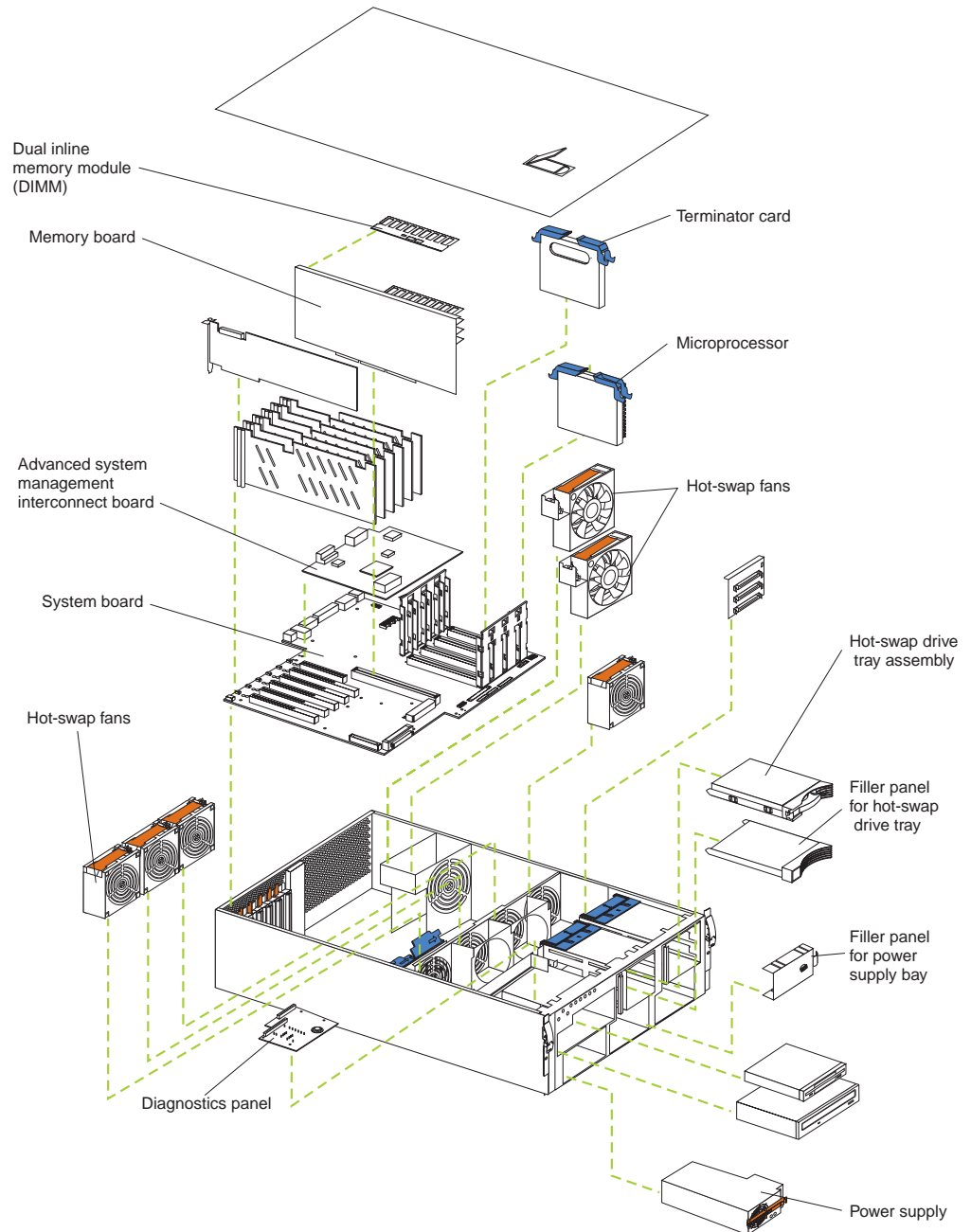

## Component locations

This section provides illustrations of the system board, Diagnostic LED panel, memory board, and Advanced System Management Interconnect board component locations.

### System board component locations

The following illustrations detail certain locations on the system board.

**Note:** The illustrations in this document might differ slightly from your hardware.

**System board connectors:** The following illustration shows the location of connectors on the system board.

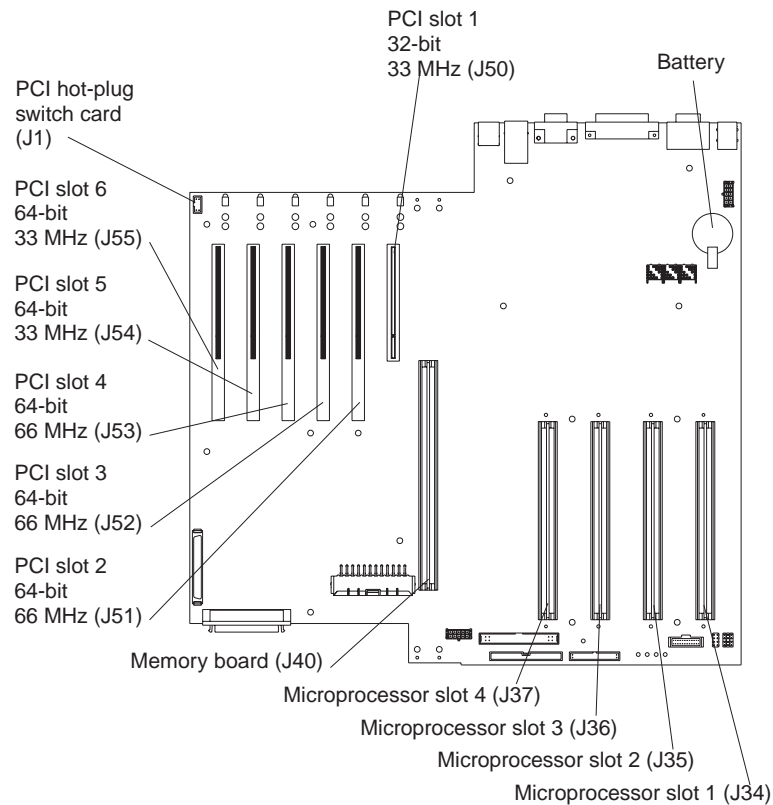

**System board cable connectors:** The following illustration shows the location of the cable connectors on the system board.

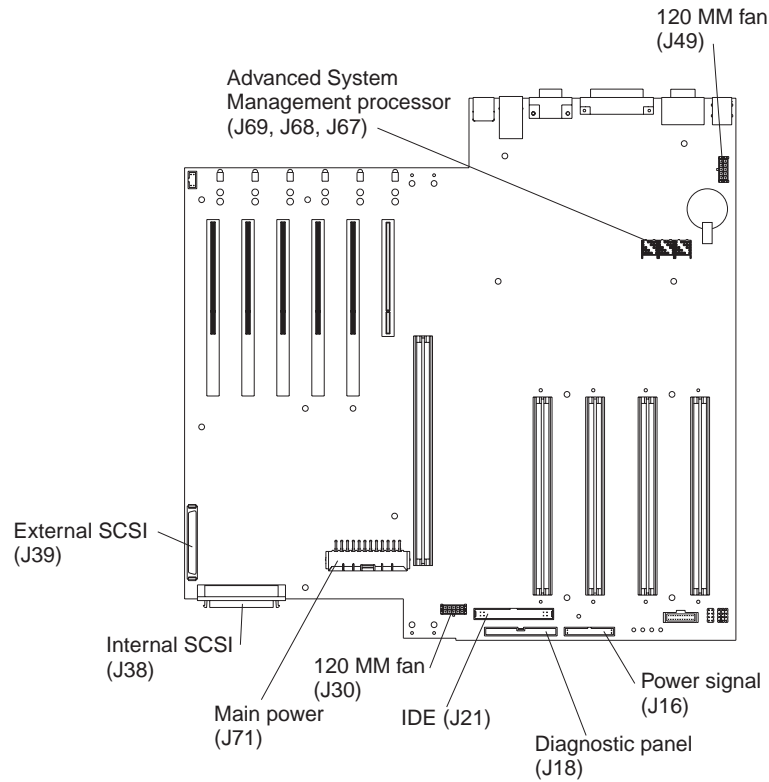

**I/O external port connectors:** The following illustration shows the location of the input/output external port connectors on the system board.

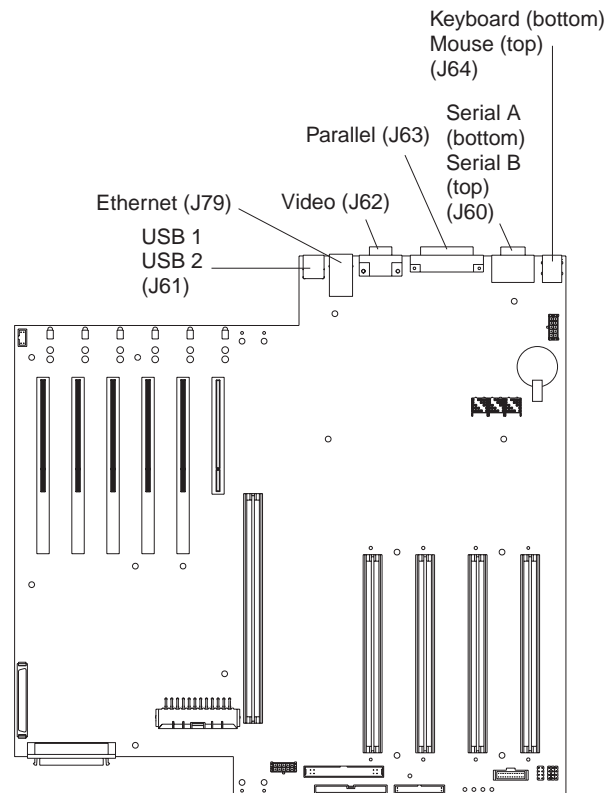

**System board jumpers:** The following illustration shows the location of the flash ROM page swap jumper (J14) and power-on password override jumper (J15) on the system board. Jumper J14 is located at the top of the jumper block, and jumper J15 is located immediately below jumper J14.

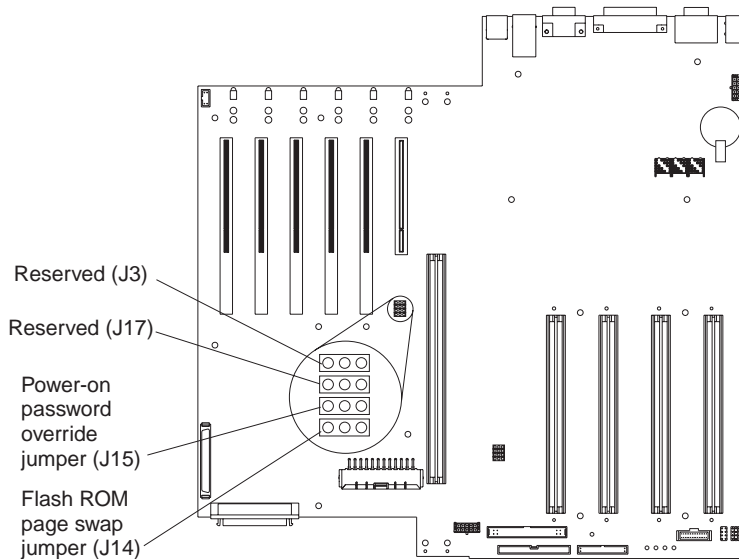

**Notes:**

1. Turn off the server; then, disconnect all power cords and external cables. before moving any jumpers.
2. Jumpers J19 and J3 are located on the same jumper block as jumpers J14 and J15 on the system board. These jumpers are set to **Disabled**. Do not change the settings on these jumpers.  
**Attention:** If you change the settings on these jumpers, the server will fail.
3. See “Changing jumper positions” on page 69 for additional information on setting jumpers.

Table 9. Jumpers J14 and J15 on the system board

Jumper name	Description
J14 Flash ROM page swap	The default position is a jumper installed on pins 2 and 3. See “Recovering BIOS” on page 20 for additional information.
J15 Power-on password override	Changing the position of this jumper bypasses the power-on password check if the jumper has been moved since the server was last powered on. You do not need to move the jumper back to the default position after the password is overridden. The default position is a jumper on pins 2 and 3.  Changing the position of this jumper does not affect the administrator password check if an administrator password is set.  See “Power-on password” on page 38 for additional information on the power-on password.

Table 10. Jumper setback table

J13	J27	J28	J29	Bus Ratio	Core Frequency
H	L	L	H	7:1	700
H	L	H	L	8:1	800

The following illustration shows the location of the microprocessor speed (core-frequency-selection) jumper block on the system board. The jumpers on this block are in the following order, from top to bottom: J13, J27, J28, and J29. See "Installing a microprocessor kit" on page 66 for the jumper speed settings.

**Note:** Any system-board jumper blocks that are not shown in the illustrations in this book are reserved.

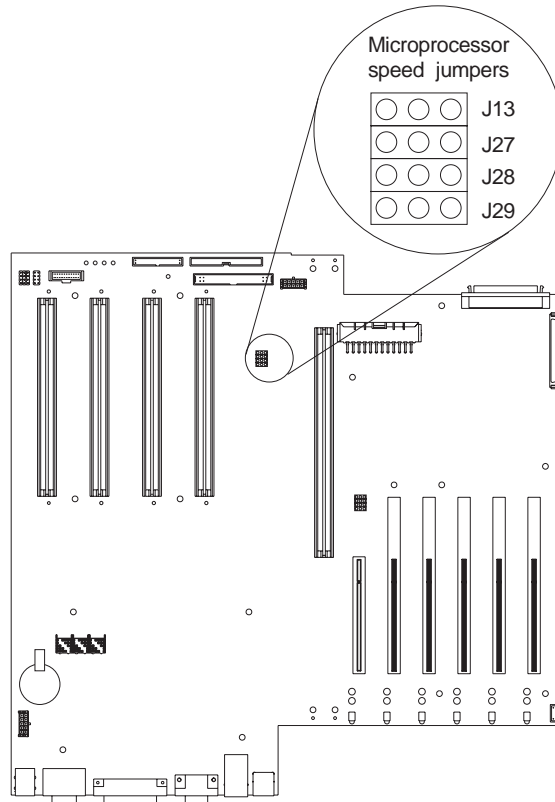

## System board LED locations

The following illustration shows the location of the lights on the system board.

**Note:** The illustrations in this document might differ slightly from your hardware.

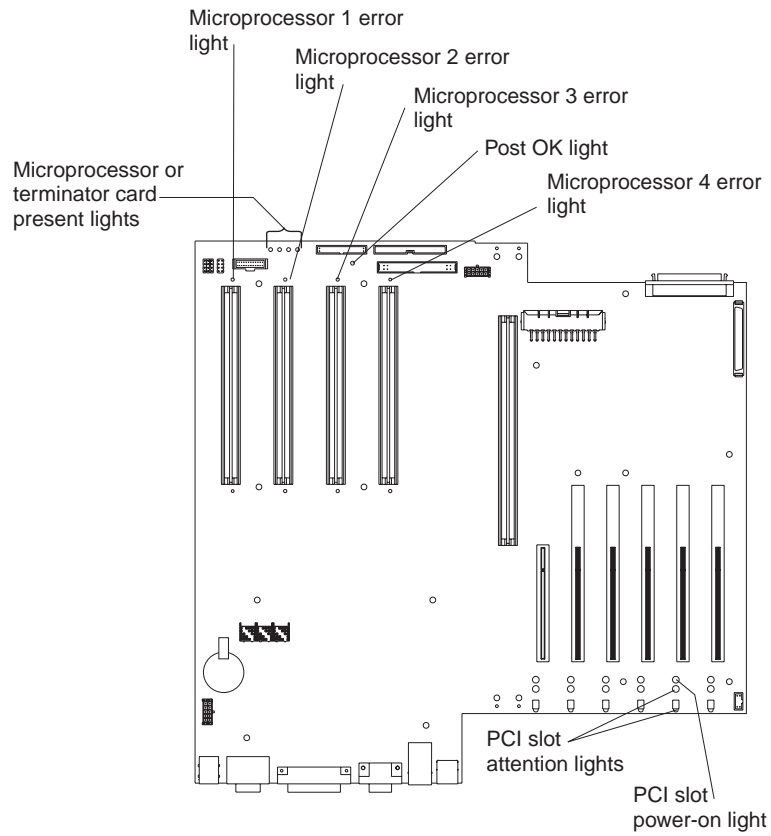



## Diagnostic panel LEDs

The following illustration shows the location of the LEDs on the diagnostic panel. The diagnostic panel LEDs are visible through a special cutout area located to the left of the cover-release latch on the top cover. However, to determine the exact location of the error condition in the server, you might need to remove the top cover to view the location of the error LED on the diagnostic panel.

**Note:** The diagnostic panel is also called the LED card.

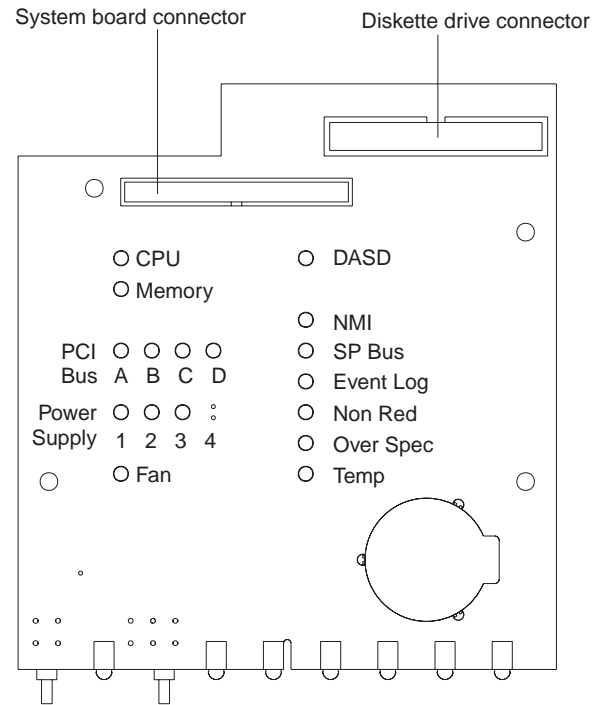

The meanings of these LEDs are as follows:

<b>CPU</b>	Microprocessor fault
<b>Memory</b>	Memory fault
<b>PCI Bus A (PCIA)</b>	PCI bus A fault
<b>PCI Bus B (PCIB)</b>	PCI bus B fault
<b>PCI Bus C (PCIC)</b>	PCI bus C fault
<b>PCI Bus D (PCID)</b>	Not implemented at this time.
<b>Power supply 1</b>	Power supply number 1 failure
<b>Power supply 2</b>	Power supply number 2 failure
<b>Power supply 3</b>	Power supply number 3 failure
<b>FAN</b>	Fan failure
<b>DASD</b>	Hard disk drive fault
<b>NMI</b>	Nonmaskable interrupt
<b>SP Bus</b>	Service processor failure
<b>Event Log</b>	Not implemented at this time.
<b>NON RED</b>	Nonredundant power mode
<b>OVER SPEC</b>	Over specification
<b>TEMP</b>	System temperature failure

### Notes:

1. The server does not support replaceable voltage regulator modules (VRMs).
2. The server supports a maximum of three PCI buses.
3. The server supports a maximum of three power supplies.
4. See "Light Path Diagnostics" on page 19 for a detailed description of these LEDs.

## Memory board component locations

The following illustration shows the location of the dual inline memory module (DIMM) connectors and error LEDs on the memory board.

### Notes:

1. The illustrations in this document might differ slightly from your hardware.
2. Some of the DIMM error LEDs are not visible in this illustration. The memory board contains 16 error LEDs; that is, one error LED for each DIMM connector.

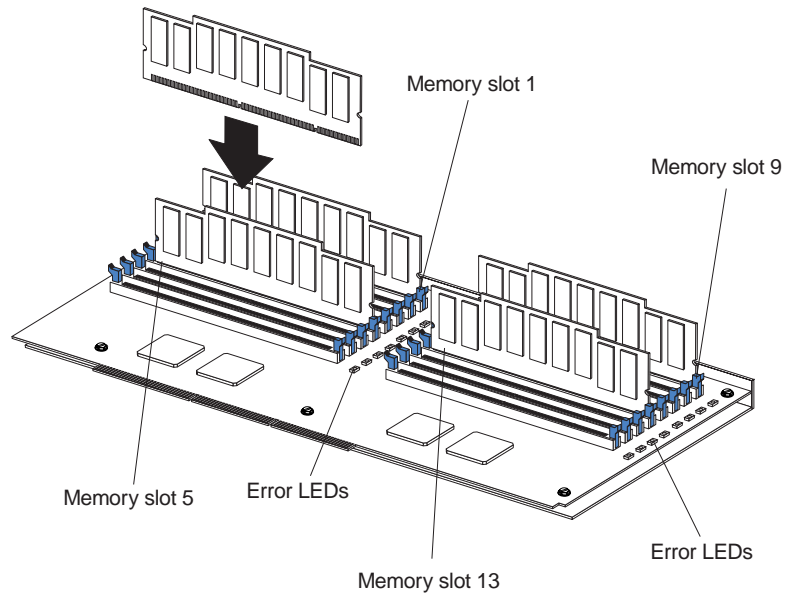

## Advanced System Management Interconnect board component locations

The following illustration shows the connectors and lights for the Advanced System Management Interconnect board.

### Notes:

1. The illustrations in this document might differ slightly from your hardware.
2. The Advanced System Management Interconnect board is also called the service processor card.

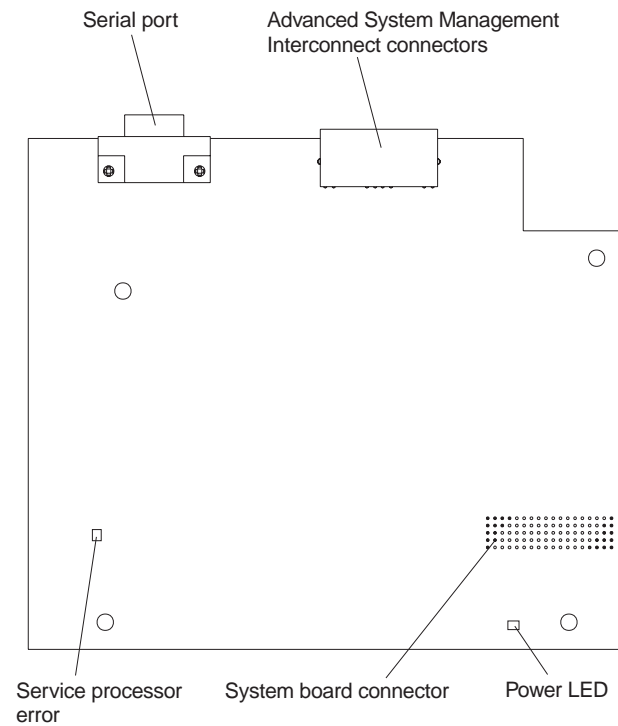

---

## Before you begin

Before you begin to install options in the server, read the following information:

- Become familiar with the safety and handling guidelines provided in “Safety information” on page 127 and “Handling electrostatic discharge-sensitive devices” on page 130. These guidelines will help you work safely while working with the server or options.
- You do not need to turn off the server to install or replace hot-swap power supplies, hot-swap drives, hot-swap fans, Active PCI (hot-plug) adapters, or hot-plug USB devices.
- The orange color on components and labels in the server identifies hot-swap or hot-plug components. This means that you can install or remove the component while the system is running, provided that the system is configured to support this function.
- The blue color on components and labels identifies touch points where you can grip a component, move a latch, and so on.
- Make sure that you have an adequate number of properly grounded electrical outlets for the server, monitor, and any other options that you intend to install.
- Back up all important data before you make changes to disk drives.
- For a list of supported options for the eServer xSeries 350, refer to <http://www.ibm.com/pc/us/compat> on the World Wide Web.

## System reliability considerations

To help ensure proper cooling and system reliability, make sure that:

- Each of the drive bays has either a drive or a filler panel installed.
- Each of the power supply bays has either a power supply or a filler panel installed.
- There is at least 50 mm (2 inches) of ventilated space at the sides of the server and 100 mm (4 inches) at the rear of the server.
- The top cover is in place during normal operation.
- The top cover is removed for no longer than 30 minutes while the server is operating.
- The processor housing cover over the processor and memory area is removed for no longer than 10 minutes while the server is operating.
- A removed hot-swap drive is replaced within 10 minutes of removal.
- Cables for optional adapters are routed according to the instructions provided with the adapters.
- A failed fan is replaced within 48 hours.

## Working inside the server with the power on

The server supports hot-add, hot-plug and hot-swap devices and is designed to operate safely while turned on with the cover removed. Follow these guidelines when you work inside a server that is turned on:

- Avoid loose-fitting clothing on your forearms. Button long-sleeved shirts before working inside the server; do not wear cuff links while you are working inside the server.
- Do not allow your necktie to hang inside the server.
- Remove jewelry, such as bracelets, necklaces, rings, and loose-fitting wrist watches.

- Remove items from your shirt pocket (such as pens or pencils) that could fall into the server as you lean over it.
- Avoid dropping any metallic objects, such as paper clips, hair pins, or screws, into the server.

## Handling static-sensitive devices

Static electricity, though harmless to you, can seriously damage server components or options.

**Note:** When you are adding an internal option, do not open the static-protective package containing the option until you are instructed to do so.

When you handle options and other server components, take these precautions to avoid damage from static electricity:

- Limit your movement. Movement can cause static electricity to build up around you.
- Always handle components carefully. Handle adapters, the memory board, and memory modules (DIMMs) by the edges. Never touch any exposed circuitry.
- Prevent others from touching components.
- When you are installing a new option, touch the static-protective package containing the option to a metal expansion-slot screw or other unpainted metal surface on the server for at least two seconds. (This reduces static electricity from the package and from your body.)
- When possible, remove the option and install it directly into the server without setting the option down. When this is not possible, place the static-protective package that the option comes in on a smooth, level surface and place the option on it.
- Do not place the option on the server's covers or any metal surface.

### Statement 1



### DANGER

Electrical current from power, telephone and communication cables is hazardous.

#### To avoid a shock hazard:

- **Do not connect or disconnect any cables or perform installation, maintenance, or reconfiguration of this product during an electrical storm.**
- **Connect all power cords to a properly wired and grounded electrical outlet.**
- **Connect to properly wired outlets any equipment that will be attached to this product.**
- **When possible, use one hand only to connect or disconnect signal cables.**
- **Never turn on any equipment when there is evidence of fire, water, or structural damage.**
- **Disconnect the attached power cords, telecommunications systems, networks, and modems before you open the device covers, unless instructed otherwise in the installation and configuration procedures.**
- **Connect and disconnect cables as described in the following table when installing, moving, or opening covers on this product or attached devices.**

To Connect	To Disconnect
<ol style="list-style-type: none"> <li>1. Turn everything OFF.</li> <li>2. First, attach all cables to devices.</li> <li>3. Attach signal cables to connectors.</li> <li>4. Attach power cords to outlet.</li> <li>5. Turn device ON.</li> </ol>	<ol style="list-style-type: none"> <li>1. Turn everything OFF.</li> <li>2. First, remove power cords from outlet.</li> <li>3. Remove signal cables from connectors.</li> <li>4. Remove all cables from devices.</li> </ol>

**Statement 4**

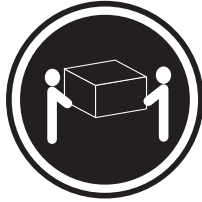

≥18 kg (39.7 lb)



≥32 kg (70.5 lb)



≥55 kg (121.2 lb)

**CAUTION:**  
Use safe practices when lifting.

**Statement 5**



**CAUTION:**  
The power control button on the device and the power switch on the power supply do not turn off the electrical current supplied to the device. The device also might have more than one power cord. To remove all electrical current from the device, ensure that all power cords are disconnected from the power source.

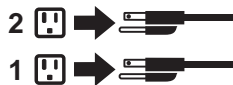

---

## Removing the server top cover and bezel

Review the information in “Before you begin” on page 50

The following illustration shows how to remove the top cover and bezel from the server.

**Note:** The illustrations in this document might differ slightly from your hardware.

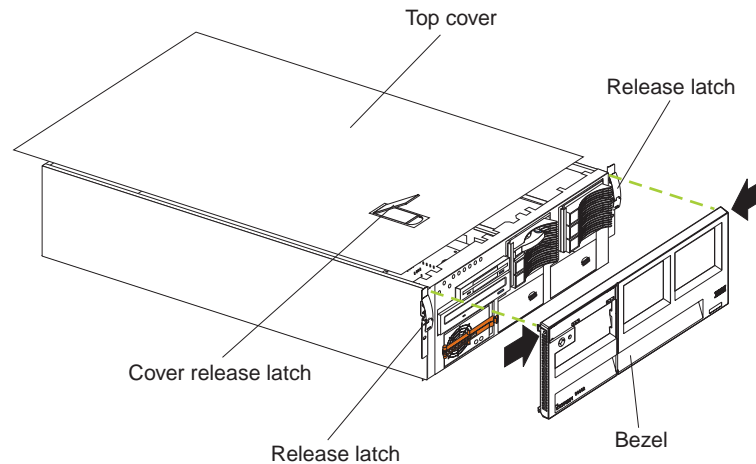

To remove the server top cover:

1. Lift the plastic cover-release latch near the edge of the top cover.
2. Slide the top cover slightly toward the rear of the server; the cover will stop after about 25 mm (1 inch). Lift the cover off the server and set the cover aside.

**Attention:** For proper cooling and airflow, replace the top cover before turning on the server. Operating the server for extended periods of time (over 30 minutes) with the top cover removed might damage server components.

To remove the bezel:

1. Release the two tabs at the top edge of the bezel and pull the top of the bezel slightly away from the server.
2. Pull the bezel up to release the two tabs at the bottom edge of the bezel. Store the bezel in a safe place.

## Working with adapters

The following illustration shows the location of the Active™ PCI adapter expansion slots on the system board.

### Notes:

1. The illustrations in this document might differ slightly from your hardware.
2. Active PCI slots are also called hot-plug PCI slots.

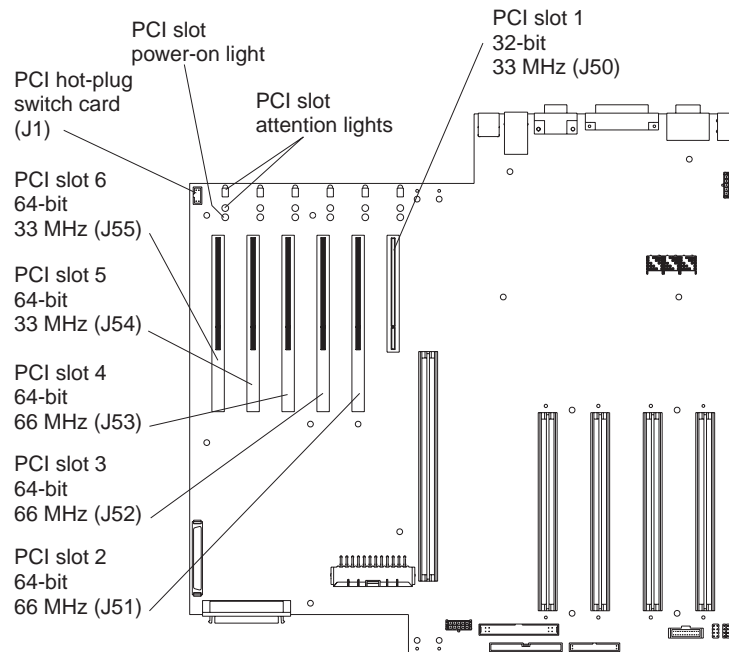

### PCI bus configuration

- Hot-plug, 32-bit PCI slot 1 (on PCI bus A, 5V, 33 MHz)
- Hot-plug, 64-bit PCI slots 2 through 4 (on PCI bus B, 3.3V, 66 MHz)
- Hot-plug, 64-bit PCI slots 5 through 6 (on PCI bus C, 5V, 33 MHz)
- Power-on lights for Active PCI slots
- Internal Attention lights for Active PCI slots
- External Attention lights for Active PCI slots

This section gives the procedure for installing a hot-plug PCI adapter. If your operating system supports hot-plug PCI adapters, you can replace a failing hot-plug PCI adapter with a new adapter of the same type without turning off power to the server. If your operating system and adapter also support the hot-add feature, you can install a new adapter without turning off the power to the server.

### Before you begin:

- Review the information in “Before you begin” on page 50 and “Working inside the server with the power on” on page 50
- Read the documentation that comes with your adapter for any special requirements or restrictions.
- Read the documentation that comes with your operating system.



**Attention:** Do not remove a hot-plug PCI adapter before performing the operating-system-defined procedure for disabling the Active PCI (hot-plug) slot that contains the adapter. Failure to do so might cause your system to lock up. Refer to your operating-system documentation.

## Installing a hot-plug adapter

The following illustration shows how to install a hot-plug PCI adapter.

**Note:** The illustrations in this document might differ slightly from your hardware.

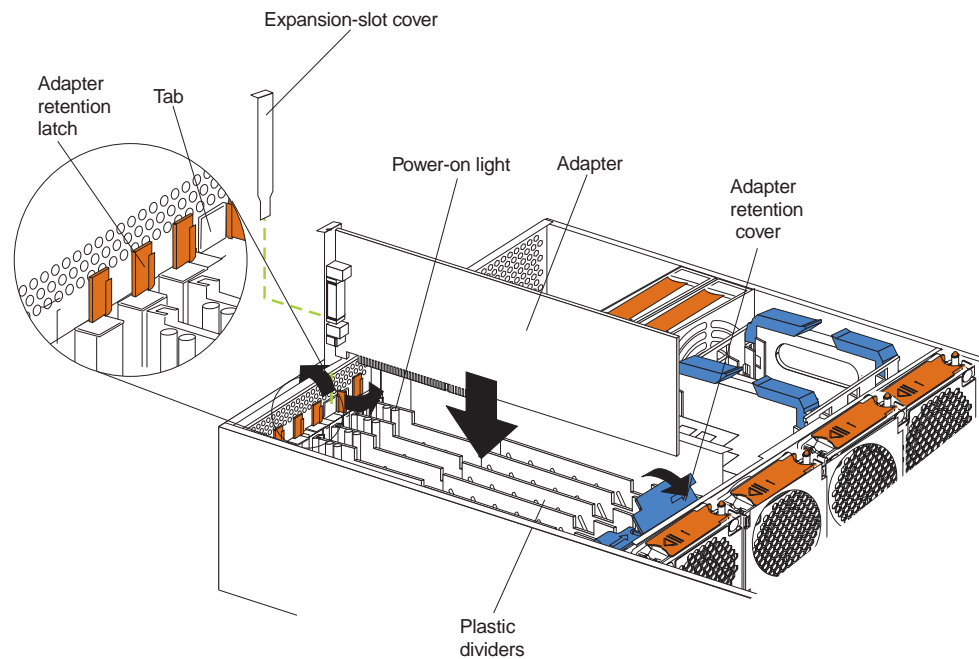

To install a hot-plug PCI adapter:

**Attention:** When you handle Electrostatic Discharge-Sensitive devices (ESD), take precautions to avoid damage from static electricity. For details on handling these devices, refer to the following Web site and search for ESD:  
<http://www.ibm.com>

1. Remove the top cover (see “Removing the server top cover and bezel” on page 53).
2. Determine which expansion slot you will use for the adapter.

**Note:** All six PCI slots support hot-plug PCI adapters.

3. Disable the selected PCI slot from your operating system. (Refer to the documentation that comes with your operating system for information about disabling a hot-plug PCI slot.) Disabling the PCI slot turns off the power-on light for that PCI slot.

**Attention:** Make sure that the power-on light for the hot-plug PCI slot is off before you continue with the next step.

4. Remove the expansion-slot cover:
  - a. Rotate the adapter retention latch counterclockwise.
  - b. Lift the tab on the top of the expansion-slot cover; then, remove the expansion-slot cover from the server. Store it in a safe place for future use.

- c. Press on the rear of the adapter retention assembly and lift the adapter retention cover.  
**Attention:** Expansion-slot covers must be installed on all empty slots. This maintains the electromagnetic emissions characteristics of the system and ensures proper cooling of system components.
5. Refer to the documentation that comes with your adapter for any cabling instructions. It might be easier for you to route any cables before you install the adapter.
6. Remove the adapter from the static-protective package.  
**Attention:** Avoid touching the components and gold-edge connectors on the adapter.
7. Place the adapter, component-side up, on a flat, static-protective surface.
8. Install the adapter:
  - a. Carefully grasp the adapter by its top edge or upper corners, and align it with the expansion slot on the system board.
  - b. Press the adapter *firmly* into the expansion slot.  
**Attention:** When you install an adapter in the server, be sure that it is completely and correctly seated in the system-board connector. Incomplete insertion might cause damage to the system board or the adapter.
  - c. Lower the tab over the top corner of the adapter. Rotate the adapter retention latch clockwise until it snaps into place.
9. Connect any needed cables to the adapter.
10. Enable the PCI slot from your operating system. (Refer to the documentation that comes with your operating system for information about enabling a hot-plug PCI slot.) Make sure that the power-on light for the hot-plug PCI slot comes on.
11. If you have other options to install or remove, do so now; otherwise, go to “Installing the server top cover and bezel” on page 74

## Cabling example for the ServeRAID adapter

You can install an optional IBM ServeRAID<sup>®</sup> adapter in the server to control the internal hot-swap hard-disk drives; that is, to enable you to configure the internal hot-swap hard disk drives into disk arrays. To do this, you must turn off the server, disconnect the internal SCSI cable from the integrated SCSI controller on the system board, and connect the cable to a ServeRAID adapter. Refer to the ServeRAID adapter option documentation for complete instructions on installing a ServeRAID adapter in the server. Refer to the *Using IBM ServeRAID* book on the Documentation CD for information on ServeRAID adapters and controllers.

The following procedure describes the cable routing that is necessary when you install a ServeRAID adapter. The following illustrations show the cabling for internal hot-swap hard disk drives. You can also cable a ServeRAID adapter to external hard disk drives.

### Notes:

1. The illustrations in this document might differ slightly from your hardware.
2. Refer to the documentation that comes with your adapter for any cabling instructions.
3. Cable identifiers are printed on the cables that come with the server and options. Use these identifiers to connect the cables to the correct connectors. For example, the hard disk drive cables are labeled HDD.

To cable the ServeRAID adapter:

1. Turn off the server.
2. Remove all adapters from the Active PCI adapter slots.
3. Remove the plastic dividers between the PCI adapter slots.
4. Press the fan assembly release latches on both sides of the fan assembly; then, remove the fan assembly from the server.

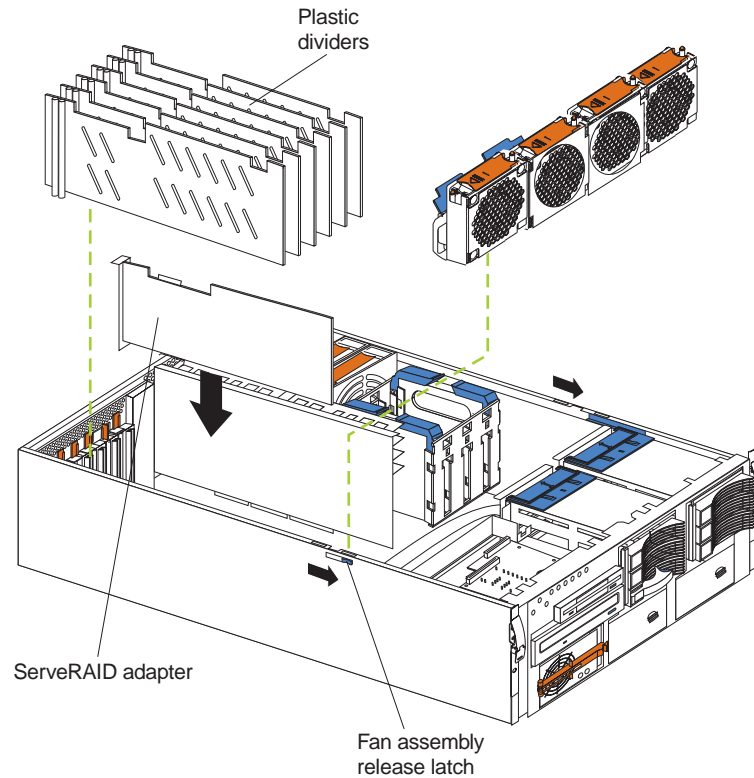

5. Disconnect the internal SCSI cable from the SCSI connector (J38) on the system board. (See "System board cable connectors" on page 43).
6. Carefully thread the disconnected end of the internal SCSI cable out of the chassis, pulling the cable out of the opening in the chassis.
7. Reinstall the fan assembly in the server.
8. Replace the plastic dividers between the PCI adapter slots.
9. Reinstall the adapters in the PCI adapter slots.
10. The following illustration shows how to route the SCSI cable to the ServeRAID adapter.

**Attention:** When you route the SCSI cable, observe the following:

- Do not block the ventilated space in front of the fan assembly.
- Do not place the SCSI cable fold on top of the fan assembly.
- Do not route the SCSI cable over the memory board assembly.

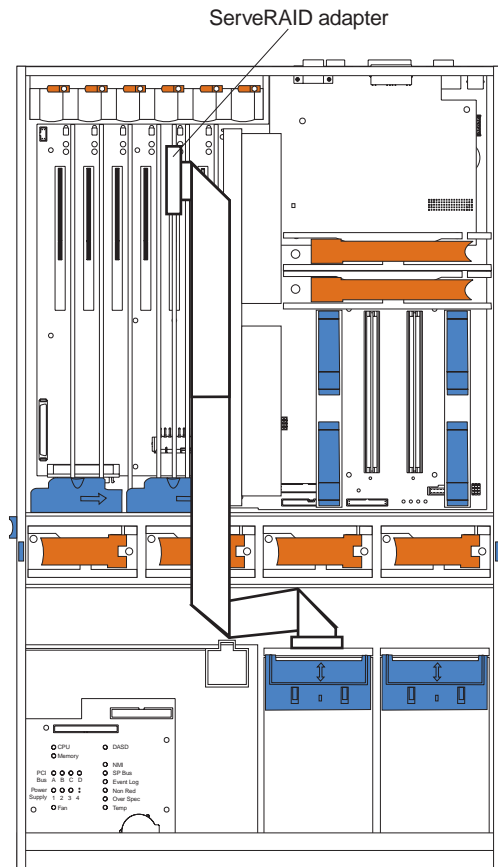

11. Install the ServeRAID adapter in the desired PCI slot. See “Installing a hot-plug adapter” on page 55 for adapter installation instructions. Refer to the ServeRAID adapter option documentation for additional information on installing a ServeRAID adapter in the server and connecting the SCSI cable to a ServeRAID adapter.
12. Connect the SCSI cable to an internal channel connector on the ServeRAID adapter.

**Note:** Refer to the *Using IBM ServeRAID* book on the Documentation CD for information on ServeRAID adapters and controllers.

## Installing internal drives

If you add different types of drives, the system can read multiple types of media and store more data. Several types of drives are available, such as:

- Diskette
- Hard disk
- CD-ROM
- DVD-ROM
- Tape

**Note:** The server supports external tape drives; however, the server does not support internal tape drives.

The server contains hardware that enables you to replace a failed hard disk drive without turning off the server. Therefore, you have the advantage of continuing to operate the system while a hard disk drive is removed or installed. These drives are known as *hot-swap* drives.

Each hot-swap drive bay has two indicator lights on the front of the server (see "Start the server" on page 8). If the amber hard-disk status light for a drive is lit continuously, that individual drive is faulty and requires replacement. When the hard-disk status light indicates a drive fault, you can replace a hot-swap drive without turning off the server.

Each hot-swap drive that you plan to install must be mounted in a hot-swap-drive tray. The drive must have a single connector attachment (SCA) connector. Hot-swap-drive trays come with hot-swap drives.

## Internal drive bays

Internal drives are installed in *bays*. The server supports up to a maximum of six 1-inch (26 mm) slim high, 3.5 inch, hot-swap hard disk drives when the media bay option is installed.

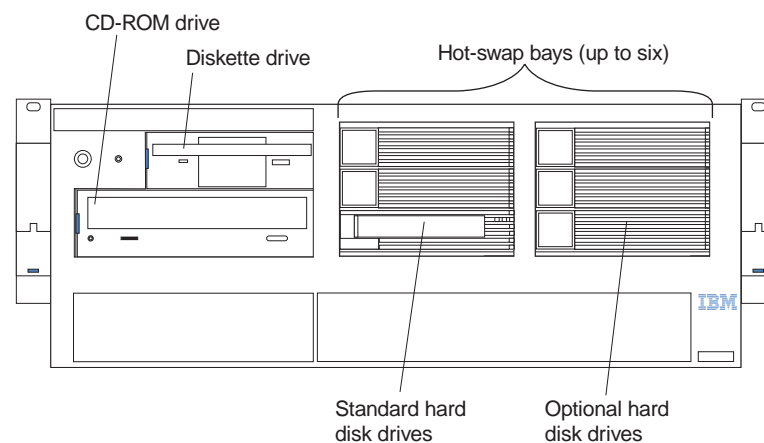

3.5-inch diskette drive  
CD-ROM drive  
3 hot-swap hard disk drives

- The server comes with one integrated drive electronics (IDE) CD-ROM drive and one 3.5-inch, 1.44 MB diskette drive.
- The CD-ROM drive bay (bottom left front) supports 5.25-inch, half-high, removable-media drives. However, you cannot install additional removable-media drives in the server.

- The server supports three standard and three optional 1-inch (26 mm) slim-high, 3.5-inch, hot-swap hard disk drives in the hot-swap bays. The standard hot-swap bays are bays 1 through 3 (from bottom to top). The optional hot-swap bays are bays 4 through 6 (from bottom to top). Bays 1 through 3 are located in the standard hard disk drive cage, to the left of bays 4 through 6 in the optional hard disk drive cage.

**Note:** The server does not support half-high hot-swap drives or internal tape drives.

- The hot-swap bays connect to a hot-swap drive *backplane*. The backplane is a printed circuit board behind the bays.

### Hard disk drive component locations

The following illustration shows the hot-swap-drive backplane component locations, as viewed from the front of the server.

**Note:** The illustrations in this document might differ slightly from your hardware.

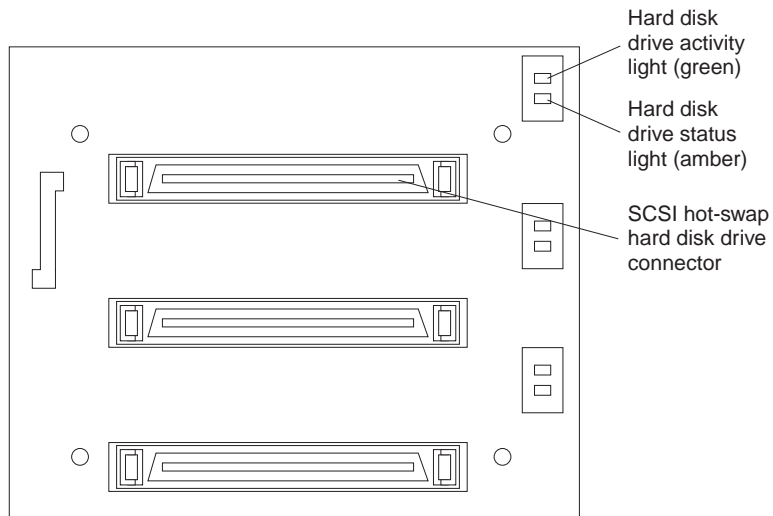

**Note:** The hard-disk drive activity light and hard-disk drive status light on the backplane match the hard-disk drive activity light and hard-disk drive status light on the front of the server (see “Start the server” on page 8).

The following illustration shows the rear connectors on the hot-swap-drive backplane before the repeater card is installed, as viewed from the rear of the server.

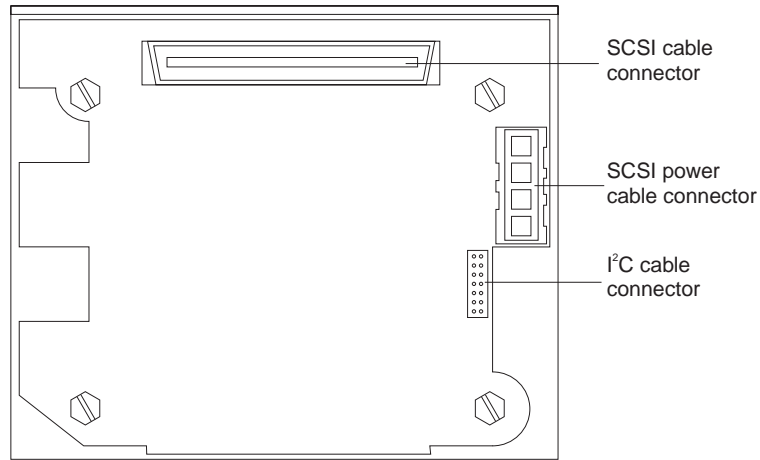

**Note:** To install an additional hot-swap drive backplane on the back of the server, see “Installing a 3-Pack Ultra160 Hot-Swap Expansion Kit” on page 71

## Installing a hot-swap hard disk drive

The following illustration shows how to install a hot-swap hard disk drive.

**Note:** You do not have to turn off the server to install hot-swap drives in these bays.

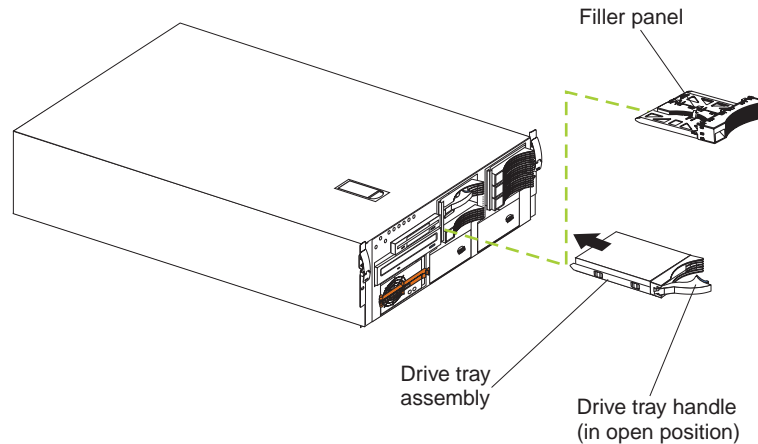

To install a drive in a hot-swap bay:

1. Review “Before you begin” on page 50
2. Unlock and open the server front door.

**Attention:** To maintain proper system cooling, do not operate the server for more than 10 minutes without either a drive or a filler panel installed for each bay.

3. Remove the filler panel from one of the empty hot-swap bays by inserting your finger into the depression at the left side of the filler panel and pulling it away from the server.
4. Install the hard disk drive in the hot-swap bay:
  - a. Ensure that the tray handle is open (that is, perpendicular to the drive).
  - b. Align the drive assembly so that it engages the guide rails in the bay.
  - c. Gently push the drive assembly into the bay until the drive stops.
  - d. Push the tray handle to the closed (locked) position.
  - e. Check the hard disk drive status indicator to verify that the hard disk drive is operating properly.

If the amber hard-disk status light for a drive is lit continuously, that individual drive is faulty and needs to be replaced. If the green hard-disk activity light is flashing, the drive is being accessed.

**Note:** If the server has a ServeRAID controller or adapter installed, you might need to reconfigure the disk arrays after installing hard disk drives. Refer to *Using IBM ServeRAID* on the Documentation CD or the Hardware Maintenance Manual pertaining to the specific RAID adapter for information.



## Installing memory-module kits

The illustrations in this document might differ slightly from your hardware.

Adding memory to the server is an easy way to make programs run faster. You can increase the amount of memory in the server by installing memory-module options. You must install a bank of four matched dual-inline memory modules (DIMMs).

### Notes:

1. The DIMM options available for the server are 128 MB, 256 MB, 512 MB, and 1 GB. The server supports a minimum of 512 MB (4 x 128MB) and a maximum of 16 GB (16 x 1GB) of system memory.
2. When 4 GB of memory is installed in the server, the amount of usable memory will be reduced depending on the system configuration. A certain amount of memory must be reserved below 4 GB for system resources. A second reduction in the usable memory is made when 16 GB of memory is installed.
3. The server comes with a minimum of 512 MB (4x128) memory installed in bank 1. When you install additional DIMMs, be sure to follow the DIMM population sequence in Table 11..
4. All the DIMMs installed in a bank must be the same size, speed, type, and technology. You can mix compatible DIMMs from various manufacturers.
5. All the banks do not have to contain DIMMs of the same size, speed, type, and technology. You can mix compatible DIMMs from various manufacturers.
6. The memory board contains 16 DIMM connectors and utilizes 4-way memory interleaving. See Table 11  
The 4-way memory interleave technology in the server requires that you install DIMMs in all four connectors in each populated bank.
7. Install only 3.3 V, 168-pin, 8-byte, 100 MHz, PCI, PC100-322-622R, registered synchronous dynamic random-access memory (SDRAM) with error correcting code (ECC), DIMMs. Only 100 MHz, 72-bit, registered, synchronous, x4 SDRAM configuration DIMM memory is supported for the 128 MB, 256 MB, 512 MB, and 1 GB DIMMs.
8. Installing or removing DIMMs changes the configuration information in the server. Therefore, after installing or removing a bank of DIMMs, you must save the new configuration information using the Configuration/Setup Utility program. When you restart the server, the system displays a message indicating that the memory configuration has changed. Start the Configuration/Setup Utility program and select **Save Settings**. See "Configuring the server" on page 33 for more information.

Install the DIMMs in the order provided in Table 11

Table 11. DIMM installation order

Bank of 4 DIMMs	Install DIMMs in these connectors:
Bank 1 (shipped as standard)	J1, J5, J9, J13
Bank 2	J2, J6, J10, J14
Bank 3	J3, J7, J11, J15
Bank 4	J4, J8, J12, J16

The following illustration shows how to install memory on the memory board.

**Note:** The illustrations in this document might differ slightly from your hardware.

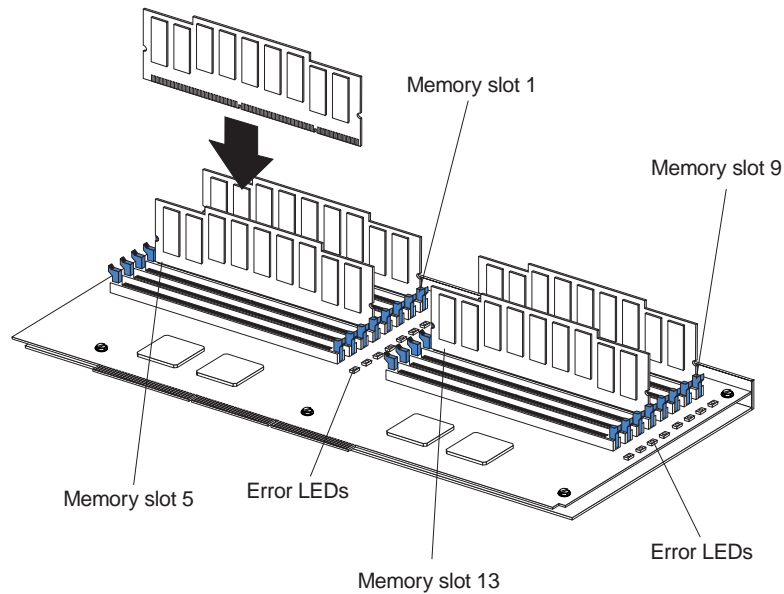

Before you begin:

- Review “Before you begin” on page 50
- Read the documentation that comes with your option.

To install a DIMM:

**Attention:** When you handle Electrostatic Discharge-Sensitive devices (ESD), take precautions to avoid damage from static electricity. For details on handling these devices, refer to the following Web site and search for ESD:  
<http://www.ibm.com>

1. Turn off the server and disconnect all power cords and external cables; then, remove the top cover (see “Removing the server top cover and bezel” on page 53).
2. Remove the memory board assembly:
  - a. Lift up on the memory board assembly and remove it from the server.

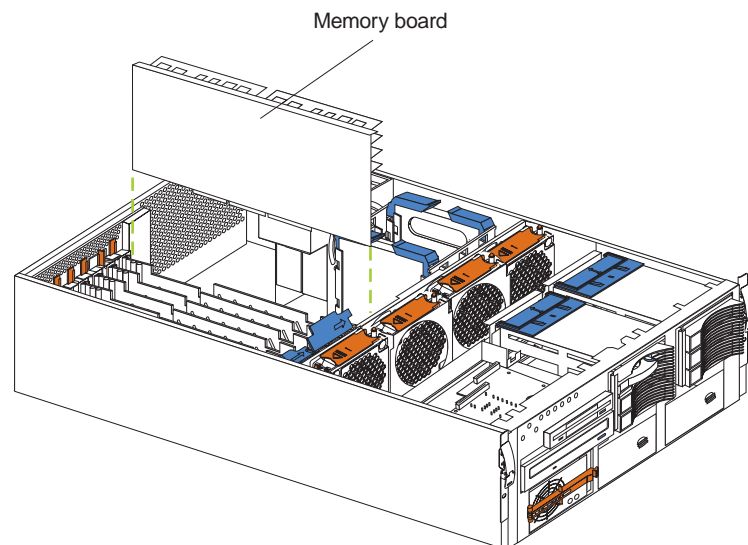

- b. Place the memory board assembly on a static-protective surface, such as the static-protective package in which an option comes.
3. Locate the DIMM connectors on the memory board. Determine the DIMM connectors into which you will install the DIMMs. (See the notes at the beginning of this procedure.)
4. Touch the static-protective package that contains the DIMM option to any unpainted metal surface on the server. Then, remove the DIMM from the package.

**Note:** To avoid breaking the retaining clips or damaging the DIMM connectors, handle the clips gently.

- a. Turn the DIMM so that the DIMM keys align correctly with the connector.
  - b. Insert the DIMM by pressing the DIMM straight into the connector. Be sure that the retaining clips snap into the closed positions.
  - c. Make sure that the retaining clips are in the closed position. If a gap exists between the DIMM and the retaining clips, the DIMM has not been properly installed. In this case, open the retaining clips and remove the DIMM; then, reinsert the DIMM.
6. Install the memory board assembly:
  - a. Hold the memory board assembly, and align it into the card guides and over the memory board connector.

**Attention:** When you insert the memory board assembly into the connector, press on the flat metal projection on the board.
  - b. Insert the memory board assembly into the connector.
7. If you have other options to install or remove, do so now; otherwise, go to “Installing the server top cover and bezel” on page 74

---

## Installing a microprocessor kit

The server comes with one microprocessor installed on the system board. The server supports up to four microprocessors. If you install at least one additional microprocessor, the server can operate as a symmetric multiprocessing (SMP) server. With SMP, certain operating systems and application programs can distribute the processing load among the microprocessors.

Before you begin:

- Review the information in “Before you begin” on page 50
- Thoroughly review the documentation that comes with the microprocessor, so that you can determine whether you need to update the server basic input/output system (BIOS). The latest level of BIOS for the server is available through the World Wide Web and the IBM Bulletin Board System (BBS). Go to <http://www.pc.ibm.com/support/>, select IBM Servers, and make the selections for the server.
- Obtain an SMP-capable operating system (optional). For a list of supported operating systems, see <http://www.ibm.com/pc/us/compat/> on the World Wide Web.

**Attention:** To avoid damage and ensure proper server operation when you install a new or an additional microprocessor, use microprocessors that have the same cache size and type, and the same clock speed. Microprocessor internal and external clock frequencies must be identical.

**Notes:**

1. To order additional microprocessor options, contact your IBM reseller or IBM marketing representative.
2. The server comes standard with one microprocessor installed in microprocessor connector J34 (slot 1) on the system board, and a terminator card in microprocessor slot 4. The microprocessor in slot 1 is the startup (boot) microprocessor. The microprocessor installed in microprocessor connector J35 is microprocessor 2 (slot 2); the microprocessor installed in microprocessor connector J36 is microprocessor 3 (slot 3); and the microprocessor installed in microprocessor connector J37 is microprocessor 4 (slot 4). If more than one microprocessor is installed, the highest numbered microprocessor is the microprocessor from which the server will start. The lower numbered microprocessors are used as application microprocessors.
3. If you replace the microprocessors in the server with microprocessors of a different speed, be sure to set the microprocessor-core-frequency-selection jumper block correctly, as described in this section. For a list of supported microprocessor speeds, see <http://www.ibm.com> on the World Wide Web.
4. The server does not support replaceable voltage regulator modules (VRMs).

If you need to install additional microprocessors, install them in the following order:

- Slot 1 (first slot, connector J34)
- Slot 2 (second slot, connector J35)
- Slot 3 (third slot, connector J36)
- Slot 4 (fourth slot, connector J37)

**Attention:** The server comes with a terminator card installed in microprocessor slot 4. To ensure proper server operation, the terminator card must remain installed in microprocessor slot 4 until you have installed microprocessors in slots 1 through 3.

The following illustration is a simplified layout of the microprocessor connector locations and other microprocessor-related components on the system board.

**Note:** The illustrations in this document might differ slightly from your hardware.

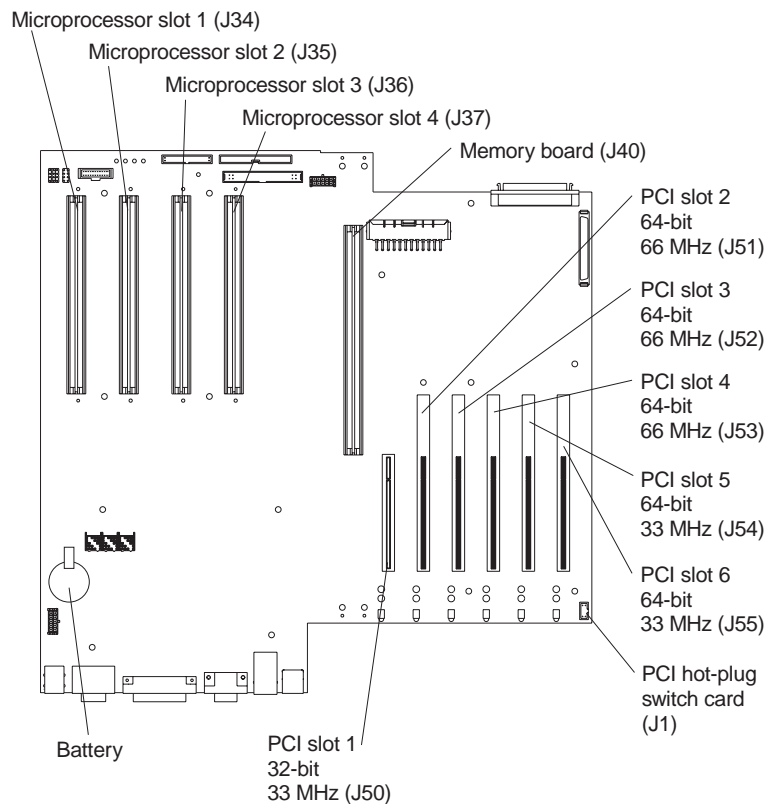

**Note:** For additional illustrations of the system-board components, see “System board component locations” on page 42

The following illustration shows how to install a microprocessor on the system board.

**Note:** The illustrations in this document might differ slightly from your hardware.

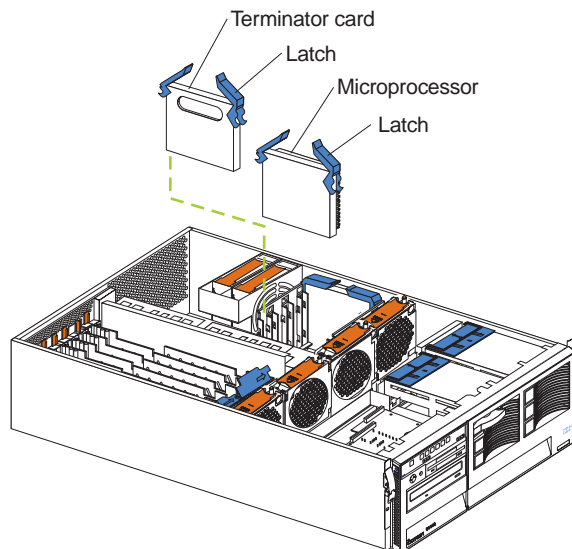

To install an additional microprocessor:

**Attention:** When you handle Electrostatic Discharge-Sensitive devices (ESD), take precautions to avoid damage from static electricity. For details on handling these devices, refer to the following Web site and search for ESD:  
<http://www.ibm.com>

**Note:** If you are replacing a failed microprocessor, verify that you have selected the correct microprocessor for replacement. To do this, check the Diagnostic panel that is located under the top cover to see which LED is on.

1. Turn off the server and disconnect all power cords and external cables; then, remove the top cover (see “Removing the server top cover and bezel” on page 53).
2. Determine the slot where the microprocessor is to be installed.
3. If you have installed microprocessors in slots 1 through 3 and you are now installing a microprocessor in slot 4, remove the terminator card from the microprocessor connector. Store the terminator card in a safe place in the static-protective package that your new microprocessor comes in; you will need to install it again if you ever remove the microprocessor.
4. Install the microprocessor:
  - a. Touch the static-protective package containing the new microprocessor to any *unpainted* metal surface on the server; then, remove the microprocessor from the package.
  - b. Hold the microprocessor by the open latches, and center the microprocessor over the microprocessor connector.

**Attention:** Make sure that the microprocessor is oriented and aligned correctly before you try to close the latches.
  - c. Carefully close the latches to seat the microprocessor in the connector.
5. If you replace the microprocessors in the server with microprocessors of a different speed, set the microprocessor-core-frequency-selection jumper block as described in Table 12 To ensure that the server maintains the correct microprocessor bus-to-core ratio, you must set the following microprocessor speed (core-frequency-selection) jumpers: J13, J27, J28, and J29. The jumpers on this block are in the following order, from top to bottom: J13, J27, J28, and J29. For locations of these jumpers, see “System board jumpers” on page 44

**Note:** See “Changing jumper positions” on page 69 for additional information on setting jumpers.

Table 12. Microprocessor-core-frequency-selection jumper block settings

J13	J27	J28	J29	Bus Ratio	Core Frequency (MHz)
H	L	L	H	7:1	700/100
H	L	H	L	8:1	800/100

6. If you have other options to install or remove, do so now; otherwise, go to “Installing the server top cover and bezel” on page 74

## Changing jumper positions

Jumpers located on the system board help you to customize the way the server operates.

The server system board contains two-pin and three-pin jumper blocks.

In some cases, groups of jumpers might combine to define a function.

### Three-pin jumper blocks

With the three-pin jumper blocks, each jumper covers two of the three pins on a pin block. You can position the jumper to fit over the center pin and either of the other two pins.

The following illustration identifies pins 1, 2, and 3 on a three-pin jumper block.

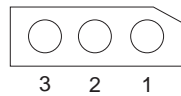

To change a jumper position for a three-pin jumper block:

1. Turn off the server; then, disconnect all power cords and external cables.
2. Remove the server cover (see “Removing the server top cover and bezel” on page 53).
3. Lift the jumper straight off the pin block.
4. Align the holes in the bottom of the jumper with the center pin and the pin that was not covered previously.

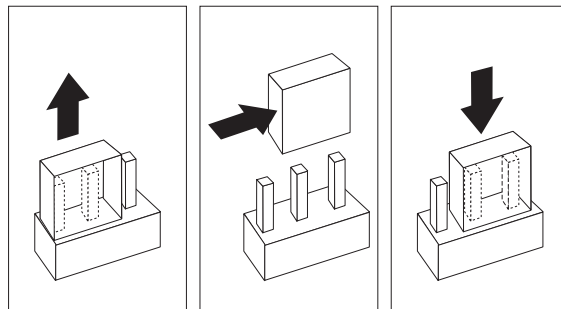

5. Slide the jumper fully onto these pins.
6. Reinstall the server cover and connect the cables (see “Installing the server top cover and bezel” on page 74).

## Installing a hot-swap power supply

The following illustration shows how to install a hot-swap power supply.

**Note:** The illustrations in this document might differ slightly from your hardware.

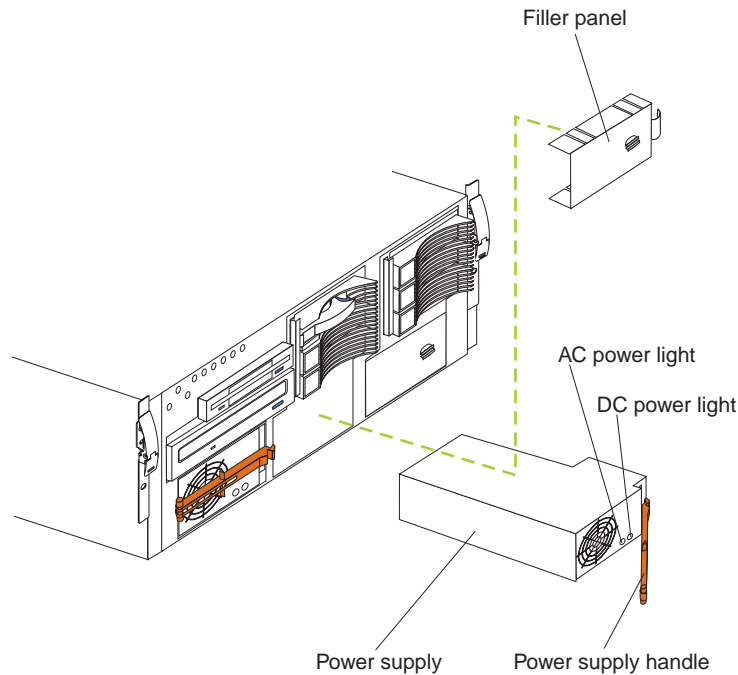

To install an additional power supply:

1. Remove the filler panel.
2. Place the handle on the power supply in the open position.
3. Slide the power supply into the chassis and close the handle.
4. Plug the power cord into the power supply; then, into a properly grounded electrical outlet.
5. Verify that the DC Power light and the AC Power light on the power supply are lit, indicating that the power supply is operating properly.

### Statement 8



### CAUTION:

Never remove the cover on a power supply or any part that has the following label attached.



Hazardous voltage, current, and energy levels are present inside any component that has this label attached. There are no serviceable parts inside these components. If you suspect a problem with one of these parts, contact a service technician.





**CAUTION:**

If you install a strain-relief bracket option over the end of the power cord that is connected to the device, you must connect the other end of the power cord to an easily accessible power source.

---

## Installing a 3-Pack Ultra160 Hot-Swap Expansion Kit

You can install an optional 3-Pack Ultra160 Hot-Swap Expansion Kit in the server to connect three additional hot-swap hard disk drives to the server. This kit contains a hot-swap hard disk drive backplane that you install adjacent to the standard hot-swap hard disk drive backplane. The server supports a maximum of two hot-swap drive backplanes.

**Notes:**

1. In addition to the optional hot-swap drive backplane, the 3-Pack Ultra160 Hot-Swap Expansion Kit comes with a hard disk drive cage. Do not install the hard disk drive cage on the server, as the hard disk drive cage is not compatible with the xSeries 350 server. The 3-Pack Ultra160 Hot-Swap Expansion Kit can be installed in various types of @servers; the hard disk drive cage is used with other types of servers.
2. Cable identifiers are printed on the cables that come with the server and options. Use these identifiers to connect the cables to the correct connectors. For example, the hard disk drive cables are labelled HDD.
3. For information on cabling options and using the 3-Pack Ultra160 Hot-Swap Expansion option, refer to the documentation that comes with the option kit.
4. For additional information on cabling, see “Cabling example for the ServeRAID adapter” on page 56 and “Cabling the server” on page 88
5. The hot-swap drive backplane components are shown at “Installing a hot-swap hard disk drive” on page 62

**Note:** The hard-disk drive activity light and hard-disk drive status light on the backplane match the hard-disk drive activity light and hard-disk drive status light on the front of the server (see “Start the server” on page 8).

The rear connectors on the hot-swap-drive backplane (before repeater card is installed) can be seen at “Installing a hot-swap hard disk drive” on page 62

The following illustration shows the rear connectors on the SCSI repeater card after the repeater card is installed, as viewed from the rear of the server.

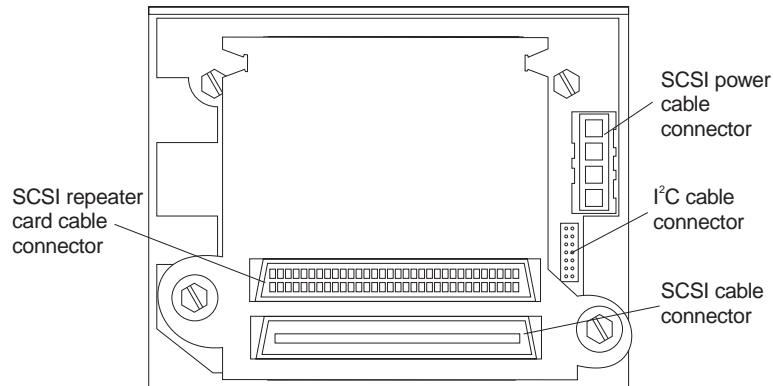

The following illustration shows how to install a 3-Pack Ultra160 Hot-Swap Expansion Kit.

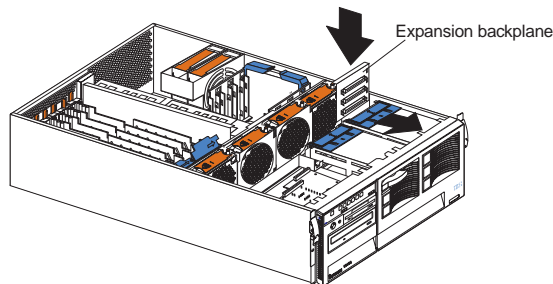

To install a 3-Pack Ultra160 Hot-Swap Expansion Kit:

**Attention:** When you handle Electrostatic Discharge-Sensitive devices (ESD), take precautions to avoid damage from static electricity. For details on handling these devices, refer to the following Web site and search for ESD:  
<http://www.ibm.com>

1. Review the information in "Before you begin" on page 50 and in "Safety information" on page 127
2. Turn off the server and peripheral devices and disconnect all power cords and external cables; then, remove the top cover (see "Removing the server top cover and bezel" on page 53).
3. Refer to the documentation that comes with the option to assemble the hot-swap expansion option.
4. Align the hot-swap expansion option with the empty slot at the rear of the optional hard disk drive cage, adjacent to the standard hot-swap hard disk drive backplane.
5. Slide the hot-swap expansion option down into the guides on the slot at the rear of the optional hard disk drive cage, and secure it to the server with the blue slide latch located on top of the optional hard disk drive cage.
6. Refer to the documentation that comes with the option to complete the installation of the option.
7. Install additional internal hot-swap hard disk drives in the optional hard disk drive cage (see "Installing a hot-swap hard disk drive" on page 62), and connect the drives to the optional hot-swap backplane. You can connect a maximum of three hot-swap hard disk drives to the optional hot-swap backplane.

**Note:** If you connected these optional hot-swap hard disk drives to the optional hot-swap backplane, then the optional hot-swap backplane sets the SCSI IDs for the optional hot-swap backplane and the hot-swap hard disk drives. See “Setting SCSI IDs” on page 80 for additional information.

8. If you have other options to install or remove, do so now; otherwise, go to “Installing the server top cover and bezel” on page 74

---

## Replacing a hot-swap fan

The server comes with six hot-swap fans. You do not need to turn off the power to the server to replace a hot-swap fan assembly.

**Attention:** To help ensure proper cooling, replace a fan that has failed within 48 hours.

**Note:** The speed of the fans will increase if:

- One fan fails.
- Ambient temperature gets too high.

The following illustration shows how to replace hot-swap fans.

**Note:** The illustrations in this document might differ slightly from your hardware.

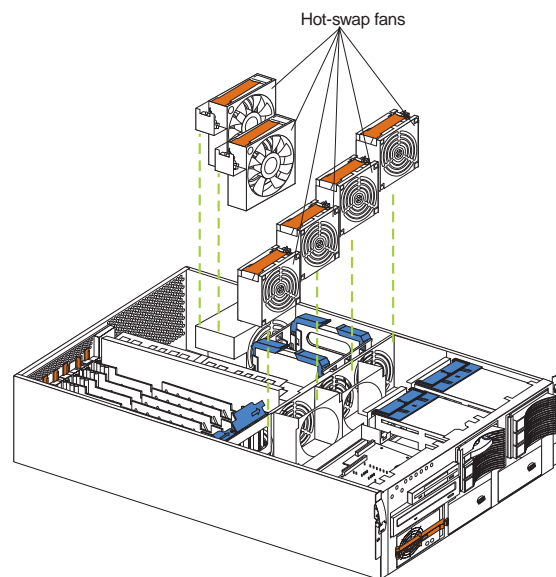

To replace a hot-swap fan assembly:

1. Remove the top cover (see “Removing the server top cover and bezel” on page 53).

**Attention:** To ensure proper system cooling, do not remove the top cover for more than 30 minutes during this procedure.

2. Lift the fan release handle and lift the fan out of the server.
3. Slide the replacement fan into the server and press the handle down.
4. Replace the top cover (see “Installing the server top cover and bezel” on page 74).

---

## Completing the installation

To complete the installation, you must reinstall the top cover, reinstall the bezel, reconnect all cables that you disconnected, and, for certain options, run the Configuration/Setup Utility program. Follow the instructions in this section.

**Attention:** For correct cooling and airflow, install the top cover before turning on the server. Operating the server for extended periods of time (over 30 minutes) with the top cover removed might damage server components.

To complete the installation, you must reinstall the top cover, reinstall the media-bay bezel, reconnect all the cables that you disconnected earlier and, for certain options, run the Configuration/Setup Utility program. Follow the instructions in this section.

**Attention:** For correct cooling and airflow, install the top cover before turning on the server. Operating the server for extended periods of time (over 30 minutes) with the top cover removed might damage server components.

**Note:** If you have just plugged the power cords of the server into an electrical outlet, you will have to wait approximately 20 seconds before pressing the power-control button.

## Installing the server top cover and bezel

The following illustration shows how install the server top cover.

**Note:** The illustrations in this document might differ slightly from your hardware.

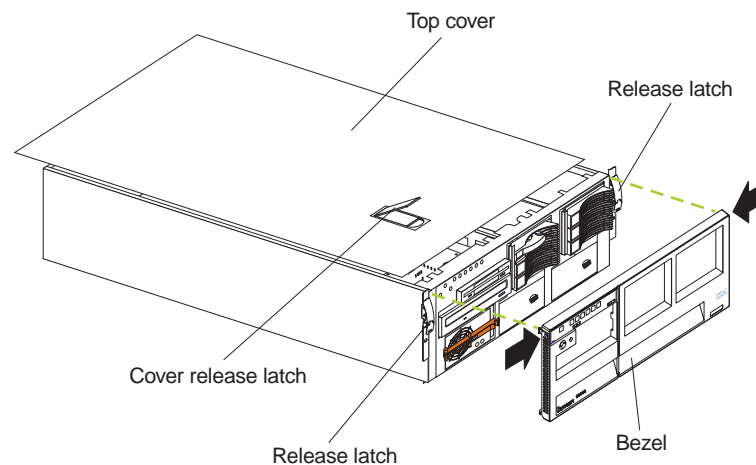

To install the server top cover:

1. Before installing the cover, check that all cables, adapters, and other components are installed and seated correctly and that you have not left loose tools or parts inside the server.
2. Place the cover-release latch in the open (up) position.
3. Insert the bottom tabs of the top cover in the matching slots in the server chassis.
4. Close the cover-release latch to pull the top cover forward and lock the top cover in place.
5. If you disconnected any cables from the back of the server, reconnect the cables; then, plug the power cords into properly grounded electrical outlets.

**Note:** If necessary, refer to “Input/output ports” on page 76 for connector locations.

To install the bezel:

1. Insert the two tabs on the bottom of the bezel into the matching holes on the server chassis.
2. Push the top of the bezel toward the server until the two tabs at the top of the bezel snap into place.

## Updating the server configuration

When you start the server for the first time after you add or remove an internal option or an external SCSI device, you might see a message telling you that the configuration has changed. The Configuration/Setup Utility program automatically starts so that you can save the new configuration information. See “Configuring the server” on page 33

Some options have device drivers that you need to install. Refer to the documentation that comes with your option for information about installing any required device drivers.

The server comes with at least one microprocessor installed on the system board. If you have installed one or more additional microprocessors, the server can now operate as an SMP server. Therefore, you might need to upgrade your operating system to support SMP.

If the server has a ServeRAID adapter installed and you have installed or removed a hard disk drive, refer to the documentation that comes with your ServeRAID adapter for information about reconfiguring your disk arrays.

---

## Connecting external options

Before you begin:

- Review “Before you begin” on page 50
- Read the documentation that comes with your options.

You can attach external options to the input/output (I/O) connectors on the rear of the server. (See “Input/output ports” on page 76 for more information.)

To attach an external device:

1. Turn off the server and all attached devices.
2. Follow the instructions that come with the option to prepare it for installation and to connect it to the server.

**Note:** If you are attaching an external SCSI device, see “Ultra160 SCSI ports” on page 79 for information about SCSI cabling and SCSI IDs.

---

## Input/output ports

This section provides information about the input/output (I/O) ports on the rear of the server. These ports include the following:

- One parallel port
- One video port
- One keyboard port
- One auxiliary-device port (pointing device) port
- Two Ultra160 SCSI ports
- Two serial ports
- Two Universal Serial bus (USB) ports
- One Ethernet port
- Three communication ports dedicated to the Advanced System Management processor

The following illustration shows the I/O port connectors on the rear of the server.

**Note:** The illustrations in this document might differ slightly from your hardware.

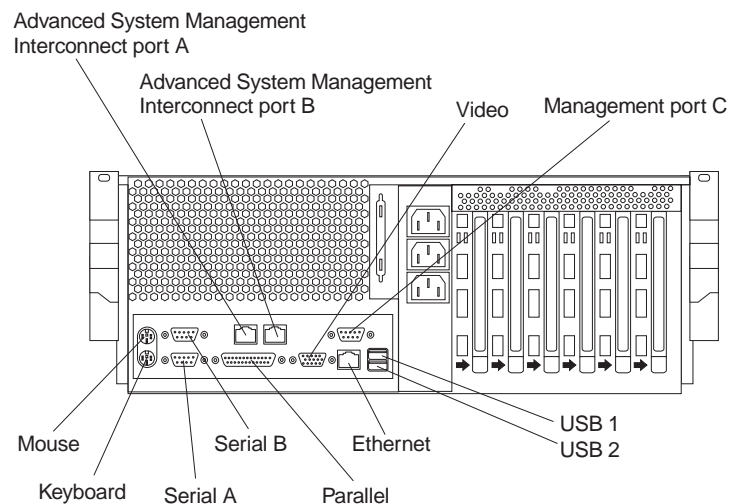

## Parallel port

The server has one parallel port. This port supports three standard Institute of Electrical and Electronics Engineers (IEEE) 1284 modes of operation: Standard Parallel Port (SPP), Enhanced Parallel Port (EPP), and Extended Capability Port (ECP).

### Viewing or changing the parallel-port assignments

You can use the built-in Configuration/Setup Utility program to configure the parallel port as bidirectional; that is, so that data can be both read from and written to a device. In bidirectional mode, the server supports the ECP and EPP modes.

To view or change the parallel-port assignment:

1. Restart the server and watch the monitor screen.
2. When the message Press F1 for Configuration/Setup appears, press F1.

**Note:** The Devices and I/O Ports choice appears only on the full configuration menu. If you set two levels of passwords, you must enter the administrator password to access the full configuration menu.

3. From the main menu, select **Devices and I/O Ports**; then, press Enter.

- Select the parallel port; then, use the arrow keys to advance through the settings available.

**Note:** When you configure the parallel port as bidirectional, use an IEEE 1284-compliant cable. The maximum length of the cable must not exceed 3 meters (9.8 feet).

- Select **Save Settings**; then, select **Exit Setup** to exit from the Configuration/Setup Utility main menu.

### Parallel port connector

The following table shows the pin-number assignments for the 25-pin, female D-shell parallel-port connector on the rear of the server.

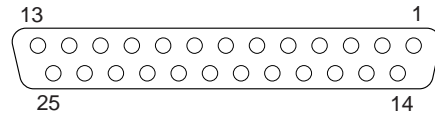

Table 13. Parallel-port connector pin-number assignments

Pin	I/O	SPP/ECP Signal	EPP Signal
1	O	-STROBE	-WRITE
2	I/O	Data 0	Data 0
3	I/O	Data 1	Data 1
4	I/O	Data 2	Data 2
5	I/O	Data 3	Data 3
6	I/O	Data 4	Data 4
7	I/O	Data 5	Data 5
8	I/O	Data 6	Data 6
9	I/O	Data 7	Data 7
10	I	-ACK	-ACK
11	I	BUSY	-WAIT
12	I	PE (paper end)	PE (paper end)
13	I	SLCT (select)	SLCT (select)
14	O	-AUTO FD (feed)	-AUTO FD
15	I	-ERROR	-ERROR
16	O	-INIT	-INIT
17	O	-SLCT IN	-SLCT IN
18	—	Ground	Ground
19	—	Ground	Ground
20	—	Ground	Ground
21	—	Ground	Ground
22	—	Ground	Ground
23	—	Ground	Ground
24	—	Ground	Ground
25	—	Ground	Ground

## Video port

The server comes with an integrated super video graphics array (SVGA) video controller. This controller is not removable, but you can disable it by installing a PCI video adapter.

**Note:** If you install a PCI video adapter, the server BIOS will automatically disable the integrated video controller.

The following table shows the pin-number assignments for the 15-pin analog video connector on the rear of the server.

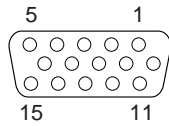

Table 14. Video-port connector pin-number assignments

Pin	Signal
1	Red
2	Green or monochrome
3	Blue
4	Monitor ID bit 2
5	Ground
6	Ground
7	Ground
8	Ground
9	+5 V dc
10	Ground
11	Monitor ID bit 0
12	DDC SDA
13	Horizontal synchronization (Hsynch)
14	Vertical synchronization (Vsynch)
15	DDC SCL

## Keyboard port

There is one keyboard connector on the rear of the server.

**Note:** If you attach a standard (non-USB) keyboard to the keyboard connector, the USB ports and devices will be disabled during the power-on self-test (POST).

The following table shows the pin-number assignments for the keyboard connector on the rear of the server.

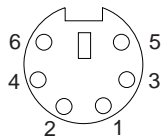



Table 15. Keyboard connector pin-number assignments

Pin	I/O	Signal
1	I/O	Data
2	N/A	Reserved
3	N/A	Ground
4	N/A	+5 V dc
5	I/O	Keyboard clock
6	N/A	Reserved

## Auxiliary-device (pointing device) port

The system board has one auxiliary-device port that supports a mouse or other pointing device.

The following table shows the pin-number assignments for the auxiliary-device connector on the rear of the server.

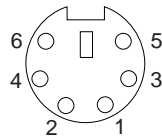

Table 16. Auxiliary-device connector pin-number assignments

Pin	Signal
1	Data
2	Not connected
3	Ground
4	+5 V dc
5	Clock
6	Not connected

## Ultra160 SCSI ports

The server has an integrated dual-channel Ultra160 small computer system interface (SCSI) controller. This controller supports two independent Ultra 160/m SCSI channels: one internal and one external. Each of these channels supports up to 15 SCSI devices. In addition, this controller uses:

- Double-transition clocking to achieve high transfer rates
- Domain name validation to negotiate compatible data transfer speeds with each device
- Cyclic-redundancy checking (CRC), instead of the usual parity checking, to significantly improve data reliability
- An active terminator on the system board for SCSI bus termination

The server comes with two SCSI cables. One cable connects the internal SCSI channel connector to the standard hot-swap-drive backplane. The other cable is not connected to the server when the server is shipped and must be installed in the server. If you want to use the external LVD SCSI channel connector to connect external SCSI devices to the server, remove the knockout on the rear of the server and install the LVD SCSI cable that comes with the server.

**Note:** If you install a PCI RAID adapter to configure and manage the internal hot-swap drives, you must move the SCSI cable from the system-board SCSI connector to an internal channel connector on the RAID adapter. See “Cabling example for the ServeRAID adapter” on page 56 for additional information.

### SCSI cabling requirements

If you plan to attach external SCSI devices, you must order additional SCSI cables. To select and order the correct cables for use with external devices, contact your IBM reseller or IBM marketing representative.

For information about the maximum length of SCSI cable between the terminated ends of the cable, refer to the ANSI SCSI standards. Adhering to these standards will help ensure that the server operates properly.

### Setting SCSI IDs

Each SCSI device connected to a SCSI controller must have a unique SCSI ID. This ID enables the SCSI controller to identify the device and ensure that different devices on the same SCSI channel do not attempt to transfer data simultaneously. SCSI devices that are connected to different SCSI channels can have duplicate SCSI IDs. The following table lists the SCSI IDs for devices that are connected to one channel. Note that the hot-swap hard disk drive bay numbers are from bottom to top.

Table 17. SCSI IDs for hot-swap hard disk drives and backplanes

Standard	Optional
Drive bay 1: SCSI ID 0	Drive bay 4: SCSI ID 12
Drive bay 2: SCSI ID 1	Drive bay 5: SCSI ID 13
Drive bay 3: SCSI ID 2	Drive bay 6: SCSI ID 14
Backplane: SCSI ID 8	Backplane: SCSI ID 9

The hot-swap-drive backplane controls the SCSI IDs for the internal hot-swap drive bays. However, when you attach a SCSI device to the external SCSI connector, you must set a unique ID for the device. Refer to the information that is provided with the device for instructions to set its SCSI ID.

### SCSI connector pin-number assignments

The following table shows the pin-number assignments for the 68-pin SCSI connectors.

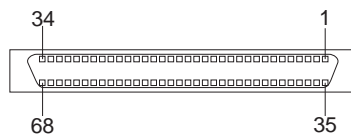

Table 18. 68-pin SCSI connector pin-number assignments

Pin	Signal	Pin	Signal
1	+Data 12	35	-Data 12
2	+Data 13	36	-Data 13
3	+Data 14	37	-Data 14
4	+Data 15	38	-Data 15
5	+Data P1	39	-Data P1
6	+Data 0	40	-Data 0
7	+Data1	41	-Data 1
8	+Data 2	42	-Data 2
9	+Data 3	43	-Data 3
10	+Data 4	44	-Data 4
11	+Data 5	45	-Data 5
12	+Data 6	46	-Data 6
13	+Data 7	47	-Data 7
14	+Data P	48	-Data P
15	Ground	49	Ground
16	DIFFSENS	50	Ground
17	Term power	51	Term power
18	Term power	52	Term power
19	Reserved	53	Reserved
20	Ground	54	Ground
21	+Attention	55	-Attention
22	Ground	56	Ground
23	+Busy	57	-Busy
24	+Acknowledge	58	-Acknowledge
25	+Reset	59	-Reset
26	+Message	60	-Message
27	+Select	61	-Select
28	+Control/Data	62	-Control/Data
29	+Request	63	-Request
30	+Input/Output	64	-Input/Output
31	+Data 8	65	-Data 8
32	+Data 9	66	-Data9
33	+Data 10	67	-Data 10
34	+Data 11	68	-Data 11

## Serial ports

The server has two standard serial ports: Serial port A and Serial port B. The operating system can use and share both serial ports; however, the integrated Advanced System Management processor can use and share only Serial port A.

Some application programs require specific ports, and some modems function properly only at certain communication port addresses. You might need to use the Configuration/Setup Utility program to change communication port address assignments to prevent or resolve address conflicts.

## Viewing or changing the serial-port assignments

To view or change the serial-port assignments:

1. Restart the server and watch the monitor screen.
2. When the message Press F1 for Configuration/Setup appears, press F1.
3. From the main menu, select **Devices and I/O Ports**; then, press Enter.

**Note:** The Devices and I/O Ports choice appears only on the full configuration menu. If you set two levels of passwords, you must enter the administrator password to access the full configuration menu.

4. Select the serial port; then, use the arrow keys to advance through the settings available.
5. Select **Save Settings**; then, select **Exit Setup** to exit from the Configuration/Setup Utility main menu.

## Serial-port connectors

The following table shows the pin-number assignments for the 9-pin, male D-shell serial-port connectors on the rear of the server. These pin-number assignments conform to the industry standard.

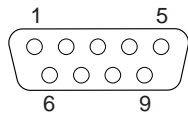

Table 19. Serial-port connectors pin-number assignments

Pin	Signal	Pin	Signal
1	Data carrier detect	6	Data set ready
2	Receive data	7	Request to send
3	Transmit data	8	Clear to send
4	Data terminal ready	9	Ring indicator
5	Signal ground		

## Universal Serial Bus ports

The server has two Universal Serial Bus (USB) ports, which configure automatically. USB is an emerging serial interface standard for telephony and multimedia devices. It uses Plug and Play technology to determine the type of device attached to the connector.

### Notes:

1. If you attach a standard (non-USB) keyboard to the keyboard connector, the USB ports and devices will be disabled during the power-on self-test (POST).
2. If you install a USB keyboard that has a mouse port, the USB keyboard emulates a mouse and you will not be able to disable the mouse settings in the Configuration/Setup Utility program.

## USB cables and hubs

You need a 4-pin cable to connect devices to USB 1 or USB 2. If you plan to attach more than two USB devices, you must use a hub to connect the devices. The hub provides multiple connectors for attaching additional external USB devices.

USB technology provides up to 12 megabits-per-second (Mbps) speed with a maximum of 127 external devices and a maximum signal distance of five meters (16 ft.) per segment.

## USB-port connectors

Each USB port has an external connector on the rear of the server for attaching USB compatible devices.

The following table shows the pin-number assignments for the USB-port connectors on the rear of the server.

Table 20. USB-port connector pin-number assignments

Pin	Signal
1	VCC
2	-Data
3	+Data
4	Ground

## Ethernet port

The server comes with an integrated Ethernet controller. This controller provides an interface for connecting to 10-Mbps or 100-Mbps networks and provides full-duplex (FDX) capability, which enables simultaneous transmission and reception of data on the Ethernet local area network (LAN).

To access the Ethernet port, connect a Category 3, 4 or 5 unshielded twisted-pair (UTP) cable to the RJ-45 connector on the rear of the server.

**Note:** The 100BASE-TX Fast Ethernet standard requires that the cabling in the network be Category 5 or higher.

The Ethernet (RJ-45) connector has two lights. The Ethernet link-status light is on the left. When this green light is on, there is an active connection on the Ethernet port. The Ethernet transmit/receive activity light on the right. When this amber light is on, there is activity between the server and the network. These lights have the same functions as the Ethernet link-status light and the Ethernet transmit/receive activity light on the information panel (see "Information LED panel" on page 9).

### Configuring the Ethernet controller

When you connect the server to the network, the Ethernet controller automatically detects the data-transfer rate (10 Mbps or 100 Mbps) on the network and then sets the controller to operate at the appropriate rate. That is, the Ethernet controller will adjust to the network data rate, whether the data rate is standard Ethernet (10BASE-T), Fast Ethernet (100BASE-TX), half duplex (HDX), or full duplex (FDX). The controller supports half-duplex (HDX) and full-duplex (FDX) modes at both speeds.

The Ethernet controller is a PCI Plug and Play device. You do not need to set any jumpers or configure the controller for your operating system before you use the Ethernet controller. However, you must install a device driver to enable your operating system to address the Ethernet controller. The device drivers are provided on the ServerGuide CDs.

### Failover for redundant Ethernet

The IBM 10/100 Fault Tolerant Adapter is an optional redundant network interface card (NIC adapter) that you can install in the server. If you install this NIC adapter and connect it to the same logical LAN segment as the primary Ethernet controller, you can configure the server to support a *failover* function. You can configure either the integrated Ethernet controller or the NIC adapter as the primary Ethernet controller. In failover mode, if the primary Ethernet controller detects a link failure,

all Ethernet traffic associated with it is switched to the redundant (secondary) controller. If the appropriate device drivers are installed, this switching occurs without any user intervention. When the primary link is restored to an operational state, the Ethernet traffic switches back to the primary Ethernet controller. The switch back to the primary Ethernet controller can be automatic or manually controlled, depending on the setup and operating system.

Note that only one controller in the redundant pair is active at any given time. For example, if the primary Ethernet controller is active, then the secondary Ethernet controller cannot be used for any other network operation.

**Note:** Your operating system determines the maximum number of IBM 10/100 Fault Tolerant Adapters that you can install in the server. See the documentation that comes with the adapter for more information.

**Considerations when combining failover and hot-plug functions:** If your operating system supports hot-plug PCI adapters and the optional redundant NIC adapter is installed in a hot-plug PCI slot, you can replace the NIC adapter without powering off the server — even if it is the primary Ethernet controller. Disconnecting the Ethernet cable from the primary Ethernet controller will cause the Ethernet traffic to switch automatically to the secondary Ethernet controller. This can be very useful if a faulty adapter causes a network problem, or if you want to upgrade the primary adapter hardware.

**Note:** If you hot-replace the primary adapter while the Ethernet traffic is being handled by the secondary Ethernet controller, the traffic does not automatically switch back to the primary adapter when the primary adapter comes back online. See “Configuring for failover”..

**Configuring for failover:** The failover feature currently is supported by Windows NT Server and IntraNetWare. The setup required for each operating system follows.

*Windows NT Server:*

IBM offers hot-plug support for Windows NT Server Version 4.0. Failover can work in conjunction with hot-plug support or independently. If you are not using hot-plug support, go to “Windows NT Server failover setup” on page 85

*Windows NT Server hot-plug setup:*

IBM Hot Plug PCI for Windows NT Server 4.0 package is available for download from the IBM Web site at:

<http://www.pc.ibm.com/support>

Enter the brand type of **Server**, click on **Downloadable files** and look for **Hot Plug**. The IBM Hot Plug PCI for Windows NT Server 4.0 package uses the Intel Desktop Management Interface (DMI) to control hot-plug support for the Ethernet controllers. The Ethernet controller in your computer is DMI compliant. Download and install the following software in the order listed:

1. IBM PCI Hotplug for Windows NT 4.0 Failover DMI Agent
2. IBM PCI Hotplug for Windows NT 4.0 Solution
3. IBM 10/100 Fault Tolerant Adapter device drivers

**Note:** The order of installation is important. You must install the IBM Hot Plug for Windows NT Server 4.0 package before you install the IBM 10/100 Fault Tolerant Adapter driver. If you install the adapter device driver before the PCI

Hot Plug Solution package, the adapter device driver will not recognize the hot-plug code. This happens because the adapter device driver only checks the NT registry for the Hot Plug package during installation. If the PCI Hot Plug Solution package is added after the adapter device driver is installed, the adapter must be removed and added again in order for it to detect the PCI Hot-Plug Solution code.

To install the IBM PCI Hotplug for Windows NT 4.0 Failover DMI Agent:

1. Download the IBM PCI Hotplug for Windows NT 4.0 Failover DMI Agent file from the xSeries Support web page and extract the files onto a diskette.
2. Insert the diskette into the diskette drive.
3. From the Start menu, select the **Run** option.
4. Type A:\SETUP.EXE in the Open box.
5. Click **Ok**. The setup wizard opens.
6. Follow the instructions that are given by the setup wizard until the program is installed.
7. Restart the server.

To install the IBM PCI Hotplug for Windows NT 4.0 Solution package:

1. Download the IBM PCI Hotplug for Windows NT 4.0 Solution file from the xSeries Support web page and extract the files onto a diskette.
2. Log on to Windows NT Server as a user in the Administrator group.
3. Insert the diskette into the diskette drive.
4. From the Start menu, select the **Run** option.
5. Type A:\SETUP.EXE in the Open box.
6. Click **OK**. The Setup wizard opens.
7. Follow the instructions given by the setup wizard until the program is installed.

*Windows NT Server failover setup:*

To install the IBM 10/100 Fault Tolerant Adapter device drivers:

1. Add the redundant NIC adapter according to the instructions that are provided with the adapter.
2. Use the ServerGuide CDs to install the AMD PCNet Ethernet Family adapter device driver.
3. Do not select the Grouping box at this point; you must first restart the machine.
4. From the Windows NT Server desktop, select **Control Panel**, then select the **Network** icon, then select the **Adapters** tab.
5. Highlight one of the adapters that will be in the redundant pair and then click the **Properties...** button.
6. Check the Grouping box. This will show the possible combinations for redundant pairs.
7. Select the adapter pair you want and then select **OK**. Note that the integrated Ethernet controller is located at PCI C.

Two options are available for recovering from a failover condition. The options are determined by the Enable for DMI / Hot Swap Support checkbox. If the IBM Hot Plug PCI for Windows NT Server 4.0 package is installed, this checkbox will appear at the bottom of the Adapter Properties panel. If you do not have the IBM Hot Plug PCI for Windows NT Server 4.0 package installed on the server, you will not see the Enable for DMI / Hot Swap Support checkbox.

If the Enable for DMI / Hot Swap Support checkbox is not checked or is not present, traffic will automatically switch back to the primary adapter when the primary link status is restored. In this mode, the adapter cannot be hot-swapped. Users with the IBM Hot Plug PCI for Windows NT Server 4.0 package installed should check the Enable for DMI / Hot Swap Support checkbox.

If the Enable for DMI / Hot Swap Support checkbox is checked, traffic will remain on the secondary adapter until the user directs it to return to the primary adapter. This can be done after the hot-swap replacement of the primary adapter or by using the DMI interface.

8. Select **Close** to exit from the Network setup.

When you restart the server, the failover function will be in effect.

If a failover occurs, a message is written to the NT Event Viewer log. In addition, if the Enable for DMI / Hot Swap Support checkbox is checked, a DMI alert will also be generated.

*IntraNetWare:*

The IBM PCI Hot Plug System Bus Driver Diskette for Novell Netware V4.41, V4.42, and V5.0 is available for download from the IBM Web site at:

<http://www.pc.ibm.com/support>

The failover function is now enabled. If a failover occurs:

- The operating system console generates a message.
- The custom counters for the device driver contain variables that define the state of the failover function and the location of the redundant pair. You can use the NetWare Monitor to view the custom counters.

**Note:** If the primary adapter was hot-replaced while the Ethernet traffic was being handled by the secondary Ethernet controller, the traffic does not automatically switch back to the primary adapter when the primary adapter comes back online. In this case, issue the command:

```
LOAD d:\path\PCNTNW SCAN
```

where *d* and *path* are the drive and path where the driver is located. This command causes the device driver to locate the primary adapter and switch the Ethernet traffic to it.

### **Ethernet port connector**

The following table shows the pin-number assignments for the RJ-45 connector. These assignments apply to both 10BASE-T and 100BASE-TX devices.

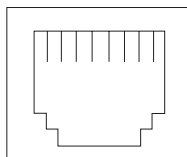



Table 21. Ethernet RJ-45 connector pin-number assignments.

Pin	Signal	Pin	Signal
1	Transmit data+	5	Not connected
2	Transmit data-	6	Receive data -
3	Receive data+	7	Not connected
4	Not connected	8	Not connected

## Advanced System Management ports

The server has three communication ports dedicated to the Advanced System Management processor. One port uses a standard D-shell serial-port connector, connector C. The other two ports, which are used for the ASM Interconnect function, use a dual RJ-45 connector.

You can attach a dedicated modem to the D-shell system-management connector on the rear of the server to communicate with the integrated Advanced System Management processor.

The ASM Interconnect function uses the RJ-45 system-management connectors. This function enables you to connect the Advanced System Management processors of several rack-mounted servers so that they can communicate with each other in half-duplex mode.

The following illustration shows the connectors and lights for the Advanced System Management Interconnect board.

**Note:** The illustrations in this document might differ slightly from your hardware.

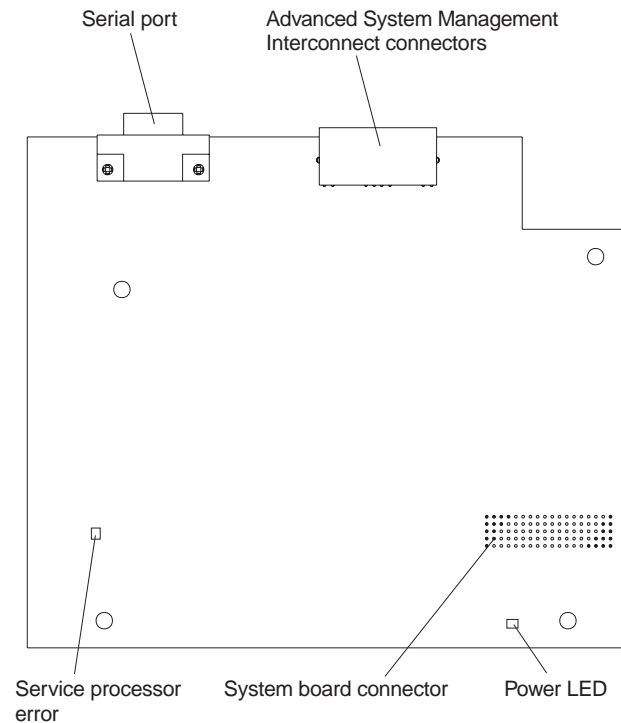

---

## Cabling the server

The following illustration shows the cabling for a typical server configuration.

**Notes:**

1. The illustrations in this document might differ slightly from your hardware.
2. Refer to the documentation that comes with your options for additional cabling instructions. It might be easier for you to route any cables before you install certain options.
3. Cable identifiers are printed on the cables that come with the server and options. Use these identifiers to connect the cables to the correct connectors. For example, the hard disk drive cables are labeled HDD.

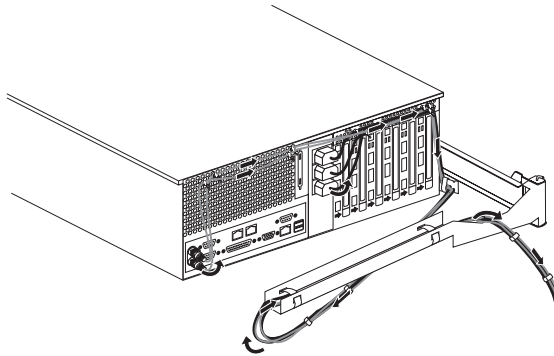

---

## FRU information (service only)

Field Replacement Units (FRUs) should be replaced by qualified service personnel only.

---

### LED switch card

**Before you begin:**

- Read “Safety information” on page 127
- Review the information in “Before you begin” on page 50

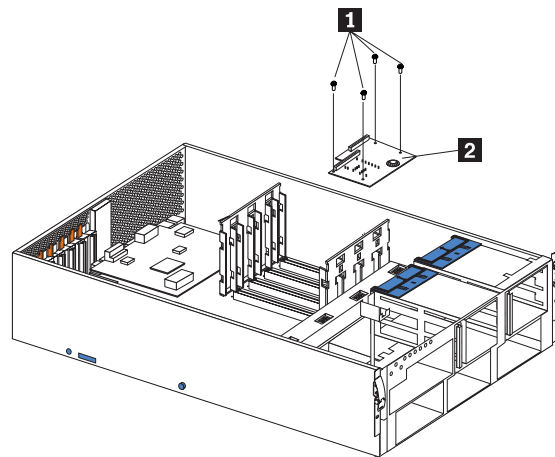

- 1** Holding screws
- 2** LED switch card

To remove the LED switch card, do the following:

1. Power-off the server, if it is on.
2. Unplug the server.
3. Remove the top cover (see “Removing the server top cover and bezel” on page 53).
4. Disconnect the switch card cables.
5. Remove the 4 holding screws.
6. Lift the switch card out of the server.

---

## Four-fan housing

### Before you begin:

- Read “Safety information” on page 127
- Review the information in “Before you begin” on page 50

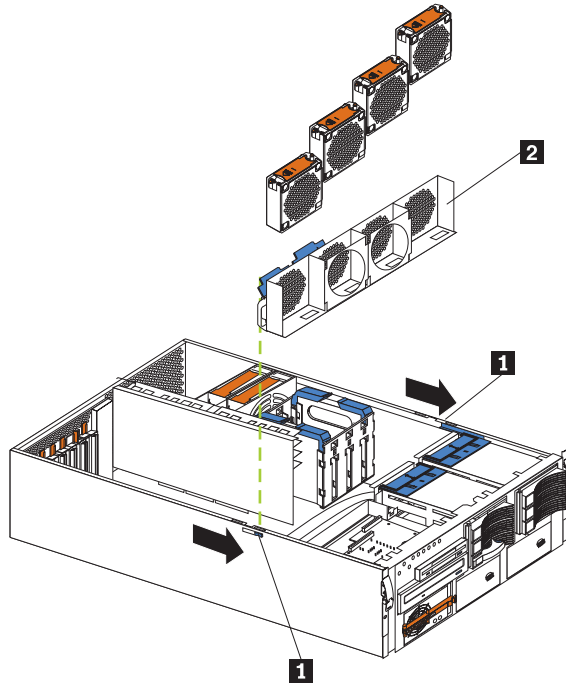

- 1** Release latches
- 2** Fan housing

To remove the four-fan housing, do the following:

1. Power-off the server, if it is on.
2. Unplug the server.
3. Remove the top cover (see “Removing the server top cover and bezel” on page 53).
4. Remove the four fan assemblies.
5. Remove all adapters from the Active PCI adapter slots.
6. Remove the plastic dividers between the PCI adapter slots.
7. Press the fan assembly release latches on both sides of the fan assembly; then, remove the fan assembly from the server.

---

## Dual fan mount assembly with cable

### Before you begin:

- Read “Safety information” on page 127
- Review the information in “Before you begin” on page 50

**Note:** To remove the fan housing assembly with card guides (for four fans), see step 4 on page 57

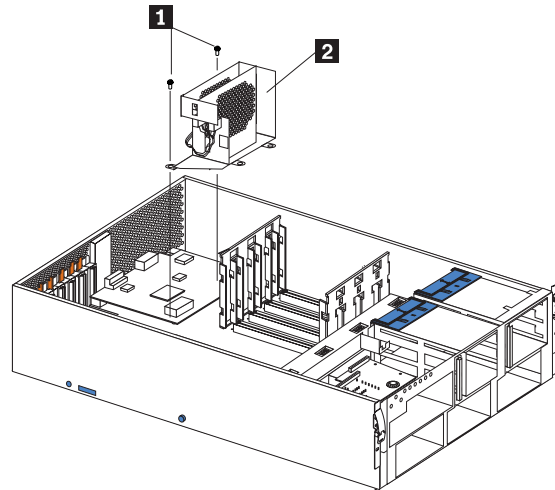

- 1** Holding screws
- 2** Dual fan mount assembly

To remove the dual fan mount assembly with cable, do the following:

1. Power-off the server, if it is on.
2. Unplug the server.
3. Remove the top cover (see “Removing the server top cover and bezel” on page 53).
4. Disconnect the dual fan mount cable.
5. Remove the two holding screws.
6. Gently lift the fan mount assembly out of the server.

---

## Service processor card assembly

### Before you begin:

- Read “Safety information” on page 127
- Review the information in “Before you begin” on page 50

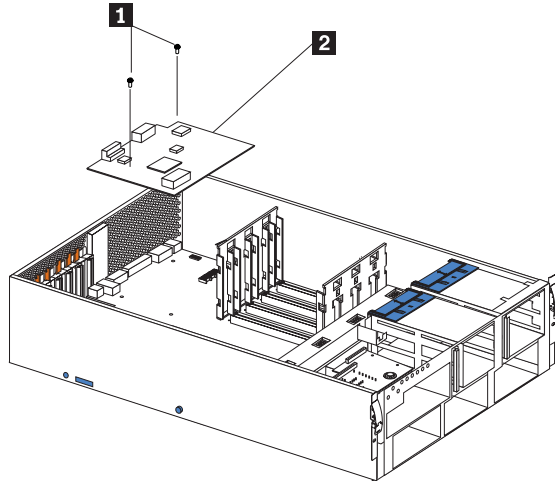

- 1** Holding screws
- 2** Service processor card assembly

To remove the service processor card assembly, do the following:

1. Power-off the server, if it is on.
2. Unplug the server.
3. Remove the top cover (see “Removing the server top cover and bezel” on page 53).
4. Remove the dual fan mount assembly (see “Dual fan mount assembly with cable” on page 91).
5. Remove the two holding screws.
6. Gently lift the service processor card away from the system board and out of the server.

---

## PCI switch card

### Before you begin:

- Read “Safety information” on page 127
- Review the information in “Before you begin” on page 50

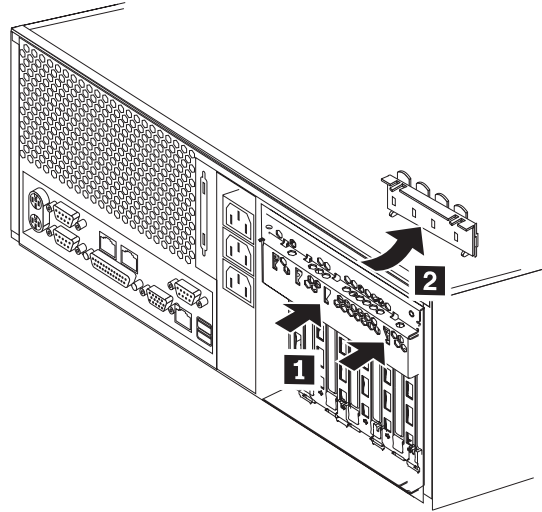

- 1** Switch card latches
- 2** Switch card assembly

1. Power-off the server, if it is on.
2. Disconnect the server from the electrical outlet.
3. Remove the top cover (see “Removing the server top cover and bezel” on page 53).
4. Disconnect the switch card cable from the system board.
5. Disengage the switch card:
  - a. Press the switch card latches toward the front and sides of the server.
  - b. Push the latches through the notches.
6. When the switch card latches have been disengaged from the notches, gently pull the switch card free and lift it up and out of the server.

**Note:** You may have to tilt the top of the switch card toward the front of the server when removing it.

7. To replace the switch card, reverse the steps above.

---

## Power backplane assembly

### Before you begin:

- Read “Safety information” on page 127
- Review the information in “Before you begin” on page 50

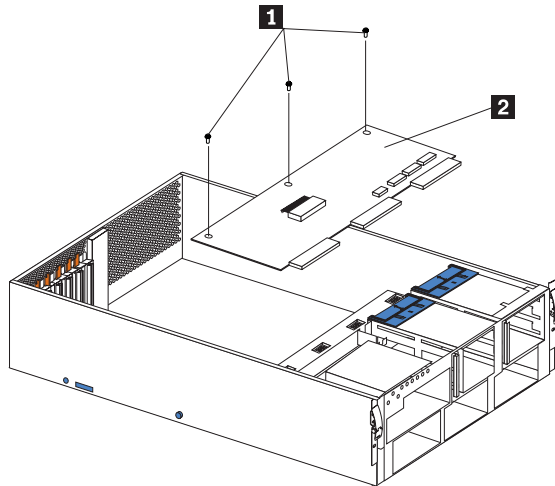

- 1** Holding screws
- 2** Power backplane

To remove the power backplane assembly, do the following:

1. Power-off the server, if it is on.
2. Unplug the server.
3. Remove the top cover (see “Removing the server top cover and bezel” on page 53).
4. Remove the system board assembly (see “System board assembly with backerplate” on page 95).
5. Disconnect all cables to the power backplane.
6. Remove the three holding screws.
7. Lift the power backplane out of the server.



---

## System board assembly with backerplate

### Before you begin:

- Read “Safety information” on page 127
- Review the information in “Before you begin” on page 50

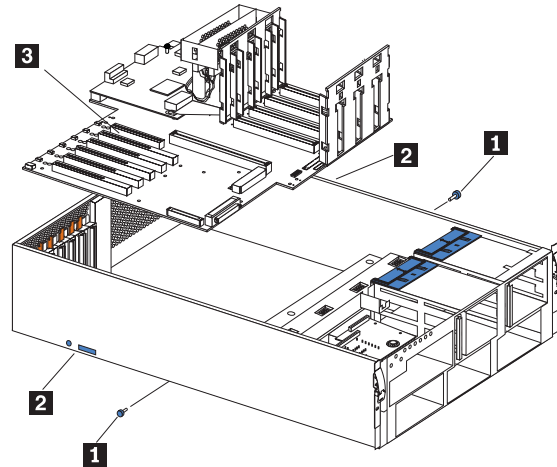

- 1** Shipping screws
- 2** Release latch assembly
- 3** System board assembly

**Note:** When replacing the system board, you must either update the system with the latest firmware or restore the pre-existing firmware that the customer provides on a diskette or CD image.

To remove the system board assembly with backerplate, do the following:

1. Power-off the server, if it is on.
2. Unplug the server.
3. Remove the top cover (see “Removing the server top cover and bezel” on page 53).
4. Remove the four fan assemblies.
5. Remove the four-fan housing (see “Four-fan housing” on page 90).
6. Disconnect cables on the system board.
7. Remove the memory card.
8. Remove all microprocessors.
9. Remove the shipping screw on each side of the server.
10. Engage the release latch assembly:
  - a. Press in on the release button on each side of the server at the same time.
  - b. Push each of the two release latches at the same time toward the rear of the server
11. Gently lift the system board assembly out of the server.
12. Reverse the above steps to connect the system board assembly.

**Note:** Shipping screws do not have to be replaced for the server to function.



---

## Symptom-to-FRU index

This index supports xSeries 350 servers.

### Notes:

1. Check the configuration before you replace a FRU. Configuration problems can cause false errors and symptoms.
2. The default configuration can be loaded by starting the system and then pressing the reset button four times, waiting 15 seconds between each press. Once the configuration has reset to the default, it must be saved in Setup to be stored in CMOS.
3. For IBM devices not supported by index, refer to the manual for that device.
4. Always start with "General checkout" on page 1

The Symptom-to-FRU lists symptoms, errors, and the possible causes. The most likely cause is listed first. Use this Symptom-to-FRU index to help you decide which FRUs to have available when servicing the computer. The POST BIOS displays POST error codes and messages on the screen.

---

## Beep symptoms

Beep symptoms are short tones or a series of short tones separated by pauses (intervals without sound). See the following examples.

**Note:** One beep after successfully completing POST indicates the system is functioning properly.

Beeps	Description
1-2-3	<ul style="list-style-type: none"><li>• One beep</li><li>• A pause (or break)</li><li>• Two beeps</li><li>• A pause (or break)</li><li>• Three Beeps</li></ul>
4	Four continuous beeps

Beep/Symptom	FRU/Action
1-1-3 (CMOS write/read test failed)	<ol style="list-style-type: none"><li>1. <b>Battery</b></li><li>2. System Board</li></ol>
1-1-4 (BIOS EEPROM checksum failed)	<ol style="list-style-type: none"><li>1. <b>System Board</b></li></ol>
1-2-1 (Programmable Interval Timer failed)	<ol style="list-style-type: none"><li>1. <b>System Board</b></li></ol>
1-2-2 (DMA initialization failed)	<ol style="list-style-type: none"><li>1. <b>System Board</b></li></ol>
1-2-3 (DMA page register write/read failed)	<ol style="list-style-type: none"><li>1. <b>System Board</b></li></ol>

<b>Beep/Symptom</b>	<b>FRU/Action</b>
<b>1-2-4</b> (RAM refresh verification failed)	1. <b>DIMM</b> 2. System Board 3. Memory Card
<b>1-3-1</b> (1st 64K RAM test failed)	1. <b>DIMM</b> 2. Memory Card 3. System Board
<b>1-3-2</b> (1st 64K RAM parity test failed)	1. <b>DIMM</b> 2. Memory Card 3. System Board
<b>1-4-3</b> (Interrupt vector loading test failed)	1. <b>System Board</b>
<b>2-1-1</b> (Secondary DMA register failed)	1. <b>System Board</b>
<b>2-1-2</b> (Primary DMA register failed)	1. <b>System Board</b>
<b>2-1-3</b> (Primary interrupt mask register failed)	1. <b>System Board</b>
<b>2-1-4</b> (Secondary interrupt mask register failed)	1. <b>System Board</b>
<b>2-2-1</b> (Interrupt vector loading failed)	1. <b>System Board</b>
<b>2-2-2</b> (Keyboard controller failed)	1. <b>System Board</b> 2. Keyboard
<b>2-2-3</b> (CMOS power failure and checksum checks failed)	1. <b>Battery</b> 2. System board
<b>2-2-4</b> (CMOS configuration info validation failed)	1. <b>Battery</b> 2. System board
<b>2-3-1</b> (Screen initialization failed)	1. <b>System Board</b>
<b>2-3-2</b> (Screen memory failed)	1. <b>System board</b>
<b>2-3-3</b> (Screen retrace failed)	1. <b>System board</b>
<b>2-3-4</b> (Search for video ROM failed)	1. <b>System board</b>

Beep/Symptom	FRU/Action
<b>2-4-1</b> (Video failed, screen believed operable)	1. <b>System board</b>
<b>3-1-1</b> (Timer tick interrupt failed)	1. <b>System Board</b>
<b>3-1-2</b> (Interval timer channel 2 failed)	1. <b>System Board</b>
<b>3-1-3</b> (RAM test failed above address OFFFF h)	1. <b>DIMM</b> 2. Memory card 3. System board
<b>3-1-4</b> (Time-Of-Day clock failed)	1. <b>Battery</b> 2. System Board
<b>3-2-1</b> (Serial port failed)	1. <b>System board</b>
<b>3-2-2</b> (Parallel port failed)	1. <b>System board</b>
<b>3-2-3</b> (Math coprocessor failed)	1. <b>Optional processor (if installed)</b> 2. Processor 3. System board
<b>3-2-4</b> (Failure comparing CMOS memory size against actual)	1. <b>DIMM</b> 2. Battery 3. System board
<b>3-3-1</b> (Memory size mismatch occurred, see "Memory Settings" on page 37)	1. <b>DIMM</b> 2. System board 3. Battery
<b>3-3-2</b> (Critical SMBUS error occurred) (I2C bus error)	1. <b>Disconnect the server power cord from outlet, wait 30 seconds and retry.</b> 2. System Board 3. DIMMs 4. Memory Card 5. DASD Backplane 6. Power Supply 7. Power Supply Backplane 8. I2C Cable
<b>3-3-3</b> (No operational memory in system)	1. <b>Install or reseat the memory modules, then do a 3 boot reset.</b> (See "Using the Configuration/Setup Utility program" on page 33) 2. DIMMs 3. Memory Card 4. System Board

Beep/Symptom	FRU/Action
<b>Two Short Beeps</b> (Information only, the configuration has changed)	<ol style="list-style-type: none"> <li>1. <b>Run Diagnostics</b></li> <li>2. Run Configuration/Setup</li> </ol>
<b>Three Short Beeps</b>	<ol style="list-style-type: none"> <li>1. <b>DIMM</b></li> <li>2. System Board</li> </ol>
<b>One Continuous Beep</b>	<ol style="list-style-type: none"> <li>1. <b>Processor</b></li> <li>2. Optional Processor (if installed)</li> <li>3. System Board</li> <li>4. Service Processor Card</li> </ol>
<b>Repeating Short Beeps</b>	<ol style="list-style-type: none"> <li>1. <b>Keyboard</b></li> <li>2. System Board</li> </ol>
<b>One Long and One Short Beep</b>	<ol style="list-style-type: none"> <li>1. <b>Video adapter (if present)</b></li> <li>2. System Board</li> </ol>
<b>One Long and Two Short Beeps</b>	<ol style="list-style-type: none"> <li>1. <b>Video adapter (if present)</b></li> <li>2. System Board</li> </ol>
<b>Two Long and Two Short Beeps</b>	<ol style="list-style-type: none"> <li>1. <b>Video adapter</b></li> </ol>

---

## No beep symptoms

No Beep Symptom	FRU/Action
<b>No beep and the system operates correctly.</b>	<ol style="list-style-type: none"> <li>1. <b>Diagnostic LED Panel</b></li> </ol>
<b>No Beeps occur after successfully completing POST</b> (The Power-On Status is disabled.)	<ol style="list-style-type: none"> <li>1. <b>Run Configuration/Setup, set the Start Options Power-On Status to enable.</b></li> <li>2. Diagnostic LED Panel</li> <li>3. System Board</li> </ol>
<b>No ac power</b> (Power supply ac LED is off)	<ol style="list-style-type: none"> <li>1. <b>Check the power cord.</b></li> <li>2. Power Supply (If two are installed, swap them to determine if one is defective.)</li> <li>3. Power Backplane</li> </ol>
<b>No beep and no video</b>	<ol style="list-style-type: none"> <li>1. <b>See “Undetermined problems” on page 122</b></li> </ol>
<b>System will not power-up</b> (Power supply ac LED is on)	<ol style="list-style-type: none"> <li>1. <b>See “Power supply LED errors” on page 110</b></li> </ol>

## Diagnostic panel error LEDs

The system error LED is turned on when an error is detected. If the system error LED is on, remove the cover and check the diagnostic panel LEDs. The following is a complete list of diagnostic panel LEDs followed by the FRU/Action for correcting the problem.

**Note:** If a diagnostic panel LED is on and the information LED panel system error LED is off, there is probably an LED problem. Run LED diagnostics.

**Notes:**

1. To locate the LEDs on the system board see "System board component locations" on page 42
2. Check the System Error Log for additional information before replacing a FRU.
3. It may be necessary to view the System Error Log from a remote connection, such as MOST.
4. The memory card DIMM error LEDs and processor error LEDs turn off when the system is powered down.

<b>Note:</b> The System Error LED will also be on.	
<b>Diagnostic Panel LED</b>	<b>FRU/Action</b>
<b>All LEDs off</b> (Check System Error Log for error condition, then clear System Error Log when the problem is found.)	<ol style="list-style-type: none"> <li>1. <b>System Error Log is 75% full; clear the log.</b></li> <li>2. Bad, missing or mis-installed processor terminator; remove and reinsert terminator.</li> <li>3. PFA alert; check error log for failure; clear PFA alert; remove AC power for at least 20 seconds, reconnect, then power up system.</li> <li>4. Run Information Panel diagnostics.</li> </ol>
<b>CPU LED on</b> (The LED next to the failing CPU should be on.)	<ol style="list-style-type: none"> <li>1. <b>Insure terminator (or processor if multiprocessor system) is installed in slot D.</b> See "Installing a microprocessor kit" on page 66</li> <li>2. Processor 1, 2, 3, or 4</li> <li>3. System Board.</li> </ol>
<b>DASD LED on</b> (Check amber drive LED for a failing hard drive if RAID system.)	<ol style="list-style-type: none"> <li>1. <b>Be sure the fans are operating correctly and the air flow is good.</b></li> <li>2. Failing drive.</li> <li>3. SCSI Backplane.</li> </ol>
<b>FAN LED on</b>	<ol style="list-style-type: none"> <li>1. <b>Check individual fan LEDs.</b></li> <li>2. Replace respective fan.</li> <li>3. Fan Cable.</li> <li>4. System Board.</li> <li>5. Power Backplane Board.</li> </ol>
<b>MEM LED on</b> (The LED next to the failing DIMM is on.)	<ol style="list-style-type: none"> <li>1. <b>Failing DIMM(s) in slot J1-J16.</b></li> <li>2. Memory Card.</li> <li>3. System Board.</li> </ol>
<b>NMI LED on</b> <b>Note:</b> NMI LED can only be turned off by removing ac power from system, then restoring ac power.	<ol style="list-style-type: none"> <li>1. <b>Reboot the system.</b></li> <li>2. Check the System Error Log.</li> </ol>

<b>Note:</b> The System Error LED will also be on.	
<b>Diagnostic Panel LED</b>	<b>FRU/Action</b>
<b>PCI A LED on</b>	<ol style="list-style-type: none"> <li>1. <b>Check System Error Log for additional information.</b></li> <li>2. PCI card in slot 1. See "System board component locations" on page 42</li> <li>3. Remove all PCI adapters from slots 1-6.</li> <li>4. Replace failing PCI adapter.</li> <li>5. System Board.</li> </ol>
<b>PCI B LED on</b>	<ol style="list-style-type: none"> <li>1. <b>Check System Error Log for additional information.</b></li> <li>2. PCI card in slots 2-4. See "System board component locations" on page 42</li> <li>3. Remove all PCI adapters from slots 1-6.</li> <li>4. Replace failing PCI adapter.</li> <li>5. System Board.</li> </ol>
<b>PCI C LED on</b>	<ol style="list-style-type: none"> <li>1. <b>Check System Error Log for additional information.</b></li> <li>2. PCI card in slots 5-6. See "System board component locations" on page 42</li> <li>3. Remove all PCI adapters from slots 1-6.</li> <li>4. Replace failing PCI adapter.</li> <li>5. System Board.</li> </ol>
<b>PS1 LED on</b>	<ol style="list-style-type: none"> <li>1. <b>Check the DC Good LED on power supply 1. If off, replace power supply 1.</b></li> <li>2. Power Backplane.</li> </ol>
<b>PS2 LED on</b>	<ol style="list-style-type: none"> <li>1. <b>Check the DC Good LED on power supply 2. If off, replace power supply 2.</b></li> <li>2. Power Backplane.</li> </ol>
<b>PS3 LED on</b>	<ol style="list-style-type: none"> <li>1. <b>Check the DC Good LED on power supply 3. If off, replace power supply 3.</b></li> <li>2. Power Backplane.</li> </ol>
<b>SP Bus on</b>	<ol style="list-style-type: none"> <li>1. <b>SP Bus card.</b></li> <li>2. System Board.</li> </ol>
<b>Event Log</b>	Not implemented at this time.
<b>Non Red</b>	<ol style="list-style-type: none"> <li>1. <b>Check PS1, PS2, and PS3 LEDs and take the actions for those indicators.</b></li> <li>2. See "Diagnostic panel error LEDs" on page 101</li> </ol>
<b>TEMP LED on</b>	<ol style="list-style-type: none"> <li>1. <b>Ambient temperature must be within normal operating specifications.</b> See "Features and specifications" on page 3</li> <li>2. Ensure fans are operating correctly.</li> <li>3. Examine System Error Log. <ol style="list-style-type: none"> <li>a. DASD over recommended temperature (DASD LED also on) <ol style="list-style-type: none"> <li>1) Overheating hard drive</li> <li>2) DASD Backplane</li> <li>3) System Board</li> </ol> </li> <li>b. System over recommended temperature for CPU X (where X is CPU 1, 2, 3, or 4) (CPU LED also on) <ol style="list-style-type: none"> <li>1) CPU X</li> </ol> </li> </ol> </li> </ol>



## Diagnostic error codes

**Note:** In the following error codes, if *XXX* is *000*, *195*, or *197* **do not** replace a FRU. The description for these error codes are:

- 000** The test passed.
- 195** The **Esc** key was pressed to abort the test.
- 197** This is a warning error and may not indicate a hardware failure.

For all error codes, replace/follow the FRU/Action indicated.

Error Code/Symptom	FRU/Action
<b>001-XXX-000</b> (Failed core tests)	1. <b>System Board</b>
<b>001-XXX-001</b> (Failed core tests)	1. <b>System Board</b>
<b>001-250-000</b> (Failed System Board ECC)	1. <b>System Board</b>
<b>001-250-001</b> (Failed System Board ECC)	1. <b>System Board</b>
<b>005-XXX-000</b> (Failed Video test)	1. <b>Video Adapter (if installed)</b> 2. System Board
<b>011-XXX-000</b> (Failed COM1 Serial Port test)	1. <b>System Board</b>
<b>011-XXX-001</b> (Failed COM2 Serial Port test)	1. <b>System Board</b>
<b>014-XXX-000</b> (Failed Parallel Port test)	1. <b>System Board</b>
<b>015-XXX-001</b> (Failed USB test)	1. <b>System Board.</b>
<b>015-XXX-015</b> (Failed USB External Loopback test)	1. Make sure parallel port is not disabled. 2. Re-run USB External Loopback test. 3. <b>System board.</b>
<b>015-XXX-198</b> (USB device connected during USB test)	1. Remove USB devices from USB1 and USB2. 2. Re-run test. 3. <b>System Board.</b>
<b>020-XXX-000</b> (Failed PCI Interface test)	1. <b>System Board</b>
<b>020-XXX-001</b> (Failed Hot-Swap Slot 1 PCI Latch test)	1. <b>PCI Hot-Swap Latch Assembly</b> 2. System Board

<b>Error Code/Symptom</b>	<b>FRU/Action</b>
<b>020-XXX-002</b> (Failed Hot-Swap Slot 2 PCI Latch test)	<ol style="list-style-type: none"> <li>1. <b>PCI Hot-Swap Latch Assembly</b></li> <li>2. System Board</li> </ol>
<b>020-XXX-003</b> (Failed Hot-Swap Slot 3 PCI Latch test)	<ol style="list-style-type: none"> <li>1. <b>PCI Hot-Swap Latch Assembly</b></li> <li>2. System Board</li> </ol>
<b>020-XXX-004</b> (Failed Hot-Swap Slot 4 PCI Latch test)	<ol style="list-style-type: none"> <li>1. <b>PCI Hot-Swap Latch Assembly</b></li> <li>2. System Board</li> </ol>
<b>020-XXX-005</b> (Failed Hot-Swap Slot 5 PCI Latch test)	<ol style="list-style-type: none"> <li>1. <b>PCI Hot-Swap Latch Assembly</b></li> <li>2. System Board</li> </ol>
<b>020-XXX-006</b> (Failed Hot-Swap Slot 6 PCI Latch test)	<ol style="list-style-type: none"> <li>1. <b>PCI Hot-Swap Latch Assembly</b></li> <li>2. System Board</li> </ol>
<b>030-XXX-000</b> (Failed Internal SCSI interface test)	<ol style="list-style-type: none"> <li>1. <b>System Board</b></li> </ol>
<b>030-XXX-00N</b> (Failed SCSI test on PCI slot N. Check system error log before replacing a FRU.)	<ol style="list-style-type: none"> <li>1. <b>Adapter in Slot N</b></li> </ol>
<b>035-XXX-099</b>	<ol style="list-style-type: none"> <li>1. <b>No adapters were found.</b></li> <li>2. If adapter is installed re-check connection.</li> </ol>
<b>035-XXX-S99</b> (Failed RAID test on PCI slot S. S = number of failing PCI slot. Check System Error Log before replacing a FRU.)	<ol style="list-style-type: none"> <li>1. <b>Adapter</b></li> <li>2. SCSI Backplane</li> <li>3. Cable</li> </ol>
<b>035-XXX-SNN</b> (Check System Error Log before replacing a FRU. S = number of failing PCI slot; NN = SCSI ID of failing fixed disk.)	<ol style="list-style-type: none"> <li>1. <b>Fixed Disk with SCSI ID NN on RAID adapter in PCI slot S.</b></li> </ol>
<b>035-253-S99</b> (RAID adapter initialization failure)	<ol style="list-style-type: none"> <li>1. <b>ServeRAID Adapter in slot S is not configured properly.</b> Obtain the basic and extended configuration status and refer to the ServeRAID Hardware Maintenance Manual for more information.</li> <li>2. Cable</li> <li>3. SCSI Backplane</li> <li>4. Adapter</li> </ol>
<b>075-XXX-000</b> (Failed Power Supply test)	<ol style="list-style-type: none"> <li>1. <b>Power Supply</b></li> </ol>
<b>089-XXX-001</b> (Failed Microprocessor test)	<ol style="list-style-type: none"> <li>1. <b>Microprocessor</b></li> </ol>
<b>089-XXX-002</b> (Failed Optional Microprocessor test)	<ol style="list-style-type: none"> <li>1. <b>Optional Microprocessor 2</b></li> </ol>
<b>089-XXX-003</b> (Failed Optional Microprocessor test)	<ol style="list-style-type: none"> <li>1. <b>Optional Microprocessor 3</b></li> </ol>

Error Code/Symptom	FRU/Action
<b>089-XXX-004</b> (Failed Optional Microprocessor test)	1. <b>Optional Microprocessor 4</b>
<b>165-060-000</b> (Unable to communicate with Service Processor. It may be busy.)	1. <b>Re-run the Diagnostic test.</b> 2. Troubleshoot all errors in the error logs; then re-run this test. 3. Disconnect all server and external option power cords, wait 30 seconds, reconnect and retry. 4. Replace Advanced System Management processor.
<b>165-198-000</b> (Unable to communicate with Service Processor. It may be busy.)	1. <b>Re-run the Diagnostic test.</b> 2. Troubleshoot all errors in the error logs; then re-run this test. 3. Disconnect all server and external option power cords, wait 30 seconds, reconnect and retry. 4. Replace Advanced System Management processor.
<b>165-201-000</b> (I2C Bus error(s). See System Error/Event Log for details from both SERVPROC and DIAGS messages.)	1. <b>Disconnect all server and external option power cords, wait 30 seconds, reconnect and retry.</b> 2. Reseat Advanced System Management processor. 3. Replace Advanced System Management processor. 4. Replace system board. Before replacing system board, ensure that jumper J5 (the default) is not installed when the error occurs.
<b>165-330-000</b> (Failed Service Processor test)	1. <b>Update to the latest ROM diagnostic level; then re-try.</b>
<b>165-342-000</b> (Advanced System Management BIST indicate failed tests.)	1. <b>Ensure latest firmware levels for ASM and BIOS.</b> 2. Disconnect all server and external option power cords, wait 30 seconds, reconnect and retry. 3. Replace Advanced System Management processor.
<b>180-XXX-000</b> (Diagnostics LED failure)	1. <b>Run Diagnostic LED test for the failing LED.</b>
<b>180-XXX-001</b> (Failed information LED panel test)	1. <b>Information LED Panel</b> 2. Diagnostic LED Panel 3. System Board
<b>180-XXX-002</b> (Failed Diagnostics LED Panel test)	1. <b>Diagnostics LED Panel</b> 2. System Board
<b>180-XXX-003</b> (Failed System Board LED test)	1. <b>System Board</b>
<b>180-XXX-004</b> (Failed Processor LED test)	1. <b>System Board</b>
<b>180-XXX-005</b> (Failed SCSI Backplane LED test)	1. <b>SCSI Backplane</b> 2. SCSI Backplane Cable 3. System Board
<b>180-XXX-006</b> (Memory Board LED test)	1. <b>Memory Board</b> 2. System Board

Error Code/Symptom	FRU/Action
<b>201-XXX-0NN</b> (Failed Memory test, see "Memory Settings" on page 37) NN = DIMM location.	1. <b>DIMM Location J1-J16</b> 2. Memory card
<b>201-XXX-999</b> (Multiple DIMM failure, see error text.)	1. <b>See error text for failing DIMMs</b> 2. Memory card
<b>202-XXX-001</b> (Failed System Cache test)	1. <b>Microprocessor CPU 1</b>
<b>202-XXX-002</b> (Failed System Cache test)	1. <b>Microprocessor CPU 2</b>
<b>202-XXX-003</b> (Failed System Cache test)	1. <b>Microprocessor CPU 3</b>
<b>202-XXX-004</b> (Failed System Cache test)	1. <b>Microprocessor CPU 4</b>
<b>206-XXX-000</b> (Failed Diskette Drive test)	1. <b>Cable</b> 2. Diskette Drive 3. System Board
<b>215-XXX-000</b> (Failed IDE CD-ROM test)	1. <b>CD-ROM Drive Cables</b> 2. CD-ROM Drive 3. System Board
<b>217-XXX-000</b> (Failed BIOS Fixed Disk test) <b>Note:</b> If RAID is configured, the fixed disk number refers to the RAID logical array.	1. <b>Fixed Disk 1</b>
<b>217-XXX-001</b> (Failed BIOS Fixed Disk test) <b>Note:</b> If RAID is configured, the fixed disk number refers to the RAID logical array.	1. <b>Fixed Disk 2</b>
<b>217-XXX-002</b> (Failed BIOS Fixed Disk test) <b>Note:</b> If RAID is configured, the fixed disk number refers to the RAID logical array.	1. <b>Fixed Disk 3</b>
<b>217-XXX-003</b> (Failed BIOS Fixed Disk test) <b>Note:</b> If RAID is configured, the fixed disk number refers to the RAID logical array.	1. <b>Fixed Disk 4</b>

Error Code/Symptom	FRU/Action
<p><b>217-XXX-004</b></p> <p>(Failed BIOS Fixed Disk test)  <b>Note:</b> If RAID is configured, the fixed disk number refers to the RAID logical array.</p>	<p>1. <b>Fixed Disk 5</b></p>
<p><b>217-XXX-005</b></p> <p>(Failed BIOS Fixed Disk test)  <b>Note:</b> If RAID is configured, the fixed disk number refers to the RAID logical array.</p>	<p>1. <b>Fixed Disk 6</b></p>
<p><b>264-XXX-0NN</b></p> <p>(NN = SCSI ID of failing Tape Drive)</p>	<p>1. <b>Tape Cartridge, if user executed the Read/Write Tape Drive test (XXX = 256)</b></p> <p>2. SCSI or power cable connected to the tape drive with SCSI ID NN</p> <p>3. Tape drive with SCSI ID NN – refer to Help and Service Information appendix of tape drive's User Guide.</p> <p>4. System Board or SCSI Controller – run SCSI Controller diagnostic to determine of SCSI bus is functioning properly.</p>
<p><b>264-XXX-999</b></p> <p>(Errors on multiple tape drives, see error text for more info)</p>	<p>1. <b>See error messages/text in the PC Doctor error log for detailed information on each individual tape drive error.</b></p>
<p><b>301-XXX-000</b></p> <p>(Failed Keyboard test)</p>	<p>1. <b>Keyboard</b></p>
<p><b>405-XXX-000</b></p> <p>(Failed Ethernet test on controller on the System Board)</p>	<p>1. <b>Verify that Ethernet is not disabled in BIOS.</b></p> <p>2. System Board</p>
<p><b>405-XXX-00N</b></p> <p>(Failed Ethernet test on adapter in PCI slot N)</p>	<p>1. <b>Adapter in PCI slot N.</b></p> <p>2. System Board</p>
<p><b>415-XXX-000</b></p> <p>(Failed Modem test)</p>	<p>1. <b>Cable</b></p> <p>2. Modem</p> <p>3. System Board</p>

## Error symptoms

General	FRU/Action
CD is not working properly.	<ol style="list-style-type: none"> <li>1. <b>Clean the CD.</b></li> <li>2. Run CD-ROM diagnostics.</li> <li>3. CD-ROM Drive</li> </ol>
CD-ROM drive tray is not working. (The server must be powered-on.)	<ol style="list-style-type: none"> <li>1. <b>Insert the end of a paper clip into the manual tray-release opening.</b></li> <li>2. Run CD-ROM diagnostics.</li> <li>3. CD-ROM Drive</li> </ol>
CD-ROM drive is not recognized.	<ol style="list-style-type: none"> <li>1. <b>Run Configuration/Setup, enable primary IDE channel.</b></li> <li>2. Check cables and jumpers.</li> <li>3. Check for correct device driver.</li> <li>4. Run CD-ROM diagnostics.</li> <li>5. CD-ROM drive</li> <li>6. System Board</li> </ol>
Power switch does not work and reset button does work.	<ol style="list-style-type: none"> <li>1. <b>Verify that the power-on control jumper on J19 is on pins 1 and 2.</b></li> <li>2. Power Switch Assembly</li> <li>3. System Board</li> </ol>
Front panel is not plugged in.	<ol style="list-style-type: none"> <li>1. Make sure front panel is plugged in.</li> </ol>
On/Off Reset panel is not plugged in.	<ol style="list-style-type: none"> <li>1. Make sure On/Off Reset panel is plugged in.</li> </ol>
CD-ROM drive cable is not plugged in.	<ol style="list-style-type: none"> <li>1. Make sure CD-ROM drive cable is plugged in.</li> </ol>
Diskette drive in-use light stays on, or the system bypasses the diskette drive, or the diskette drive does not work.	<ol style="list-style-type: none"> <li>1. <b>If there is a diskette in the drive, verify that:</b> <ol style="list-style-type: none"> <li>a. The diskette drive is enabled in the Configuration/Setup utility program.</li> <li>b. The diskette is good and not damaged. (Try another diskette if you have one.)</li> <li>c. The diskette is inserted correctly in the drive.</li> <li>d. The diskette contains the necessary files to start the server.</li> <li>e. The software program is OK.</li> <li>f. Cable is installed correctly (proper orientation)</li> </ol> </li> <li>2. Run Diskette Drive Diagnostics.</li> <li>3. Cable</li> <li>4. Diskette Drive</li> <li>5. System Board</li> </ol>
<b>Monitor problems (general).</b>  Some IBM monitors have their own self-tests. If you suspect a problem with the monitor, refer to the information that comes with the monitor for adjusting and testing instructions.	<ol style="list-style-type: none"> <li>1. <b>Monitor</b></li> <li>2. Run Video Diagnostics. If diagnostics pass, the problem may be a video driver.</li> <li>3. Display Adapter / System Board</li> </ol>

Setup	Action
<i>Setup and Installation CD</i> won't start.	<ul style="list-style-type: none"> <li>• Be sure the server is supported; all @servers with a startable (bootable) CD-ROM drive are supported.</li> <li>• If the startup (boot) sequence settings have been altered, be sure the CD-ROM is first in the boot sequence.</li> <li>• If more than one CD-ROM drive is installed, be sure that only one drive is set as the primary drive. Start the CD from the primary drive.</li> </ul>
ServeRAID program cannot view all installed drives - or - cannot install NOS.	<ul style="list-style-type: none"> <li>• Be sure there are no duplicate SCSI IDs or IRQ assignments.</li> <li>• Be sure that the hard disk drive is connected properly.</li> </ul>
The <i>Operating System Installation</i> program continuously loops.	Free up more space on the hard disk.
ServerGuide won't start <i>your</i> NOS CD.	Be sure the NOS CD you have is supported by ServerGuide. See the <i>Setup and Installation CD</i> label for a list of NOS versions supported.
Can't install NOS - option is grayed out.	Either there is no logical drive defined (ServeRAID systems) or the ServerGuide system partition is not present. Run the setup and configuration program.

Setup	Action
<i>Setup and Installation CD</i> won't start.	<ul style="list-style-type: none"> <li>• Be sure the server is supported; all @servers with a startable (bootable) CD-ROM drive are supported.</li> <li>• If the startup (boot) sequence settings have been altered, be sure the CD-ROM is first in the boot sequence.</li> <li>• If more than one CD-ROM drive is installed, be sure that only one drive is set as the primary drive. Start the CD from the primary drive.</li> </ul>
ServeRAID program cannot view all installed drives - or - cannot install NOS.	<ul style="list-style-type: none"> <li>• Be sure there are no duplicate SCSI IDs or IRQ assignments.</li> <li>• Be sure that the hard disk drive is connected properly.</li> </ul>
The <i>Operating System Installation</i> program continuously loops.	Free up more space on the hard disk.
ServerGuide won't start <i>your</i> NOS CD.	Be sure the NOS CD you have is supported by ServerGuide. See the <i>Setup and Installation CD</i> label for a list of NOS versions supported.
Can't install NOS - option is grayed out.	Either there is no logical drive defined (ServeRAID systems) or the ServerGuide system partition is not present. Run the setup and configuration program.

TechConnect CD	Action
Can't start TechConnect CD.	Be sure you're starting the CD on a system with Microsoft Windows installed.
Can't view publications from TechConnect CD, or text is unreadable.	Be sure you have the Adobe reader installed (available from the TechConnect CD).

Diskette Factory CD	Action
Get "time out" or "Unknown host" errors	Be sure you have access to the Internet through FTP directly.

## Power supply LED errors

Use the power supply LED information on the following page to troubleshoot power supply problems.

**Note:** The minimum configuration required for the DC Good light to come on is:

- Power Supply
- Power Backplane
- System Board (With pins 2 and 3 on J19 connected together to bypass the power switch; see "System board component locations" on page 42)

AC Good LED	DC Good LED	Description	FRU/Action
Off	Off	No power to system or ac problem.	<ol style="list-style-type: none"> <li>1. <b>Check ac power to system.</b></li> <li>2. Power Supply</li> </ol>
On	Off	Standby mode or dc problem.	<ol style="list-style-type: none"> <li>1. Move jumper on J19 to pins 2-3 to bypass power control. If the DC Good LED comes on, press Ctrl+Alt+Delete. Watch the screen for any POST errors. Check the System Error Log for any listed problems. If the system powers up with no errors:               <ol style="list-style-type: none"> <li>a. Diagnostic LED panel</li> </ol> </li> <li>2. Remove the adapters and disconnect the cables and power connectors to all internal and external devices. Power-on the system. If the DC Good LED comes on, replace the adapters and devices one at a time until you isolate the problem.</li> <li>3. Power Supply</li> <li>4. Power Backplane</li> <li>5. System Board</li> </ol>
On	On	Power is OK.	N/A

## POST error codes

In the following error codes, X can be any number or letter.

Error Code/Symptom	FRU/Action
<b>062</b> (Three consecutive boot failures using the default configuration.)	<ol style="list-style-type: none"> <li>1. <b>Run Configuration/Setup</b></li> <li>2. Battery</li> <li>3. System Board</li> <li>4. Processor</li> </ol>
<b>101, 102, 106</b> (System and processor error)	<ol style="list-style-type: none"> <li>1. <b>System Board</b></li> </ol>
<b>111</b> (Channel check error)	<ol style="list-style-type: none"> <li>1. <b>Failing adapter</b></li> <li>2. DIMM</li> <li>3. System board</li> </ol>
<b>114</b> (Adapter read-only memory error)	<ol style="list-style-type: none"> <li>1. <b>Failing adapter</b></li> <li>2. Run diagnostics</li> </ol>



<b>Error Code/Symptom</b>	<b>FRU/Action</b>
<b>129</b> (Internal cache error)	<ol style="list-style-type: none"> <li>1. <b>Processor</b></li> <li>2. Optional processor (if installed)</li> </ol>
<b>151</b> (Real time clock error)	<ol style="list-style-type: none"> <li>1. <b>Run Diagnostics</b></li> <li>2. Battery</li> <li>3. System Board</li> </ol>
<b>161</b> (Real time clock battery error)	<ol style="list-style-type: none"> <li>1. <b>Run Configuration/Setup</b></li> <li>2. Battery</li> <li>3. System Board</li> </ol>
<b>162</b> (Device Configuration Error) <b>Note:</b> Be sure to load the default settings and any additional desired settings; then, <b>save the configuration.</b>	<ol style="list-style-type: none"> <li>1. <b>Run Configuration/Setup</b></li> <li>2. Battery</li> <li>3. Failing Device</li> <li>4. System Board</li> </ol>
<b>163</b> (Real-Time Clock error)	<ol style="list-style-type: none"> <li>1. <b>Run Configuration/Setup</b></li> <li>2. Battery</li> <li>3. System Board</li> </ol>
<b>164</b> (Memory configuration changed, see "Memory Settings" on page 37)	<ol style="list-style-type: none"> <li>1. <b>Run Configuration/Setup</b></li> <li>2. DIMM</li> <li>3. Memory Card</li> <li>4. System Board</li> </ol>
<b>175</b> (Hardware error)	<ol style="list-style-type: none"> <li>1. <b>System Board</b></li> </ol>
<b>176, 177, 178</b> (Security hardware error)	<ol style="list-style-type: none"> <li>1. <b>Run Configuration/Setup</b></li> <li>2. System Board</li> </ol>
<b>184</b> (Power-on password corrupted)	<ol style="list-style-type: none"> <li>1. <b>Run Configuration/Setup</b></li> <li>2. System Board</li> </ol>
<b>185</b> (Drive startup sequence information corrupted)	<ol style="list-style-type: none"> <li>1. <b>Run Configuration/Setup</b></li> <li>2. System Board</li> </ol>
<b>186</b> (Security hardware control logic failed)	<ol style="list-style-type: none"> <li>1. <b>Run Configuration/Setup</b></li> <li>2. System Board</li> </ol>
<b>187</b> (VPD serial number not set.)	<ol style="list-style-type: none"> <li>1. <b>Set serial number in Setup</b></li> <li>2. System Board</li> </ol>
<b>188</b> (Bad EEPROM CRC #2)	<ol style="list-style-type: none"> <li>1. <b>Run Configuration/Setup</b></li> <li>2. System Board</li> </ol>
<b>189</b> (Three attempts were made to access the server with invalid passwords)	<ol style="list-style-type: none"> <li>1. <b>Run Configuration/Setup, enter the administrator password</b></li> <li>2. System Board.</li> </ol>

Error Code/Symptom	FRU/Action
<b>201</b> (Memory test error, see "Memory Settings" on page 37) If the server does not have the latest level of BIOS installed, update the BIOS to the latest level and run the diagnostic program again.	1. Run memory diagnostics. 2. DIMM 3. Memory card 4. System Board
<b>229</b> (Cache error)	1. <b>Processor</b> 2. Optional Processor (if installed)
<b>289</b> (DIMM has been disabled by user or system, see "Memory Settings" on page 37)	1. <b>Run Configuration/Setup</b> 2. Disabled DIMM
<b>301</b> (Keyboard or keyboard controller error)	1. <b>Keyboard</b> 2. System Board
<b>303</b> (Keyboard controller error)	1. <b>System Board</b> 2. Keyboard
<b>602</b> (Invalid diskette boot record)	1. <b>Diskette</b> 2. Diskette Drive 3. Cable 4. System Board
<b>604</b> (Diskette drive error)	1. <b>Run Configuration/Setup and Diagnostics</b> 2. Diskette Drive 3. Drive Cable 4. System Board
<b>662</b> (Diskette drive configuration error)	1. <b>Run Configuration/Setup and Diagnostics</b> 2. Diskette Drive 3. Drive Cable 4. System Board
<b>962</b> (Parallel port error)	1. <b>Disconnect external cable on parallel port.</b> 2. Run Configuration/Setup 3. System Board
<b>11XX</b> (System board serial port 1 or 2 error)	1. <b>Disconnect external cable on serial port.</b> 2. Run Configuration/Setup 3. System Board
<b>1162</b> (Serial port configuration conflict)	1. <b>Disconnect external cable on serial port</b> 2. Run Configuration/Setup 3. System board
<b>1200</b> (processor machine check)	1. Processor

Error Code/Symptom	FRU/Action
<b>1301</b> (cable to front panel not found)	<ol style="list-style-type: none"> <li>1. <b>Cable</b></li> <li>2. Front Panel</li> <li>3. Power Switch Assembly</li> <li>4. System Board</li> </ol>
<b>1302</b> (cable from system board to power on and reset switches not found)	<ol style="list-style-type: none"> <li>1. <b>Cable</b></li> <li>2. Power Switch Assembly</li> <li>3. System Board</li> </ol>
<b>1303</b> (cable from system board to power backplane not found)	<ol style="list-style-type: none"> <li>1. <b>Cable</b></li> <li>2. Power Backplane</li> <li>3. System Board</li> </ol>
<b>1304</b> (cable to diagnostic LED board not found)	<ol style="list-style-type: none"> <li>1. <b>Cable</b></li> <li>2. Diagnostic LED Board</li> <li>3. System Board</li> </ol>
<b>1600</b> (Advanced System Management processor is not functioning) Do the following before replacing a FRU: <ol style="list-style-type: none"> <li>1. Ensure that a jumper is not installed on J5.</li> <li>2. Remove the ac power to the system, wait 20 seconds; then, re-connect the ac power. Wait 30 seconds; then, power-on the system.</li> </ol>	<ol style="list-style-type: none"> <li>1. <b>System Board</b></li> <li>2. Service Processor Board</li> </ol>
<b>1601</b> (The system is able to communicate to the Service Processor, but the Service Processor failed to respond at the start of POST.)  Do the following before replacing a FRU: <ol style="list-style-type: none"> <li>1. Remove the ac power to the system, wait 20 seconds; then, re-connect the ac power. Wait 30 seconds; then, power-on the system.</li> <li>2. Flash update the Service Processor.</li> </ol>	<ol style="list-style-type: none"> <li>1. <b>System Board</b></li> <li>2. Service Processor Board</li> </ol>
<b>1800</b> (No more hardware interrupt available for PCI adapter)	<ol style="list-style-type: none"> <li>1. Run Configuration/Setup</li> <li>2. Failing Adapter</li> <li>3. System Board</li> </ol>
<b>1962</b> (Drive does not contain a valid boot sector)	<ol style="list-style-type: none"> <li>1. <b>Verify a bootable operating system is installed.</b></li> <li>2. If RAID system, refer to the Hardware Maintenance Manual for the specific RAID adapter.</li> <li>3. Run Diagnostics</li> <li>4. Hard Disk Drive</li> <li>5. Cable</li> <li>6. SCSI Backplane</li> <li>7. System Board</li> </ol>

<b>Error Code/Symptom</b>	<b>FRU/Action</b>
<b>2400</b> (Video controller test failure)	<ol style="list-style-type: none"> <li>1. <b>Video Adapter (if installed)</b></li> <li>2. System Board</li> </ol>
<b>2462</b> (Video memory configuration error)	<ol style="list-style-type: none"> <li>1. <b>Video Adapter (if installed)</b></li> <li>2. System Board</li> </ol>
<b>5962</b> (IDE CD-ROM configuration error)	<ol style="list-style-type: none"> <li>1. <b>Run Configuration/Setup</b></li> <li>2. CD-ROM Drive</li> <li>3. CD-ROM Power Cable</li> <li>4. IDE Cable</li> <li>5. System Board</li> <li>6. Battery</li> </ol>
<b>8603</b> (Pointing Device Error)	<ol style="list-style-type: none"> <li>1. <b>Pointing Device</b></li> <li>2. System Board</li> </ol>
<b>00012000</b> (Processor machine check)	<ol style="list-style-type: none"> <li>1. <b>Update BIOS</b></li> <li>2. Replace microprocessor</li> </ol>
<b>00019501</b> (Processor 1 is not functioning)	<ol style="list-style-type: none"> <li>1. <b>Processor 1</b></li> <li>2. System Board</li> </ol>
<b>00019502</b> (Processor 2 is not functioning)	<ol style="list-style-type: none"> <li>1. <b>Processor 2</b></li> <li>2. System Board</li> </ol>
<b>00019503</b> (Processor 3 is not functioning)	<ol style="list-style-type: none"> <li>1. <b>Processor 3</b></li> <li>2. System Board</li> </ol>
<b>00019504</b> (Processor 4 is not functioning)	<ol style="list-style-type: none"> <li>1. <b>Processor 4</b></li> <li>2. System Board</li> </ol>
<b>00019701</b> (Processor 1 failed BIST)	<ol style="list-style-type: none"> <li>1. <b>Processor 1</b></li> <li>2. System Board</li> </ol>
<b>00019702</b> (Processor 2 failed BIST)	<ol style="list-style-type: none"> <li>1. <b>Processor 2</b></li> <li>2. System Board</li> <li>3. System Board</li> </ol>
<b>00019703</b> (Processor 3 failed BIST)	<ol style="list-style-type: none"> <li>1. <b>Processor 3</b></li> <li>2. System Board</li> </ol>
<b>00019704</b> (Processor 4 failed BIST)	<ol style="list-style-type: none"> <li>1. <b>Processor 4</b></li> <li>2. System Board</li> </ol>
<b>00180100</b> (No room for PCI option ROM)	<ol style="list-style-type: none"> <li>1. <b>Run Configuration/Setup</b></li> <li>2. Failing Adapter</li> <li>3. System Board</li> </ol>
<b>00180200</b> (No more I/O space available for PCI adapter)	<ol style="list-style-type: none"> <li>1. <b>Run Configuration/Setup</b></li> <li>2. Failing Adapter</li> <li>3. System Board</li> </ol>

Error Code/Symptom	FRU/Action
<b>00180300</b> (No more memory (above 1MB for PCI adapter))	<ol style="list-style-type: none"> <li>1. <b>Run Configuration/Setup</b></li> <li>2. Failing Adapter</li> <li>3. System Board</li> </ol>
<b>00180400</b> (No more memory (below 1MB for PCI adapter))	<ol style="list-style-type: none"> <li>1. <b>Run Configuration/Setup</b></li> <li>2. Failing Adapter</li> <li>3. System Board</li> </ol>
<b>00180500</b> (PCI option ROM checksum error)	<ol style="list-style-type: none"> <li>1. <b>Remove Failing PCI Card</b></li> <li>2. System Board</li> </ol>
<b>00180600</b> (PCI device built-in self test failure)	<ol style="list-style-type: none"> <li>1. <b>Run Configuration/Setup</b></li> <li>2. Failing Adapter</li> <li>3. System Board</li> </ol>
<b>00180700</b> (xxxxyyy planar PCI device not responding (where xxxx is PCI vendor ID and yyyy is PCI device ID))	<ol style="list-style-type: none"> <li>1. System Board</li> <li>2. PCI Card</li> </ol>
<b>00180800</b> (Unsupported PCI device installed)	<ol style="list-style-type: none"> <li>1. System Board</li> <li>2. PCI Card</li> </ol>
<b>00181000</b> (PCI error)	<ol style="list-style-type: none"> <li>1. System Board</li> <li>2. PCI Card</li> </ol>
<b>01295085</b> (ECC checking hardware test error)	<ol style="list-style-type: none"> <li>1. <b>System Board</b></li> <li>2. Processor</li> </ol>
<b>01298001</b> (No update data for processor 1)	<ol style="list-style-type: none"> <li>1. <b>Ensure all processors are the same stepping level and cache size.</b></li> <li>2. Processor 1</li> </ol>
<b>01298002</b> (No update data for processor 2)	<ol style="list-style-type: none"> <li>1. <b>Ensure all processors are the same stepping level and cache size.</b></li> <li>2. Processor 2</li> </ol>
<b>01298003</b> (No update data for processor 3)	<ol style="list-style-type: none"> <li>1. <b>Ensure all processors are the same stepping level and cache size.</b></li> <li>2. Processor 3</li> </ol>
<b>01298004</b> (No update data for processor 4)	<ol style="list-style-type: none"> <li>1. <b>Ensure all processors are the same stepping level and cache size.</b></li> <li>2. Processor 4</li> </ol>
<b>01298101</b> (Bad update data for processor 1)	<ol style="list-style-type: none"> <li>1. <b>Ensure all processors are the same stepping level and cache size.</b></li> <li>2. Processor 1</li> </ol>
<b>01298102</b> (Bad update data for processor 2)	<ol style="list-style-type: none"> <li>1. <b>Ensure all processors are the same stepping level and cache size.</b></li> <li>2. Processor 2</li> </ol>
<b>01298103</b> (Bad update data for processor 3)	<ol style="list-style-type: none"> <li>1. <b>Ensure all processors are the same stepping level and cache size.</b></li> <li>2. Processor 3</li> </ol>

Error Code/Symptom	FRU/Action
<b>01298104</b> (Bad update data for processor 4)	<ol style="list-style-type: none"> <li>1. <b>Ensure all processors are the same stepping level and cache size.</b></li> <li>2. Processor 4</li> </ol>
<b>01298200</b> (Microprocessor speed mismatch)	<ol style="list-style-type: none"> <li>1. Ensure all processors are the same speed.</li> </ol>
<b>I9990301</b> (Fixed boot sector error)	<ol style="list-style-type: none"> <li>1. <b>Hard Disk Drive</b></li> <li>2. If RAID system, refer to the Hardware Maintenance Manual for the specific RAID adapter.</li> <li>3. SCSI Backplane</li> <li>4. Cable</li> <li>5. System Board</li> </ol>
<b>I9990305</b> (Fixed boot sector error, no operating system installed)	<ol style="list-style-type: none"> <li>1. <b>Install operating system to hard disk drive.</b></li> </ol>
<b>I9990650</b> (AC power has been restored)	<ol style="list-style-type: none"> <li>1. <b>Check cable</b></li> <li>2. Check for interruption of power supply</li> <li>3. Power Cable</li> </ol>
Other numbers	Follow instructions on screen.

---

## ServeRAID

For ServeRAID error codes and procedures, refer to the Hardware Maintenance Manual for the particular RAID adapter in the system being serviced.

## I2C bus fault messages

The System Event/Error Log may contain I2C bus fault messages from both the Service Processor Diagnostic and the Advanced System Management processor, indicated by the source DIAGS and SERVPROC, respectively. The format of the DIAGS messages from the revision ARY115 and later are formatted as either

I2C Bus x bad or devices on this bus are functioning incorrectly.

or

I2C Busses x, y, ... , z bad or devices on these busses are functioning incorrectly.

where the numbers listed x, y, ..., z represent any of the busses that are experiencing a fault. The table below provides the appropriate actions to take for each bus number listed.

Message	Action
Failure reading I2C device. Check devices on bus 0.	<ol style="list-style-type: none"> <li>1. Reseat Service Processor Board</li> <li>2. Replace Service Processor Board</li> <li>3. Replace System Board</li> </ol>
Failure reading I2C device. Check devices on bus 1.	<ol style="list-style-type: none"> <li>1. Reseat power supplies</li> <li>2. Replace power supplies</li> <li>3. Replace power backplane</li> <li>4. Replace System Board</li> </ol>
Failure reading I2C device. Check devices on bus 2.	<ol style="list-style-type: none"> <li>1. Reseat front panel connectors</li> <li>2. Replace front panel</li> <li>3. Replace System Board</li> </ol>
Failure reading I2C device. Check devices on bus 3.	<ol style="list-style-type: none"> <li>1. Replace System Board</li> </ol>
Failure reading I2C device. Check devices on bus 4.	<ol style="list-style-type: none"> <li>1. Reseat Service Processor Board</li> <li>2. Replace Service Processor Board</li> <li>3. Replace System Board</li> </ol>
Failure reading I2C device. Check devices on bus 5.	<ol style="list-style-type: none"> <li>1. Reseat CPUs</li> <li>2. Replace CPUs</li> <li>3. Replace System Board</li> </ol>
Failure reading I2C device. Check devices on bus 6.	<ol style="list-style-type: none"> <li>1. Reseat memory card</li> <li>2. Replace memory card</li> <li>3. Replace System Board</li> </ol>
Failure reading I2C device. Check devices on bus 7.	<ol style="list-style-type: none"> <li>1. Replace System Board</li> </ol>
Failure reading I2C device. Check devices on bus 8.	<ol style="list-style-type: none"> <li>1. Replace SCSI backplane</li> <li>2. Replace power backplane</li> <li>3. Replace System Board</li> </ol>
Failure reading I2C device. Check devices on bus 9.	<ol style="list-style-type: none"> <li>1. Reseat DIMMs 1, 2, 3, and 4</li> <li>2. Replace DIMMs 1, 2, 3, and 4</li> <li>3. Replace memory card</li> <li>4. Replace System Board</li> </ol>

Message	Action
Failure reading I2C device. Check devices on bus 9.	<ol style="list-style-type: none"> <li>1. Reseat DIMMs 5, 6, 7, and 8</li> <li>2. Replace DIMMs 5, 6, 7, and 8</li> <li>3. Replace memory card</li> <li>4. Replace System Board</li> </ol>
Failure reading I2C device. Check devices on bus 9.	<ol style="list-style-type: none"> <li>1. Reseat DIMMs 9, 10, 11, and 12</li> <li>2. Replace DIMMs 9, 10, 11, and 12</li> <li>3. Replace memory card</li> <li>4. Replace System Board</li> </ol>
Failure reading I2C device. Check devices on bus 9.	<ol style="list-style-type: none"> <li>1. Reseat DIMMs 13, 14, 15, and 16</li> <li>2. Replace DIMMs 13, 14, 15, and 16</li> <li>3. Replace memory card</li> <li>4. Replace System Board</li> </ol>

## SCSI error codes

Error Code	FRU/Action
<p><b>All SCSI Errors</b></p> <p>One or more of the following might be causing the problem:</p> <ul style="list-style-type: none"> <li>• A failing SCSI device (adapter, drive, controller)</li> <li>• An improper SCSI configuration or SCSI termination jumper setting</li> <li>• Duplicate SCSI IDs in the same SCSI chain</li> <li>• A missing or improperly installed SCSI terminator</li> <li>• A defective SCSI terminator</li> <li>• An improperly installed cable</li> <li>• A defective cable</li> </ul>	<ol style="list-style-type: none"> <li>1. <b>External SCSI devices must be powered-on before you power-on the server.</b></li> <li>2. The cables for all external SCSI devices are connected correctly.</li> <li>3. If you have attached an external SCSI device to the server, make sure the external SCSI termination is set to automatic.</li> <li>4. The last device in each SCSI chain is terminated correctly.</li> <li>5. The SCSI devices are configured correctly.</li> </ol>

## Temperature error messages

Message	Action
<p><b>DASD "X" Over Temperature</b></p> <p>(level-critical; Direct Access Storage Device bay "X" was over temperature)</p>	<ol style="list-style-type: none"> <li>1. <b>Ensure system is being properly cooled;</b> see "Temperature checkout" on page 23</li> </ol>
<p><b>DASD Over recommended Temperature</b></p> <p>(sensor X) (level-warning; the DASD backplane had an over temperature condition)</p>	<ol style="list-style-type: none"> <li>1. <b>Ensure system is being properly cooled;</b> see "Temperature checkout" on page 23</li> </ol>
<p><b>DASD under recommended temperature</b></p> <p>(sensor X) (level-warning; the DASD backplane had an under temperature condition)</p>	<ol style="list-style-type: none"> <li>1. <b>Ambient temperature must be within normal operating specifications;</b> (see "Features and specifications" on page 3).</li> </ol>
<p><b>CPU "X" over recommended temperature</b></p> <p>(level-critical; temperature of CPU "X" reached critical level)</p>	<ol style="list-style-type: none"> <li>1. <b>Ensure system is being properly cooled;</b> see "Temperature checkout" on page 23</li> <li>2. Replace CPU "X".</li> </ol>



Message	Action
<b>Power Supply "X" Temperature Fault</b> (level-critical; power supply "x" had over temperature condition)	<ol style="list-style-type: none"> <li>1. <b>Ensure system is being properly cooled;</b> see "Temperature checkout" on page 23</li> <li>2. Replace Power Supply "X"</li> </ol>
<b>System over temperature for CPU "X"</b> (level-warning; CPU "X" reporting over temperature condition)	<ol style="list-style-type: none"> <li>1. <b>Ensure system is being properly cooled;</b> see "Temperature checkout" on page 23</li> <li>2. Replace system board.</li> </ol>
<b>System under recommended CPU "X" temperature</b> (level-warning; system reporting under temperature condition for CPU "X")	<ol style="list-style-type: none"> <li>1. <b>Ambient temperature must be within normal operating specifications;</b> (see "Features and specifications" on page 3).</li> </ol>
<b>System over recommended ambient temperature</b> (level-warning; ambient temperature too warm for safe system operation)	<ol style="list-style-type: none"> <li>1. <b>Ambient temperature must be within normal operating specifications;</b> (see "Features and specifications" on page 3).</li> </ol>

---

## Fan error messages

Message	Action
<b>Fan "X" fault</b> (level-critical; fan "X" beyond recommended RPM range)	<ol style="list-style-type: none"> <li>1. <b>Check connections to fan "X"</b></li> <li>2. Replace fan "X"</li> </ol>

---

## Power error messages

Message	Action
<b>Power supply "X" DC good fault</b> (level-critical; power good signal not detected for power supply "X")	<ol style="list-style-type: none"> <li>1. <b>Replace power supply "X"</b></li> </ol>
<b>Power supply "X" fan fault</b> (level-critical; fan fault in power supply "X")	<ol style="list-style-type: none"> <li>1. <b>Replace power supply "X"</b></li> </ol>
<b>Power supply "X" fault</b> (level-critical; overcurrent condition exists)	<ol style="list-style-type: none"> <li>1. <b>See "Power checkout" on page 20</b></li> </ol>
<b>Power supply "X" 12V fault</b> (level-critical; overcurrent condition detected)	<ol style="list-style-type: none"> <li>1. <b>See "Power checkout" on page 20</b></li> </ol>
<b>Power supply "X" 3.3V fault</b> (level-critical; 3.3V power supply "X" had an error)	<ol style="list-style-type: none"> <li>1. <b>See "Power checkout" on page 20</b></li> </ol>
<b>Power supply "X" 5V fault</b> (level-critical; 5V power supply "X" had an error)	<ol style="list-style-type: none"> <li>1. <b>See "Power checkout" on page 20</b></li> </ol>
<b>Power supply current exceeded max spec value</b> (level-critical; current draw in system is over allowance for a single supply)	<ol style="list-style-type: none"> <li>1. <b>See "Power checkout" on page 20</b></li> </ol>

Message	Action
<b>Power Supply "X" fault</b> (level-critical; power supply "X" has been removed or has encountered some other fault)	<ol style="list-style-type: none"> <li>1. <b>Check error log for other messages.</b></li> <li>2. See "Power checkout" on page 20</li> </ol>
<b>Power Supply "X" overvoltage fault</b> (level-critical)	<ol style="list-style-type: none"> <li>1. <b>See "Power checkout" on page 20.</b></li> </ol>
<b>Power Supply "X" AC power removed, early power-off warning</b> (level-critical; a power supply has been unplugged or has been installed without an ac cord)	<ol style="list-style-type: none"> <li>1. <b>Check to see if ac cords are plugged in properly.</b></li> <li>2. Problem may have been temporary ac problem. If problem persists, see "Power checkout" on page 20</li> </ol>
<b>System running non-redundant power</b> (level-non-critical; system does not have redundant power)	<ol style="list-style-type: none"> <li>1. <b>Add another power supply</b></li> <li>2. Remove options from system</li> <li>3. System can continue to operate without redundancy protection if <b>1</b> and <b>2</b> above are not followed.</li> </ol>
<b>System under recommended voltage for "X" v</b> (level-warning; indicated voltage supply under nominal value; value for "X" can be +12, -12, or +5)	<ol style="list-style-type: none"> <li>1. <b>Check connections to power subsystem</b></li> <li>2. Replace power supply</li> <li>3. Replace power backplane</li> </ol>
<b>System under recommended voltage on 3.3 v</b> (level-warning; 3.3 volt supply under nominal value)	<ol style="list-style-type: none"> <li>1. <b>Check connections to power subsystem</b></li> <li>2. Replace power supply</li> <li>3. Replace power backplane</li> </ol>
<b>"X" V bus fault</b> (level-critical; overcurrent condition on "X" voltage bus)	<ol style="list-style-type: none"> <li>1. <b>See "Power checkout" on page 20.</b></li> </ol>
<b>12V "X" bus fault</b> (level-critical; overcurrent condition on 12 volt "X" voltage bus)	<ol style="list-style-type: none"> <li>1. <b>See "Power checkout" on page 20.</b></li> </ol>
<b>5V fault</b> (level-critical; overcurrent condition on 5 V subsystem)	<ol style="list-style-type: none"> <li>1. <b>See "Power checkout" on page 20.</b></li> </ol>

## System shutdown

Refer to the following tables when experiencing system shutdown related to voltage or temperature problems.

### Voltage related system shutdown

Message	Action
<b>System shutoff due to "X" V over voltage</b> (level-critical; system shutoff due to "X" supply over voltage)	<ol style="list-style-type: none"> <li>1. <b>Check power supply connectors</b></li> <li>2. Replace power supply</li> <li>3. Replace power backplane</li> </ol>
<b>System shutoff due to "X" V under voltage</b> (level-critical system shutoff due to "X" supply under voltage)	<ol style="list-style-type: none"> <li>1. <b>Check power supply connectors</b></li> <li>2. Replace power supply</li> <li>3. Replace power backplane</li> </ol>

## Temperature related system shutdown

Message	Action
<b>System shutoff due to CPU "X" over temperature</b> (level-critical; CPU "X" is over temperature)	1. <b>Ensure system is being properly cooled</b> , see "Temperature checkout" on page 23 2. Replace CPU "X"
<b>System shutoff due to CPU "X" under temperature</b> (level-critical; CPU "X" is under temperature)	1. <b>Ambient temperature must be within normal operating specifications</b> (see "Features and specifications" on page 3) 2.
<b>System shutoff due to DASD temperature (sensor X)</b> (level-critical; DASD area reported temperature outside recommended operating range)	1. <b>Ensure system is being properly cooled</b> , see "Temperature checkout" on page 23
<b>System shutoff due to high ambient temperature</b> (level-critical; high ambient temperature)	1. <b>Ambient temperature must be within normal operating specifications</b> (see "Features and specifications" on page 3)
<b>System shutoff due to faults on each supply</b> (level-critical; each installed power supply encountered a fault condition)	1. See "Power checkout" on page 20.

---

## DASD checkout

Message	Action
<b>Hard drive "X" removal detected</b> (level-critical; hard drive "X" has been removed)	1. <b>Information only, take action as appropriate.</b>
<b>Hard Drive (SCSI ID "X") fault</b> (level-critical; error has occurred on a DASD drive in a RAID configuration causing it to be defunct)	1. <b>Ambient temperature must be within normal operating specifications</b> (see "Features and specifications" on page 3)

---

## CPU checkout

Message	Action
<b>Host BIST fail</b> (level-informational; host's built-in self test failed)	1. <b>Reseat CPU</b> 2. Replace CPU
<b>Internal Error CPU "X" fault</b> (level-critical; specified processor reported internal error and is held offline and system restarted)	1. <b>If problem persists, replace CPU "X".</b>

---

## Undetermined problems

You are here because the diagnostic tests did not identify the failure, the Devices List is incorrect, or the system is inoperative.

**Note:** A corrupt CMOS can cause undetermined problems.

Check the LEDs on all the power supplies, see "Power supply LED errors" on page 110. If the LEDs indicate the power supplies are working correctly, return here and do the following:

1. Power-off the computer.
2. Be sure the system is cabled correctly.
3. Remove or disconnect the following (one at a time) until you find the failure (power-on the computer and reconfigure each time).

Any external devices

Surge suppressor device (on the computer)

Modem, printer, mouse, or non-IBM devices

Each adapter

Drives

Memory-Modules (Minimum requirement = 512 MB (4x128 MB DIMMs))

**Note:** Minimum operating requirements are:

- a. 1 Power Supply
  - b. Power Backplane
  - c. System Board (with pins 2 and 3 on J23 connected together to bypass the power switch; default is pins 1 and 2)
  - d. 1 Microprocessor
  - e. 1 Terminator Card in Slot 4
  - f. Memory Module (with a minimum of 1 bank of 128 MB DIMMs (128x4))
4. Power-on the computer. If the problem remains, suspect the following FRUs in the order listed:
    - Power Supply
    - Power Backplane
    - System Board

**Notes:**

1. If the problem goes away when you remove an adapter from the system, and replacing that adapter does not correct the problem, suspect the System Board.
2. If you suspect a networking problem and all the system tests pass, suspect a network cabling problem external to the system.

## Parts listing, Type 8682

The following parts information is for the xSeries 350, Type 8682, Models 1RY 2RY 4RY 5RY 6RY.

### System

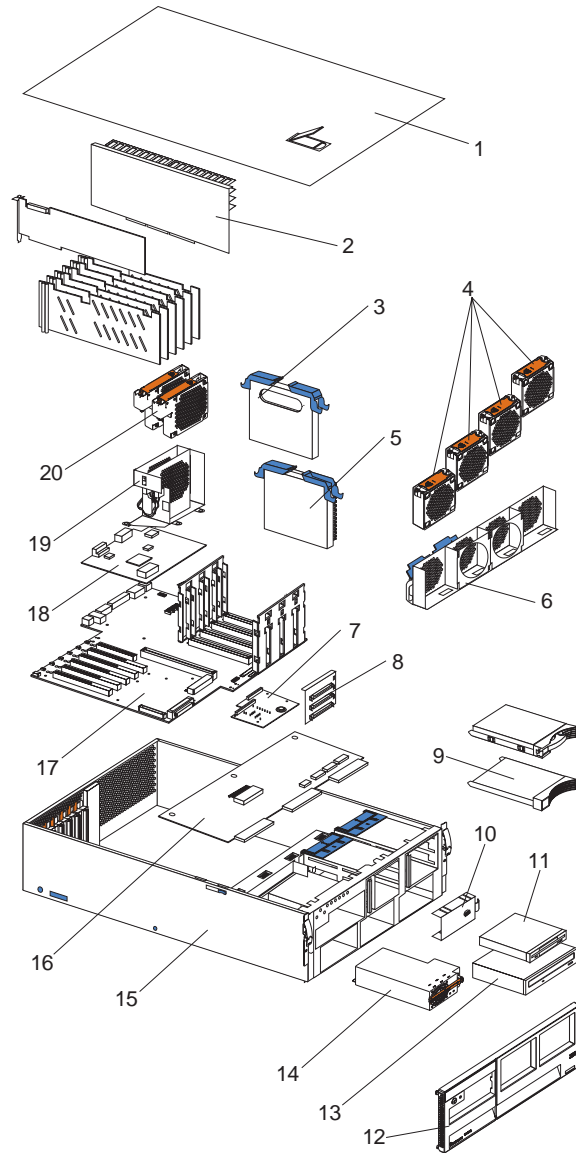

<b>Index</b>	<b>xSeries 350, Type 8682 (models 1RY 2RY 4RY 5RY 6RY)</b>	<b>FRU No.</b>
1	Top cover assembly (all models)	36L9611
2	Memory card with backer plate assembly (all models)	00N6637
3	CPU terminator card, slot 2 (models 1RY 4RY)	94H0598
4	92mm x 38 fan assembly (all models)	37L0305
5	700MHz/1MB processor (models 1RY 4RY)	19K0911
5	700MHz/2MB processor (models 2RY 5RY)	19K0913
5	900MHz/2MB processor (model 6RY)	24P3576
6	92mm fan housing assembly with card guides (all models)	00N8981
7	LED/switch card (katana) (all models)	37L6460
8	SCSI backplane w/backer plate assembly (all models)	00N8953
9	Slim hard disk drive bezel filler assembly (all models)	00N7259
10	Power supply filler panel (all models)	37L0331
11	1.44MB diskette drive (all models)	76H4091
12	Front bezel assembly, 18mm (models 1RY 2RY)	00N8971
13	48x CD-ROM (all models)	06P5167
14	Power supply with mounting, 270w (all models)	37L0311
15	Frame assembly (chassis) (all models)	36L9590
16	Power backplane assembly (all models)	00N6651
17	System board and backerplate assembly (all models)	00N6623
18	Service processor card assembly (all models)	00N6644
19	120mm fan dual fan mount with cable assembly (all models)	09N7936
20	120mm fan assembly (all models)	09N7938
	Rails snap-on, CD-ROM (all models)	00N6412
	Slide assembly, FDD left/right (all models)	00N6413
	Assembly, 3u left EIA flange (all models)	00N7190
	Assembly, 3u right EIA flange (all models)	00N7192
	Miscellaneous rack hardware kit (clips (12), cage nuts (12), M6 screws (12), M4x5 screws (10), Velcro strips (10)) (all models)	00N7193
	Slide with brackets assembly (all models)	00N7205
	Rigid cable management arm (all models)	00N7211
	Miscellaneous plastics kit (memory card support guides (2), processor support goalposts (2), DASD backplane locking latch (1), fan housing locking latch (1)) (all models)	00N8961
	Cassette, handle, slot 2 terminator card (all models)	10L6936
	Label, system service (all models)	36L9586
	Front bezel (models 4RY 5RY 6RY)	06P5945
	On/off switch cover (all models)	09N8012
	FR, 48X, BLWHP (alternate)	19K1531
	PCI hot plug switch card/housing (all models)	00N6665
	128 MB memory (all models)	33L3114
	AC distribution box assembly (all models)	00N8955
	1024 MB memory (all models)	33L3120
	256 MB memory (all models)	33L3116
	512 MB memory (all models)	33L3118
	Cable, signal I2C -board to SCSI backplane (2x7) (all models)	00N7185
	Cable, signal lvd-SCSI - repeater to SCSI backplane (all models)	00N7198
	Cable, SCSI to bulkhead (all models)	06P5912
	Cable, 2 drop 120mm fan (all models)	09N7945
	Cable, 50 circuit signal with connector (all models)	09N7947
	Cable, 34 circuit FDD w / connector (all models)	09N7949
	Cable, power - power backplane to SCSI backplane & devices (4 drop) (all models)	36L9601
	Cable, signal - system board to CD-ROM (IDE) (all models)	36L9603
	Cable, power 24 circuit (power backplane - system board) (all models)	36L9605
	Cable, power - signal - power backplane to board 2x17 (all models)	36L9609
	Cable, power - board to fans 2x15 (5 drop) (all models)	36L9613

<b>Index</b>	<b>xSeries 350, Type 8682 (models 1RY 2RY 4RY 5RY 6RY)</b>	<b>FRU No.</b>
	Cable, signal system board to SCSI backplane (all models)	37L0350
	Power cord (all models)	6952301

---

## Keyboards

<b>Keyboard</b>	<b>FRU No.</b>
US English	37L2551
French Canadian	37L2552
LA Spanish	37L2553
Arabic	37L2555
Belgium/French	37L2556
Belgium/UK	37L2557
Bulgarian	37L2558
Czech	37L2559
Danish	37L2560
Dutch	37L2561
French	37L2562
German	37L2563
Greek	37L2564
Hebrew	37L2565
Hungarian	37L2566
Korean	02K0901
Iceland	37L2567
Italy	37L2568
Norwegian	37L2569
Polish	37L2570
Portuguese	37L2571
Romanian	37L2572
Russian	37L2573
Serbian/Cyrillic	37L2574
Slavic	37L2575
Spanish	37L2576
Swedish/Finn	37L2577
Swiss, F/G	37L2578
Turkish	37L2579
Turkish	37L2580
UK English	37L2581
Yugosl/Lat	37L2582
US English-EMEA	37L2583
Chinese/US	37L2585
Thailand	37L2587
French Canadian	37L0913

---

## Power cords

<b>Power cord</b>	<b>FRU No.</b>
China (PRC)	01K9851
Japan	01K9853
Thailand	12J5120
Israel	12J5122
Bangladesh, Burma, India, Pakistan, South Africa, Sri Lanka	12J5124
Chile, Ethiopia, Italy, Libya, Somalia	12J5126

<b>Power cord</b>	<b>FRU No.</b>
Argentina, Australia, New Zealand, Papua New Guinea, Paraguay, Uruguay, Western Samoa	12J5128
Antigua, Bahrain, Brunei, Channel Islands, Cyprus, Dubai, Fiji, Ghana, Hong Kong, Iraq, Ireland, Kenya, Kuwait, Malawi, Malaysia, Malta, Nepal, Nigeria, Polynesia, Qatar, Sierra Leone, Singapore, Tanzania, Uganda, United Kingdom, Yemen, Zambia	12J5987
Afghanistan, Algeria, Andorra, Angola, Austria, Belgium, Benin, Bulgaria, Burkina Faso, Burundi, Cameroon, Central African Rep., Chad, Czech Republic, Egypt, Finland, France, French Guiana, Germany, Greece, Guinea, Hungary, Iceland, Indonesia, Iran, Ivory Coast, Jordan, Lebanon, Luxembourg, Macau, Malagasy, Mali, Martinique, Mauritania, Mauritius, Monaco, Morocco, Mozambique, Netherlands, New Caledonia, Niger, Norway, Poland, Portugal, Romania, Senegal, Slovakia, Spain, Sudan, Sweden, Syria, Togo, Tunisia, Turkey, former USSR, Vietnam, former Yugoslavia, Zaire, Zimbabwe	55H6643
Denmark, Switzerland, Liechtenstein	55H6646
Bahamas, Barbados, Bermuda, Bolivia, Brazil, Canada, Cayman Islands, Colombia, Costa Rica, Dominican Republic, Ecuador, El Salvador, Guatemala, Guyana, Haiti, Honduras, Jamaica, Korea (South), Liberia, Mexico, Netherlands Antilles, Nicaragua, Panama, Peru, Philippines, Saudi Arabia, Suriname, Taiwan, Trinidad (West Indies), Venezuela	76H4865
United States of America	6952301 (110) 1838574 (220) 36L8886 (220V/15A)



---

## Related service information

**Note:** The service procedures are designed to help you isolate problems. They are written with the assumption that you have model-specific training on all computers, or that are familiar with the computers, functions, terminology, and service information provided in this manual.

---

## Safety information

The following section contains the safety information that you need to be familiar with before servicing an IBM computer.

### General safety

Follow these rules to ensure general safety:

- Observe good housekeeping in the area of the machines during and after maintenance.
- When lifting any heavy object:
  1. Ensure you can stand safely without slipping.
  2. Distribute the weight of the object equally between your feet.
  3. Use a slow lifting force. Never move suddenly or twist when you attempt to lift.
  4. Lift by standing or by pushing up with your leg muscles; this action removes the strain from the muscles in your back. *Do not attempt to lift any objects that weigh more than 16 kg (35 lb) or objects that you think are too heavy for you.*
- Do not perform any action that causes hazards to the customer, or that makes the equipment unsafe.
- Before you start the machine, ensure that other service representatives and the customer's personnel are not in a hazardous position.
- Place removed covers and other parts in a safe place, away from all personnel, while you are servicing the machine.
- Keep your tool case away from walk areas so that other people will not trip over it.
- Do not wear loose clothing that can be trapped in the moving parts of a machine. Ensure that your sleeves are fastened or rolled up above your elbows. If your hair is long, fasten it.
- Insert the ends of your necktie or scarf inside clothing or fasten it with a nonconductive clip, approximately 8 centimeters (3 inches) from the end.
- Do not wear jewelry, chains, metal-frame eyeglasses, or metal fasteners for your clothing.

**Remember:** Metal objects are good electrical conductors.
- Wear safety glasses when you are: hammering, drilling soldering, cutting wire, attaching springs, using solvents, or working in any other conditions that might be hazardous to your eyes.
- After service, reinstall all safety shields, guards, labels, and ground wires. Replace any safety device that is worn or defective.
- Reinstall all covers correctly before returning the machine to the customer.

## Electrical safety



### CAUTION:

**Electrical current from power, telephone, and communication cables can be hazardous. To avoid personal injury or equipment damage, disconnect the attached power cords, telecommunication systems, networks, and modems before you open the server covers, unless instructed otherwise in the installation and configuration procedures.**

Observe the following rules when working on electrical equipment.

**Important:** Use only approved tools and test equipment. Some hand tools have handles covered with a soft material that does not insulate you when working with live electrical currents.

Many customers have, near their equipment, rubber floor mats that contain small conductive fibers to decrease electrostatic discharges. Do not use this type of mat to protect yourself from electrical shock.

- Find the room emergency power-off (EPO) switch, disconnecting switch, or electrical outlet. If an electrical accident occurs, you can then operate the switch or unplug the power cord quickly.
- Do not work alone under hazardous conditions or near equipment that has hazardous voltages.
- Disconnect all power before:
  - Performing a mechanical inspection
  - Working near power supplies
  - Removing or installing main units
- Before you start to work on the machine, unplug the power cord. If you cannot unplug it, ask the customer to power-off the wall box that supplies power to the machine and to lock the wall box in the off position.
- If you need to work on a machine that has exposed electrical circuits, observe the following precautions:
  - Ensure that another person, familiar with the power-off controls, is near you.  
**Remember:** Another person must be there to switch off the power, if necessary.
  - Use only one hand when working with powered-on electrical equipment; keep the other hand in your pocket or behind your back.  
**Remember:** There must be a complete circuit to cause electrical shock. By observing the above rule, you may prevent a current from passing through your body.
  - When using testers, set the controls correctly and use the approved probe leads and accessories for that tester.
  - Stand on suitable rubber mats (obtained locally, if necessary) to insulate you from grounds such as metal floor strips and machine frames.

Observe the special safety precautions when you work with very high voltages; these instructions are in the safety sections of maintenance information. Use extreme care when measuring high voltages.

- Regularly inspect and maintain your electrical hand tools for safe operational condition.
  - Do not use worn or broken tools and testers.
  - *Never assume* that power has been disconnected from a circuit. First, *check* that it has been powered-off.
  - Always look carefully for possible hazards in your work area. Examples of these hazards are moist floors, nongrounded power extension cables, power surges, and missing safety grounds.
  - Do not touch live electrical circuits with the reflective surface of a plastic dental mirror. The surface is conductive; such touching can cause personal injury and machine damage.
  - Do not service the following parts with the power on when they are removed from their normal operating places in a machine:
    - Power supply units
    - Pumps
    - Blowers and fans
    - Motor generators
- and similar units. (This practice ensures correct grounding of the units.)
- If an electrical accident occurs:
    - Use caution; do not become a victim yourself.
    - Switch off power.
    - Send another person to get medical aid.

## Safety inspection guide

The intent of this inspection guide is to assist you in identifying potentially unsafe conditions on these products. Each machine, as it was designed and built, had required safety items installed to protect users and service personnel from injury. This guide addresses only those items. However, good judgment should be used to identify potential safety hazards due to attachment of non-IBM features or options not covered by this inspection guide.

If any unsafe conditions are present, you must determine how serious the apparent hazard could be and whether you can continue without first correcting the problem.

Consider these conditions and the safety hazards they present:

- Electrical hazards, especially primary power (primary voltage on the frame can cause serious or fatal electrical shock).
- Explosive hazards, such as a damaged CRT face or bulging capacitor
- Mechanical hazards, such as loose or missing hardware

The guide consists of a series of steps presented in a checklist. Begin the checks with the power off, and the power cord disconnected.

Checklist:

1. Check exterior covers for damage (loose, broken, or sharp edges).
2. Power-off the computer. Disconnect the power cord.
3. Check the power cord for:
  - a. A third-wire ground connector in good condition. Use a meter to measure third-wire ground continuity for 0.1 ohm or less between the external ground pin and frame ground.

- b. The power cord should be the appropriate type as specified in the parts listings.
- c. Insulation must not be frayed or worn.
4. Remove the cover.
5. Check for any obvious non-IBM alterations. Use good judgment as to the safety of any non-IBM alterations.
6. Check inside the unit for any obvious unsafe conditions, such as metal filings, contamination, water or other liquids, or signs of fire or smoke damage.
7. Check for worn, frayed, or pinched cables.
8. Check that the power-supply cover fasteners (screws or rivets) have not been removed or tampered with.

## Handling electrostatic discharge-sensitive devices

Any computer part containing transistors or integrated circuits (ICs) should be considered sensitive to electrostatic discharge (ESD). ESD damage can occur when there is a difference in charge between objects. Protect against ESD damage by equalizing the charge so that the machine, the part, the work mat, and the person handling the part are all at the same charge.

### Notes:

1. Use product-specific ESD procedures when they exceed the requirements noted here.
2. Make sure that the ESD protective devices you use have been certified (ISO 9000) as fully effective.

When handling ESD-sensitive parts:

- Keep the parts in protective packages until they are inserted into the product.
- Avoid contact with other people.
- Wear a grounded wrist strap against your skin to eliminate static on your body.
- Prevent the part from touching your clothing. Most clothing is insulative and retains a charge even when you are wearing a wrist strap.
- Use the black side of a grounded work mat to provide a static-free work surface. The mat is especially useful when handling ESD-sensitive devices.
- Select a grounding system, such as those listed below, to provide protection that meets the specific service requirement.

**Note:** The use of a grounding system is desirable but not required to protect against ESD damage.

- Attach the ESD ground clip to any frame ground, ground braid, or green-wire ground.
- Use an ESD common ground or reference point when working on a double-insulated or battery-operated system. You can use coax or connector-outside shells on these systems.
- Use the round ground-prong of the ac plug on ac-operated computers.

## Grounding requirements

Electrical grounding of the computer is required for operator safety and correct system function. Proper grounding of the electrical outlet can be verified by a certified electrician.

## Safety notices (multi-lingual translations)

The caution and danger safety notices in this section are provided in the following languages:

- English
- Brazilian/Portuguese
- Chinese
- French
- German
- Italian
- Japanese
- Korean
- Spanish

**Important:** All caution and danger statements in this IBM documentation begin with a number. This number is used to cross reference an English caution or danger statement with translated versions of the caution or danger statement in this section.

For example, if a caution statement begins with a number 1, translations for that caution statement appear in this section under statement 1.

Be sure to read all caution and danger statements before performing any of the instructions.

### Statement 1



### DANGER

Electrical current from power, telephone and communication cables is hazardous.

#### To avoid a shock hazard:

- Do not connect or disconnect any cables or perform installation, maintenance, or reconfiguration of this product during an electrical storm.
- Connect all power cords to a properly wired and grounded electrical outlet.
- Connect to properly wired outlets any equipment that will be attached to this product.
- When possible, use one hand only to connect or disconnect signal cables.
- Never turn on any equipment when there is evidence of fire, water, or structural damage.
- Disconnect the attached power cords, telecommunications systems, networks, and modems before you open the device covers, unless instructed otherwise in the installation and configuration procedures.
- Connect and disconnect cables as described in the following table when installing, moving, or opening covers on this product or attached devices.

To Connect	To Disconnect
<ol style="list-style-type: none"><li>1. Turn everything OFF.</li><li>2. First, attach all cables to devices.</li><li>3. Attach signal cables to connectors.</li><li>4. Attach power cords to outlet.</li><li>5. Turn device ON.</li></ol>	<ol style="list-style-type: none"><li>1. Turn everything OFF.</li><li>2. First, remove power cords from outlet.</li><li>3. Remove signal cables from connectors.</li><li>4. Remove all cables from devices.</li></ol>

### Statement 2



#### CAUTION:

When replacing the lithium battery, use only IBM Part Number 33F8354 or an equivalent type battery recommended by the manufacturer. If your system has a module containing a lithium battery, replace it only with the same module type made by the same manufacturer. The battery contains lithium and can explode if not properly used, handled, or disposed of.

#### *Do not:*

- Throw or immerse into water
- Heat to more than 100°C (212°F)
- Repair or disassemble

Dispose of the battery as required by local ordinances or regulations.

### Statement 3



#### CAUTION:

When laser products (such as CD-ROMs, DVD-ROM drives, fiber optic devices, or transmitters) are installed, note the following:

- Do not remove the covers. Removing the covers of the laser product could result in exposure to hazardous laser radiation. There are no serviceable parts inside the device.
- Use of controls or adjustments or performance of procedures other than those specified herein might result in hazardous radiation exposure.



#### DANGER

Some laser products contain an embedded Class 3A or Class 3B laser diode. Note the following:

Laser radiation when open. Do not stare into the beam, do not view directly with optical instruments, and avoid direct exposure to the beam.

Statement 4

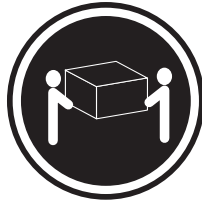

≥18 kg (39.7 lb)



≥32 kg (70.5 lb)

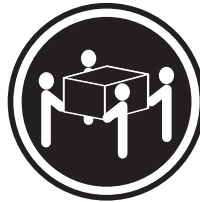

≥55 kg (121.2 lb)

**CAUTION:**  
Use safe practices when lifting.

Statement 5



**CAUTION:**

The power control button on the device and the power switch on the power supply do not turn off the electrical current supplied to the device. The device also might have more than one power cord. To remove all electrical current from the device, ensure that all power cords are disconnected from the power source.



Statement 10

**CAUTION:**

Do not place any object weighing more than 82 kg (180 lbs.) on top of rack-mounted devices.



## Importante:

Todas as instruções de cuidado e perigo da IBM documentation começam com um número. Este número é utilizado para fazer referência cruzada de uma instrução de cuidado ou perigo no idioma inglês com as versões traduzidas das instruções de cuidado ou perigo encontradas nesta seção.

Por exemplo, se uma instrução de cuidado é iniciada com o número 1, as traduções para aquela instrução de cuidado aparecem nesta seção sob a instrução 1.

Certifique-se de ler todas as instruções de cuidado e perigo antes de executar qualquer operação.

### Instrução 1



#### PERIGO

A corrente elétrica proveniente de cabos de alimentação, de telefone e de comunicações é perigosa.

Para evitar risco de choque:

- Não conecte ou desconecte cabos e não realize instalação, manutenção ou reconfiguração deste produto durante uma tempestade com raios.
- Conecte todos os cabos de alimentação a tomadas elétricas corretamente instaladas e aterradas.
- Conecte todos os equipamentos ao qual esse produto será conectado a tomadas corretamente instaladas.
- Sempre que possível, utilize apenas uma das mãos para conectar ou desconectar cabos de sinal.
- Nunca ligue qualquer equipamento quando existir evidência de danos por fogo, água ou na estrutura.
- Desconecte cabos de alimentação, sistemas de telecomunicação, redes e modems antes de abrir as tampas dos dispositivos, a menos que especificado de maneira diferente nos procedimentos de instalação e configuração.
- Conecte e desconecte cabos conforme descrito na seguinte tabela, ao instalar ou movimentar este produto ou os dispositivos conectados, ou ao abrir suas tampas.

Para Conectar:	Para Desconectar:
<ol style="list-style-type: none"><li>1. DESLIGUE Tudo.</li><li>2. Primeiramente, conecte todos os cabos aos dispositivos.</li><li>3. Conecte os cabos de sinal aos conectores.</li><li>4. Conecte os cabos de alimentação às tomadas.</li><li>5. LIGUE os dispositivos.</li></ol>	<ol style="list-style-type: none"><li>1. DESLIGUE Tudo.</li><li>2. Primeiramente, remova os cabos de alimentação das tomadas.</li><li>3. Remova os cabos de sinal dos conectores.</li><li>4. Remova todos os cabos dos dispositivos.</li></ol>



## Instrução 2



### **CUIDADO:**

Ao substituir a bateria de lítio, utilize apenas uma bateria IBM, Número de Peça 33F8354 ou uma bateria de tipo equivalente, recomendada pelo fabricante. Se o seu sistema possui um módulo com uma bateria de lítio, substitua-o apenas pelo mesmo tipo de módulo, do mesmo fabricante. A bateria contém lítio e pode explodir se não for utilizada, manuseada e descartada de maneira correta.

Não:

- Jogue ou coloque na água
- Aqueça a mais de 100°C (212°F)
- Conserte nem desmonte

Para descartar a bateria, entre em contato com a área de atendimento a clientes IBM, pelo telefone (011) 889-8986, para obter informações sobre como enviar a bateria pelo correio para a IBM.

## Instrução 3



### **PRECAUCIÓN:**

Quando produtos a laser (unidades de CD-ROM, unidades de DVD, dispositivos de fibra ótica, transmissores, etc.) estiverem instalados, observe o seguinte:

- Não remova as tampas. A remoção das tampas de um produto a laser pode resultar em exposição prejudicial à radiação de laser. Nenhuma peça localizada no interior do dispositivo pode ser consertada.
- A utilização de controles ou ajustes ou a execução de procedimentos diferentes dos especificados aqui pode resultar em exposição prejudicial à radiação.



### **PERIGO**

Alguns produtos a laser contêm um diodo laser da Classe 3A ou Classe 3B embutido. Observe o seguinte:

Radiação de laser quando aberto. Não olhe diretamente para o raio a olho nu ou com instrumentos óticos, e evite exposição direta ao raio.

#### Instrução 4

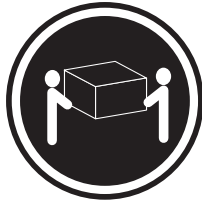

≥18 kg (39.7 lb)



≥32 kg (70.5 lb)

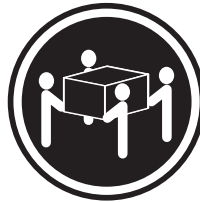

≥55 kg (121.2 lb)

#### CUIDADO:

Ao levantar a máquina, faça-o com segurança.

#### Instrução 5



#### CUIDADO:

Os botões Liga/Desliga localizados no dispositivo e na fonte de alimentação não desligam a corrente elétrica fornecida ao dispositivo. O dispositivo também pode ter mais de um cabo de alimentação. Para remover toda a corrente elétrica do dispositivo, assegure que todos os cabos de alimentação estejam desconectados da fonte de energia elétrica.



#### Instrução 10

#### CUIDADO:

Não coloque nenhum objeto com peso superior a 82 kg (180 lbs.) sobre dispositivos montados em rack.



## 重要:

Server Library 中的所有提醒和危险条款前都有一个数字标识。该数字是用来交叉引用一个英文的提醒和危险条款及本部分中的与之对应的已翻译成其它文字的提醒和危险条款。

例如, 如果一个提醒条款前的数字为 1, 则本部分中相应的译文也带有标号 1。

在执行任何指示的操作之前, 请确保您已经阅读了全部提醒和危险条款。

### 声明 1



#### 危险

电源、电话和通信电缆中带有危险电流。  
为避免电击:  
雷电期间不要拆接电缆或安装、维修及重新配置本产品。  
将所有电源线连接至正确布线并已安全接地的电源插座上。  
将与本产品连接的所有设备连接至正确布线的插座上。  
尽量只使用单手拆接信号电缆。  
有水、火及结构损坏迹象时, 请勿打开任何设备。  
除非在安装配置过程中有明确指示, 否则, 打开设备机盖前应先断开与电源线、远程通信系统、网络和调制解调器的所有连接。  
安装、移动或打开本产品及其附带设备的机盖时, 应按下表所述连接和断开电缆。

连接时:	断开连接时:
1. 关闭所有设备。	1. 关闭所有设备。
2. 首先将所有电缆连接至设备。	2. 首先从插座中拔出电源线。
3. 将信号电缆连接至接口。	3. 从接口上拔下信号电缆。
4. 将电源线连接至插座。	

## 声明 2



### 警告:

更换锂电池时，只能使用 IBM 产品号 33F8354 或者是厂商推荐的等同类型的电池。

如果系统模块中含有锂电池，则只能使用同一厂商制造的同一类型的模块进行更换。电池中含有锂。如果使用、拿放或处理不当，可能会发生爆炸。

请勿对电池进行下列操作：  
扔入或浸入水电  
加热超过 100 (212 F)  
进行修理或分解  
请按本地法规要求处理电池。

## 声明 3



### 警告:

安装激光产品（如 CD-ROM、DVD 驱动器、光纤设备或送话器）时，应注意以下事项：

不要拆除外盖。拆除激光产品的外盖可能会导致激光辐射的危险，本设备中没有用户可维修的部件。

非此处指定的其它控制、调整或与性能有关的操作都有可能导致激光辐射的危险。



### 危险

某些激光产品中包含内嵌的 3A 级或 3B 级激光二极管。请注意以下事项。

打开时会产生激光辐射。不要直视光束，不要使用光学仪器直接观看光束，避免直接暴露于光束之下。

声明 4



≥18 kg (37 磅)



≥32 kg (70.5 磅)



≥55 kg (121.2 磅)

警告：  
抬起时请采用安全操作方法。

声明 5



警告：  
使用设备上的电源控制按钮和电源上的开关都不能断开本设备上的电流。  
另外，本设备可能带有多条电源线。如要断开设备上的所有电流，请确  
保所有电源线均已与电源断开连接。

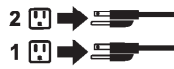

声明 6



警告：  
如果在电源线连接设备的一端安装了固定松紧夹，则必须将电源线的另一端连接至  
使用方便的电源。

声明 7



警告:

如果设备带有外门，则在移动或抬起设备前应将其拆除或固定以避免造成人员伤害。外门支撑不了设备的重量。

声明 8



警告:

不要拆除电源外盖或贴有下列标签的任何部件。



贴有此标签的组件内部存在高电压、高电流的危险。这些组件中没有用户可维修的部件。如果怀疑其中的部件存在问题，应与服务技术人员联系。

声明 9



警告:

为避免人员伤害，拆除设备上的风扇前应拨下热插拔风扇电缆。

声明 10



警告:

机柜安装的设备上面不能放置重于 82kg (180 磅) 的物品。



> 82 kg (180 磅)

## 重要資訊：

**Server Library** 中所有「注意」及「危險」的聲明均以數字開始。此一數字是用來作為交互參考之用，英文「注意」或「危險」聲明可在本節中找到相同內容的「注意」或「危險」聲明的譯文。

例如，有一「危險」聲明以數字 1 開始，則該「危險」聲明的譯文將出現在本節的「聲明」1 中。

執行任何指示之前，請詳讀所有「注意」及「危險」的聲明。

### 聲明 1



#### 危險

電源、電話及通信電纜上所產生的電流均有危險性。

#### 欲避免電擊危險：

- 在雷雨期間，請勿連接或切斷本產品上的任何電纜線，或安裝、維修及重新架構本產品。
- 請將電源線接至接線及接地正確的電源插座。
- 請將本產品隨附的設備連接至接線正確的插座。
- 儘可能使用單手來連接或切斷信號電纜線。
- 當設備有火燒或泡水的痕跡，或有結構性損害時，請勿開啓該設備的電源。
- 在安裝及架構之時，若非非常熟悉，在開啓裝置蓋子之前，請切斷電源線、電信系統、網路及數據機。
- 在安裝、移動本產品或附加裝置，或開啓其蓋子時，請依照下表中「連接」及「切斷」電纜線的步驟執行。

#### 連接：

1. 關閉所有開關。
2. 先將所有電纜線接上裝置。
3. 將信號電纜接上接頭。
4. 再將電源線接上電源插座。
5. 開啓裝置的電源。

#### 切斷：

1. 關閉所有開關。
2. 先自電源插座拔掉電源線。
3. 拔掉接頭上的所有信號電纜。
4. 再拔掉裝置上的所有電纜線。

### 聲明 2



#### 注意：

更換鋰電池時，只可使用 IBM 零件編號 33F8354 的電池，或製造商建議之相當類型的電池。若系統中具有包含鋰電池的模組，在更換此模組時，請使用相同廠商製造的相同模組類型。如未正確使用、處理或丟棄含有鋰的電池時，可能會引發爆炸。

#### 請勿將電池：

- 丟入或浸入水中
- 加熱超過 100 °C (212 °F)
- 修理或拆開

請遵照當地法令規章處理廢棄電池。

聲明 3



注意：

安裝雷射產品 (如 CD-ROM、DVD 光碟機、光纖裝置或發射器) 時，請注意下列事項：

- 請勿移開蓋子。移開雷射產品的蓋子，您可能會暴露於危險的雷射輻射之下。裝置中沒有需要維修的組件。
- 不依此處所指示的控制、調整或處理步驟，您可能會暴露於危險的輻射之下。



危險

有些雷射產品含有內嵌式 Class 3A 或 Class 3B 雷射二極體。請注意下列事項：

開啓時會產生雷射輻射。請勿凝視光束，不要使用光學儀器直接觀察，且應避免直接暴露在光束下。

聲明 4



≥ 18 公斤 (37 磅) ≥ 32 公斤 (70.5 磅) ≥ 55 公斤 (121.2 磅)

注意：

抬起裝置時，請注意安全措施。

聲明 5



注意：

裝置上的電源控制按鈕及電源供應器上的電源開關均無法關閉裝置上的電流。

本裝置可能有一條以上的電源線。如要移除裝置上的所有電流，請確認所有電源線已與電源分離。





聲明 10



注意：

請勿將任何重量超過 82 公斤 (180 磅) 的物品置於已安裝機架的裝置上方。



>82 公斤 (180 磅)

## Important:

Toutes les consignes Attention et Danger indiquées dans la bibliothèque IBM documentation sont précédées d'un numéro. Ce dernier permet de mettre en correspondance la consigne en anglais avec ses versions traduites dans la présente section.

Par exemple, si une consigne de type Attention est précédée du chiffre 1, ses traductions sont également précédées du chiffre 1 dans la présente section.

Prenez connaissance de toutes les consignes de type Attention et Danger avant de procéder aux opérations décrites par les instructions.

### Notice n° 1



### DANGER

Le courant électrique passant dans les câbles de communication, ou les cordons téléphoniques et d'alimentation peut être dangereux.

Pour éviter tout risque de choc électrique:

- Ne manipulez aucun câble et n'effectuez aucune opération d'installation, d'entretien ou de reconfiguration de ce produit au cours d'un orage.
- Branchez tous les cordons d'alimentation sur un socle de prise de courant correctement câblé et mis à la terre.
- Branchez sur des socles de prise de courant correctement câblés tout équipement connecté à ce produit.
- Lorsque cela est possible, n'utilisez qu'une seule main pour connecter ou déconnecter les câbles d'interface.
- Ne mettez jamais un équipement sous tension en cas d'incendie ou d'inondation, ou en présence de dommages matériels.
- Avant de retirer les carters de l'unité, mettez celle-ci hors tension et déconnectez ses cordons d'alimentation, ainsi que les câbles qui la relient aux réseaux, aux systèmes de télécommunication et aux modems (sauf instruction contraire mentionnée dans les procédures d'installation et de configuration).
- Lorsque vous installez ou que vous déplacez le présent produit ou des périphériques qui lui sont raccordés, reportez-vous aux instructions ci-dessous pour connecter et déconnecter les différents cordons.

Connexion	Déconnexion
<ol style="list-style-type: none"><li>1. Mettez les unités hors tension.</li><li>2. Commencez par brancher tous les cordons sur les unités.</li><li>3. Branchez les câbles d'interface sur des connecteurs.</li><li>4. Branchez les cordons d'alimentation sur des prises.</li><li>5. Mettez les unités sous tension.</li></ol>	<ol style="list-style-type: none"><li>1. Mettez les unités hors tension.</li><li>2. Débranchez les cordons d'alimentation des prises.</li><li>3. Débranchez les câbles d'interface des connecteurs.</li><li>4. Débranchez tous les câbles des unités.</li></ol>

### Notice n° 2



#### ATTENTION:

Remplacez la pile au lithium usagée par une pile de référence identique exclusivement - voir la référence IBM - ou par une pile équivalente recommandée par le fabricant. Si votre système est doté d'un module contenant une pile au lithium, vous devez le remplacer uniquement par un module identique, produit par le même fabricant. La pile contient du lithium et présente donc un risque d'explosion en cas de mauvaise manipulation ou utilisation.

- Ne la jetez pas à l'eau.
- Ne l'exposez pas à une température supérieure à 100 °C.
- Ne cherchez pas à la réparer ou à la démonter.

Pour la mise au rebut, reportez-vous à la réglementation en vigueur.

### Notice n° 3



#### ATTENTION:

Si des produits laser sont installés (tels que des unités de CD-ROM ou de DVD, des périphériques contenant des fibres optiques ou des émetteurs-récepteurs), prenez connaissance des informations suivantes:

- N'ouvrez pas ces produits pour éviter une exposition directe au rayon laser. Vous ne pouvez effectuer aucune opération de maintenance à l'intérieur.
- Pour éviter tout risque d'exposition au rayon laser, respectez les consignes de réglage et d'utilisation des commandes, ainsi que les procédures décrites dans le présent document.



#### DANGER

Certains produits laser contiennent une diode laser de classe 3A ou 3B. Prenez connaissance des informations suivantes:

Rayonnement laser lorsque le carter est ouvert. évitez de regarder fixement le faisceau ou de l'observer à l'aide d'instruments optiques. évitez une exposition directe au rayon.

Notice n° 4

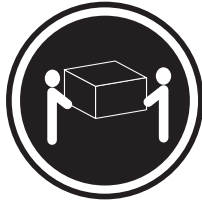

≥18 kg (39.7 lb)



≥32 kg (70.5 lb)

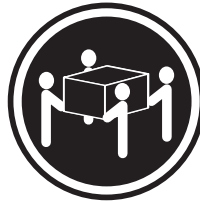

≥55 kg (121.2 lb)

**ATTENTION:**

Faites-vous aider pour soulever ce produit.

Notice n° 5



**ATTENTION:**

Le bouton de mise sous tension/hors tension de l'unité et l'interrupteur d'alimentation du bloc d'alimentation ne coupent pas l'arrivée de courant électrique à l'intérieur de la machine. Il se peut que votre unité dispose de plusieurs cordons d'alimentation. Pour isoler totalement l'unité du réseau électrique, débranchez tous les cordons d'alimentation des socles de prise de courant.



Notice n° 10

**ATTENTION:**

Ne posez pas d'objet dont le poids dépasse 82 kg sur les unités montées en armoire.



## Wichtig:

Alle Sicherheitshinweise in dieser IBM documentation beginnen mit einer Nummer. Diese Nummer verweist auf einen englischen Sicherheitshinweis mit den übersetzten Versionen dieses Hinweises in diesem Abschnitt.

Wenn z. B. ein Sicherheitshinweis mit der Nummer 1 beginnt, so erscheint die Übersetzung für diesen Sicherheitshinweis in diesem Abschnitt unter dem Hinweis 1.

Lesen Sie alle Sicherheitshinweise, bevor Sie eine Anweisung ausführen.

### Hinweis 1



### VORSICHT

Elektrische Spannungen von Netz-, Telefon- und Datenübertragungsleitungen sind gefährlich.

Aus Sicherheitsgründen:

- Bei Gewitter an diesem Gerät keine Kabel anschließen oder lösen. Ferner keine Installations-, Wartungs- oder Rekonfigurationsarbeiten durchführen.
- Gerät nur an eine Schutzkontaktsteckdose mit ordnungsgemäß geerdetem Schutzkontakt anschließen.
- Alle angeschlossenen Geräte ebenfalls an Schutzkontaktsteckdosen mit ordnungsgemäß geerdetem Schutzkontakt anschließen.
- Signalkabel möglichst einhändig anschließen oder lösen.
- Keine Geräte einschalten, wenn die Gefahr einer Beschädigung durch Feuer, Wasser oder andere Einflüsse besteht.
- Die Verbindung zu den angeschlossenen Netzkabeln, Telekommunikationssystemen, Netzwerken und Modems ist vor dem Öffnen des Gehäuses zu unterbrechen. Es sei denn, dies ist in den zugehörigen Installations- und Konfigurationsprozeduren anders angegeben.
- Nur nach den nachfolgend aufgeführten Anweisungen arbeiten, die für Installation, Transport oder Öffnen von Gehäusen von Personal Computern oder angeschlossenen Einheiten gelten.

Kabel anschließen:	Kabel lösen:
<ol style="list-style-type: none"><li>1. Alle Geräte ausschalten und Netzstecker ziehen.</li><li>2. Zuerst alle Kabel an Einheiten anschließen.</li><li>3. Signalkabel an Anschlußbuchsen anschließen.</li><li>4. Netzstecker an Steckdose anschließen.</li><li>5. Gerät einschalten.</li></ol>	<ol style="list-style-type: none"><li>1. Alle Geräte ausschalten.</li><li>2. Zuerst Netzstecker von Steckdose lösen.</li><li>3. Signalkabel von Anschlußbuchsen lösen.</li><li>4. Alle Kabel von Einheiten lösen.</li></ol>

## Hinweis 2



### ACHTUNG:

Eine verbrauchte Batterie nur durch eine Batterie mit der IBM Teilenummer 33F8354 oder durch eine vom Hersteller empfohlene Batterie ersetzen. Wenn Ihr System ein Modul mit einer Lithium-Batterie enthält, ersetzen Sie es immer mit dem selben Modultyp vom selben Hersteller. Die Batterie enthält Lithium und kann bei unsachgemäßer Verwendung, Handhabung oder Entsorgung explodieren.

Die Batterie nicht:

- mit Wasser in Berührung bringen.
- über 100 C erhitzen.
- reparieren oder zerlegen.

Die örtlichen Bestimmungen für die Entsorgung von Sondermüll beachten.

## Hinweis 3



### ACHTUNG:

Wenn ein Laserprodukt (z. B. CD-ROM-Laufwerke, DVD-Laufwerke, Einheiten mit Glasfaserkabeln oder Transmitter) installiert ist, beachten Sie folgendes.

- Das Entfernen der Abdeckungen des CD-ROM-Laufwerks kann zu gefährlicher Laserstrahlung führen. Es befinden sich keine Teile innerhalb des CD-ROM-Laufwerks, die vom Benutzer gewartet werden müssen. Die Verkleidung des CD-ROM-Laufwerks nicht öffnen.
- Steuer- und Einstellelemente sowie Verfahren nur entsprechend den Anweisungen im vorliegenden Handbuch einsetzen. Andernfalls kann gefährliche Laserstrahlung auftreten.



### VORSICHT

Manche CD-ROM-Laufwerke enthalten eine eingebaute Laserdiode der Klasse 3A oder 3B. Die nachfolgend aufgeführten Punkte beachten.

Laserstrahlung bei geöffneter Tür. Niemals direkt in den Laserstrahl sehen, nicht direkt mit optischen Instrumenten betrachten und den Strahlungsbereich meiden.

#### Hinweis 4

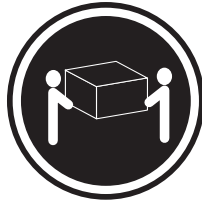

≥18 kg



≥32 kg

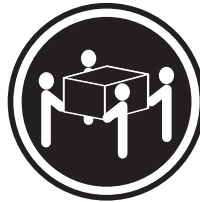

≥55 kg

#### ACHTUNG:

Beim Anheben der Maschine die vorgeschriebenen Sicherheitsbestimmungen beachten.

#### Hinweis 5



#### ACHTUNG:

Mit dem Betriebsspannungsschalter an der Vorderseite des Servers und dem Betriebsspannungsschalter am Netzteil wird die Stromversorgung für den Server nicht unterbrochen. Der Server könnte auch mehr als ein Netzkabel aufweisen. Um die gesamte Stromversorgung des Servers auszuschalten, muß sichergestellt werden, daß alle Netzkabel aus den Netzsteckdosen herausgezogen wurden.



#### Hinweis 10

#### ACHTUNG:

Keine Gegenstände, die mehr als 82 kg wiegen, auf Rack-Einheiten ablegen.



## Importante:

Tutti gli avvisi di attenzione e di pericolo riportati nella pubblicazione IBM documentation iniziano con un numero. Questo numero viene utilizzato per confrontare avvisi di attenzione o di pericolo in inglese con le versioni tradotte riportate in questa sezione.

Ad esempio, se un avviso di attenzione inizia con il numero 1, la relativa versione tradotta è presente in questa sezione con la stessa numerazione.

Prima di eseguire una qualsiasi istruzione, accertarsi di leggere tutti gli avvisi di attenzione e di pericolo.

### Avviso 1



### PERICOLO

La corrente elettrica circolante nei cavi di alimentazione, del telefono e di segnale è pericolosa.

Per evitare il pericolo di scosse elettriche:

- Non collegare o scollegare i cavi, non effettuare l'installazione, la manutenzione o la riconfigurazione di questo prodotto durante i temporali.
- Collegare tutti i cavi di alimentazione ad una presa elettrica correttamente cablata e munita di terra di sicurezza.
- Collegare qualsiasi apparecchiatura collegata a questo prodotto ad una presa elettrica correttamente cablata e munita di terra di sicurezza.
- Quando possibile, collegare o scollegare i cavi di segnale con una sola mano.
- Non accendere qualsiasi apparecchiatura in presenza di fuoco, acqua o se sono presenti danni all'apparecchiatura stessa.
- Scollegare i cavi di alimentazione, i sistemi di telecomunicazioni, le reti e i modem prima di aprire i coperchi delle unità, se non diversamente indicato nelle procedure di installazione e configurazione.
- Collegare e scollegare i cavi come descritto nella seguente tabella quando si effettuano l'installazione, la rimozione o l'apertura dei coperchi di questo prodotto o delle unità collegate.

Per collegare:	Per scollegare:
<ol style="list-style-type: none"><li>1. SPEGNERE tutti i dispositivi.</li><li>2. Collegare prima tutti i cavi alle unità.</li><li>3. Collegare i cavi di segnale ai connettori.</li><li>4. Collegare i cavi di alimentazione alle prese elettriche.</li><li>5. ACCENDERE le unità.</li></ol>	<ol style="list-style-type: none"><li>1. SPEGNERE tutti i dispositivi.</li><li>2. Rimuovere prima i cavi di alimentazione dalle prese elettriche.</li><li>3. Rimuovere i cavi di segnale dai connettori.</li><li>4. Rimuovere tutti i cavi dalle unità.</li></ol>



## Avviso 2



### ATTENZIONE:

Quando si sostituisce la batteria al litio, utilizzare solo una batteria IBM con numero parte 33F8354 o batterie dello stesso tipo o di tipo equivalente consigliate dal produttore. Se il sistema di cui si dispone è provvisto di un modulo contenente una batteria al litio, sostituire tale batteria solo con un tipo di modulo uguale a quello fornito dal produttore. La batteria contiene litio e può esplodere se utilizzata, maneggiata o smaltita impropriamente.

Evitare di:

- Gettarla o immergerla in acqua
- Riscaldarla ad una temperatura superiore ai 100°C
- Cercare di ripararla o smontarla

Smaltire secondo la normativa in vigore (D.Lgs 22 del 5/2/9) e successive disposizioni nazionali e locali.

## Avviso 3



### ATTENZIONE:

Quando si installano prodotti laser come, ad esempio, le unità DVD, CD-ROM, a fibre ottiche o trasmettitori, prestare attenzione a quanto segue:

- Non rimuovere i coperchi. L'apertura dei coperchi di prodotti laser può determinare l'esposizione a radiazioni laser pericolose. All'interno delle unità non vi sono parti su cui effettuare l'assistenza tecnica.
- L'utilizzo di controlli, regolazioni o l'esecuzione di procedure non descritti nel presente manuale possono provocare l'esposizione a radiazioni pericolose.



### PERICOLO

Alcuni prodotti laser contengono all'interno un diodo laser di Classe 3A o Classe 3B. Prestare attenzione a quanto segue:

Aperto l'unità vengono emesse radiazioni laser. Non fissare il fascio, non guardarlo direttamente con strumenti ottici ed evitare l'esposizione diretta al fascio.

#### Avviso 4

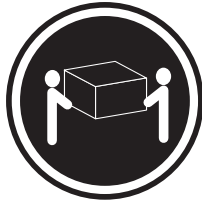

≥18 kg



≥32 kg

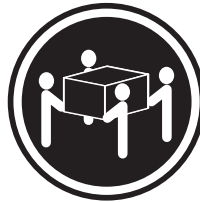

≥55 kg

#### ATTENZIONE:

Durante il sollevamento della macchina seguire delle norme di sicurezza.

#### Avviso 5



#### ATTENZIONE:

Il pulsante del controllo dell'alimentazione situato sull'unità e l'interruttore di alimentazione posto sull'alimentatore non disattiva la corrente elettrica fornita all'unità. L'unità potrebbe disporre di più di un cavo di alimentazione. Per disattivare la corrente elettrica dall'unità, accertarsi che tutti i cavi di alimentazione siano scollegati dalla sorgente di alimentazione.



#### Avviso 10

#### ATTENZIONE:

Non poggiare oggetti che pesano più di 82 kg sulla parte superiore delle unità montate in rack.



重要:

Netfinity Server ライブラリーにあるすべての注意および危険の記述は数字で始まります。この数字は、英語版の注意および危険の記述と翻訳された注意および危険の記述を相互参照するために使用します。

例えば、もし注意の記述が数字の1で始まっている場合は、その注意の翻訳は、記述1の下にあります。

手順を実施する前に、すべての注意:

・記述 1

## ⚠ 危険

感電を防止するため、雷の発生時には、いかなるケーブルの取り付けまたは取り外しも行わないでください。また導入、保守、再構成などの作業も行わないでください。

感電を防止するため:

- 電源コードは正しく接地および配線が行われている電源に接続してください。
- 本製品が接続されるすべての装置もまた正しく配線された電源に接続されている必要があります。

できれば、信号ケーブルに取り付けまたは取り外し的时候は片方の手のみで行うようにしてください。これにより、電位差がある二つの表面に触ることによる感電を防ぐことができます。

電源コード、電話ケーブル、通信ケーブルからの電流は身体に危険を及ぼします。設置、移動、または製品のカバーを開けたり装置を接続したりするときには、以下のようにケーブルの接続、取り外しを行ってください。

接続するには	取り外すには
1. すべての電源を切る	1. すべての電源を切る
2. まず、装置にすべてのケーブルを接続する。	2. まず、電源コンセントから電源コードを取り外す
3. 次に、通信ケーブルをコネクタに接続する	3. 次に、通信ケーブルをコネクタから取り外す。
4. その後、電源コンセントに電源コードを接続する	4. その後、装置からすべてのケーブルを取り外す
5. 装置の電源を入れる。	

・記述 2

## ⚠ 注意

本製品には、システム・ボード上にリチウム電池が使用されています。電池の交換方法や取り扱いを誤ると、発熱、発火、破裂のおそれがあります。

電池の交換には、IBM部品番号33F8354の電池またはメーカー推奨の同等の電池を使用してください。

交換用電池の購入については、お買い求めの販売店または弊社の営業担当までお問い合わせください。

電池は幼児の手の届かない所に置いてください。

万一、幼児が電池を飲み込んだときは、直ちに医師に相談してください。

以下の行為は絶対にしないでください。

- 水にぬらすこと
- 100度C 以上の過熱や焼却
- 分解や充電
- ショート

電池を廃棄する場合、および保存する場合にはテープなどで絶縁してください。他の金属や電池と混ざると発火、破裂の原因となります。電池は地方自治体の条例、または規則に従って廃棄してください。ごみ廃棄場で処分されるごみの中に捨てないでください。

・記述 3

## ⚠ 注意

レーザー製品 (CD-ROM、DVD、または光ファイバー装置または送信器など) が組み込まれている場合は、下記に御注意ください。

- ここに記載されている制御方法、調整方法、または性能を超えて使用すると、危険な放射線を浴びる可能性があります。
- ドライブのカバーを開けると、危険な放射線を浴びる可能性があります。ドライブの内部に修理のために交換可能な部品はありません。カバーを開けないでください。

## ⚠ 危険

一部 CD-ROM ドライブは、Class 3A または Class 3B レーザーダイオードを使用しています。次の点に注意してください。

CD-ROMドライブのカバーを開けるとレーザーが放射されます。光線を見つめたり、光学器械を使って直接見たりしないでください。また直接光線を浴びないようにしてください。

・記述 4

## ⚠ 注意



18kg 以上



32kg 以上



55kg 以上

装置を持ち上げる場合は、安全に持ち上げる方法に従ってください。

・記述 5

## ⚠ 注意 ⚡

サーバーの前面にある電源制御ボタンは、サーバーに供給された電流を遮断しません。サーバーには、複数の電源コードが接続されているかもしれません。サーバーから電流を完全に遮断するために、すべての電源コードが電源から取り外されていることを確認してください。

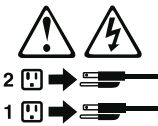

・記述 10

## ⚠ 注意

ラック・モデルのサーバーの上に 82 Kg 以上の物を置かないでください。



**중요:**

본 *Server Library*에 있는 모든 주의 및 위험 경고문은 번호로 시작합니다. 이 번호는 영문 주의 혹은 위험 경고문과 이 절에 나오는 번역된 버전의 주의 혹은 위험 경고문을 상호 참조하는 데 사용됩니다.

예를 들어, 주의 경고문이 번호 1로 시작하면, 번역된 해당 주의 경고문을 본 절의 경고문 1에서 찾아볼 수 있습니다.

모든 지시사항을 수행하기 전에 반드시 모든 주의 및 위험 경고문을 읽으십시오.

경고문 1

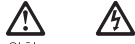

위험

전원, 전황 및 통신 케이블로부터 흘러 나오는 전류는 위험합니다.

전기 충격을 피하려면:

- 뇌우를 동반할 때는 케이블의 연결이나 철수, 이 제품의 설치, 유지보수 또는 재구성을 하지 마십시오.
- 모든 전원 코드를 적절히 배선 및 접지해야 합니다.
- 이 제품에 연결될 모든 장비를 적절하게 배선된 콘센트에 연결하십시오.
- 가능한 신호 케이블을 한 손으로 연결하거나 끊으십시오.
- 화재, 수해 또는 구조상의 손상이 있을 경우 장비를 꺼지 마십시오.
- 설치 및 구성 프로시저에 다른 설명이 없는 한, 장치 덮개를 열기 전에 연결된 전원 코드, 원거리 통신 시스템, 네트워크 및 모뎀을 끊어 주십시오.
- 제품 또는 접속된 장치를 설치, 이동 및 덮개를 열 때 다음 설명에 따라 케이블을 연결하거나 끊도록 하십시오.

<p>연결하려면:</p> <ol style="list-style-type: none"> <li>1. 모든 스위치를 끕니다.</li> <li>2. 먼저 모든 케이블을 장치에 연결합니다.</li> <li>3. 신호 케이블을 커넥터에 연결합니다.</li> <li>4. 콘센트에 전원 코드를 연결합니다.</li> <li>5. 장치 스위치를 켭니다.</li> </ol>	<p>연결을 끊으려면:</p> <ol style="list-style-type: none"> <li>1. 모든 스위치를 끕니다.</li> <li>2. 먼저 콘센트에서 전원 코드를 뽑습니다.</li> <li>3. 신호 케이블을 커넥터에서 제거합니다.</li> <li>4. 장치에서 모든 케이블을 제거합니다.</li> </ol>
---	---

경고문 2



주의:

리튬 배터리를 교체할 때는 IBM 부품 번호 33F8354 또는 제조업체에서 권장하는 동등한 유형의 배터리를 사용하십시오. 시스템에 리튬 배터리를 갖고 있는 모듈이 있으면 동일한 제조업체에서 생산된 동일한 모듈 유형으로 교체하십시오. 배터리에 리튬이 있을 경우 제대로 사용, 처리 또는 처분하지 않으면 폭발할 수 있습니다.

다음은 주의하십시오.

- 던지거나 물에 담그지 않도록 하십시오.
- 100°C(212°F) 이상으로 가열하지 마십시오.
- 수리하거나 분해하지 마십시오.

지역 법령이나 규정의 요구에 따라 배터리를 처분하십시오.

경고문 3



주의:

레이저 제품(CD-ROMs, DVD 드라이브, 광 장치 또는 트랜스미터 등과 같은)이 설치되어 있을 경우 다음을 유의하십시오.

- 덮개를 제거하지 마십시오. 레이저 제품의 덮개를 제거했을 경우 위험한 레이저 광선에 노출될 수 있습니다. 이 장치 안에는 서비스를 받을 수 있는 부품이 없습니다.

- 여기에서 지정하지 않은 방식의 제어, 조절 또는 실행으로 인해 위험한 레이저 광선에 노출될 수 있습니다.



위험

일부 레이저 제품에는 클래스 3A 또는 클래스 3B 레이저 다이오드가 들어 있습니다. 다음을 주의하십시오.

열면 레이저 광선에 노출됩니다. 광선을 주시하거나 광학 기계를 직접 쳐다보지 않도록 하고 광선에 노출되지 않도록 하십시오.

경고문 4



≥18 kg (37 lbs)



≥ 32 kg (70.5 lbs)



≥ 55 kg (121.2 lbs)

주의:

기계를 들 때는 안전하게 들어 올리십시오.

경고문 5



주의:

장치의 전원 제어 버튼 및 전원 공급기의 전원 스위치는 장치에 공급되는 전류를 차단하지 않습니다. 장치에 둘 이상의 전원 코드가 연결되어 있을 수도 있습니다. 장치에서 모든 전류를 차단하려면 모든 전원 코드가 전원으로부터 차단되어 있는지 확인하십시오.



경고문 10



주의:

서랍형 모델의 장치 상단에 82 kg(180 lbs.)이 넘는 물체를 올려 놓지 마십시오.



>82 kg (180 lbs)

## Importante:

Todas las declaraciones de precaución de esta IBM documentation empiezan con un número. Dicho número se emplea para establecer una referencia cruzada de una declaración de precaución o peligro en inglés con las versiones traducidas que de dichas declaraciones pueden encontrarse en esta sección.

Por ejemplo, si una declaración de peligro empieza con el número 1, las traducciones de esta declaración de precaución aparecen en esta sección bajo Declaración 1.

Lea atentamente todas las declaraciones de precaución y peligro antes de llevar a cabo cualquier operación.

### Declaración 1



#### PELIGRO

La corriente eléctrica de los cables telefónicos, de alimentación y de comunicaciones es perjudicial.

Para evitar una descarga eléctrica:

- No conecte ni desconecte ningún cable ni realice las operaciones de instalación, mantenimiento o reconfiguración de este producto durante una tormenta.
- Conecte cada cable de alimentación a una toma de alimentación eléctrica con conexión a tierra y cableado correctos.
- Conecte a tomas de alimentación con un cableado correcto cualquier equipo que vaya a estar conectado a este producto.
- Si es posible, utilice una sola mano cuando conecte o desconecte los cables de sent.al.
- No encienda nunca un equipo cuando haya riesgos de incendio, de inundación o de daños estructurales.
- Desconecte los cables de alimentación, sistemas de telecomunicaciones, redes y módems conectados antes de abrir las cubiertas del dispositivo a menos que se indique lo contrario en los procedimientos de instalación y configuración.
- Conecte y desconecte los cables tal como se describe en la tabla siguiente cuando desee realizar una operación de instalación, de traslado o de apertura de las cubiertas para este producto o para los dispositivos conectados.

Para la conexión	Para la desconexión
<ol style="list-style-type: none"><li>1. APÁGUELO todo.</li><li>2. En primer lugar, conecte los cables a los dispositivos.</li><li>3. Conecte los cables de señal a los conectores.</li><li>4. Conecte cada cable de alimentación a la toma de alimentación.</li><li>5. ENCIENDA el dispositivo.</li></ol>	<ol style="list-style-type: none"><li>1. APÁGUELO todo.</li><li>2. En primer lugar, retire cada cable de alimentación de la toma de alimentación.</li><li>3. Retire los cables de señal de los conectores.</li><li>4. Retire los cables de los dispositivos.</li></ol>

### Declaración 2



#### PRECAUCIÓN:

Cuando desee sustituir la batería de litio, utilice únicamente el número de pieza 33F8354 de IBM o cualquier tipo de batería equivalente que recomiende el fabricante. Si el sistema tiene un módulo que contiene una batería de litio, sustitúyalo únicamente por el mismo tipo de módulo, que ha de estar creado por el mismo fabricante. La batería contiene litio y puede explotar si el usuario no la utiliza ni la maneja de forma adecuada o si no se desprende de la misma como corresponde.

No realice las acciones siguientes:

- Arrojarla al agua o sumergirla
- Calentarla a una temperatura que supere los 100°C (212°F)
- Repararla o desmontarla

Despréndase de la batería siguiendo los requisitos que exija el reglamento o la legislación local.

### Declaración 3



#### PRECAUCIÓN:

Cuando instale productos láser (como, por ejemplo, CD-ROM, unidades DVD, dispositivos de fibra óptica o transmisores), tenga en cuenta las advertencias siguientes:

- No retire las cubiertas. Si retira las cubiertas del producto láser, puede quedar expuesto a radiación láser perjudicial. Dentro del dispositivo no existe ninguna pieza que requiera mantenimiento.
- El uso de controles o ajustes o la realización de procedimientos que no sean los que se han especificado aquí pueden dar como resultado una exposición perjudicial a las radiaciones.



#### PELIGRO

Algunos productos láser contienen un diodo de láser incorporado de Clase 3A o de Clase 3B. Tenga en cuenta la advertencia siguiente.

Cuando se abre, hay radiación láser. No mire fijamente el rayo ni lleve a cabo ningún examen directamente con instrumentos ópticos; evite la exposición directa al rayo.



#### Declaración 4

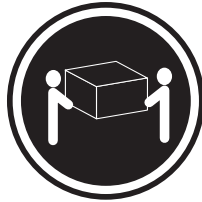

≥18 kg



≥32 kg



≥55 kg

#### PRECAUCIÓN:

Tome medidas de seguridad al levantar el producto.

#### Declaración 5



#### PRECAUCIÓN:

El botón de control de alimentación del dispositivo y el interruptor de alimentación de la fuente de alimentación no apagan la corriente eléctrica suministrada al dispositivo. Es posible también que el dispositivo tenga más de un cable de alimentación. Para eliminar la corriente eléctrica del dispositivo, asegúrese de desconectar todos los cables de alimentación de la fuente de alimentación.



#### Declaración 10

#### PRECAUCIÓN:

No coloque ningún objeto que pese más de 82 kg (180 libras) encima de los dispositivos montados en bastidor.



---

## Problem determination tips

Due to the variety of hardware and software combinations that can be encountered, use the following information to assist you in problem determination. If possible, have this information available when requesting assistance from Service Support and Engineering functions.

- Machine type and model
- Processor or hard disk upgrades
- Failure symptom
  - Do diagnostics fail?
  - What, when, where, single, or multiple systems?
  - Is the failure repeatable?
  - Has this configuration ever worked?
  - If it has been working, what changes were made prior to it failing?
  - Is this the original reported failure?
- Reference/Diagnostics version
  - Type and version level
- Hardware configuration
  - Print (print screen) configuration currently in use
  - BIOS level
- Operating system software
  - Type and version level

**Note:** To eliminate confusion, identical systems are considered identical only if they:

1. Are the exact machine type and models
2. Have the same BIOS level
3. Have the same adapters/attachments in the same locations
4. Have the same address jumpers/terminators/cabling
5. Have the same software versions and levels
6. Have the same Reference/Diagnostics Diskette (version)
7. Have the same configuration options set in the system
8. Have the same setup for the operation system control files

Comparing the configuration and software set-up between "working and non-working" systems will often lead to problem resolution.

---

## Notices

References in this publication to IBM products, programs, or services do not imply that IBM intends to make these available in all countries in which IBM operates. Any reference to an IBM product, program, or service is not intended to state or imply that only that IBM product, program, or service may be used. Subject to IBM's valid intellectual property or other legally protectable rights, any functionally equivalent product, program, or service may be used instead of the IBM product, program, or service. The evaluation and verification of operation in conjunction with other products, except those expressly designated by IBM, are the responsibility of the user.

IBM makes no representations or warranties regarding non-IBM products. For non-IBM software, third-party software licenses may apply.

GHz, MHz only measures microprocessor internal clock speed, not application performance. Many factors affect application performance.

When referring to hard disk drive capacity, GB equals one billion bytes. Total user-accessible capacity may vary depending on operating environments.

IBM makes no warranties, express or implied, regarding non-IBM products and services that are ServerProven<sup>®</sup>, including but not limited to the implied warranties of merchantability and fitness for particular purpose. These products are offered and warranted solely by third parties.

---

## Trademarks

The following terms are trademarks of International Business Machines Corporation in the United States, other countries, or both:

Active Memory	PS/2
Active PCI	ServeRAID
Active PCI-X	ServerGuide
Alert on LAN	ServerProven
C2T Interconnect	TechConnect
Chipkill	ThinkPad
EtherJet	Tivoli
e-business logo	Tivoli Enterprise
@server	Update Connector
FlashCopy	Wake on LAN
IBM	XA-32
IntelliStation	XA-64
NetBAY	X-Architecture
Netfinity	Xcel4
NetView	XpandOnDemand
OS/2 WARP	xSeries
Predictive Failure Analysis	

Lotus, Lotus Notes, SmartSuite, and Domino are trademarks of Lotus Development Corporation and/or IBM Corporation in the United States, other countries, or both.

Intel, MMX, and Pentium are trademarks of Intel Corporation in the United States, other countries, or both.

Microsoft, Windows, and Windows NT are trademarks of Microsoft Corporation in the United States, other countries, or both.

UNIX is a registered trademark of The Open Group in the United States and other countries.

Java and all Java-based trademarks and logos are trademarks or registered trademarks of Sun Microsystems, Inc. in the United States, other countries, or both.

Other company, product, or service names may be trademarks or service marks of others.







Part Number: 24P2905  
File Number:

Printed in U.S.A.

(1P) P/N: 24P2905



## Free Manuals Download Website

<http://myh66.com>

<http://usermanuals.us>

<http://www.somanuals.com>

<http://www.4manuals.cc>

<http://www.manual-lib.com>

<http://www.404manual.com>

<http://www.luxmanual.com>

<http://aubethermostatmanual.com>

Golf course search by state

<http://golfingnear.com>

Email search by domain

<http://emailbydomain.com>

Auto manuals search

<http://auto.somanuals.com>

TV manuals search

<http://tv.somanuals.com>