



**@server**  
**BladeCenter**  
Type 8677

# Installation and User's Guide

## Welcome...

This *Installation and User's Guide* contains information for setting up, configuring, and using your BladeCenter unit.

For detailed information about your BladeCenter unit, view the publications on the Documentation CD.

You can also find the most current information about your BladeCenter unit and servers on the IBM Web site at:  
<http://www.ibm.com/pc/support>

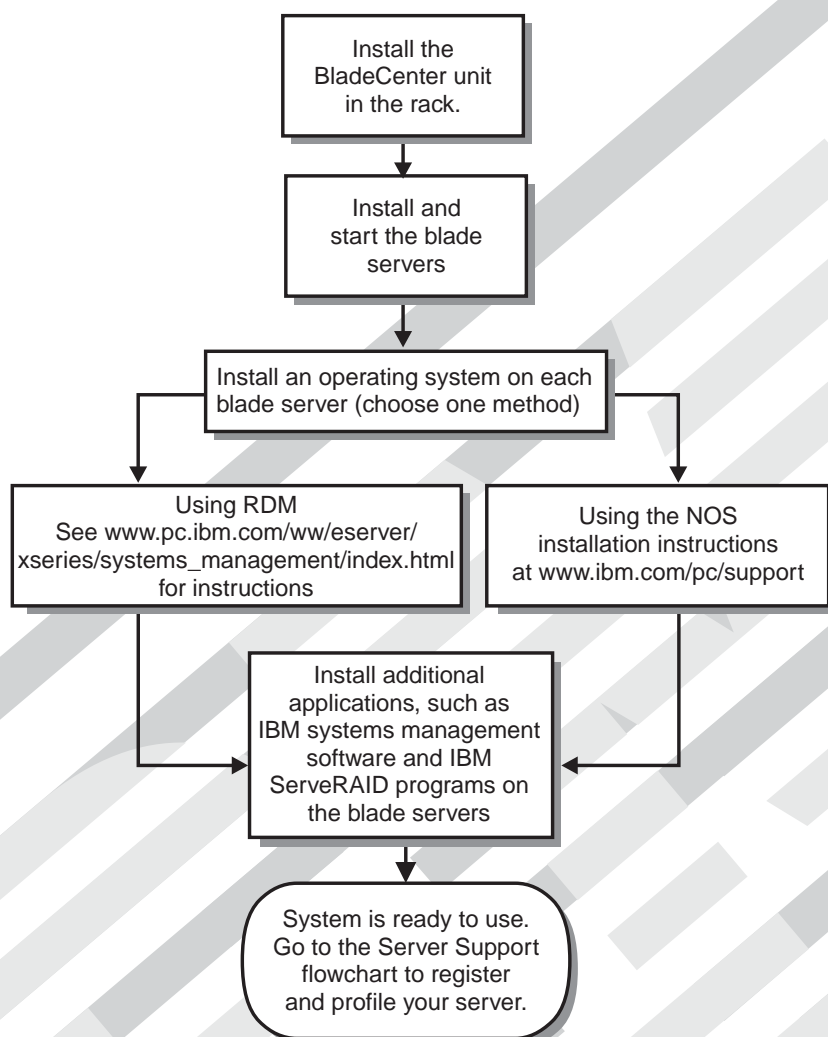

# Server Support

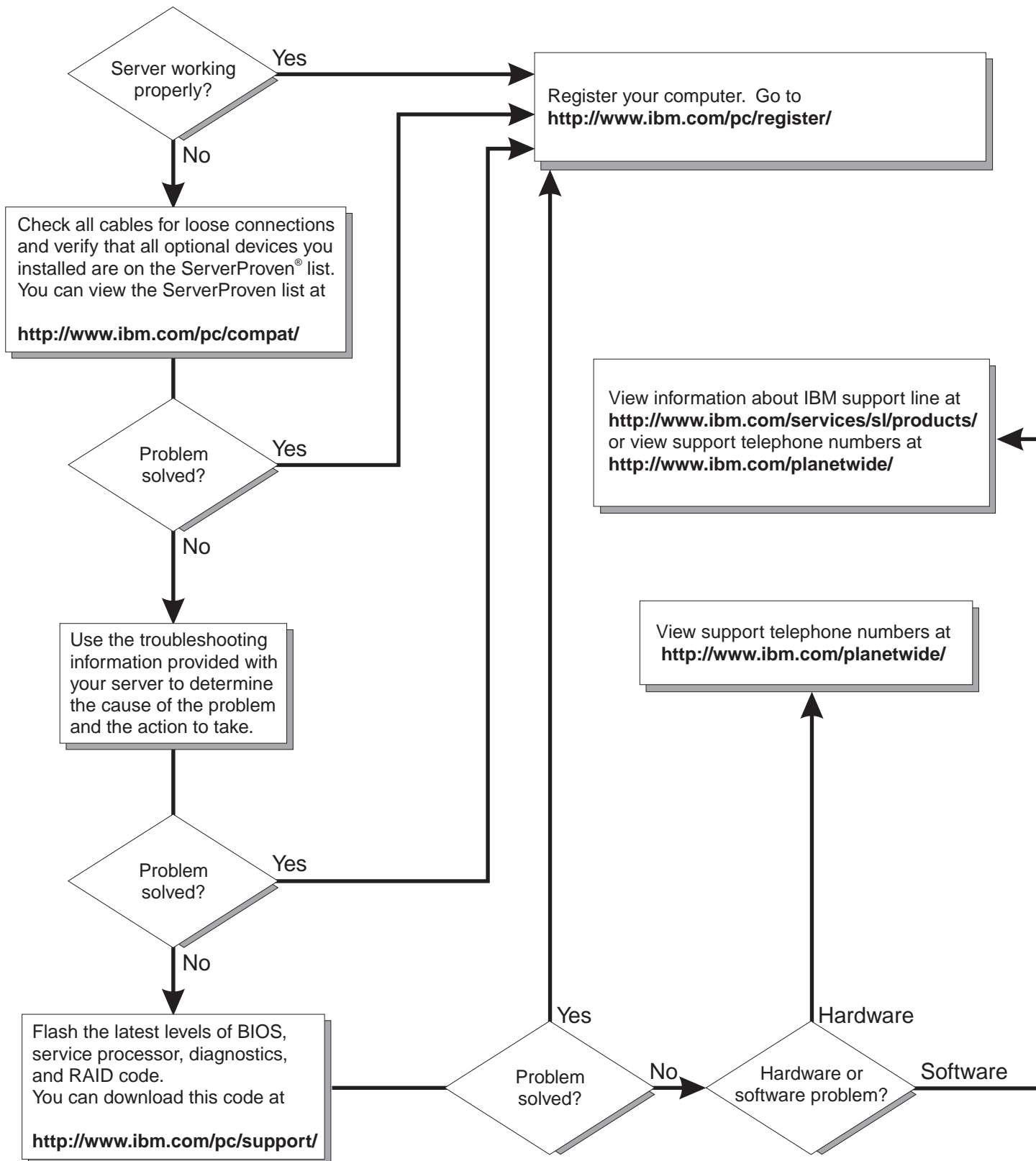



@server

BladeCenter Type 8677

Installation and User's Guide

**Note:**

Before using this information and the product it supports, read the general information in Appendix B, "IBM Statement of Limited Warranty Z125-4753-07 11/2002", on page 61 and Appendix C, "Notices", on page 77.

**Fifth Edition (August 2003)**

© Copyright International Business Machines Corporation 2002, 2003. All rights reserved.

US Government Users Restricted Rights – Use, duplication or disclosure restricted by GSA ADP Schedule Contract with IBM Corp.

---

# Contents

<b>Safety</b> . . . . .	vii
<b>Chapter 1. Introduction</b> . . . . .	1
About your documentation CD . . . . .	3
System requirements . . . . .	3
Starting the IBM Documentation Browser . . . . .	3
Using the IBM Documentation Browser . . . . .	3
Using the search feature . . . . .	4
Related publications . . . . .	4
Features and specifications . . . . .	6
Notices and statements used in this book . . . . .	7
What your BladeCenter unit offers . . . . .	7
Reliability, availability, and serviceability . . . . .	9
Major components of the BladeCenter Type 8677 unit . . . . .	10
Front view . . . . .	11
Rear view . . . . .	11
<b>Chapter 2. Installing options</b> . . . . .	13
Installing the BladeCenter unit in a rack . . . . .	13
Installation guidelines . . . . .	13
System reliability considerations . . . . .	14
Handling static-sensitive devices . . . . .	14
Installing and removing modules . . . . .	15
The BladeCenter modules . . . . .	15
Management module . . . . .	15
I/O modules . . . . .	16
Power modules . . . . .	17
Blower modules . . . . .	18
Installing a module . . . . .	18
Removing a module . . . . .	20
Installing and removing the acoustic module option . . . . .	21
Installing the acoustic module option . . . . .	21
Removing the acoustic module option . . . . .	22
Installing and removing blade servers . . . . .	22
Blade server expansion options . . . . .	23
I/O expansion option . . . . .	23
Storage-expansion option . . . . .	23
Installing a blade server . . . . .	23
Removing a blade server . . . . .	25
Completing the installation . . . . .	26
Input/output connectors . . . . .	26
Video connector . . . . .	27
Keyboard connector . . . . .	27
Mouse connector . . . . .	27
Remote management and console Ethernet connector . . . . .	27
I/O-module connectors . . . . .	28
<b>Chapter 3. BladeCenter unit power, controls, and indicators</b> . . . . .	29
Starting the BladeCenter unit . . . . .	29
Shutting down the BladeCenter unit . . . . .	30
BladeCenter components, controls, and LEDs . . . . .	31
Front view . . . . .	31
Rear view . . . . .	33

Rear system LED panel . . . . .	33
Blower module . . . . .	33
I/O module . . . . .	34
Power module . . . . .	34
Management module. . . . .	35
System LED panel . . . . .	36
<b>Chapter 4. Configuring your BladeCenter unit . . . . .</b>	<b>37</b>
Setting up the remote connection . . . . .	39
Cabling the Ethernet port . . . . .	39
Configuring the management module for remote access. . . . .	39
Communicating with the IBM Director software . . . . .	40
Configuring Wake on LAN in the BladeCenter unit . . . . .	41
Verifying your Wake on LAN configuration . . . . .	41
Linux-specific configuration . . . . .	42
Using the management and configuration program. . . . .	42
Starting the management and configuration program . . . . .	42
Management and configuration program options . . . . .	43
Configuring the external Ethernet port . . . . .	43
Configuring the internal Ethernet port. . . . .	44
Configuring the management port on I/O modules . . . . .	44
Saving and restoring the configuration file . . . . .	44
Using IBM Director . . . . .	45
About the wizard . . . . .	45
Starting the wizard . . . . .	45
Using Remote Deployment Manager Version 4.1 or later . . . . .	46
Configuring a switch module . . . . .	46
What to configure . . . . .	47
Supporting Ethernet failover . . . . .	47
Configuring the Ethernet controllers in the blade servers . . . . .	48
BladeCenter networking guidelines . . . . .	48
<b>Chapter 5. Sharing resources among the blade servers . . . . .</b>	<b>51</b>
<b>Chapter 6. Solving problems . . . . .</b>	<b>53</b>
Diagnostic tools overview . . . . .	53
Troubleshooting charts . . . . .	54
Monitor problems . . . . .	54
Power problems . . . . .	55
Management module problems . . . . .	55
Blower module problems . . . . .	55
Options problems . . . . .	56
Light path diagnostics feature . . . . .	56
Identifying problems using the light path diagnostics feature . . . . .	56
Light path diagnostics LEDs . . . . .	57
<b>Appendix A. Getting help and technical assistance . . . . .</b>	<b>59</b>
Before you call . . . . .	59
Using the documentation . . . . .	59
Getting help and information from the World Wide Web . . . . .	59
Software service and support . . . . .	60
Hardware service and support . . . . .	60
<b>Appendix B. IBM Statement of Limited Warranty Z125-4753-07 11/2002 . . . . .</b>	<b>61</b>
Part 1 - General Terms . . . . .	61
Part 2 - Country-unique Terms . . . . .	64

Part 3 - Warranty Information . . . . .	75
<b>Appendix C. Notices . . . . .</b>	<b>77</b>
Edition notice . . . . .	77
Trademarks . . . . .	78
Important notes. . . . .	78
Product recycling and disposal . . . . .	79
Battery return program . . . . .	79
Electronic emission notices . . . . .	80
Federal Communications Commission (FCC) statement . . . . .	80
Industry Canada Class A emission compliance statement . . . . .	80
Australia and New Zealand Class A statement . . . . .	80
United Kingdom telecommunications safety requirement. . . . .	80
European Union EMC Directive conformance statement. . . . .	80
Taiwanese Class A warning statement . . . . .	81
Chinese Class A warning statement . . . . .	81
Japanese Voluntary Control Council for Interference (VCCI) statement . . . . .	81
Power cords . . . . .	81
<b>Index . . . . .</b>	<b>85</b>





# Safety

Before installing this product, read the Safety Information.

قبل تركيب هذا المنتج، يجب قراءة الملاحظات الأمنية

Antes de instalar este produto, leia as Informações de Segurança.

在安装本产品之前，请仔细阅读 **Safety Information** (安全信息)。

安裝本產品之前，請先閱讀「安全資訊」。

Prije instalacije ovog produkta obavezno pročitajte Sigurnosne Upute.

Před instalací tohoto produktu si přečtěte příručku bezpečnostních instrukcí.

Læs sikkerhedsforskrifterne, før du installerer dette produkt.

Lees voordat u dit product installeert eerst de veiligheidsvoorschriften.

Ennen kuin asennat tämän tuotteen, lue turvaohjeet kohdasta Safety Information.

Avant d'installer ce produit, lisez les consignes de sécurité.

Vor der Installation dieses Produkts die Sicherheitshinweise lesen.

Πριν εγκαταστήσετε το προϊόν αυτό, διαβάστε τις πληροφορίες ασφάλειας (safety information).

לפני שתתקינו מוצר זה, קראו את הוראות הבטיחות.

A termék telepítése előtt olvassa el a Biztonsági előírásokat!

Prima di installare questo prodotto, leggere le Informazioni sulla Sicurezza.

製品の設置の前に、安全情報をお読みください。

본 제품을 설치하기 전에 안전 정보를 읽으십시오.

Пред да се инсталира овој продукт, прочитајте информацијата за безбедност.

Les sikkerhetsinformasjonen (Safety Information) før du installerer dette produktet.

Przed zainstalowaniem tego produktu, należy zapoznać się z książką "Informacje dotyczące bezpieczeństwa" (Safety Information).

Antes de instalar este produto, leia as Informações sobre Segurança.

Перед установкой продукта прочтите инструкции по технике безопасности.

Pred inštaláciou tohto zariadenia si pečítajte Bezpečnostné predpisy.

Pred namestitvijo tega proizvoda preberite Varnostne informacije.

Antes de instalar este producto, lea la información de seguridad.

Läs säkerhetsinformationen innan du installerar den här produkten.

**Statement 1:**



**DANGER**

**Electrical current from power, telephone, and communication cables is hazardous.**

**To avoid a shock hazard:**

- **Do not connect or disconnect any cables or perform installation, maintenance, or reconfiguration of this product during an electrical storm.**
- **Connect all power cords to a properly wired and grounded electrical outlet.**
- **Connect to properly wired outlets any equipment that will be attached to this product.**
- **When possible, use one hand only to connect or disconnect signal cables.**
- **Never turn on any equipment when there is evidence of fire, water, or structural damage.**
- **Disconnect the attached power cords, telecommunications systems, networks, and modems before you open the device covers, unless instructed otherwise in the installation and configuration procedures.**
- **Connect and disconnect cables as described in the following table when installing, moving, or opening covers on this product or attached devices.**

<b>To Connect:</b>	<b>To Disconnect:</b>
1. Turn everything OFF.	1. Turn everything OFF.
2. First, attach all cables to devices.	2. First, remove power cords from outlet.
3. Attach signal cables to connectors.	3. Remove signal cables from connectors.
4. Attach power cords to outlet.	4. Remove all cables from devices.
5. Turn device ON.	

**Statement 2:**



**CAUTION:**

When replacing the lithium battery, use only IBM Part Number 33F8354 or an equivalent type battery recommended by the manufacturer. If your system has a module containing a lithium battery, replace it only with the same module type made by the same manufacturer. The battery contains lithium and can explode if not properly used, handled, or disposed of.

*Do not:*

- Throw or immerse into water
- Heat to more than 100°C (212°F)
- Repair or disassemble

Dispose of the battery as required by local ordinances or regulations.

**Statement 3:**



**CAUTION:**

When laser products (such as CD-ROMs, DVD drives, fiber optic devices, or transmitters) are installed, note the following:

- Do not remove the covers. Removing the covers of the laser product could result in exposure to hazardous laser radiation. There are no serviceable parts inside the device.
- Use of controls or adjustments or performance of procedures other than those specified herein might result in hazardous radiation exposure.



**DANGER**

Some laser products contain an embedded Class 3A or Class 3B laser diode. Note the following.

Laser radiation when open. Do not stare into the beam, do not view directly with optical instruments, and avoid direct exposure to the beam.

Class 1 Laser Product  
Laser Klasse 1  
Laser Klass 1  
Luokan 1 Laserlaite  
Appareil À Laser de Classe 1

**Statement 4:**

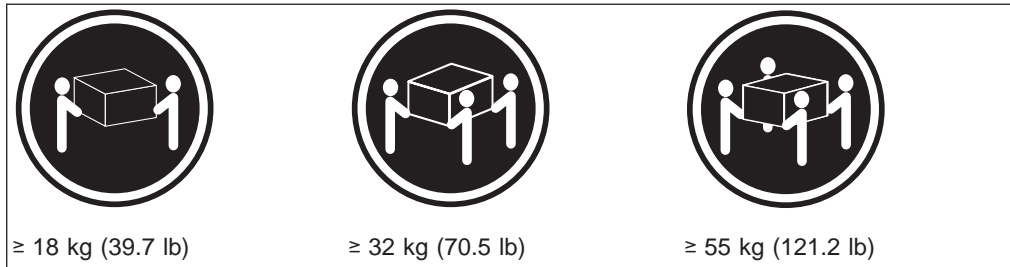

**CAUTION:**  
Use safe practices when lifting.

**Statement 5:**



**CAUTION:**  
The power control button on the device and the power switch on the power supply do not turn off the electrical current supplied to the device. The device also might have more than one power cord. To remove all electrical current from the device, ensure that all power cords are disconnected from the power source.

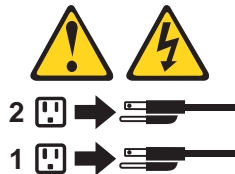

**Statement 8:**



**CAUTION:**

Never remove the cover on a power supply or any part that has the following label attached.



Hazardous voltage, current, and energy levels are present inside any component that has this label attached. There are no serviceable parts inside these components. If you suspect a problem with one of these parts, contact a service technician.

**Statement 12:**



**CAUTION:**

The following label indicates a hot surface nearby.



**Statement 13:**



**DANGER**

Overloading a branch circuit is potentially a fire hazard and a shock hazard under certain conditions. To avoid these hazards, ensure that your system electrical requirements do not exceed branch circuit protection requirements. Refer to the information that is provided with your device for electrical specifications.

**Statement 20:**



**CAUTION:**

To avoid personal injury, before lifting the unit, remove all the blades to reduce the weight.

**Statement 21:**



**CAUTION:**

Hazardous energy is present when the blade is connected to the power source. Always replace the blade cover before installing the blade.

---

## Chapter 1. Introduction

The IBM® eServer BladeCenter™ Type 8677 unit is based on IBM Enterprise X-Architecture™ technologies<sup>1</sup>.

Your BladeCenter unit is a high-density, high-performance rack-mounted server system developed for medium-to-large businesses. It supports up to 14 blade servers, making it ideally suited for networking environments that require a large number of high-performance servers in a small amount of space. The BladeCenter system provides common resources that are shared by the blade servers, such as power, cooling, system management, network connections, and I/O (diskette drive, CD-ROM drive, ports for USB, keyboard, video, mouse, and network interfaces). The use of common resources enables small size in the blade servers, enables minimal cabling, and eliminates resources sitting idle.

Performance, ease of use, reliability, and expansion capabilities were key considerations during the design of your BladeCenter system. These design features make it possible for you to customize the system hardware to meet your needs today, while providing flexible expansion capabilities for the future.

This *Installation and User's Guide* provides information to:

- Set up and cable your BladeCenter unit
- Start and configure your BladeCenter unit
- Install options
- Perform basic troubleshooting of your BladeCenter unit

The latest version of this publication is available from the IBM Support Web site at <http://www.ibm.com/pc/support/>.

Packaged with the *Installation and User's Guide* are software CDs that help you to configure and manage the BladeCenter unit.

This *Installation and User's Guide* and other publications that provide detailed information about your BladeCenter unit are provided in Portable Document Format (PDF) on the IBM *BladeCenter Documentation* CD.

Your BladeCenter unit comes with a three-year limited warranty. You can obtain up-to-date information about your BladeCenter Type 8677 model and other IBM server products at <http://www.ibm.com/eserver/xseries/>.

You can register the BladeCenter unit and blade servers on the World Wide Web. To register, go to: <http://www.ibm.com/pc/register/>.

Record information about your BladeCenter unit in the following table. You will need this information when you register your BladeCenter unit with IBM.

---

1. Enterprise X-Architecture technology takes full advantage of existing IBM technologies to build powerful, scalable, and reliable Intel processor-based servers. For more information about IBM Enterprise X-Architecture, go to <http://www.ibm.com/pc/us/eserver/xseries/xarchitecture/index.html>.

<b>Product name</b>	@server BladeCenter
<b>Machine type</b>	8677
<b>Model number</b>	_____
<b>Serial number</b>	_____

The serial number and model number are on labels on the top, front, and rear of the chassis, as shown in the following illustration.

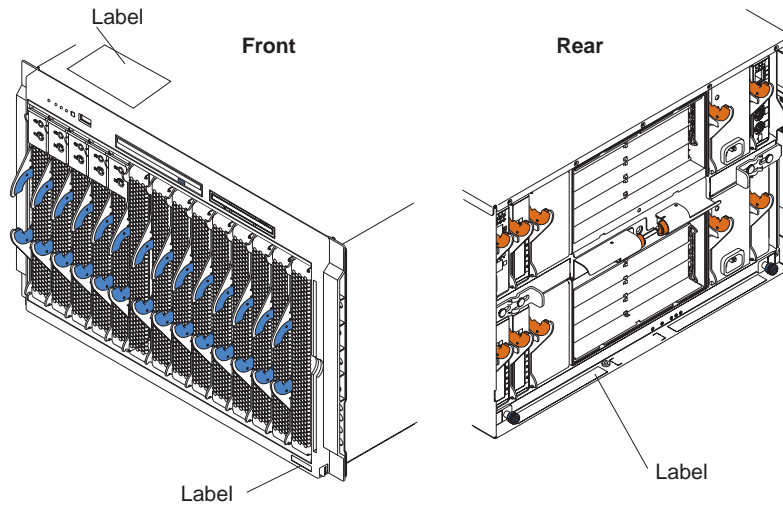

A set of user labels comes with each blade server. Write whatever identifying information you want on a label and place it on the BladeCenter bezel just below the blade server, as shown in the following illustration.

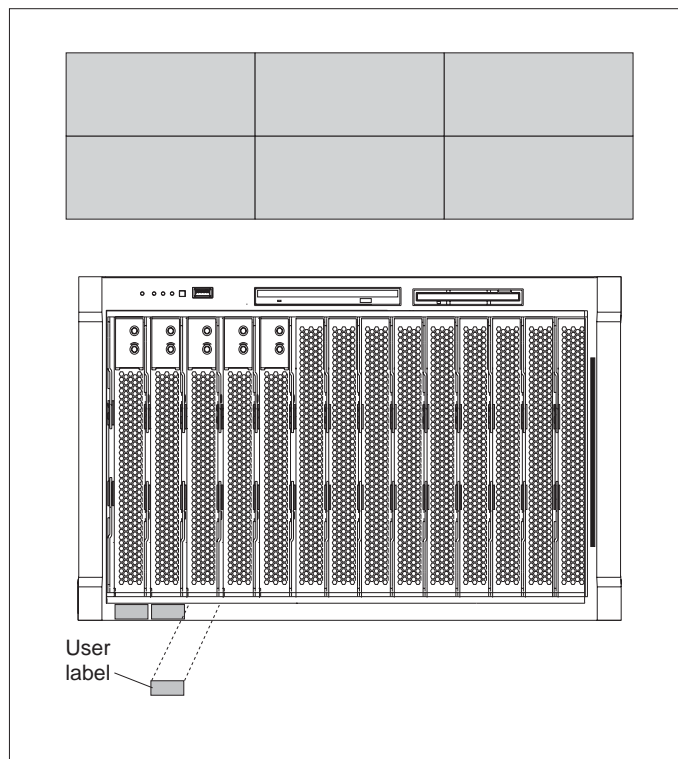

**Important:** Do not place the label on the blade server itself or in any way block the ventilation holes on the blade server.



---

## About your documentation CD

Your IBM BladeCenter unit comes with the IBM *BladeCenter Type 8677 Documentation CD*, which contains documentation for your system in Portable Document Format (PDF) and includes the IBM Documentation Browser to help you find information quickly.

In addition to the documentation CD, your BladeCenter unit comes with the *Rack Installation Instructions*, which contain a rack-installation template and basic instructions for installing your system into a rack.

## System requirements

To run the documentation CD, use a system that has the following minimum hardware and software:

- Microsoft® Windows NT® 4.0 (with Service Pack 3 or later), Windows® 98, or Windows 2000.
- 100 MHz Intel Pentium® microprocessor.
- 32 MB RAM.
- Adobe Acrobat Reader 3.0 or later. Adobe Acrobat Reader software is included on the documentation CD, and you can install it when you run the IBM Documentation Browser.

## Starting the IBM Documentation Browser

Use one of the following procedures to start the Documentation Browser:

- If Autostart is enabled, insert the documentation CD into your CD-ROM drive. The Documentation Browser will start automatically.
- If Autostart is disabled, insert the documentation CD into your CD-ROM drive; then, click **Start --> Run**. In the **Open** field, type  
`e:\win32.bat`  
where *e* is the drive letter of your CD-ROM drive, and click **OK**.

## Using the IBM Documentation Browser

Use the IBM Documentation Browser to browse the contents of the documentation CD, select from a list of available topics, see brief descriptions of the selected topics, and view selected topics using Adobe Acrobat Reader. The Documentation Browser automatically detects the regional settings in use on your system and presents the information in the language for that region (if available). If a topic is not available in the language for that region, the English version is displayed.

Click **Help** for detailed information about using the IBM Documentation Browser.

Complete the following steps to use the Documentation Browser:

1. Select your product from the **Product** drop-down list.  
The **Topics** list appears. It lists all topics that pertain to the selected product. Topics are in folders or under other topics. A plus sign (+) appears beside each folder or topic that has additional topics under it. Click the plus sign to display the additional topics.
2. Click a topic to select it.  
When you select a topic, a description of the topic contents appears in the **Description** field.

**Note:** To select multiple topics, press and hold down the Ctrl key while selecting your topics.

3. View selected topics.

Click **View Book**. Adobe Acrobat Reader starts, and the selected topics are displayed.

## Using the search feature

Complete the following steps to use the Documentation Browser search feature:

1. Type a key word in the **Search** field.
2. Click **Search**. The topics containing the search word are listed in order based on the number of occurrences.
3. Click a file to open it.
4. Press Ctrl+F and use the Adobe Acrobat search function to search within the file.

---

## Related publications

This *Installation and User's Guide* provides general information about your BladeCenter unit, including information about features, how to configure your BladeCenter unit, and how to get help.

In addition to this *Installation and User's Guide*, the following documentation is provided in PDF on the IBM *BladeCenter Documentation* CD that comes with your BladeCenter unit:

- *Safety Information*: This publication contains translated caution and danger statements. Each caution and danger statement that appears in the documentation has a number that you can use to locate the corresponding statement in your language in the *Safety Information* book.
- *BladeCenter HS20 Installation and User's Guide* for each blade server type: This publication contains instructions for setting up a BladeCenter HS20 blade server and basic instructions for installing some options. It also contains general information about the blade server.
- *BladeCenter HS20 Hardware Maintenance Manual and Troubleshooting Guide* for each blade server type: This publication contains the information to help you solve BladeCenter HS20 problems yourself, and it contains information for service technicians.
- *@server BladeCenter Type 8677 Hardware Maintenance Manual and Troubleshooting Guide*: This publication contains the information to help you solve BladeCenter problems yourself, and it contains information for service technicians.
- *@server BladeCenter Type 8677 Rack Installation Instructions*: This publication contains instructions for installing the BladeCenter unit in a rack.
- *Installation and User's Guide* for each BladeCenter option, such as a switch module: This publication usually contains instructions for setting up and configuring the option and a description of the option features.
- *IBM BladeCenter Management Module User's Guide*: This publication contains instructions for using the Web interface to configure the management modules in a BladeCenter.
- *IBM BladeCenter Management Module Installation Guide*: This publication contains instructions for installing an IBM BladeCenter management module option in a BladeCenter unit and creating the initial configuration.

Additional publications might be included on the IBM *BladeCenter Documentation* CD.

## Features and specifications

The following table provides a summary of the features and specifications for your BladeCenter unit.

Table 1. Features and specifications

<p><b>Media tray (on front):</b></p> <ul style="list-style-type: none"> <li>• Diskette drive: 1.44 MB</li> <li>• CD-ROM drive: IDE</li> <li>• Universal Serial Bus (USB) v1.1 port</li> <li>• Front system LED panel</li> </ul> <p><b>Module bays (on rear):</b></p> <ul style="list-style-type: none"> <li>• Four hot-swap 220-volt power-module bays</li> <li>• Two hot-swap management-module bays</li> <li>• Four hot-swap I/O-module bays</li> <li>• Two hot-swap blower bays</li> </ul> <p><b>Blade bays (on front):</b></p> <p>14 hot-swap blade bays</p> <p><b>Redundant cooling:</b></p> <p>Two variable-speed hot-swap blowers</p> <p><b>Power modules:</b></p> <ul style="list-style-type: none"> <li>• Standard: Two 1200-watt or greater 220-volt (200-240 V ac) hot-swap power modules             <ul style="list-style-type: none"> <li>– Both power modules supply 12 V power to all modules and to blade bays 1 through 6</li> <li>– Both power modules provide redundancy to each other</li> </ul> </li> <li>• Maximum: Four             <ul style="list-style-type: none"> <li>– Power modules 1 and 2 supply 12 V to all modules and to blade bays 1 through 6</li> <li>– Power modules 3 and 4 supply 12 V to blade bays 7 through 14</li> <li>– Power modules 1 and 2 provide redundancy to each other</li> <li>– Power modules 3 and 4 provide redundancy to each other</li> </ul> </li> </ul>	<p><b>I/O modules:</b></p> <ul style="list-style-type: none"> <li>• Standard: None</li> <li>• Maximum: Four</li> </ul> <p><b>Management module:</b></p> <ul style="list-style-type: none"> <li>• Standard: One hot-swap management module providing the following features:             <ul style="list-style-type: none"> <li>– System-management functions for the BladeCenter system</li> <li>– Video port (analog)</li> <li>– PS/2<sup>®</sup> keyboard port</li> <li>– PS/2 mouse port</li> <li>– 10/100 Mb Ethernet remote management connection</li> </ul> </li> <li>• Maximum: Two hot-swap management modules: one active, one redundant</li> </ul> <p><b>Upgradeable microcode:</b></p> <ul style="list-style-type: none"> <li>• Management module firmware</li> <li>• I/O module firmware (not all I/O module types)</li> <li>• Blade server service processor firmware</li> </ul> <p><b>Security features:</b></p> <ul style="list-style-type: none"> <li>• Login password for remote connection</li> <li>• Secure socket layer (SSL) security for remote management access</li> </ul> <p><b>Predictive Failure Analysis<sup>®</sup> (PFA) alerts:</b></p> <ul style="list-style-type: none"> <li>• Blowers</li> <li>• Blade-dependent features</li> </ul> <p><b>Size (7U):</b></p> <ul style="list-style-type: none"> <li>• Height: 304.2 mm (12 in. or 7 U)</li> <li>• Depth: 711.2 mm (28 in.)</li> <li>• Width: 444 mm (17.5 in.)</li> <li>• Weight:             <ul style="list-style-type: none"> <li>– Fully configured with modules and blades: Approx. 108.86 kg (240 lb)</li> <li>– Fully configured without blades: Approx. 44.91 kg (99 lb)</li> </ul> </li> </ul>	<p><b>Acoustical noise emissions:</b></p> <ul style="list-style-type: none"> <li>• Without acoustics module option:             <ul style="list-style-type: none"> <li>– Sound power, idle: 7.4 bels maximum</li> <li>– Sound power, operating: 7.4 bels maximum</li> </ul> </li> <li>• With acoustics module option:             <ul style="list-style-type: none"> <li>– Sound power, idle: 6.9 bels maximum</li> <li>– Sound power, operating: 6.9 bels maximum</li> </ul> </li> </ul> <p><b>Environment:</b></p> <ul style="list-style-type: none"> <li>• Air temperature:             <ul style="list-style-type: none"> <li>– BladeCenter unit on: 10° to 35°C (50° to 95°F). Altitude: 0 to 914 m (2998.69 ft)</li> <li>– BladeCenter unit on: 10° to 32°C (50° to 89.6°F). Altitude: 914 m to 2134 m (2998.69 ft to 7000 ft)</li> <li>– BladeCenter off: -40° to 60° C (-40° to 140° F).</li> </ul> </li> <li>• Humidity:             <ul style="list-style-type: none"> <li>– Server on: 8% to 80%</li> <li>– Server off: 8% to 80%</li> </ul> </li> </ul> <p><b>Electrical input:</b></p> <ul style="list-style-type: none"> <li>• Sine-wave input (50-60 Hz single-phase) required</li> <li>• Input voltage:             <ul style="list-style-type: none"> <li>– Minimum: 200 V ac</li> <li>– Maximum: 240 V ac</li> </ul> </li> </ul> <p><b>Heat output:</b></p> <p>Approximate heat output in British thermal units (Btu) per hour</p> <ul style="list-style-type: none"> <li>• Minimum configuration: 1365 Btu/hour (400 watts)</li> <li>• Maximum configuration: Varies depending on the type of power supplies installed.             <ul style="list-style-type: none"> <li>– Four 1200-watt power supplies: 9622 Btu/hour (2820 watts)</li> <li>– Four 1400-watt power supplies: 11111 Btu/hour (3256 watts)</li> </ul> </li> </ul> <p>For all other power supplies, see the documentation that comes with the power supply.</p>
--	--	---

### Notes:

1. For details about the BladeCenter unit port specifications, see "Input/output connectors" on page 26.
2. For information about which types of I/O modules can be installed in which I/O-module bays, see "I/O modules" on page 16.
3. The operating system in the blade server must provide USB support for the blade server to recognize and use the keyboard, mouse, CD-ROM drive, and diskette drive. The BladeCenter unit uses USB for internal communication with these devices.

---

## Notices and statements used in this book

The caution and danger statements that appear in this book are also in the multilingual *Safety Information* book, which is on the IBM *BladeCenter Documentation* CD. Each statement is numbered for reference to the corresponding statement in the *Safety Information* book.

The following notices and statements are used in the documentation:

- **Note:** These notices provide important tips, guidance, or advice.
- **Important:** These notices provide information or advice that might help you avoid inconvenient or problem situations.
- **Attention:** These notices indicate possible damage to programs, devices, or data. An attention notice is placed just before the instruction or situation in which damage could occur.
- **Caution:** These statements indicate situations that can be potentially hazardous to you. A caution statement is placed just before the description of a potentially hazardous procedure step or situation.
- **Danger:** These statements indicate situations that can be potentially lethal or extremely hazardous to you. A danger statement is placed just before the description of a potentially lethal or extremely hazardous procedure step or situation.

---

## What your BladeCenter unit offers

The design of your BladeCenter unit takes advantage of advancements in server technology. It provides up to 14 functionally separate servers and their shared resources in a single center. Your BladeCenter unit combines:

- **IBM Enterprise X-Architecture technology**

IBM Enterprise X-Architecture technology leverages proven innovative IBM technologies to build powerful, scalable, reliable Intel-processor-based servers. Enterprise X-Architecture technology includes features such as Predictive Failure Analysis (PFA), scalability, and Real Time Diagnostics.

- **Expansion capabilities**

You can add blade servers to the BladeCenter unit as needed, up to a maximum of 14 blade servers.

**Note:** When any blade server or option is in blade bay 7 through 14, power modules must be present in power bays 1 and 2, *and* power modules must be present in power bays 3 and 4.

Some blade servers have connectors for options that add capabilities to the blade server, such as an I/O expansion card to add a network interface, or a storage expansion unit to add SCSI hard disk drives.

- **Hot-swap capabilities**

The front bays on the BladeCenter unit are hot-swap blade bays; the rear bays on the BladeCenter unit are hot-swap module bays. You can add, remove, or replace blade servers or management, I/O, power, or blower modules in hot-swap bays without removing power from the BladeCenter unit.

**Attention:** To maintain proper system cooling, each unoccupied bay must contain a filler blade or filler module.

- **Redundancy capabilities**

The redundant components in the rear of your BladeCenter unit enable continued operation if one of the components fails.

- Power modules and blowers: Normally, the redundant power modules and blowers share the load. If one of the power modules or blowers fails, the non-failing power module or blower handles the entire load. You can then replace the failed blower or power module without shutting down the BladeCenter unit.
- Management modules: Only one management module will be active at a time. If the active management module fails, the secondary, or redundant, management module becomes the active management module, containing current BladeCenter configuration and status information. You can then replace the failed management module without shutting down the BladeCenter unit.

- **Redundant network connection capabilities**

Configuring a pair of Ethernet switch modules in I/O-module bays 1 and 2 identically provides support for Ethernet failover configured on blade servers. See “Configuring a switch module” on page 46 for more information. If the I/O expansion options in your blade servers can be configured for failover, configuring a pair of switch modules in I/O-module bays 3 and 4 identically provides support for the failover configured on the I/O expansion options.

Other network-interface I/O expansion options, such as the IBM HS20 Fibre Channel Expansion Card, can have similar capability for redundant network connections. See the documentation that comes with your I/O expansion and switch module options for more information about configuring for redundant network connections.

- **System-management capabilities**

Your BladeCenter unit comes with a service processor in the management module. This service processor, in conjunction with the system-management firmware that is provided with your BladeCenter unit and the service processor in each blade server, enables you to remotely manage the BladeCenter unit, its components, and the blade servers. The management module also multiplexes the keyboard, mouse, and video ports and the USB port across the multiple blade servers.

The service processor in each blade server provides blade server system monitoring, event recording, and alert capability.

See Chapter 4, “Configuring your BladeCenter unit”, on page 37 for more information.

- **Network environment support**

Your BladeCenter unit supports up to two Ethernet-compatible I/O modules (switch modules or pass-thru modules), for blade server integrated Ethernet controller communication with the network. Each I/O module provides one internal connection to each blade server, up to 14 internal connections per I/O module.

The BladeCenter unit also supports two additional I/O modules, for a total of four I/O modules. The two additional I/O modules support the network interface on the optional I/O expansion card installed on one or more blade servers in the BladeCenter unit.

**Note:** The two additional I/O modules must be compatible with the network interface on the optional I/O expansion cards in the blade servers.

Each of these two additional I/O modules provides one internal connection to the optional I/O expansion card, up to 14 internal connections per I/O module.

---

## Reliability, availability, and serviceability

Three of the most important features in server design are reliability, availability, and serviceability (RAS). These factors help to ensure the integrity of the data stored on your blade server; that your blade server is available when you want to use it; and that should a failure occur, you can easily diagnose and repair the failure with minimal inconvenience.

The following is a list of some of the RAS features that your BladeCenter unit supports:

- Shared key components, such as power, cooling, and I/O
- All components serviced from the front or rear of the chassis
- Automatic error retry and recovery
- Automatic restart after a power failure
- Built-in monitoring for blower, power, temperature, and voltage
- Built-in monitoring for module redundancy
- Customer support center 24 hours a day, 7 days a week<sup>2</sup>
- Error codes and messages
- Fault-resistant startup
- Remote system management through the management module
- Remote management module firmware upgrade
- Remote upgrade of blade server service processor microcode
- Built-in self-test (BIST)
- Predictive Failure Analysis (PFA) alerts
- Redundant components
  - Cooling fans (blowers) with speed-sensing capability
  - Power modules
  - Management modules
- Hot-swap components
  - Cooling fans (blowers) with speed-sensing capability
  - Power modules
  - Management module
  - I/O modules
  - Blade servers
  - Media tray
- System automatic inventory at startup
- System error logging

---

2. Service availability will vary by country. Response time varies; may exclude holidays.

---

## Major components of the BladeCenter Type 8677 unit

The following illustration shows the locations of major components in your BladeCenter unit.

**Note:** The illustrations in this document might differ slightly from your hardware.

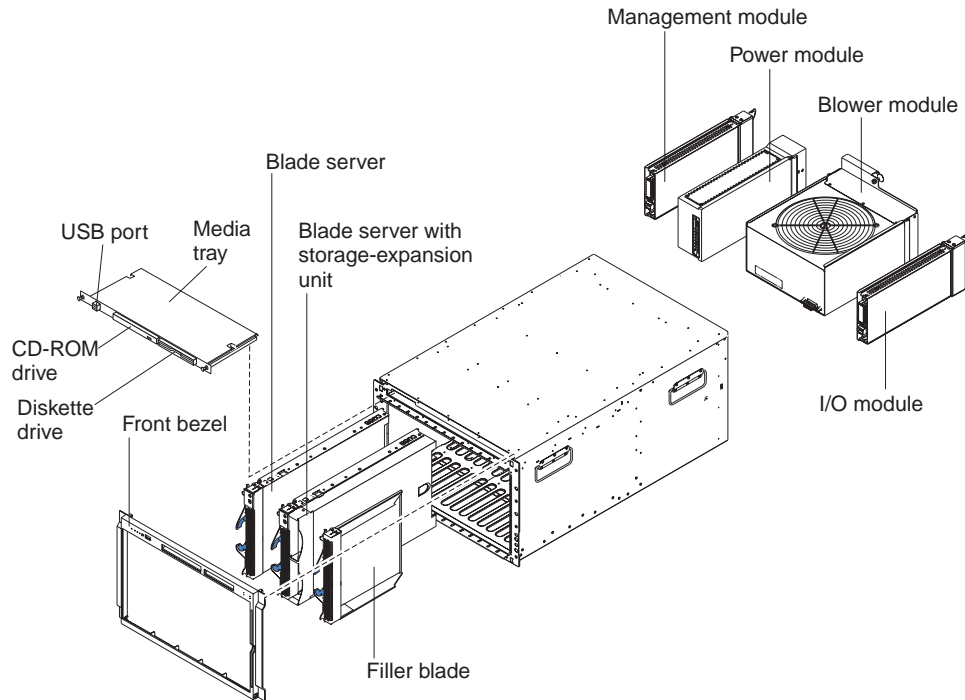

**Attention:** To maintain proper system cooling, each module bay must contain either a module or a filler module; each blade bay must contain either a blade server or a filler blade.



## Front view

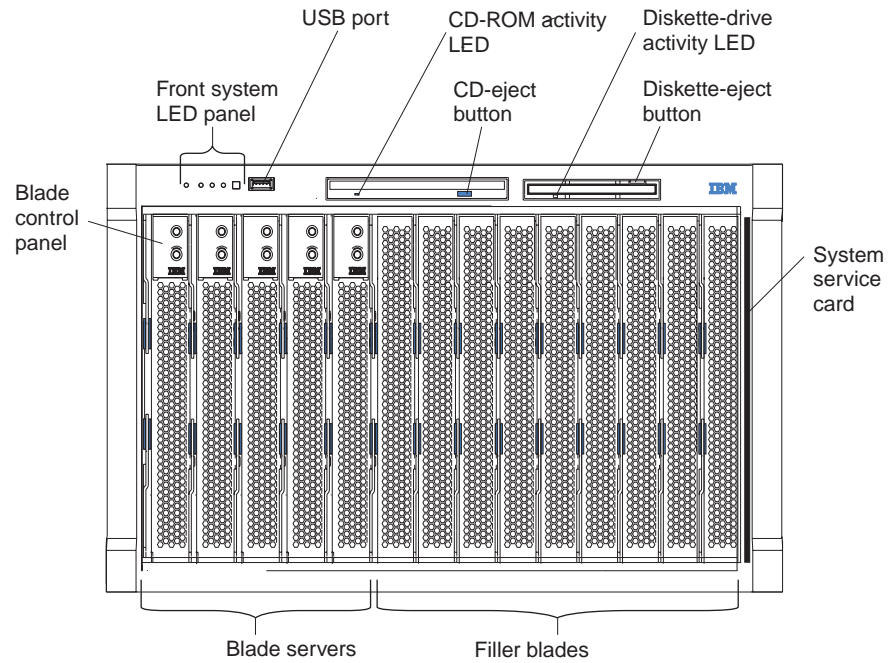

See Chapter 3, “BladeCenter unit power, controls, and indicators”, on page 29 for details about these components and indicators.

## Rear view

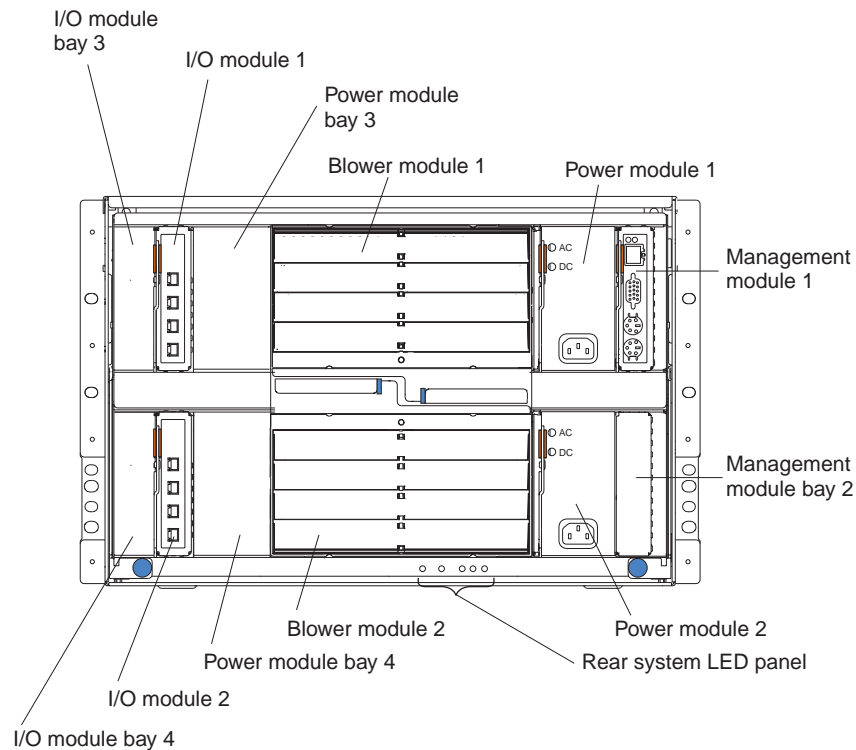

See Chapter 3, “BladeCenter unit power, controls, and indicators”, on page 29 for details about these components and indicators.



---

## Chapter 2. Installing options

This chapter provides instructions for adding options to your BladeCenter unit. Some option-removal instructions are provided in case you need to remove one option to install another.

---

### Installing the BladeCenter unit in a rack

Statement 20:



**CAUTION:**

To avoid personal injury, before lifting the unit, remove all the blades to reduce the weight.

Statement 4:

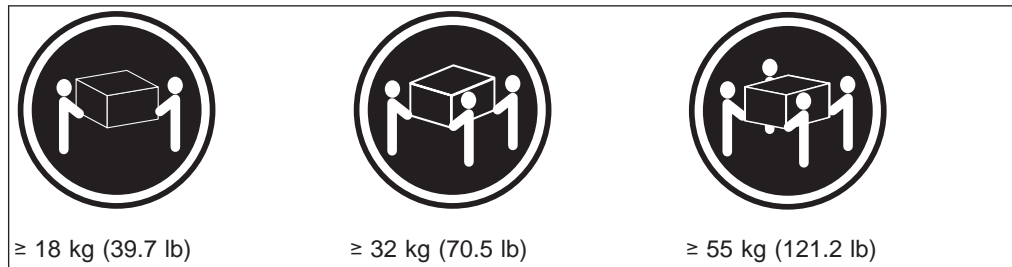

**CAUTION:**

Use safe practices when lifting.

Install the BladeCenter unit in a rack before installing any blade servers in the BladeCenter unit. If your BladeCenter unit has blade servers already installed, remove them first. Blade servers are installed from the front of the BladeCenter unit, without sliding the BladeCenter unit into or out of the rack. Detailed instructions for installing a BladeCenter unit in a rack are in the *Rack Installation Instructions* that come with your BladeCenter unit.

---

### Installation guidelines

Before you begin to install options in your BladeCenter unit, read the following information:

- Read the safety information beginning on page vii and the guidelines in “Handling static-sensitive devices” on page 14. This information will help you work safely with your BladeCenter unit and options.
- The orange color on components and labels in your BladeCenter unit identifies hot-swap components. You can install or remove hot-swap modules and, with

some restrictions, hot-swap blade servers while the BladeCenter unit is running. For complete details about installing or removing a hot-swap component, see the detailed information in this chapter.

- The blue color on components and labels identifies touch points where you can grip a component, move a latch, and so on.
- You do not need to disconnect the BladeCenter unit from power to install or replace any of the hot-swap modules on the rear of the BladeCenter unit. You need to shut down the operating system and turn off a hot-swap blade server on the front of the BladeCenter unit before removing the blade server, but you do not need to shut down the BladeCenter unit itself.
- For a list of supported options for your BladeCenter unit, go to <http://www.ibm.com/pc/compat/> on the World Wide Web.

## System reliability considerations

To help ensure proper cooling and system reliability, make sure that:

- Each of the module bays on the rear of the BladeCenter unit has either a module or filler module installed.
- Each of the blade bays on the front of the BladeCenter unit has either a blade server or filler blade installed.
- Each of the drive bays in a blade server storage expansion option has either a hot-swap drive or a filler panel installed.
- A removed hot-swap module, blade server, or drive is replaced within 1 minute of removal.
- Cables for the option modules are routed according to the illustrations and instructions in this document.
- A failed blower is replaced as soon as possible, to restore cooling redundancy.

## Handling static-sensitive devices

**Attention:** Static electricity can damage electronic devices and your system. To avoid damage, keep static-sensitive devices in their static-protective packages until you are ready to install them.

To reduce the possibility of electrostatic discharge, observe the following precautions:

- Limit your movement. Movement can cause static electricity to build up around you.
- Handle the device carefully, holding it by its edges or its frame.
- Do not touch solder joints, pins, or exposed printed circuitry.
- Do not leave the device where others can handle and damage it.
- While the device is still in its static-protective package, touch it to an unpainted metal part of the system unit for at least 2 seconds. This drains static electricity from the package and from your body.
- Remove the device from its package and install it directly into the system unit without setting the device down. If it is necessary to set down the device, place it back into its static-protective package. Do not place the device on your system unit or on a metal surface.
- Take additional care when handling devices during cold weather. Heating reduces indoor humidity and increases static electricity.

---

## Installing and removing modules

The procedures for installing or removing a module on the BladeCenter unit are nearly identical for all modules except the blower modules. To install or remove a blower module, see the BladeCenter *Hardware Maintenance Manual and Troubleshooting Guide* on the *BladeCenter Documentation CD*. To install or remove all other modules, follow the instructions in this section.

Each module is keyed so that it can be inserted only in an appropriate bay. You can insert an I/O module only in an I/O-module bay, for example. In addition, most modules must be installed in a specific sequence or under specific circumstances.

## The BladeCenter modules

Your BladeCenter unit contains the following hot-swap modules: power modules, I/O modules, management modules, and blower modules. See “Rear view” on page 33 for the location of each module. These modules supply common functions to the blade servers that are installed in the blade bays in the front of the BladeCenter unit.

The chassis and the active management module supply I/O (diskette drive, CD-ROM drive, USB port, keyboard, video, and mouse) that is available to all the blade servers, selected by any one blade server at a time. The chassis can contain up to 14 blade servers.

**Attention:** To help ensure proper cooling, performance, and system reliability, make sure that each of the module bays on the rear of the BladeCenter unit has a module or filler module installed. When replacing a module, do not operate the BladeCenter unit for more than one minute without either a module or a filler module installed in each module bay.

### Management module

Your BladeCenter unit comes with one hot-swap management module in the management bay. You can add a management module in management bay 2.

**Note:** Only one management module will be active; the second management module, if present, provides redundancy.

The management module functions as a service processor and a keyboard/video/mouse (KVM) multiplexor for the multiple blade servers. The management module also configures the BladeCenter unit and modules, configuring information such as switch module IP addresses. The management module provides the following external connections: keyboard, mouse, and video for use by a local console, and one RJ-45 connector for a 10/100 Mbps Ethernet remote management connection.

The service processor in the management module communicates with the service processor in each blade server for functions such as:

- Blade server power-on requests
- Blade server error and event reporting
- Blade server requests for keyboard, mouse, and video
- Blade server requests for diskette drive, CD-ROM drive, and USB port

The management module also communicates with the I/O modules, power modules, blower modules, and blade servers to detect presence or absence and any error conditions, sending alerts when required.

## I/O modules

For blade server communication with the network, your BladeCenter unit supports from one to four hot-swap I/O modules. Table 2 identifies the type of I/O module you can install in each I/O-module bay. Go to the IBM Support Web site at <http://www.ibm.com/pc/support/> to see the list of supported I/O modules.

Your BladeCenter unit supports a minimum of one hot-swap Ethernet switch module or pass-thru module, in I/O-module bay 1 or 2. This I/O module provides an internal connection to an integrated Ethernet controller in all the blade servers in the BladeCenter unit, up to 14 internal connections per I/O module. To provide an internal connection for the second integrated Ethernet controller in each blade server, install an Ethernet switch module or pass-thru module in the available I/O-module bay of the pair (I/O-module bay 1 or bay 2).

Similarly, the BladeCenter unit supports two additional I/O modules in I/O-module bays 3 and 4. Each of these I/O modules provides an internal connection to one of the two network-interface controllers on all the I/O expansion options installed on blade servers in the BladeCenter unit. The I/O module must be compatible with the network interface on all the I/O expansion options. For example, if you install a Fibre Channel I/O expansion option on a blade server, the I/O modules you install in I/O-module bays 3 and 4 must be Fibre Channel switch modules or pass-thru modules.

### Notes:

1. Because of electromagnetic interference (EMI), no more than two four-port 1-Gb Ethernet switch modules can be installed in the BladeCenter unit. You can mix four-port 1-Gb Ethernet switch modules with other supported Ethernet switch modules to achieve the total number of Ethernet switch modules you need in the BladeCenter unit.
2. You can use a pass-thru module in any I/O-module bay, provided the associated controller in the blade servers or I/O expansion options is compatible with it.

The following table summarizes the types of modules that can be used in each I/O-module bay. See "Rear view" on page 33 for the location of the I/O-module bays on the BladeCenter unit.

Table 2. Hot-swap I/O module types by location

Bays	I/O-module function	Permissible I/O module
1 and 2	Network connections 1 and 2 (Ethernet) for all blade servers in the BladeCenter unit	One of the following combinations: <ul style="list-style-type: none"><li>• Two Ethernet switch modules</li><li>• Two pass-thru modules</li><li>• One Ethernet switch module and one pass-thru module</li></ul>
3 and 4	Network connections 3 and 4 (for all I/O expansion options on blade servers in the BladeCenter unit)	One of the following combinations. <ul style="list-style-type: none"><li>• Two Ethernet switch modules</li><li>• Two Fibre Channel switch modules</li><li>• Two pass-thru modules</li></ul> <b>Important:</b> <ul style="list-style-type: none"><li>• The modules used must support the network interface used on the I/O expansion options.</li><li>• The I/O modules in bays 3 and 4 must be the same type.</li></ul>

### Notes:

1. The enumeration of the Ethernet controllers in a blade server is operating-system dependent. You can verify the Ethernet controller designations a blade server uses through your operating system settings.
2. The routing of an Ethernet controller to a particular I/O-module bay depends on the type of blade server. You can verify which Ethernet controller is routed to which I/O-module bay by using the following test:
  - a. Install only one Ethernet switch module or pass-thru module, in I/O-module bay 1.
  - b. Make sure the ports on the switch module or pass-thru module are enabled (**I/O Module Tasks** → **Management** → **Advanced Management** in the management module Web-based user interface).
  - c. Enable only one of the Ethernet controllers on the blade server. Note the designation the blade server operating system has for the controller.
  - d. Ping an external computer on the network connected to the switch module or pass-thru module.

If you can ping the external computer, the Ethernet controller you enabled is associated with the I/O module in I/O-module bay 1. The other Ethernet controller in the blade server is associated with the I/O module in I/O-module bay 2.

3. If you have installed an I/O expansion option on a blade server, communications from the option are routed to I/O-module bays 3 and 4. You can verify which controller on the option is routed to which I/O-module bay by performing the test in note 2, using a controller on the I/O expansion option and a compatible switch module or pass-thru module in I/O bay 3 or 4.

### Power modules

Your BladeCenter unit comes with one pair of 220-volt hot-swap power modules in power bays 1 and 2 that provides power to all the BladeCenter modules and to blade bays 1 through 6. The BladeCenter unit supports a second pair of power modules in power bays 3 and 4 that provides power to blade bays 7 through 14.

The following table summarizes the application for each power module.

Bays	Power module function
1 and 2	Provides power to all the BladeCenter modules and to blade bays 1 through 6
3 and 4	Provides power to blade bays 7 through 14

Power modules are not needed in bays 3 and 4 until you begin installing blade servers and options in blade bays 7 through 14.

**Note:** If you install a blade server that has a storage expansion unit option attached in blade bay 6, the option will use blade bay 7; power modules will be required in power bays 1, 2, 3 and 4.

Each active power module supplies 12 volts of power to the blade bays it services.

**Important:** Plug one end of each power-module power cord into the power module; plug the other end of the power cord into a 220-volt power distribution unit (PDU).

Each pair of power modules is redundant. If either power module fails, the remaining power module continues to supply power, but there is no redundancy; the failed power module must be replaced as soon as possible.

**Important:**

1. The power modules in a pair must match each other in capacity (wattage, amperage, and so forth).
2. In a pair of power modules, a power module that is not connected to an ac power source creates a non-redundant condition.

To provide true redundant power, BladeCenter power modules 1 and 3 must connect to a different ac power source than power modules 2 and 4. Connect BladeCenter power modules 1 and 3 to a different PDU than power modules 2 and 4; then, connect each PDU to an ac power source (building power source or service entrance) that is controlled by a separate circuit breaker.

**Blower modules**

Your BladeCenter unit comes with two hot-swap blowers for cooling redundancy. The blower speeds vary depending on the ambient air temperature at the front of the BladeCenter. If the ambient temperature is 72°F or below, the BladeCenter blowers will run at 30% of their maximum rotational speed, increasing their speed as required to control internal BladeCenter temperature. If the ambient temperature is above 72°F, the blowers will run at 80% of their maximum rotational speed, increasing their speed as required to control internal BladeCenter temperature. If a blower fails, the remaining blower continues to cool the BladeCenter unit and blade servers.

**Important:** Replace a failed blower as soon as possible, to restore cooling redundancy (see the *Hardware Maintenance Manual and Troubleshooting Guide* on the *BladeCenter Documentation CD* for instructions).

## Installing a module

The following illustration shows how to install a power module, management module, or I/O module in the rear of the BladeCenter unit. See the *Hardware Maintenance Manual and Troubleshooting Guide* on the *BladeCenter Documentation CD* for information about replacing a blower module.

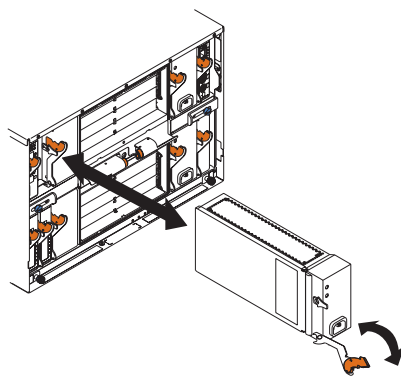

Before you begin, read the documentation that comes with your option.



**Statement 8:**



**CAUTION:**

**Never remove the cover on a power supply or any part that has the following label attached.**



**Hazardous voltage, current, and energy levels are present inside any component that has this label attached. There are no serviceable parts inside these components. If you suspect a problem with one of these parts, contact a service technician.**

Complete the following steps to install a module:

**Note:** These instructions assume the BladeCenter unit is connected to power.

1. Read the safety information beginning on page vii and “Installation guidelines” on page 13 through “Handling static-sensitive devices” on page 14.
2. Remove the acoustic module option, if installed, from the rear of the BladeCenter unit. See “Installing and removing the acoustic module option” on page 21 for instructions.
3. Remove the filler module from the bay.
4. Ensure that the release lever on the module is in the open position (perpendicular to the module).
5. Slide the module into the appropriate module bay until it stops.
6. Push the release lever on the front of the module closed.
7. Attach any cables or cords required by the module. See “Input/output connectors” on page 26 for the location of connectors on the BladeCenter unit. Be sure to route the power cord on a power module through the strain-relief clamp on the power module.
8. Make sure the LEDs on the module indicate that it is operating properly. Verify that:
  - The dc power LED and the ac power LED on each power module are lit.
  - The OK LED on the management module is lit.
  - The OK LED on each I/O module is lit.
9. If you have other modules to install, do so now; otherwise, go to step 10.
10. Replace the acoustic module option, if you removed it in step 2.

## Removing a module

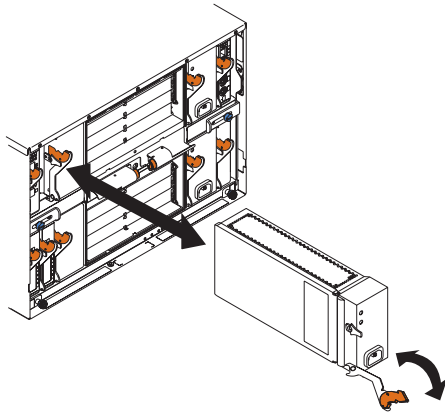

Complete the following steps to remove a power module, management module, or I/O module. See the *Hardware Maintenance Manual and Troubleshooting Guide* on the *BladeCenter Documentation CD* for information about replacing a blower module.

**Note:** These instructions assume the BladeCenter unit is connected to power.

### Statement 8:



### CAUTION:

Never remove the cover on a power supply or any part that has the following label attached.



**Hazardous voltage, current, and energy levels are present inside any component that has this label attached. There are no serviceable parts inside these components. If you suspect a problem with one of these parts, contact a service technician.**

1. Read the safety information beginning on page vii and “Installation guidelines” on page 13 through “Handling static-sensitive devices” on page 14.
2. Remove the acoustic module option, if installed, from the rear of the BladeCenter unit. See “Installing and removing the acoustic module option” on page 21 for instructions.

### Important:

- a. If you are removing a functional power module, make sure before you remove the module that both the ac power LED and the dc power LED on the remaining power module are lit; otherwise, shut down the operating systems and turn off all blade servers that are supported by the power

- module you are removing before you remove it. (See the documentation that comes with the blade server for instructions for shutting down the blade server operating system and turning off the blade server.)
- b. If you are removing a management module, you might prefer to stop all management module local and remote sessions before proceeding, to avoid unexpected termination of sessions.
3. Disconnect any cables from the module. For a power module, disconnect the power cord from the module.
  4. Pull the release lever all the way toward the bottom of the module until it stops, as shown in the illustration. The module moves out of the bay approximately 0.6 cm (0.25 inch).
  5. Slide the module out of the bay and set it aside. Within 1 minute, place either another module of the same type or a filler module in the bay.
  6. If you placed another module in the bay, reconnect any cables or power cords you disconnected in step 3; then, make sure the LEDs on the module indicate that it is operating properly. Verify that:
    - The dc power LED and the ac power LED on each power module are lit.
    - The OK LED on the management module is lit.
    - The OK LED on each I/O module is lit.
  7. Replace the acoustic module option, if you removed it in step 2.

---

## Installing and removing the acoustic module option

For server environments where noise reduction is essential, you might choose to install the BladeCenter Acoustic Attenuation Module option (acoustic module), on your BladeCenter unit. The acoustic module reduces the sound level of the BladeCenter unit to below 6.9 bel using a T-shaped baffle. The acoustic module is installed on the back of the BladeCenter unit, directly covering the blower modules and partially covering the other modules. The system LED panel is replicated on the acoustic module for visibility. Installing an acoustic module increases the length of a BladeCenter unit and requires use of an enterprise rack.

### Installing the acoustic module option

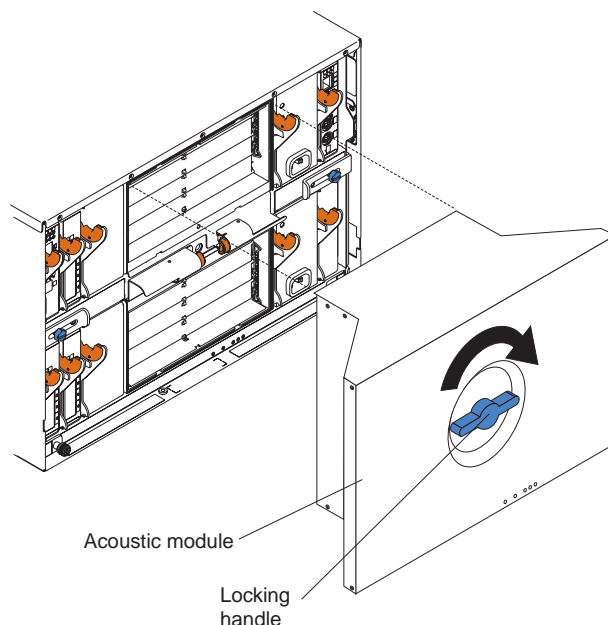

Complete the following steps to install an acoustic module option on the BladeCenter unit:

1. Place the acoustic module over the blower modules, aligning the corners of the acoustic module back with the guides on the chassis, and pushing the shaft into the hole between the blower modules.
2. Rotate the acoustic module handle approximately 2 turns clockwise until it tightens the acoustic module firmly into place.

## Removing the acoustic module option

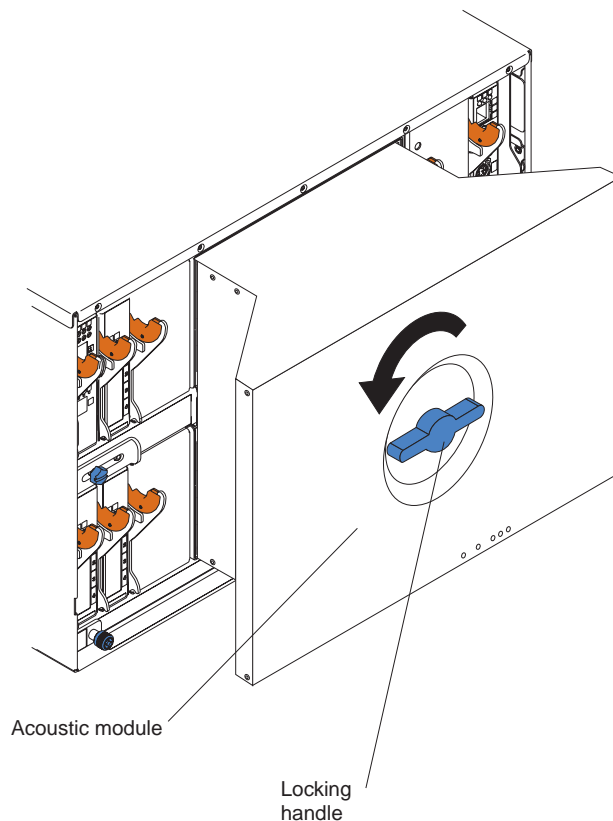

Complete the following steps to remove an acoustic module option from the BladeCenter unit:

1. Rotate the acoustic module handle approximately 2 turns counter-clockwise until it stops.
2. Carefully pull the acoustic module away from the BladeCenter unit and set it aside.

---

## Installing and removing blade servers

Your BladeCenter unit supports up to 14 high-performance blade servers. Each blade server is an enclosure that contains microprocessors, memory, a control chip set, an I/O bus, Ethernet controllers, hard disk drives, and customer interface controls, and connectors for expansion options. The blade server receives its power, network connection, and I/O devices (CD-ROM and diskette drives, keyboard, mouse, and video ports, USB port, remote monitoring port) from the BladeCenter unit, reducing the server physical size and reducing the number of cables needed.

## Blade server expansion options

Some blade servers contain connectors for options that add capabilities to the blade server. You can add these options before installing the blade server in the BladeCenter unit.

Go to <http://www.ibm.com/pc/compat/> on the World Wide Web for a list of available options for your IBM blade server.

### I/O expansion option

Some blade servers have connectors for adding an I/O expansion option, such as the IBM HS20 Fibre Channel Expansion Card. The BladeCenter unit routes network communication signals from the I/O expansion option to I/O modules 3 and 4 on the BladeCenter unit. The I/O expansion option is attached directly to the blade server but does not occupy an additional blade bay.

**Note:** If an I/O expansion option is installed on any blade server, I/O modules compatible with that network interface must be installed in I/O-module bays 3 and 4 on the BladeCenter unit. See “I/O modules” on page 16 for more information.

### Storage-expansion option

Some blade servers have a connector for adding a SCSI expansion unit, such as the IBM HS20 SCSI Storage Expansion Unit. The storage expansion unit supports up to two hot-swap SCSI hard disk drives. The expansion option is attached directly to the blade server; the blade server and expansion option together use two blade bays.

## Installing a blade server

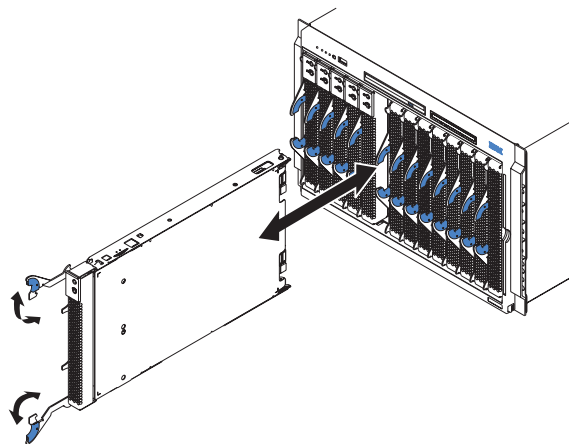

Complete the following steps to install a blade server in the BladeCenter unit.

### Statement 21:



### CAUTION:

**Hazardous energy is present when the blade is connected to the power source. Always replace the blade cover before installing the blade.**

1. Read the safety information beginning on page vii and “Installation guidelines” on page 13 through “Handling static-sensitive devices” on page 14.

2. Install any options needed, such as disk drives or memory, in the blade server. See the documentation that comes with the blade server for instructions.
3. Select the bay for the blade server.

**Notes:**

- a. If a blade server has a SCSI storage expansion option installed on it, the blade server and expansion option require two adjacent blade bays.
  - b. If you install a blade server or option in bay 7 through 14, you must install power modules in power bays 3 and 4.
4. Remove the filler blade from the bay and store in a safe place.

**Attention:** To help ensure proper cooling, performance, and system reliability, make sure that each of the blade bays on the front of the BladeCenter unit has a blade server or filler blade installed. When replacing a blade server, do not operate the BladeCenter unit for more than one minute without either a blade server or a filler blade installed in each blade bay.

5. Ensure that the release levers on the blade server are in the open position (perpendicular to the blade server).
6. Slide the blade server into the bay until it stops. The spring-loaded doors that cover the bay opening move out of the way as you insert the blade server.
7. Push the release levers on the front of the blade server until they are closed.
8. Turn on the blade server by pressing the power-control button on the blade server control panel. See the documentation that comes with the blade server for more instructions.
9. Verify that the power LED on the blade server control panel is lit, indicating that the blade server is receiving power.
10. If desired, write identifying information on one of the user labels that come with the blade server; then, place the label on the BladeCenter bezel just below the blade server, as shown in the following illustration.

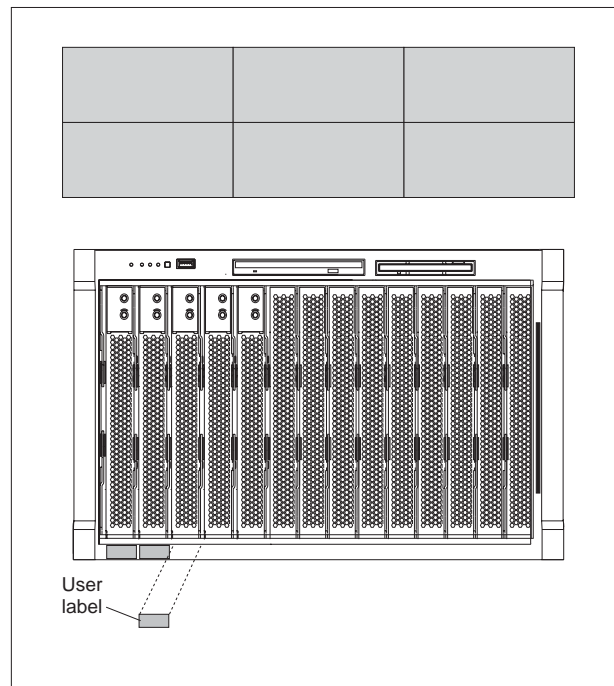

**Important:** Do not place the label on the blade server or in any way block the ventilation holes on the blade server.

11. If you have other blade servers to install, do so now.

**Important:** Reinstalling a blade server into a different bay than the one from which it was removed could have unintended consequences. Some configuration information and update options are established according to bay number. You might need to reconfigure the blade server.

If this is the initial installation for a blade server in the BladeCenter unit, you need to configure the blade server with the blade server Configuration/Setup Utility program and install the blade server operating system. See the documentation that comes with the blade server for instructions.

## Removing a blade server

The following illustration shows how to remove a blade server from the BladeCenter unit.

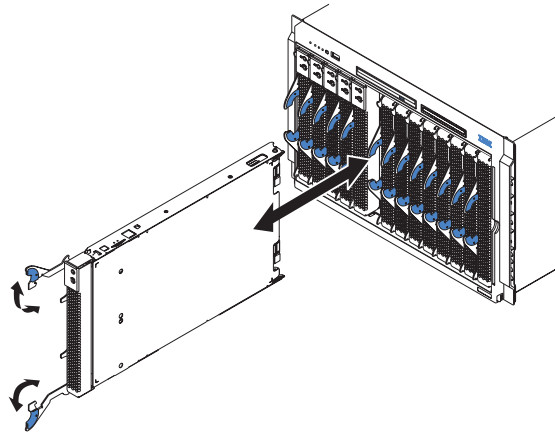

### Attention:

- To maintain proper system cooling, do not operate the BladeCenter unit for more than one minute without either a blade server or a filler blade installed in each blade bay. If you fail to replace a blade server or filler blade within one minute, system performance might be affected.
- Make note of the bay number. Some configuration information and update options are established according to bay; if you reinstall the blade server in a different bay than the one from which it was removed, unintended consequences could occur.

Complete the following steps to remove a blade server from the BladeCenter unit.

1. Read the safety information beginning on page vii and “Installation guidelines” on page 13 through “Handling static-sensitive devices” on page 14.

**Note:** Improper shutdown of a blade server will not allow that blade server to be restarted using Wake on LAN.

2. Shut down the blade server operating system; then, press the blade server power-control button (behind the blade server control panel door) to turn off the blade server. Wait at least 30 seconds until the drives stop spinning, before proceeding to the next step.
3. Open the two release levers as shown in the illustration. The blade server moves out of the bay approximately 0.6 cm (0.25 inch).
4. Pull the blade server out of the bay. Spring-loaded doors move down to cover the bay temporarily.

5. Place either a filler blade or another blade server in the bay within one minute. The spring-loaded doors will move out of the way as you insert the blade server or filler blade.

---

## Completing the installation

After you connect the cables to the modules and route the cables (if necessary, see the *Rack Installation Instructions* for information about routing the cables), start the BladeCenter unit (if it is not already started) and verify that it is working properly, as follows:

1. Start the BladeCenter unit by connecting the power-module power cords to a 220-volt power source (a 220-volt power distribution unit (PDU) that is connected to a 220-volt ac power outlet).
2. Make sure the LEDs on the modules indicate that they are operating properly. Verify that:
  - The dc power LED and the ac power LED on each power module are lit.
  - The OK LED on each management module is lit.
  - The OK LED on each I/O module is lit.
3. Make sure the Power-on LED on each blade server is lit, either steady or blinking.

See Chapter 3, “BladeCenter unit power, controls, and indicators”, on page 29 for information about starting the BladeCenter unit and the location of the LEDs on the modules. See the *BladeCenter HS20 Type 8678 Installation and User's Guide* on the *BladeCenter Documentation CD* for the location of the LEDs on the blade servers.

---

## Input/output connectors

The BladeCenter unit has the following ports:

- One video
- One PS/2 keyboard
- One PS/2 mouse
- One Universal Serial Bus (USB) on the front of the BladeCenter unit
- One 10/100 Mbps Ethernet for remote console and management

The following illustration shows the I/O connectors on the rear of your BladeCenter.

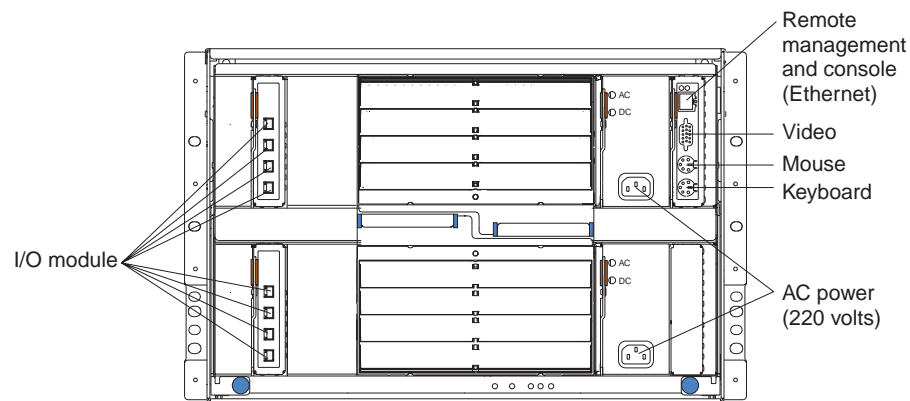



## Video connector

Your BladeCenter management module contains one standard video connector. The integrated video controller on each blade server is compatible with SVGA and VGA and communicates through this video port.

Use this connector to connect a video monitor to the BladeCenter unit.

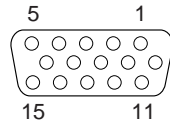

## Keyboard connector

Your BladeCenter management module contains one PS/2-style keyboard connector.

Use this connector to connect a PS/2 keyboard to the BladeCenter unit.

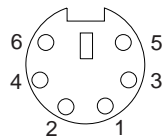

## Mouse connector

Your BladeCenter management module contains one PS/2-style mouse connector.

Use this connector to connect a PS/2 mouse to the BladeCenter unit.

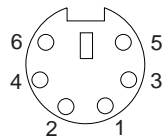

## Remote management and console Ethernet connector

Your BladeCenter management module contains one 10/100 Mb Ethernet connector that provides the remote connection to the network management station on the network.

Use this port for remote management and remote console.

The network management station, through this connector, can access control functions running in the management module, the service processor on each blade server, or within each switch module. However, it cannot use this port to communicate with application programs running in the blade servers. The network management station must direct those communications through a network connected to the external ports in the I/O modules in the BladeCenter unit.

The following illustration shows the Ethernet connector that is on the management module.

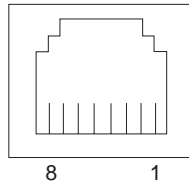

## I/O-module connectors

See the documentation that comes with each I/O module for a description of the connectors on the I/O module.

---

## Chapter 3. BladeCenter unit power, controls, and indicators

This section describes the controls and light-emitting diodes (LEDs) and how to start and shut down the BladeCenter unit.

---

### Starting the BladeCenter unit

**Important:** For the LEDs on each system LED panel to function correctly, be sure to install the management module before starting the BladeCenter unit. See Chapter 2, "Installing options", on page 13 for instructions for installing the management module.

The BladeCenter unit does not have a power switch. To start the BladeCenter unit, plug one end of each power cord into a power module on the rear of the BladeCenter unit, and the other end of each power cord into a 220-volt power distribution unit (PDU) that is plugged into an appropriate electrical outlet.

After you start the BladeCenter unit, it has ac power. The blade servers in the BladeCenter unit are connected to ac power but are not turned on. Press the power-control button on the front of each blade server to obtain full power for the blade server and start its operating system (see the documentation that comes with your blade server for information about turning on the blade server). Be sure to shut down the operating system before turning off the blade server, to avoid damaging the hard disk drives.

**Notes:**

1. If a power failure occurs, the BladeCenter unit restarts automatically when power is restored.
2. The blade server power button turns on or turns off the blade server if local power control has not been disabled through the management module.
3. The blade server power button turns on the blade server only if the green power light on the blade server is flashing slowly. If the light flashes rapidly, the blade server has not yet synchronized with the management module and the power button will have no effect.

---

## Shutting down the BladeCenter unit

You can shut down the BladeCenter unit by turning off the blade servers and disconnecting the BladeCenter unit from the power source.

Complete the following steps to shut down the BladeCenter unit:

1. Refer to your blade server operating-system documentation for the proper procedure to shut down the operating system in the blade servers; then, shut down each operating system.

**Statement 5:**



**CAUTION:**

The power control button on the device and the power switch on the power supply do not turn off the electrical current supplied to the device. The device also might have more than one power cord. To remove all electrical current from the device, ensure that all power cords are disconnected from the power source.

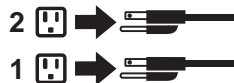

2. Press the power-control button on the front of each blade server. Wait at least 30 seconds for the blade server drives to stop spinning.
3. Disconnect all power cords on the BladeCenter unit from all the power modules.

**Note:** After you disconnect the BladeCenter unit from power, wait at least 5 seconds before you connect the BladeCenter unit to power again.

## BladeCenter components, controls, and LEDs

This section identifies the components, controls, and LEDs on the front and rear of your BladeCenter unit.

**Note:** The illustrations in this document might differ slightly from your hardware.

### Front view

This section identifies the components, controls, and LEDs on the front of your BladeCenter unit.

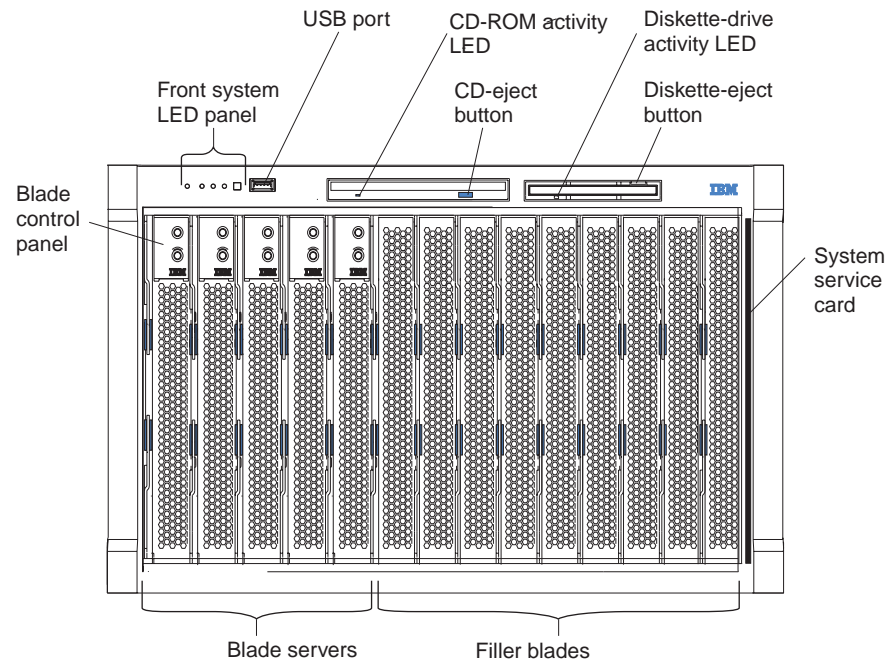

**Front system LED panel:** The LEDs on this panel provide status information for your BladeCenter unit. See “System LED panel” on page 36 for more information.

**USB port:** Use this port to attach an external USB device.

**CD-ROM drive activity LED:** When this LED is lit, it indicates that the CD-ROM drive is in use.

**CD-eject button:** Press this button to release a CD from the drive.

**Diskette-drive activity LED:** When this LED is lit, it indicates that the diskette drive is in use.

**Diskette-eject button:** Press this button to release a diskette from the drive.

**Blade control panel:** This panel contains indicators and controls for the blade server. See the documentation that comes with your blade server for information about the blade control panel.

**System service card:** This card contains system service instructions and a writable area for your use.

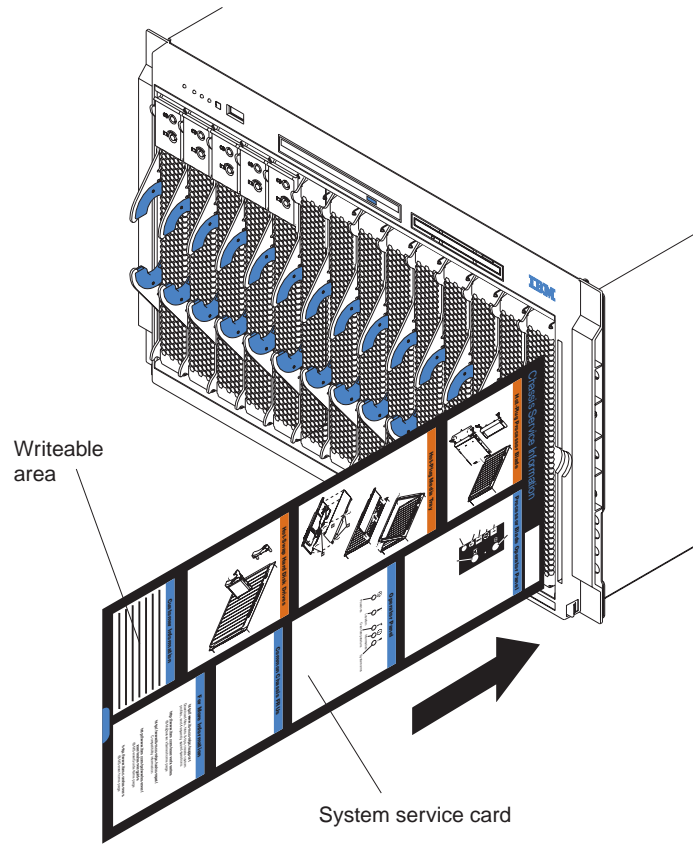

## Rear view

This section identifies the components and indicators on the rear of your BladeCenter unit.

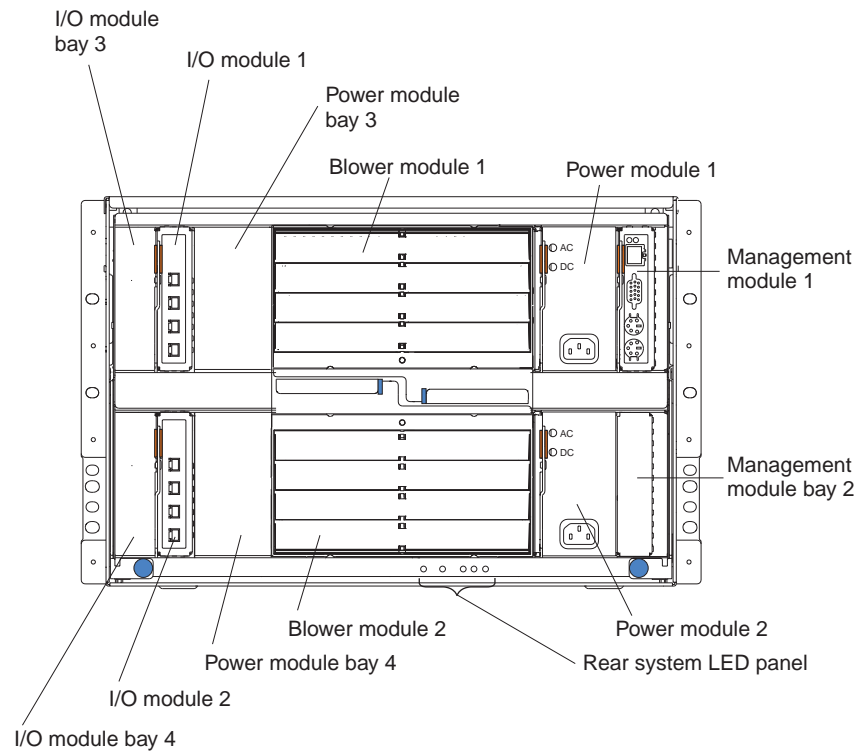

### Rear system LED panel

The LEDs on this panel provide status information for your BladeCenter unit. These LEDs duplicate the LEDs in the front system LED panel. See “System LED panel” on page 36 for more information about these LEDs.

### Blower module

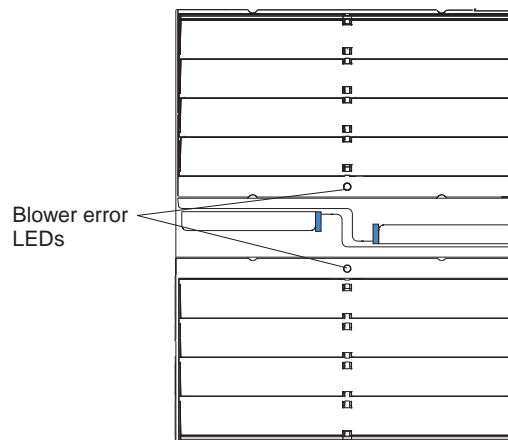

**Blower LEDs:** The LED on each blower provides status information about the blower. For additional information, see the “Light Path Diagnostics” section in the *BladeCenter Hardware Maintenance Manual and Troubleshooting Guide* on the IBM *BladeCenter Documentation CD*.

- **Blower error:** This amber LED is lit and stays lit when an error has been detected in the blower. The system error LED on the BladeCenter system LED panels is also lit.

### I/O module

See the documentation that comes with each I/O module for a description of the LEDs on the I/O module.

### Power module

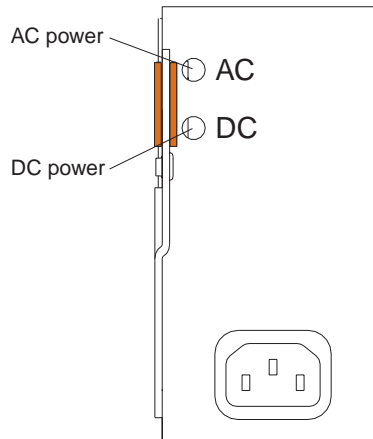

**Power module LEDs:** These green LEDs indicate the condition of the power module. For additional information, see the “Light Path Diagnostics” section in the *BladeCenter Hardware Maintenance Manual and Troubleshooting Guide* on the IBM *BladeCenter Documentation CD*.

- **AC power:** When this LED is lit, ac input to the power module is present and within specifications. During typical operation, both the ac and dc power LEDs are lit. For any other combination of LEDs, see the *Hardware Maintenance Manual and Troubleshooting Guide* on the IBM *BladeCenter Documentation CD*.
- **DC power:** When this LED is lit, the dc output from the power module to the other components and blade servers is present and within specifications. During typical operation, both the ac and dc power LEDs are lit. For any other combination of LEDs, see the *Hardware Maintenance Manual and Troubleshooting Guide* on the IBM *BladeCenter Documentation CD*.



## Management module

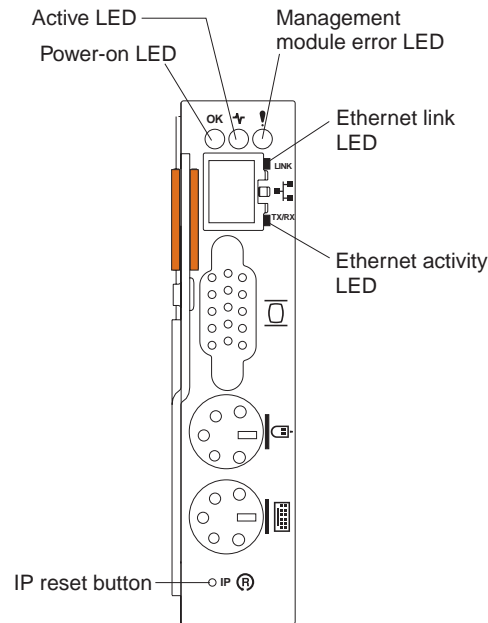

**Management module LEDs:** These LEDs provide status information about the management module and remote management connection. For additional information, see the “Light Path Diagnostics” section in the *Hardware Maintenance Manual and Troubleshooting Guide* on the *IBM BladeCenter Documentation CD*.

- **Power-on:** When this green LED is lit, the management module has power.
- **Active:** When this green LED is lit, it indicates that this management module is actively controlling the BladeCenter unit.
- **Management module error:** When this amber LED is lit, it indicates that an error has been detected somewhere on this management module. When this indicator is lit, the system error LED on each of the BladeCenter system LED panels is also lit.
- **Ethernet link:** When this green LED is lit, there is an active connection through the port to the network.
- **Ethernet activity:** When this green LED is flashing, it indicates that there is activity through the port over the network link.

**Management module IP reset button:** Do not press this button unless you intend to erase your configured IP addresses for the management module and lose connection with the remote management station, the I/O modules, and the blade servers. If you press this button, you will need to reconfigure the management module settings (see the information beginning with “Setting up the remote connection” on page 39 for instructions).

Press this recessed button to reset the IP configuration of the management module network interfaces (Ethernet 1, Ethernet 2, gateway address, and so forth) to the factory defaults and then restart the management module.

Use a straightened paper clip to press the button.

A newly-installed (out-of-the-box) BladeCenter unit tries to locate a DHCP server on the network before it will default to the factory-configured static IP address in the management module. This is the initial configuration setting. When there is no

DHCP server on the network the BladeCenter unit is connected to, it takes two minutes before the management module uses the default (static) IP address.

When the DHCP search times out and the management module uses the static IP address, you can change the management module configuration so that it will not attempt to locate a DHCP server (**MM Control** → **Network Interfaces** → **External Network Interface** → **DHCP**, select **Static only**).

## System LED panel

The following illustration shows the status LEDs on the system LED panels on the front and rear of the BladeCenter unit.

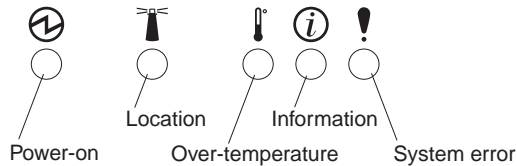

**Attention:** If the power-on LED is off, it does not mean there is no electrical current present in the BladeCenter unit. The LED might be burned out. To remove all electrical current from the BladeCenter unit, you must disconnect all power cords from all power modules.

**Note:** You can turn off the location LED and the information LED through the Web interface or the IBM Director console.

**Power-on:** When this green LED is lit, power is present in the BladeCenter unit. When this LED is off, the power subsystem, the ac power, or the LED has failed, or the management module is not present or not functioning.

**Location:** When this blue LED is lit or flashing, it has been turned on by the system administrator, to aid in visually locating the BladeCenter unit. If a blade server requires attention, the location LED on the blade server usually will also be lit. After the BladeCenter unit has been located, you can have the system administrator turn off the location LED.

**Over-temperature:** When this amber LED is lit, the temperature in the BladeCenter unit exceeds the temperature limits or a blade server reports an over-temperature condition. The BladeCenter unit might have already taken corrective action, such as increasing the blower speed. This LED turns off automatically when there is no longer an over-temperature condition.

**Information:** When this amber LED is lit, a noncritical event has occurred that requires attention, such as the wrong I/O module inserted in a bay or power demands that exceed the capacity of power modules currently installed. The event is recorded in the event log. Check the LEDs on the BladeCenter unit and the blade servers to isolate the component (see the *Hardware Maintenance Manual and Troubleshooting Guide* on the IBM *BladeCenter Documentation CD* for instructions for viewing the event log and checking the LEDs). After the situation is handled, have the system administrator turn off the information LED.

**System-error:** When this amber LED is lit, it indicates that a system error has occurred, such as a failed module or a system error in a blade server. An LED on one of the components or on a blade server is also lit to further isolate the error. (For more information, see the *Hardware Maintenance Manual and Troubleshooting Guide* on the IBM *BladeCenter Documentation CD*.)

---

## Chapter 4. Configuring your BladeCenter unit

The BladeCenter unit automatically detects the modules and blade servers that are installed and stores the vital product data (VPD) information. When the BladeCenter unit is started, it automatically configures the remote management port on the management module, so that you can configure and manage the BladeCenter unit and blade servers. You configure and manage the BladeCenter unit remotely, through the management module, using the Web-based user interface and the HTTP.

**Note:** You can also configure the switch modules directly through an external switch module port, using a Telnet interface or a Web browser. See the documentation that comes with the switch module for more information.

For the management module to communicate with the I/O modules in the BladeCenter unit, you will need to configure the IP addresses for the following internal and external ports:

- The external Ethernet (remote management) port on the management module (see “Configuring the external Ethernet port” on page 43 for instructions). The initial management module autoconfiguration enables the network management station to connect to the management module to configure the port completely and to configure the rest of the BladeCenter unit.
- The internal Ethernet port on the management module for communication with the I/O modules (see “Configuring the internal Ethernet port” on page 44 for instructions).
- The management port on each switch module for communication with the management module. You configure this port by configuring the IP address for the switch module (see “Configuring the management port on I/O modules” on page 44 for instructions).

**Note:** Some types of I/O modules, such as the pass-thru module, have no management port.

See the documentation that comes with the I/O module to determine what else you need to configure in the I/O module.

To communicate with the blade servers for functions such as deploying an operating system or application program, you also will need to configure at least one external (in-band) port on an Ethernet switch module in I/O-module bay 1 or 2. See “What to configure” on page 47 for information about configuring external ports on switch modules.

**Note:** If a pass-thru module is installed in I/O-module bay 1 or 2 (instead of an Ethernet switch module), you will need to configure the network switch that the pass-thru module is connected to; see the documentation that come with the network switch.

The management module supports the following Web browsers for remote access. The Web browser that you use must be Java-enabled, must support JavaScript 1.2 or later, and must have the Java 1.4.1 Plug-In installed.

- Microsoft Internet Explorer 4.0 (with Service Pack 1), or later
- Netscape Navigator 4.72, or later (version 6.x is not supported)

**Notes:**

1. For best results when using the Web browser, set the monitor to 256 colors. Use only the video resolutions and refresh rates given in the following table. These are the only video resolution and refresh rate combinations that are supported for all system configurations.

Resolution	Refresh rate
640x480	60 Hz
640x480	72 Hz
640x480	75 Hz
640x480	85 Hz
800x600	60 Hz
800x600	72 Hz
800x600	75 Hz
800x600	85 Hz
1024x768	60 Hz
1024x768	75 Hz

2. The Web interface does not support the double-byte character set (DBCS) languages.

The Web-based user interface communicates with the management and configuration program that is part of the firmware that comes with the management module. You can use this program to perform tasks such as:

- Defining the login IDs and passwords
- Selecting recipients for alert notification of specific events
- Monitoring the status of the BladeCenter unit and blade servers
- Controlling the BladeCenter unit and blade servers
- Accessing the I/O modules to configure them
- Changing the drive startup sequence in a blade server
- Setting the date and time
- Using a remote console for the blade servers
- Changing ownership of the keyboard, video, and mouse
- Changing ownership of the CD-ROM drive, diskette drive, and USB port. (The CD-ROM drive and diskette drive in the BladeCenter unit are viewed as USB devices by the blade server operating system.)
- Activating On Demand blade servers

**Note:** The IBM Director program is a system-management product that comes with the BladeCenter unit. To configure the remote alert recipients for IBM Director over LAN, the remote alert recipient must be an IBM Director-enabled server.

You also can use the management and configuration program to view some of the blade server configuration settings. See "Using the management and configuration program" on page 42 for more information.

---

## Setting up the remote connection

To configure and manage the BladeCenter unit and blade servers, you must first set up the remote connection through the external Ethernet port on the management module.

### Cabling the Ethernet port

Complete the following steps to connect the Ethernet cable to the management module:

1. Connect one end of a Category 5 or higher Ethernet cable to the Ethernet port on the management module. Connect the other end of the Ethernet cable to the network.
2. Check the Ethernet LEDs to ensure that the network connection is working. The following illustration shows the locations of the Ethernet LEDs.

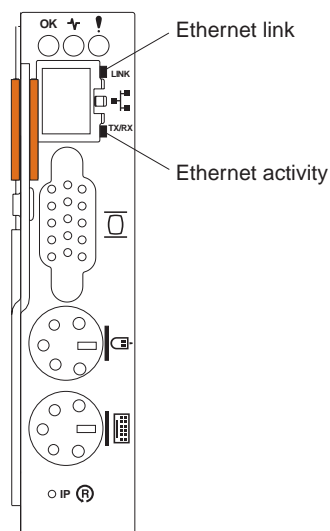

#### Ethernet link LED

When this green LED is lit, it indicates that there is an active connection through the port to the network.

#### Ethernet activity LED

When this green LED is flashing, it indicates that there is activity through the port over the network link.

## Configuring the management module for remote access

After you connect the management module to the network, the Ethernet port connection is configured in one of the following ways:

- If you have an accessible, active, and configured dynamic host configuration protocol (DHCP) server on the network, the host name, IP address, gateway address, subnet mask, and DNS server IP address are set automatically.
- If the DHCP server does not respond within 2 minutes after the port is connected, the management module uses the static IP address and subnet address.

Either of these actions enables the Ethernet connection.

If you do not want to use the default static values, you can configure the static IP address, host name, and subnet mask for the management module through the

Web interface (**MM Control** → **Network Interfaces** → **External Network Interface (eth0)**). The default IP address is 192.168.70.125, the default subnet address is 255.255.255.0, and the default host name is MMxxxxxxxxxxxx, where xxxxxxxxxxxx is the burned-in medium access control (MAC) address. The MAC address is on a label on the management module, below the IP reset button.

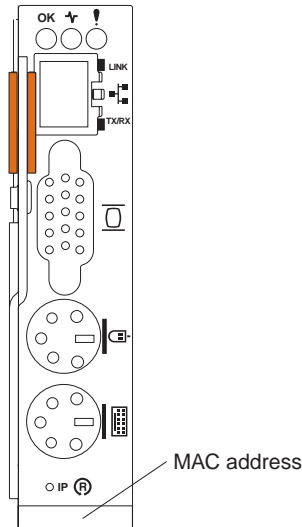

**Notes:**

1. If the IP configuration is assigned by the DHCP server, the network administrator can use the MAC address of the management-module network interface to find out what IP address and host name are assigned.
2. If you plan to use redundant management modules and want both to use the same IP address, disable DHCP (**MM Control** → **Network Interfaces** → **External Network Interface (eth0)** in the Web interface) and configure and use the static IP address. See the *BladeCenter Management Module User's Guide* for more information about configuring redundant management modules.
3. If you want to access the management module with a mobile computer, set your mobile computer to have an address with the same subnet as the management module; then, enter the address of the management module in the Web browser on your mobile computer.

## Communicating with the IBM Director software

**Notes:**

1. See the illustration on page 49 for an example of a typical network configuration. See the *IBM @server BladeCenter Planning and Installation Guide* for more examples of network configurations. You can obtain the planning guide from <http://www.ibm.com/pc/eserver/bladecenter/>.
2. The IBM Director CD comes with the BladeCenter unit.

To communicate with the BladeCenter unit, the IBM Director software needs a managed object (in the Group Contents pane of the IBM Director Management Console main window) that represents the BladeCenter unit. If the BladeCenter management module IP address is known, the network administrator can create an IBM Director managed object for the unit. If the IP address is not known, the IBM Director software can automatically discover the BladeCenter unit (out-of-band, using the Ethernet port on the BladeCenter management module) and create a managed object for the unit.

For the IBM Director software to discover the BladeCenter unit, your network must initially provide connectivity from the IBM Director server to the BladeCenter management-module Ethernet port. To establish connectivity, the management module attempts to use DHCP to acquire its initial IP address for the Ethernet port. If the DHCP request fails, the management module uses a static IP address. Therefore, the DHCP server (if used) must be on the management LAN for your BladeCenter unit.

**Notes:**

1. All management modules are preconfigured with the same static IP address. You can use the management-module Web interface to assign a new static IP address for each BladeCenter unit. If DHCP is not used and you do not assign a new static IP address for each BladeCenter unit before attempting to communicate with the IBM Director software, only one BladeCenter unit at a time can be added onto the network for discovery. Adding multiple units to the network without a unique IP address assignment for each BladeCenter unit results in IP address conflicts.
2. For switch communication with the IBM Director server through the management-module external Ethernet port, the switch module internal network interface and the management-module internal and external interfaces must be on the same subnet.

---

## Configuring Wake on LAN in the BladeCenter unit

Complete the following steps to configure the Wake on LAN feature in the BladeCenter unit:

1. Write down the MAC addresses of the integrated Ethernet controllers of each blade server. This information can be found using the Configuration/Setup Utility program for each blade server (**Devices and I/O Ports** → **System MAC Addresses**). The blade server MAC addresses can also be found on a bar code label that is on the bottom of the blade server enclosure. There might also be a loose label that comes with the blade server that has the MAC addresses printed on it. The MAC addresses are needed to configure a remote system to start the blade servers using the Wake on LAN feature: the remote system issues the Wake on LAN command (magic packet) by broadcasting it to a MAC address.
2. Make sure that the Wake on LAN feature is enabled in the BladeCenter management module (**Blade Tasks** → **Power/Restart** and **Blade Tasks** → **Configuration** in the management module Web interface).
3. Make sure that the external ports of the Ethernet switch modules or pass-thru modules in I/O-module bays 1 and 2 are enabled (**I/O Tasks** → **Management** → **Advanced Management** in the management module Web interface). If the external ports are not enabled, blade servers in the BladeCenter unit will not be able to communicate with the external network.

## Verifying your Wake on LAN configuration

Complete the following steps to verify that the Wake on LAN feature was properly configured and is functioning:

1. Start the blade server operating system.
2. Attempt to ping the remote computer that will issue the Wake on LAN command (magic packet). This verifies network connectivity.
3. Make sure that the blade server is the current owner of the keyboard, video, and mouse (KVM).



4. Shut down the blade server, insert a DOS startable diskette into the diskette drive, and then restart the blade server.
5. When the A:\ prompt appears, turn off the blade server using the power-control button.
6. Issue the Wake on LAN command (magic packet) from the remote computer.  
If the Wake on LAN feature was properly configured and is functioning, the single blade server will wake up. This is a good procedure to determine whether it is a single blade or BladeCenter configuration problem, or a device driver problem within the operating system.

## Linux-specific configuration

Complete the following steps when configuring the Wake on LAN feature under Linux (Red Hat or SuSE):

1. Type the following command:

```
insmod bcm5700.o enable_wol=1,1
```

Where the 1,1 in the switch `enable_wol=1,1` instructs the device driver to enable the Wake on LAN feature for both Broadcom controllers on board a single blade. Because there are two Broadcom controllers, you must issue a 1 for each of them.

2. Recompile the device driver for your Linux image. For example, a device driver compiled in Red Hat Linux is not guaranteed to function for SuSE Linux. See the documentation that comes with your operating system for information about compiling device drivers.

To compile the Broadcom device drivers successfully in Red Hat Linux, a default installation is not sufficient because all files needed to compile successfully are not included. A custom installation of Red Hat Linux, in which the packages for software and kernel development are chosen, will include the files required for successful compilation of the device drivers.

---

## Using the management and configuration program

This section provides the instructions for using the management and configuration program in the management module.

### Starting the management and configuration program

Complete the following steps to start the management and configuration program:

1. Open a Web browser. In the address or URL field, type the IP address or host name defined for the management module remote connection (see "Configuring the management module for remote access" on page 39 for more details).  
The Enter Network Password window opens.
2. Type your user name and password. If you are logging in to the management module for the first time, you can obtain your user name and password from your system administrator. All login attempts are documented in the event log.

**Note:** The initial user ID and password for the management module are:

- User ID: USERID (all capital letters)
  - Password: PASSWORD (note the zero, not O, in PASSWORD)
3. Follow the instructions that appear on the screen. Be sure to set the timeout value you want for your Web session.



The BladeCenter management and configuration window opens.

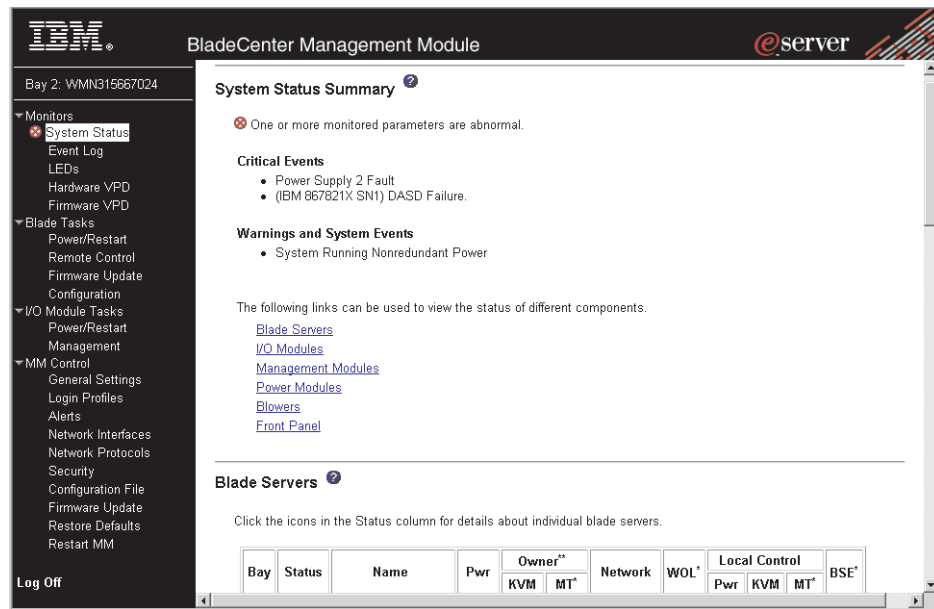

**Note:** The upper left corner of the management and configuration window shows the location and identity of the active management module.



## Management and configuration program options

From the management and configuration program main menu, you can select settings that you want to view or change.

The navigation pane (on the left side of the management module window) contains navigational links that you use to manage your BladeCenter unit and check the status of the components (modules and blade servers). The following information describes the choices you will use to configure the external Ethernet port on the management module, the internal Ethernet port on the management module, and the management port on each switch module. See the *BladeCenter Management Module User's Guide* on the *Documentation CD* that comes with your BladeCenter unit for a description of all the navigational links.

### Configuring the external Ethernet port

Under **MM Control**, click **Network Interfaces** → **External Network Interface (eth0)**. This is the interface for the remote management and console port.

- Set **Interface** to **Enabled** to use the Ethernet connection.

- If you plan to use redundant management modules and want both to use the same IP address, disable DHCP and configure and use the static IP address (the IP configuration information will be transferred to the redundant management module automatically when needed). Otherwise, configure the DHCP setting as you prefer. You need to configure the static IP address only if DHCP is disabled.
  - **IP address** - The IP address for the management module. The IP address must contain four integers from 0 to 255, separated by periods, with no spaces or consecutive periods. The default setting is 192.168.70.125.
  - **Subnet mask** - The subnet mask must contain four integers from 0 to 255, separated by periods, with no spaces. The default setting is 255.255.255.0
  - **Gateway address** - The IP address for your network gateway router. The gateway address must contain four integers from 0 to 255, separated by periods, with no spaces.

### Configuring the internal Ethernet port

Under **MM Control**, click **Network Interfaces** → **Internal Network Interface (eth1)**. This interface communicates with the network-interface I/O modules, such as the Ethernet switch module or the Fibre Channel switch module.

- Specify the IP address to use for this interface. The subnet mask must be the same as the subnet mask in the external network interface (eth0).
- You can configure the locally-administered MAC address for this interface; the other fields (data rate, duplex mode, maximum transmission unit (MTU), and burned-in MAC address) are read-only.

### Configuring the management port on I/O modules

Under **I/O Module Tasks**, click **Management**; then, click the bay number that corresponds to the I/O module you are configuring.

- In the **New Static IP address** fields, specify the IP address to use for this interface. The subnet mask must be the same as the subnet mask in the internal network interface (eth1).
- Click **Advanced Management** → **Advanced setup**. Enable the external ports and external management.

## Saving and restoring the configuration file

After you have configured the management module, you can save the configuration file to a diskette or other external media. Then, if the configuration in the management module becomes damaged or the management module is replaced, you can restore the saved configuration file to the management module. Use the management-module Web interface to save and restore the configuration file (**MM Control** → **Configuration File**).

**Note:** If you cannot communicate with a replacement management module through the Web interface or the IBM Director programs, the IP address might be different from the IP address of the management module just removed. Press the IP reset button to set the management module to the factory default IP addresses; then, access the management module using the factory IP address (see “Configuring the management module for remote access” on page 39 for the factory IP addresses) and configure the management module or load the saved configuration file.

---

## Using IBM Director

The IBM Director program is a system-management product that comes with the BladeCenter unit. Through the remote connection on the management module, you can use the IBM Director software at the IBM Director console to configure the BladeCenter unit, modify the configuration, and set up more advanced features.

### Notes:

1. Some tasks, such as software distribution, require an in-band connection from the Director server through a campus (public) LAN to a switch module port.
2. See the IBM Support Web site at <http://www.ibm.com/pc/support/> for the version of IBM Director software that you can use to manage redundant management modules.

The IBM Director software includes the IBM BladeCenter Deployment Wizard.

## About the wizard

The BladeCenter Deployment Wizard is integrated into the IBM Director management software. The wizard walks you through initial startup and configuration of one or more BladeCenter units.

In addition to performing initial configuration on BladeCenter units, you can use the built-in IBM Director tasks in the wizard to modify the configuration and to set up more advanced features.

You can also create a reusable profile in the wizard for configuring or reconfiguring BladeCenter units. The profile is a noninteractive script that can run as scheduled or as part of an Event Action Plan. With this feature you can define policies to reconfigure a BladeCenter unit on demand, responding to hardware failures or other IBM Director events.

Specifically, you can use the BladeCenter Deployment wizard to perform the following tasks:

- Perform all initial network configuration, including configuring IP addresses for the management module and the switch module internal configuration ports.
- Set up the initial security profile for the BladeCenter unit, including user names, passwords, enablement or disablement of management services, and so forth.
- Optionally configure external switch module ports for multi-port link aggregation (trunking).

## Starting the wizard

Start the wizard from the IBM Director Management Console on the Director server.

1. Select one or more BladeCenter units from the middle (contents) pane of the console window.

**Note:** A lock icon beside a newly discovered BladeCenter unit indicates that the Director server cannot log into the management module for that BladeCenter unit, which can mean that the management module has not been configured yet. You might want to select that BladeCenter unit for initial configuration through the wizard.

2. Perform either of the following actions:
  - Right-click the selected BladeCenter units (managed objects).

- Drag the wizard task from the right-most pane (under BladeCenter in the task list) to any of the selected BladeCenter units (managed objects).

The wizard starts, and guides you through the login and configuration tasks needed.

The following illustration shows the main window on the BladeCenter Deployment wizard.

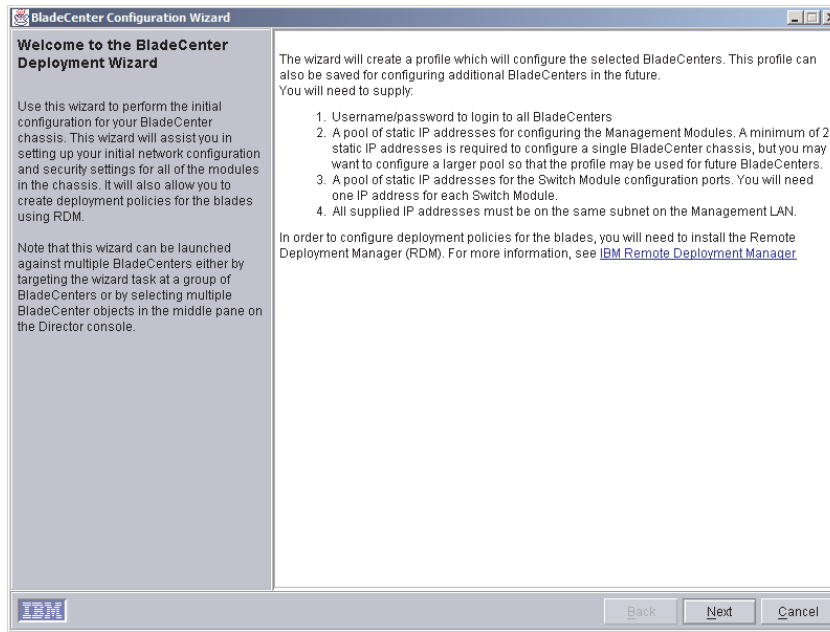

---

## Using Remote Deployment Manager Version 4.1 or later

You can use the Remote Deployment Manager (RDM) Version 4.1 (or later) program to install a supported Microsoft Windows operating system or a BIOS update onto a blade server. Follow the instructions in the documentation that comes with the RDM program to log into the BladeCenter system and install a supported Microsoft Windows operating system or BIOS update.

Go to the following Web site for updated information about the RDM program and to download the software:

[http://www.pc.ibm.com/ww/eserver/xseries/systems\\_management/index.html/](http://www.pc.ibm.com/ww/eserver/xseries/systems_management/index.html/)

---

## Configuring a switch module

This topic discusses configuring a switch module; you might not need to configure other types of I/O modules. To determine whether configuring is needed for an I/O module, see the documentation that comes with the I/O module.

To connect any of the blade servers to the network, you must have an Ethernet switch module installed in I/O-module bay 1 or 2, or a pass-thru module in I/O-module bay 1 or 2 connected to an external Ethernet switch. If you have an I/O expansion option installed in one or more blade servers, you must have compatible I/O modules (switch modules or other compatible modules) in I/O module bays 3 and 4. See "I/O modules" on page 16 for information about the location and purpose of each I/O module.

## What to configure

You need to configure the switch module IP addresses and subnet mask through the management module Web interface to have switch module communication with the management module and remote management station (IBM Director server and console, for example). This is in addition to the IP addresses configured in the management module. You might also need to use the firmware in the switch module to configure the switch external ports to operate in the correct link aggregation (trunking) mode, or to configure any VLANs or other special conditions.

**Note:** To access the firmware in the switch module, make sure the following configuration items in the management module are set to **Enabled**:

- Switch module external ports
- External management for the external ports

In the management module Web interface, under **I/O Module Tasks**, click **Management** → **Advanced Management** → **Advanced Setup** and enable the items.

Because all blade servers in the BladeCenter chassis share access to the external LAN through the switch ports, you can configure the ports on a switch module to operate together as an aggregate link, or trunk. An aggregate link provides more bandwidth than a single link to the attached LAN.

### Notes:

1. The attaching LAN switch must have a compatible multi-port trunk configuration.
2. Configure link aggregation before you attach cables between the external ports and your LAN equipment.

You configure the switch through the firmware on the switch module, which you can access through the Web interface to the management module (click **I/O Module Tasks** → **Management** in the navigation panel).

**Note:** You can also access the firmware on the switch module directly through an external switch module port, using a Telnet interface or a Web browser and the switch IP address. See the documentation that comes with the switch module for more information.

You can configure the IP addresses, subnet mask, and protocols through the IBM BladeCenter Deployment Wizard, which is a function of the IBM Director product. You can also configure external switch module ports for multi-port link aggregation through the Wizard.

**Important:** For a remote management station, such as the IBM Director server, to communicate with the switch modules in the BladeCenter unit, the switch modules must be on the same subnet as the management module.

## Supporting Ethernet failover

To have the BladeCenter unit support Ethernet failover on the blade servers, set up the BladeCenter unit and blade servers as follows:

- Configure the Ethernet controllers in one or more blade servers for failover (see the blade server documentation and the operating-system documentation for information).

**Note:** When failover occurs on a blade server, the secondary Ethernet controller takes over network communication, using the I/O module associated with that controller.

- Install a pair of Ethernet switch modules in I/O-module bays 1 and 2.

**Note:** You can install a pass-thru module that is connected to an external Ethernet switch in either or both of these I/O-module bays.

- Configure the Ethernet switch modules and your network infrastructure so that they can direct traffic to the same destinations.

## Configuring the Ethernet controllers in the blade servers

**Note:** The BladeCenter unit does not include an Ethernet switch module; this is an optional feature that must be purchased separately. An Ethernet switch module or a pass-thru module that connects to an external Ethernet switch must be installed in the BladeCenter unit in I/O-module bay 1 or 2, or both, before the Ethernet controllers integrated on each blade server system board can be used.

The Ethernet controllers are integrated on each blade server system board. The Ethernet controllers provide 1000-Mbps full-duplex capability only, which enables simultaneous transmission and reception of data to the external ports on the Ethernet switches. You do not need to set any jumpers or configure the controller for the blade server operating system. However, you must install a device driver in the blade server to enable the blade server operating system to address the Ethernet controller. For blade server device drivers and information about configuring the Ethernet controllers, see the *Broadcom NetXtreme Ethernet Software* CD that comes with the BladeCenter unit.

---

## BladeCenter networking guidelines

Your networking administrator should assist in the configuration of the network infrastructure prior to connecting the BladeCenter unit to the LAN switch or similar network device. This section provides additional guidelines that might be useful in setting up your system.

A BladeCenter chassis with two Ethernet switch modules and one management module has the following internal configuration:

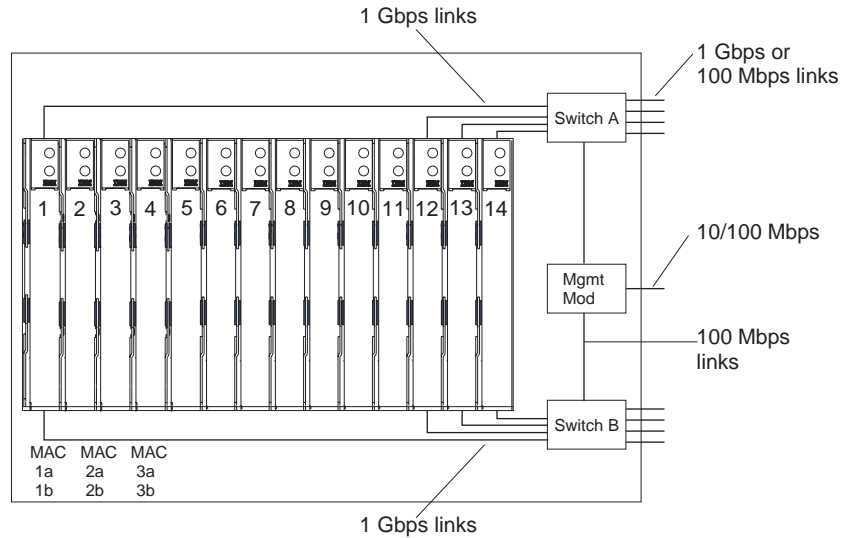

Note: 2nd switch module is optional

Each blade server has two independent Ethernet controllers, each with its own MAC address and a dedicated 1000-Mbps link to one of the switch modules in I/O module bays 1 and 2 (Controller 1 to Switch A and Controller 2 to Switch B in this diagram). In this configuration (the default), the blade servers share access to four external ports on each switch. There is no internal data path between the two switches within the BladeCenter chassis; an external network device is required for data packets to flow from one internal switch to the other.

The management module has a separate internal 100-Mbps link to each switch. These links are for internal management and control only. No data packets are allowed to flow from application programs on the blade servers to the management module over this path. A separate, nonswitched path (not shown) is used for communication between the management module and a service processor on each blade server.

A typical, preferred BladeCenter network topology is shown in the following illustration. See the *IBM @server BladeCenter Planning and Installation Guide* for more information and other topologies and guidelines.



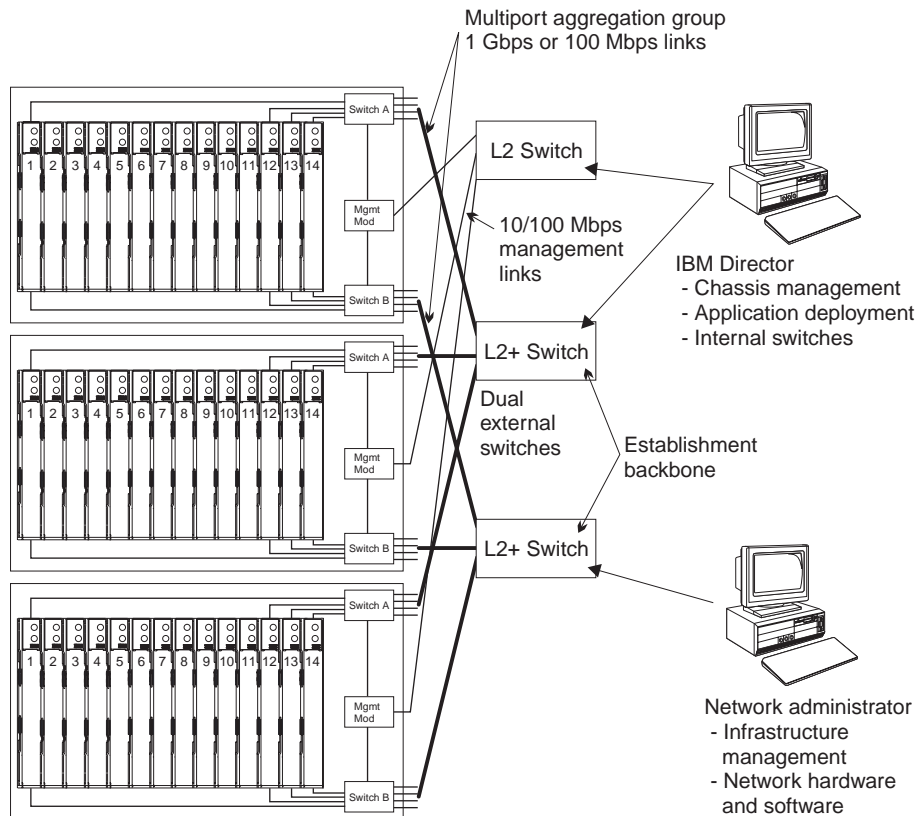

In this configuration, each BladeCenter unit contains two Ethernet switch modules and one management module. The external ports on the switch modules are configured for multi-port link aggregation groups, or trunks, as are the corresponding ports on the attached external LAN switches. Additionally, every port in the switch module in I/O-module bay 1 (switch A in this illustration) in the BladeCenter units is connected to the same external LAN switch and every port in the switch module in I/O-module bay 2 (switch B in this illustration) in the BladeCenter units is connected to the second external LAN switch.

Observe the following guidelines when creating this topology:



1. The external ports on the BladeCenter switch modules are designed for point-to-point, full-duplex operation to a compatible LAN switch or router. Configure a corresponding multi-port link aggregation group, or trunk, in both the switch module and the attached LAN switch prior to installing the cables. The connection options are as follows, in order of preference:
  - Multi-port Link Aggregation Group or Trunk, 1 Gbps (1000 Mbps) per port
  - Single-uplink port, 1 Gbps
  - Multi-port Link Aggregation Group or Trunk, 100 Mbps per port
2. Connect the management module 10/100 Mbps Ethernet port to a separate Layer 2 network if possible, for the best security. If a separate network is not available, you can attach the Ethernet ports of the management module and switch modules to the same Layer 2 network.
3. Avoid network configurations that could lead to data loops, if possible. Loops will be created if you connect multiple ports from the same switch module to the same Layer 2 network device without first enabling link aggregation. If you implement configurations that include data loops, it is essential that you enable Spanning Tree Protocol on the switch module external ports.



---

## Chapter 5. Sharing resources among the blade servers

Your @server BladeCenter Type 8677 unit provides resources that are available to all blade servers at all times, such as power modules, cooling, system management, and network I/O modules; no user intervention is required. Some resources are selectable for use by a single blade server at a time, such as the CD-ROM drive, diskette drive, and USB port unit (media tray), or the keyboard-video-mouse unit. There are several ways to select resources for a blade server:

- Each blade server has two selection buttons on the front of the blade: **CD** and .
  - To switch the keyboard, video, and mouse to a specific blade server, press the  button on that blade server.
  - To switch the CD-ROM, diskette drive, and USB port to a specific blade server, press the **CD** button on that blade server.

The management module immediately assigns the resource to the blade server requesting it.

- You can use the management module Web interface to change ownership of the keyboard, video, and mouse, or the CD-ROM drive, diskette drive, and USB port (**Blade tasks**→ **Remote control**).
- You can press keyboard keys in the following sequence to switch KVM control between blade servers:

NumLock NumLock *blade\_server\_number* Enter

Where *blade\_server\_number* is the two-digit number for the blade bay in which the blade server is installed. When using some keyboards, such as the 28L3644 (37L0888) keyboard, you will need to hold down the Shift key while entering this key sequence.

### Notes:

1. It can take up to 20 seconds for the operating system in the switched-to blade server to recognize the CD-ROM drive, diskette drive, and USB port, or the keyboard, video, and mouse.
2. If you install Microsoft Windows 2000 on a blade server while it is not the current owner of the keyboard, video, and mouse, the first time the blade server requests ownership after the operating system has been installed, it can take up to 1 minute for the operating system to recognize the devices (this is a one-time-only occurrence).
3. The operating system in the blade server must provide USB support for the blade server to recognize and use the keyboard, mouse, CD-ROM drive, and diskette drive. The BladeCenter unit uses USB for internal communication with these devices.
4. You can use the management-module Web interface to enable or disable the select buttons (**Blade tasks**→ **Remote control**) on the blade servers.
5. The monitor attached to the BladeCenter management module normally shows the video output from the blade server that is the current owner of the keyboard, video, and mouse (KVM). When there is no actively selected video from any blade server, the video from blade server 14 is routed to the management module. While the management module is restarting, there is temporarily no

current KVM owner. The video from blade server 14 displays on the monitor briefly until the management module uses its NVRAM values to reestablish ownership of the KVM and media tray (CD-ROM drive, diskette drive, and USB port). After that, the video from the blade server that is the current KVM owner is displayed on the monitor.

**Attention:** Do not switch the CD-ROM drive, diskette drive, and USB port to another blade server while a transaction is taking place on either the CD-ROM or the diskette drive. (Activity lights on the CD-ROM drive and diskette drive must be off.) Data damage can occur.

---

## Chapter 6. Solving problems

This section provides basic troubleshooting information to help you solve some common problems that might occur while setting up your BladeCenter unit.

If you cannot locate and correct the problem using the information in this section, see the *Hardware Maintenance Manual and Troubleshooting Guide* on the IBM *BladeCenter Documentation* CD for more information.

---

### Diagnostic tools overview

The following tools are available to help you identify and solve hardware-related problems:

- **Troubleshooting charts**

These charts list problem symptoms and steps to correct the problems. See the "Troubleshooting charts" on page 54 for more information.

- **Diagnostic programs and error messages**

The built-in self-test (BIST) program checks the BladeCenter unit during startup and generates error messages if problems are found.

The system diagnostic program, Real Time Diagnostics Version 1.3, tests the major components of your BladeCenter unit. It is run from the IBM Director Management Console window (under the **BladeCenter** task in the Task panel).

Complete the following steps to obtain the Real Time Diagnostics program:

1. Go to <http://www.ibm.com/pc/support/>.
2. Select **Servers** from the list on the left side of the window.
3. Select **Downloadable files** from the list on the left side of the window.
4. In the **Downloadable files by category** list, select **Diagnostic**.
5. Click the entry for Real Time Diagnostics and follow the instructions on that page.

- **Light path diagnostics feature**

Use the light path diagnostics feature to identify system errors quickly. On the BladeCenter unit, the light path diagnostics feature consists of the LEDs on the front and rear of the BladeCenter chassis and on the front of the modules and blade servers.

---

## Troubleshooting charts

You can use the troubleshooting charts in this section to find solutions to problems that have definite symptoms.

**Note:** The symptoms for monitor, keyboard, and mouse apply only to the devices connected to the management module; they do not apply to the remote console.

See the *Hardware Maintenance Manual and Troubleshooting Guide* on the IBM BladeCenter Documentation CD for more detailed information about testing the BladeCenter unit. If you have run the diagnostic test programs or if running the tests does not reveal the problem, call for service.

**Attention:** If diagnostic error messages appear that are not listed in the *Hardware Maintenance Manual and Troubleshooting Guide*, make sure that your BladeCenter unit has the latest level of firmware code installed.

If you have just added a new option and your system is not working, complete the following procedure before using the troubleshooting charts:

1. Remove the option that you just added.
2. Run the diagnostic tests to determine if your system is running correctly.
3. Reinstall the new device.

## Monitor problems

**Note:** The monitor screen remains blank until directed to a blade server that is turned on; this is normal behavior.

Some IBM monitors have their own self-tests. If you suspect a problem with your monitor, see the information that comes with the monitor for instructions for testing and adjusting the monitor. If you cannot diagnose the problem, call for service.

Device	Suggested action
The monitor screen goes blank when you direct it to a working blade server or goes blank when you start some application programs in the blade servers.	Make sure that the monitor cable is connected to the video connector on the BladeCenter management module and that the management module LEDs indicate that the module is functioning. Some IBM monitors have their own self-tests. If you suspect a problem with your monitor, see the information that comes with the monitor for adjusting and testing instructions.  If you cannot diagnose the problem, try replacing the management module. If the problem remains, replace the monitor.
The screen is blank.	Make sure that: <ul style="list-style-type: none"><li>• The BladeCenter unit power cord is connected to a BladeCenter power module and a working 220-volt PDU.</li><li>• The monitor cables are connected correctly.</li><li>• The monitor is turned on and the brightness and contrast controls are adjusted correctly.</li><li>• The monitor is owned by a blade server that is turned on.</li></ul> If the problem remains, call for service.
Only the cursor appears.	Try switching the monitor to another blade server. <ul style="list-style-type: none"><li>• If the problem goes away, troubleshoot the blade sever for which only the cursor appears.</li><li>• If the problem remains, call for service.</li></ul>

Device	Suggested action
The monitor has screen jitter, or the screen image is wavy, unreadable, rolling, or distorted.	<p>If the monitor self-tests show the monitor is working correctly, consider the location of the monitor. Magnetic fields around other devices (such as transformers, appliances, fluorescent lights, and other monitors) can cause screen jitter or wavy, unreadable, rolling, or distorted screen images. If this happens, turn off the monitor. (Moving a color monitor while it is turned on might cause screen discoloration.) Then move the device and the monitor at least 305 mm (12 in.) apart. Turn on the monitor.</p> <p><b>Notes:</b></p> <ol style="list-style-type: none"> <li>1. To prevent diskette drive read/write errors, make sure that the distance between the monitor and diskette drive is at least 76 mm (3 in.).</li> <li>2. Non-IBM monitor cables might cause unpredictable problems.</li> <li>3. An enhanced monitor cable with additional shielding is available for the 9521 and 9527 monitors. For information about the enhanced monitor cable, contact your IBM marketing representative or authorized reseller.</li> </ol> <p>If the problem remains, call for service.</p>
All other symptoms	Troubleshoot the blade server that is the current owner of the keyboard, video, and monitor.

## Power problems

Device	Suggested action
The BladeCenter unit does not start.	<ul style="list-style-type: none"> <li>• Make sure that the power cables are properly connected to the power modules in the BladeCenter unit.</li> <li>• Make sure that the 220-volt PDU or electrical outlet is working correctly.</li> <li>• Make sure that the LEDs on the power module are on.</li> <li>• If you just installed an option, remove it, and restart the BladeCenter unit. If the BladeCenter unit now starts, you might have installed more options than the power module supports.</li> </ul> <p>If the problem remains, call for service.</p>

## Management module problems

Device	Suggested action
Management module does not complete changeover to redundant module on hardware failure.	Call for service.

## Blower module problems

Device	Suggested action
Blower module operates at full speed, with no regulation.	<p>Make sure that:</p> <ul style="list-style-type: none"> <li>• Both blower modules are functioning (neither has failed).</li> <li>• Each power module is connected to an ac power source. A power module that is not connected to an ac power source creates a non-redundant-power condition and causes the blower modules to operate at full speed.</li> </ul> <p>If a blower module has failed, replace the module as soon as possible.</p>

## Options problems

Device	Suggested action
An IBM option that was just installed does not work.	<p>Make sure that:</p> <ul style="list-style-type: none"><li>• The option is designed for the BladeCenter unit. See the “Server Support” flowchart on the inside of the front cover for information about obtaining ServerProven<sup>®</sup> compatibility information from the World Wide Web.</li><li>• You followed the installation instructions that come with the option.</li><li>• The option is installed correctly.</li><li>• You have not loosened any other installed options or cables.</li></ul> <p>If the problem remains, call for service.</p>
An IBM option that used to work does not work now.	<ul style="list-style-type: none"><li>• Make sure that all of the option hardware and cable connections are secure.</li><li>• If the option comes with test instructions, use those instructions to test the option.</li></ul> <p>If the problem remains, call for service.</p>

---

## Light path diagnostics feature

On the BladeCenter system, the light path diagnostics feature consists of the LEDs on the front and rear of the BladeCenter chassis and on the front of the modules and blade servers. If the system-error LED on the system LED panel on the front or rear of the BladeCenter unit is lit, one or more error LEDs on the BladeCenter components also might be on. These LEDs help identify the cause of the problem.

## Identifying problems using the light path diagnostics feature

This section provides the information to identify, using the light path diagnostics feature, problems that might arise during installation.

To locate the actual component that caused the error, you must locate the lit error LED on that component.

The following example illustrates how to use the light path diagnostics feature to diagnose a system error:

1. Note that the BladeCenter system-error LED is lit on the system LED panel.
2. Locate the module or blade server that also has an error LED lit (see “BladeCenter components, controls, and LEDs” on page 31 for the location of error LEDs; see the documentation that comes with your blade server for the location of error LEDs on the blade server).
  - a. If the component is a module, replace the module.
  - b. If the component is a blade server with its system error LED lit, follow the instructions in the documentation that comes with the blade server to isolate and correct the problem.

## Light path diagnostics LEDs

The system-error LED on the system LED panel is lit when certain system errors occur. If the system-error LED on your BladeCenter unit is lit, use the following table to help determine the cause of the error and the action you should take.

Table 3. Light path diagnostics

Lit LED	Cause	Action
<b>BladeCenter system LED panel</b>		
Location	A condition has occurred in the BladeCenter unit that has caused the remote system management to identify the BladeCenter unit as needing attention.	Look for any information or error LEDs on the system LED panels, the modules, and the blade servers in this BladeCenter unit, and follow the instructions in this table for those LEDs.
Over-temperature	The system temperature has exceeded a threshold level.	<ul style="list-style-type: none"> <li>• Determine whether a blower module has failed. If it has, replace the blower module as soon as possible, to regain redundancy.</li> <li>• Make sure that the room temperature is not too high. (See “Features and specifications” on page 6 for temperature information.)</li> <li>• Determine whether a blade server has a temperature LED lit. If it does, see the documentation that comes with the blade server.</li> <li>• Make sure that there is a blade server, module, or filler installed in each bay.</li> </ul> <p>If the problem remains, call for service.</p>
Information	A noncritical event has occurred that should be looked at, such as the wrong I/O module inserted in a bay, or power needs that exceed the capacity of power modules currently installed.	Check the error log for the messages. Check the LEDs on the BladeCenter unit and the blade servers to isolate the component.
System error	A critical system error has occurred, such as nonredundancy on the power modules or a system error in a blade.	<ul style="list-style-type: none"> <li>• Check the error log for messages.</li> <li>• Look for an error LED on the modules and blade servers to locate the component: <ul style="list-style-type: none"> <li>– If the error LED is on a module, follow the instructions for the module in this table.</li> <li>– If the error LED is on a blade server, see the documentation that comes with the blade server.</li> </ul> </li> </ul>
<b>Management module</b>		
System error	A critical error has occurred in the management module.	<ul style="list-style-type: none"> <li>• If your BladeCenter unit has only one management module: <ol style="list-style-type: none"> <li>1. Try reseating the management module.</li> <li>2. Restart the management module.</li> </ol> <p>If the problem remains, replace the management module.</p> </li> <li>• If your BladeCenter unit has two management modules, the BladeCenter unit continues to function using the redundant module. Replace the failed management module.</li> </ul>

Table 3. Light path diagnostics (continued)

Lit LED	Cause	Action
<b>Power module</b>		
System error	A critical error has occurred in the power module.	Reseat the power module. If the problem remains, replace the module. If your BladeCenter unit has a redundant module for this power module, the BladeCenter unit continues to function using the redundant module.
<b>Blower module</b>		
System error	The blower has failed or is operating too slowly.	Reseat the blower module. If the problem remains, replace the blower module as soon as possible, to regain cooling redundancy. The BladeCenter unit continues to function. The redundant blower module provides cooling to the BladeCenter unit and blade servers.
<b>I/O module</b>		
System error	A critical error has occurred in the I/O module.	Reseat the I/O module. If the problem remains, replace the module.



---

## Appendix A. Getting help and technical assistance

If you need help, service, or technical assistance or just want more information about IBM products, you will find a wide variety of sources available from IBM to assist you. This appendix contains information about where to go for additional information about IBM and IBM products, what to do if you experience a problem with your @server or IntelliStation® system, and whom to call for service, if it is necessary.

---

### Before you call

Before you call, make sure that you have taken these steps to try to solve the problem yourself:

- Check all cables to make sure that they are connected.
- Check the power switches to make sure that the system is turned on.
- Use the troubleshooting information in your system documentation, and use the diagnostic tools that come with your system.
- Go to the IBM Support Web site at <http://www.ibm.com/pc/support/> to check for technical information, hints, tips, and new device drivers.
- Use an IBM discussion forum on the IBM Web site to ask questions.

You can solve many problems without outside assistance by following the troubleshooting procedures that IBM provides in the online help or in the publications that are provided with your system and software. The information that comes with your system also describes the diagnostic tests that you can perform. Most @server and IntelliStation systems, operating systems, and programs come with information that contains troubleshooting procedures and explanations of error messages and error codes. If you suspect a software problem, see the information for the operating system or program.

---

### Using the documentation

Information about your IBM @server or IntelliStation system and preinstalled software, if any, is available in the documentation that comes with your system. That documentation includes printed books, online books, README files, and help files. See the troubleshooting information in your system documentation for instructions for using the diagnostic programs. The troubleshooting information or the diagnostic programs might tell you that you need additional or updated device drivers or other software. IBM maintains pages on the World Wide Web where you can get the latest technical information and download device drivers and updates. To access these pages, go to <http://www.ibm.com/pc/support/> and follow the instructions. Also, you can order publications through the IBM Publications Ordering System at <http://www.elink.ibm.com/public/applications/publications/cgibin/pbi.cgi/>.

---

### Getting help and information from the World Wide Web

On the World Wide Web, the IBM Web site has up-to-date information about IBM @server and IntelliStation products, services, and support. The address for IBM @server information is <http://www.ibm.com/eserver/xseries/>. The address for IBM IntelliStation information is <http://www.ibm.com/pc/intellistation/>.

You can find service information for your IBM products, including supported options, at <http://www.ibm.com/pc/support/>. If you click **Profile** from the support page, you can create a customized support page. The support page has many sources of information and ways for you to solve problems, including:

- Diagnosing problems, using the IBM Online Assistant
- Downloading the latest device drivers and updates for your products
- Viewing Frequently Asked Questions (FAQ)
- Viewing hints and tips to help you solve problems
- Participating in IBM discussion forums
- Setting up e-mail notification of technical updates about your products

---

## Software service and support

Through IBM Support Line, you can get telephone assistance, for a fee, with usage, configuration, and software problems with @server BladeCenter units, xSeries servers, IntelliStation workstations, and appliances. For information about which products are supported by Support Line in your country or region, go to <http://www.ibm.com/services/sl/products/>.

For more information about Support Line and other IBM services, go to <http://www.ibm.com/services/>, or go to <http://www.ibm.com/planetwide/> for support telephone numbers.

---

## Hardware service and support

You can receive hardware service through IBM Integrated Technology Services or through your IBM reseller, if your reseller is authorized by IBM to provide warranty service. Go to <http://www.ibm.com/planetwide/> for support telephone numbers.

In the U.S. and Canada, hardware service and support is available 24 hours a day, 7 days a week. In the U.K., these services are available Monday through Friday, from 9 a.m. to 6 p.m.

---

# Appendix B. IBM Statement of Limited Warranty Z125-4753-07 11/2002

---

## Part 1 - General Terms

### Part 1 - General Terms

*This Statement of Limited Warranty includes Part 1 - General Terms, Part 2 - Country-unique Terms, and Part 3 - Warranty Information. The terms of Part 2 replace or modify those of Part 1. The warranties provided by IBM in this Statement of Limited Warranty apply only to Machines you purchase for your use, and not for resale. The term "Machine" means an IBM machine, its features, conversions, upgrades, elements, or accessories, or any combination of them. The term "Machine" does not include any software programs, whether pre-loaded with the Machine, installed subsequently or otherwise. **Nothing in this Statement of Limited Warranty affects any statutory rights of consumers that cannot be waived or limited by contract.***

### What this Warranty Covers

IBM warrants that each Machine 1) is free from defects in materials and workmanship and 2) conforms to IBM's Official Published Specifications ("Specifications") which are available on request. The warranty period for the Machine starts on the original Date of Installation and is specified in Part 3 - Warranty Information. The date on your invoice or sales receipt is the Date of Installation unless IBM or your reseller informs you otherwise. Many features, conversions, or upgrades involve the removal of parts and their return to IBM. A part that replaces a removed part will assume the warranty service status of the removed part. Unless IBM specifies otherwise, these warranties apply only in the country or region in which you purchased the Machine.

**THESE WARRANTIES ARE YOUR EXCLUSIVE WARRANTIES AND REPLACE ALL OTHER WARRANTIES OR CONDITIONS, EXPRESS OR IMPLIED, INCLUDING, BUT NOT LIMITED TO, THE IMPLIED WARRANTIES OR CONDITIONS OF MERCHANTABILITY AND FITNESS FOR A PARTICULAR PURPOSE. SOME STATES OR JURISDICTIONS DO NOT ALLOW THE EXCLUSION OF EXPRESS OR IMPLIED WARRANTIES, SO THE ABOVE EXCLUSION MAY NOT APPLY TO YOU. IN THAT EVENT, SUCH WARRANTIES ARE LIMITED IN DURATION TO THE WARRANTY PERIOD. NO WARRANTIES APPLY AFTER THAT PERIOD. SOME STATES OR JURISDICTIONS DO NOT ALLOW LIMITATIONS ON HOW LONG AN IMPLIED WARRANTY LASTS, SO THE ABOVE LIMITATION MAY NOT APPLY TO YOU.**

### What this Warranty Does not Cover

This warranty does not cover the following:

- any software programs, whether pre-loaded or shipped with the Machine, or installed subsequently;
- failure resulting from misuse (including but not limited to use of any Machine capacity or capability, other than that authorized by IBM in writing), accident, modification, unsuitable physical or operating environment, or improper maintenance by you;
- failure caused by a product for which IBM is not responsible; and
- any non-IBM products, including those that IBM may procure and provide with or integrate into an IBM Machine at your request.

The warranty is voided by removal or alteration of identification labels on the Machine or its parts.

IBM does not warrant uninterrupted or error-free operation of a Machine.

Any technical or other support provided for a Machine under warranty, such as assistance via telephone with “how-to” questions and those regarding Machine set-up and installation, is provided **WITHOUT WARRANTIES OF ANY KIND**.

### **How to Obtain Warranty Service**

If the Machine does not function as warranted during the warranty period, contact IBM or your reseller to obtain warranty service. If you do not register the Machine with IBM, you may be required to present proof of purchase as evidence of your entitlement to warranty service.

### **What IBM Will Do to Correct Problems**

When you call for service, you must follow the problem determination and resolution procedures that IBM specifies. A technician will attempt to make an initial diagnosis of your problem and help you resolve it over the telephone.

The type of warranty service applicable to your Machine is specified in Part 3 - Warranty Information.

You are responsible for downloading and installing designated Machine Code (microcode, basic input/output system code (called “BIOS”), utility programs, device drivers, and diagnostics delivered with an IBM Machine) and other software updates from an IBM Internet Web site or from other electronic media, and following the instructions that IBM provides.

If your problem can be resolved with a Customer Replaceable Unit (“CRU”) (e.g., keyboard, mouse, speaker, memory, hard disk drive and other easily replaceable parts), IBM will ship these parts to you for replacement by you.

If the Machine does not function as warranted during the warranty period and your problem cannot be resolved over the telephone, through your application of Machine Code or software updates, or with a CRU, IBM or your reseller, if approved by IBM to provide warranty service, will either, at its discretion, 1) repair it to make it function as warranted, or 2) replace it with one that is at least functionally equivalent. If IBM is unable to do either, you may return the Machine to your place of purchase and your money will be refunded.

IBM or your reseller will also manage and install selected engineering changes that apply to the Machine.

### **Exchange of a Machine or Part**

When the warranty service involves the exchange of a Machine or part, the item IBM or your reseller replaces becomes its property and the replacement becomes yours. You represent that all removed items are genuine and unaltered. The replacement may not be new, but will be in good working order and at least functionally equivalent to the item replaced. The replacement assumes the warranty service status of the replaced item.

### **Your Additional Responsibilities**

Before IBM or your reseller exchanges a Machine or part, you agree to remove all features, parts, options, alterations, and attachments not under warranty service.

You also agree to:

1. ensure that the Machine is free of any legal obligations or restrictions that prevent its exchange;
2. obtain authorization from the owner to have IBM or your reseller service a Machine that you do not own; and
3. where applicable, before service is provided:
  - a. follow the service request procedures that IBM or your reseller provides;
  - b. backup or secure all programs, data, and funds contained in the Machine;
  - c. provide IBM or your reseller with sufficient, free, and safe access to your facilities to permit IBM to fulfill its obligations; and
  - d. inform IBM or your reseller of changes in the Machine's location.
4. (a) ensure all information about identified or identifiable individuals (Personal Data) is deleted from the Machine (to the extent technically possible), (b) allow IBM, your reseller or an IBM supplier to process on your behalf any remaining Personal Data as IBM or your reseller considers necessary to fulfill its obligations under this Statement of Limited Warranty (which may include shipping the Machine for such processing to other IBM service locations around the world), and (c) ensure that such processing complies with any laws applicable to such Personal Data.

#### **Limitation of Liability**

IBM is responsible for loss of, or damage to, your Machine only while it is 1) in IBM's possession or 2) in transit in those cases where IBM is responsible for the transportation charges.

Neither IBM nor your reseller are responsible for any of your confidential, proprietary or personal information contained in a Machine which you return to IBM for any reason. You should remove all such information from the Machine prior to its return.

Circumstances may arise where, because of a default on IBM's part or other liability, you are entitled to recover damages from IBM. In each such instance, regardless of the basis on which you are entitled to claim damages from IBM (including fundamental breach, negligence, misrepresentation, or other contract or tort claim), except for any liability that cannot be waived or limited by applicable laws, IBM is liable for no more than

1. damages for bodily injury (including death) and damage to real property and tangible personal property; and
2. the amount of any other actual direct damages, up to the charges (if recurring, 12 months' charges apply) for the Machine that is subject of the claim. For purposes of this item, the term "Machine" includes Machine Code and Licensed Internal Code ("LIC").

This limit also applies to IBM's suppliers and your reseller. It is the maximum for which IBM, its suppliers, and your reseller are collectively responsible.

**UNDER NO CIRCUMSTANCES IS IBM, ITS SUPPLIERS OR RESELLERS LIABLE FOR ANY OF THE FOLLOWING EVEN IF INFORMED OF THEIR POSSIBILITY: 1) THIRD PARTY CLAIMS AGAINST YOU FOR DAMAGES (OTHER THAN THOSE UNDER THE FIRST ITEM LISTED ABOVE); 2) LOSS OF, OR DAMAGE TO, DATA; 3) SPECIAL, INCIDENTAL, OR INDIRECT DAMAGES OR FOR ANY ECONOMIC CONSEQUENTIAL DAMAGES; OR 4) LOST**

**PROFITS, BUSINESS REVENUE, GOODWILL OR ANTICIPATED SAVINGS. SOME STATES OR JURISDICTIONS DO NOT ALLOW THE EXCLUSION OR LIMITATION OF INCIDENTAL OR CONSEQUENTIAL DAMAGES, SO THE ABOVE LIMITATION OR EXCLUSION MAY NOT APPLY TO YOU. SOME STATES OR JURISDICTIONS DO NOT ALLOW LIMITATIONS ON HOW LONG AN IMPLIED WARRANTY LASTS, SO THE ABOVE LIMITATION MAY NOT APPLY TO YOU.**

#### **Governing Law**

Both you and IBM consent to the application of the laws of the country in which you acquired the Machine to govern, interpret, and enforce all of your and IBM's rights, duties, and obligations arising from, or relating in any manner to, the subject matter of this Statement of Limited Warranty, without regard to conflict of law principles.

**THESE WARRANTIES GIVE YOU SPECIFIC LEGAL RIGHTS AND YOU MAY ALSO HAVE OTHER RIGHTS WHICH VARY FROM STATE TO STATE OR JURISDICTION TO JURISDICTION.**

#### **Jurisdiction**

All of our rights, duties, and obligations are subject to the courts of the country in which you acquired the Machine.

---

## **Part 2 - Country-unique Terms**

### **AMERICAS**

#### **ARGENTINA**

**Governing Law:** *The following is added after the first sentence:*

Any litigation arising from this Statement of Limited Warranty will be settled exclusively by the Ordinary Commercial Court of the city of Buenos Aires.

#### **BRAZIL**

**Governing Law:** *The following is added after the first sentence:*

Any litigation arising from this Statement of Limited Warranty will be settled exclusively by the court of Rio de Janeiro, RJ.

#### **PERU**

**Limitation of Liability:** *The following is added at the end of this section:*

In accordance with Article 1328 of the Peruvian Civil Code the limitations and exclusions specified in this section will not apply to damages caused by IBM's willful misconduct ("dolo") or gross negligence ("culpa inexcusable").

### **NORTH AMERICA**

**How to Obtain Warranty Service:** *The following is added to this Section:*

To obtain warranty service from IBM in Canada or the United States, call 1-800-IBM-SERV (426-7378).

#### **CANADA**

**Limitation of Liability:** *The following replaces item 1 of this section:*

1. damages for bodily injury (including death) or physical harm to real property and tangible personal property caused by IBM's negligence; and

**Governing Law:** *The following replaces "laws of the country in which you acquired the Machine" in the first sentence:*

laws in the Province of Ontario.

## **UNITED STATES**

**Governing Law:** *The following replaces "laws of the country in which you acquired the Machine" in the first sentence:*

laws of the State of New York.

## **ASIA PACIFIC**

### **AUSTRALIA**

**What this Warranty Covers:** *The following paragraph is added to this section:*

The warranties specified in this Section are in addition to any rights you may have under the Trade Practices Act 1974 or other similar legislation and are only limited to the extent permitted by the applicable legislation.

**Limitation of Liability:** *The following is added to this section:*

Where IBM is in breach of a condition or warranty implied by the Trade Practices Act 1974 or other similar legislation, IBM's liability is limited to the repair or replacement of the goods or the supply of equivalent goods. Where that condition or warranty relates to right to sell, quiet possession or clear title, or the goods are of a kind ordinarily acquired for personal, domestic or household use or consumption, then none of the limitations in this paragraph apply.

**Governing Law:** *The following replaces "laws of the country in which you acquired the Machine" in the first sentence:*

laws of the State or Territory.

### **CAMBODIA, LAOS, AND VIETNAM**

**Governing Law:** *The following replaces "laws of the country in which you acquired the Machine" in the first sentence:*

laws of the State of New York, United States of America.

### **CAMBODIA, INDONESIA, LAOS, AND VIETNAM**

**Arbitration:** *The following is added under this heading:*

Disputes arising out of or in connection with this Statement of Limited Warranty shall be finally settled by arbitration which shall be held in Singapore in accordance with the Arbitration Rules of Singapore International Arbitration Center ("SIAC Rules") then in effect. The arbitration award shall be final and binding for the parties without appeal and shall be in writing and set forth the findings of fact and the conclusions of law.

The number of arbitrators shall be three, with each side to the dispute being entitled to appoint one arbitrator. The two arbitrators appointed by the parties shall appoint a third arbitrator who shall act as chairman of the proceedings. Vacancies in the post of chairman shall be filled by the president of the SIAC. Other vacancies shall



be filled by the respective nominating party. Proceedings shall continue from the stage they were at when the vacancy occurred.

If one of the parties refuses or otherwise fails to appoint an arbitrator within 30 days of the date the other party appoints its, the first appointed arbitrator shall be the sole arbitrator, provided that the arbitrator was validly and properly appointed.

All proceedings shall be conducted, including all documents presented in such proceedings, in the English language. The English language version of this Statement of Limited Warranty prevails over any other language version.

## **HONG KONG S.A.R. OF CHINA AND MACAU S.A.R. OF CHINA**

**Governing Law:** *The following replaces “laws of the country in which you acquired the Machine” in the first sentence:*

laws of Hong Kong Special Administrative Region of China.

## **INDIA**

**Limitation of Liability:** *The following replaces items 1 and 2 of this section:*

1. liability for bodily injury (including death) or damage to real property and tangible personal property will be limited to that caused by IBM's negligence; and
2. as to any other actual damage arising in any situation involving nonperformance by IBM pursuant to, or in any way related to the subject of this Statement of Limited Warranty, the charge paid by you for the individual Machine that is the subject of the claim. For purposes of this item, the term “Machine” includes Machine Code and Licensed Internal Code (“LIC”).

**Arbitration:** *The following is added under this heading:*

Disputes arising out of or in connection with this Statement of Limited Warranty shall be finally settled by arbitration which shall be held in Bangalore, India in accordance with the laws of India then in effect. The arbitration award shall be final and binding for the parties without appeal and shall be in writing and set forth the findings of fact and the conclusions of law.

The number of arbitrators shall be three, with each side to the dispute being entitled to appoint one arbitrator. The two arbitrators appointed by the parties shall appoint a third arbitrator who shall act as chairman of the proceedings. Vacancies in the post of chairman shall be filled by the president of the Bar Council of India. Other vacancies shall be filled by the respective nominating party. Proceedings shall continue from the stage they were at when the vacancy occurred.

If one of the parties refuses or otherwise fails to appoint an arbitrator within 30 days of the date the other party appoints its, the first appointed arbitrator shall be the sole arbitrator, provided that the arbitrator was validly and properly appointed.

All proceedings shall be conducted, including all documents presented in such proceedings, in the English language. The English language version of this Statement of Limited Warranty prevails over any other language version.

## **JAPAN**

**Governing Law:** *The following sentence is added to this section:*

Any doubts concerning this Statement of Limited Warranty will be initially resolved between us in good faith and in accordance with the principle of mutual trust.



## **MALAYSIA**

**Limitation of Liability:** *The word “SPECIAL” in item 3 of the fifth paragraph is deleted.*

## **NEW ZEALAND**

**What this Warranty Covers:** *The following paragraph is added to this section:*

The warranties specified in this section are in addition to any rights you may have under the Consumer Guarantees Act 1993 or other legislation which cannot be excluded or limited. The Consumer Guarantees Act 1993 will not apply in respect of any goods which IBM provides, if you require the goods for the purposes of a business as defined in that Act.

**Limitation of Liability:** *The following is added to this section:*

Where Machines are not acquired for the purposes of a business as defined in the Consumer Guarantees Act 1993, the limitations in this section are subject to the limitations in that Act.

## **PEOPLE’S REPUBLIC OF CHINA (PRC)**

**Governing Law:** *The following replaces “laws of the country in which you acquired the Machine” in the first sentence:*

laws of the State of New York, United States of America (except when local law requires otherwise).

## **PHILIPPINES**

**Limitation of Liability:** *Item 3 in the fifth paragraph is replaced by the following:*

**SPECIAL (INCLUDING NOMINAL AND EXEMPLARY DAMAGES), MORAL, INCIDENTAL, OR INDIRECT DAMAGES FOR ANY ECONOMIC CONSEQUENTIAL DAMAGES; OR**

**Arbitration:** *The following is added under this heading:*

Disputes arising out of or in connection with this Statement of Limited Warranty shall be finally settled by arbitration which shall be held in Metro Manila, Philippines in accordance with the laws of the Philippines then in effect. The arbitration award shall be final and binding for the parties without appeal and shall be in writing and set forth the findings of fact and the conclusions of law.

The number of arbitrators shall be three, with each side to the dispute being entitled to appoint one arbitrator. The two arbitrators appointed by the parties shall appoint a third arbitrator who shall act as chairman of the proceedings. Vacancies in the post of chairman shall be filled by the president of the Philippine Dispute Resolution Center, Inc. Other vacancies shall be filled by the respective nominating party. Proceedings shall continue from the stage they were at when the vacancy occurred.

If one of the parties refuses or otherwise fails to appoint an arbitrator within 30 days of the date the other party appoints its, the first appointed arbitrator shall be the sole arbitrator, provided that the arbitrator was validly and properly appointed.

All proceedings shall be conducted, including all documents presented in such proceedings, in the English language. The English language version of this Statement of Limited Warranty prevails over any other language version.

## **SINGAPORE**

**Limitation of Liability:** *The words “SPECIAL” and “ECONOMIC” in item 3 in the fifth paragraph are deleted.*

## **EUROPE, MIDDLE EAST, AFRICA (EMEA)**

### ***THE FOLLOWING TERMS APPLY TO ALL EMEA COUNTRIES:***

The terms of this Statement of Limited Warranty apply to Machines purchased from IBM or an IBM reseller.

**Hot to Obtain Warranty Service:** If you purchase a Machine in Austria, Belgium, Cyprus, Denmark, Estonia, Finland, France, Germany, Greece, Iceland, Ireland, Italy, Latvia, Liechtenstein, Lithuania, Luxembourg, Monaco, Netherlands, Norway, Portugal, Spain, San Marino, Sweden, Switzerland, United Kingdom or Vatican State, you may obtain warranty service for that Machine in any of those countries from either (1) an IBM reseller approved to perform warranty service or (2) from IBM, provided the Machine has been announced and made available by IBM in the country in which you wish to obtain service. If you purchased a Personal Computer Machine in Albania, Armenia, Belarus, Bosnia and Herzegovina, Bulgaria, Croatia, Czech Republic, Georgia, Hungary, Kazakhstan, Kyrgyzstan, Federal Republic of Yugoslavia, Former Yugoslav Republic of Macedonia (FYROM), Moldova, Poland, Romania, Russia, Slovak Republic, Slovenia, or Ukraine, you may obtain warranty service for that Machine in any of those countries from either (1) an IBM reseller approved to perform warranty service or (2) from IBM.

If you purchase a Machine in a Middle Eastern or African country, you may obtain warranty service for that Machine from the IBM entity within the country of purchase, if that IBM entity provides warranty service in that country, or from an IBM reseller, approved by IBM to perform warranty service on that Machine in that country. Warranty service in Africa is available within 50 kilometers of an IBM approved service provider. You are responsible for transportation costs for Machines located outside 50 kilometers of an IBM approved service provider.

*Add the following paragraph in **Western Europe** (Austria, Belgium, Cyprus, Denmark, Finland, France, Germany, Greece, Iceland, Ireland, Italy, Liechtenstein, Luxembourg, Monaco, Netherlands, Norway, Portugal, Spain, San Marino, Sweden, Switzerland, United Kingdom, Vatican State):*

The warranty for Machines acquired in Western Europe shall be valid and applicable in all Western Europe countries provided the Machines have been announced and made available in such countries.

### **Governing Law:**

*The phrase “the laws of the country in which you acquired the Machine” is replaced by:*

1) “the laws of Austria” in **Albania, Armenia, Azerbaijan, Belarus, Bosnia-Herzegovina, Bulgaria, Croatia, Georgia, Hungary, Kazakhstan, Kyrgyzstan, FYR Macedonia, Moldova, Poland, Romania, Russia, Slovakia, Slovenia, Tajikistan, Turkmenistan, Ukraine, Uzbekistan, and FR Yugoslavia;** 2)

“the laws of France” in **Algeria, Benin, Burkina Faso, Cameroon, Cape Verde, Central African Republic, Chad, Comoros, Congo Republic, Djibouti, Democratic Republic of Congo, Equatorial Guinea, French Guiana, French Polynesia, Gabon, Gambia, Guinea, Guinea-Bissau, Ivory Coast, Lebanon, Madagascar, Mali, Mauritania, Mauritius, Mayotte, Morocco, New Caledonia, Niger, Reunion, Senegal, Seychelles, Togo, Tunisia, Vanuatu, and Wallis & Futuna**; 3) “the laws of Finland” in **Estonia, Latvia, and Lithuania**; 4) “the laws of England” in **Angola, Bahrain, Botswana, Burundi, Egypt, Eritrea, Ethiopia, Ghana, Jordan, Kenya, Kuwait, Liberia, Malawi, Malta, Mozambique, Nigeria, Oman, Pakistan, Qatar, Rwanda, Sao Tome, Saudi Arabia, Sierra Leone, Somalia, Tanzania, Uganda, United Arab Emirates, the United Kingdom, West Bank/Gaza, Yemen, Zambia, and Zimbabwe**; and 5) “the laws of South Africa” in **South Africa, Namibia, Lesotho and Swaziland**.

**Jurisdiction:** *The following exceptions are added to this section:*

1) **In Austria** the choice of jurisdiction for all disputes arising out of this Statement of Limited Warranty and relating thereto, including its existence, will be the competent court of law in Vienna, Austria (Inner-City); 2) **in Angola, Bahrain, Botswana, Burundi, Egypt, Eritrea, Ethiopia, Ghana, Jordan, Kenya, Kuwait, Liberia, Malawi, Malta, Mozambique, Nigeria, Oman, Pakistan, Qatar, Rwanda, Sao Tome, Saudi Arabia, Sierra Leone, Somalia, Tanzania, Uganda, United Arab Emirates, West Bank/Gaza, Yemen, Zambia, and Zimbabwe** all disputes arising out of this Statement of Limited Warranty or related to its execution, including summary proceedings, will be submitted to the exclusive jurisdiction of the English courts; 3) **in Belgium and Luxembourg**, all disputes arising out of this Statement of Limited Warranty or related to its interpretation or its execution, the law, and the courts of the capital city, of the country of your registered office and/or commercial site location only are competent; 4) **in France, Algeria, Benin, Burkina Faso, Cameroon, Cape Verde, Central African Republic, Chad, Comoros, Congo Republic, Djibouti, Democratic Republic of Congo, Equatorial Guinea, French Guiana, French Polynesia, Gabon, Gambia, Guinea, Guinea-Bissau, Ivory Coast, Lebanon, Madagascar, Mali, Mauritania, Mauritius, Mayotte, Morocco, New Caledonia, Niger, Reunion, Senegal, Seychelles, Togo, Tunisia, Vanuatu, and Wallis & Futuna** all disputes arising out of this Statement of Limited Warranty or related to its violation or execution, including summary proceedings, will be settled exclusively by the Commercial Court of Paris; 5) **in Russia**, all disputes arising out of or in relation to the interpretation, the violation, the termination, the nullity of the execution of this Statement of Limited Warranty shall be settled by Arbitration Court of Moscow; 6) **in South Africa, Namibia, Lesotho and Swaziland**, both of us agree to submit all disputes relating to this Statement of Limited Warranty to the jurisdiction of the High Court in Johannesburg; 7) **in Turkey** all disputes arising out of or in connection with this Statement of Limited Warranty shall be resolved by the Istanbul Central (Sultanahmet) Courts and Execution Directorates of Istanbul, the Republic of Turkey; 8) in each of the following specified countries, any legal claim arising out of this Statement of Limited Warranty will be brought before, and settled exclusively by, the competent court of a) Athens for **Greece**, b) Tel Aviv-Jaffa for **Israel**, c) Milan for **Italy**, d) Lisbon for **Portugal**, and e) Madrid for **Spain**; and 9) **in the United Kingdom**, both of us agree to submit all disputes relating to this Statement of Limited Warranty to the jurisdiction of the English courts.

**Arbitration:** *The following is added under this heading:*

**In Albania, Armenia, Azerbaijan, Belarus, Bosnia-Herzegovina, Bulgaria, Croatia, Georgia, Hungary, Kazakhstan, Kyrgyzstan, FYR Macedonia, Moldova,**

**Poland, Romania, Russia, Slovakia, Slovenia, Tajikistan, Turkmenistan, Ukraine, Uzbekistan, and FR Yugoslavia** all disputes arising out of this Statement of Limited Warranty or related to its violation, termination or nullity will be finally settled under the Rules of Arbitration and Conciliation of the International Arbitral Center of the Federal Economic Chamber in Vienna (Vienna Rules) by three arbitrators appointed in accordance with these rules. The arbitration will be held in Vienna, Austria, and the official language of the proceedings will be English. The decision of the arbitrators will be final and binding upon both parties. Therefore, pursuant to paragraph 598 (2) of the Austrian Code of Civil Procedure, the parties expressly waive the application of paragraph 595 (1) figure 7 of the Code. IBM may, however, institute proceedings in a competent court in the country of installation.

**In Estonia, Latvia and Lithuania** all disputes arising in connection with this Statement of Limited Warranty will be finally settled in arbitration that will be held in Helsinki, Finland in accordance with the arbitration laws of Finland then in effect. Each party will appoint one arbitrator. The arbitrators will then jointly appoint the chairman. If arbitrators cannot agree on the chairman, then the Central Chamber of Commerce in Helsinki will appoint the chairman.

## **EUROPEAN UNION (EU)**

### ***THE FOLLOWING TERMS APPLY TO ALL EU COUNTRIES:***

Consumers have legal rights under applicable national legislation governing the sale of consumer goods. Such rights are not affected by the warranties provided in this Statement of Limited Warranty.

**How to Obtain Warranty Service:** *The following is added to this section:*

To obtain warranty service from IBM in EU countries, see the telephone listing in Part 3 - Warranty Information.

You may contact IBM at the following address:

IBM Warranty & Service Quality Dept.  
PO Box 30  
Spango Valley  
Greenock  
Scotland PA16 0AH

## **AUSTRIA, DENMARK, FINLAND, GREECE, ITALY, NETHERLANDS, PORTUGAL, SPAIN, SWEDEN AND SWITZERLAND**

**Limitation of Liability:** *The following replaces the terms of this section in its entirety:*

Except as otherwise provided by mandatory law:

1. IBM's liability for any damages and losses that may arise as a consequence of the fulfillment of its obligations under or in connection with this Statement of Limited Warranty or due to any other cause related to this Statement of Limited Warranty is limited to the compensation of only those damages and losses proved and actually arising as an immediate and direct consequence of the non-fulfillment of such obligations (if IBM is at fault) or of such cause, for a maximum amount equal to the charges you paid for the Machine. For purposes of this item, the term "Machine" includes Machine Code and Licensed Internal Code ("LIC").

The above limitation shall not apply to damages for bodily injuries (including death) and damages to real property and tangible personal property for which IBM is legally liable.

2. **UNDER NO CIRCUMSTANCES IS IBM, ITS SUPPLIERS OR RESELLERS LIABLE FOR ANY OF THE FOLLOWING, EVEN IF INFORMED OF THEIR POSSIBILITY: 1) LOSS OF, OR DAMAGE TO, DATA; 2) INCIDENTAL OR INDIRECT DAMAGES, OR FOR ANY ECONOMIC CONSEQUENTIAL DAMAGES; 3) LOST PROFITS, EVEN IF THEY ARISE AS AN IMMEDIATE CONSEQUENCE OF THE EVENT THAT GENERATED THE DAMAGES; OR 4) LOSS OF BUSINESS, REVENUE, GOODWILL, OR ANTICIPATED SAVINGS.**

## **FRANCE AND BELGIUM**

**Limitation of Liability:** *The following replaces the terms of this section in its entirety:*

Except as otherwise provided by mandatory law:

1. IBM's liability for any damages and losses that may arise as a consequence of the fulfillment of its obligations under or in connection with this Statement of Limited Warranty is limited to the compensation of only those damages and losses proved and actually arising as an immediate and direct consequence of the non-fulfillment of such obligations (if IBM is at fault), for a maximum amount equal to the charges you paid for the Machine that has caused the damages. For purposes of this item, the term "Machine" includes Machine Code and Licensed Internal Code ("LIC").

The above limitation shall not apply to damages for bodily injuries (including death) and damages to real property and tangible personal property for which IBM is legally liable.

2. **UNDER NO CIRCUMSTANCES IS IBM, ITS SUPPLIERS OR RESELLERS LIABLE FOR ANY OF THE FOLLOWING, EVEN IF INFORMED OF THEIR POSSIBILITY: 1) LOSS OF, OR DAMAGE TO, DATA; 2) INCIDENTAL OR INDIRECT DAMAGES, OR FOR ANY ECONOMIC CONSEQUENTIAL DAMAGES; 3) LOST PROFITS, EVEN IF THEY ARISE AS AN IMMEDIATE CONSEQUENCE OF THE EVENT THAT GENERATED THE DAMAGES; OR 4) LOSS OF BUSINESS, REVENUE, GOODWILL, OR ANTICIPATED SAVINGS.**

## **THE FOLLOWING TERMS APPLY TO THE COUNTRY SPECIFIED:**

### **AUSTRIA**

**What this Warranty Covers:** *The following replaces the first sentence of the first paragraph of this section:*

The warranty for an IBM Machine covers the functionality of the Machine for its normal use and the Machine's conformity to its Specifications.

*The following paragraphs are added to this section:*

The warranty period for Machines is 12 months from the date of delivery. The limitation period for consumers in action for breach of warranty is the statutory period as a minimum. In case IBM or your reseller is unable to repair an IBM Machine, you can alternatively ask for a partial refund as far as justified by the reduced value of the unrepaired Machine or ask for a cancellation of the respective agreement for such Machine and get your money refunded.

*The second paragraph does not apply.*

**What IBM Will Do to Correct Problems:** *The following is added to this section:*

During the warranty period, transportation for delivery of the failing Machine to IBM will be at IBM's expense.

**Limitation of Liability:** *The following paragraph is added to this section:*

The limitations and exclusions specified in the Statement of Limited Warranty will not apply to damages caused by IBM with fraud or gross negligence and for express warranty.

*The following sentence is added to the end of item 2:*

IBM's liability under this item is limited to the violation of essential contractual terms in cases of ordinary negligence.

## **EGYPT**

**Limitation of Liability:** *The following replaces item 2 in this section:*

as to any other actual direct damages, IBM's liability will be limited to the total amount you paid for the Machine that is the subject of the claim. For purposes of this item, the term "Machine" includes Machine Code and Licensed Internal Code ("LIC").

*Applicability of suppliers and resellers (unchanged).*

## **FRANCE**

**Limitation of Liability:** *The following replaces the second sentence of the first paragraph of this section:*

In such instances, regardless of the basis on which you are entitled to claim damages from IBM, IBM is liable for no more than: (items 1 and 2 unchanged).

## **GERMANY**

**What this Warranty Covers:** *The following replaces the first sentence of the first paragraph of this section:*

The warranty for an IBM Machine covers the functionality of the Machine for its normal use and the Machine's conformity to its Specifications.

*The following paragraphs are added to this section:*

The minimum warranty period for Machines is twelve months. In case IBM or your reseller is unable to repair an IBM Machine, you can alternatively ask for a partial refund as far as justified by the reduced value of the unrepaired Machine or ask for a cancellation of the respective agreement for such Machine and get your money refunded.

*The second paragraph does not apply.*

**What IBM Will Do to Correct Problems:** *The following is added to this section:*



During the warranty period, transportation for delivery of the failing Machine to IBM will be at IBM's expense.

**Limitation of Liability:** *The following paragraph is added to this section:*

The limitations and exclusions specified in the Statement of Limited Warranty will not apply to damages caused by IBM with fraud or gross negligence and for express warranty.

*The following sentence is added to the end of item 2:*

IBM's liability under this item is limited to the violation of essential contractual terms in cases of ordinary negligence.

## **HUNGARY**

**Limitation of Liability:** *The following is added at the end of this section:*

The limitation and exclusion specified herein shall not apply to liability for a breach of contract damaging life, physical well-being, or health that has been caused intentionally, by gross negligence, or by a criminal act.

The parties accept the limitations of liability as valid provisions and state that the Section 314.(2) of the Hungarian Civil Code applies as the acquisition price as well as other advantages arising out of the present Statement of Limited Warranty balance this limitation of liability.

## **IRELAND**

**What this Warranty Covers:** *The following is added to this section:*

Except as expressly provided in these terms and conditions, all statutory conditions, including all warranties implied, but without prejudice to the generality of the foregoing all warranties implied by the Sale of Goods Act 1893 or the Sale of Goods and Supply of Services Act 1980 are hereby excluded.

**Limitation of Liability:** *The following replaces the terms of this section in its entirety:*

For the purposes of this section, a "Default" means any act, statement, omission, or negligence on the part of IBM in connection with, or in relation to, the subject matter of this Statement of Limited Warranty in respect of which IBM is legally liable to you, whether in contract or tort. A number of Defaults which together result in, or contribute to, substantially the same loss or damage will be treated as one Default occurring on the date of occurrence of the last such Default.

Circumstances may arise where, because of a Default, you are entitled to recover damages from IBM.

This section sets out the extent of IBM's liability and your sole remedy.

1. IBM will accept unlimited liability for death or personal injury caused by the negligence of IBM.
2. Subject always to the **Items for Which IBM is Not Liable** below, IBM will accept unlimited liability for physical damage to your tangible property resulting from the negligence of IBM.

3. Except as provided in items 1 and 2 above, IBM's entire liability for actual damages for any one Default will not in any event exceed the greater of 1) EUR 125,000, or 2) 125% of the amount you paid for the Machine directly relating to the Default.

#### **Items for Which IBM is Not Liable**

Save with respect to any liability referred to in item 1 above, under no circumstances is IBM, its suppliers or resellers liable for any of the following, even if IBM or they were informed of the possibility of such losses:

1. loss of, or damage to, data;
2. special, indirect, or consequential loss; or
3. loss of profits, business, revenue, goodwill, or anticipated savings.

#### **SLOVAKIA**

**Limitation of Liability:** *The following is added to the end of the last paragraph:*

The limitations apply to the extent they are not prohibited under §§ 373-386 of the Slovak Commercial Code.

#### **SOUTH AFRICA, NAMIBIA, BOTSWANA, LESOTHO AND SWAZILAND**

**Limitation of Liability:** *The following is added to this section:*

IBM's entire liability to you for actual damages arising in all situations involving nonperformance by IBM in respect of the subject matter of this Statement of Warranty will be limited to the charge paid by you for the individual Machine that is the subject of your claim from IBM.

#### **UNITED KINGDOM**

**Limitation of Liability:** *The following replaces the terms of this section in its entirety:*

For the purposes of this section, a "Default" means any act, statement, omission, or negligence on the part of IBM in connection with, or in relation to, the subject matter of this Statement of Limited Warranty in respect of which IBM is legally liable to you, whether in contract or tort. A number of Defaults which together result in, or contribute to, substantially the same loss or damage will be treated as one Default.

Circumstances may arise where, because of a Default, you are entitled to recover damages from IBM.

This section sets out the extent of IBM's liability and your sole remedy.

1. IBM will accept unlimited liability for:
  - a. death or personal injury caused by the negligence of IBM; and
  - b. any breach of its obligations implied by Section 12 of the Sale of Goods Act 1979 or Section 2 of the Supply of Goods and Services Act 1982, or any statutory modification or re-enactment of either such Section.
2. IBM will accept unlimited liability, subject always to the **Items for Which IBM is Not Liable** below, for physical damage to your tangible property resulting from the negligence of IBM.
3. IBM's entire liability for actual damages for any one Default will not in any event, except as provided in items 1 and 2 above, exceed the greater of 1) Pounds



Sterling 75,000, or 2) 125% of the total purchase price payable or the charges for the Machine directly relating to the Default.

These limits also apply to IBM's suppliers and resellers. They state the maximum for which IBM and such suppliers and resellers are collectively responsible.

### Items for Which IBM is Not Liable

Save with respect to any liability referred to in item 1 above, under no circumstances is IBM or any of its suppliers or resellers liable for any of the following, even if IBM or they were informed of the possibility of such losses:

1. loss of, or damage to, data;
2. special, indirect, or consequential loss; or
3. loss of profits, business, revenue, goodwill, or anticipated savings.

---

## Part 3 - Warranty Information

This Part 3 provides information regarding the warranty applicable to your Machine, including the warranty period and type of warranty service IBM provides.

### Warranty Period

The warranty period may vary by country or region and is specified in the table below.

**Note:** "Region" means either Hong Kong or Macau Special Administrative Region of China.

### Machine - @server BladeCenter Type 8677

Country or Region of Purchase	Warranty Period	Type of Warranty Service*
Worldwide	Parts - 3 years, labor - 3 years	2
* See " <a href="#">Types of Warranty Service</a> " for the legend and explanations of warranty-service types.		

A warranty period of 3 years on parts and 1 year on labor means that IBM provides warranty service without charge for:

1. parts and labor during the first year of the warranty period; and
2. parts only, on an exchange basis, in the second and third years of the warranty period. IBM will charge you for any labor provided in performance of the repair or replacement(s) in the second and third year of the warranty period.

### Types of Warranty Service

If required, IBM provides repair or exchange service depending on the type of warranty service specified for your Machine in the above table and as described below. Warranty service may be provided by your reseller if approved by IBM to perform warranty service. Scheduling of service will depend upon the time of your call and is subject to parts availability. Service levels are response time objectives and are not guaranteed. The specified level of warranty service may not be available in all worldwide locations, additional charges may apply outside IBM's normal service area, contact your local IBM representative or your reseller for country and location specific information.

#### 1. Customer Replaceable Unit ("CRU") Service

IBM will ship CRU parts to you for your replacement. If IBM instructs you to return the replaced CRU, you are responsible for returning it to IBM in accordance with IBM's instructions. If you do not return the defective CRU, if IBM so instructs, within 30 days of your receipt of the replacement CRU, IBM may charge you for the replacement.

**2. On-site Service**

IBM or your reseller will either repair or exchange the failing Machine at your location and verify its operation. You must provide suitable working area to allow disassembly and reassembly of the IBM Machine. The area must be clean, well lit and suitable for the purpose. **For some Machines, certain repairs may require sending the Machine to an IBM service center.**

**3. Courier or Depot Service\***

You will disconnect the failing Machine for collection arranged by IBM. IBM will provide you with a shipping container for you to return your Machine to a designated service center. A courier will pick up your Machine and deliver it to the designated service center. Following its repair or exchange, IBM will arrange the return delivery of the Machine to your location. You are responsible for its installation and verification.

**4. Customer Carry-In or Mail-In Service**

You will deliver or mail as IBM specifies (prepaid unless IBM specifies otherwise) the failing Machine suitably packaged to a location IBM designates. After IBM has repaired or exchanged the Machine, IBM will make it available for your collection or, for Mail-in Service, IBM will return it to you at IBM's expense, unless IBM specifies otherwise. You are responsible for the subsequent installation and verification of the Machine.

\* This type of service is called ThinkPad® EasyServ or EasyServ in some countries.

The IBM Machine Warranty World Wide Web site at [http://www.ibm.com/servers/support/machine\\_warranties/](http://www.ibm.com/servers/support/machine_warranties/) provides a worldwide overview of IBM Limited Warranty for Machines, a Glossary of IBM definitions, Frequently Asked Questions (FAQs) and Support by Product (Machine) with links to Product Support pages. **The IBM Statement of Limited Warranty is also available on this site in 29 languages.**

To obtain warranty service contact IBM or your IBM reseller. In Canada or the United States, call 1-800-IBM-SERV (426-7378). In the EU countries, see the telephone numbers below.

**EU Country Telephone List**

Phone numbers are subject to change without notice.

Austria -- 43-1-24592-5901	Italy -- 39-02-482-9202
Belgium -- 02-718-4339	Luxembourg -- 352-360385-1
Denmark -- 4520-8200	Netherlands -- 020-514-5770
Finland -- 358-9-4591	Portugal -- 351-21-7915-147
France -- 0238-557-450	Spain -- 34-91-662-4916
Germany -- 07032-15-4920	Sweden -- 46-8-477-4420
Greece -- 30-210-688-1220	United Kingdom -- 01475-555-055
Ireland -- 353-1-815-4000	

---

## Appendix C. Notices

This publication was developed for products and services offered in the U.S.A.

IBM may not offer the products, services, or features discussed in this document in other countries. Consult your local IBM representative for information on the products and services currently available in your area. Any reference to an IBM product, program, or service is not intended to state or imply that only that IBM product, program, or service may be used. Any functionally equivalent product, program, or service that does not infringe any IBM intellectual property right may be used instead. However, it is the user's responsibility to evaluate and verify the operation of any non-IBM product, program, or service.

IBM may have patents or pending patent applications covering subject matter described in this document. The furnishing of this document does not give you any license to these patents. You can send license inquiries, in writing, to:

*IBM Director of Licensing  
IBM Corporation  
North Castle Drive  
Armonk, NY 10504-1785  
U.S.A.*

INTERNATIONAL BUSINESS MACHINES CORPORATION PROVIDES THIS PUBLICATION "AS IS" WITHOUT WARRANTY OF ANY KIND, EITHER EXPRESS OR IMPLIED, INCLUDING, BUT NOT LIMITED TO, THE IMPLIED WARRANTIES OF NON-INFRINGEMENT, MERCHANTABILITY OR FITNESS FOR A PARTICULAR PURPOSE. Some jurisdictions do not allow disclaimer of express or implied warranties in certain transactions, therefore, this statement may not apply to you.

This information could include technical inaccuracies or typographical errors. Changes are periodically made to the information herein; these changes will be incorporated in new editions of the publication. IBM may make improvements and/or changes in the product(s) and/or the program(s) described in this publication at any time without notice.

Any references in this publication to non-IBM Web sites are provided for convenience only and do not in any manner serve as an endorsement of those Web sites. The materials at those Web sites are not part of the materials for this IBM product, and use of those Web sites is at your own risk.

IBM may use or distribute any of the information you supply in any way it believes appropriate without incurring any obligation to you.

---

### Edition notice

© COPYRIGHT INTERNATIONAL BUSINESS MACHINES CORPORATION, 2002, 2003. All rights reserved.

U.S. Government Users Restricted Rights — Use, duplication or disclosure restricted by GSA ADP Schedule Contract with IBM Corp.

---

## Trademarks

The following terms are trademarks of International Business Machines Corporation in the United States, other countries, or both:

Active Memory	Predictive Failure Analysis
Active PCI	PS/2
Active PCI-X	ServeRAID
Alert on LAN	ServerGuide
BladeCenter	ServerProven
C2T Interconnect	TechConnect
Chipkill	Tivoli
EtherJet	Tivoli Enterprise
e-business logo	Update Connector
FlashCopy	Wake on LAN
IBM	XA-32
IntelliStation	XA-64
NetBAY	X-Architecture
Netfinity	Xcel4
NetView	XpandOnDemand
OS/2 WARP	xSeries

Lotus, Lotus Notes, and Domino are trademarks of Lotus Development Corporation and/or IBM Corporation in the United States, other countries, or both.

ActionMedia, LANDesk, MMX, Pentium, and ProShare are trademarks of Intel Corporation in the United States, other countries, or both.

Microsoft, Windows, and Windows NT are trademarks of Microsoft Corporation in the United States, other countries, or both.

UNIX is a registered trademark of The Open Group in the United States and other countries.

Java and all Java-based trademarks and logos are trademarks or registered trademarks of Sun Microsystems, Inc. in the United States, other countries, or both.

Other company, product, or service names may be trademarks or service marks of others.

---

## Important notes

Processor speeds indicate the internal clock speed of the microprocessor; other factors also affect application performance.

CD-ROM drive speeds list the variable read rate. Actual speeds vary and are often less than the maximum possible.

When referring to processor storage, real and virtual storage, or channel volume, KB stands for approximately 1000 bytes, MB stands for approximately 1 000 000 bytes, and GB stands for approximately 1 000 000 000 bytes.

When referring to hard disk drive capacity or communications volume, MB stands for 1 000 000 bytes, and GB stands for 1 000 000 000 bytes. Total user-accessible capacity may vary depending on operating environments.

Maximum internal hard disk drive capacities assume the replacement of any standard hard disk drives and population of all hard disk drive bays with the largest currently supported drives available from IBM.

Maximum memory may require replacement of the standard memory with an optional memory module.

IBM makes no representation or warranties regarding non-IBM products and services that are ServerProven, including but not limited to the implied warranties of merchantability and fitness for a particular purpose. These products are offered and warranted solely by third parties.

IBM makes no representations or warranties with respect to non-IBM products. Support (if any) for the non-IBM products is provided by the third party, not IBM.

Some software may differ from its retail version (if available), and may not include user manuals or all program functionality.

---

## Product recycling and disposal

This unit contains materials such as circuit boards, cables, electromagnetic compatibility gaskets, and connectors which may contain lead and copper/beryllium alloys that require special handling and disposal at end of life. Before this unit is disposed of, these materials must be removed and recycled or discarded according to applicable regulations. IBM offers product-return programs in several countries. Information on product recycling offerings can be found on IBM's Internet site at <http://www.ibm.com/ibm/environment/products/prp.shtml>.

---

## Battery return program

This product may contain a sealed lead acid, nickel cadmium, nickel metal hydride, lithium, or lithium ion battery. Consult your user manual or service manual for specific battery information. The battery must be recycled or disposed of properly. Recycling facilities may not be available in your area. For information on disposal of batteries outside the United States, go to <http://www.ibm.com/ibm/environment/products/batteryrecycle.shtml> or contact your local waste disposal facility.

In the United States, IBM has established a collection process for reuse, recycling, or proper disposal of used IBM sealed lead acid, nickel cadmium, nickel metal hydride, and battery packs from IBM equipment. For information on proper disposal of these batteries, contact IBM at 1-800-426-4333. Have the IBM part number listed on the battery available prior to your call.

In the Netherlands, the following applies.



---

## Electronic emission notices

IBM BladeCenter Type 8677

### Federal Communications Commission (FCC) statement

**Note:** This equipment has been tested and found to comply with the limits for a Class A digital device, pursuant to Part 15 of the FCC Rules. These limits are designed to provide reasonable protection against harmful interference when the equipment is operated in a commercial environment. This equipment generates, uses, and can radiate radio frequency energy and, if not installed and used in accordance with the instruction manual, may cause harmful interference to radio communications. Operation of this equipment in a residential area is likely to cause harmful interference, in which case the user will be required to correct the interference at his own expense.

Properly shielded and grounded cables and connectors must be used in order to meet FCC emission limits. Properly shielded and grounded cables and connectors must be used in order to meet FCC emission limits. IBM is not responsible for any radio or television interference caused by using other than recommended cables and connectors or by using other than recommended cables and connectors or by unauthorized changes or modifications to this equipment. Unauthorized changes or modifications could void the user's authority to operate the equipment.

This device complies with Part 15 of the FCC Rules. Operation is subject to the following two conditions: (1) this device may not cause harmful interference, and (2) this device must accept any interference received, including interference that may cause undesired operation.

### Industry Canada Class A emission compliance statement

This Class A digital apparatus complies with Canadian ICES-003.

#### Avis de conformité à la réglementation d'Industrie Canada

Cet appareil numérique de la classe A est conforme à la norme NMB-003 du Canada.

### Australia and New Zealand Class A statement

**Attention:** This is a Class A product. In a domestic environment this product may cause radio interference in which case the user may be required to take adequate measures.

### United Kingdom telecommunications safety requirement

#### Notice to Customers

This apparatus is approved under approval number NS/G/1234/J/100003 for indirect connection to public telecommunication systems in the United Kingdom.

### European Union EMC Directive conformance statement

This product is in conformity with the protection requirements of EU Council Directive 89/336/EEC on the approximation of the laws of the Member States relating to electromagnetic compatibility. IBM cannot accept responsibility for any failure to satisfy the protection requirements resulting from a nonrecommended modification of the product, including the fitting of non-IBM option cards.

This product has been tested and found to comply with the limits for Class A Information Technology Equipment according to CISPR 22/European Standard EN 55022. The limits for Class A equipment were derived for commercial and industrial environments to provide reasonable protection against interference with licensed communication equipment.

**Attention:** This is a Class A product. In a domestic environment this product may cause radio interference in which case the user may be required to take adequate measures.

## Taiwanese Class A warning statement

警告使用者：  
這是甲類的資訊產品，在居住的環境中使用時，可能會造成射頻干擾，在這種情況下，使用者會被要求採取某些適當的對策。

## Chinese Class A warning statement

聲 明  
此為 A 級產品。在生活環境中，該產品可能會造成無線電干擾。在這種情況下，可能需要用戶對其干擾採取切实可行的措施。

## Japanese Voluntary Control Council for Interference (VCCI) statement

この装置は、情報処理装置等電波障害自主規制協議会（VCCI）の基準に基づくクラスA情報技術装置です。この装置を家庭環境で使用すると電波妨害を引き起こすことがあります。この場合には使用者が適切な対策を講ずるよう要求されることがあります。

---

## Power cords

For your safety, IBM provides a power cord with a grounded attachment plug to use with this IBM product. To avoid electrical shock, always use the power cord and plug with a properly grounded outlet.

IBM power cords used in the United States and Canada are listed by Underwriter's Laboratories (UL) and certified by the Canadian Standards Association (CSA).



For units intended to be operated at 115 volts: Use a UL-listed and CSA-certified cord set consisting of a minimum 18 AWG, Type SVT or SJT, three-conductor cord, a maximum of 15 feet in length and a parallel blade, grounding-type attachment plug rated 15 amperes, 125 volts.

For units intended to be operated at 230 volts (U.S. use): Use a UL-listed and CSA-certified cord set consisting of a minimum 18 AWG, Type SVT or SJT, three-conductor cord, a maximum of 15 feet in length and a tandem blade, grounding-type attachment plug rated 15 amperes, 250 volts.

For units intended to be operated at 230 volts (outside the U.S.): Use a cord set with a grounding-type attachment plug. The cord set should have the appropriate safety approvals for the country in which the equipment will be installed.

IBM power cords for a specific country or region are usually available only in that country or region.

<b>IBM power cord part number</b>	<b>Used in these countries and regions</b>
02K0546	China
13F9940	Australia, Fiji, Kiribati, Nauru, New Zealand, Papua New Guinea
13F9979	Afghanistan, Albania, Algeria, Andorra, Angola, Armenia, Austria, Azerbaijan, Belarus, Belgium, Benin, Bosnia and Herzegovina, Bulgaria, Burkina Faso, Burundi, Cambodia, Cameroon, Cape Verde, Central African Republic, Chad, Comoros, Congo (Democratic Republic of), Congo (Republic of), Cote D'Ivoire (Ivory Coast), Croatia (Republic of), Czech Republic, Dahomey, Djibouti, Egypt, Equatorial Guinea, Eritrea, Estonia, Ethiopia, Finland, France, French Guyana, French Polynesia, Germany, Greece, Guadeloupe, Guinea, Guinea Bissau, Hungary, Iceland, Indonesia, Iran, Kazakhstan, Kyrgyzstan, Laos (People's Democratic Republic of), Latvia, Lebanon, Lithuania, Luxembourg, Macedonia (former Yugoslav Republic of), Madagascar, Mali, Martinique, Mauritania, Mauritius, Mayotte, Moldova (Republic of), Monaco, Mongolia, Morocco, Mozambique, Netherlands, New Caledonia, Niger, Norway, Poland, Portugal, Reunion, Romania, Russian Federation, Rwanda, Sao Tome and Principe, Saudi Arabia, Senegal, Serbia, Slovakia, Slovenia (Republic of), Somalia, Spain, Suriname, Sweden, Syrian Arab Republic, Tajikistan, Tahiti, Togo, Tunisia, Turkey, Turkmenistan, Ukraine, Upper Volta, Uzbekistan, Vanuatu, Vietnam, Wallis and Futuna, Yugoslavia (Federal Republic of), Zaire
13F9997	Denmark
14F0015	Bangladesh, Lesotho, Maceo, Maldives, Namibia, Nepal, Pakistan, Samoa, South Africa, Sri Lanka, Swaziland, Uganda
14F0033	Abu Dhabi, Bahrain, Botswana, Brunei Darussalam, Channel Islands, China (Hong Kong S.A.R.), Cyprus, Dominica, Gambia, Ghana, Grenada, Iraq, Ireland, Jordan, Kenya, Kuwait, Liberia, Malawi, Malaysia, Malta, Myanmar (Burma), Nigeria, Oman, Polynesia, Qatar, Saint Kitts and Nevis, Saint Lucia, Saint Vincent and the Grenadines, Seychelles, Sierra Leone, Singapore, Sudan, Tanzania (United Republic of), Trinidad and Tobago, United Arab Emirates (Dubai), United Kingdom, Yemen, Zambia, Zimbabwe
14F0051	Liechtenstein, Switzerland
14F0069	Chile, Italy, Libyan Arab Jamahiriya



<b>IBM power cord part number</b>	<b>Used in these countries and regions</b>
14F0087	Israel
1838574	Antigua and Barbuda, Aruba, Bahamas, Barbados, Belize, Bermuda, Bolivia, Brazil, Caicos Islands, Canada, Cayman Islands, Costa Rica, Colombia, Cuba, Dominican Republic, Ecuador, El Salvador, Guam, Guatemala, Haiti, Honduras, Jamaica, Japan, Mexico, Micronesia (Federal States of), Netherlands Antilles, Nicaragua, Panama, Peru, Philippines, Taiwan, United States of America, Venezuela
24P6858	Korea (Democratic People's Republic of), Korea (Republic of)
34G0232	Japan
36L8880	Argentina, Paraguay, Uruguay
49P2078	India
49P2110	Brazil
6952300	Antigua and Barbuda, Aruba, Bahamas, Barbados, Belize, Bermuda, Bolivia, Caicos Islands, Canada, Cayman Islands, Colombia, Costa Rica, Cuba, Dominican Republic, Ecuador, El Salvador, Guam, Guatemala, Haiti, Honduras, Jamaica, Mexico, Micronesia (Federal States of), Netherlands Antilles, Nicaragua, Panama, Peru, Philippines, Saudi Arabia, Thailand, Taiwan, United States of America, Venezuela



---

# Index

## A

- ac power LED 34
- acoustic attenuation module
  - about 21
  - installing 22
  - removing 22
- acoustical noise emissions 6
- activity LED
  - CD-ROM drive 31
  - diskette drive 31
- availability features 9

## B

- blower error LED 34
- blower module 18, 55
- Broadcom NetXtreme Software CD 48

## C

- cabling
  - remote connection Ethernet port 39
  - switch module connectors 28
- CD-ROM drive
  - activity LED 31
  - eject button 31
  - specifications 6
- Class A electronic emission notice 80
- components
  - location of 10
  - major 10
- configuration file
  - restoring 44
  - saving 44
- Configuration/Setup Utility program 42
- configuring
  - BladeCenter unit 37
  - Ethernet controllers 48
- connector
  - Ethernet
    - on I/O modules 28
    - remote management and console 27
  - input/output 26
  - keyboard 27
  - PS/2 mouse 27
  - remote management 27
  - Universal Serial Bus 31
  - video 27
- controls 31
- cooling 6

## D

- dc power LED
  - power module 34
- diagnostic tools 53
- difficulty communicating with replacement module 44

- diskette
  - eject button 31
- diskette drive
  - activity LED 31
  - specifications 6

## E

- eject button
  - CD 31
  - diskette 31
- electrical input 6
- electronic emission Class A notice 80
- environment 6
- Ethernet
  - configuring 48
  - configuring remote connection 39
  - integrated on blade server system board 48
  - port, cabling 39
- Ethernet connector, remote management and console 27
- Ethernet failover, supporting 47
- Ethernet-link status LED 39
  - management module 35

## F

- failover 47
- failover, Ethernet 47
- FCC Class A notice 80
- features
  - BladeCenter unit 6
  - reliability, availability, and serviceability 9
  - server 7

## H

- handling
  - static-sensitive devices 14
- hardware problems 53
- heat output 6

## I

- I/O module 16
- information LED
  - BladeCenter 36
  - system LED panel 36
- installing
  - blade 22
  - in a rack 13
  - module 18
  - options 13
- IP addresses, default 40
- IP reset button, management module 35, 44

## K

keyboard connector 27

## L

### LEDs

- ac power 34
- active, management module 35
- blower 34
- CD-ROM drive activity 31
- dc power 34
- diskette drive activity 31
- error
  - blower 34
  - management module 35
  - system 36
- Ethernet-link status 35, 39
- front of server 36
- front view 31
- information
  - system LED panel 36
- location
  - blade server 36
  - BladeCenter 36
- over-temp 36
- power-on
  - management module 35
  - system LED panel 36
- rear view 33
- system error
  - blade server 36
  - system LED panel 36
  - system LED panel 36
- light path diagnostics feature 53, 56
- light path diagnostics table 57

## M

- major components 10
- management module 15
  - redundant
    - automatic changeover 57
- module
  - blower 18
  - I/O 16
  - installing 18
  - management 15
  - power 17
  - removing 20
- mouse connector 27

## N

- network connections, redundant 8
- network, connecting 39
- notes, important 78
- notices
  - electronic emission 80
  - FCC, Class A 80

## O

- options
  - installing 13
- over-temp LED 36

## P

- planning guide 40
- port
  - See connector
- power cords 81
- power module 17
  - specifications 6
- power supply
  - specifications 6
- power-on LED
  - management module 35
  - system LED panel 36
- problem
  - blower 55
  - hardware 53
  - management module 55
  - monitor 54
  - option 56
  - power 55
  - solving 53
- product
  - data 1

## R

- rack, installing BladeCenter in 13
- RAS.
  - reliability, availability, and serviceability 9
- redundant
  - components 8
  - network connection capabilities 8
- reliability features 9
- remote management connector 27
- removing
  - blade 25
  - module 20
- replacement module, difficulty communicating with 44
- restoring configuration file 44

## S

- saving configuration file 44
- serviceability features 9
- size 6
- specifications 6
- static electricity 14
- static-sensitive devices
  - handling 14
- status LEDs 31, 33, 36
- system error LED
  - system LED panel 36
- system LED panel 36
- system LED panel, front 31
- system LED panel, rear 33

system reliability 14

## **T**

temperature 6

trademarks 78

troubleshooting 53

charts 54

## **U**

United States electronic emission Class A notice 80

United States FCC Class A notice 80

utility

Configuration/Setup 42

## **V**

video connector 27

video output, unexpected or blank 51

## **W**

Web browsers, supported 37

Web site

compatible options 14

weight 6







Part Number: 59P6595

Printed in U.S.A.

(1P) P/N: 59P6595





## Free Manuals Download Website

<http://myh66.com>

<http://usermanuals.us>

<http://www.somanuals.com>

<http://www.4manuals.cc>

<http://www.manual-lib.com>

<http://www.404manual.com>

<http://www.luxmanual.com>

<http://aubethermostatmanual.com>

Golf course search by state

<http://golfingnear.com>

Email search by domain

<http://emailbydomain.com>

Auto manuals search

<http://auto.somanuals.com>

TV manuals search

<http://tv.somanuals.com>