

ProMix[®] 2KE

3A0869H

Meter-Based Plural Component Proportioner

EN

Self-contained, electronic plural component paint proportioner. For professional use only.



Important Safety Instructions

Read all warnings and instructions in this manual. Save these instructions.

See page 3 for model information, including maximum working pressure and approvals.

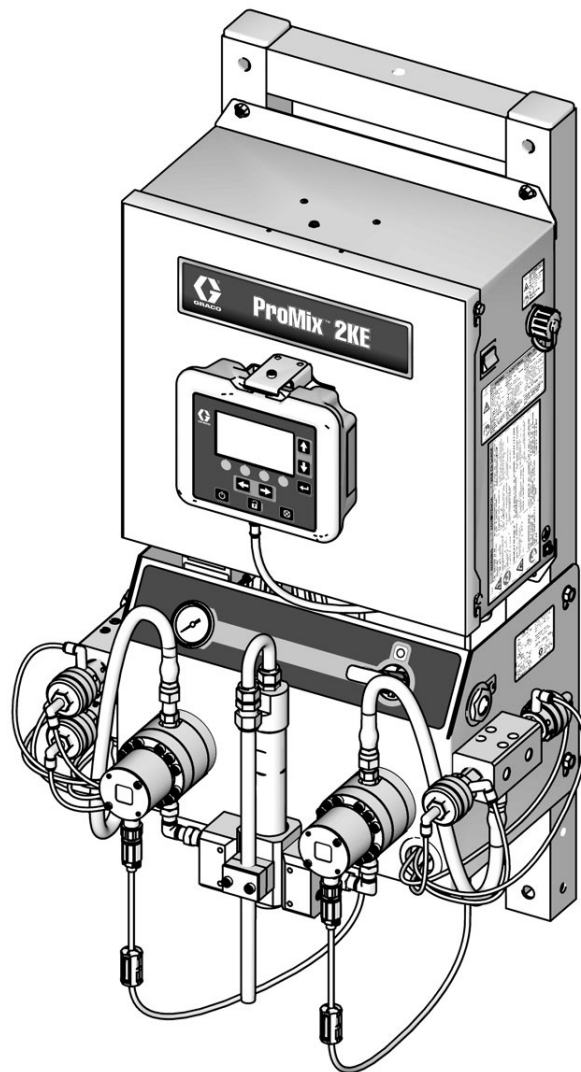

ti15698a





PROVEN QUALITY. LEADING TECHNOLOGY.

Contents

Models	3	Use of Optional USB Module	39
Related Manuals	4	USB Logs	39
Warnings	4	Setup	40
Important Two-Component Material Information .	7	Download Procedure	41
Isocyanate Conditions	7	Recommended USB Flash Drives	41
Material Self-ignition	7	Run Mode Details	42
Keep Components A and B Separate	7	Run Mix Spray (Screen 2)	42
Moisture Sensitivity of Isocyanates	7	Run Home (Screen 1)	42
Changing Materials	7	Run Mix Batch (Screen 3)	42
Glossary of Terms	8	Run Mix Totals (Screen 4)	43
Overview	9	Run Job Number (Screen 38)	43
Usage	9	Run Log Errors (Screens 5-14)	44
Component Identification and Definition	9	Setup Mode Details	45
Installation	9	Password (Screen 16)	45
General Information	9	Setup Home (Screen 17)	45
Intrinsically Safe Installation Requirements . . .	10	Configure 1-4 (Screens 18-21)	45
Display Module	12	Recipe 0 (Screen 27)	47
Air Supply	12	Recipe 1-1 (Screen 28)	47
Fluid Supply	14	Recipe 1-2 (Screen 29)	47
Tubing Chart and Diagrams	18	Maintenance 1-3 (Screens 24-26)	48
Electrical	20	Maintenance Recommendations	48
Grounding	21	Calibration 1 and 2 (Screens 22 and 23)	49
Check Resistance	21	Troubleshooting (Screens 35-37)	49
Display Module	23	Dosing Options	51
Display	23	Sequential Dosing	51
Icon Key	24	Dynamic Dosing	53
Screen Summary	25	System Errors	55
Ranges for User Inputs	26	System Alarms	55
Basic Operation	31	System Advisory/Record Codes	55
Pre-Operation Tasks	31	To Clear Error and Restart	55
Power On	31	Air Flow Switch (AFS) Function	55
Initial System Setup	31	System Idle Notice (IDLE)	56
Prime the System	32	Error Codes	57
Meter Calibration	32	Alarm Troubleshooting	58
Spraying	33	Dynamic Dosing Restrictor Selection Graphs ..	65
Purging	34	Schematics	72
Color Change	35	Dimensions and Mounting	78
Purge/Color Change Detail	36	Technical Data	79
Pressure Relief Procedure	37	Graco Standard Warranty	80
Lock Mode	38		
Valve Settings	38		
Shutdown	38		

Models

			
ProMix 2KE systems are not approved for use in hazardous locations unless the base model, all accessories, all kits, and all wiring meet local, state, and national codes.			

Approved for Hazardous Location*				
Class 1, Div 1, Group D (North America); Class 1, Zones 1 and 2 (Europe)				
Part No.	Series	Description	Maximum Working Pressure psi (MPa, bar)	USB Port
24F084	A	1 color/1 catalyst	3000 (27.58, 275.8)	
24F085	A	3 colors/1 catalyst	3000 (27.58, 275.8)	
24F086	A	1 color/1 catalyst	3000 (27.58, 275.8)	✓
24F087	A	3 colors/1 catalyst	3000 (27.58, 275.8)	✓

Approvals*

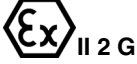

Ex ia px IIA T3 Ta = 0°C to 54°C
FM10 ATEX 0025 X





**Intrinsically safe and purged
equipment for
Class I, Division 1, Group D, T3
Ta = 0°C to 54°C**



See Special Conditions for Safe Use in **Related Manuals**, page 4.

* ProMix 2KE hazardous location equipment manufactured in the United States, with serial number beginning with A or 01, has ATEX, FM, and CE approvals, as noted. Equipment manufactured in Belgium, with serial number beginning with M or 38, has ATEX and CE approvals, as noted.

Approved for Non-Hazardous Location					
Part No.	Series	Description	Maximum Working Pressure psi (MPa, bar)	USB Port	Approvals*
24F080	A	1 color/1 catalyst	3000 (27.58, 275.8)		
24F081	A	3 colors/1 catalyst	3000 (27.58, 275.8)		
24F082	A	1 color/1 catalyst	3000 (27.58, 275.8)	✓	
24F083	A	3 colors/1 catalyst	3000 (27.58, 275.8)	✓	

* ProMix 2KE non-hazardous location equipment manufactured in the United States, with serial number beginning with A or 01, has FM and CE approvals. Equipment manufactured in Belgium, with serial number beginning with M or 38, has CE approval.



Related Manuals





Manual	Description
3A0870	ProMix 2KE, Repair/Parts
313599	Coriolis Meter, Instructions/Parts
308778	G3000 Flow Meter, Instructions/Parts
312781	Fluid Mix Manifold, Instructions/Parts
312782	Dosing Valve, Instructions/Parts
312784	Gun Flush Box Kit 15V826
406714	Rebuild Kit for High Pressure Dispense Valve
406823	Dispense Valve Seat Kit

Manual	Description
3A1244	Graco Control Architecture Module Programming
3A1323	16G353 Alternator Conversion Kit
3A1324	16G351 Electric Power Conversion Kit
3A1325	ProMix 2KE Stand Kits
3A1332	24H255 3-Color Valve Stack Kit
3A1333	24H253 USB Module Kit
313542	Beacon Tower

Warnings

The following warnings are for the setup, use, grounding, maintenance, and repair of this equipment. The exclamation point symbol alerts you to a general warning and the hazard symbols refer to procedure-specific risks. When these symbols appear in the body of this manual, refer back to these Warnings. Product-specific hazard symbols and warnings not covered in this section may appear throughout the body of this manual where applicable.

 WARNING	
	<p>FIRE AND EXPLOSION HAZARD</p> <p>Flammable fumes, such as solvent and paint fumes, in work area can ignite or explode. To help prevent fire and explosion:</p> <ul style="list-style-type: none"> • Use equipment only in well ventilated area. • Eliminate all ignition sources; such as pilot lights, cigarettes, portable electric lamps, and plastic drop cloths (potential static arc). • Keep work area free of debris, including solvent, rags and gasoline. • Do not plug or unplug power cords, or turn power or light switches on or off when flammable fumes are present. • Ground all equipment in the work area. See Grounding instructions. • Use only grounded hoses. • Hold gun firmly to side of grounded pail when triggering into pail. • If there is static sparking or you feel a shock, stop operation immediately. Do not use equipment until you identify and correct the problem. • Keep a working fire extinguisher in the work area.
	<p>SPECIAL CONDITIONS FOR SAFE USE</p> <ul style="list-style-type: none"> • To prevent the risk of electrostatic sparking, the equipment's non-metallic parts should be cleaned only with a damp cloth.

 <h1 style="margin: 0;">WARNING</h1>	
	<p>ELECTRIC SHOCK HAZARD</p> <p>This equipment must be grounded. Improper grounding, setup, or usage of the system can cause electric shock.</p> <ul style="list-style-type: none"> • Turn off and disconnect power at main switch before disconnecting any cables and before servicing equipment. • Connect only to grounded power source. • All electrical wiring must be done by a qualified electrician and comply with all local codes and regulations.
	<p>INTRINSIC SAFETY</p> <p>Intrinsically safe equipment that is installed improperly or connected to non-intrinsically safe equipment will create a hazardous condition and can cause fire, explosion, or electric shock. Follow local regulations and the following safety requirements.</p> <ul style="list-style-type: none"> • Only models with model numbers 24F084-24F087, utilizing the air-driven alternator, are approved for installation in a Hazardous (explosive atmosphere) Location. See Models, page 3. • Be sure your installation complies with national, state, and local codes for the installation of electrical apparatus in a Class I, Group D, Division 1 (North America) or Class I, Zones 1 and 2 (Europe) Hazardous Location, including all of the local safety fire codes, NFPA 33, NEC 500 and 516, and OSHA 1910.107. • To help prevent fire and explosion: <ul style="list-style-type: none"> • Do not install equipment approved only for a non-hazardous location in a hazardous location. See model ID label for the intrinsic safety rating of your model. • Do not substitute system components as this may impair intrinsic safety. • Equipment that comes in contact with the intrinsically safe terminals must be rated for Intrinsic Safety. This includes DC voltage meters, ohmmeters, cables, and connections. Remove the unit from the hazardous area when troubleshooting. • The equipment is intrinsically safe when no external electrical components are connected to it. • Do not connect, download, or remove USB device unless unit is removed from the hazardous (explosive atmosphere) location.
	<p>SKIN INJECTION HAZARD</p> <p>High-pressure fluid from gun, hose leaks, or ruptured components will pierce skin. This may look like just a cut, but it is a serious injury that can result in amputation. Get immediate surgical treatment.</p> <ul style="list-style-type: none"> • Do not spray without tip guard and trigger guard installed. • Engage trigger lock when not spraying. • Do not point gun at anyone or at any part of the body. • Do not put your hand over the spray tip. • Do not stop or deflect leaks with your hand, body, glove, or rag. • Follow the Pressure Relief Procedure when you stop spraying and before cleaning, checking, or servicing equipment. • Tighten all fluid connections before operating the equipment. • Check hoses and couplings daily. Replace worn or damaged parts immediately.



WARNING



EQUIPMENT MISUSE HAZARD

Misuse can cause death or serious injury.



- Do not operate the unit when fatigued or under the influence of drugs or alcohol.
- Do not exceed the maximum working pressure or temperature rating of the lowest rated system component. See **Technical Data** in all equipment manuals.
- Use fluids and solvents that are compatible with equipment wetted parts. See **Technical Data** in all equipment manuals. Read fluid and solvent manufacturer's warnings. For complete information about your material, request MSDS from distributor or retailer.
- Do not leave the work area while equipment is energized or under pressure. Turn off all equipment and follow the **Pressure Relief Procedure** when equipment is not in use.
- Check equipment daily. Repair or replace worn or damaged parts immediately with genuine manufacturer's replacement parts only.
- Do not alter or modify equipment.
- Use equipment only for its intended purpose. Call your distributor for information.
- Route hoses and cables away from traffic areas, sharp edges, moving parts, and hot surfaces.
- Do not kink or over bend hoses or use hoses to pull equipment.
- Keep children and animals away from work area.
- Comply with all applicable safety regulations.



TOXIC FLUID OR FUMES HAZARD

Toxic fluids or fumes can cause serious injury or death if splashed in the eyes or on skin, inhaled, or swallowed.



- Read MSDSs to know the specific hazards of the fluids you are using.
- Store hazardous fluid in approved containers, and dispose of it according to applicable guidelines.
- Always wear chemically impermeable gloves when spraying, dispensing, or cleaning equipment.







PERSONAL PROTECTIVE EQUIPMENT

You must wear appropriate protective equipment when operating, servicing, or when in the operating area of the equipment to help protect you from serious injury, including eye injury, hearing loss, inhalation of toxic fumes, and burns. This equipment includes but is not limited to:



- Protective eyewear, and hearing protection.
- Respirators, protective clothing, and gloves as recommended by the fluid and solvent manufacturer.

Important Two-Component Material Information



Isocyanate Conditions

						
<p>Spraying or dispensing materials containing isocyanates creates potentially harmful mists, vapors, and atomized particulates.</p> <p>Read material manufacturer's warnings and material MSDS to know specific hazards and precautions related to isocyanates.</p> <p>Prevent inhalation of isocyanate mists, vapors, and atomized particulates by providing sufficient ventilation in the work area. If sufficient ventilation is not available, a supplied-air respirator is required for everyone in the work area.</p> <p>To prevent contact with isocyanates, appropriate personal protective equipment, including chemically impermeable gloves, boots, aprons, and goggles, is also required for everyone in the work area.</p>						

Material Self-ignition

						
<p>Some materials may become self-igniting if applied too thickly. Read material manufacturer's warnings and material MSDS.</p>						

Keep Components A and B Separate

						
<p>Cross-contamination can result in cured material in fluid lines which could cause serious injury or damage equipment. To prevent cross-contamination of the equipment's wetted parts, never interchange component A (resin) and component B (isocyanate) parts.</p>						

Moisture Sensitivity of Isocyanates

Isocyanates (ISO) are catalysts used in two component coatings. ISO will react with moisture (such as humidity) to form small, hard, abrasive crystals, which become suspended in the fluid. Eventually a film will form on the surface and the ISO will begin to gel, increasing in viscosity. If used, this partially cured ISO will reduce performance and the life of all wetted parts.

NOTE: The amount of film formation and rate of crystallization varies depending on the blend of ISO, the humidity, and the temperature.

To prevent exposing ISO to moisture:

- Always use a sealed container with a desiccant dryer in the vent, or a nitrogen atmosphere. **Never** store ISO in an open container.
- Use moisture-proof hoses specifically designed for ISO, such as those supplied with your system.
- Never use reclaimed solvents, which may contain moisture. Always keep solvent containers closed when not in use.
- Never use solvent on one side if it has been contaminated from the other side.
- Always lubricate threaded parts with ISO pump oil or grease when reassembling.

Changing Materials

- When changing materials, flush the equipment multiple times to ensure it is thoroughly clean.
- Always clean the fluid inlet strainers after flushing.
- Check with your material manufacturer for chemical compatibility.

Glossary of Terms

Coriolis Meter - a non-intrusive flow meter often used in low flow applications or with light viscosity, shear sensitive, or acid catalyzed materials. This meter uses vibration to measure flow.

Dose Size - the amount of resin (A) and catalyst (B) that is dispensed into an integrator.

Dose Time Alarm - the amount of time that is allowed for a dose to occur before an alarm occurs.

Dynamic Dosing - Component A dispenses constantly. Component B dispenses intermittently in the necessary volume to attain the mix ratio.

Grand Total - a non-resettable value that shows the total amount of material dispensed through the system.

Intrinsically Safe (IS) - refers to the ability to locate certain components in a hazardous location.

Idle - if the gun is not triggered for 2 minutes the system enters Idle mode. Trigger the gun to resume operation.

Batch Total - a resettable value that shows the amount of material dispensed through the system for one batch. A batch is complete when the user resets the batch counter to zero.

K-factor - an assigned value that refers to the amount of material per pulse that passes through a meter.

Mix - when cross-linking of the resin (A) and catalyst (B) occurs.

Overdose Alarm - when either the resin (A) or catalyst (B) component dispenses too much material and the system cannot compensate for the additional material.

Potlife Time - the amount of time before a material becomes unsprayable.

Potlife Volume - the amount of material that is required to move through the mix manifold, hose and applicator before the potlife timer is reset.

Purge - when all mixed material is flushed from the system.

Purge Time - the amount of time required to flush all mixed material from the system.

Ratio Tolerance - the settable percent of acceptable variance that the system will allow before a ratio alarm occurs.

Sequential Color Change - the process when a color change is initiated and the system automatically flushes the old color and loads a new color.

Sequential Dosing - Components A and B dispense sequentially in the necessary volumes to attain the mix ratio.

Standby - refers to the status of the system.

Overview

Usage

The ProMix 2KE is an electronic two-component paint proportioner. It can blend most two-component paints. It is not for use with quick-setting paints (those with a pot life of less than 5 minutes).

- Has dynamic dosing capabilities. It dispenses material A, monitors fluid flow, and dispenses material B in doses to cause the mixture to stay on ratio.
- Can proportion at ratios from 0.1:1 to 30.0:1.
- Will display the last 50 errors with date, time, and event. The optional USB upgrade kit will log 500 errors and up to 2000 jobs.
- For systems with one gun, an optional Gun Flush Box provides an automated flushing system for a manual spray gun.

Component Identification and Definition

Table 1: Component Description



Component	Description
Control Box	<ul style="list-style-type: none"> • Advanced Fluid Control Module • Power supply or alternator • Solenoid valves • Air flow switch(es) • Optional USB Module • Audible alarm • Optional pressure switch for gun flush box
Fluid Module	<ul style="list-style-type: none"> • Mix manifold, which includes the fluid integrator and static mixer. • Color/catalyst valve stacks, includes pneumatically operated dose valves for material A1 and B, additional dose valves A2 and A3 (optional), as well as solvent valves. • Meters
Display Module	Used to set up, display, operate, and monitor the system. Used for daily painting functions including choosing recipes, reading/clearing alarms, and placing the system in Spray, Standby, or Purge mode.

Installation

General Information

- Reference numbers and letters in parentheses in the text refer to numbers and letters in the illustrations.
- Be sure all accessories are adequately sized and pressure-rated to meet system requirements.
- There must be a shutoff valve between each fluid supply line and the ProMix 2KE system.
- A 100 mesh minimum fluid filter must be installed on component A and B fluid supply lines.
- To protect the Display Module screens from paints and solvents, clear-plastic protective shields are available in packs of 10 (Part No. 24G821). Clean the screens with a dry cloth if necessary.

Intrinsically Safe Installation Requirements

						
<p>Do not substitute or modify system components as this may impair intrinsic safety. For installation, maintenance, or operation instructions, read instruction manuals. Do not install equipment approved only for non-hazardous location in a hazardous location. See the identification label for the intrinsic safety rating for your model.</p>						

1. The installation must meet the requirements of the National Electric Code, NFPA 70, Article 504 Resp., Article 505, and ANSI/ISA 12.06.01.
2. Multiple earthing of components is allowed only if high integrity equipotential system realized between the points of bonding.
3. For ATEX, install per EN 60079-14 and applicable local and national codes.

Hazardous (Classified) Locations Class 1, Div 1, Group D, T3 (US and Canada) Class 1, Zone 1, Group IIA, T3 (ATEX only)

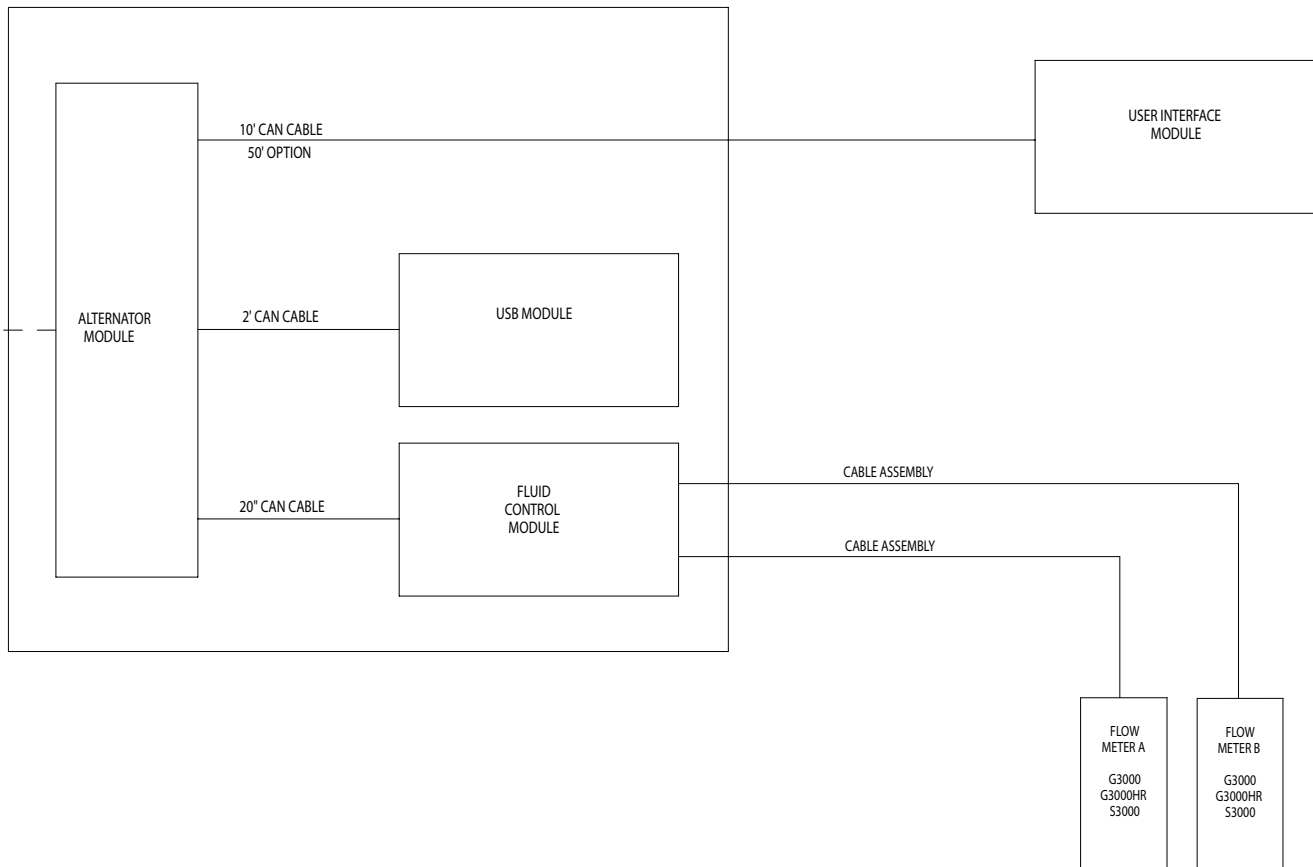

FIG. 1. Hazardous Location Installation

Non-Hazardous Locations

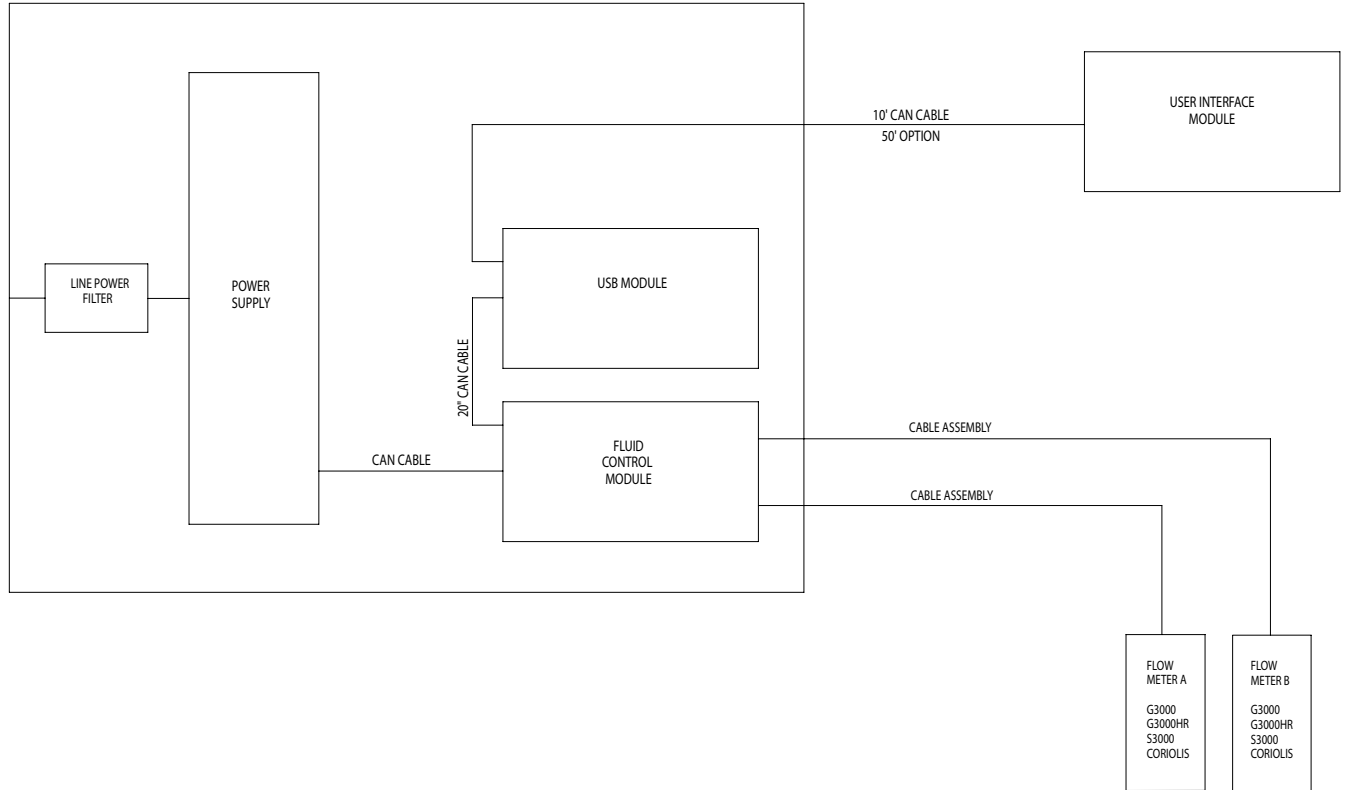
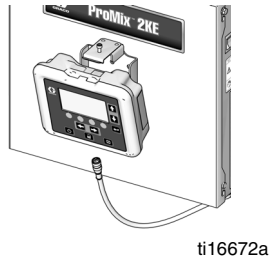

FIG. 2. Non-Hazardous Location Installation

Display Module

1. Use the screws provided to mount the bracket for the Display Module on the front of the Control Box or on the wall, as you prefer.



ti16672a

2. Snap the Display Module into the bracket.

3. Connect one end of the CAN cable (provided) to J6 on the Display Module (either port).

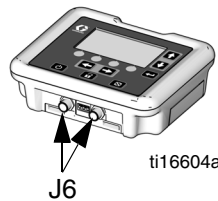

ti16604a

4. The other end of the cable comes from the factory connected as shown, depending on the configuration of your system:

- **Wall Power Systems with USB Module:**

Connect the CAN cable to P3 on the USB Module.

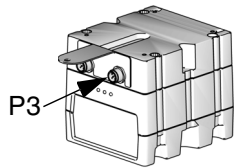

ti16580a

- **Wall Power Systems without USB Module:**

Connect CAN cable to J8 on the Advanced Fluid Control Module.

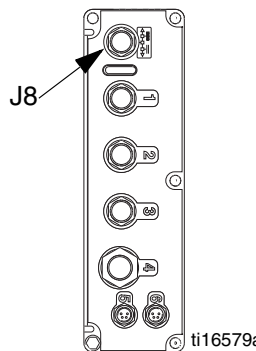

ti16579a

- **Alternator Power Systems (with or without USB Module):** Connect CAN cable to J3 on the alternator.

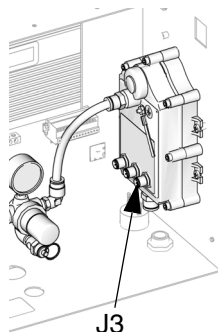

ti16456a

Air Supply

Requirements

- **Compressed air supply pressure:** 75-100 psi (517-700 kPa, 5.2-7 bar).
- **Air hoses:** use grounded hoses that are correctly sized for your system.



Trapped air can cause a pump or dispense valve to cycle unexpectedly, which could result in serious injury from splashing or moving parts. Use bleed-type shutoff valves.

- **Air regulator and bleed-type shutoff valve:** include in each air line to fluid supply equipment. Install an additional shutoff valve upstream of all air line accessories to isolate them for servicing.



If using a Graco electrostatic PRO™ Gun, a shutoff valve must be installed in the gun air line to shutoff the atomizing and turbine air to the gun. Contact your Graco distributor for information on air shutoff valves for electrostatic applications.

- **Air line filter:** a 10 micron or better air filter is recommended to filter oil and water out of the air supply and help avoid paint contamination and clogged solenoids.

Air Connections

See the **System Pneumatic Schematic** on page 72 (hazardous location) or page 73 (non-hazardous location).

1. Tighten all ProMix 2KE system air and fluid line connections as they may have loosened during shipment.
2. Connect the main air supply line to the main air inlet. This air line supplies the solenoids and all pneumatic control valves.

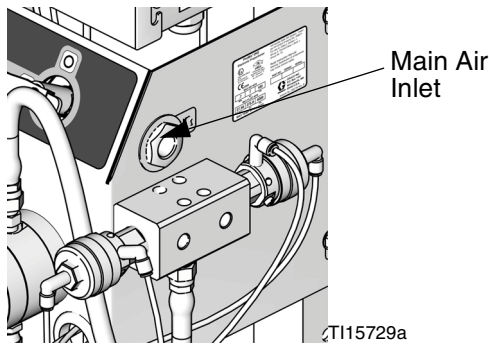

FIG. 3. Main Air Connection

3. For each gun in the system, connect a separate clean air supply line to the air inlet of the air flow switch. This air line supplies gun atomizing air. The air flow switch detects air flow to the gun and signals the controller when the gun is being triggered.

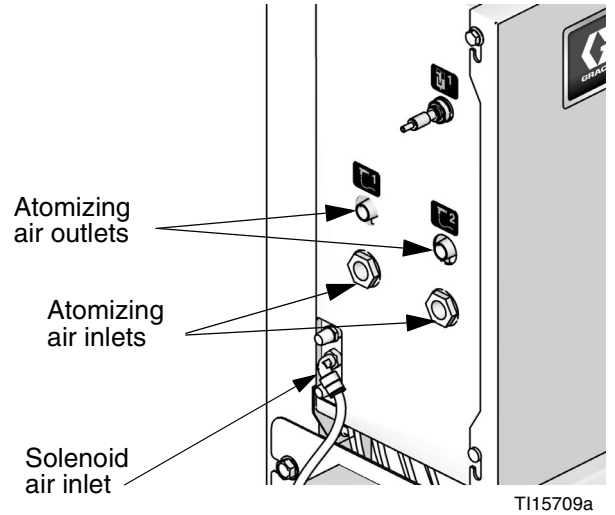





FIG. 4. Atomizing Air Connection

Fluid Supply

Requirements

						
<ul style="list-style-type: none"> Do not exceed the pressure rating of the lowest rated component. See the identification label. To reduce the risk of injury, including fluid injection, you must install a shutoff valve between each fluid supply line and the mix manifold. Use the valves to shut off fluid during maintenance and service. 						

ProMix 2KE models are available to operate air spray or air-assisted systems with a capacity of up to 3800 cc/min.

- Fluid supply pressure tanks, feed pumps, or circulating systems can be used.
- Materials can be transferred from their original containers or from a central paint recirculating line.
- See manual 313599 for Coriolis meter installation and operation instructions.

NOTE: The Coriolis meter can be used only on non-IS systems 24F080-24F083. When installed on these systems, the meter's hazardous location intrinsically safe status is voided.

- If you are using dynamic dosing, see **Fluid Connections**, this page. See also **Set Up the Fluid Manifold for Dynamic Dosing**, page 16.

NOTE: The fluid supply must be free of pressure spikes, which are commonly caused by pump stroke change-over. If necessary, install pressure regulators or a surge tank on the ProMix 2KE fluid inlets to reduce pulsation. Contact your Graco distributor for additional information.

Fluid Connections

- See FIG. 6. Connect the solvent supply line to the 1/4 npt(f) solvent valve inlets (SVA and SVB).
 - Connect the component A supply line(s).
- Single color system:** connect component supply line to the component A1 dose valve inlet (DVA1).

- Multiple color system:** connect supply lines to the component A2 and A3 dose valve inlets (DVA2, DVA3). See FIG. 6.

NOTE: Solvent supplied by a single source can cause cross contamination and damage to the system. Install check valves or use separate solvent sources.

NOTE: Paint Recirculating System Only

- If you are recirculating paint, use the standard inlet on Dose Valve A1 (A2, A3) or Dose Valve B. Remove the plug directly opposite it on the dose valve for the recirculation outlet. The second port is on the back of the valve and must be reached from inside the control box.

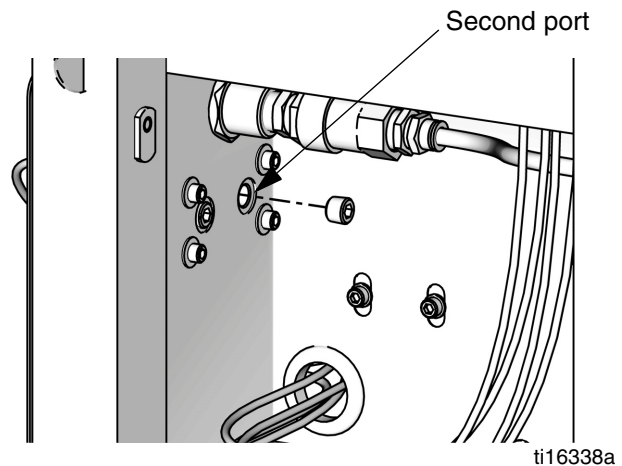

FIG. 5. Paint Recirculation Port

- Another option is to use a tee fitting to recirculate.

NOTE: Verify that all unused fluid ports on the color change valve stack are plugged before operation. An open port will leak fluid.

- Connect the component B line to the component B dose valve inlet (DVB).

NOTE: The component A and B fluid meter inlets have fluid check valves to prevent backflow from fluid supply pressure fluctuations. Backflow can cause ratio inaccuracies.

- Connect the gun fluid supply line between the static mixer (SM) outlet and the gun fluid inlet.

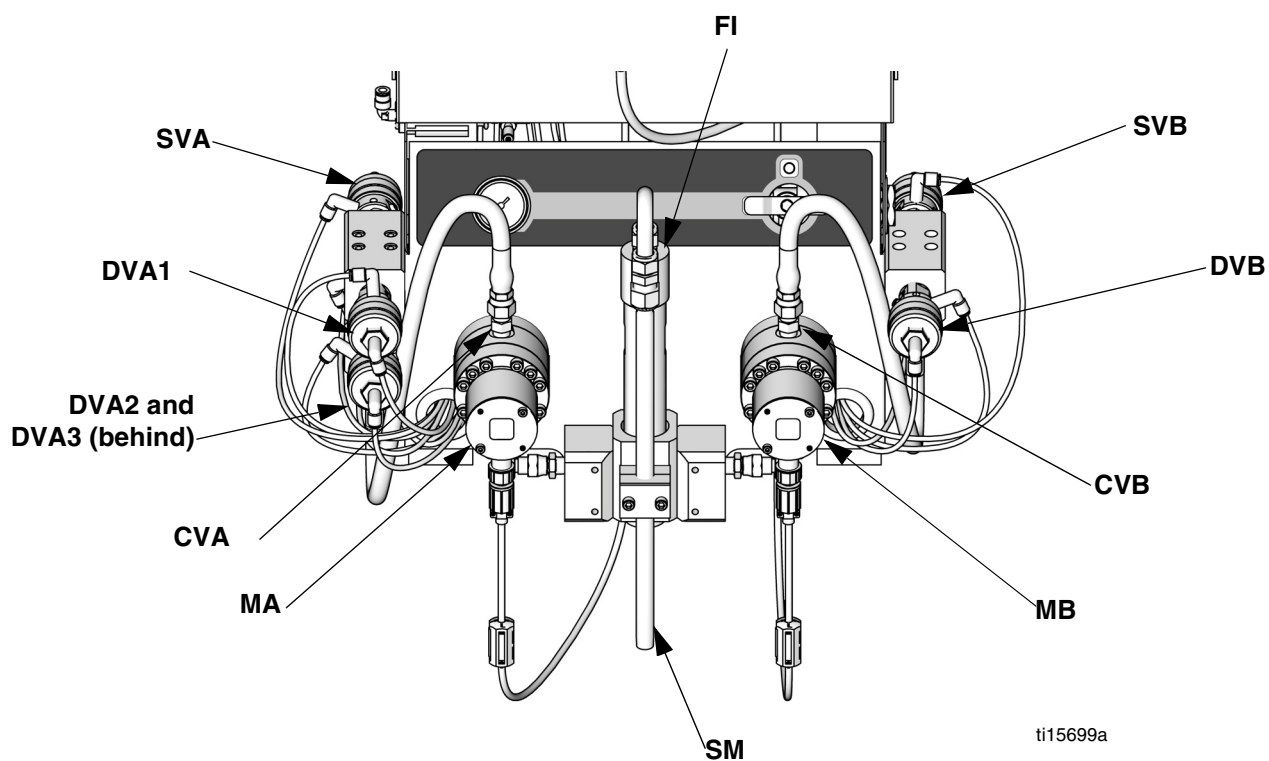
**Key:**

MA	Component A Meter	MB	Component B Meter
DVA1	Component A Dose Valve	DVB	Component B Dose Valve
DVA2	Second Color/Catalyst Valve	SVB	Solvent Valve B
DVA3	Third Color/Catalyst Valve	CVB	Meter B Check Valve
SVA	Solvent Valve A	SM	Static Mixer
CVA	Meter A Check Valve	FI	Fluid Integrator Assembly

FIG. 6. Fluid Controls, Sequential Dosing

Set Up the Fluid Manifold for Dynamic Dosing

NOTE: For more information about **Dynamic Dosing**, see page 53.

NOTE: When using dynamic dosing it is very important to maintain a constant, well-regulated fluid supply. To obtain proper pressure control and minimize pump pulsation, install a fluid regulator on the A and B supply lines upstream of the meters.

If you will be operating using dynamic dosing, the fluid manifold must be set up properly for your application. Order the 15U955 Injection Kit (accessory).

1. See FIG. 7. Remove the screws (A) and static mixer bracket assembly (B).
2. Loosen the static mixer nut (N1). Remove and retain the static mixer (SM).
3. Loosen the u-tube nuts (N2 and N3). Discard the u-tube (C) and the static mixer fitting (D).
4. Remove and retain the 1/4 npt(m) fitting (F). Remove the integrator (G) and discard
5. See FIG. 8. Remove the remaining parts from the restrictor housing (H). Retain the plug (J) and base (K). Discard all the used o-rings.
6. Rotate the restrictor housing (H) 180° so the set-screw (S) is at top left, as shown in FIG. 8. Remove and retain the two setscrews (S). The position of these screws will be reversed when reassembled.
7. Install one larger o-ring (L1*) in the housing (H). Screw the injection cap (M*) into the housing.
8. Determine the desired flow range for your application. Select the appropriate size restrictor for your selected flow and ratio, using the **Dynamic Dosing Restrictor Selection Graphs** on pages 66-70, as a guide. Install the restrictor (R*) in the base (K).
9. Assemble the smaller o-ring (L2*), restrictor (R*) and base (K), one larger o-ring (L1*), and plug (J) as shown.
10. Install the two setscrews. Install the long setscrew (S) at the front of the housing, for ease of access.

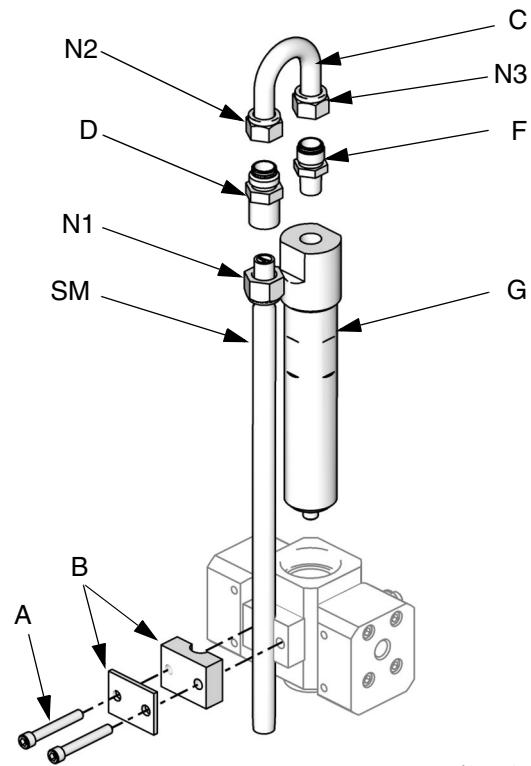

ti16334a

FIG. 7. Disassemble Integrator and Static Mixer

11. Screw the static mixer (SM) into the injection cap (M*). Install the retained fitting (F) on the static mixer tube and secure with the nut (N1).

* These parts are included in the 15U955 Injection Kit.

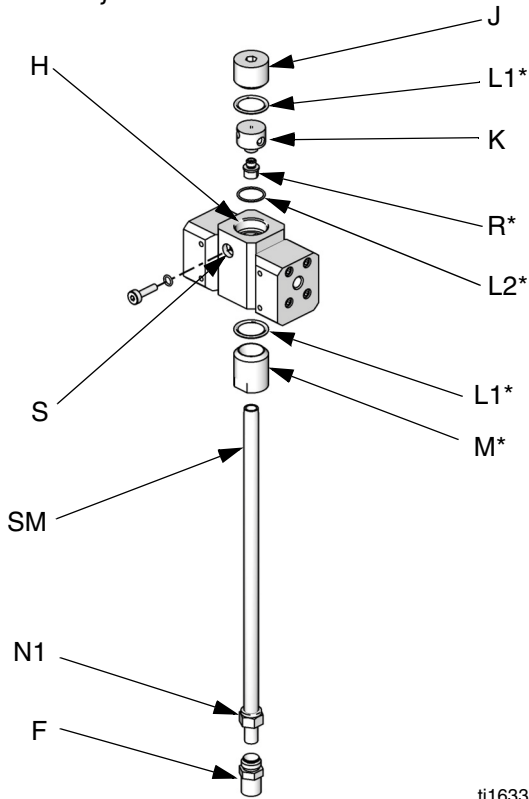

ti16335a

FIG. 8. Install 15U955 Injection Kit

12. Follow instructions under **Fluid Connections** on page 14.

NOTE: Use a minimum 20 ft (6.1 m) x 1/4 in. (6 mm) ID gun fluid supply hose when using dynamic dosing. If the material is harder to integrate, use a longer hose.

13. Tune the fluid pressure and flow.

Tubing Chart and Diagrams

Type	Color	Description	Starting Point	Ending Point	Tube OD in. (mm)
Air	Green	Solvent Valve A On	1G	1G	0.156 (4.0)
Air	Green	Dose Valve A1 On	2G	2G	0.156 (4.0)
Air	Green	Solvent Valve B On	3G	3G </td <td>0.156 (4.0)</td>	0.156 (4.0)
Air	Green	Dose Valve B On	4G	4G	0.156 (4.0)
Air	Green	Dose Valve A2 On	5G	5G	0.156 (4.0)
Air	Green	Dose Valve A3 On	6G	6G	0.156 (4.0)
Air	Red	Solvent Valve A Off	1R	1R	0.156 (4.0)
Air	Red	Dose Valve A1 Off	2R	2R	0.156 (4.0)
Air	Red	Solvent Valve B Off	3R	3R	0.156 (4.0)
Air	Red	Dose Valve B Off	4R	4R	0.156 (4.0)
Air	Red	Dose Valve A2 Off	5R	5R	0.156 (4.0)
Air	Red	Dose Valve A3 Off	6R	6R	0.156 (4.0)
Air	----	Main Air to Pressure Gauge	A1	A1	0.156 (4.0)
Air	Natural	Solenoid Air	A2	A2	0.25 (6.3)
Air	Natural	Main Air to Filter	A3	A3	0.25 (6.3)
Fluid	----	Valve Stack A to Meter A	A4	A4	0.375 (9.5)
Fluid	----	Valve Stack B to Meter B	A5	A5	0.375 (9.5)
Air	Black	Alternator Air Exhaust*	A6	A6	0.5 (12.7)
Air	Natural	Air Regulator to Alternator*	A7	A7	0.375 (9.5)

* Used only on IS models.

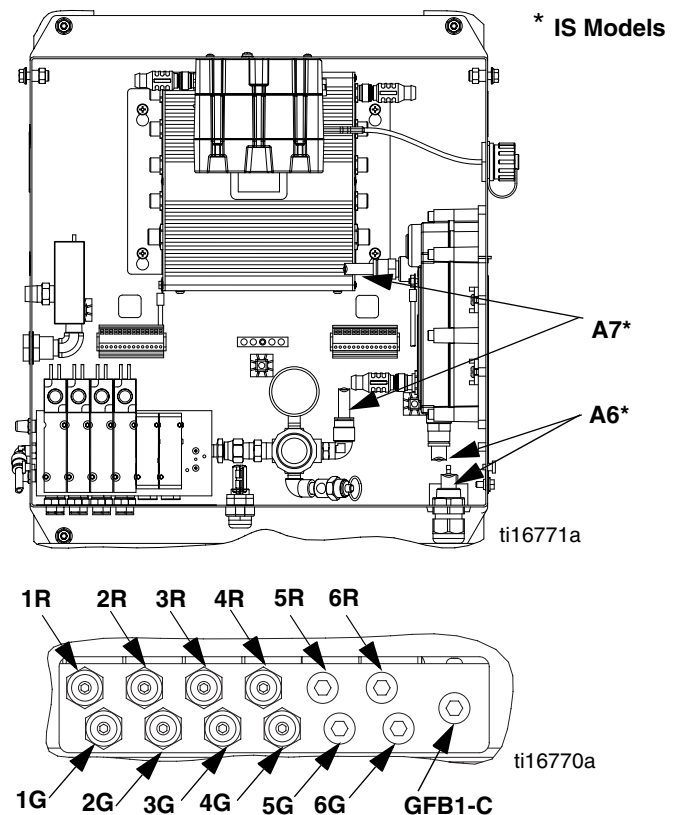
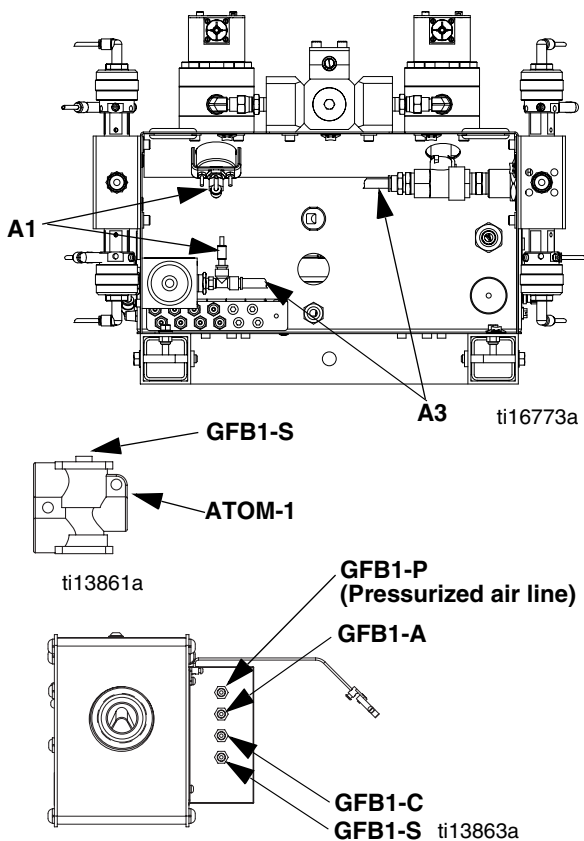

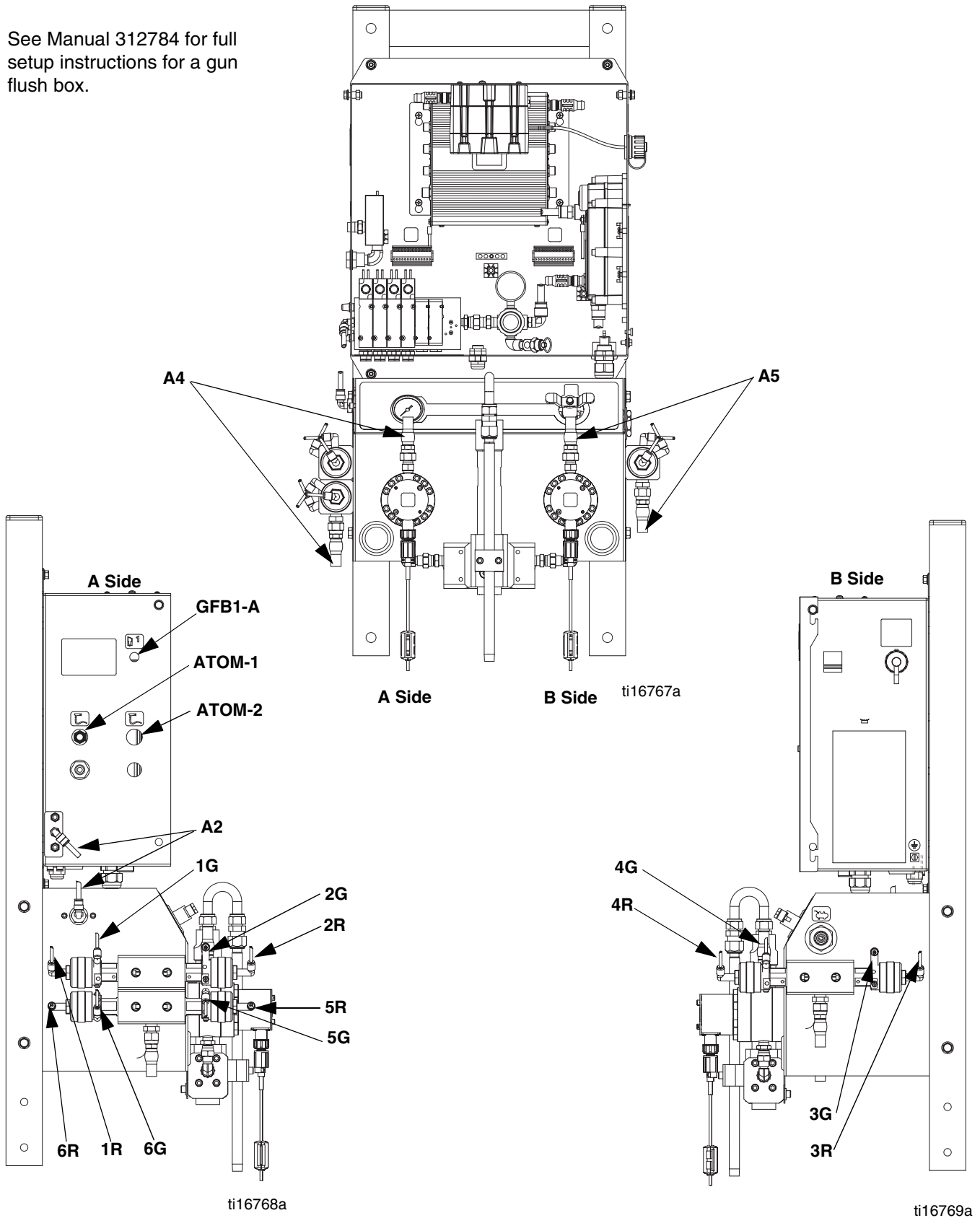

See Manual 312784 for full setup instructions for a gun flush box.



Electrical

Power Connection (non-IS units only)

							
<p>All electrical wiring must be completed by a qualified electrician and comply with all local codes and regulations.</p>							

Enclose all cables routed in the spray booth and high traffic areas in conduit to prevent damage from paint, solvent, and traffic.

The ProMix 2KE operates with 85-250 VAC, 50/60 Hz input power, with a maximum of 2 amp current draw. The power supply circuit must be protected with a 15 amp maximum circuit breaker.

Not included with system:

- Power supply cord compatible to your local power configuration. Wire gauge size must be 8-14 AWG.
 - The input power access port is 22.4 mm (0.88 in.) in diameter. It accepts a bulkhead strain relief fitting or conduit.
1. Verify that electrical power at the main panel is shut off. Open Control Box cover.
 2. Connect electrical cord to the terminal block as shown in FIG. 10.
 3. Close the Control Box. Restore power.
 4. Follow instructions in **Grounding**, page 21.

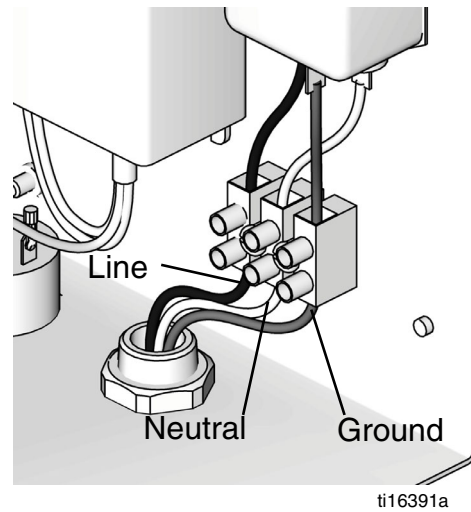

FIG. 9. Control Box Electrical Connection

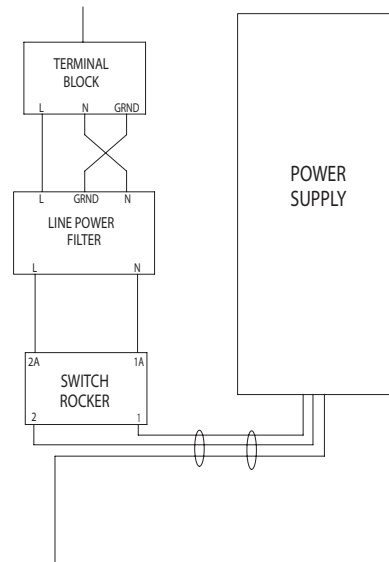





FIG. 10. Electrical Schematic

Grounding

						
<p>The equipment must be grounded. Grounding reduces the risk of static and electric shock by providing an escape wire for the electrical current due to static build up or in the event of a short circuit.</p>						

Connect the ProMix 2KE ground wire to the ground screw. Connect the clamp to a true earth ground. If wall power is used to power controls, ground electrical connection according to local codes.

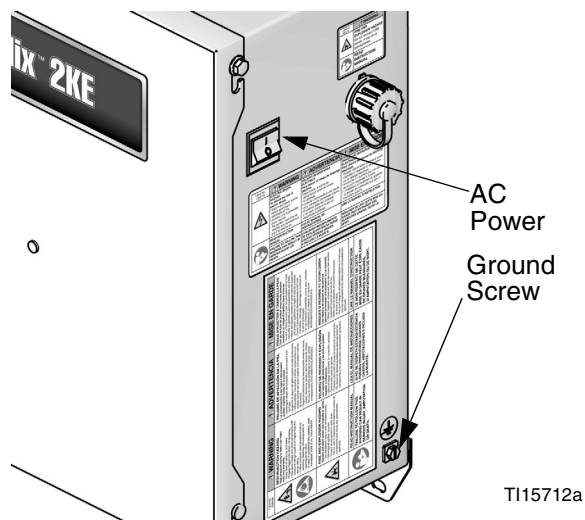

FIG. 11. Ground Screw and Power Switch

Gun Flush Box

Connect a ground wire from the Gun Flush Box ground lug to a true earth ground.

Flow Meters

Verify that the meter cables are connected as shown in the **Hazardous Location Electrical Schematic** on page 74-75. Failure to properly connect the shield may cause incorrect signals.

NOTE: The Coriolis meter can be used only on non-IS systems 24F080-24F083. When installed on these systems, the meter's hazardous location intrinsically safe status is voided.

Feed Pumps or Pressure Pots

Connect a ground wire and clamp from a true earth ground to the pumps or pots. See pump or pressure pot manual.

Air and Fluid Hoses

Use grounded hoses only.

Spray Gun

- **Non-Electrostatic:** Ground the spray gun through connection to a Graco-approved grounded fluid supply hose.
- **Electrostatic:** Ground the spray gun through connection to a Graco-approved grounded air supply hose. Connect the air hose ground wire to a true earth ground.

Fluid Supply Container

Follow local code.





Object Being Sprayed

Follow local code.

All Solvent Pails Used When Purging

Follow local code. Use only conductive metal pails/containers placed on a grounded surface. Do not place the pail/container on a nonconductive surface, such as paper or cardboard, which interrupts the grounding continuity.

Check Resistance

						
<p>To ensure proper grounding, resistance between components and true earth ground must be less than 1 ohm.</p>						

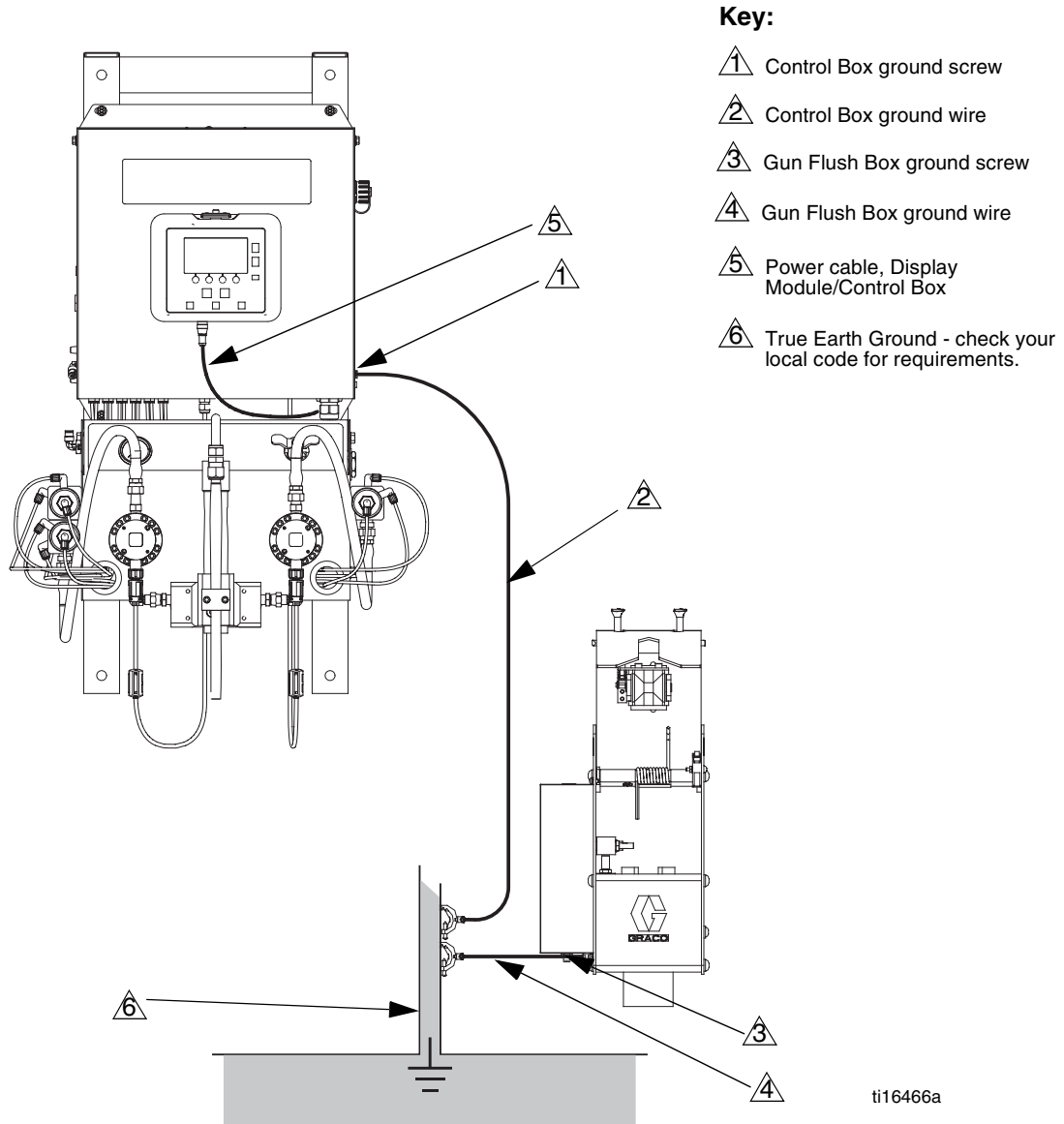

FIG. 12. Grounding

Display Module

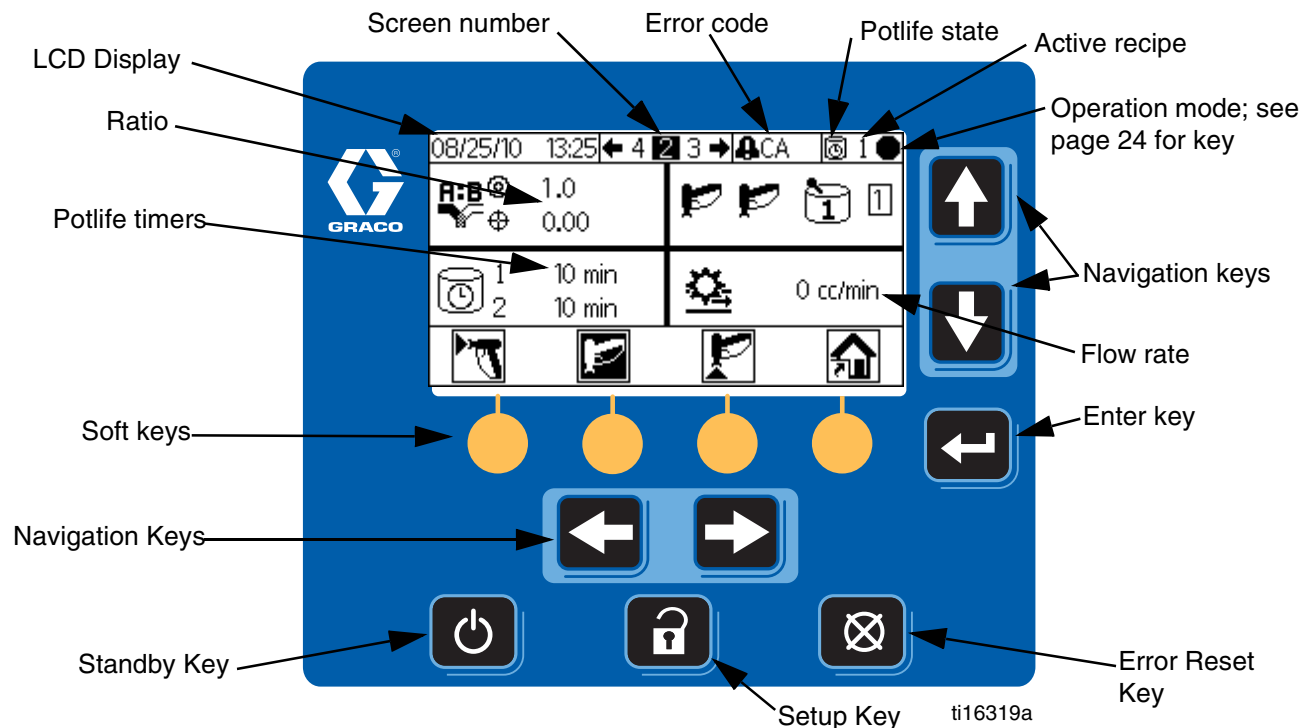

FIG. 13. Display Module

Display

Shows graphical and text information related to setup and spray operations. The screen backlight is factory set to remain on. The user may set a number of minutes the screen can be inactive before the backlight dims. See **Configure 3 (Screen 20)**, page 46. Press any key to restore.

NOTE: The Display Module and bracket can be removed from the cover of the electrical box and mounted remotely, if preferred.

Keys are used to input numerical data, enter setup screens, navigate within a screen, scroll through screens, and select setup values.

NOTICE

To prevent damage to the soft key buttons, do not press the buttons with sharp objects such as pens, plastic cards, or fingernails.



















Key	Function
	<i>Setup:</i> Press to enter or exit Setup mode.
	<i>Enter:</i> Press to choose a field to update, to make a selection, or to save a selection or value.
	<i>Left/Right Arrows:</i> Use to move from screen to screen.
	<i>Up/Down Arrows:</i> Use to move among fields on a screen, items on a dropdown menu, or digits in a settable field.

	<i>Error Reset:</i> Use to clear alarm so cause can be fixed. Also use to cancel a data entry field.
	<i>Standby:</i> Stops the current operation and puts the system into standby.
	<i>Soft keys:</i> Press to select the specific screen or operation shown on the display directly above each key.

Icon Key

The following tables present a printable version of the information on the ProMix 2KE icon card. See Table 5, page 57, for a printable version of the error code information on the reverse side of the card.











General Icons

Icon	Description
	Pump
	Meter
	Dose Valve
	Solvent Valve
	Air Filter
	Fluid Filter
	Gun Flush Box
	Park Pumps
	Flush Time
	Hose Length
	Hose Diameter
	Ratio
	Potlife
	Length
	Volume
	Pressure
	Flow Rate High/Low
	Job Number
	User Number









Spray Gun States

Icon	Description
	Mix
	Mix Spray
	In Flush Box
	Purge
	Purge in Flush Box
	Standby
	Idle
	Locked







Operation Modes

Icon	Description
	Standby
	Mix
	Purge
	Color Change
	Dispense A
	Dispense B
	Batch
	Calibrate
	Forced
	Park
	Locked

Screen Shortcuts

Icon	Description
	Home
	Spray
	Alarm Log
	Run Pumps
	System Configuration
	Recipes
	Maintenance
	Calibrate

Softkeys

Icon	Description
	Mix/Spray
	Standby
	Purge
	Reset Counter
	Start
	Stop/Standby

Screen Summary

NOTE: This summary is a one-page guide to the ProMix 2KE screens, followed by screen maps. For operating instructions, see **Basic Operation**, page 31. For further detail on individual screens, see **Run Mode Details**, page 42, or **Setup Mode Details**, page 45.

Run Mode

The run mode has two screen sections that control the mixing operations.

Mix (Screens 2-4, 38)

- Spray (Screen 2) controls most mixing operations.
- Batch (Screen 3) controls dispense of a set volume.
- Totals (Screen 4) displays grand and batch totals for materials A1 (A2, A3) and B.
- Job Number (Screen 38) displays job number and user number

Error Log (Screens 5-14)

- 10 screens, 5 errors per page
- Displays date, time, and error

Setup Mode

The setup mode has four screen sections that allow an authorized user to choose the exact settings needed for the system:

Configure (Screens 18-21)

- Configure 1 (Screen 18) controls system type (pump or meter), dosing type (sequential or dynamic dosing), gun flush box enable, number of guns (1 or 2), and system color configuration (1 or 3).
- Configure 2 (Screen 19) controls hose length and diameter for one or two guns and flow rate region for dynamic dosing.
- Configure 3 (Screen 20) controls language (for optional USB Module), date format, date, time, password setting, and backlight timer.
- Configure 4 (Screen 21) controls units for distance and volume.

Recipe (Screens 27-33)

- Recipe 0 (Screen 27) includes timers for the system first, second, and third flush and a third flush material selection.

- Recipe 1-1 (Screen 28) and 1-2 (Screen 29) control Material 1/Color 1 parameters and flush.
- Recipe 2-1 (Screen 30) and 2-2 (Screen 31) control Material 2/Color 2 parameters and flush.
- Recipe 3-1 (Screen 32) and 3-2 (Screen 33) control Material 3/Color 3 parameters and flush.

Maintenance (Screens 24-26)

- Maintenance 1 (Screen 24) controls maintenance timer actual and target for Meter A, Meter B, Solvent Valve A, and Solvent Valve B.
- Maintenance 2 (Screen 25) controls dose valves A1 and B maintenance timer actual and target. Dose valves A2 and A3 are included if 3 colors are selected on Configure 1 (Screen 18).
- Maintenance 3 (Screen 26) controls fluid and air filter maintenance timers, actual and target.

Calibration (Screens 22 and 23)

1-Color

- Calibration 1 (Screen 22) controls k factors (cc/pulse) for Meter A and Meter B.
- Calibration 2 (Screen 23) allows the user to perform a calibration.

3-Color

- Calibration 1 (Screen 22) controls k factors (cc/pulse) for Meter B and for Meter A using colors A1, A2, and A3.
- Calibration 2 (Screen 23) allows the user to perform a calibration.

Troubleshooting Mode

The troubleshooting mode has three screen sections that allow an authorized user to troubleshoot system operation. See FIG. 17, page 30.

System Inputs (Screen 35)

Membrane Test (Screen 36)

System Outputs and Manual Activation (Screen 37)

Ranges for User Inputs

This table is a one-sheet reference of the data range accepted for each user input. See the page indicated in the table for further screen information, if needed.

Page	Screen	User Input	Range/Options	Default
42	Run Mix Batch (3)	Target Volume	1 to 9999 cc	0 cc
43	Run Job Number	User Number	000000000 to 999999999	000000000
45	Password (16)	Password	0000 to 9999	0000 (disabled)
46	Configure 1 (18)	System Type	Meters; 50cc Pump; 75cc Pump; 100cc Pump; 125cc Pump; 150cc Pump	Meters
46	Configure 1 (18)	Dosing Type	Dynamic (A B) 50cc Sequential (A-B 50cc) 100cc Sequential (A-B 100cc)	50 cc Sequential
46	Configure 1 (18)	Gun Flush Box Enable	On or Off	Off
46	Configure 1 (18)	Number of Guns	1 or 2 guns	1 gun
46	Configure 1 (18)	Number of Colors	1 or 3 colors	1 color
46	Configure 2 (19)	Gun 1 or Gun 2 hose length	0.1 to 45.7 m / 0.3 to 150 ft	1.53 m / 5.01 ft.
46	Configure 2 (19)	Gun 1 or Gun 2 hose diameter	0.1 to 1 inch	0.25 inches
46	Configure 2 (19)	Flow Rate Region	High (250 cc/min or higher) or Low (<250 cc/min)	High
46	Configure 3 (20)	USB Log Language	Chinese; Dutch; English; French; German; Italian; Japanese; Korean; Portuguese; Russian; Spanish; Swedish;	English
46	Configure 3 (20)	Date Format	mm/dd/yy; dd/mm/yy; yy/mm/dd	mm/dd/yy
46	Configure 3 (20)	Date	01/01/00 to 12/31/99	Set at factory
46	Configure 3 (20)	Time	00:00 to 23:59	Set at factory
46	Configure 3 (20)	Password	0000 to 9999	0000 (disabled)
46	Configure 3 (20)	Backlight Timer	0 to 99 minutes	0 minutes
46	Configure 4 (21)	Distance Units	Feet/inches or Meters/cm	Feet/inches
46	Configure 4 (21)	Volume Units	Liters; Gallons US; Gallons Imperial	Gallons US
47	Recipe 1-1 (28) Recipe 2-1 (30) Recipe 3-1 (32)	Ratio	0:1 to 30:1 Note: Enter 0 to dispense A only.	1:1
47	Recipe 1-1 (28) Recipe 2-1 (30) Recipe 3-1 (32)	Ratio Tolerance	1 to 99 percent	5 percent
47	Recipe 1-1 (28) Recipe 2-1 (30) Recipe 3-1 (32)	Potlife Timer	0 to 240 minutes Note: If set to 0, potlife alarm is disabled.	60 minutes
47	Recipe 0 (27) Recipe 1-2 (29) Recipe 2-2 (31) Recipe 3-2 (33)	Flush Times - First (A purge), Second (B purge), or Third (using A or B, selected by user)	0 to 240 seconds Note: If set to 0, the valve(s) will not flush.	60 seconds
48	Maintenance 1 (24)	Meter A or Meter B	0 to 2,000,000 L / 0 to 528,344 gal	0
48	Maintenance 1 (24)	Solvent Valve A or B	0 to 9,999,999	0
48	Maintenance 2 (25)	Dose Valve A1, A2, A3, or B	0 to 9,999,999	0
48	Maintenance 3 (26)	Fluid Filter A or B, or Air Filter	0 to 9999 days	0 days
49	Calibration 1 (22)	Meter A1, A2, A3, or B K-Factor	0 to 0.873 cc/pulse	0.119 cc/pulse
49	Calibration 2 (23)	Actual Dispensed Volume	0 to 9999 cc	0 cc

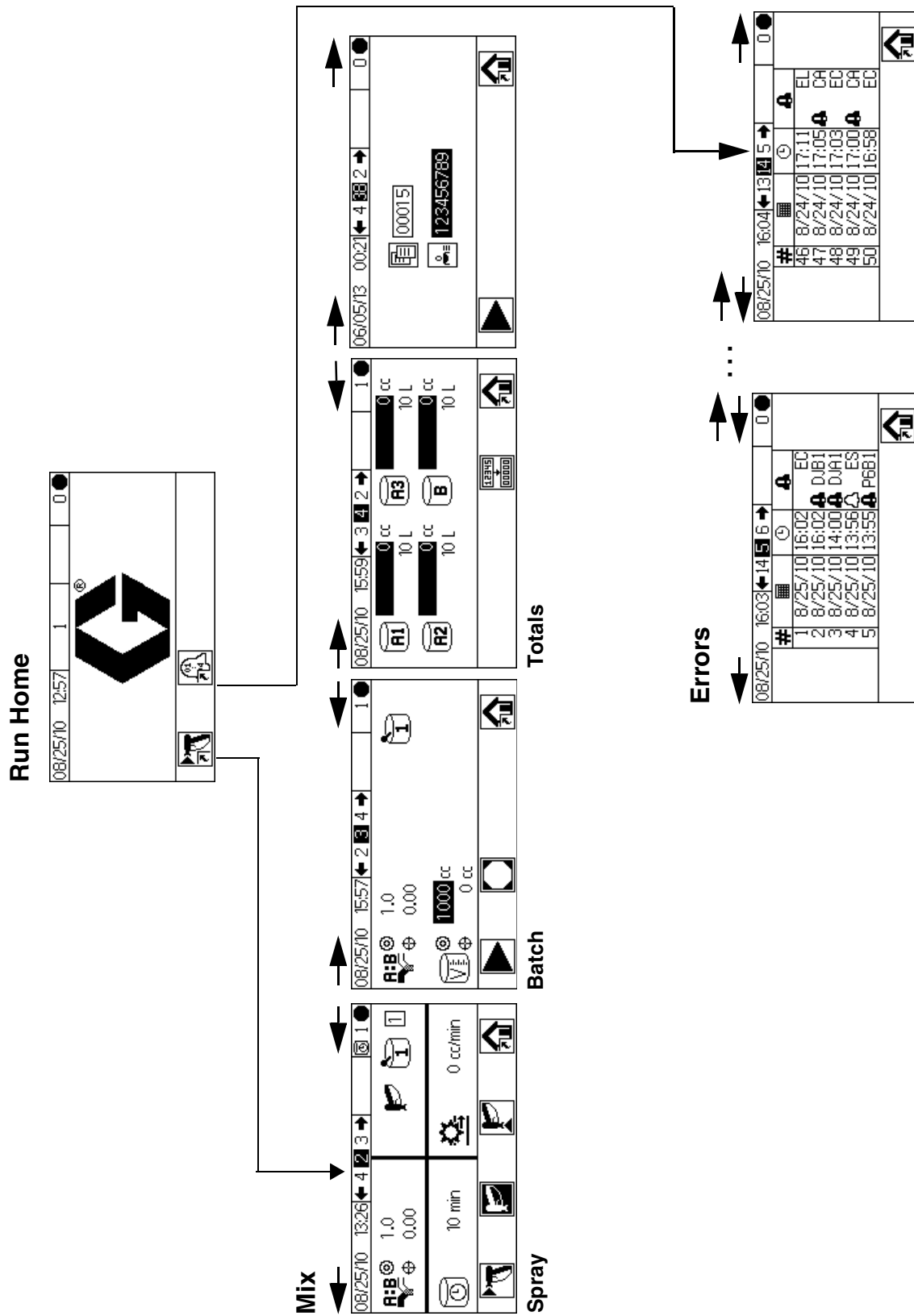

FIG. 14. Run Mode Screen Map

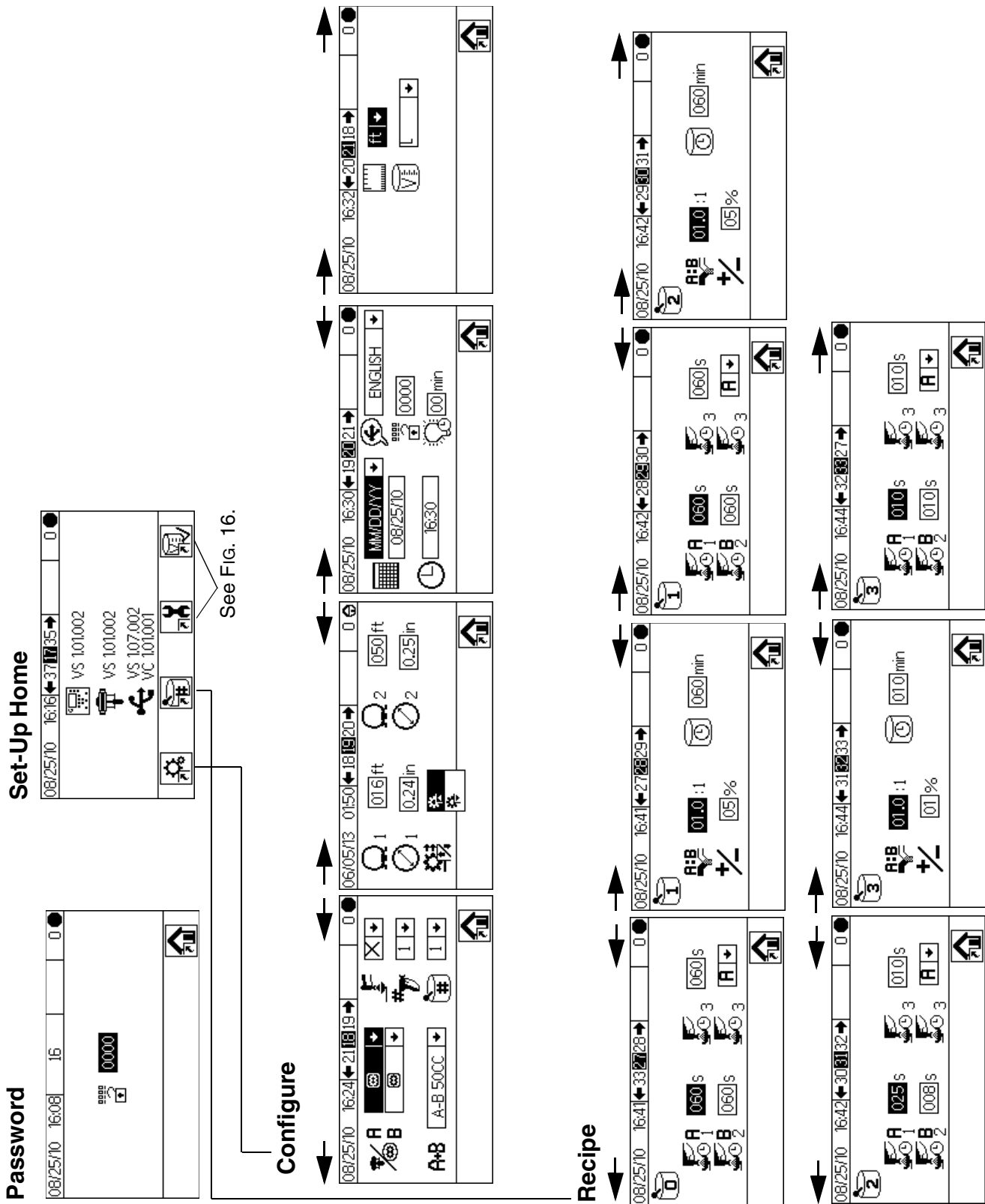

FIG. 15. Setup Mode Screen Map, page 1

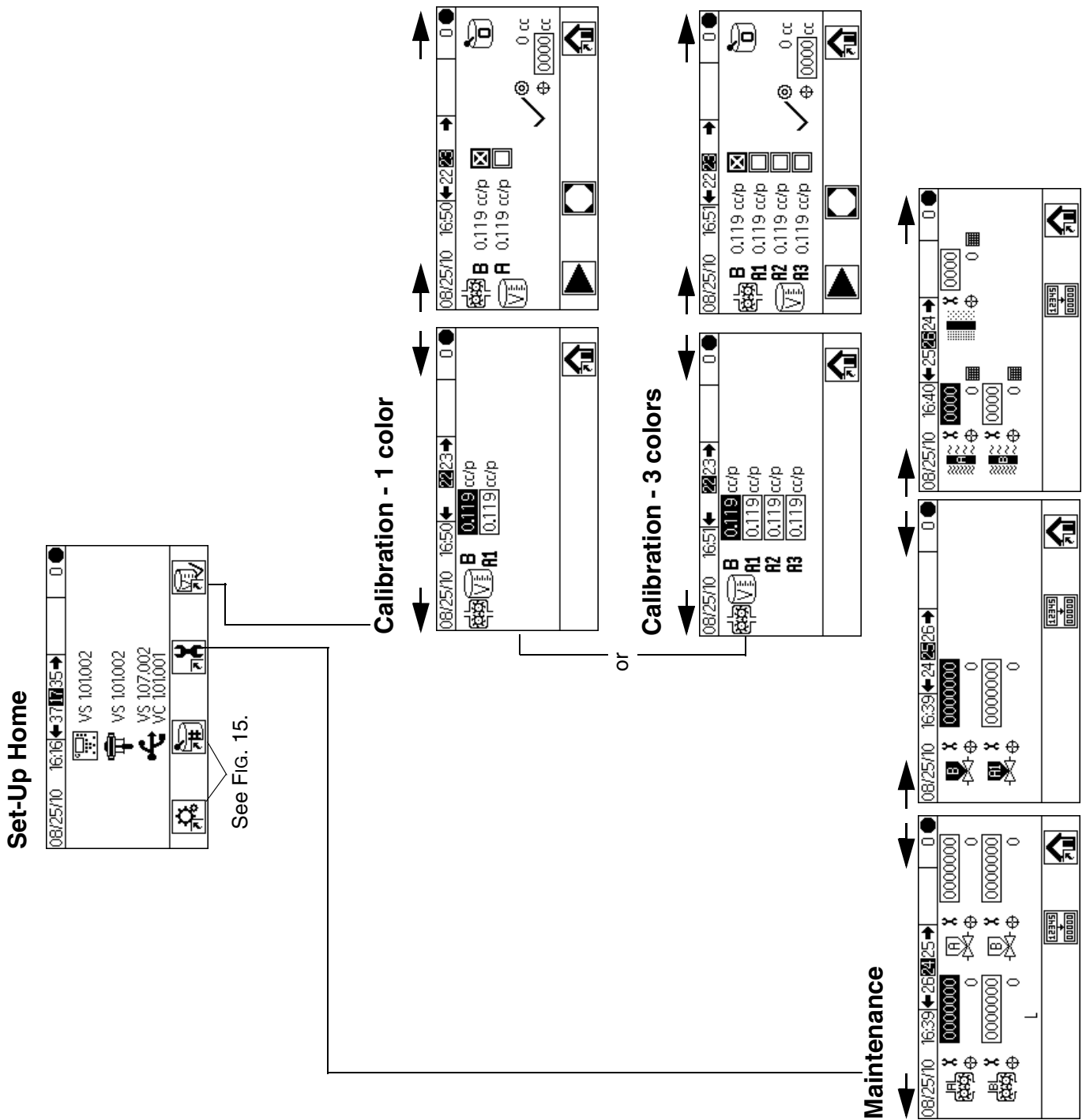

FIG. 16. Setup Mode Screen Map, page 2

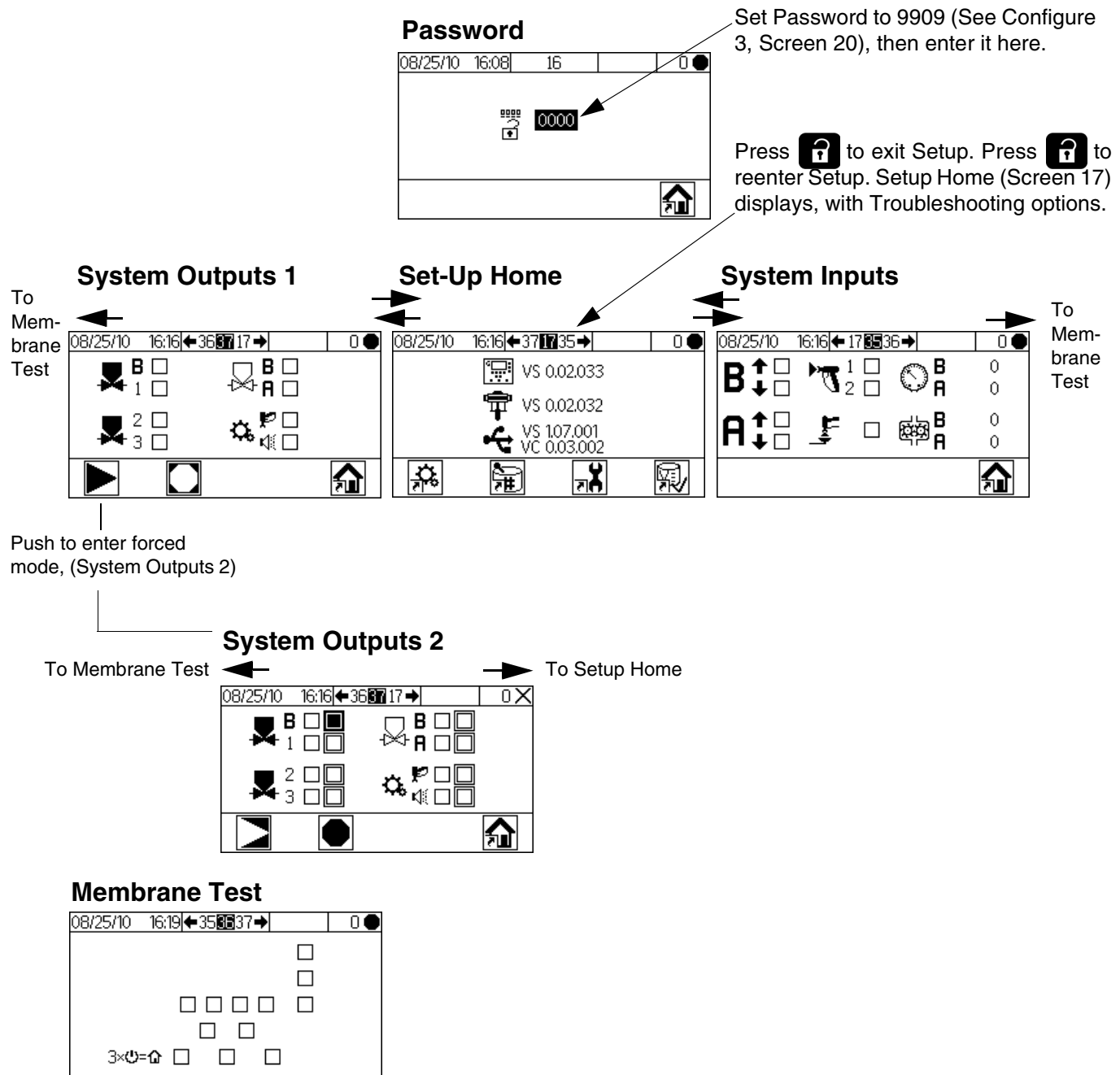

FIG. 17. Troubleshooting Screen Map

Basic Operation

Pre-Operation Tasks

Go through the Pre-Operation Checklist in Table 2.

Table 2: Pre-Operation Checklist

✓	Checklist
	System grounded Verify all grounding connections were made. See Grounding , page 21.
	All connections tight and correct Verify all electrical, fluid, air, and system connections are tight and installed according to the manual instructions.
	Fluid supply containers filled Check all supply containers - A1 (A2 and A3, if present), B, and solvent.
	Dose valves set Check that the dose valves are set correctly. Start with the settings recommended in Valve Settings , page 38, then adjust as needed.
	Fluid supply valves open and pressure set Component A and B fluid supply pressures should be equal unless one component is more viscous and requires a higher pressure setting.
	Solenoid pressure set 75-100 psi inlet air supply (0.5-0.7 MPa, 5.2-7 bar)

Power On

1. **IS Systems (Alternator Power Supply):** Set pump air regulators to minimum setting. Open main air valve to start air-powered alternator. Main air pressure is displayed on gauge. Display Module screen will display after five seconds.

Non-IS Systems (Wall Power Supplied): Turn the AC Power Switch ON (1 = ON, 0 = OFF).

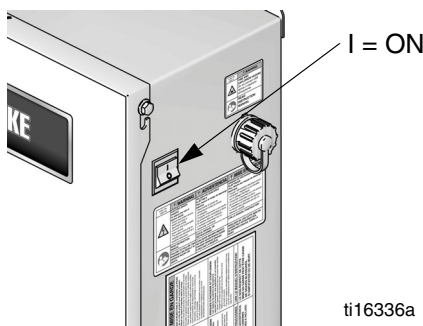

FIG. 18. Power Switch

2. Graco logo will display after five seconds, followed by Run Mix Spray (Screen 2).

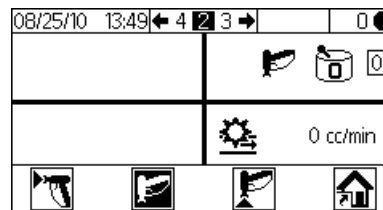

FIG. 19. Run Mix Spray (Screen 2)

Initial System Setup

1. Change optional setup selections to desired parameters, as described in **Configure 1-4 (Screens 18-21)**, page 46.
2. Set recipe and flush information as described in **Recipe 0 (Screen 27)**, **Recipe 1-1 (Screen 28)**, and **Recipe 1-2 (Screen 29)**, page 47.
3. Set maintenance timers for meters, solvent valves, dose valves, fluid filters and air filters, as described in **Maintenance 1-3 (Screens 24-26)**, page 48.

Prime the System

NOTE: See **Run Mode Details**, pages 42-43, for further screen information, if needed.



1. Adjust the main air pressure. Most applications require about 80 psi (552 kPa, 5.5 bar) air pressure to operate properly. Do not use less than 75 psi (517 kPa, 5.2 bar).
2. If this is the first time starting up the system, or if lines may contain air, purge as instructed in **Purging**, page 34. The equipment was tested with light-weight oil, which should be flushed out to avoid contaminating your material.
3. From Run Home (Screen 1), press . Make sure that the system is in Standby mode.

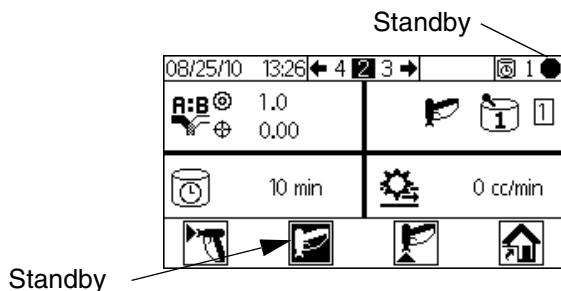

4. Adjust component A and B fluid supplies as needed for your application. Use lowest pressure possible.

NOTE: Do not exceed the maximum rated working pressure shown on the system identification label or the lowest rated component in the system.

5. Open the fluid supply valves to the system.
6. If using an electrostatic gun, shut off the electrostatics before spraying.
7. If using a gun flush box, place the gun in the box and close the lid.
8. Use to change to desired color recipe.

9. Press . The system will purge, then load mixed material to the gun. If the gun flush box is not used, trigger the gun into a grounded metal pail until the system returns to Standby.

Meter Calibration

NOTE: See **Calibration 1 and 2 (Screens 22 and 23)**, page 49, for further screen information, if needed.



Calibrate the meter:

- The first time the system is operated.
- Whenever new materials are used in the system, especially if the materials have viscosities that differ significantly.
- As part of regular maintenance to retain meter accuracy.
- Whenever a flow meter is serviced or replaced.

NOTE:

- Meter factors on Calibration 1 (Screen 22) are updated automatically after the calibration procedure is completed. You also may manually edit them if desired.
 - All values on this screen are in cc or cc/pulse, regardless of the units set in Configure 4 (Screen 21).
1. Before calibrating Meter A or Meter B, prime the system with material. See **Prime the System**, page 32.
 2. If the display is on a Run Mode screen, press to access setup screens.
 3. Press to display Calibration 1 (Screen 22). K-factors are shown for B and A1 (A2, A3 if present).

4. Press to move to Calibration 2 (Screen 23).
5. Press to highlight the meter you wish to calibrate. Press . An X displays in the box.
6. Press to start the calibration on the checked meter (A with fluid A1, A2, or A3, or B). Press to cancel the calibration.
7. Trigger gun into a graduated cylinder. Dispense a minimum of 200-300cc of material.

NOTE: Stop triggering the gun when desired amount is reached. **Do not** press , as it will cancel the calibration.

8. The volume that the ProMix 2KE measured displays on the Display Module.

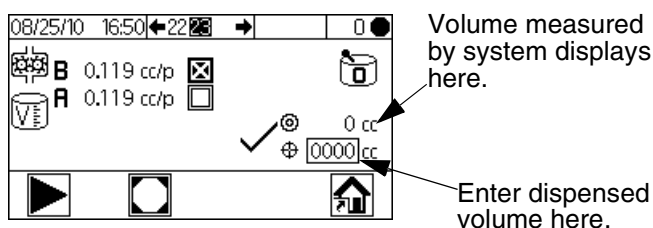

FIG. 20. Dispensed Volume Comparison

9. Compare the amount on the Display Module to the amount in the graduated cylinder.

NOTE: For maximum accuracy, use a gravimetric (mass) method to determine the actual volumes dispensed.

- If the screen and actual volumes are different, press to highlight the dispense volume field. Press . Press to move between digits. Press to change a digit. Press when field is correct.

NOTE: If the value is substantially different, repeat the calibration process until the dispensed volume and measured volume match.

10. After the volume for A1 (A2, A3) or B is entered, the ProMix 2KE controller calculates the new k-factor and shows it on Calibration 1 (Screen 22) and Calibration 2 (Screen 23).
11. Before you begin production, clear the system of solvent and prime it with material.
 - a. Go to Mix mode.
 - b. Trigger the gun into a grounded metal pail until mixed material flows from the gun nozzle.

Spraying

NOTE: See **Run Mode Details**, pages 42-43, for further screen information, if needed.



1. Calibrate the meters as described in **Meter Calibration**, page 32. Meter k-factors will update automatically based on calibration results. Make additional manual changes, if desired, as described in **Calibration 1 and 2 (Screens 22 and 23)**, page 49.
2. Press . The system will load the correct potlife volume based on hose length and diameter entered on Configure 2 (Screen 19). Once material is loaded, the system returns to Standby. Press again to spray the active recipe.

- Adjust the flow rate. The fluid flow rate shown on the Display Module screen is for either component A or B, depending on which dose valve is open.

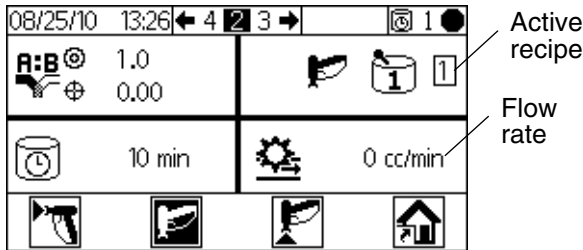

FIG. 21. Flow Rate Display

If the fluid flow rate is too low: increase air pressure to component A and B fluid supplies or increase the regulated fluid pressure of mixed material.

If the fluid flow rate is too high: reduce the air pressure to component A and B fluid supplies, close the dose valves further, or decrease the regulated fluid pressure of mixed material.

- Turn on atomizing air to the gun. Check the spray pattern as instructed in your spray gun manual.

NOTE:

- Pressure adjustments of each component will vary with fluid viscosity. Start with the same fluid pressure for component A and B, then adjust as needed.
- Do not use the first 4-5 oz. (120-150 cc) of material as it may not be thoroughly mixed due to errors while priming the system.

NOTICE

Do not allow a fluid supply tank to run empty. It is possible for air flow in the supply line to turn gear meters in the same manner as fluid. This can damage the meters and lead to the proportioning of fluid and air that meets the ratio and tolerance settings of the equipment. This can further result in spraying uncatalyzed or poorly catalyzed material.



Purging

NOTE: See **Run Mode Details**, pages 42-43, for further screen information, if needed.



Purge the system:

- at the end of potlife
- breaks in spraying that exceed the potlife
- overnight shutdown or end of shift
- the first time material is loaded into equipment
- servicing
- shutting down equipment for an extended period of time

- Press  on Run Mix Spray (Screen 2) or  from any screen to put the system in Standby.
- Trigger the gun to relieve pressure.
- If you are using a high pressure gun, engage the trigger lock. Remove spray tip and clean tip separately.
- If using an electrostatic gun shut off the electrostatics before flushing the gun.
- Set the solvent supply pressure regulator at a pressure high enough to completely purge the system in a reasonable amount of time but low enough to avoid splashing or an injection injury. Generally, a setting of 100 psi (0.7 MPa, 7 bar) is sufficient.
- If using a gun flush box, place the gun into the box and close the lid.
- Press  on Run Mix Spray (Screen 2). The purge sequence automatically starts.

If the gun flush box is not used, trigger the gun into a grounded metal pail until the purge sequence is complete.



When done purging, the system automatically switches to Standby mode.

- If the system is not completely clean, repeat step 6.

NOTE: If necessary, adjust purge sequence times so only one cycle is required.

- Trigger the gun to relieve pressure. Engage trigger lock.
- If spray tip was removed, reinstall it.
- Adjust the solvent supply regulator back to its normal operating pressure.

NOTE: The system remains full of solvent.

NOTE: If your system uses 2 guns, you must trigger both guns simultaneously during a purge to purge both guns and lines. Verify that clean solvent flows from each gun. If not, repeat purge or clear clog/blockage in system.

Color Change

Color Change Sequence

Step 1. Color Purge. The system flushes out the color with solvent. The selected color change solvent valve opens during Purge Time and closes when the time expires.

Step 2. Catalyst Purge. The system flushes out the catalyst with solvent. The catalyst change solvent valve opens during Purge Time and closes when the time expires.





Step 3. Final Purge. The system fills the line with the selected purge media (usually solvent). The selected purge valve opens during the Final Purge Time and closes when the time expires.

Step 4. Catalyst Fill. The system fills the line with new catalyst. The new catalyst valve opens during the Fill Time and closes when the fill volume is reached.

Step 5. Color Fill. The system fills the line with new color. The new color valve opens during the Fill Time and closes when the fill volume is reached.

Step 6. Mixed Material Fill. The system fills the line with mixed material. The system begins mixing components A and B until the fill volume expires.

Color Change Procedures

- Place the gun in the gun flush box if used, and close the lid.
- Press  on Run Mix Spray (Screen 2) or  from any screen to put the system in Standby.
- Use the scroll keys,  or , to select the new color. Press  to begin the color change sequence.

- If a gun flush box is not used, trigger the gun into a grounded metal pail until the color change sequence is complete. If your system has two guns, trigger both guns at the same time.

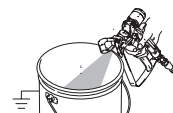

NOTE: The color change timer does not start until the gun is triggered and fluid flow is detected. If no flow is detected within 2 minutes, the color change operation aborts. The Display Module enters

Standby  mode at the previous color.

Error SG occurs if the gun flush box is open.
Error SAD1 or **SAD2** occurs if the AFS is on.

- Trigger the gun (or guns) while the system flushes the current color, purges with solvent, and loads the new color.

NOTE: If your system uses 2 guns, you must trigger both guns simultaneously during the entire color purge, solvent purge, and load color sequence.

NOTE: If you do not see clear solvent flow, the system did not flush successfully. Stop the color change. Look for a clog in the line or increase the flush time.

- During color change, the Recipe icon blinks on and off, and you'll see the number of the current color and the new color. When the color change is complete, Standby is highlighted.
- When you are ready to spray, remove the gun from the gun flush box if used, and close its door.

NOTE: The gun flush box door must be closed for the atomizing air valve to open.

- Press  to start spraying.

Purge/Color Change Detail

Purge/Flush

The Purge Sequence flushes the lines from the A & B color stacks through the mix manifold and out to the gun(s).

"A" has a pre-assigned (not selectable) valve. "B" has a pre-assigned (not selectable) valve.

If you choose a third flush option, it can be "A" or "B" (not "A" and "B"). You do not have an option to select something other than "A" or "B" valve. For example, if "A" was water and "B" was solvent. The third flush options would have to be "A" water or "B" solvent. You couldn't assign a third option like air.

The following should be the only selectable flush sequence options:

A, B, 0 A, B, A A, B, B A, 0, A
 A, 0, B 0, B, 0 0, B, A 0, B, B

There are 4 basic purge sequences as follows:

1. Selecting the purge button on the pendant. The purge sequence from the recipe that you are currently in is used. The system is left full of solvent.
2. Color Change from A1, A2 or A3 to A1, A2 or A3. The purge sequence from the recipe you are leaving is used. After the purge sequence completes, the premix fill, from the recipe that you are going to, starts (blinking recipe number, etc).
3. Color Change from A1, A2 or A3 to Zero. The recipe zero purge sequence is used. The system is left full of solvent.
4. Color change from Zero to Zero. The recipe zero purge sequence is used. The system is left full of solvent.

NOTE: Color Change from Zero to A1, A2 or A3. The system does not do a purge sequence. It immediately starts the premix fill sequence.

A SPSA/SPSB alarm (Not enough volume during purge) is generated when the end of a purge phase is reached (Time specified by user), and the system has not totaled at least 10cc of material.

Pre-Mix Fill

Premix fill sequence (right after purge sequence) loads 60 cc of the A1, A2, or A3 and B1, from the color stack, to the mix manifold.

In the premix fill sequence, a SFA1/SFA2/SFA3/SFB1 alarm (Premix fill, low flow) is generated if there are less than 10 ccs in 60 seconds.

SHA1/SHA2/SHA3/SHB1 alarm (Not enough premix fill volume) is generated if there are less than 50 ccs in 60 seconds.

NOTE: Premix fill always starts with the "B" side.

Mix Fill

The mix fill sequence (right after premix fill) loads A1, A2, or A3: B1 mixed material (Ratio specified by user) out to the gun(s). It loads 110% of the volume of the hoses plus the volume of the manifold: (hose 1 + hose 2 + manifold) x 1.1

SM (mix fill low flow) is generated if there are less than 50ccs in 60 seconds during a mix fill sequence.

SN (Not enough mix fill volume) is generated if less than the mix fill volume is loaded in 5 minutes during a mix fill sequence.

Pressure Relief Procedure

--	--	--	--	--	--	--

To reduce the risk of skin injection, relieve pressure when you stop spraying, before changing spray tips, and before cleaning, checking, or servicing equipment.

NOTE: The following procedure relieves all fluid and air pressure in the ProMix 2KE system.

1. Press on Run Mix Spray (Screen 2) or from any screen to put the system in Standby.
2. Shut off the A1 (plus A2 and A3, if using multiple colors) and B fluid supply pumps/pressure pots.
3. Remove the Control Box cover.
4. With the gun triggered, push the manual override on the A1 (A2, A3) and B dose valve solenoids to relieve pressure. See FIG. 22.
5. Follow **Purging** procedure, page 34.
6. Shut off the fluid supply to solvent valves A and B.
7. With the gun triggered, push the manual override on the A and B solvent valve solenoids to relieve solvent pressure. See FIG. 22. Verify that solvent pressure is reduced to 0.
8. Reinstall the Control Box cover.

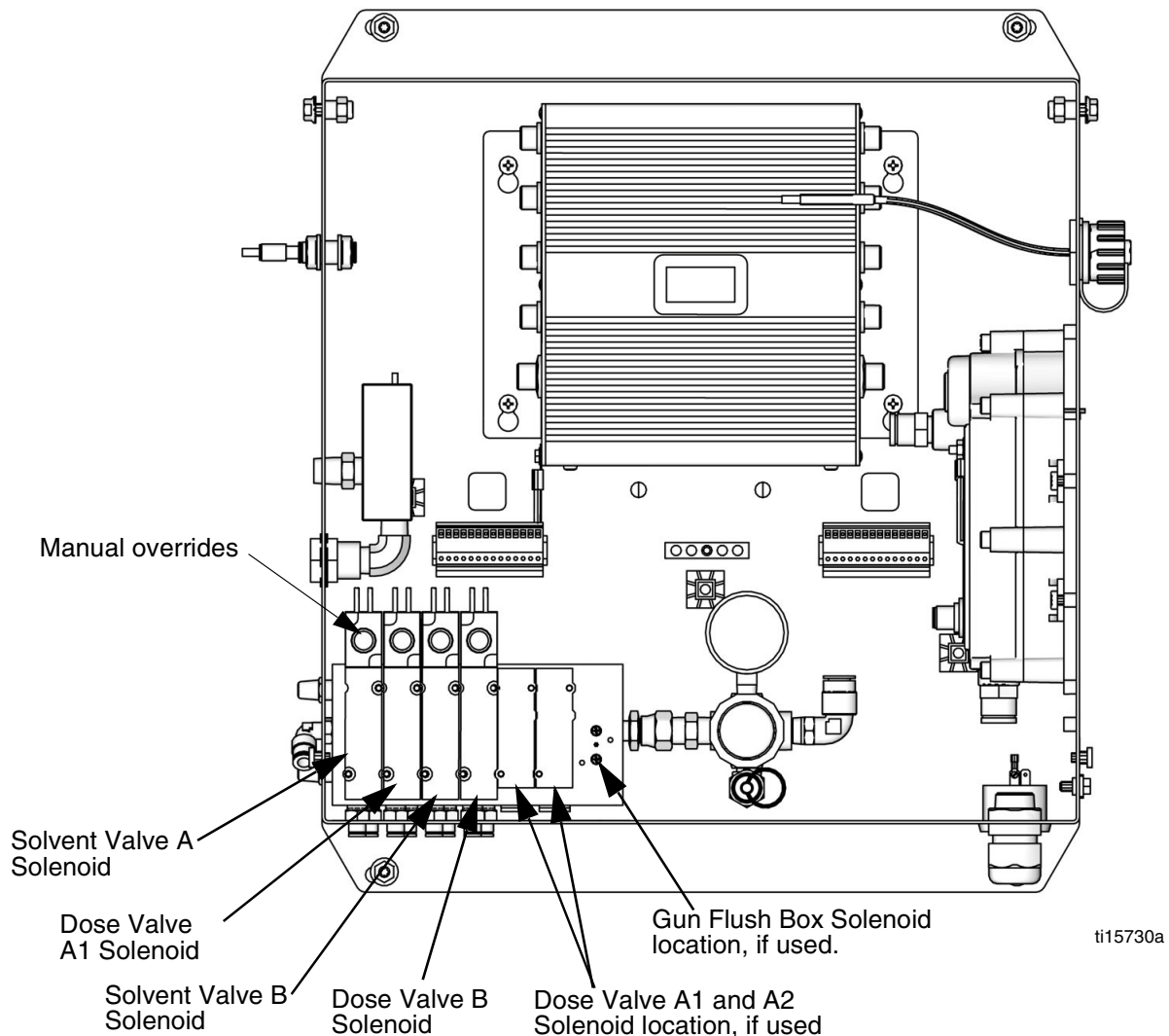

FIG. 22. Solenoid Valves in Control Box

Lock Mode

NOTE: Do not change system type, number of guns, hose length, hose diameter, dosing type, or number of colors when material is loaded in the system. Change these inputs only if system hardware is changed.

If you change one of these inputs, the system locks so that you cannot spray or mix. The lock icons display.

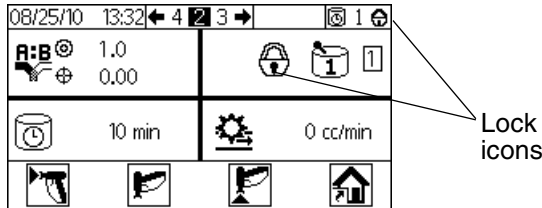
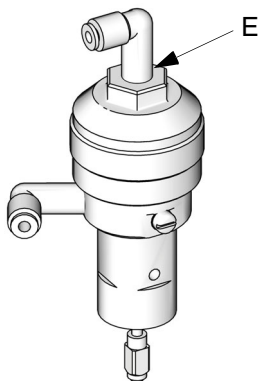

FIG. 23. System Lock Mode

Power down and power back up again to clear the lock and put the new settings into effect. The lock ensures that the selection was intended and prevents operation with incorrect settings.

Valve Settings

Dose valves and purge valves are factory set with the hex nut 1-1/4 turns out from fully closed. This setting limits maximum fluid flow rate into integrator and minimizes valve response time. To open dose or purge valves (for high viscosity materials), turn hex nut (E) *counterclockwise*. To close dose or purge valves (for low viscosity materials), turn *clockwise*. See FIG. 24.



TI11581a

FIG. 24. Valve Adjustment

Shutdown

1. Follow **Purging**, page 34.
2. Close main air shutoff valve on air supply line and on ProMix 2KE.
3. **Non-IS Systems:** Shut off ProMix 2KE power (0 position). **NOTE:** The system will restart in Recipe 0.

Use of Optional USB Module

USB Logs

Job Log 1

See example in FIG. 25. The job log records total volumes for each job that the system performs, up to 2000. It records the date, time, user number, job number, total A volume, total B volume, mix ratio, and the recipe used. Job total volumes are in cubic centimeters. A log entry is made whenever a new job is initiated, which occurs when batch totals are cleared, when the job number is incremented from Run Job Number (Screen 38), or when a color change is performed. Job information is displayed on the Display Module **only** through use of the optional USB Module.

NOTE: User Number, Ratio, and Alarm 1-5 are displayed as of 2KE System Software version 1.03.001 (USB Cube Software version 1.10.001).

Error Log 2

See example in FIG. 26. The error log records all errors generated by the system, up to 500. It records the date, time, error number, error code, and error type for each error that occurs. Without the USB, the user can access the 50 most recent errors via the Display Module.

NOTE: For both the Job Log and the Error Log, when the log is full, new data automatically overwrites old data. When data in either log is downloaded via the USB, it remains in the module until it is overwritten.

	A	B	C	D	E	F	G	H	I	J	K	L	M
1	Job Log												
2	USB Serial Number: 09001088												
3	Software Part Number: 15W201												
4	Software Revision: 1.10.001												
5	#####												
6													
7	Date	Time	User Number	Job No.	Ratio	Job Total: A	Job Total: B	Job Recipe No.	Alarm 1	Alarm 2	Alarm 3	Alarm 4	Alarm 5
8	8/12/13	16:32:10	300000010	633	1	502	488	1	-	-	-	-	-
9	8/12/13	16:37:54	300000010	634	30	0	0	2	SFA2	-	-	-	-
10	8/12/13	16:41:49	300000010	635	0	360	0	3	-	-	-	-	-
11	8/12/13	16:42:22	300000010	636	1	0	0	1	-	-	-	-	-
12	8/12/13	17:54:51	300000010	637	30	0	0	2	QLBX	SAD1	SAD1	SFA2	SFA2
13													
14													
15													
16													
17													
18													
19													
20													
21													
22													
23													
24													
25													
26													
27													
28													
29													
30													
31													
32													
33													
34													
35													
36													
37													
38													
39													
40													
41													
42													
43													
44													
45													
46													

FIG. 25. Sample Job Log

Date	Time	Alarm Number	Alarm	Type of Alarm
7/26/13	0:00:10	618	MGA1	ADVISORY
7/26/13	0:00:11	619	MGB1	ADVISORY
7/29/13	12:03:38	620	EL	RECORD
7/29/13	12:03:39	621	MESA	ADVISORY
7/29/13	12:03:40	622	MGA1	ADVISORY
7/29/13	12:03:41	623	MGB1	ADVISORY
218569986	12:03:48	624	EL	RECORD
218569986	12:03:49	625	CA	ALARM
218569986	12:03:50	626	MESA	ADVISORY
218569986	12:03:51	627	MGA1	ADVISORY
218569986	12:03:52	628	MGB1	ADVISORY
218569986	12:03:53	629	MGP1	ADVISORY
2018569987	12:04:00	1617	EL	RECORD
218569987	12:04:01	1618	CA	ALARM
218569988	12:04:08	624	EL	RECORD
218569988	12:04:09	625	CA	ALARM
218569988	12:04:10	626	MESA	ADVISORY
218569988	12:04:11	627	MGA1	ADVISORY
218569988	12:04:12	628	MGB1	ADVISORY
218569988	12:04:13	629	MGP1	ADVISORY
8/8/13	12:08:00	624	EL	RECORD
8/8/13	12:08:01	625	MESA	ADVISORY
8/8/13	12:08:02	626	MGA1	ADVISORY
8/8/13	12:08:03	627	MGB1	ADVISORY
8/8/13	12:08:19	628	EQU1	RECORD
8/8/13	12:22:23	1617	EL	RECORD
8/8/13	12:26:25	1689	EL	RECORD
8/8/13	12:26:57	1690	EL	RECORD
8/8/13	12:27:19	1691	EL	RECORD
8/8/13	12:28:33	1692	EL	RECORD
8/8/13	12:29:01	1693	EL	RECORD
8/8/13	12:29:28	1694	EL	RECORD
8/8/13	14:50:45	1695	EL	RECORD
8/8/13	14:52:15	1696	EL	RECORD
8/8/13	15:19:49	1697	EL	RECORD
8/8/13	15:33:55	1703	EL	RECORD
8/8/13	15:35:28	1706	EL	RECORD
8/8/13	15:39:48	1707	EL	RECORD
8/8/13	15:50:46	1710	EL	RECORD
8/8/13	15:52:14	1711	EL	RECORD
8/12/13	16:22:05	631	EL	RECORD
8/12/13	16:22:06	632	MESA	ADVISORY
8/12/13	16:22:07	633	MGA1	ADVISORY
8/12/13	16:22:08	634	MGB1	ADVISORY
8/12/13	16:33:18	635	SFA2	ALARM
8/12/13	16:43:30	636	SFA2	ALARM
8/12/13	16:45:27	637	EQU1	RECORD
8/12/13	17:51:42	638	SFA2	ALARM
8/12/13	17:52:33	639	SAD1	ALARM
8/12/13	17:53:37	640	SAD1	ALARM
8/12/13	17:54:07	641	QLBX	ALARM

FIG. 26. Sample Error Log

Setup

The only setup required is to select the language in which you want to view the downloaded data. (Screens are icon-based and do not change.) Navigate to Config-ure 3 (Screen 20). Select your language from the language dropdown.

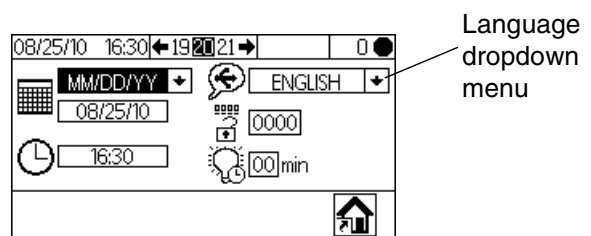
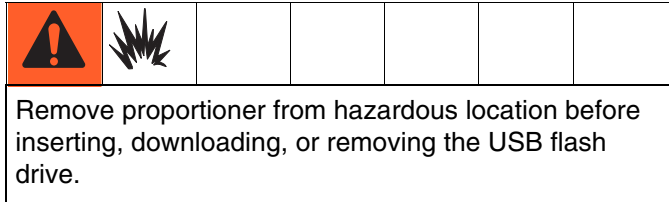



FIG. 27. Select Language for USB Logs

Download Procedure



1. Press  on Run Mix Spray (Screen 2) or  from any screen to place the system in Standby.

NOTE: The system will not operate with a USB flash drive in the port. If you insert the flash drive while spraying, the system will stop and an alarm error will occur.

2. Insert USB flash drive into USB port. Use only Graco-recommended USB flash drives; see **Recommended USB Flash Drives**, page 41.
3. Data download begins automatically. An LED on the flash drive blinks until the download is complete.

NOTE: If you use a flash drive that does not have an LED, open the Control Box. An LED near the USB module flashes until the download is complete.

4. Remove flash drive from USB port.

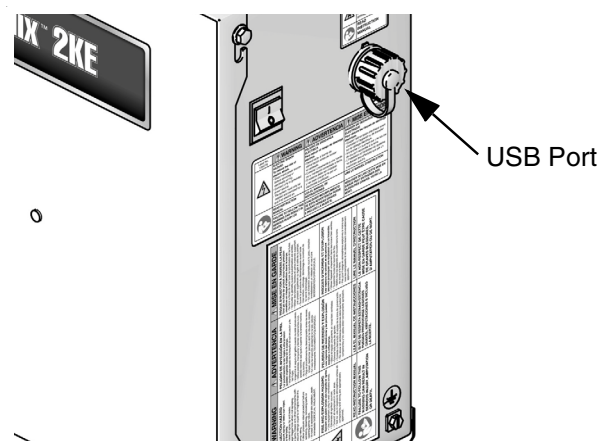
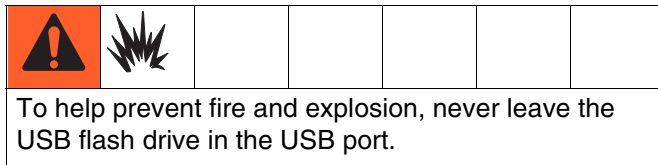

Fig. 28. USB Port

5. Insert USB flash drive into USB port of computer.

6. The USB flash drive window automatically opens. If it does not, open USB flash drive from within Windows® Explorer.
7. Open Graco folder.
8. Open sprayer folder. If downloading data from more than one sprayer, there will be more than one sprayer folder. Each sprayer folder is labeled with the corresponding USB serial number.
9. Open DOWNLOAD folder.
10. Open folder labeled with the highest number. The highest number indicates the most recent data download.
11. Open log file. Log files open in Microsoft® Excel® by default. However, they can also be opened in any text editor or Microsoft® Word.

NOTE: All USB logs are saved in Unicode (UTF-16) format. If opening the log file in Microsoft Word, select Unicode encoding.

Recommended USB Flash Drives

It is recommended that users use the 4GB USB flash drive (16A004) available for purchase separately from Graco. If preferred, users may use one of the following 4 GB or less USB flash drives (not available from Graco).

- Crucial Gizmo!™ 4GB USB flash drive (model JDO4GB-730)
- Transcend JetFlash® V30 4GB USB flash drive (model TS4GJFV30)
- OCZ Diesel™ 4GB USB flash drive (model OCZUSBD4G)

Run Mode Details

Run Mix Spray (Screen 2)

Run Mix Spray (Screen 2) displays at startup or if  is selected from Run Home (Screen 1). Use the Mix Spray screen to control most mixing operations.

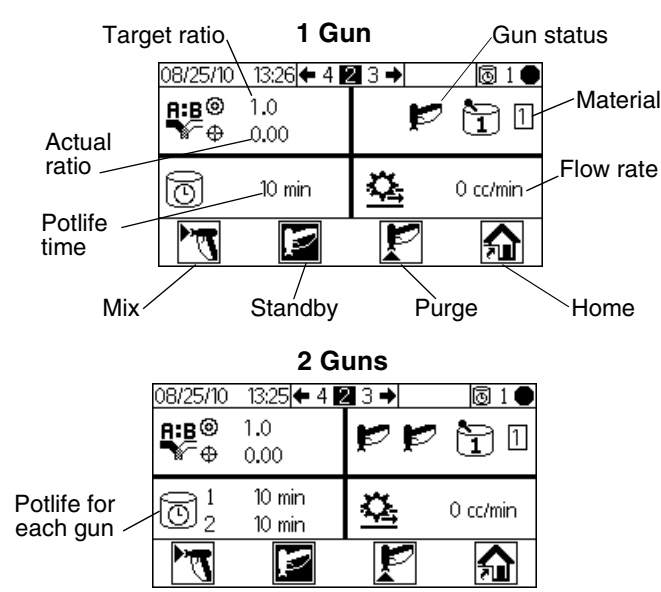





FIG. 29. Run Mix Spray (Screen 2)

- Press   to toggle between Run Mix Spray (Screen 2), Run Mix Batch (Screen 3), Run Mix Totals (Screen 4), and Run Job Number (Screen 38).
- Press  to access Run Home (Screen 1).

Run Home (Screen 1)

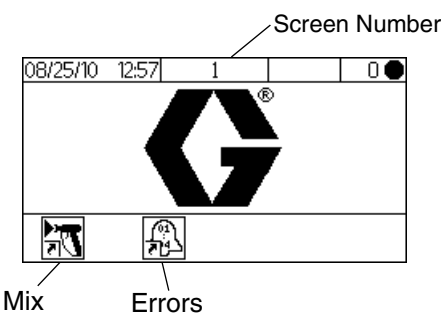







FIG. 30. Run Home (Screen 1)

- Press a soft key button to select one of the main Run Mode screen sections: Mix  or Errors .
- Press  to enter the Setup screens.

Run Mix Batch (Screen 3)

Run Mix Batch (Screen 3) displays if   is selected from Run Mix Spray (Screen 2). Use the Mix Batch screen to dispense set volumes. Target volume can be set from 1 to 9999 cc.

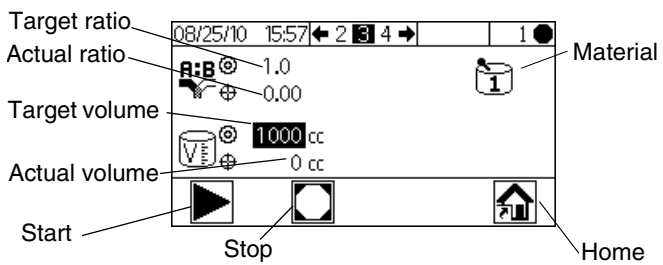











FIG. 31. Run Mix Batch (Screen 3)

- Press  to set the target dispense volume. Use   to change each digit, then   to move to the next digit. Press  when finished.
- Press   to toggle between Run Mix Spray (Screen 2), Run Mix Batch (Screen 3), Run Mix Totals (Screen 4), and Run Job Number (Screen 38).

Run Mix Totals (Screen 4)

Run Mix Totals (Screen 4) displays if   is selected from Run Mix Batch (Screen 3). Use this screen to view grand and batch totals for material A1, A2, A3, and material B, and to clear batch totals if desired.

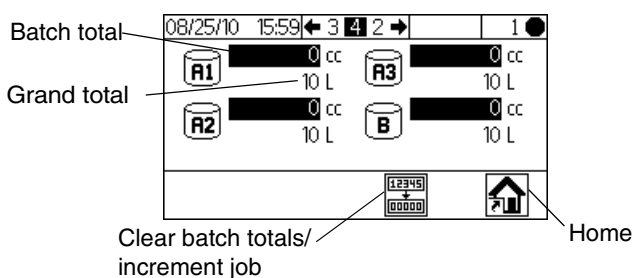







FIG. 32. Run Mix Totals (Screen 4)

- Press  to clear all batch totals. A verification screen appears. Use   to highlight and press  on  to clear the batch totals, or on  to return to the Run Totals (Screen 4) without clearing.

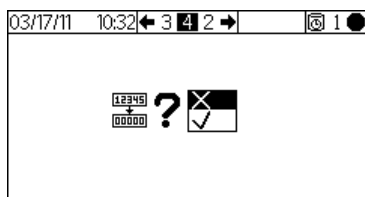





FIG. 33. Confirm Clear Batch Totals

- Press   to toggle between Run Mix Spray (Screen 2), Run Mix Batch (Screen 3), Run Mix Totals (Screen 4), and Run Job Number (Screen 38).

Run Job Number (Screen 38)

Run Job Number (Screen 38) displays if   is selected from the Run Mix Totals Screen. Use this screen to view and increment the job number as well as view and assign a 9-digit user number to the job.

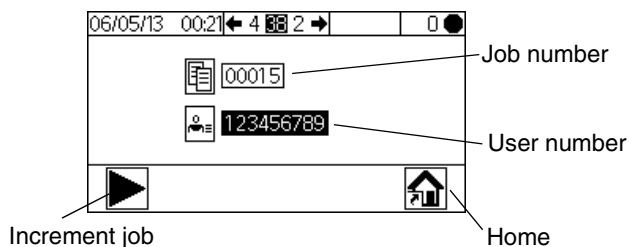









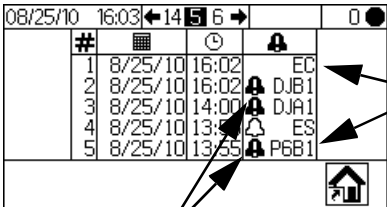

FIG. 34. Run Job Number (Screen 38)

- Press  to set the user number. Use   to change each digit, then   to move to the next digit. Press  when finished.
- Press  to increment the job number.
- Press   to toggle between Run Mix Spray (Screen 2), Run Mix Batch (Screen 3), Run Mix Totals (Screen 4), and Run Job Number (Screen 38).

Run Log Errors (Screens 5-14)



Run Log Errors (Screens 5-14) display if  is selected from Run Home (Screen 1). It displays the last 50 errors in the log. (Screen 5 displays errors 1 to 5; Screen 6 displays errors 6 to 10, etc.).



#	Date	Time	Error Code
1	8/25/10	16:02	EC
2	8/25/10	16:02	DJB1
3	8/25/10	14:00	DJA1
4	8/25/10	13:55	ES
5	8/25/10	13:55	P6B1

Arrows in the image point to the error codes (EC, DJB1, DJA1, ES, P6B1) and the error icons (bell icons) in the table.

FIG. 35. Run Log Errors (Screen 5)

- Use   to view the next page. See FIG. 57, page 55, for an explanation of the different error icons. See Table 5, page 57, for an explanation of the different error codes.

Setup Mode Details

Press  on any screen to enter the Setup screens. If the system has a password lock, Password (Screen 16) displays. If the system is not locked (password is set to 0000), Setup Home (Screen 17) displays.

Password (Screen 16)

From any Run screen, press  to access the password screen. Password (Screen 16) displays if a password has been set. Set the password to 0000 to prevent the Password Screen from displaying. See Configure 3 (Screen 20), page 46, to set or change the password.

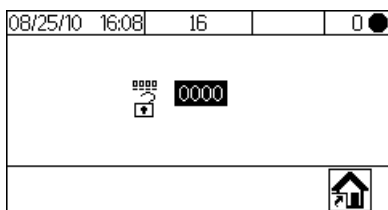











FIG. 36. Password (Screen 16)

- Press  to enter the password (0000 to 9999). Press   to move between digits. Press   to change a digit. Press  when field is correct. Setup Home (Screen 17) displays.
- Press  to toggle between Run Mode and Setup Mode.
- Select  to display Run Home (Screen 1). Entering an incorrect password also displays Run Home (Screen 1).

Setup Home (Screen 17)

Setup Home (Screen 17) displays if  is selected on any screen and the system is not locked, or when a correct password is entered on Password (Screen 16). The Setup Home screen displays the software versions of the boards in the Display Module, Advanced Fluid Control Module, and the USB Module (if applicable).

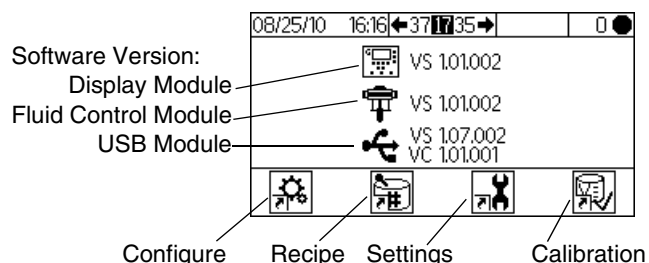







FIG. 37. Setup Home (Screen 17)

- Press a soft key button to select one of the four Setup Mode screen sections:
Configure , Recipe , Maintenance , or Calibration .
- Press  to toggle between Run Mode and Setup Mode.

Configure 1-4 (Screens 18-21)

Configure 1 (Screen 18) displays if  is selected on Setup Home (Screen 17). This screen allows users to set up the system type (pump or meter), the type of dosing (sequential or dynamic), number of guns (1 or 2), and the system color configuration (1 or 3).

NOTE: If 1 gun is selected, users can enable a gun flush box (=yes; =no). The gun flush box option is available only for 1-gun systems.

NOTE: If your application requires only 2 colors, the system is still configured for 3 colors. Select 3 from the dropdown menu.

Dynamic vs. Sequential Dosing: See page 51 and following for a description of each type of dosing, to help you select the best option for your system. The options are:

- A-B 50cc**
(Select for sequential dosing, 50cc dose size.)
- A-B 100cc**
(Select for sequential dosing, 100cc dose size.)
- A || B**
(Select for dynamic dosing.)

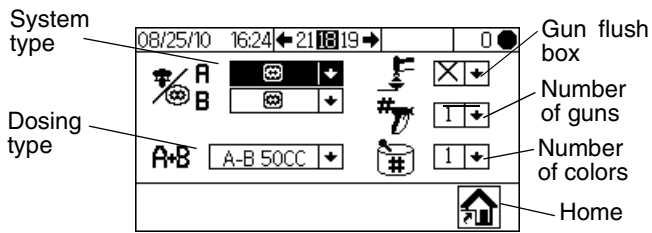

FIG. 38. Configure 1 (Screen 18)

- Press **↓** **↑** to highlight the desired field. Press **↵** to display the dropdown menu for that field. Press **↓** **↑** to choose from the menu options and **↵** to set. Press **↓** **↑** to move to the next field.
- Press **←** **→** to move through Configure 2 (Screen 19), Configure 3 (Screen 20), and Configure 4 (Screen 21).

NOTE: If you change system type (meter to pump), number of guns, dosing type, or number of colors, a verification screen appears. Use **↓** **↑** to highlight and press **↵** on the **✓** to make the change, or on the **✗** to return to Configure 1 (Screen 18) without making a change. If a change is made, the system locks so that you cannot spray or mix. Power down and power back up again to clear the lock and put the new settings into effect. The lock ensures that the selection was intended, and prevents the user from attempting to operate with incorrect settings.

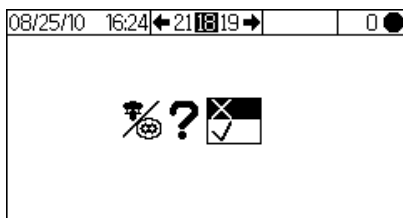

FIG. 39. Confirm Change of System Type

Configure 2 (Screen 19) allows users to set for each gun the hose length (0.1 to 45.7 m, 0.3 to 150 ft) and hose diameter (0.1 to 1 inch). The system uses this information to calculate pot life volume. The pot life volume tells the system how much material must be moved to trigger a reset of the pot life timer. It also tells the system the volume needed to fill during a load sequence. A change in any of these fields will trigger the lock. See **NOTE** in previous paragraph.

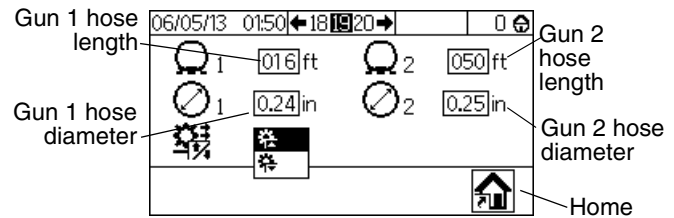
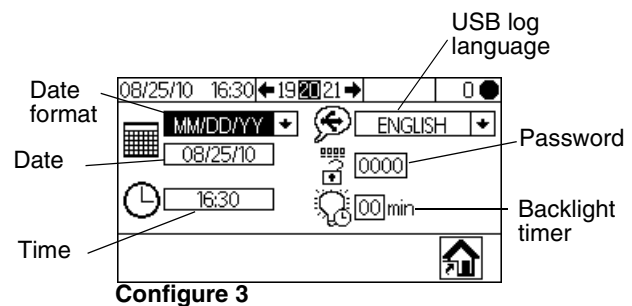
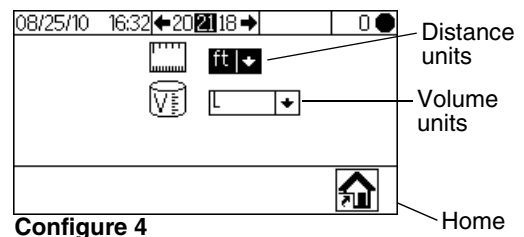

FIG. 40. Configure 2 (Screen 19)

Configure 3 (Screen 20) allows users to set preferred language (for optional USB Module), date format, date, time, password (0000 to 9999), and number of minutes (0 to 99) of inactivity required before the backlight turns off. Configure 4 (Screen 21) allows users to set preferred units for distance and volume.



Configure 3



Configure 4

FIG. 41. Configure 3 (Screen 20) and Configure 4 (Screen 21)

Recipe 0 (Screen 27)

The Recipe Screens allow the user to set up the basic recipes. Recipe 0 (Screen 27) displays if  is selected on Setup Home (Screen 17). Recipe 0 allows users to set up a full flush, independent of recipe purge timers, with no material load. It includes timers for first, second and third flush. See **Recipe 1-2 (Screen 29)**, page 47, for flush timer details.

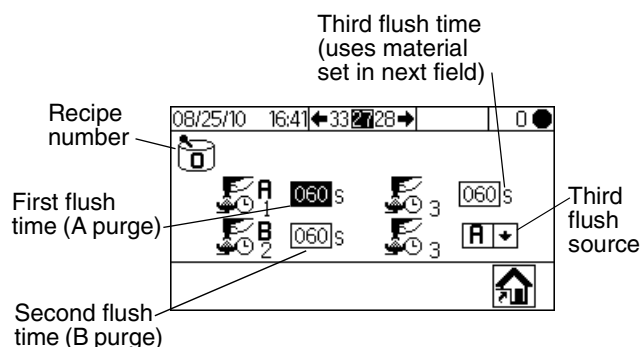



FIG. 42. Recipe 0 (Screen 27)

Recipe 1-1 (Screen 28)

Note about Settings of 0: If Ratio is set to 0, the system will dispense the A material only. If Potlife Time is set to 0, the potlife alarm is disabled.

Press   to move through the Recipe screens. The Recipe Screens allow the user to set up the basic recipe: Recipe 1-1 (Screen 28) is for A1 (color 1) and B. In 3-Color systems, Recipe 2-1 (Screen 30) is for A2 (color 2) and B, and Recipe 3-1 (Screen 32) is for A3 (color 3) and B. These screens include the ratio of Material A1 (A2, A3) to Material B (0 to 30), ratio tolerance (1 to 99 percent), and potlife time (0 to 240 minutes).

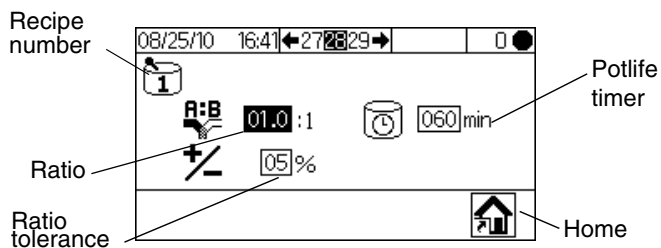

FIG. 43. Recipe 1-1 (Screen 28)

Recipe 1-2 (Screen 29)

Note about Settings of 0: If a Flush time is set to 0, that valve will not flush.

Recipe 1-2 (Screen 29) includes timers for first, second and third flush for A1 (color 1). In 3-Color systems, Recipe 2-2 (Screen 31) and Recipe 3-2 (Screen 33) allow users to set flush timers for the additional materials A2 and A3 (colors 2 and 3).

- First flush: Always an A side purge, using the A side flush material from the A purge valve.
- Second flush: Always a B side purge, using the B side flush material from the B purge valve.
- Third flush: User settable to run the A purge valve or the B purge valve for any required additional flush, as selected in the dropdown for the third flush source (A or B).

All flush times are settable from 0 to 240 seconds. Set flush time to 0 seconds to skip a flush in the sequence. For example, to skip the first flush (A side purge), enter 0 seconds. The system goes immediately to the second flush, followed by the third flush as user defined.

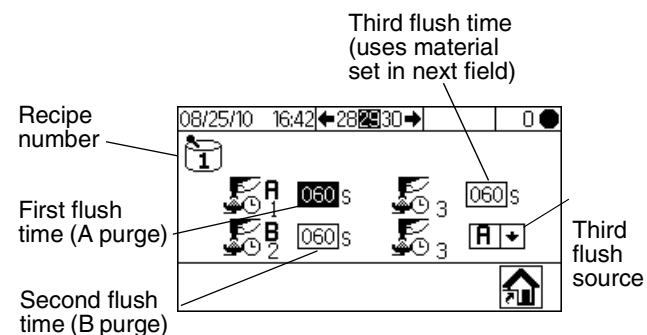











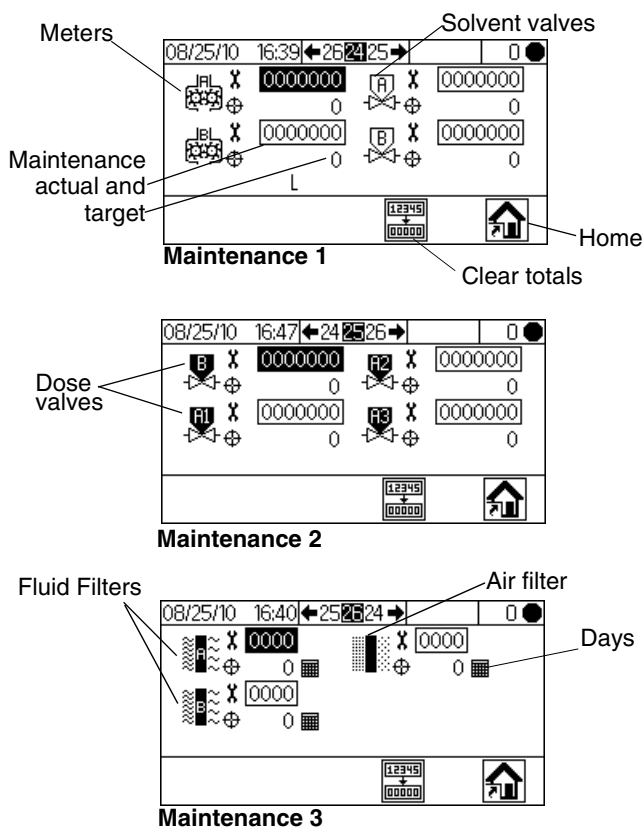

FIG. 44. Recipe 1-2 (Screen 29)

- Press   to highlight the desired field and press  to select. Press   to move between digits. Press   to change a digit. Press  when field is correct.
- Press   to move through the Recipe screens.

Maintenance 1-3 (Screens 24-26)

Maintenance 1 (Screen 24) displays if  is selected on Setup Home (Screen 17). The Maintenance Screens display actual and target maintenance timers for meters and solvent valves (Maintenance 1, Screen 24), dose valves (Maintenance 2, Screen 25), and fluid filters and air filters (Maintenance 3, Screen 26). Timers for meters are settable from 0 to 2,000,000 L or 0 to 528,344 gallons. Timers for valves are settable from 0 to 9,999,999 counts. Timers for filters are settable from 0 to 9999 days.











Maintenance Recommendations

The following table shows recommended starting values for maintenance. Maintenance needs will vary based on individual applications and material differences.

Component	Recommended Maintenance Frequency
Solvent Valves	1,000,000 cycles
Fluid Filter	5 days, daily check is recommended
Air Filter	30 days
Pumps	250,000 cycles
Dose Valves	1,000,000 cycles
Meters	5,000 gallons

FIG. 45. Setup Maintenance 1-3 (Screens 24-26)

- Press   to move through the three maintenance screens.
- Press  to clear the maintenance total that is highlighted. A confirmation screen appears. Use   to highlight and press  on the  to clear the batch totals. No other button press will clear the totals. Press  on the  to return to the active Maintenance Screen without clearing.

Calibration 1 and 2 (Screens 22 and 23)

NOTE: See **Meter Calibration**, page 32, for detailed instructions.

Calibration 1 (Screen 22) displays if  is selected on Setup Home (Screen 17). This screen displays the k factor (cc/pulse) for Meter A with fluid A1 (A2 and A3, if present) and Meter B. The system starts at the default factor values for the meters. Factor values update automatically as needed based on calibration results from Calibration 2 (Screen 23). Factor values also can be set on this screen, from 0 to 0.873 cc/pulse.

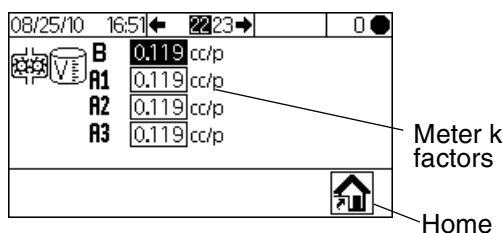



FIG. 46. Calibration 1 (Screen 22)

Press   to display Calibration 2 (Screen 23). This screen allows the user to perform a calibration. It displays Meter A (with fluid A1, A2, and A3) and Meter B k-factors, the target dispense volume, the actual dispense volume (settable from 0 to 9999 cc), and the material to dispense.

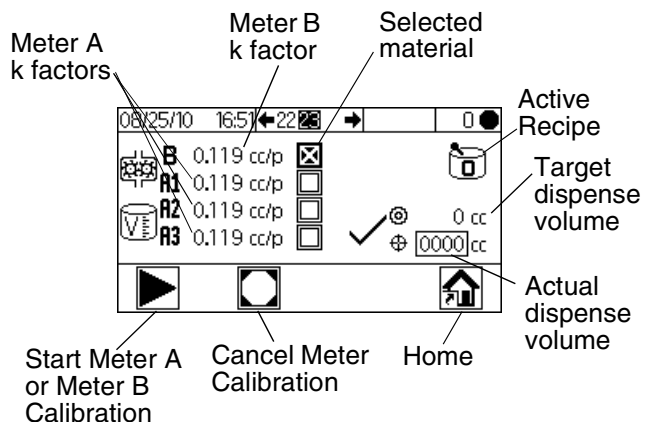



















FIG. 47. Calibration 2 (Screen 23)

- Press   to highlight the meter you wish to calibrate. Press . An X displays in the box.
- Press  to start the calibration on the checked meter (A with fluid A1, A2, or A3, or B). Press  to cancel the calibration.
- Press   to highlight the actual dispense volume field. Press  to set the volume (from 0 to 9999 cc). Press   to move between digits. Press   to change a digit. Press  when field is correct.
- Use   to toggle between Calibration 1 (Screen 22) and Calibration 2 (Screen 23).

Troubleshooting (Screens 35-37)

Screens for testing system controls can be accessed by setting the password to 9909. See Configure 3 (Screen 20), page 46, to set or change the password.

After setting the password to 9909, press  to exit Setup. Press  to reenter Setup. Setup Home (Screen 17) displays, with troubleshooting screen options.

Troubleshooting screen options appear here.

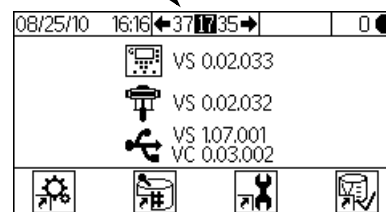

FIG. 48. Setup Home with Troubleshooting

Troubleshooting System Inputs (Screen 35)

From Setup Home (Screen 17) with Troubleshooting active, press to display Troubleshooting System Inputs (Screen 35). An X displays in the box to indicate if Air Flow Switch 1 or 2 is on and if the gun is in the Gun Flush Box. This screen also displays Meter A and Meter B pulses. The fields relating to pump function can be ignored.

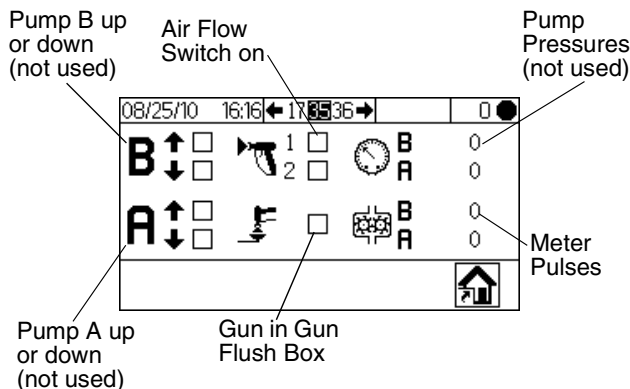

FIG. 49. Troubleshooting System Inputs (Screen 35)

- Press , then again to move to Troubleshooting System Outputs (Screen 37). Press to move to the Membrane Test (Screen 36).

Membrane Test (Screen 36)

From Setup Home (Screen 17) with Troubleshooting active, press , then again. Membrane Test (Screen 36) displays. You could also press , then again. This screen allows an authorized user to test the buttons on the Display Module membrane. When in this screen, all buttons lose their predefined functions, and the soft keys are not defined. When a properly working button is pressed, an X appears in the box.

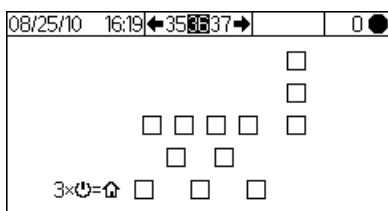

FIG. 50. Membrane Test (Screen 36)

Press three times to return to Setup Home (Screen 17). Direct access to any other screen is not possible.

Troubleshooting System Outputs (Screen 37)

From Setup Home (Screen 17) with Troubleshooting active, press to display Troubleshooting System Outputs (Screen 37). An X displays in the box to show an electrical state of On for the dose valves (B, and A1, A2, and A3), solvent valves (B and A), the gun trigger, and the alarm. Press to start Forced Mode. A second set of check boxes displays. Manually actuate the valves, alarm, or gun trigger. For properly working components, an X will display in the corresponding second box upon actuation. Press to exit Forced Mode. Moving to any other screen also will exit Forced Mode.

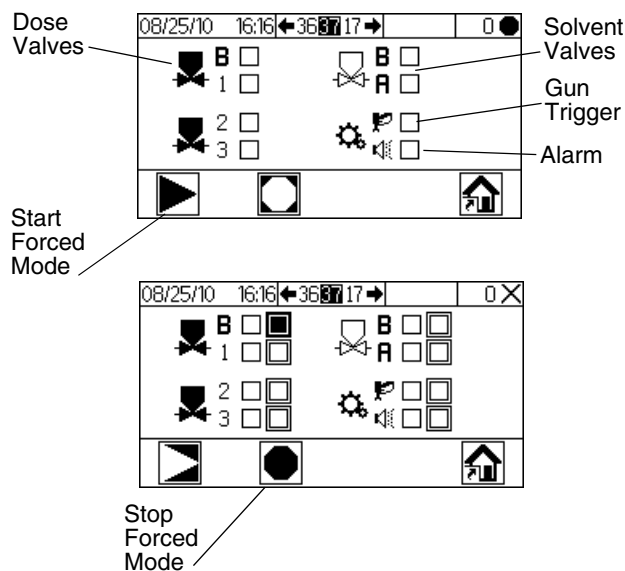



FIG. 51. Troubleshooting System Outputs (Screen 37)

Dosing Options

Sequential Dosing

Components A and B dispense sequentially in the necessary volumes to attain the mix ratio.

1. The operator presses  to begin operation.
2. The ProMix 2KE controller sends signals to activate the solenoid valves. The solenoid valves activate Dose Valves A1 (A2 or A3, depending on recipe selection) and B. Fluid flow begins when the gun is triggered.
3. Components A1 and B are introduced into the fluid integrator (FI) one at a time as follows.
 - a. The A side dose valve (DVA1, DAV2, or DVA3) opens, and fluid flows into the integrator.
 - b. Flow Meter A (MA) monitors the fluid volume dispensed and sends electrical pulses to the ProMix 2KE controller. The controller monitors these pulses and signals.
 - c. When the target volume dispenses, Dose Valve A closes.

NOTE: The dispense volume of component A and B is based on the mix ratio and dose size set by the user and calculated by the ProMix 2KE controller.

- d. Dose Valve B (DVB) opens, and fluid flows into the integrator and is aligned proportionately with component A.
 - e. Flow Meter B (MB) monitors the fluid volume dispensed and sends electrical pulses to the ProMix 2KE controller.
 - f. When the target volume is dispensed, Dose Valve B closes.
4. The components are pre-mixed in the integrator, then uniformly blended in the static mixer (SM).

NOTE: To control output from the static mixer to the gun, install an optional fluid pressure regulator.
 5. Components A and B are alternately fed into the integrator as long as the gun is triggered.
 6. If the gun is not triggered for two minutes, the system switches to Idle mode, which closes off the mix manifold dose valves.
 7. When the gun is triggered again, the ProMix 2KE continues the process where it left off.

NOTE: Operation can be stopped at any time by pressing  or shutting off the main power switch.

Table 3: Sequential Dosing Operation

Ratio = 2.0:1	Dose 1		Dose 2		Dose 3	
A = 2						
B = 1						

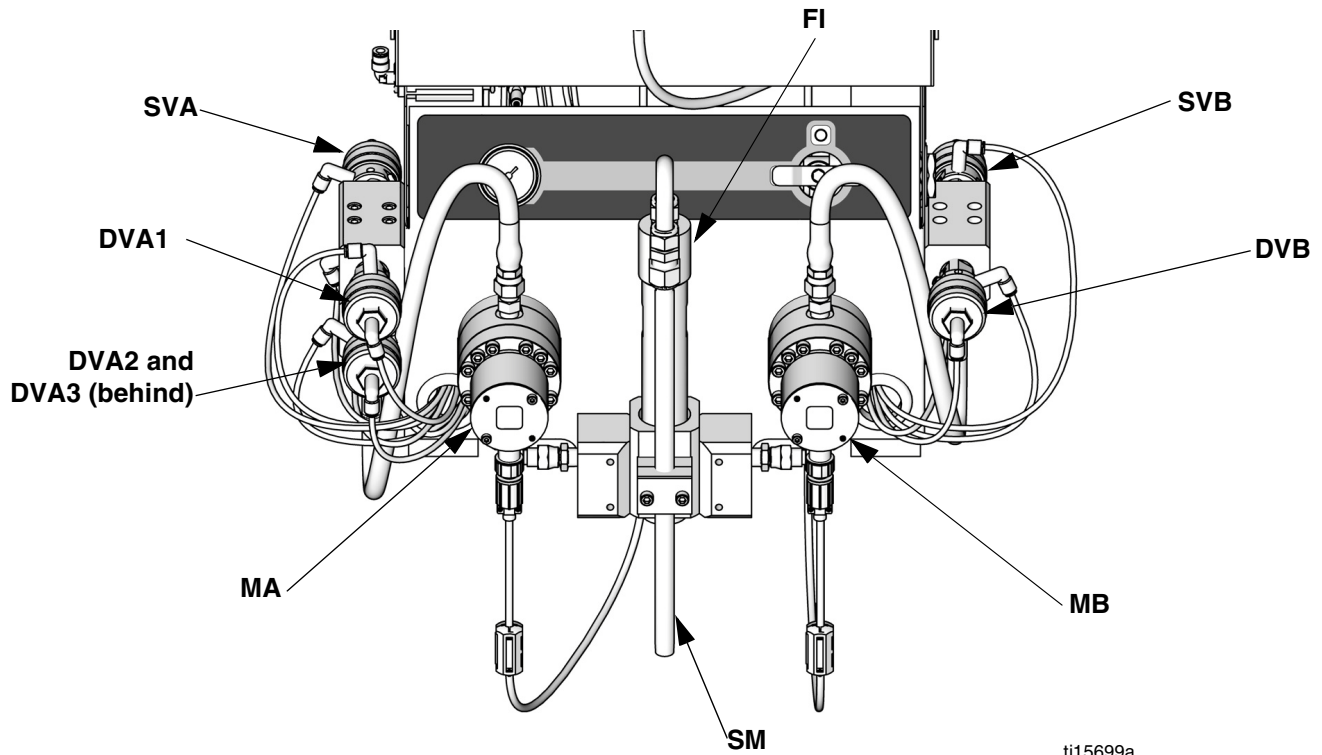

Key:

MA Component A Meter

DVA1 Component A Dose Valve

DVA2 Second Color/Catalyst Valve

DVA3 Third Color/Catalyst Valve

SVA Solvent Valve A

MB Component B Meter

DVB Component B Dose Valve

SVB Solvent Valve B

SM Static Mixer

FI Fluid Integrator

FIG. 52. Fluid Module, Sequential Dosing

Dynamic Dosing

Overview

Dynamic Dosing provides on-demand proportioning, eliminating the need for an integrator and therefore minimizing undesired material contact. This feature is especially useful with shear-sensitive and waterborne materials.

A restrictor injects component B into a continuous stream of component A. The software controls the duration and frequency of each injection. See FIG. 55 for a schematic diagram of the process.

Dynamic Dosing System Parameters

The following parameters affect dynamic dosing performance:



- **Component A Flow:** Ensure that the supply pump is sized to provide sufficient and uninterrupted flow. Note that component A provides majority of system flow at higher mix ratios.
- **Component B Flow:** Ensure that the supply pump is sized to provide sufficient and uninterrupted flow.
- **Component A Pressure:** Ensure precise pressure regulation. It is recommended that the component A pressure be 5-15% **lower** than the component B pressure.
- **Component B Pressure:** Ensure precise pressure regulation. It is recommended that the component B pressure be 5-15% **higher** than the component A pressure.

NOTE: When using dynamic dosing it is very important to maintain a constant, well-regulated fluid supply. To obtain proper pressure control and minimize pump pulsation, install a fluid regulator on the A and B supply lines upstream of the meters. In systems with color change, install the regulator downstream of the color/catalyst valve stack.

Select a Component B Restrictor Size

See **Set Up the Fluid Manifold for Dynamic Dosing**, page 16. Use the charts on pages 66 to 70 to select an appropriate restrictor size based on the desired flow and mix ratio.

Select Dynamic Dosing

1. On the Display Module press  to access Setup Home (Screen 17). Select  to display Configure 1 (Screen 18).
2. Select **A || B** from the dosing type drop down menu.

Balancing A/B Pressure

If component B pressure is too high, it will push the component A stream aside during B injection. The valve will not open long enough, causing a Ratio High error.

If component B pressure is too low, it will not be injected in sufficient volume. The valve will stay open too long, causing a Ratio Low error.

Selecting the correct component B restrictor size and balancing the A/B pressures will keep the system in the proper pressure range, resulting in a consistent mix ratio.

FIG. 53 shows the A to B pressure balance, read at the proportioner inlet. It is recommended that the component B pressure be 5-15% higher than the component A pressure to keep the system in the control range, hold the proper mix ratio, and obtain properly mixed material. If pressures are not balanced (“B Pressure Too High” or “B Pressure Too Low”), it may not be possible to hold the desired mix ratio. The system will generate an off ratio alarm and stop operation.

NOTE: In multi-flow rate systems, it is recommended that you set up the system to run properly at the highest flow rate, to ensure adequate fluid supply across the flow rate range.

In dynamic dosing, component A dose valve is constantly on. Component B dose valve will cycle on and off; one cycle every 0.5 – 1.0 seconds indicates proper balance.

Monitor system performance by watching the Display Module for warning messages which provide information on system performance, and adjust pressures accordingly. See Table 5 on page 57.

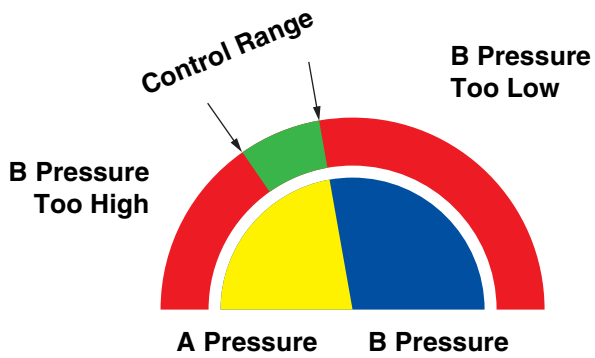
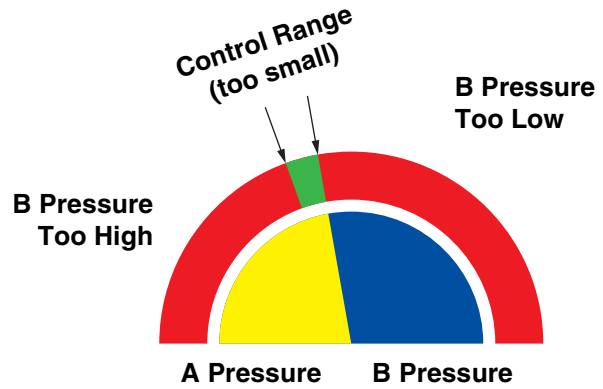

FIG. 53. A/B Control Range with Properly Sized Restrictor



NOTE: If the restrictor is too small, it may be necessary to supply more differential pressure than is available in your system.

FIG. 54. A/B Control Range with Too Large a Restrictor

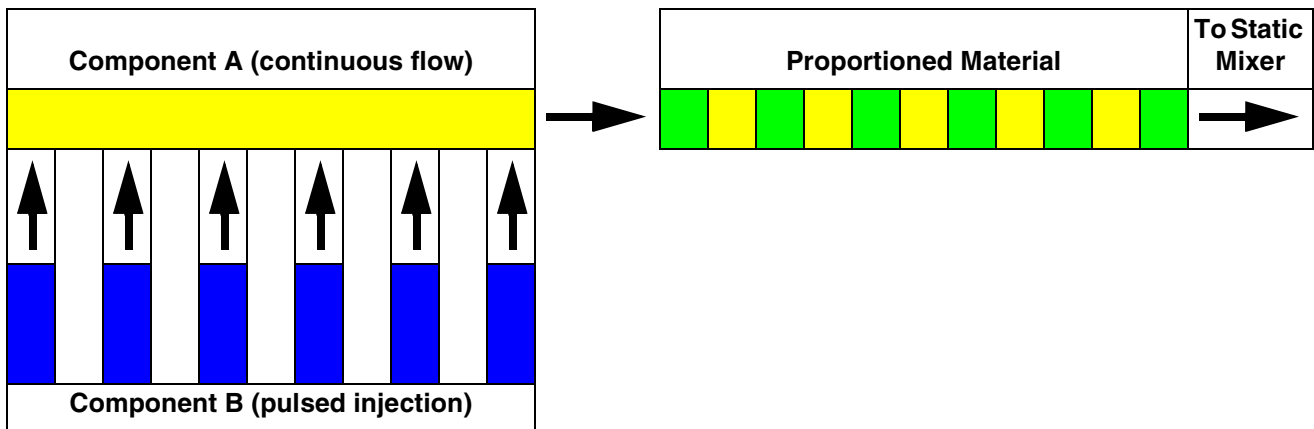

FIG. 55. Schematic Diagram of Dynamic Dosing Operation

Table 4: Dynamic Dosing Troubleshooting Guide

(for complete system troubleshooting, see **Alarm Troubleshooting** beginning on page 58)

Error Message	Solution
Ratio Low Error (R1)	<ul style="list-style-type: none"> • Increase A pressure or decrease B pressure. • Use a smaller restrictor.
Ratio High Error (R4)	<ul style="list-style-type: none"> • Increase B pressure. • Clean restrictor or use a larger size. • Verify B valve is opening properly.

System Errors

NOTE: Do not use the fluid in the line that was dispensed off ratio as it may not cure properly.

System Alarms

System alarms alert you of a problem to help prevent off-ratio spraying. If an alarm occurs, operation stops and the following occurs:

- Alarm buzzer sounds.
- Status bar on the Display Module shows the alarm icon  and code.
- Alarm is saved in the date/time stamped log.

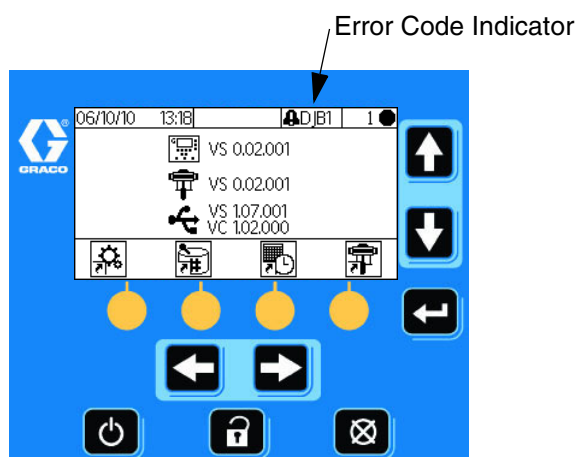

FIG. 56. Display Module Alarm Codes

System Advisory/Record Codes

Table 6 lists the advisory and record codes. Advisories and records do not stop operation or sound an alarm. If an advisory occurs, the Status bar on the Display Module shows the advisory icon and code. System records do not display on the Status bar. Both advisories and records are saved in the date/time stamped log, which can be viewed on the display or saved to a flash drive using optional USB port.

#	Date	Time	Code	Icon
1	8/25/10	16:02	EC	Record - no icon
2	8/25/10	16:02	P6B1	Alarm icon
3	8/25/10	14:00	DJA1	Advisory icon
4	8/25/10	13:56	ES	Advisory icon
5	8/25/10	13:55	P6B1	Alarm icon

FIG. 57. Error Log Icons

To Clear Error and Restart

NOTE: When an error occurs be sure to determine the error code before resetting it. If you forget which code occurred, use **Run Log Errors (Screens 5-14)**, page 44, to view the last 50 errors, with date and time stamps.

To reset errors, see Table 7 and **Alarm Troubleshooting**, page 58. Many errors can be cleared by simply

pressing .

Air Flow Switch (AFS) Function

Air or Air-assisted Guns

The air flow switch (AFS) detects air flow to the gun and signals the ProMix 2KE controller when the gun is triggered. The AFS functions with the flow meters to ensure that system components are functioning correctly.

For example, if a flow meter fails or clogs, pure resin or catalyst could spray indefinitely if the ProMix 2KE does not detect the condition and intervene, which is why the AFS is so important.

If the ProMix 2KE detects through the AFS signal that the gun is triggered, yet there is no fluid flow through the meter, a Dose Time Alarm (QTA1 or QTB1) occurs after 40 seconds and the system shuts down.

Operating Without Air Flow Switch

It is **not recommended** to run without an air flow switch. If a switch fails, replace it as soon as possible.

Airless Gun

It is **not recommended** to use an airless gun with the ProMix 2KE. Two issues can arise from operating without an air flow switch:

- Without a gun trigger/air flow switch input the ProMix 2KE does not know it is spraying and will not generate a Dose Time Alarm. This means there is no way to detect a failed meter. You could spray pure resin or catalyst for 2 minutes without knowing.

- Since the ProMix 2KE does not know it is spraying because there is no gun trigger/air flow switch input, it will go into System Idle every 2 minutes when in Mix mode.

System Idle Notice (IDLE)

This warning occurs if the ProMix 2KE is set to Mix



and 2 minutes have elapsed since the system last received the air flow switch signal (gun trigger). The Gun

Idle icon  is displayed.

In applications using the AFS, triggering the gun clears the warning and you can start spraying again.

Without the AFS, triggering the gun does not clear the alarm. To start spraying again, you must press ,

then , then trigger the gun.

Error Codes

Table 5: System Alarm/Advisory/Record Codes

Code	Description	Details
Alarm Codes - Alarm sounds, system stops, icon displays until problem is solved and alarm is cleared.		
CA	Communication Error	43
CAU1	USB Communication Error	43
EQU2	USB Installed when not in Standby	43
SG	Gun Flush Box Error	43
SAD1	Atomizing Air During Purge - Gun 1	43
SAD2	Atomizing Air During Purge - Gun 2	43
SPSA	Purge Volume Error A	
SPSB	Purge Volume Error B	
SFA1	PreMix Error - Color	43
SFA2		
SFA3		
SFB1	PreMix Error - Catalyst	
SHA1	PreFill Error - Color	43
SHA2		
SHA3		
SHB1	PreFill Error - Catalyst	
SM	MixFill Start Error	44
SN	MixFill Complete Error	44
QPD1	Potlife Error - Gun 1	44
QPD2	Potlife Error - Gun 2	44
R1	Ratio Low Error	44
R4	Ratio High Error	45
QDA1	Overdose A, B Dose too Short	46
QDA2		
QDA3		
QDB1	Overdose B, A Dose too Short	
QTA1	Dose Time A Error	47
QTA2		
QTA3		
QTB1	Dose Time B Error	
QLAX	Leak Error A	47
QLBX	Leak Error B	
P6A1	Pressure Transducer Error A	48
P6B1	Pressure Transducer Error B	
Advisory Codes - No alarm, system continues operating, icon displays on active screen until cleared		
MFA1	Meter A maintenance due	N/A
MFB1	Meter B maintenance due	N/A
MEA1	Mix valve A1 maintenance due	N/A
MEA2	Mix valve A2 maintenance due	N/A
MEA3	Mix valve A3 maintenance due	N/A

Table 5: System Alarm/Advisory/Record Codes

Code	Description	Details
MEB1	Mix valve B maintenance due	N/A
MESA	Solvent valve A maintenance due	N/A
MESB	Solvent valve B maintenance due	N/A
MGA1	Fluid Filter A maintenance due	N/A
MGB1	Fluid Filter B maintenance due	N/A
MGP1	Air Filter maintenance due	N/A
ES	System defaults loaded	N/A
Record Codes - No alarm, system continues operating, no icon displays on active screen.		
EL	System powered on	N/A
EC	System setup changed	N/A
ES	System defaults loaded	N/A
ET	System performed an autodump after a potlife	N/A
EQU1	USB Drive connected while in Standby	N/A

Alarm Troubleshooting

Alarm and Description	Cause	Solution
CA Communication Error The Display Module is not communicating with the Advanced Fluid Control Module.	The CAN cable between the Display Module and the Advanced Fluid Control Module is not connected.	Verify that the cable is correctly connected.
	The CAN cable is cut or bent.	Verify that the cable has not been cut or bent at a radius smaller than 1.6 in. (40 mm).
	The cable or connector failed.	Replace cable.
	Alternator Powered Systems: Check that the Advance Fluid Control Module (AFCM), Display Module (DM), and USB Module have power (green LED) and are communicating (amber LED blinking)	<ol style="list-style-type: none"> For any module that does not have power, disconnect and check the voltage on the cable produced by the alternator module (See Alternator Module Power Output). If the proper voltage is not detected, troubleshoot the Alternator Module. If the proper voltage is detected, verify the cable connecting the two modules is good. If the cable is good, replace the module.
	There may be a short in one of the solenoid/meter cables connected to the AFCM.	Replace the cable (16E890)
	The AFCM power supply may be bad, as indicated by the status LEDs (red, yellow, green) being off. Verify the power supply works by disconnecting from the AFCM and connecting to another module, either the Display Module or USB Module.	Replace the module.
	The DM and the AFCM have different versions of software installed.	Install the latest software from token kit 16D922 on all modules.
	The red LED on the AFCM is on.	If on solid, replace module. If blinking, contact your distributor.
	NOTE: <ol style="list-style-type: none"> If the AFCM loses communication (no flickering amber LED) but then comes back on the alarm will auto clear and will not log the alarm. If the DM loses communication (no flickering amber LED) but then comes back on you will have to manually clear the alarm and there will be an alarm log. If the USB module loses communication (no flickering amber LED) but then comes back on you will not get an alarm. 	
	CAU1 USB Communication Error The system detected a USB Module at last power up, but does not detect it currently.	The module has been removed.
The cable is disconnected or broken.		Put system in standby and reconnect or replace the USB cable.

Alarm and Description	Cause	Solution
EQU2 USB Drive Error The USB drive has been inserted when the system is not in Standby.	Most USB drives do not conform to IS standards, so it is hazardous to use one while the system is running.	Put system in Standby. Insert the USB drive only in a non-hazardous environment.
SG Gun Flush Box Error A gun flush box is enabled, but the system does not detect a gun in the gun flush box during purge, color change, or auto-dump.	The cover of the gun flush box is not closed. For systems with a gun flush box, the gun is not in the box when purge is active. <div style="border: 1px solid black; background-color: #0056b3; color: white; padding: 2px; text-align: center; margin: 5px 0;">NOTICE</div> To prevent mixed material from curing in the equipment, do not shut off power. Follow one of the solutions at right.	Close the cover and clear the alarm. Purge the system with solvent or fresh mixed material: <ul style="list-style-type: none"> • Solvent Purge - See Purging on page 34. The system purges until the preset purge time is complete. • New Mixed Material Purge - Go to Mix mode and spray the required volume to restart the potlife timer.
SPSA or SPSB Purge Volume Error Insufficient volume during first 10 seconds of A or B purge sequence.	Solvent line, valve, or meter is plugged or stuck.	Check components and clean, repair, or replace as necessary.
	Solvent pump is not working.	Check and repair pump. See pump manual for repair procedures and replacement parts.
SAD1 or SAD2 Atomizing Air During Purge Atomizing air to Gun 1 (SAD1) or Gun 2 (SAD2) is detected when purge is selected or during purge sequence.	Atomizing air is stuck on.	Replace air flow switch.
	Gun is not in Gun Flush Box.	Insert the gun into the Gun Flush Box.
	Gun Flush Box air shutoff is not working.	Test using Troubleshooting Screens. See page 49. Repair/replace air shutoff valve as needed.
	Air leak in atomizing air line.	Inspect air line for kinks, damage, or loose connections. Repair or replace as needed.
SFA1, SFA2, SFA3 or SFB1 PreMix Error In systems with a gun flush box, insufficient quantity of resin/color (SFA1, SFA2, or SFA3) or catalyst (SFB1) is detected during the 10-second PreMix sequence.	Gun, line, valve, or meter is plugged or stuck.	Check components and clean, repair, or replace as necessary.
	Feeder pump or solvent pump is not turned on or is not working.	Check and repair pump. See pump manual for repair procedures and replacement parts.
	Air lines or solenoids are plumbed incorrectly or solenoids are not working.	Check air line path. See System Pneumatic Schematic , page 72 or 73. Verify that solenoid is working.
SHA1, SHA2, SHA3 or SHB1 PreFill Error Total PreFill sequence volume is not reached for color (SHA1, SHA2, or SHA3) or catalyst (SHB1) during the 5-minute PreFill sequence.	Flow rate is too low.	Increase fluid pressure.

Alarm and Description	Cause	Solution
<p>SM MixFill Start Error In systems with a gun flush box, insufficient volume of mixed material is detected during the 10-second mixed fill sequence.</p> <p>SN MixFill Complete Error Insufficient volume of mixed material is detected during the 5-minute mixed fill sequence.</p>	Gun Flush Box is not triggering gun.	Verify trigger is being pulled. Adjust as needed.
	Line or gun is plugged or restricted.	Clean line, tip, or filter.
	Flow rate is too low.	Increase fluid pressure or decrease restriction.
	Valve is stuck.	Clean valve or verify that solenoid is triggering valve properly.
<p>QPD1 or QPD2 Potlife Error Potlife has been exceeded for the mixed material for Gun 1 (QPD1) or Gun 2 (QPD2).</p>	Have not sprayed enough volume to keep fresh mixed fluid in the mix manifold, hose, and gun.	<p>Purge the mixed material line. See page 34.</p> <p>Check that hose length and diameter have been entered correctly. See Configure 2 (Screen 19), page 46.</p> <p>Spray the required volume to restart the potlife timer.</p>

Alarm and Description	Cause	Solution
R1 Ratio Low Error The mix ratio is lower than the set tolerance for an A to B component volume comparison.	There is too much restriction in the system.	<ul style="list-style-type: none"> • Check that the system is fully loaded with material. • Check that the supply pump's cycle rate is set properly. • Check that the spray tip/nozzle is properly sized for the flow and application, and that it is not clogged. • Check that the fluid regulator is set properly.
	If the alarm occurs during start up, after purging, the flow rate was probably too high.	Restrict gun needle travel to slow down the initial fluid delivery rate until fluid hoses are loaded with material.
	If the alarm occurred after you were spraying for some time, the pressures from the fluid supplies could be unbalanced.	Adjust component A and B fluid supply regulator pressures until they are about equal. <i>If the pressures are already about equal, verify that component A and B dose valves are operating properly.</i>
	Slow actuation of the component A or B valves. This can be caused by:	Manually operate the Dose Valve A1 (A2, A3) and B solenoid valves by pressing and releasing solenoid valve override buttons. Valves should snap open and shut quickly.
	<ul style="list-style-type: none"> • Air pressure to the valve actuators is too low. 	<ul style="list-style-type: none"> • Increase air pressure. Air pressure must be 75-120 psi (0.52-0.84 MPa, 5.2-8.4 bar); 120 psi is recommended.
	<ul style="list-style-type: none"> • Something is restricting the solenoid or tubing and interrupting valve actuation air. 	<ul style="list-style-type: none"> • There may be dirt or moisture in the air supply. Filter appropriately.
	<ul style="list-style-type: none"> • Dose Valve A1 (A2, A3) is turned in too far. • Dose Valve B is open too far. 	<ul style="list-style-type: none"> • Refer to Valve Settings, page 38, for adjustment guidelines.
	<ul style="list-style-type: none"> • Fluid pressure is high and air pressure is low. 	<ul style="list-style-type: none"> • Adjust air and fluid pressure. See recommended air pressure above.
	<ul style="list-style-type: none"> • Fluid Seal in valve has failed. 	<ul style="list-style-type: none"> • See corresponding valve manual for repair instructions.

Alarm and Description	Cause	Solution
<p>R4 Ratio High Error The mix ratio is higher than the set tolerance for an A to B component volume comparison.</p>	There is too little restriction in the system.	<ul style="list-style-type: none"> • Check that the system is fully loaded with material. • Check that the supply pump's cycle rate is set properly. • Check that the spray tip/nozzle is properly sized for the flow and application, and that it is not worn. • Check that the fluid regulator is set properly.
	If the alarm occurs during start up, after purging, the flow rate was probably too high.	Restrict gun needle travel to slow down the initial fluid delivery rate until fluid hoses are loaded with material.
	If the alarm occurred after you were spraying for some time, the pressures from the fluid supplies could be unbalanced.	Adjust component A and B fluid supply regulator pressures until they are about equal. <i>If the pressures are already about equal</i> , verify that component A and B dose valves are operating properly.
	Slow actuation of the component A or B valves. This can be caused by:	Manually operate the Dose Valve A1 (A2, A3) and B solenoid valves to check operation.
	<ul style="list-style-type: none"> • Air pressure to the valve actuators is too low. 	<ul style="list-style-type: none"> • Increase air pressure. Air pressure must be 75-120 psi (0.52-0.84 MPa, 5.2-8.4 bar); 120 psi is recommended.
	<ul style="list-style-type: none"> • Something is restricting the solenoid or tubing and interrupting valve actuation air. 	<ul style="list-style-type: none"> • There may be dirt or moisture in the air supply. Filter appropriately.
	<ul style="list-style-type: none"> • Dose Valve B is turned in too far. Dose Valve A1 (A2, A3) is open too far. 	<ul style="list-style-type: none"> • Refer to Valve Settings, page 38, for adjustment guidelines.
<ul style="list-style-type: none"> • Fluid pressure is high and air pressure is low. 	<ul style="list-style-type: none"> • Adjust air and fluid pressure. See recommended air pressure above. 	

Alarm and Description	Cause	Solution
<p>QDA1, QDA2, QDA3 Overdose A The A dose has overshoot and, when combined with B, is too large for the mix manifold capacity.</p> <p>QDB1 Overdose B The B dose has overshoot, forcing an A dose that, when combined with B, is too large for the mix manifold capacity.</p>	Valve seal or needle/seat are leaking.	Repair the valve.
	Flow meter fluctuations caused by pressure pulsations.	Check for pressure pulsations: <ol style="list-style-type: none"> 1. Close all the manifold valves. 2. Turn on the circulating pumps and all the booth equipment (such as fans and conveyors). 3. Check if the ProMix 2KE is reading any fluid flow. 4. If the ProMix 2KE shows there is fluid flow and there are no leaks from the gun or any other seals or fittings, the flow meters are probably being affected by pressure pulsations. 5. Close the fluid shutoff valve between the fluid supply system and the flow meter. The flow indication should stop. 6. If necessary, install pressure regulators or a surge tank on the fluid inlets to the ProMix 2KE to reduce the fluid supply pressure. Contact your Graco distributor for information.
	Slow actuation of component A or B valves.	See Ratio Low Error and Ratio High Error , pages 61-62.
	Running a high mix ratio and a high flow rate.	It may be necessary to restrict the flow rate through the component B dose valve by adjusting its hex nut.

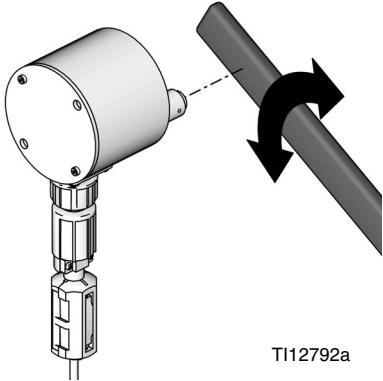
Alarm and Description	Cause	Solution
<p>QTA1, QTA2, QTA3, or QTB1 Dose Time Error The gun trigger is active, but no A pulses (QTA1, QTA2, QTA3) or no B pulses (QTB1) are detected during the dose time selected.</p>	System is in Mix mode and gun is only partially triggered, allowing air but no fluid to pass through gun.	Fully trigger the gun.
	Fluid flow rate is too low.	Increase flow rate.
	Flow meter or cable failed or flow meter clogged.	<p>To check meter sensor operation, remove meter cap to expose sensor. Pass a ferrous metal tool in front of the sensor.</p>  <p style="text-align: right;">T112792a</p> <p>If there is a meter or cable failure, you will see a large difference between the amount of fluid dispensed and the flow meter volume displayed by the Display Module. Clean or repair meter as necessary.</p>
	Slow actuation of component A or B valves.	See Ratio Low Error and Ratio High Error , pages 61-62.
	The supply pump is not turned on.	Turn on the supply pump.
	There is an air leak downstream from the air flow switch.	Check the air lines for leaks and repair.
The air flow switch is stuck open.	Clean or replace air flow switch.	
<p>QLAX or QLBX Leak Error Meter A (QLAX) or Meter B (QLBX) measures fluid with all valves closed.</p>	Pressure on circulation system is fluctuating and generating meter pulses.	Replace check valve in front of meter.
	Valve is leaking.	Replace valve seat, valve, or valve seal.
	Gun, manifold, or line is leaking.	Repair leak downstream of meters.

Dynamic Dosing Restrictor Selection Graphs

Use the graphs on pages 66- 70 as a guide to determine the correct restrictor size for your desired flow and material viscosity. Table 6 lists the available restrictor sizes.

Example:

Application: air spray system with a 5:1 mix ratio

Fluid Supply: 1:1 pumps at 100 psi (7 bar, 0.7 MPa)

Flow Rate: 300 cc/min at the gun

Select the Restrictor Size: choose either the 0.040 or 0.070 orifice, to ensure that the pressure differential is not more than 10-20 psi (0.7-1.4 bar, 0.07-0.14 MPa), provided the fluid viscosities are similar to those tested.

- If the viscosity of component B is lower than the viscosity of the chart used for selection you may need to use a smaller restrictor or decrease the pressure differential.
- If the viscosity of component B is higher than the viscosity of the chart used for selection you may need to use a larger restrictor or increase the pressure differential.
- In systems using an air-assisted gun, if the fluid pressure of component A is higher than the component A pressure from the charts you may need to use a larger restrictor or increase the pressure differential.

Table 6: Restrictor Sizes

Size Code	Orifice Size	Part No.
2*	0.020	15U936
3*	0.030	15U937
4*	0.040	15U938
5✓	0.050	15U939
6✓	0.060	15U940
7*	0.070	15U941
8✓	0.080	16D554

* These restrictors are included in Injection Kit 15U955.

✓ These restrictors are optional sizes, not included in the Injection Kit.

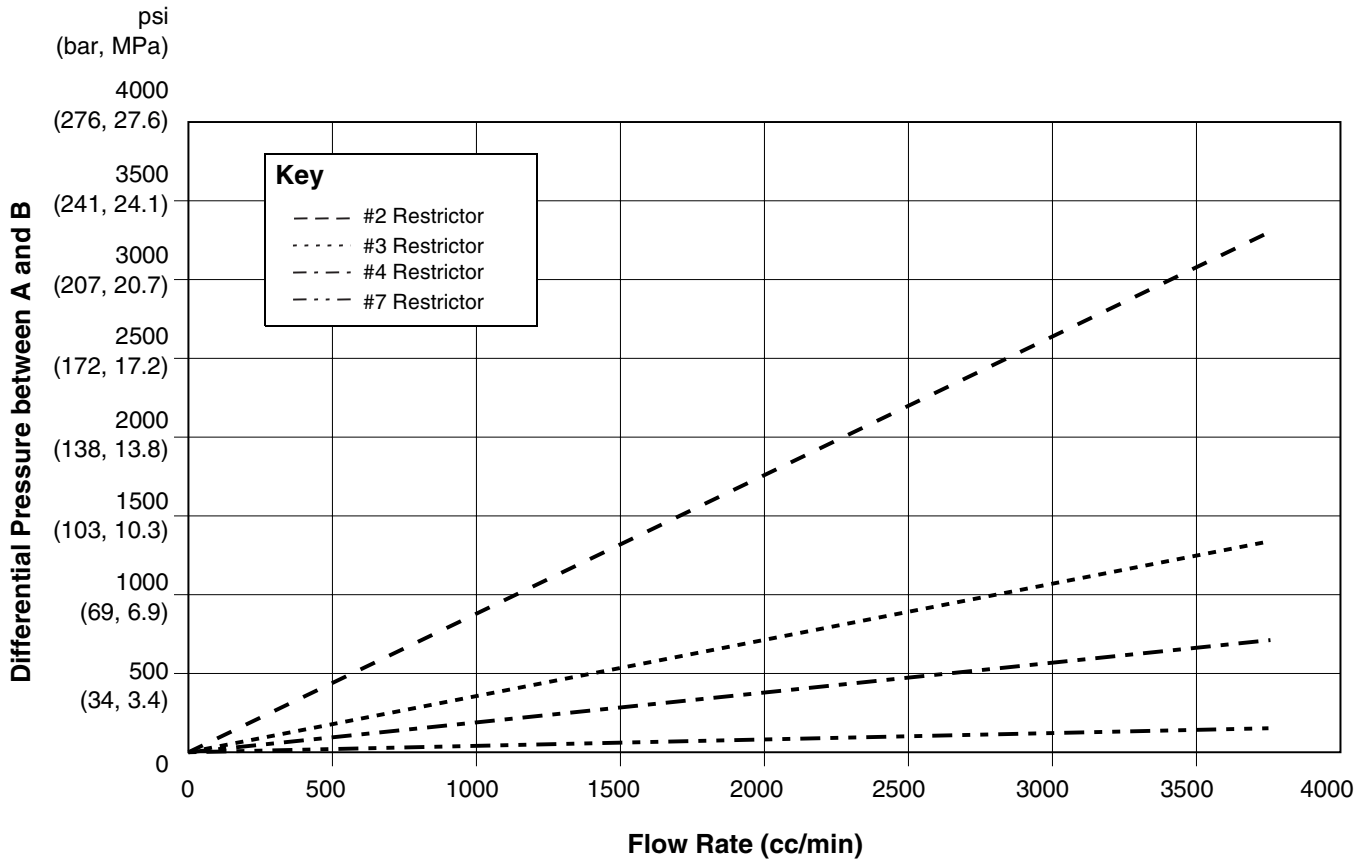

Detail View

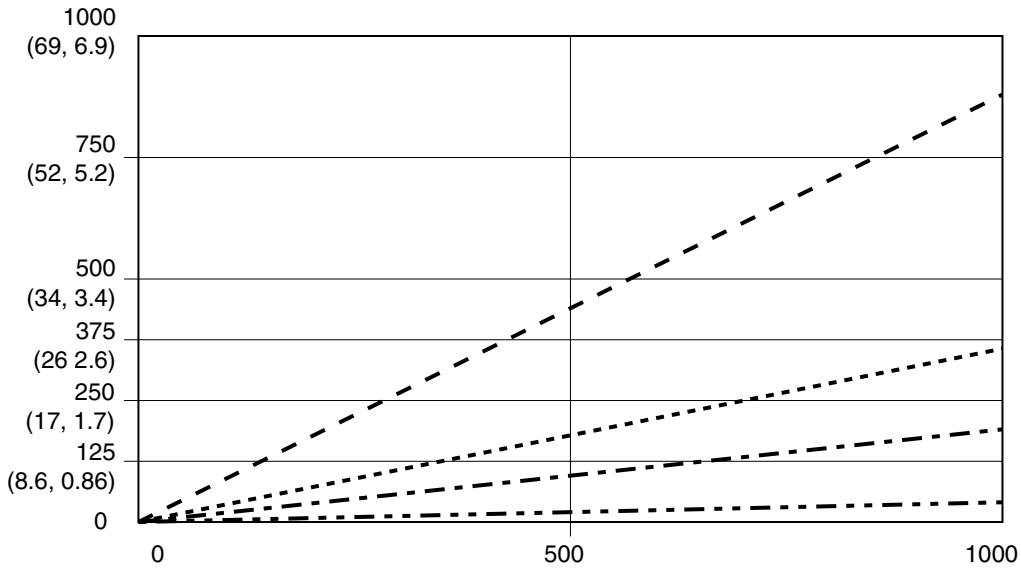
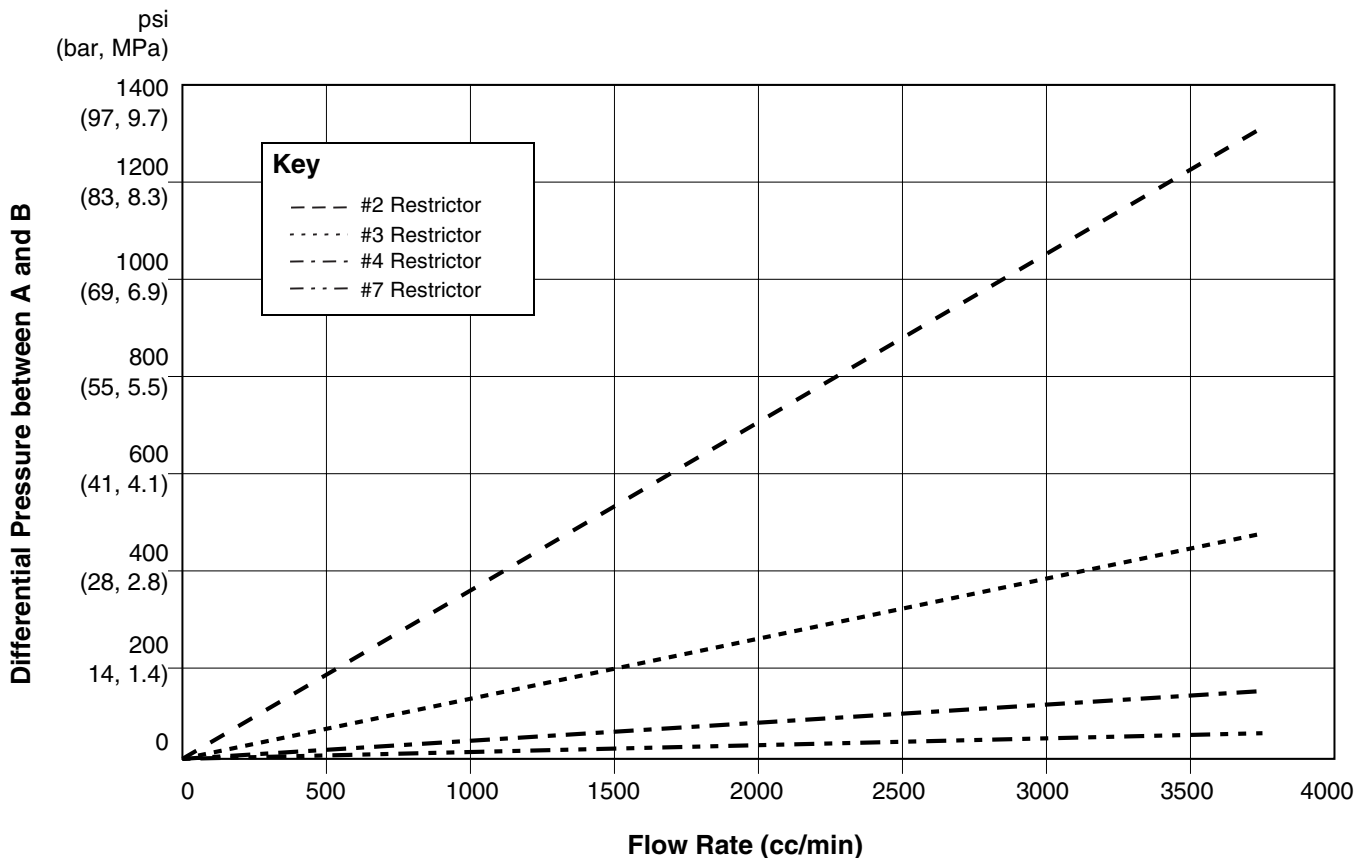

FIG. 58. Dynamic Dosing Performance (1:1 Ratio, 90 centipoise fluid, 100 psi A side pressure)



Detail View

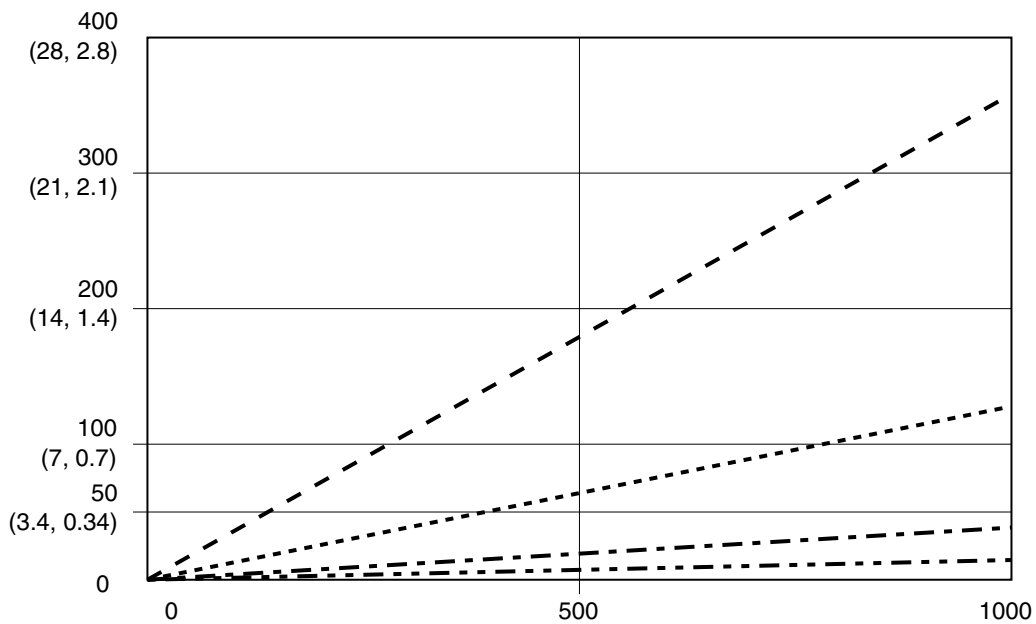
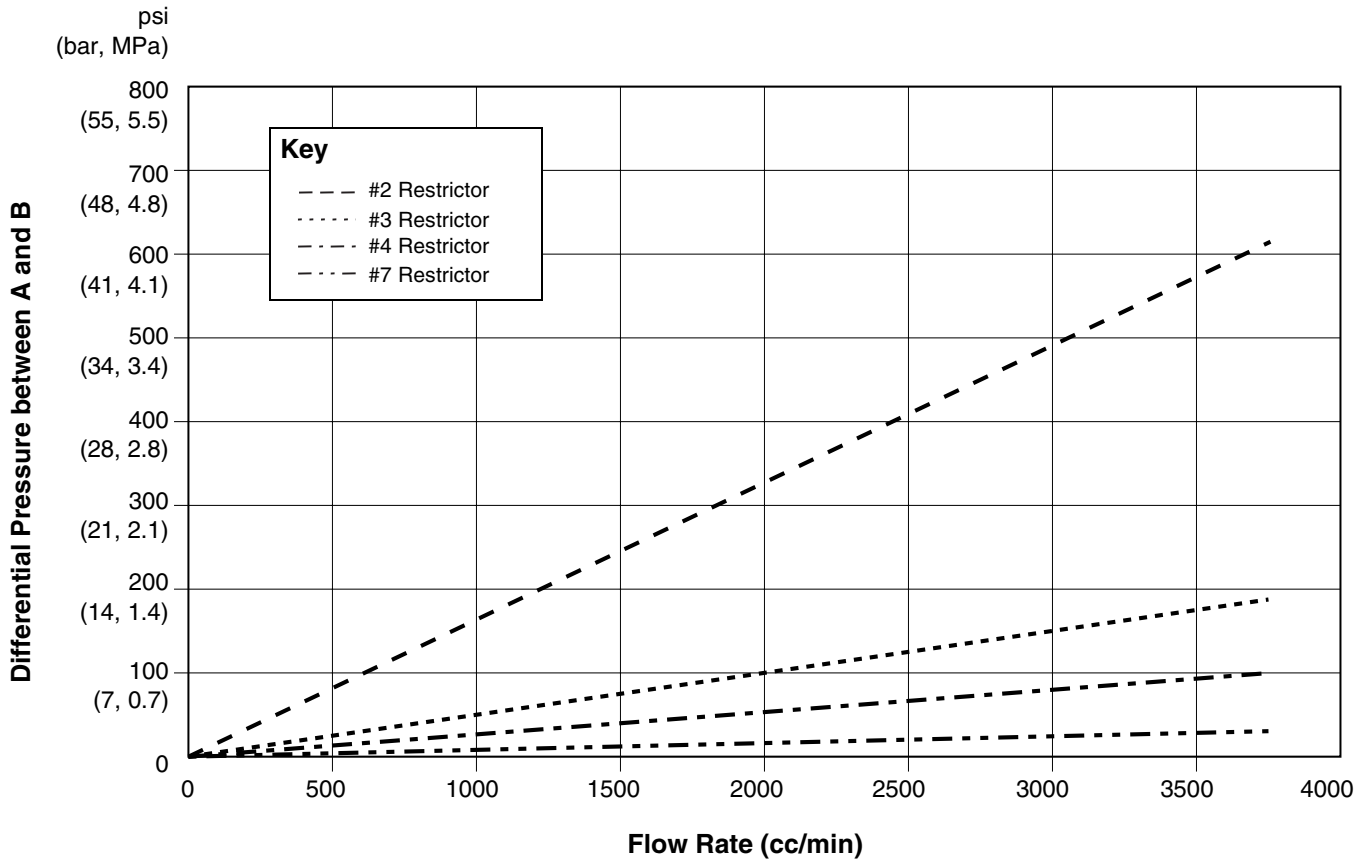

FIG. 59. Dynamic Dosing Performance (5:1 Ratio, 90 centipoise fluid, 100 psi A side pressure)



Detail View

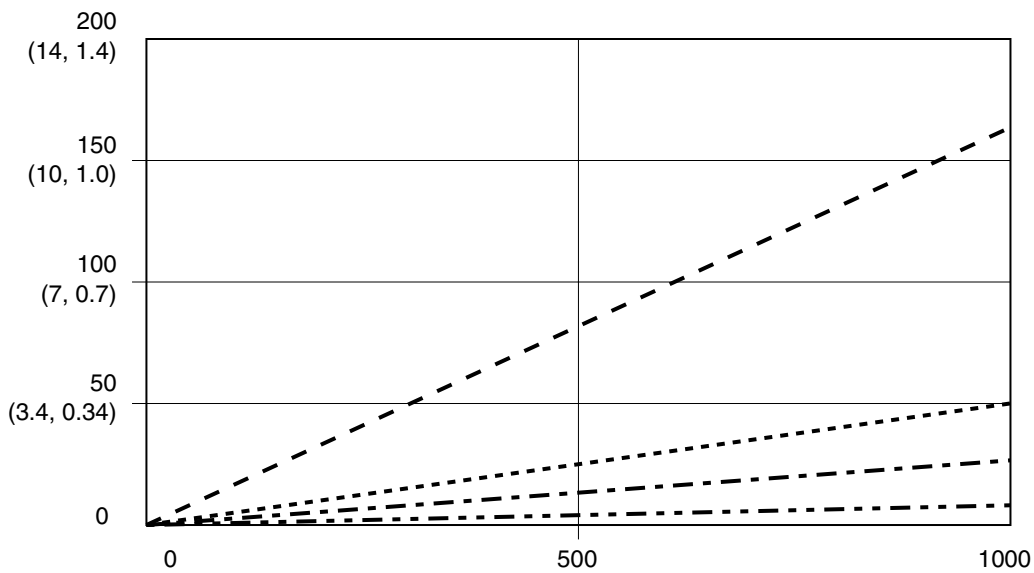
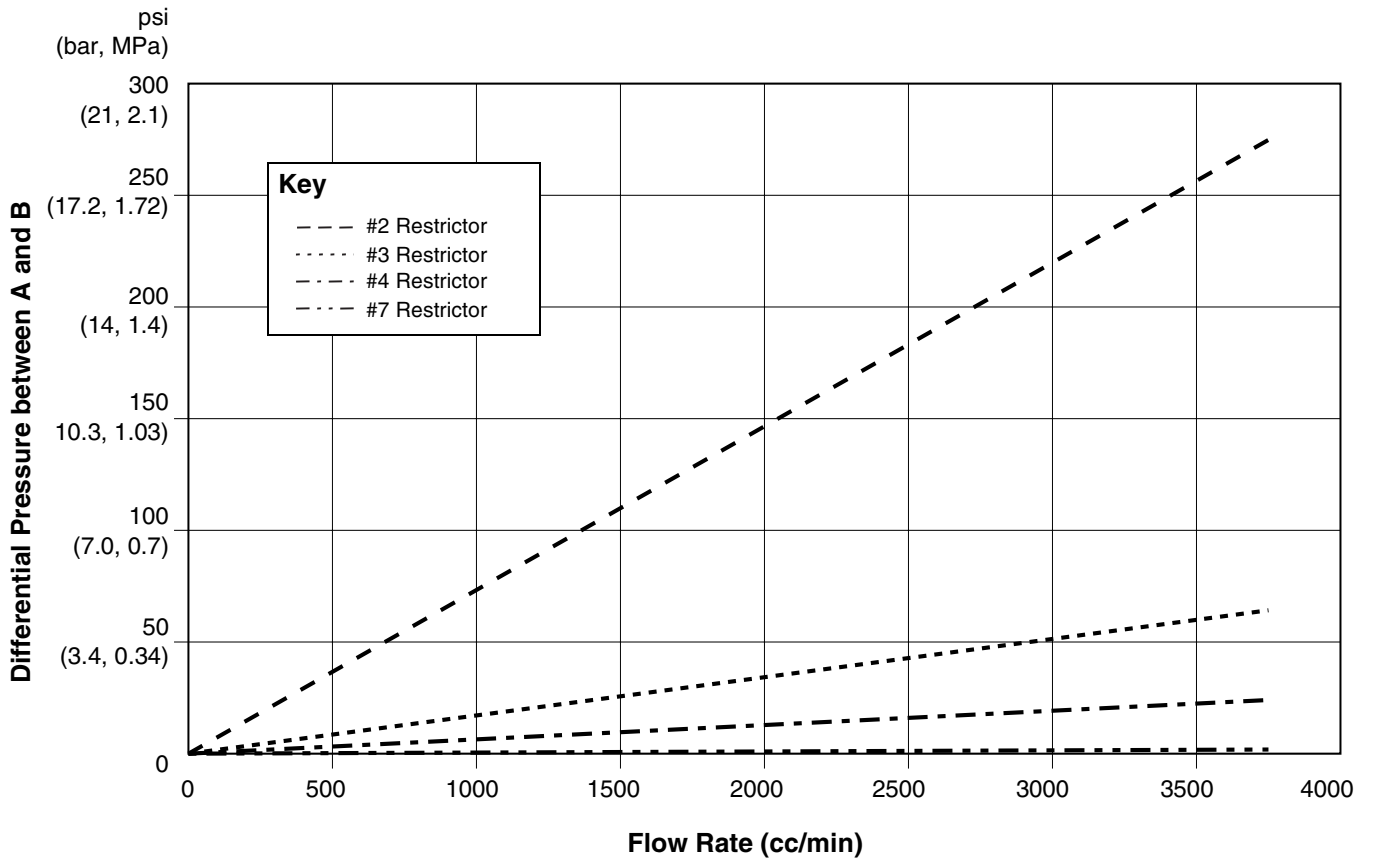

Fig. 60. Dynamic Dosing Performance (10:1 Ratio, 90 centipoise fluid, 100 psi A side pressure)



Detail View

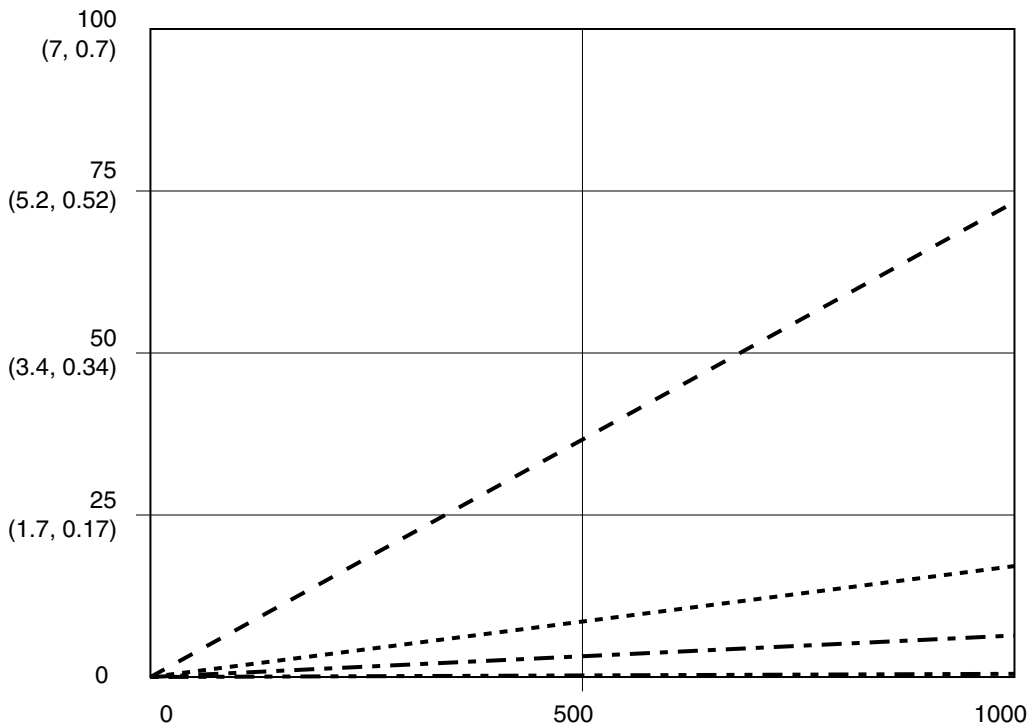
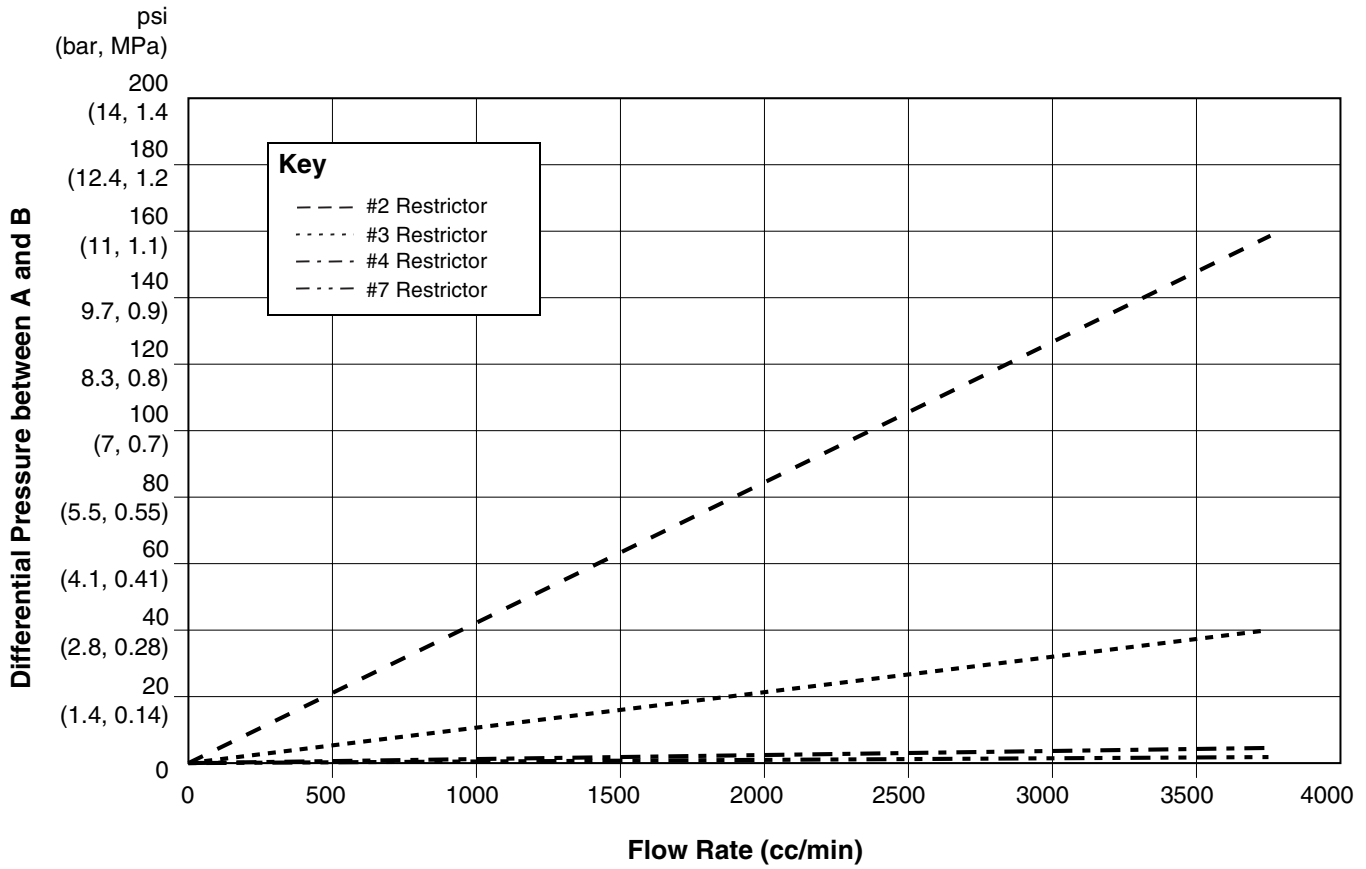

FIG. 61. Dynamic Dosing Performance (20:1 Ratio, 90 centipoise fluid, 100 psi A side pressure)



Detail View

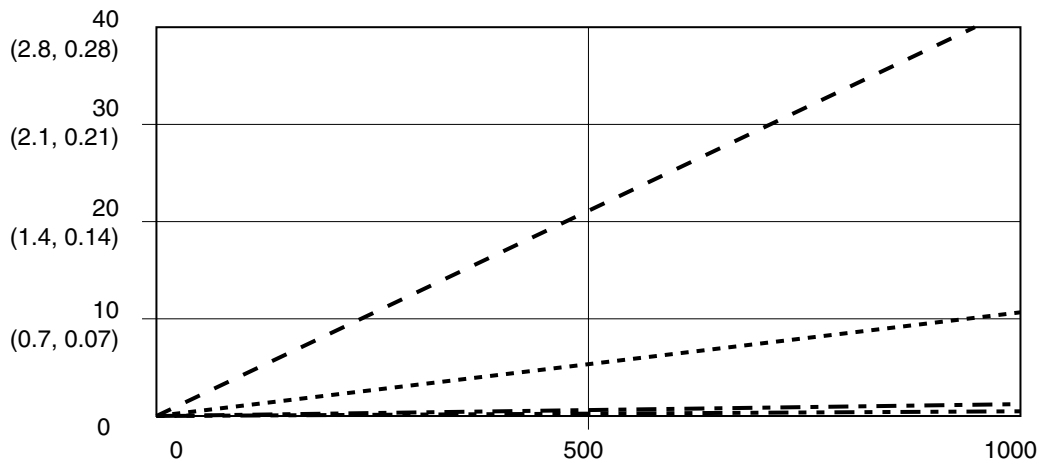
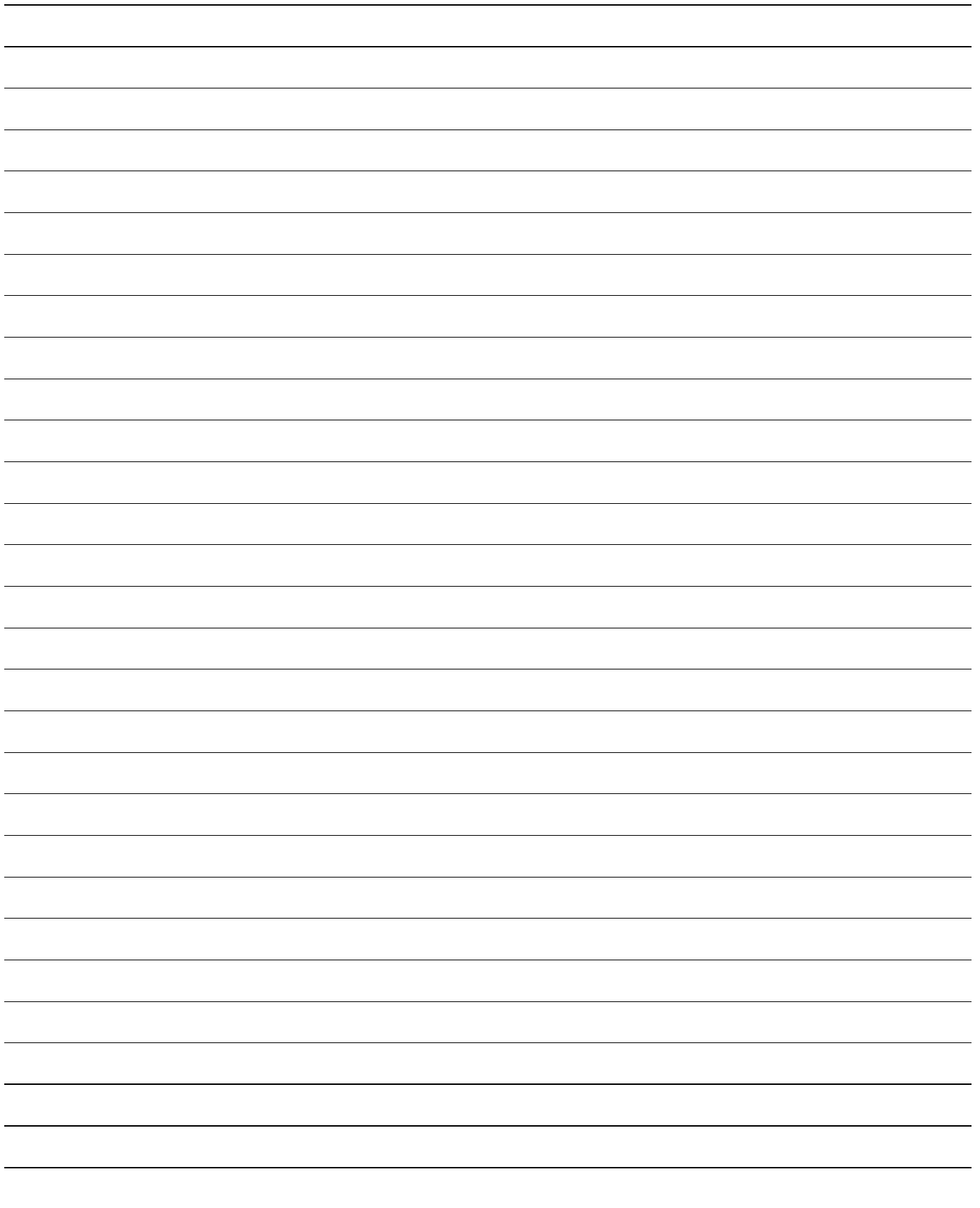
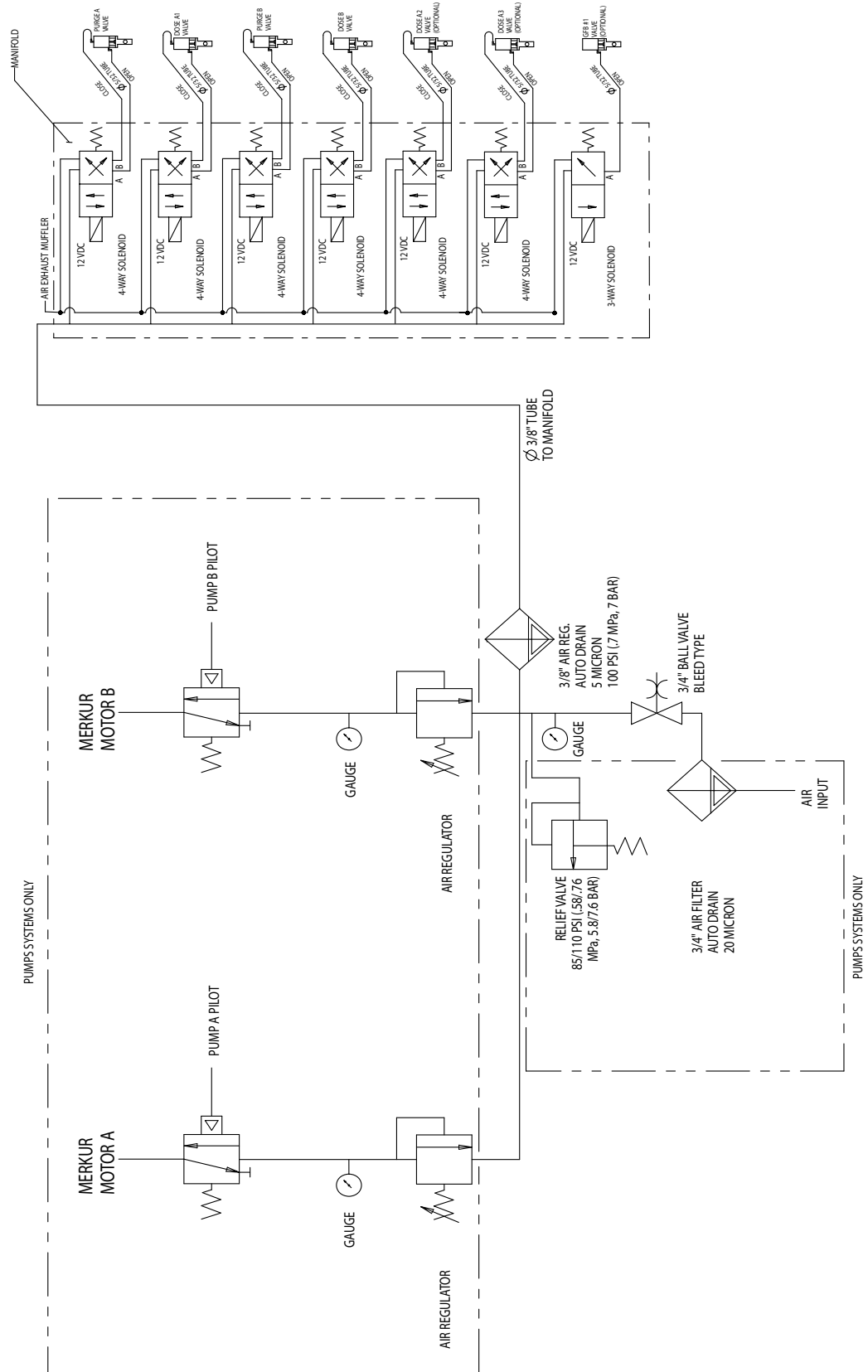

Fig. 62. Dynamic Dosing Performance (30:1 Ratio, 90 centipoise fluid, 100 psi A side pressure)



Non-Hazardous Location Pneumatic Schematic



Hazardous Location Electrical Schematic

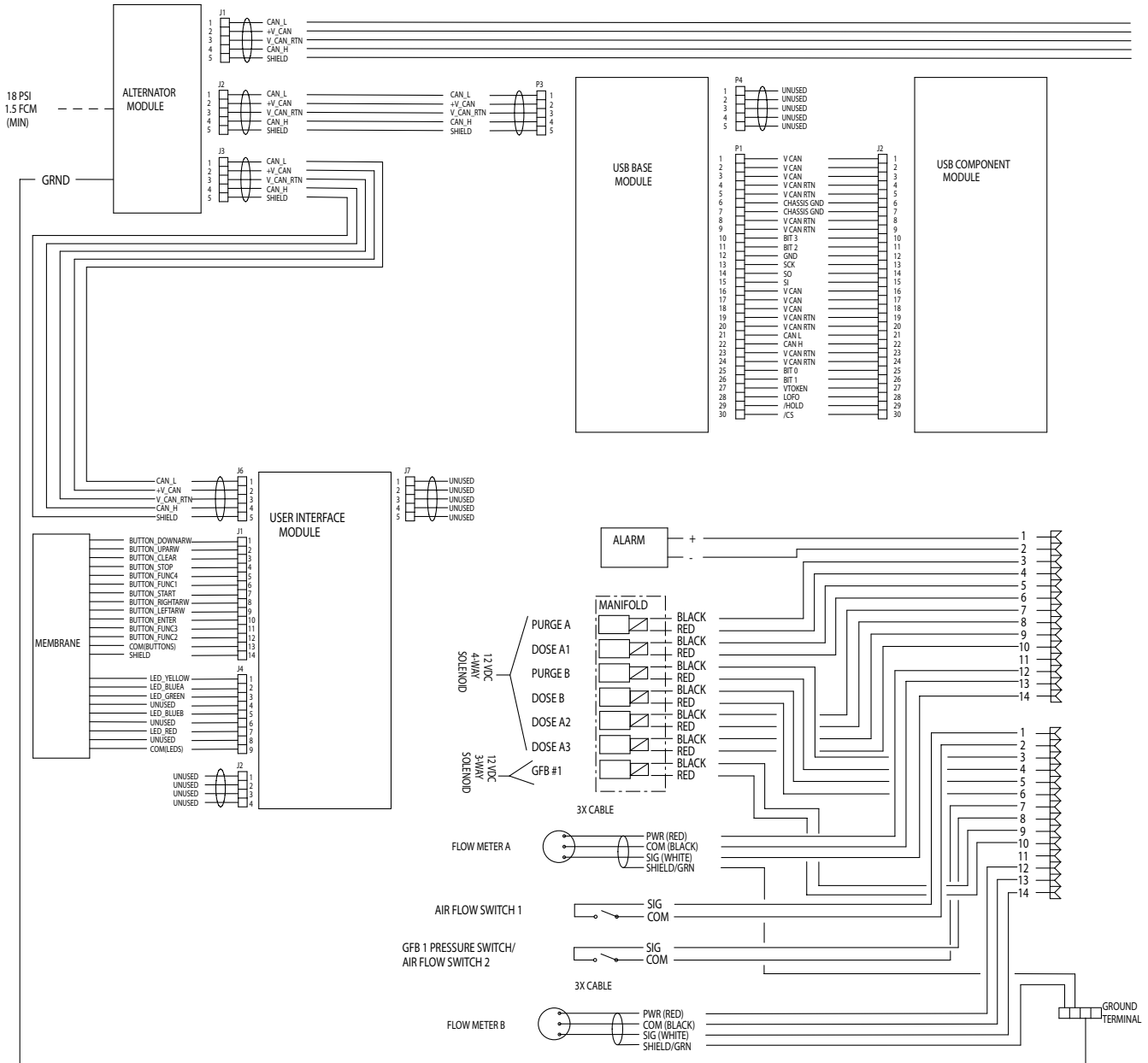

Hazardous Location Electrical Schematic (continued)

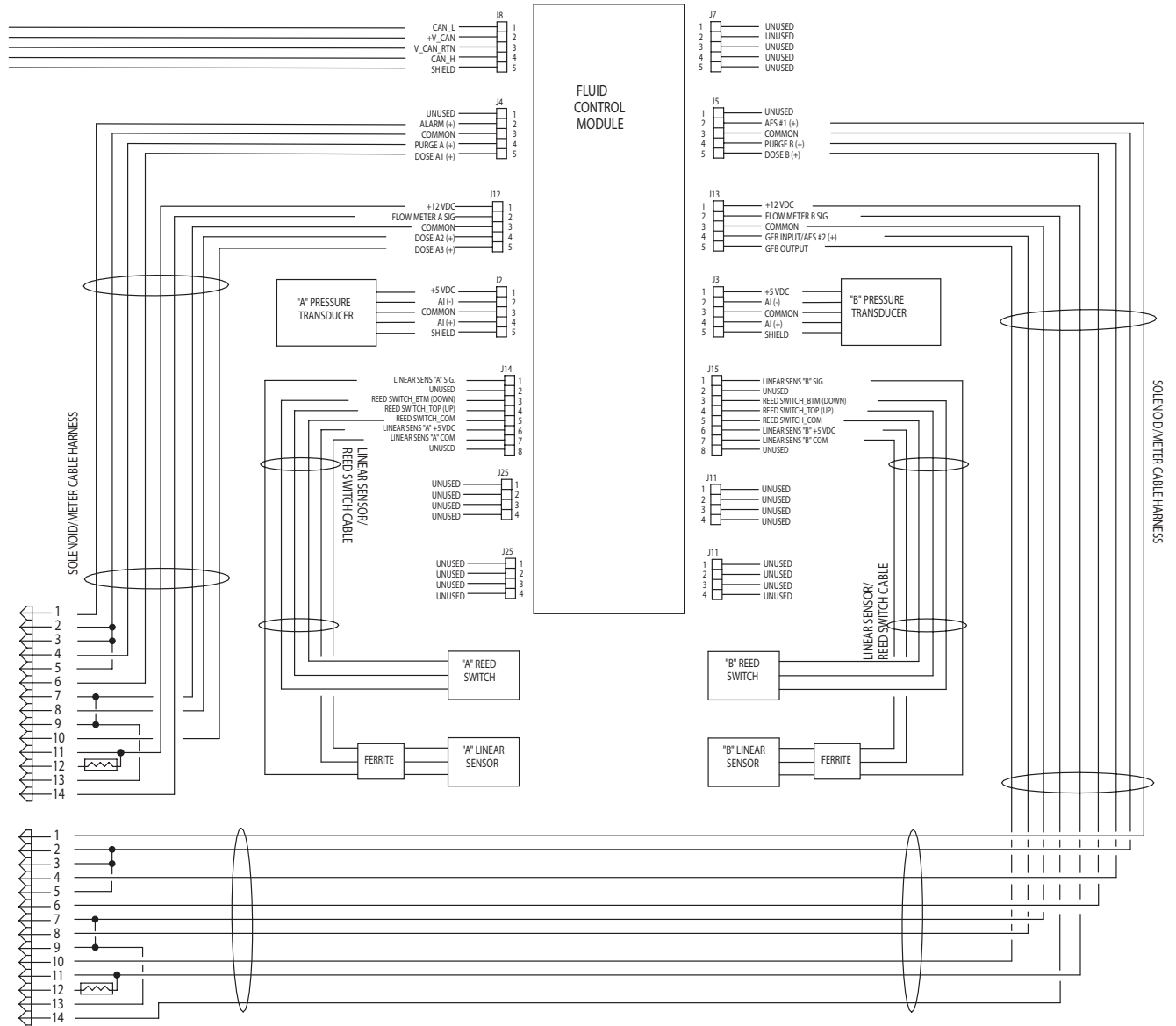

Non-Hazardous Location Electrical Schematic

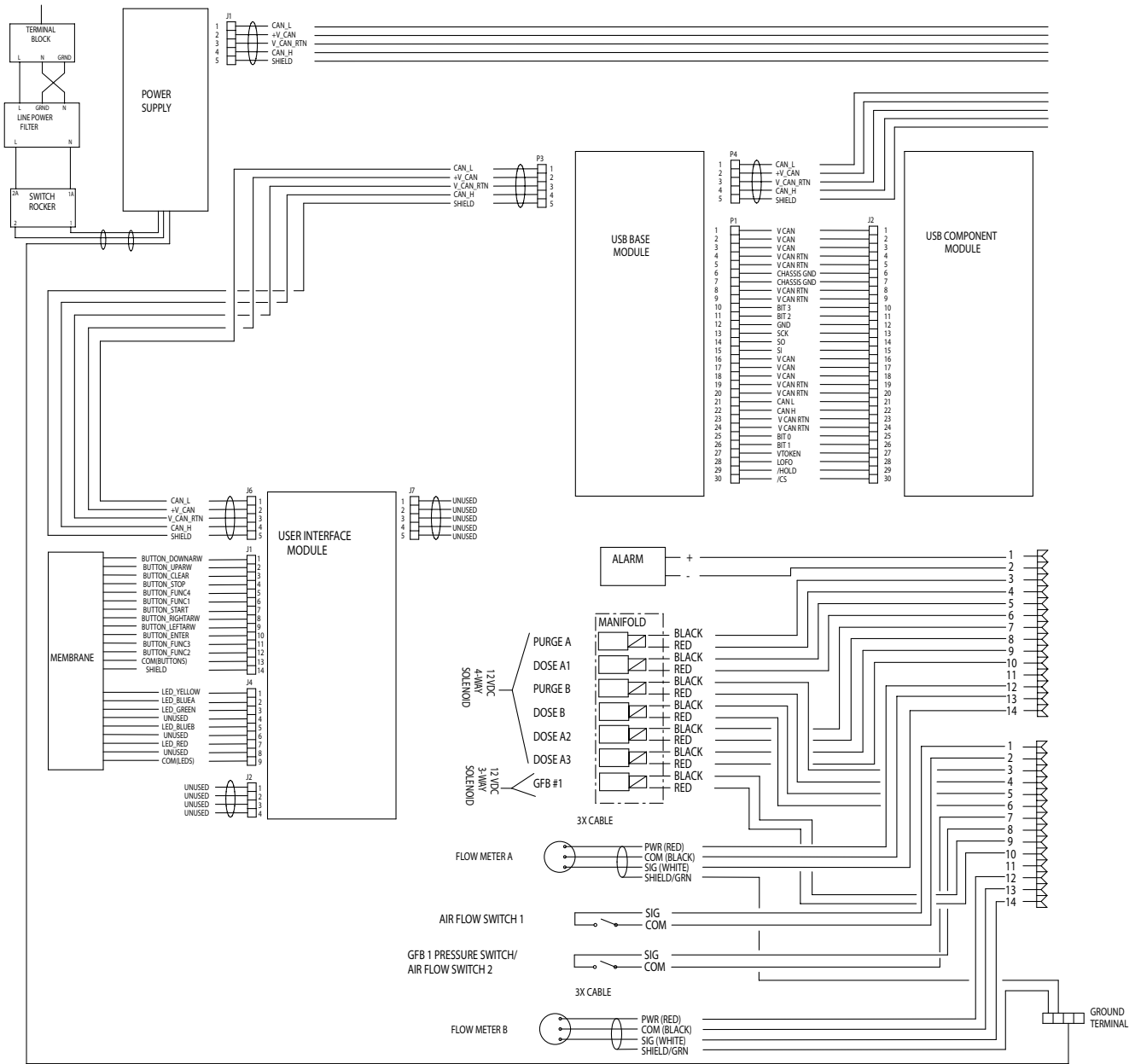

Non-Hazardous Location Electrical Schematic (continued)

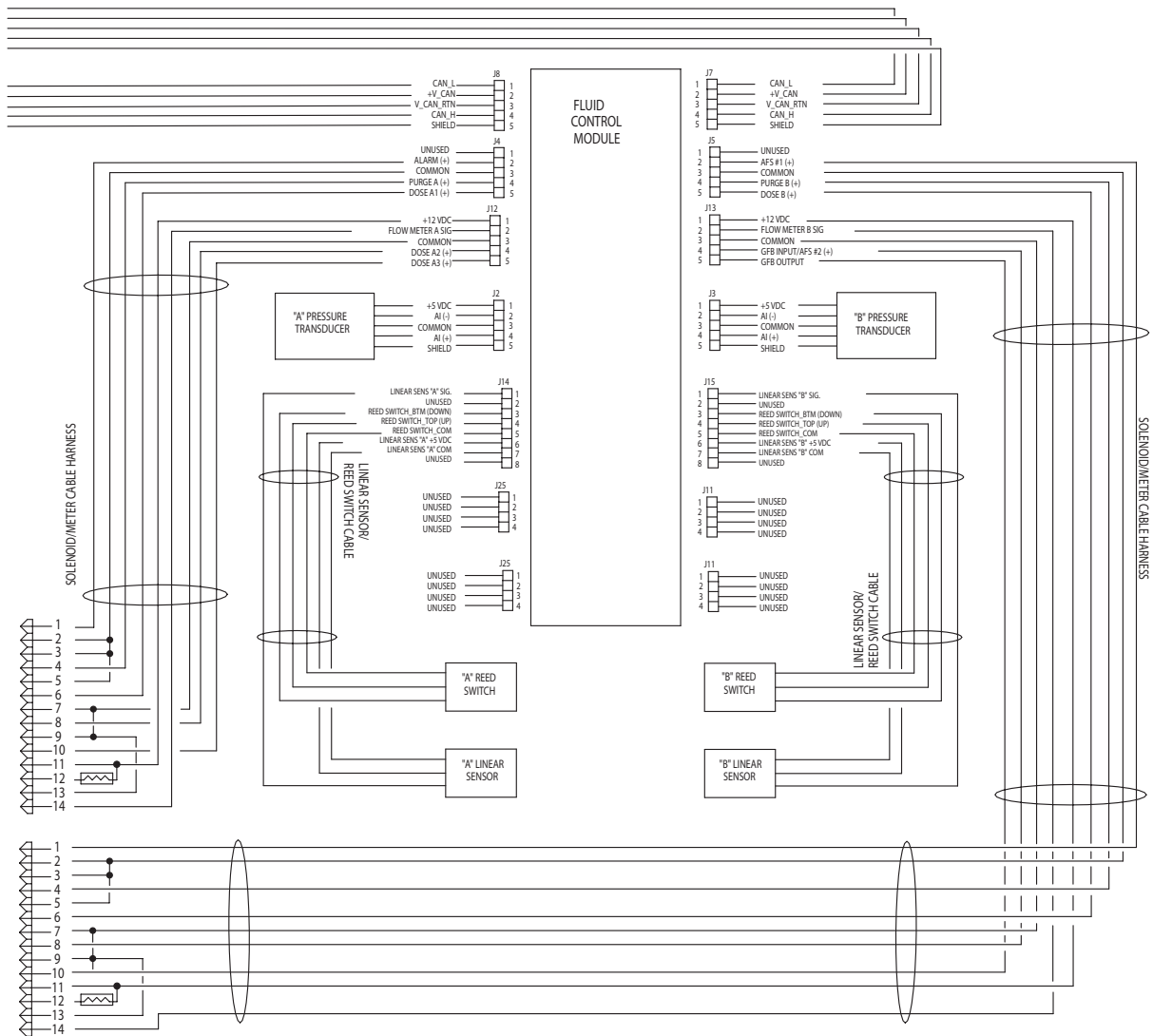

Dimensions and Mounting

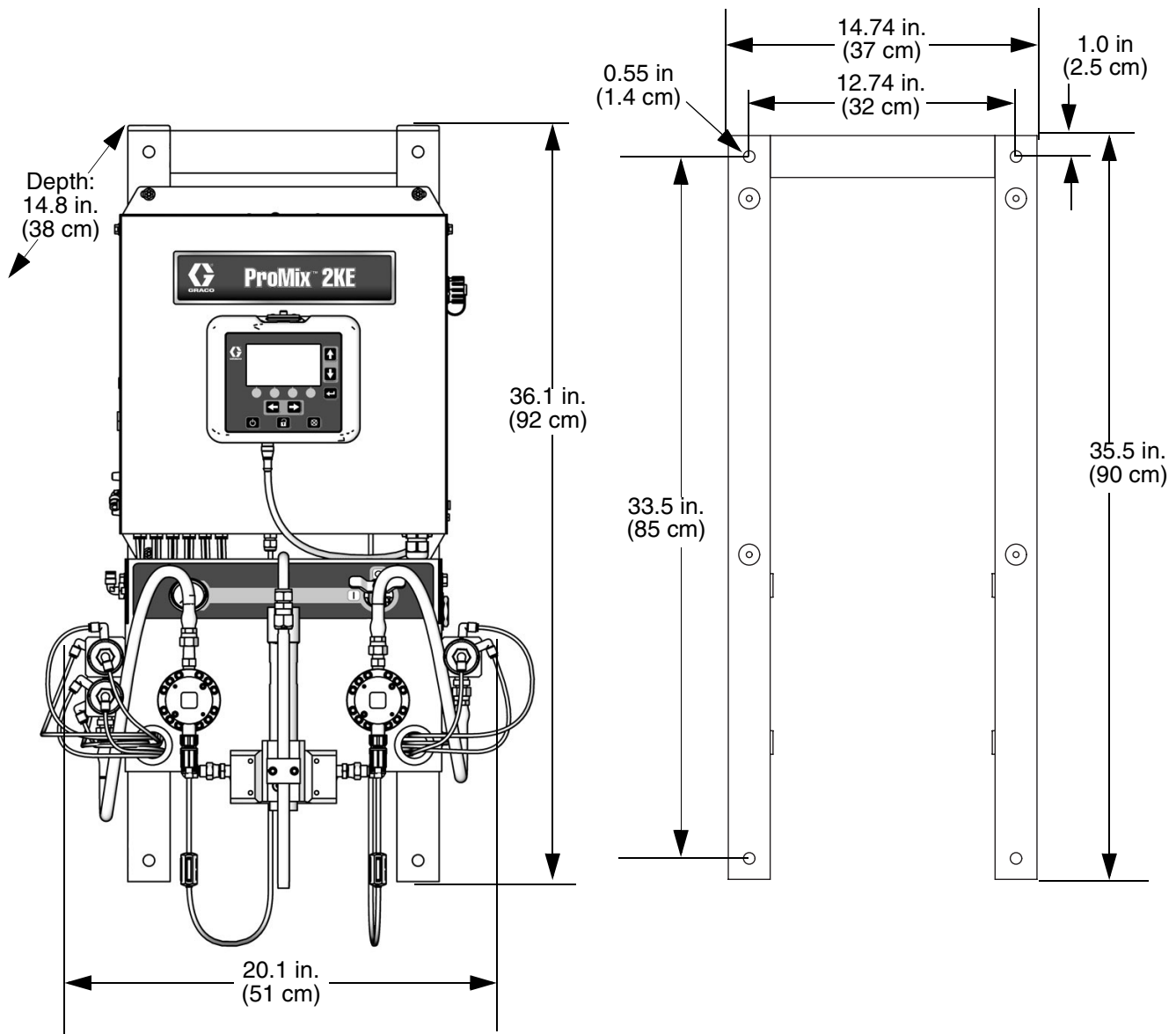

Technical Data

ProMix 2KE, Meter-Based Systems		
	US	Metric
Maximum fluid working pressure	See Models , page 3.	
Maximum working air pressure	100 psi	0.7 MPa, 7 bar
Air supply	75 to 100 psi	0.5 to 0.7 MPa, 5.2 to 7 bar
Air filter inlet size	3/8 npt(f)	
Air filtration for air logic (Graco-supplied)	5 micron (minimum) filtration required; clean and dry air	
Air filtration for atomizing air (user-supplied)	30 micron (minimum) filtration required; clean and dry air	
Mixing ratio range	0.1:1 to 30:1	
On-ratio accuracy	up to ± 1%, user selectable	
Fluid inlet sizes	1/4 npt(f)	
Fluid outlet size (static mixer)	1/4 npt(f)	
External power supply requirements	85 - 250 Vac, 50/60 Hz, 2 amps maximum draw 15 amp maximum circuit breaker required 8 to 14 AWG power supply wire gauge	
Operating temperature range	41° to 122°F	5° to 50°C
Approximate weight	200 lb	91 kg
Environmental conditions rating	indoor use, pollution degree (2), installation category II	
Fluids handled	one or two component: <ul style="list-style-type: none"> • solvent and waterborne paints • polyurethanes • epoxies • acid catalyzed varnishes 	
Fluid flow rate range		
G3000, G250 Meter	0.02 to 1.00 gal/min	75 to 3800 cc/min
G3000HR, G250HR Meter	0.01 to 0.50 gal/min	38 to 1900 cc/min
Coriolis Meter	0.005 to 1.00 gal/min	20 to 3800 cc/min
S3000 Solvent Meter (accessory)	0.01 to 0.50 gal/min	38 to 1900 cc/min
Noise level		
Sound pressure level	below 70 dBA	
Sound power level	Below 85 dBA	
Materials of construction		
Wetted materials on all models	303, 304 SST; Tungsten carbide (with nickel binder); perfluoroelastomer; PTFE	

Graco Standard Warranty

Graco warrants all equipment referenced in this document which is manufactured by Graco and bearing its name to be free from defects in material and workmanship on the date of sale to the original purchaser for use. With the exception of any special, extended, or limited warranty published by Graco, Graco will, for a period of twelve months from the date of sale, repair or replace any part of the equipment determined by Graco to be defective. This warranty applies only when the equipment is installed, operated and maintained in accordance with Graco's written recommendations.

This warranty does not cover, and Graco shall not be liable for general wear and tear, or any malfunction, damage or wear caused by faulty installation, misapplication, abrasion, corrosion, inadequate or improper maintenance, negligence, accident, tampering, or substitution of non-Graco component parts. Nor shall Graco be liable for malfunction, damage or wear caused by the incompatibility of Graco equipment with structures, accessories, equipment or materials not supplied by Graco, or the improper design, manufacture, installation, operation or maintenance of structures, accessories, equipment or materials not supplied by Graco.

This warranty is conditioned upon the prepaid return of the equipment claimed to be defective to an authorized Graco distributor for verification of the claimed defect. If the claimed defect is verified, Graco will repair or replace free of charge any defective parts. The equipment will be returned to the original purchaser transportation prepaid. If inspection of the equipment does not disclose any defect in material or workmanship, repairs will be made at a reasonable charge, which charges may include the costs of parts, labor, and transportation.

THIS WARRANTY IS EXCLUSIVE, AND IS IN LIEU OF ANY OTHER WARRANTIES, EXPRESS OR IMPLIED, INCLUDING BUT NOT LIMITED TO WARRANTY OF MERCHANTABILITY OR WARRANTY OF FITNESS FOR A PARTICULAR PURPOSE.

Graco's sole obligation and buyer's sole remedy for any breach of warranty shall be as set forth above. The buyer agrees that no other remedy (including, but not limited to, incidental or consequential damages for lost profits, lost sales, injury to person or property, or any other incidental or consequential loss) shall be available. Any action for breach of warranty must be brought within two (2) years of the date of sale.

GRACO MAKES NO WARRANTY, AND DISCLAIMS ALL IMPLIED WARRANTIES OF MERCHANTABILITY AND FITNESS FOR A PARTICULAR PURPOSE, IN CONNECTION WITH ACCESSORIES, EQUIPMENT, MATERIALS OR COMPONENTS SOLD BUT NOT MANUFACTURED BY GRACO. These items sold, but not manufactured by Graco (such as electric motors, switches, hose, etc.), are subject to the warranty, if any, of their manufacturer. Graco will provide purchaser with reasonable assistance in making any claim for breach of these warranties.

In no event will Graco be liable for indirect, incidental, special or consequential damages resulting from Graco supplying equipment hereunder, or the furnishing, performance, or use of any products or other goods sold hereto, whether due to a breach of contract, breach of warranty, the negligence of Graco, or otherwise.

FOR GRACO CANADA CUSTOMERS

The Parties acknowledge that they have required that the present document, as well as all documents, notices and legal proceedings entered into, given or instituted pursuant hereto or relating directly or indirectly hereto, be drawn up in English. Les parties reconnaissent avoir convenu que la rédaction du présente document sera en Anglais, ainsi que tous documents, avis et procédures judiciaires exécutés, donnés ou intentés, à la suite de ou en rapport, directement ou indirectement, avec les procédures concernées.

Graco Information

For the latest information about Graco products, visit www.graco.com.

For patent information, see www.graco.com/patents.

TO PLACE AN ORDER, contact your Graco distributor or call to identify the nearest distributor.

Phone: 612-623-6921 **or Toll Free:** 1-800-328-0211 **Fax:** 612-378-3505

*All written and visual data contained in this document reflects the latest product information available at the time of publication.
Graco reserves the right to make changes at any time without notice.*

Original instructions. This manual contains English. MM 3A0869

Graco Headquarters: Minneapolis

International Offices: Belgium, China, Japan, Korea

GRACO INC. AND SUBSIDIARIES • P.O. BOX 1441 • MINNEAPOLIS MN 55440-1441 • USA

Copyright 2010, Graco Inc. All Graco manufacturing locations are registered to ISO 9001.

www.graco.com

Revision H, December 2014

Free Manuals Download Website

<http://myh66.com>

<http://usermanuals.us>

<http://www.somanuals.com>

<http://www.4manuals.cc>

<http://www.manual-lib.com>

<http://www.404manual.com>

<http://www.luxmanual.com>

<http://aubethermostatmanual.com>

Golf course search by state

<http://golfingnear.com>

Email search by domain

<http://emailbydomain.com>

Auto manuals search

<http://auto.somanuals.com>

TV manuals search

<http://tv.somanuals.com>