

GRACO®

Stroller

OWNER'S MANUAL

Model No. _____
Serial No. _____

Dear Customer,

Please fill in the model and serial numbers above from the label on the rear leg of your new stroller.

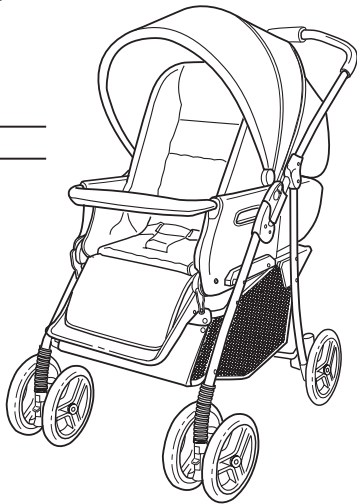

Models 7585 and 7587

Congratulations on your purchase of a Graco® stroller!

Graco® is a world leader in strollers and has helped thousands of parents transport their children in comfort. We believe your new Graco® stroller is a wise choice, promising many hours of enjoyment for your baby.

Before using your stroller, please take a few minutes to read this Owner's Manual. The short time you spend reading these instructions will help you assemble and use your stroller properly.

Please save your Owner's Manual for future use.

Customer Satisfaction

Our goal is to make every product the best it can be! We are also committed to supporting our products after purchase. If you would like to speak to Graco about your product, please contact our **Customer Service Department at 1-800-345-4109**. Our knowledgeable staff will be ready to answer any questions you may have concerning parts, use or maintenance. When you call, please have the **model and serial numbers** ready so your call may be processed quickly and efficiently.

⚠ WARNING



Never leave child unattended. Always keep your child in view.

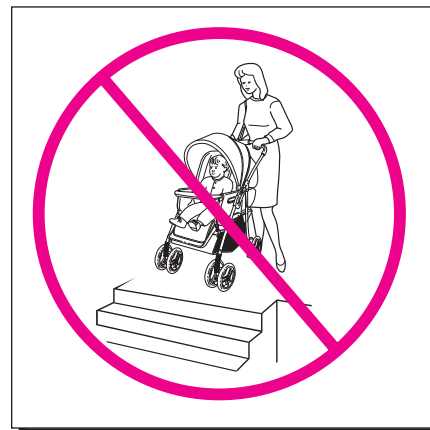

Never use stroller on stairs or escalators. You may suddenly lose control of the stroller or your child may fall out. Also, use extra care when going up or down a step or curb.



Use of the stroller with a child weighing more than 40 lbs. (18.1 kg) will cause excessive wear and stress on the stroller. Use the stroller with only one child at a time.



Avoid serious or sliding of belt.



Be certain the child is properly seated and latched before moving stroller.

Child may slip out of stroller if used in reclined position. Do not use in completely reclined position.

DO NOT lift stroller by handle.
DO NOT use stroller for jogging, skating, etc.
DO NOT lift, push, pull, or pull stroller to less than 6 inches from ground.

To prevent a storage basket from falling out of stroller, do not use stroller for jogging, skating, etc.
Discontinue use of stroller if storage basket falls out.

Failure to follow these warnings and the assembly instructions could result in serious injury or death.

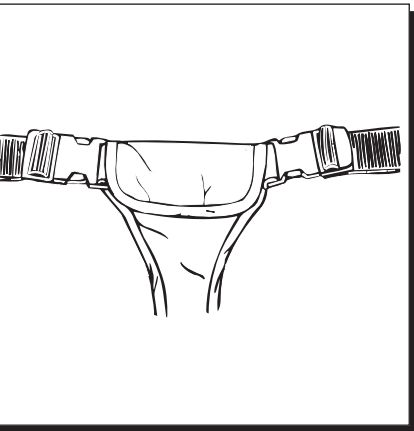

Avoid serious injury from falling or sliding out. Always use seat belt.



Never place child in the stroller with head near the footrest, when footrest faces forward as shown.

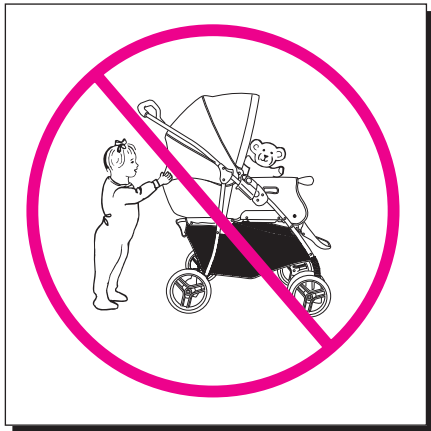

Never allow your stroller to be used as a toy.

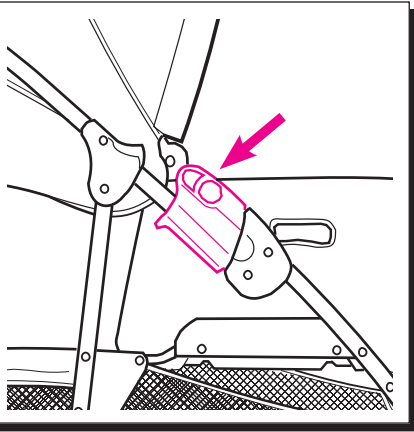

Be certain the stroller is fully erected and latched before allowing your child near the stroller.

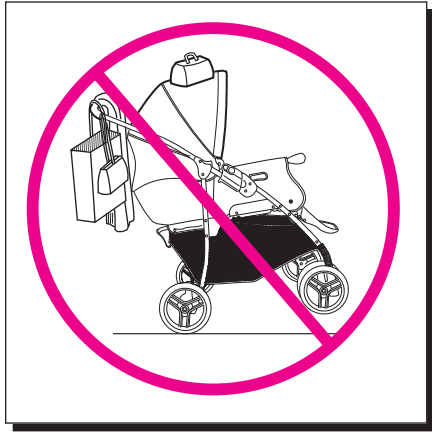

DO NOT place purses, shopping bags, parcels and accessory items on handle or canopy. They may fall on the child, or change the balance of the stroller and make it unstable.



Avoid strangulation. DO NOT place items with a string around your child's neck, suspend strings from this product, or attach strings to toys.

Child may slip into leg openings and strangle. Never use in reclined carriage position unless footrest is completely raised and locked into position as shown.

- DO NOT lift stroller by the arm bar.
- DO NOT use seat in an automobile.
- DO NOT use as a car bed.

DO NOT lift, reverse or carry the seat while child is in the seat.
DO NOT add extra mattress padding to the seat that will reduce the depth of seat to less than 6.75 inches (170 mm).

To prevent a hazardous condition, do not place more than 10 lbs. (4.5 kg) in the storage basket.

Stroller to be used only at walking speed. Product not intended for use while jogging, skating, etc.

Discontinue using your stroller should it become damaged or broken.

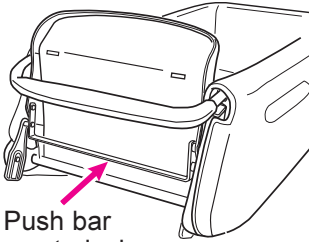

FOR ADDITIONAL IMPORTANT INFORMATION, please see the Helpful Hints and Care and Maintenance sections in these instructions.

PARTS LIST

CHECK that you have all the parts listed below BEFORE assembling your stroller. If any parts are missing, call Customer Service at 1-800-345-4109.

THIS PRODUCT REQUIRES ADULT ASSEMBLY.

No tools required for assembly.

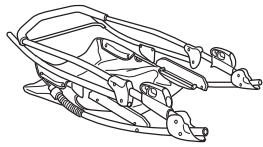

Frame

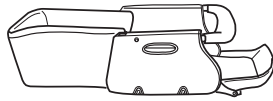

Seat



Rear wheel (2)



Retainer (2, 1 extra)



Cap (2, 1 extra)

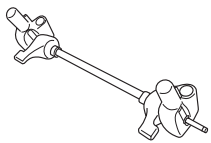

Rear axle assembly

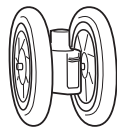

Front wheel assembly (2)

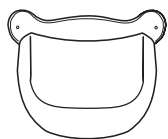

Boot (on certain models)

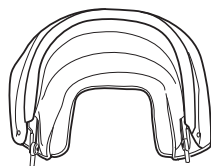

Canopy

To Unpack Stroller

Step 1.

Flatten stroller carton to protect floor. Slide seat out from frame and set it aside.

Step 2.

Open stroller frame on carton by lifting handle until locking latches on both sides are locked as shown.

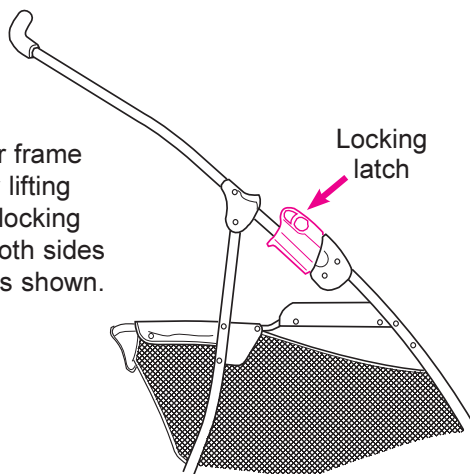

To Assemble Front Wheels

▲ WARNING To prevent serious injury or death from choking, remove and IMMEDIATELY discard plastic end caps on the front leg pins.

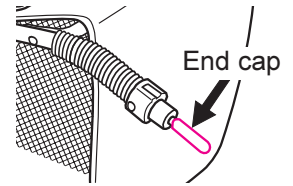

Step 1.

Remove and discard the plastic end caps on the front leg pins. Line up pin with a wheel assembly as shown.

Plastic snap inside wheel mount must be away from pin. Push wheel assembly onto pin until it snaps into place.

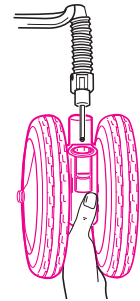

Step 2.

Repeat for other wheel assembly.

NOTE: Pull firmly on each wheel assembly to be sure the wheel assemblies are securely attached.

To Assemble Rear Axle

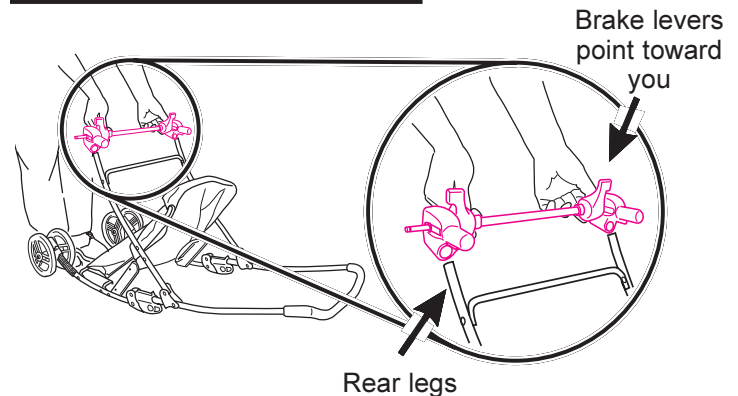

Step 1.

Turn stroller over as pictured above.

Step 2.

Position rear axle assembly as shown.

Step 3.

Start both brackets onto leg tubes at the same time.

Step 4.

Push both brackets on until plastic tabs snap into the slots on the legs.

Step 5.

Pull firmly on each bracket to be sure the brackets are securely attached.

To Assemble Rear Wheels

Place one rear wheel, red retainer, and white cap on one end of rear axle **in order** as shown below. Push red retainer onto axle **BEFORE** attaching white cap. Repeat on other side.

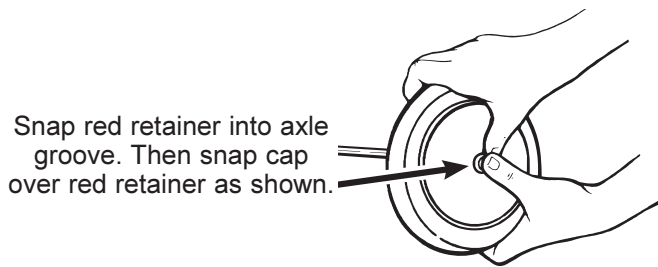
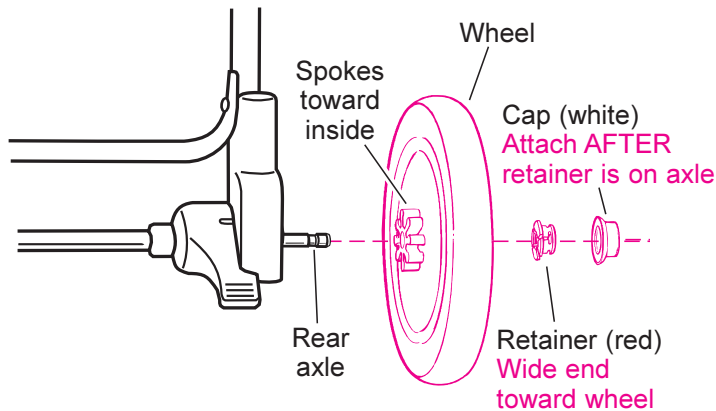

Be sure cap is snapped securely over red retainer.

To Attach Seat

Step 1.

Set the stroller frame upright.

Step 2.

Line up notches on sides of seat with plastic brackets on frame. Lower seat onto frame until it snaps into brackets. Seat can be installed facing either direction. **Pull up on each side of seat to be sure it is securely attached.**

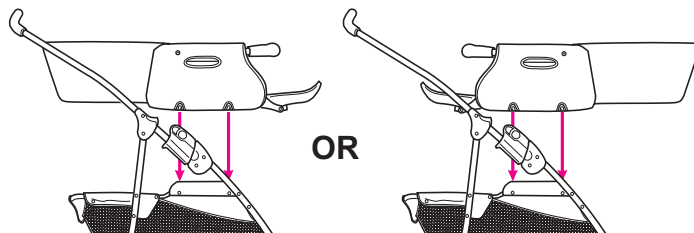

Step 3.

To remove seat to reverse position or for cleaning, squeeze the levers on both sides of seat and lift.

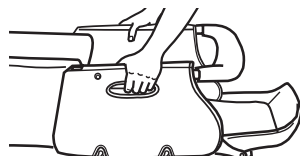

▲ WARNING DO NOT lift, reverse or carry the seat while child is in the seat.

To Adjust Back

To raise or recline seat back, pull up the plastic handle at back of seat and adjust seat back to desired position. Seat back can adjust to five different positions.

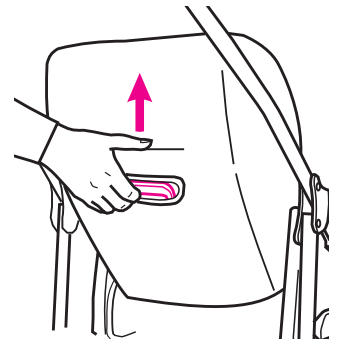

To Assemble Canopy

Step 1.

Position canopy over **back** of stroller frame as shown. Align the ends of the canopy mounts with the openings in the seat covering. Push the canopy mounts into the slots until they snap in place.

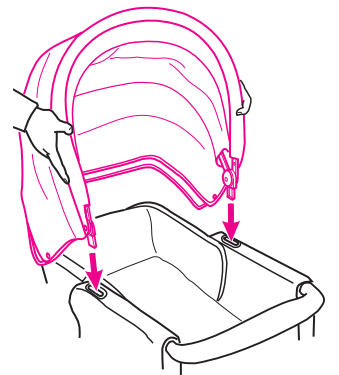

Step 2.

To remove canopy, push in the button **hidden under the padding directly under one canopy mount**, and pull the canopy mount out of the slot. Repeat on other side.

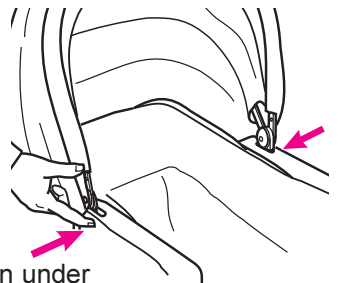

Button under padding below canopy mount

To Adjust Canopy

Push or pull canopy to desired position.

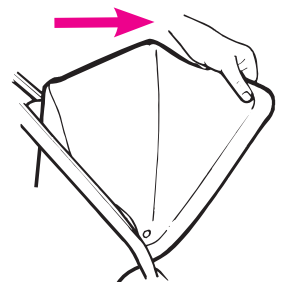

To Adjust Arm Bar

Step 1.

To release the arm bar, squeeze the latches under the arm bar on both sides as shown.

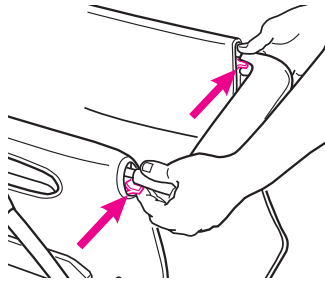

Step 2.

Pull arm bar out until it clicks into extended position.

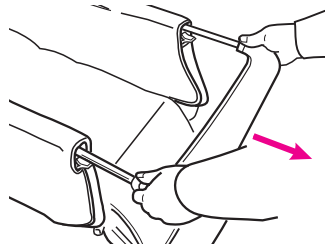

To Adjust Footrest

Step 1.

To lower the footrest, first lift the footrest slightly, then pull down the metal bar as shown.

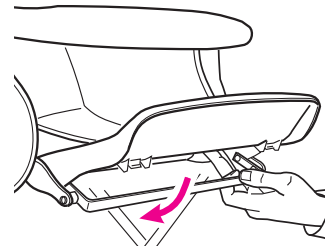

Step 2.

To raise footrest to seat height, lift up the metal bar.

Step 3.

If seat is being used in the fully reclined carriage position, you must close off the leg opening.

▲WARNING Child may slip into leg openings and strangle. Never use in reclined carriage position unless footrest is completely raised and locked into position as shown.

To close off leg opening:

With arm bar extended, raise footrest completely and push footrest bar down to lock it in place. Then snap arm bar into normal (non-extended) position. **Arm bar must SNAP into position, not just press against footrest.**

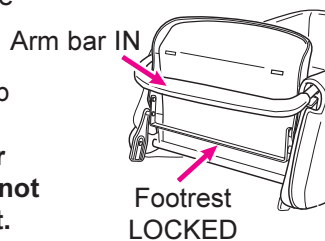

To Change to Swivel or Non-swivel Wheels

Front swivel wheels lock for use on uneven surfaces such as grass, stones or gravel.

Before locking swivels, first push stroller forward a few feet to ensure that the wheels are correctly positioned.

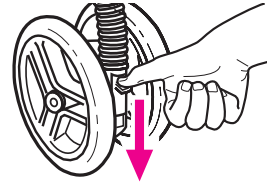

Slide **DOWN** for swivel.

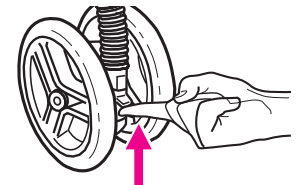

Slide **UP** for non-swivel.

To Use Brakes

▲WARNING Always apply brakes when parking stroller.

Push brake levers **DOWN** to park.

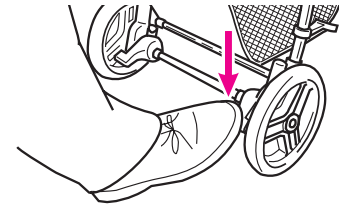

Lift brake levers **UP** to stroll.

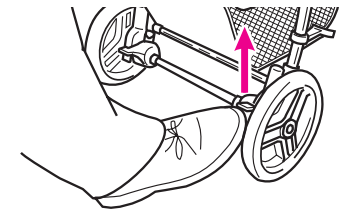

To Secure Your Child

▲WARNING Avoid serious injury from falling or sliding out. Always use seat belt.

Step 1.

Place crotch strap between legs and fasten both belt buckles together.

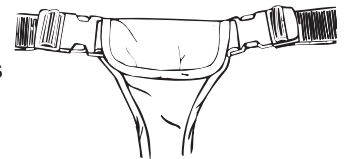

Step 2.

Adjust belt at both buckles as needed to get a snug fit around your child.

Step 3.

Squeeze sides of buckles to release.

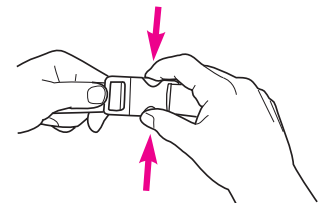

To Use Boot (on certain models)

Step 1.

Put seat back into any position except fully reclined. (For fully reclined carriage position, see below.) Set footrest at seat height and snap arm bar into the extended position. **CHECK that footrest is secure at seat height by pressing down on it. If not, adjust metal bar under footrest.** Place boot under the footrest. Slide it over footrest and arm bar as shown.

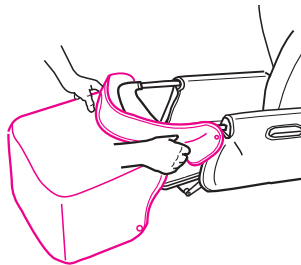

Step 2.

Fasten snaps at top and bottom corners of the boot to padding at each side.

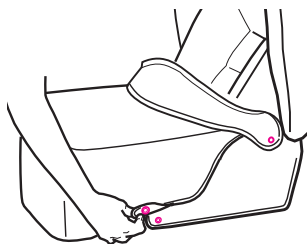

If seat is being used in fully reclined carriage position, close off leg opening as described in "To Adjust Footrest" before placing boot on stroller.

To Remove Seat Covering

Seat covering may be removed for washing.

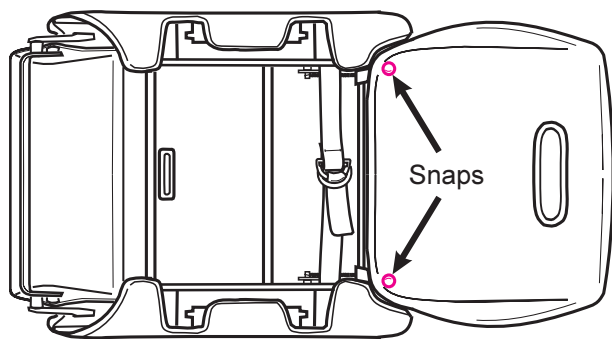

Step 1.

Turn seat upside down. Unsnap VELCRO® at sides of the seat to release side flaps. Unsnap two snaps at bottom of seat back and release elastic straps from bar.

Step 2.

Unfasten webbing strap from "D" rings under the seat.

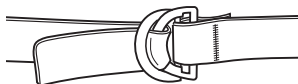

Step 3.

Unhook the small elastic loops from the two plastic tabs found under the footrest.

Step 4.

Turn seat right side up. Put footrest down. Remove arm bar. (See "To Adjust Arm Bar" instructions.)

Step 5.

Unbuckle the seat belt. Carefully remove covering from seat frame. Please note to:

- Pull crotch strap out of slot in covering.
- Pull webbing strap and "D" rings out of slots in the seat frame.

Step 6.

Crotch strap may also be removed for washing. Under the seat frame, push the plastic crotch strap retainer through the slot in the frame to remove it.

To Reattach Seat Covering

To reattach the seat covering, reverse the previous steps.

Step 1.

Slide back part of covering over rear of seat frame. **Be sure back part of covering slides behind, not over, the side panels of the seat.**

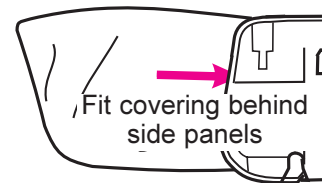

Step 2.

Replace all straps:

- Push webbing strap and "D" rings through slots in the seat frame as shown.
- If needed, reattach crotch strap by pushing lower plastic crotch strap retainer through slot in seat frame.
- Push crotch strap through slot in seat covering.

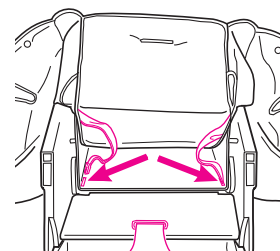

Step 3.

Fit sides of covering over side panels of seat. Push covering down into seat.

Step 4.

Reattach arm bar. Squeeze both latches below arm bar holes at sides of seat, and insert bar. Push bar in until it snaps in place.

Step 5.

Turn seat upside down. Reattach elastic loops on footrest pad to plastic tabs under footrest.

Step 6.

Thread end of webbing strap through "D" rings at back of seat **exactly as shown**.

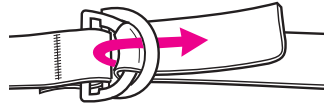

Step 7.

Snap the two elastic straps at bottom of seat back around the bar. Fasten the side flaps with VELCRO® tabs.

Be sure to secure all snaps, VELCRO®, straps and fabric before using stroller. Pull firmly on waist belt and crotch strap to make sure they are correctly attached.

Be sure fabric does not cover notches in seat sides. Notches must be clear of fabric to securely latch onto frame.

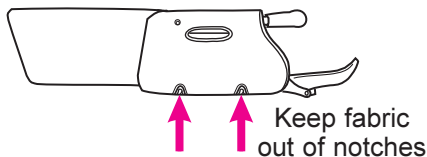

Step 2.

Pull up locking latches at sides of stroller to release handle, and fold handle down.



OR

On some models with a one-hand fold, slide red button on handle, twist grip toward yourself until it stops, then push handle down on stroller.

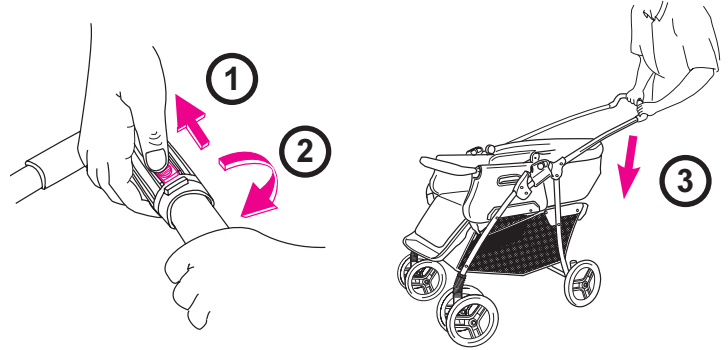

Step 3.

Close and lock storage latch.

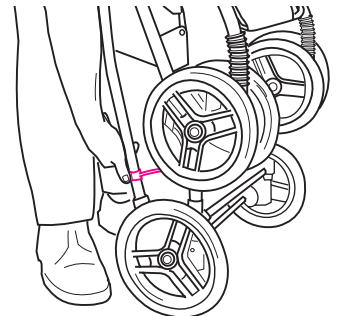

To Fold Stroller

Step 1.

Before folding stroller, fold canopy and fully recline seat. Apply brakes to prevent stroller from moving.

The stroller will fold most compactly if seat is installed in the forward-facing position.

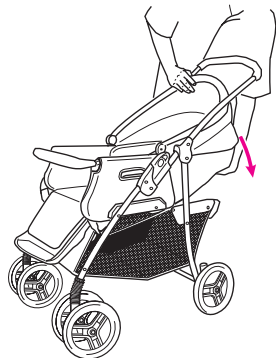

HELPFUL HINTS

IF WHEEL SQUEAKS, use a light oil (e.g., WD-40, 3-in-1, or sewing machine oil). It is important to get the oil into the axle and wheel assembly as illustrated.

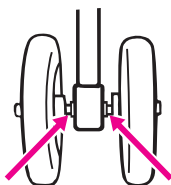

WHEN USING YOUR STROLLER AT THE BEACH, completely clean your stroller afterward to remove sand and salt from wheel assemblies and all mechanisms, including the bottom of the seat. Sand in the seat latching mechanism could damage it.

CARE AND MAINTENANCE

TO WASH SEAT COVERING, remove seat from stroller and remove seat covering. Machine wash in lukewarm water on delicate cycle and drip-dry. **NO BLEACH.**

REMOVABLE SECOND SEAT PAD (if so equipped) may be machine washed in lukewarm water on delicate cycle and drip-dried. **NO BLEACH.**

TO WASH CANOPY:

(1) Remove canopy from stroller. (2) Unsnap canopy from plastic canopy mounts. (3) Unscrew metal support rod at one end as shown. (4) Pull end of rod out of plastic mount. (5) Slide canopy over plastic mount and both rods to remove. Machine wash in lukewarm water on delicate cycle and drip-dry. **NO BLEACH.**

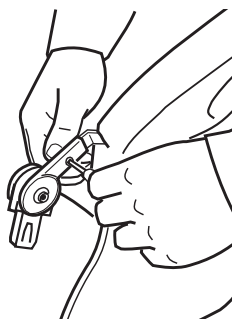

TO CLEAN STROLLER FRAME, use only household soap or detergent and warm water. **NO BLEACH.**

FROM TIME TO TIME CHECK YOUR STROLLER for loose screws, worn parts, torn material or stitching. Replace or repair the parts as needed. Use only Graco® replacement parts.

EXCESSIVE EXPOSURE TO SUN OR HEAT could cause fading or warping of parts.

IF STROLLER BECOMES WET, open canopy and remove boot. Allow to dry thoroughly before storing.

Replacement Parts

Instructions for ordering stroller parts:

Complete form below. Your stroller model number **MUST** be included on the form to ensure proper replacement parts. **Your model number can be found on a sticker on the rear leg of your stroller.** **Payment must accompany your order.**

Parts List:	Price:*
Seat	\$25.00
Canopy	\$18.00
Front wheel assembly	\$16.00
(2 wheels per unit)	
Rear axle assembly	\$11.00
Rear wheel	\$ 8.00 (each)
Basket	\$16.00
Boot	\$15.00
Arm bar	\$15.00
Removable soft pad**.....	\$16.00
Rear wheel hardware	No charge

** On certain models only

* Prices subject to change without notice.

IF YOU NEED HELP

If you have any questions, please call toll-free:

1-800-345-4109

Return the form below with payment to:
GRACO CHILDREN'S PRODUCTS INC.
CUSTOMER SERVICE DEPARTMENT
P.O. BOX 100, MAIN STREET
ELVERSON, PA 19520

Model Number	SHIP TO:
(Must be filled in)	Name _____
<input type="checkbox"/> Seat	Address _____
<input type="checkbox"/> Canopy	City, State, Zip _____
<input type="checkbox"/> Front wheel assembly	() _____
<input type="checkbox"/> Rear axle assembly	Telephone _____
<input type="checkbox"/> Rear wheel	<input type="checkbox"/> Check enclosed
<input type="checkbox"/> Basket	(payable to Graco Children's Products Inc.)
<input type="checkbox"/> Boot	<input type="checkbox"/> Charge to credit card:
<input type="checkbox"/> Arm bar	<input type="checkbox"/> Visa
<input type="checkbox"/> Removable soft pad	<input type="checkbox"/> MasterCard
<input type="checkbox"/> Rear wheel hardware	<input type="checkbox"/> Discover
Total: _____	Account #: _____
Shipping & handling: \$5.00	Expiration date: _____
6% sales tax (PA only): _____	Signature: _____
Total amount due: _____	

Free Manuals Download Website

<http://myh66.com>

<http://usermanuals.us>

<http://www.somanuals.com>

<http://www.4manuals.cc>

<http://www.manual-lib.com>

<http://www.404manual.com>

<http://www.luxmanual.com>

<http://aubethermostatmanual.com>

Golf course search by state

<http://golfingnear.com>

Email search by domain

<http://emailbydomain.com>

Auto manuals search

<http://auto.somanuals.com>

TV manuals search

<http://tv.somanuals.com>