

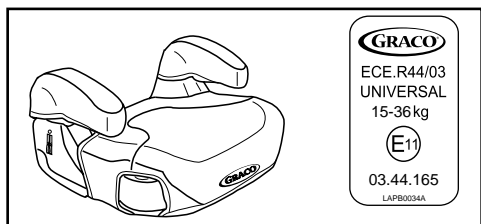

Booster Seat Owner's Manual

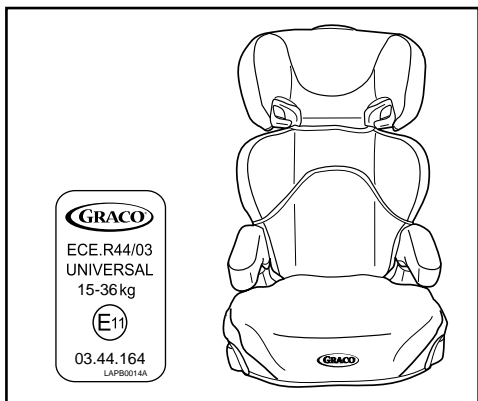

READ THIS MANUAL.

Do not install or use this car seat until you read and understand the instructions in this manual.

FAILURE TO PROPERLY USE THIS CAR SEAT INCREASES THE RISK OF SERIOUS INJURY OR DEATH IN A SUDDEN STOP OR CRASH.

Table of Contents

Important Information	3
European Standard	4
Parts List	5
Warnings to Parents and Other Users	6-9
Adjusting the Armrests	9-10
Assembling the Back Support	11-15
Weight and Height Limits	16-17
Vehicle Seat Location Requirements	18
Vehicle Seat Belt Requirements	19-20
SAFE Vehicle Belt Systems	19
UNSAFE Vehicle Belt Systems	20
Using your Graco Booster Seat	21-23
Booster Seat Positions	24
Securing your Child in Vehicle	25-28
Adjusting the Head Support	29
Securing Child in Vehicle with Shoulder Belt Positioning Clip	30-33
Additional Information	34
Airplane Use	34
Cupholders	34
Instruction Sheet Storage	35
Care and Maintenance	36-37

Important Information

Read this Owner's Manual completely BEFORE first use of your booster seat!

Always keep this Owner's Manual with the booster seat. Provisions are made on the bottom of the seat shell. Plan to spend some time getting to know your booster seat — time well spent when you consider that your baby's safety depends on it. Pay special attention to the warnings.

Before continuing, please locate your vehicle owner's manual. You may need to refer to it as part of these instructions.

Booster seats are designed to give protection to your child in the event of a sudden stop or crash. No booster seat can guarantee absolute protection from injury in the event of a crash, but their use reduces the risks.

Countries differ in their laws and recommendations for safe child restraint use. For further advise contact your local law enforcement officers or your vehicle supplier.

European Standard

European Safety Standards specify the construction and performance of your booster seat as well as its components, requirements for fitting and use, instructions and markings.

Your booster seat has been approved to

European Standard
ECE R44.03

Universal Group 2,3 15-36 kg

An approval number is attached to the seat shell and must not be removed.

Only suitable for use in a vehicle fitted with 3-point with retractor safety belts, approved to ECE Regulation No. 16 or other equivalent standards.

Graco Children's Products

Consumer Services Department

First Floor

900 Pavilion Drive

Northampton NN4 OYR

UK

Tel: 0044 1604 875 600

Fax: 0044 1604 875 800

Parts List

Adult assembly required.



Base

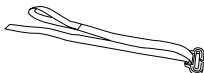

Shoulder belt
positioning clip

On certain models

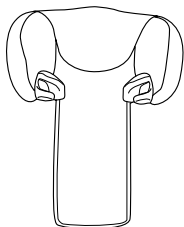

Head support

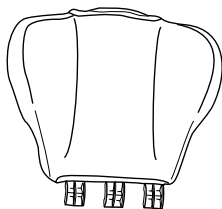

Lower back support



Armrest covers

Warnings to Parents and Other Users

WARNING

- **NO BOOSTER SEAT CAN GUARANTEE PROTECTION FROM INJURY. HOWEVER, PROPER USE OF THIS BOOSTER SEAT REDUCES THE RISK OF SERIOUS INJURY OR DEATH TO YOUR CHILD.**
- **DO NOT INSTALL OR USE THIS BOOSTER SEAT UNTIL YOU READ AND UNDERSTAND THE INSTRUCTIONS IN THIS MANUAL AND IN YOUR VEHICLE OWNER'S MANUAL.** DO NOT let others install or use the booster seat unless they understand how to use it.
- **IT IS MOST IMPORTANT** that the booster seat is correctly routed with the lap portion of the belt across the red belt guides under the armrests and the diagonal belt through the red shoulder belt guides when used with a back support or through the red shoulder belt positioning clip when used as a back-less booster. Ensure the belt webbing is not twisted.
- **DO TAKE CARE** to locate and install the booster seat so that it is not liable to become trapped by a moveable seat or in a door of the vehicle.

- **FAILURE TO PROPERLY USE THIS BOOSTER SEAT INCREASES THE RISK OF SERIOUS INJURY OR DEATH IN A SHARP TURN, SUDDEN STOP OR CRASH.** Your child can be injured in a vehicle even if you are not in a crash. Sudden braking and sharp turns can injure your child if the booster seat is not properly installed or if your child is not properly secured in the booster seat.
- **DO NOT** use another manufacturer's seat cover with this booster seat. See your retailer for Graco replacement parts only.
- **DO NOT USE** in any configuration not shown in the instructions.
- **DO NOT** use alternative load-bearing points not shown in these instructions.
- According to accident statistics, **CHILDREN ARE SAFER WHEN PROPERLY RESTRAINED IN REAR VEHICLE SEATING POSITIONS, RATHER THAN FRONT SEATING POSITIONS.** For a vehicle with a front passenger air bag, refer to your vehicle owner's manual as well as these instructions for booster seat installation.
- **NEVER LEAVE YOUR CHILD UNATTENDED.**

- **NEVER LEAVE A BOOSTER SEAT UNSECURED IN YOUR VEHICLE.** An unsecured booster seat can be thrown around and may injure occupants in a sharp turn, sudden stop or crash. Remove it or make sure that it is securely belted in the vehicle.
- **NEVER LEAVE LUGGAGE** or other objects unsecured in a vehicle, they are liable to cause injuries in the event of a collision.
- **REPLACE THE BOOSTER SEAT AFTER AN ACCIDENT OF ANY KIND.** An accident can cause damage to the booster seat that you cannot see.
- **DO NOT MODIFY YOUR BOOSTER SEAT** or use any accessories or parts supplied by other manufacturers.
- **NEVER USE BOOSTER SEAT IF IT HAS DAMAGED OR MISSING PARTS.** DO NOT use a cut, frayed or damaged vehicle seat belt.
- **THE BOOSTER SEAT CAN BECOME VERY HOT IF LEFT IN THE SUN.** Contact with these parts can burn your child's skin. Always touch the surface of any metal or plastic parts before putting your child in the booster seat.
- **NEVER GIVE THIS BOOSTER SEAT** to someone else without also giving them this manual.

- **NEVER USE A SECOND-HAND BOOSTER SEAT** or a booster seat whose history you do not know.
- **NEVER USE THIS BOOSTER SEAT** without the armrests attached to the base.

Adjusting the Armrests

Step 1.

To adjust armrests, remove screw and press in button on side of base as shown to raise or lower ① / ② . Reinsert screw and tighten.

CHECK to make sure armrests are securely attached by pulling up on them.

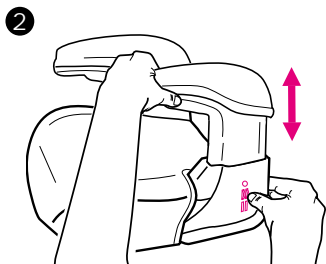
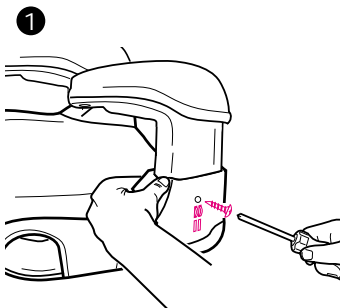

Step 2.

Slip armrest covers
(on certain models)
onto armrests as shown.

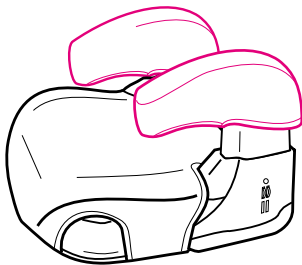

Step 3.

Your Graco booster seat
is now ready to use. See
page 30, “Securing
Child in Vehicle with
Shoulder Belt
Positioning Clip”.

FOR MODELS with a
back support continue
on to **Step 4.**

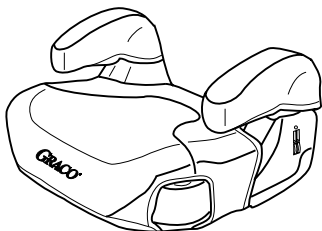

Assembling the Back Support (on certain models)

Step 4.

Flip head support and lower back support over as shown ①.

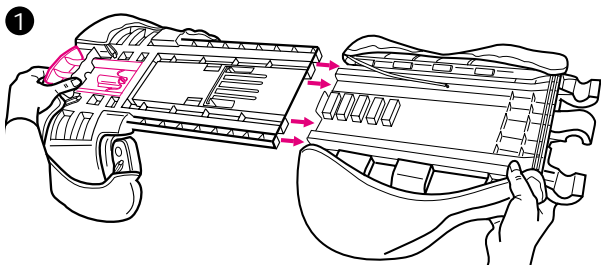

Step 5.

Squeeze red adjustment button and slide two pieces together until they snap into place ②.

CHECK to make sure two pieces are securely snapped together by pulling on them.

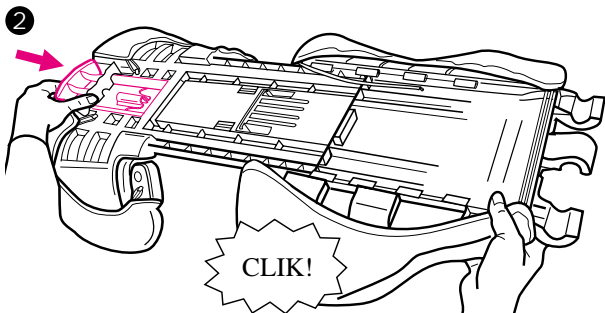

Step 6.

Attach elastic strap as shown ③.

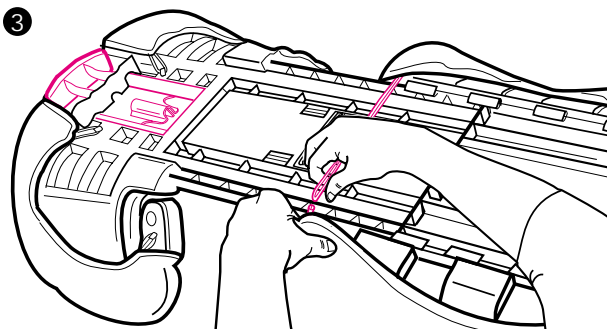

Step 7.

Flip seat over and insert the fabric from the head support underneath the fabric on the lower back support as shown ④.

To make insertion of fabric easier, slide the upper and lower back pieces apart by squeezing the red adjustment button.

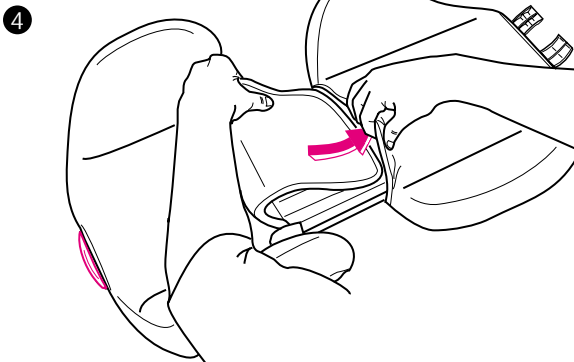

Step 8.

Attach backrest to base. “U”-shaped hooks on bottom of backrest will interlock with bars on base **5**.

Make sure that no part of the seat covering interferes when attaching backrest to the base.

5

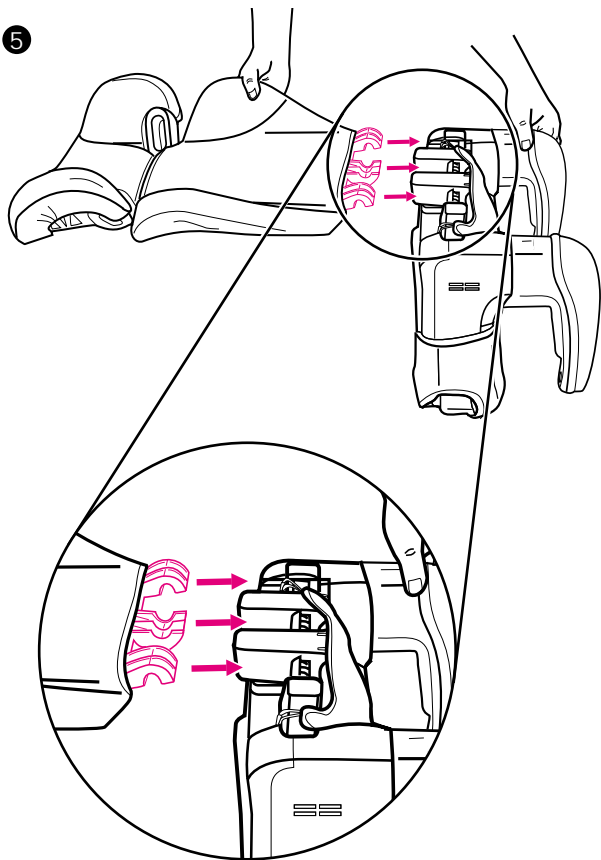

Step 9.

Once backrest is securely attached to the base, push backrest up as shown ⑥.

⑥

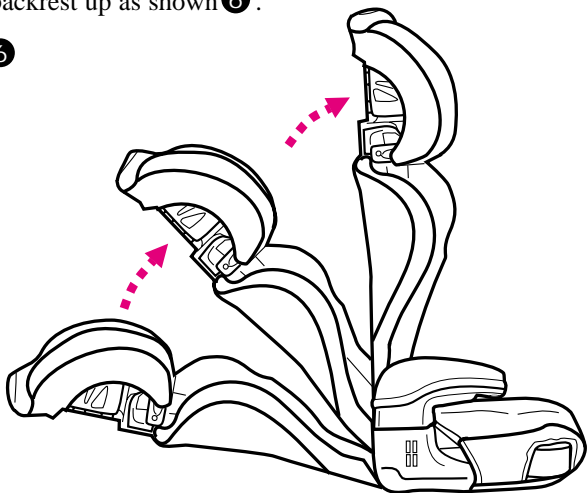

Step 10.

Your Graco booster seat is now ready to use.

See page 21-28, “Using your Graco Booster Seat” and “Securing Your Child in Vehicle”.

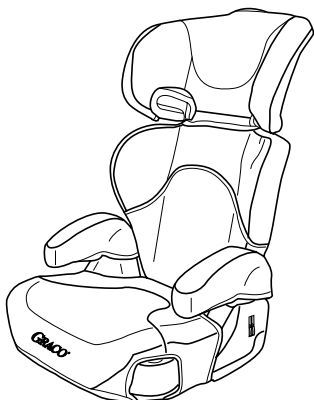

Weight and Height Limits

⚠ WARNING

FAILURE TO USE booster seat in a manner appropriate for your child's size may increase the risk of serious injury or death.

To use this Graco booster seat, your child **MUST** meet **ALL** of the following requirements:

With back support (approximately 3 to 10 years old) :

- weigh between 15-36 kg, and
- are between 96 and 145 cm in height, and
- the shoulder belt **MUST** lay across child's shoulders in red zone as shown in ① and the lap portion is positioned low on the child's hips, and
- the child's ears are below top of booster seat. If tops of ears are above top of seat, your child is too large for the booster seat

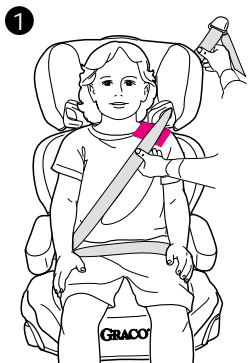

**Without back support
(approximately 4 to 10 years old) :**

- weigh between 15-36 kg, and
- are between 101 and 145 cm in height, and
- the shoulder belt **MUST** lay across child's shoulders in red zone as shown in ② and the lap portion is positioned low on the child's hips, and
- when sitting on the booster seat, your child's ears are below the top of the vehicle seat cushion / head rest.

Your Graco booster seat can be used with or without the back support (on certain models) as long as the above requirements are met.

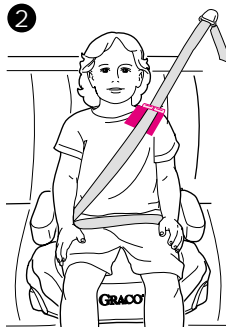

Vehicle Seat Location Requirements

⚠ WARNING

IMPROPER PLACEMENT OF THE BOOSTER SEAT INCREASES THE RISK OF SERIOUS INJURY OR DEATH. Some seating positions in your vehicle may **NOT** be safe for this booster seat. Some vehicles do not have any seating positions that can be used safely with the booster seat. If you are not sure where to place the booster seat in your vehicle, consult your vehicle owner's manual.

- **Children are safer when properly restrained in rear vehicle seating positions.** Whenever possible secure the Graco booster seat in the center position of the seat directly behind the front seats. However, this position is often equipped with a lap belt only and cannot be used.



- The vehicle seat **MUST** face forward.

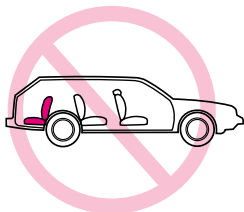

Vehicle Seat Belt Requirements

⚠ WARNING

MANY SEAT BELT SYSTEMS ARE NOT SAFE TO USE WITH THE BOOSTER SEAT.

Pay careful attention to these systems; some of the seat belts that are **NOT** safe to use look very much like seat belts that are safe to use. If you are unsure, consult your vehicle owner's manual.

SAFE Vehicle Seat Belt System

ONLY A LAP/SHOULDER BELT SYSTEM CAN BE USED WITH THIS BOOSTER SEAT, IF

the seat location meets all other requirements of these instructions and those in your vehicle owner's manual.

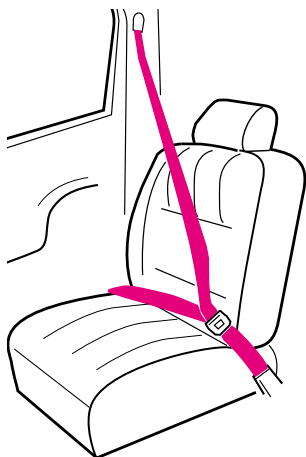

UNSAFE Vehicle Seat Belt Systems

DO NOT USE ANY OF THE FOLLOWING VEHICLE BELT SYSTEMS.

- **NEVER** use a lap-only belt.
- **NEVER** use a **Passive Restraint - Lap or Shoulder Belt Mounted on Door**

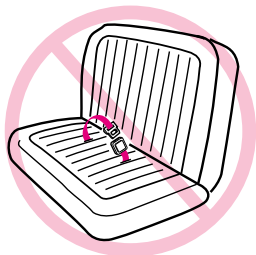

Using your Graco Booster Seat

⚠️ WARNING

FAILURE TO PROPERLY SECURE YOUR CHILD AND THE BOOSTER SEAT IN YOUR VEHICLE INCREASES THE RISK OF SERIOUS INJURY OR DEATH IN THE EVENT OF A SHARP TURN, SUDDEN STOP OR CRASH.

Use only the vehicle's lap and shoulder belt system when restraining the child in this booster seat ❶.



NEVER use a vehicle lap-only belt across front of child ❷.

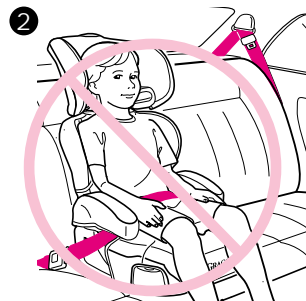

⚠ WARNING

Vehicle belts **MUST** lay flat against child and **MUST** not be twisted.

DO NOT use shoulder belt loose or positioned under child's arm ③ .

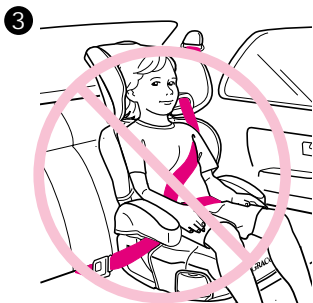

DO NOT position vehicle belt over top of the armrests ④ . It must pass underneath the armrests.

Make sure vehicle belt is NOT twisted.

Lap/shoulder belt MUST be low and snug on hips, just touching thighs.

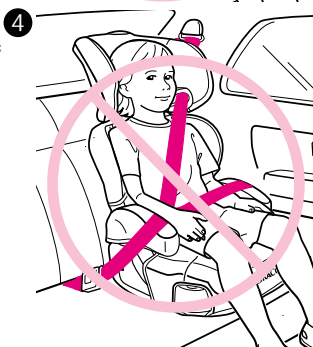

DO NOT allow child to slide down in booster seat ⑤ .

If child will not keep vehicle restraint properly positioned, **DO NOT** use this booster seat. Use a different child restraint system.

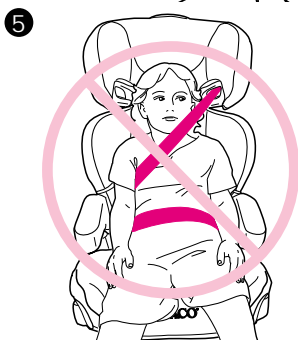

WARNING

Vehicle seat headrest must not interfere with booster seat head support. The front of booster seat **MUST NOT** hang over front of vehicle seat **6**.

6

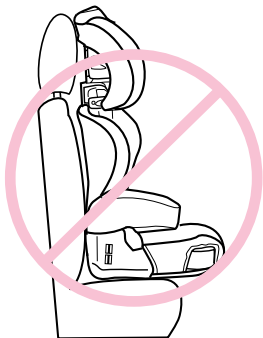

The back of the booster seat **MUST** fit tight against the vehicle seat back as shown **7**.

7

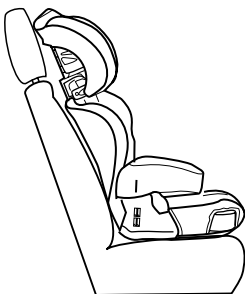

Booster Seat Positions

Your booster seat has two positions as shown.

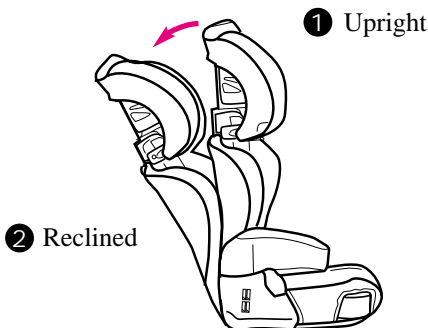

The back of the booster seat **MUST** fit tight against the vehicle seat back as shown in ③ in either the first or second position.



DO NOT USE booster seat beyond reclined position ②.

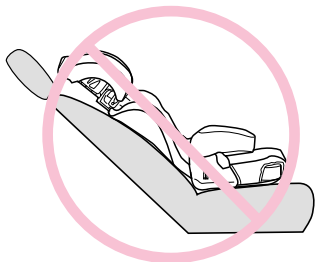

Securing Your Child in Vehicle

1. Place booster seat firmly against the back of a forward-facing vehicle seat equipped with a lap/shoulder belt only ①.
2. Have your child sit in booster seat with their back flat against back of booster seat.

①

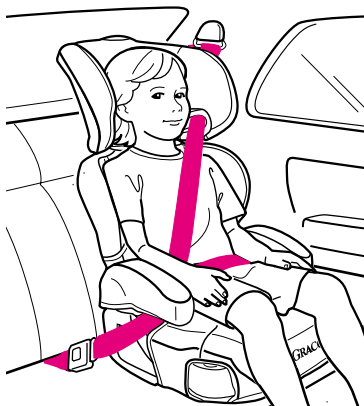

3. **Position shoulder belt through the shoulder belt guide shown in ②, NOT as shown in ③.** Fasten buckle and pull up on the shoulder belt to tighten.

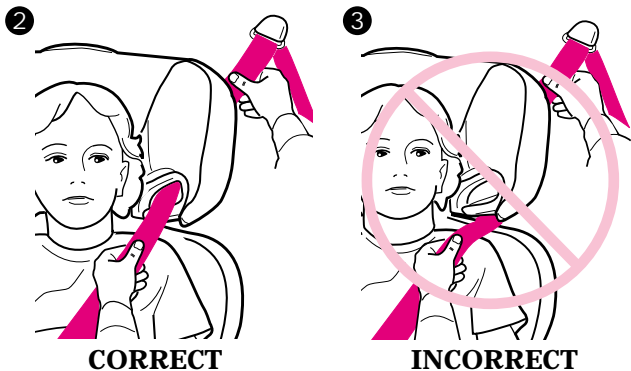

CORRECT

INCORRECT

4. To ensure the correct head support height is obtained, the bottom of the headrest **MUST** be even with the top of child's shoulders as shown in ④ and the shoulder belt must be positioned in the red zone as shown in ⑤ .



The lap belt portion MUST pass under the armrests and be positioned low on the hips.

Belt MUST NOT be twisted.



5. If the belt lays across child's neck, head or face **6**, readjust head support height.

Follow instructions on page 29, "Adjusting the Head Support".

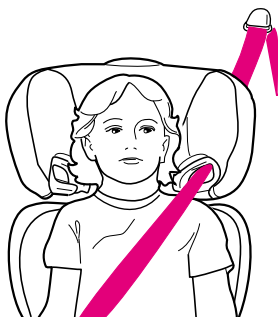

CORRECT

6

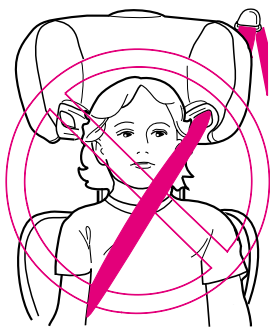

INCORRECT

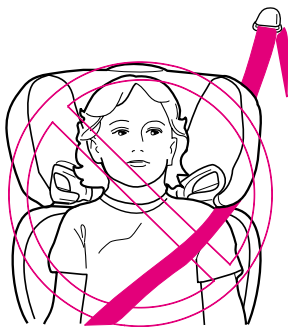

INCORRECT

Adjusting the Head Support

BEFORE adjusting the head support height, have your child lean forward slightly.

Squeeze the red adjustment button on top of seat and pull back support up until it snaps into one of the 6 height positions.

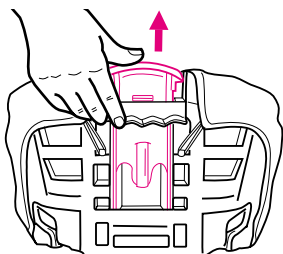

Back of seat

To lower, squeeze red adjustment button and push down.

CHECK to make sure it is securely snapped into one of the 6 height positions by pulling up on head support.

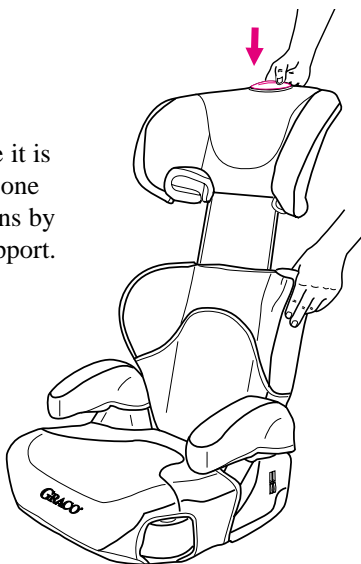

Securing Child in Vehicle with Shoulder Belt Positioning Clip

The shoulder belt **MUST** lay across child's shoulders in red zone as shown.

If shoulder belt lays outside this zone, the shoulder belt positioning clip **MUST** be used.

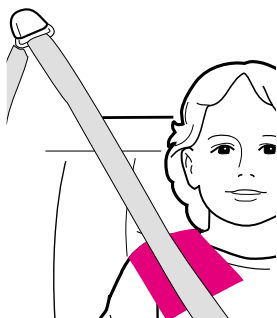

To attach clip to booster seat:

1. Insert the loop end of strap around vertical bar on rear of seat as shown in ①. The shoulder belt positioning clip **MUST** be attached onto the vertical bar of the base farthest from where the vehicle shoulder belt lays across the child.

①

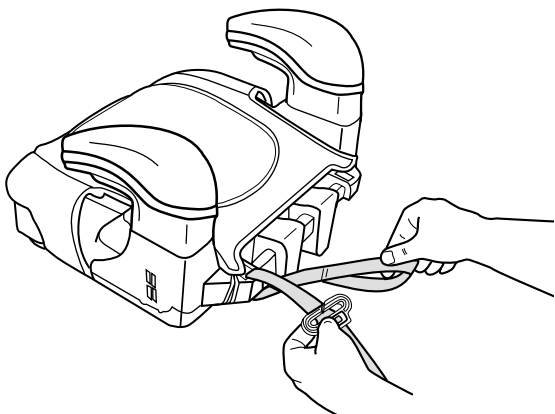

2. Pass the clip and strap through the loop end as shown in ② and pull strap up ③.

NOTE: Free end of strap should face front of seat.

②

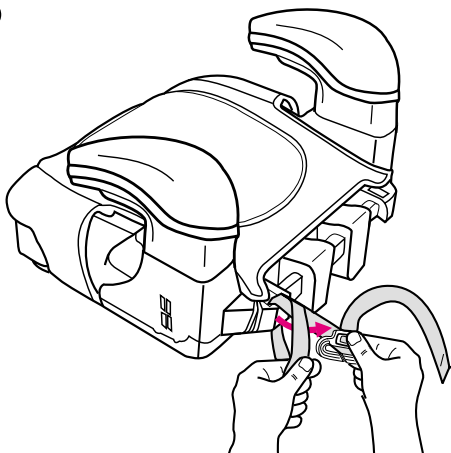

③

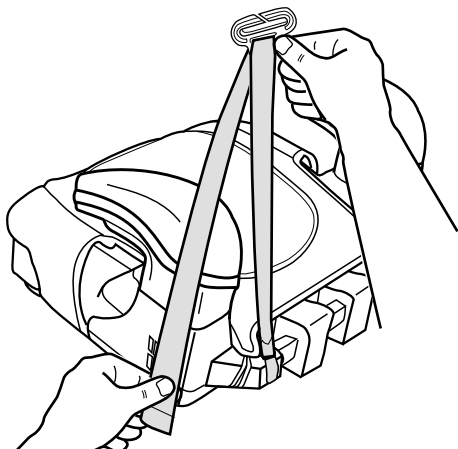

3. Slide the vehicle shoulder belt onto the clip as shown in 4 and pull strap down to tighten clip against child's shoulder.

The lap belt portion MUST pass under the armrests and be positioned low on the hips.

The belt MUST NOT be twisted.

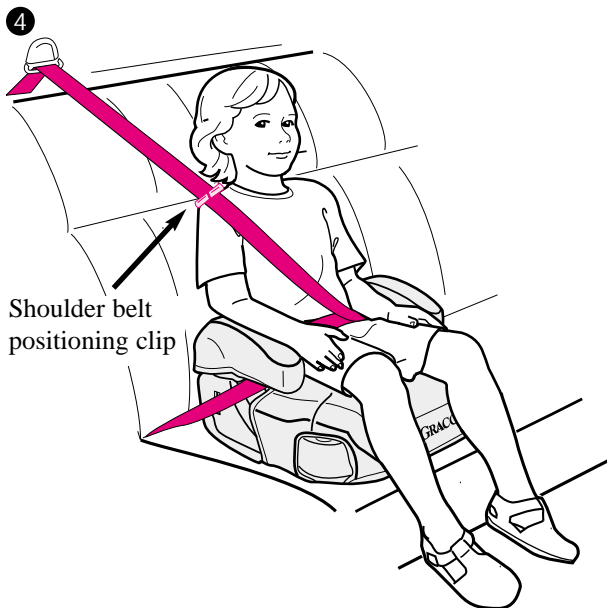

Rear view of child sitting in seat

5

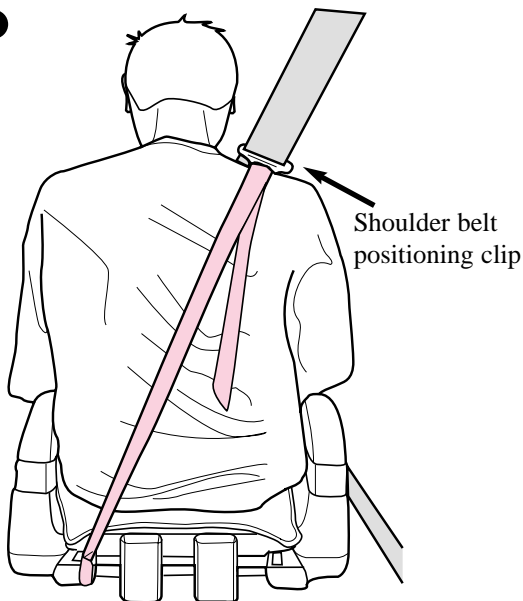

4. For warnings on vehicle belt positions, see page 21-23, “Using your Graco Booster Seat”.

Additional Information

Airplane Use

This restraint is **NOT** certified for use in an aircraft because there are no shoulder belts available in an aircraft.

Cupholders

To avoid burns, **NEVER** put hot liquids in your cupholders.

Cupholders are included on both sides of the seat.

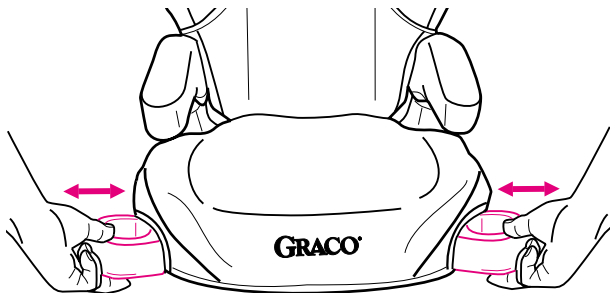

Instruction Sheet Storage

Choose the booklet with your language and store it on the bottom of the seat as shown.

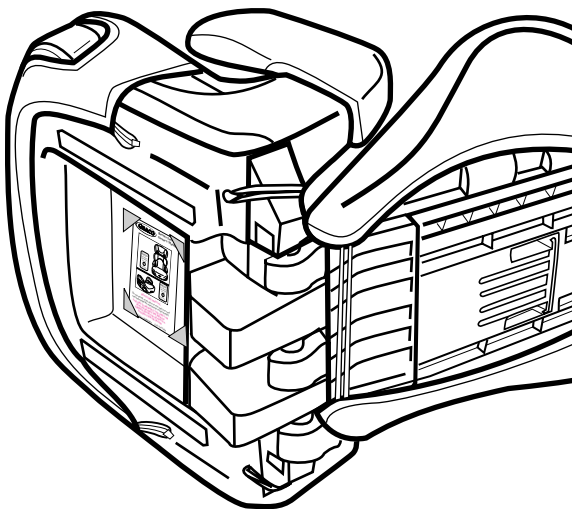

Care and Maintenance

- **CONTINUOUS USE OF BOOSTER SEAT MAY CAUSE DAMAGE TO VEHICLE SEAT.** Use a towel or thin blanket to protect upholstery.
- **METAL AND PLASTIC PARTS:** clean with mild soap and cool water. No bleach or detergents.
- **FROM TIME TO TIME CHECK YOUR BOOSTER SEAT** for worn parts, torn material and stitching. If damage is found, **DO NOT** try to modify the booster seat. Replace the booster seat.
- **DO NOT USE BOOSTER SEAT** without its cover.

To Remove Seat Cover

1. Remove elastic loops and hooks from seat as shown **1**.

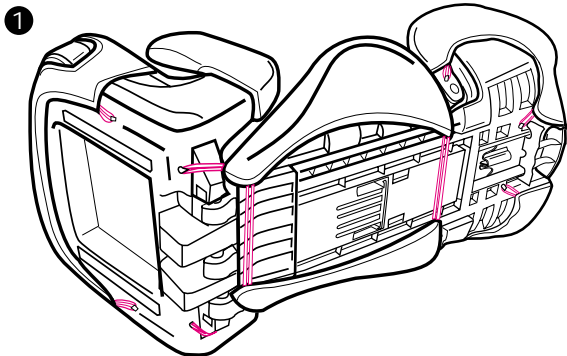

On some models, there is a plastic clip **2** in the front of the seat pad on the base that will need to be removed before washing.

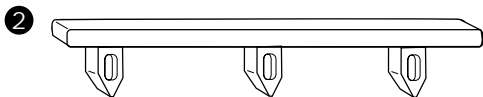

2. Machine wash cover in cold water on delicate cycle and drip-dry. **DO NOT USE BLEACH.**
3. To put the seat cover back on, reverse preceding instructions.

NOTICE: 1. This is a "Universal" child restraint. It is approved to Regulation No. 44, 03 series of amendments, for general use in vehicles and it will fit most, but not all, car seats. **2.** A correct fit is likely if the vehicle manufacturer has declared in the vehicle handbook that the vehicle is capable of accepting a "Universal" child restraint for this age group. **3.** This child restraint has been classified as "Universal" under more stringent conditions than those which applied to earlier designs which do not carry this notice. **4.** If in doubt, consult either the child restraint manufacturer or the retailer. Only suitable if the approved vehicles are fitted with 3 point with retractor safety belts, approved to UN/ECE Regulation No. 16 or other equivalent standards. **DO NOT USE THIS CAR SEAT ON ANY VEHICLE SEAT WHERE AN AIRBAG IS FITTED.**

NOTE POUR L'UTILISATEUR : 1. Ceci est un dispositif de retenue pour enfants de la catégorie " Universel " . Il est homologué conformément au Règlement N° 44.03 pour usage général sur les véhicules et peut être adapté à la plupart des sièges de véhicules. **2.** Ce dispositif peut être correctement monté sur le véhicule si le constructeur de celui-ci spécifie, dans son manuel, que le véhicule peut recevoir des dispositifs de retenue pour enfants de la catégorie " Universel " pour ce groupe d'âge. **3.** Ce dispositif de retenue pour enfants a été classé comme " universel " en suivant des prescriptions plus rigoureuses que celles qui étaient appliquées aux modèles antérieurs qui ne portent pas cette étiquette. **4.** En cas de doute, consulter le fabricant ou le revendeur du dispositif de retenue pour enfants. " Ce dispositif est utilisable, seulement sur les véhicules équipés de ceintures de sécurité à trois points, à enrouleur, homologués conformément au Règlement N° 16 de la CEE ou d'une norme équivalente. " **NE PAS UTILISER A UNE PLACE EQUIPEE D'UN COUSSIN D'AIR DE SECURITE (AIRBAG)**

HINWEIS: 1. Dieser Sitz ist ein "Universal"-Rückhaltesystem für Kinder. Er ist nach der ECE-Regelung Nr. 44/03 für den allgemeinen Gebrauch in Fahrzeugen zugelassen und passt auf die meisten, jedoch nicht auf alle, Autositze. **2.** Eine passgenaue Montage ist in den Kraftfahrzeugen wahrscheinlich, die laut der Fahrzeugbedienungsanleitung für die Installation eines "Universal"-Kinderrückhaltesystems für diese Altersgruppe geeignet sind. **3.** Dieses Kinderrückhaltesystem wurde unter strengeren Bedingungen als vorhergehende Modelle als "Universal" klassifiziert. Die vorhergehenden Modell tragen diesen Hinweis nicht. **4.** Im Zweifelsfall wenden Sie sich bitte an den Hersteller des Kinderrückhaltesystems oder an Ihren Fachhändler. Zur Eignung müssen die zugelassenen Fahrzeuge mit einem Dreipunkt-System mit Retraktor-Sicherheitsgurten gemäß der ECE-Regelung Nr. 16 oder anderen vergleichbaren Normen ausgestattet sein. **VERWENDEN SIE DIESEN KINDERAUTOSITZ NIEMALS AUF FAHRZEUGSITZEN, BEI DENEN EIN AIRBAG EINGEBAUT IST.**

LET OP: 1. Dit is een "Universele" kinderbeveiliging. Het is goedgekeurd volgens Richtlijn No. 44, 03 serie, voor algemeen gebruik in voertuigen en past in de meeste, maar niet alle auto's. **2.** Goed passen is waarschijnlijk als de autoproducent in zijn gebruiksaanwijzing stelt dat het voertuig geschikt is om "Universele" autostoeltjes te gebruiken voor deze leeftijdsgroep. **3.** Deze kinderbeveiliging is geclassificeerd als "Universeel" onder strengere omstandigheden dan die bij eerdere ontwerpen gebruikt werden. **4.** Raadpleeg bij twijfel altijd de leverancier van uw autostoel of auto. Gebruik het alleen als de auto is uitgerust met 3-punts-gordels met gordelspanners, goedgekeurd volgens UN/ECE Richtlijn No. 16 of andere gelijkwaardige standaards. **GEBRUIK DEZE AUTOSTOEL NIET OP EEN ZITPLAATS DIE IS UITGERUST MET EEN AIRBAG.**



Free Manuals Download Website

<http://myh66.com>

<http://usermanuals.us>

<http://www.somanuals.com>

<http://www.4manuals.cc>

<http://www.manual-lib.com>

<http://www.404manual.com>

<http://www.luxmanual.com>

<http://aubethermostatmanual.com>

Golf course search by state

<http://golfingnear.com>

Email search by domain

<http://emailbydomain.com>

Auto manuals search

<http://auto.somanuals.com>

TV manuals search

<http://tv.somanuals.com>