

2-Quart (1.9 Liter) Pressure Cup

312111A

For controlling atomizing air and fluid pressure for any pressure feed manual spray gun when more than one quart of fluid will be used.

288776

50 psi (0.35 MPa, 3.5 bar) Maximum Regulated Fluid Pressure

50 psi (0.35 MPa, 3.5 bar) Maximum Air Inlet Pressure



Important Safety Instructions

Read all warnings and instructions in this manual.
Save these instructions.

This manual is available in the following languages.

English	312111
Spanish	312112
French	312113
German	312114
Italian	312115

Contents



Warnings	2
Description	3
Set-Up	4
Operation	5
Maintenance	6
Troubleshooting	6
Parts	8
Technical Data	9
Graco Standard Warranty	10
Graco Information	10







PROVEN QUALITY. LEADING TECHNOLOGY.

Warnings

The following warnings are for the setup, use, grounding, maintenance, and repair of this equipment. The exclamation point symbol alerts you to a general warning and the hazard symbol refers to procedure-specific risk. Refer back to these warnings. Additional, product-specific warnings may be found throughout the body of this manual where applicable.



 WARNING	
	<p>FIRE AND EXPLOSION HAZARD</p> <p>Flammable fumes, such as solvent and paint fumes, in work area can ignite or explode. To help prevent fire and explosion:</p> <ul style="list-style-type: none"> • Use equipment only in well ventilated area. • Eliminate all ignition sources; such as pilot lights, cigarettes, portable electric lamps, and plastic drop cloths (potential static arc). • Keep work area free of debris, including solvent, rags and gasoline. • Do not plug or unplug power cords or turn lights on or off when flammable fumes are present. • Ground all equipment in the work area. See Grounding instructions. • If there is static sparking or you feel a shock, stop operation immediately. Do not use equipment until you identify and correct the problem. • Keep a working fire extinguisher in the work area.
	<p>EQUIPMENT MISUSE HAZARD</p> <p>Misuse can cause death or serious injury.</p> <ul style="list-style-type: none"> • Do not operate the unit when fatigued or under the influence of drugs or alcohol. • Do not exceed the maximum working pressure or temperature rating of the lowest rated system component. See Technical Data in all equipment manuals. • Use fluids and solvents that are compatible with equipment wetted parts. See Technical Data in all equipment manuals. Read fluid and solvent manufacturer's warnings. For complete information about your material, request MSDS forms from distributor or retailer. • Check equipment daily. Repair or replace worn or damaged parts immediately with genuine manufacturer's replacement parts only. • Do not alter or modify equipment. • Use equipment only for its intended purpose. Call your distributor for information. • Route hoses and cables away from traffic areas, sharp edges, moving parts, and hot surfaces. • Do not kink or over bend hoses or use hoses to pull equipment. • Keep children and animals away from work area. • Comply with all applicable safety regulations.

 **WARNING**

	<p>PRESSURIZED EQUIPMENT HAZARD</p> <p>Fluid from the gun/dispense valve, leaks, or ruptured components can splash in the eyes or on skin and cause serious injury.</p> <ul style="list-style-type: none"> • Follow Pressure Relief Procedure in this manual, when you stop spraying and before cleaning, checking, or servicing equipment. • Tighten all fluid connections before operating the equipment. • Check hoses, tubes, and couplings daily. Replace worn or damaged parts immediately.
	<p>TOXIC FLUID OR FUMES HAZARD</p> <p>Toxic fluids or fumes can cause serious injury or death if splashed in the eyes or on skin, inhaled, or swallowed.</p> <ul style="list-style-type: none"> • Read MSDS's to know the specific hazards of the fluids you are using. • Store hazardous fluid in approved containers, and dispose of it according to applicable guidelines. • Always wear impervious gloves when spraying or cleaning equipment.
	<p>PRESSURIZED ALUMINUM PARTS HAZARD</p> <p>Do not use 1,1,1-trichloroethane, methylene chloride, other halogenated hydrocarbon solvents or fluids containing such solvents in pressurized aluminum equipment. Such use can cause serious chemical reaction and equipment rupture, and result in death, serious injury, and property damage.</p>
	<p>PERSONAL PROTECTIVE EQUIPMENT</p> <p>You must wear appropriate protective equipment when operating, servicing, or when in the operating area of the equipment to help protect you from serious injury, including eye injury, inhalation of toxic fumes, burns, and hearing loss. This equipment includes but is not limited to:</p> <ul style="list-style-type: none"> • Protective eyewear • Clothing and respirator as recommended by the fluid and solvent manufacturer • Gloves • Hearing protection

Description

The Model 288776 2-quart (1.9-liter) pressure cup is designed to be used with any pressure feed manual spray gun when more than 1 quart of fluid will be used. Pressure cups provide a better degree of control over atomizing air and fluid pressure than siphon feed equipment. The Model 288776 enables you to spray a wider range of refinish materials and has a full 2-quart (1.9 liter) capacity when needed. The regulator assembly controls pressure of fluid in the cup from 0-50 psi (0.35 MPa, 3.5 bar). The manual pressure relief valve allows air pressure to bleed from cup.

						
<p>Never tamper with the automatic pressure relief valve (6b). The automatic relief valve limits the maximum air pressure entering the cup. If the relief valve does not work properly, over-pressurization may occur and cause the cup to rupture or explode. Air pressure in the cup must never exceed 50 psi (0.35 MPa, 3.5 bar).</p>						

Set-Up

					
<p>Always disconnect cup assembly from air supply and relieve pressure in cup (open manual relief valve counter-clockwise) before installing or removing canister from lid assembly.</p>					

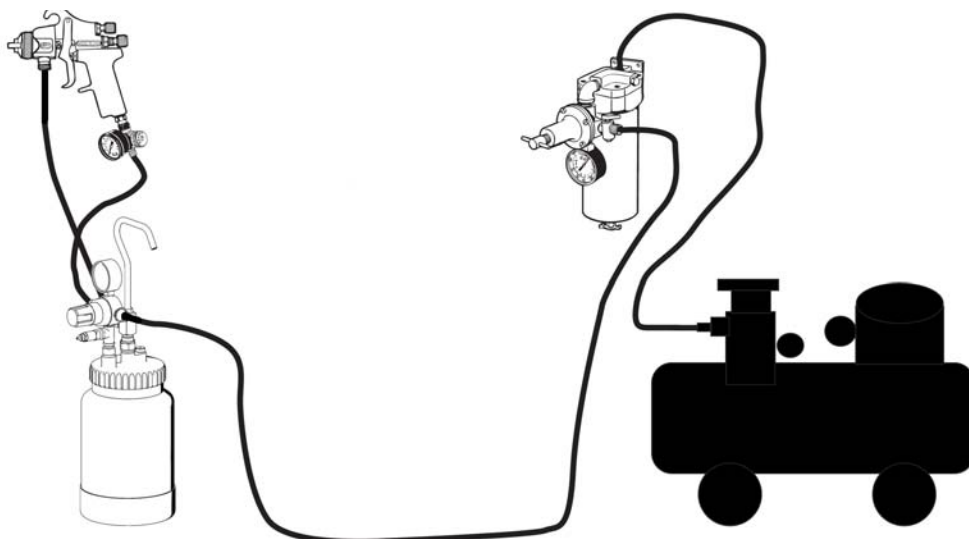

1. Connect air hose to air inlet of gun and to air outlet on cup regulator as shown.

2. Connect fluid hose to fluid inlet of gun and to cup fluid outlet as shown.
3. Connect handle to top of cup as shown.
4. It is best for the air supply line to pass through a Graco Air Control Unit to filter dirt from the air and extract water and oil. Connect the air supply hose to the air inlet fitting on cup regulator.



Note: Follow the manufacturer's directions for the mixing and preparation of material. Strain material using a fine mesh screen to prevent the entry of foreign matter and the clogging of fluid passageways.

Operation

						
---	---	--	--	--	--	--

Always disconnect cup assembly from air supply and relieve pressure in cup (open manual pressure relief valve counter-clockwise) before installing or removing canister from lid assembly.

1. Pull out regulator knob and turn fully counter-clockwise. Open manual pressure relief valve on cup lid (counter-clockwise).
2. Open lid and fill cup with desired sprayable material.
3. Close lid and seal by turning clockwise hand-tight.
4. Close relief valve on cup lid hand-tight turning clockwise.
5. Set wall-mounted regulator (not supplied) to desired air pressure. (This is your atomizing air.)
6. Slowly turn the cup regulator knob clockwise while pulling the gun trigger fully back. Continue clockwise until desired flow is achieved. Push in regulator knob to lock. **Maximum cup pressure is 50 psi (0.35 MPa, 3.5 bar).**

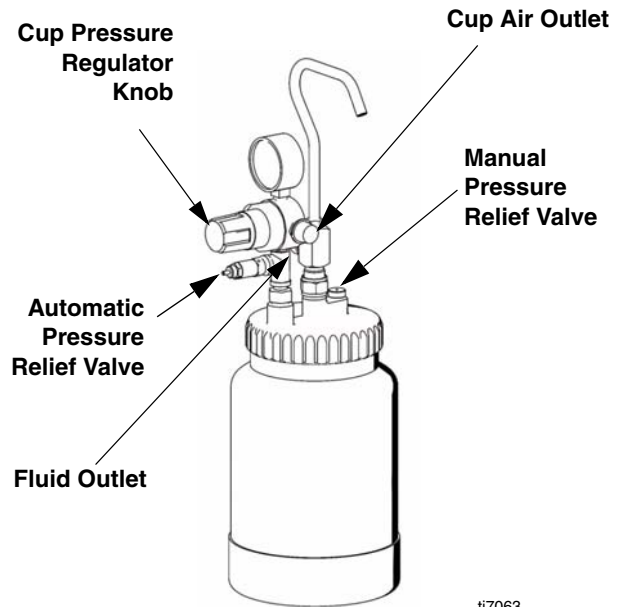

7. To decrease paint flow, pull out regulator knob and turn counter-clockwise to lower cup pressure. Open the relief valve to bleed off excess pressure. Reseal relief valve. Repeat step 6. The cup lid has a check valve that prevents the cup from losing pressure until the relief valve is opened.
8. Atomizing air for the spray gun can be adjusted at the gun by means of an air adjusting valve on the spray gun.

 Note: To achieve desired cup pressure you must always start at a lower pressure and adjust up to the desired setting.



ti7063

Maintenance

						
<p>Paint can erupt from the cup due to rapid depressurization. Never open the cup prior to turning cup pressure regulator knob to the full “off” position (counter-clockwise) and relieving cup pressure by opening (counter-clockwise) manual pressure relief valve.</p>						

1. After relieving cup pressure and turning cup pressure regulator to the full “off” position (counter-clockwise), open cup lid by turning counter-clockwise.
2. Pour out any remaining material and add a compatible solvent.

3. Repeat steps 3, 4, and 6 in **Operation** on page 5 and spray until clean solvent appears. Cup and gun material passages should be clean now.
4. Depressurize cup (See **Operation**, step 1) and empty remaining solvent from cup and wipe clean with a solvent soaked cloth.

CAUTION

Never clean your Model 288776 in a gun washer. The automatic pressure relief valve, regulator body, and gauge will be damaged by use in a gun washer. The canister only can be cleaned in a gun washer.

Troubleshooting

Problem	Cause	Solution
Excess pressure in cup.	Leak at regulator valve assembly.	Replace.
	Gauge registering incorrectly.	Replace.
	Automatic relief valve setting too high.	Replace.
	Valve spring broken or distorted.	Replace.
	Diaphragm damaged.	Replace.
Insufficient pressure in cup.	Check valve stuck shut.	Clean or Replace.
	Automatic relief valve setting too low.	Replace.
	Gauge registering incorrectly.	Replace.
	Leak at cup lid threads.	Tighten cup or replace gasket.
	Manual pressure relief valve partially open.	Tighten.

Parts

**Fluid Pressure Regulator
Part Number 234434**

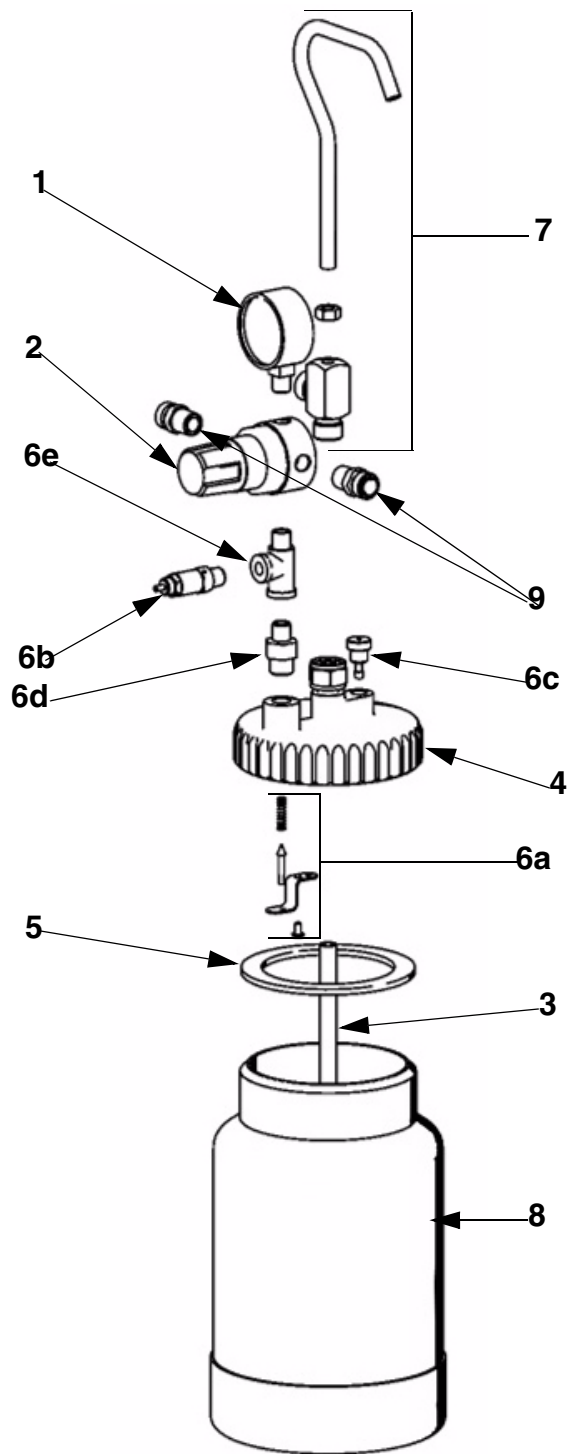
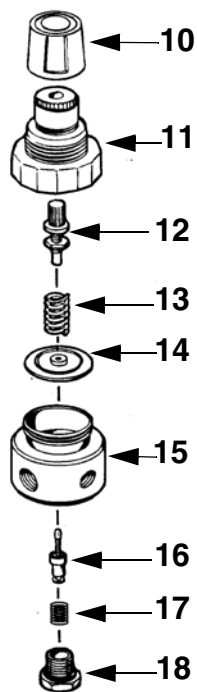

Model 288776

Ref. No.	Part No.	Description	Qty.
1	104655	GAUGE, fluid pressure	1
2	234434	REGULATOR, fluid pressure	1
3	288777	TUBE, fluid	1
4	288799	LID, cup	1
5	288800	GASKET, lid	5
6	288801	VALVE/FITTING KIT	1
6a		CHECK VALVE ASSEMBLY	1
6b		VALVE, pressure relief, automatic	1
6c		VALVE, pressure relief, manual	1
6d		FITTING, INLET	1
6e		FITTING, tee	1
7	288837	CUP, handle, nut, and fluid outlet	1
8	288836	CANISTER, 2-Quart	1
9	288778	NIPPLE, 1/4 npt	1
10		ADJUSTING KNOB	1
11		CAGE, spring	1
12		SCREW, adjusting, assembly	1
13		SPRING, top	1
14		DIAPHRAGM, assembly	1
15		BODY	1
16		VALVE ASSEMBLY, inner	1
17		SPRING, valve	1
18		PLUG, bottom and o-ring assembly	1
19▲		TAGS, warning (not shown)	

▲ Replacement Danger and Warning labels, tags, and cards are available at no cost.

Technical Data

Maximum regulated cup pressure (fluid pressure)	50 psi (0.35 MPa, 3.5 bar)
Maximum air inlet pressure	50 psi (0.35 MPa, 3.5 bar)
Automatic pressure relief valve release	40 psi (0.28 MPa, 2.8 bar)
Weight (empty)	3.2 lbs (1.5 kg)
Hose connections.	Air 1/4 in. nps (m) Fluid 3/8 in. nps (m)
Wetted parts.	Aluminum, polyethylene foam

Graco Standard Warranty

Graco warrants all equipment referenced in this document which is manufactured by Graco and bearing its name to be free from defects in material and workmanship on the date of sale to the original purchaser for use. With the exception of any special, extended, or limited warranty published by Graco, Graco will, for a period of twelve months from the date of sale, repair or replace any part of the equipment determined by Graco to be defective. This warranty applies only when the equipment is installed, operated and maintained in accordance with Graco's written recommendations.

This warranty does not cover, and Graco shall not be liable for general wear and tear, or any malfunction, damage or wear caused by faulty installation, misapplication, abrasion, corrosion, inadequate or improper maintenance, negligence, accident, tampering, or substitution of non-Graco component parts. Nor shall Graco be liable for malfunction, damage or wear caused by the incompatibility of Graco equipment with structures, accessories, equipment or materials not supplied by Graco, or the improper design, manufacture, installation, operation or maintenance of structures, accessories, equipment or materials not supplied by Graco.

This warranty is conditioned upon the prepaid return of the equipment claimed to be defective to an authorized Graco distributor for verification of the claimed defect. If the claimed defect is verified, Graco will repair or replace free of charge any defective parts. The equipment will be returned to the original purchaser transportation prepaid. If inspection of the equipment does not disclose any defect in material or workmanship, repairs will be made at a reasonable charge, which charges may include the costs of parts, labor, and transportation.

THIS WARRANTY IS EXCLUSIVE, AND IS IN LIEU OF ANY OTHER WARRANTIES, EXPRESS OR IMPLIED, INCLUDING BUT NOT LIMITED TO WARRANTY OF MERCHANTABILITY OR WARRANTY OF FITNESS FOR A PARTICULAR PURPOSE.

Graco's sole obligation and buyer's sole remedy for any breach of warranty shall be as set forth above. The buyer agrees that no other remedy (including, but not limited to, incidental or consequential damages for lost profits, lost sales, injury to person or property, or any other incidental or consequential loss) shall be available. Any action for breach of warranty must be brought within two (2) years of the date of sale.

GRACO MAKES NO WARRANTY, AND DISCLAIMS ALL IMPLIED WARRANTIES OF MERCHANTABILITY AND FITNESS FOR A PARTICULAR PURPOSE, IN CONNECTION WITH ACCESSORIES, EQUIPMENT, MATERIALS OR COMPONENTS SOLD BUT NOT MANUFACTURED BY GRACO. These items sold, but not manufactured by Graco (such as electric motors, switches, hose, etc.), are subject to the warranty, if any, of their manufacturer. Graco will provide purchaser with reasonable assistance in making any claim for breach of these warranties.

In no event will Graco be liable for indirect, incidental, special or consequential damages resulting from Graco supplying equipment hereunder, or the furnishing, performance, or use of any products or other goods sold hereto, whether due to a breach of contract, breach of warranty, the negligence of Graco, or otherwise.

FOR GRACO CANADA CUSTOMERS

The Parties acknowledge that they have required that the present document, as well as all documents, notices and legal proceedings entered into, given or instituted pursuant hereto or relating directly or indirectly hereto, be drawn up in English. Les parties reconnaissent avoir convenu que la rédaction du présente document sera en Anglais, ainsi que tous documents, avis et procédures judiciaires exécutés, donnés ou intentés, à la suite de ou en rapport, directement ou indirectement, avec les procédures concernées.

Graco Information

***TO PLACE AN ORDER, contact your Graco distributor or call to identify the nearest distributor.
Phone: 612-623-6921 or Toll Free: 1-800-328-0211 Fax: 612-378-3505***

*All written and visual data contained in this document reflects the latest product information available at the time of publication.
Graco reserves the right to make changes at any time without notice.*

This manual contains English. MM 312111

Graco Headquarters: Minneapolis

International Offices: Belgium, China, Japan, Korea

GRACO INC. P.O. BOX 1441 MINNEAPOLIS, MN 55440-1441

www.graco.com

312111A 2/2007

Download from Www.Somanuals.com. All Manuals Search And Download.

Free Manuals Download Website

<http://myh66.com>

<http://usermanuals.us>

<http://www.somanuals.com>

<http://www.4manuals.cc>

<http://www.manual-lib.com>

<http://www.404manual.com>

<http://www.luxmanual.com>

<http://aubethermostatmanual.com>

Golf course search by state

<http://golfingnear.com>

Email search by domain

<http://emailbydomain.com>

Auto manuals search

<http://auto.somanuals.com>

TV manuals search

<http://tv.somanuals.com>