

Gefen

®

A/V Cinema Scaler Pro I

EXT-AVCINEMAAA

User Manual



DOLBY
DIGITAL

ASKING FOR ASSISTANCE

Technical Support:

Telephone (818) 772-9100
(800) 545-6900

Fax (818) 772-9120

Technical Support Hours:

8:00 AM to 5:00 PM Monday thru Friday PST

Write To:

Gefen, LLC
c/o Customer Service
20600 Nordhoff St
Chatsworth, CA 91311

www.gefen.com
support@gefen.com

Notice

Gefen, LLC reserves the right to make changes in the hardware, packaging and any accompanying documentation without prior written notice.

A/V Cinema Scaler Pro I is a trademark of Gefen, LLC

ANALOG Version

Manufactured under license from Dolby Laboratories.
“Dolby”, “Pro Logic”, and the double-D symbol are trademarks of
Dolby Laboratories.

© 2010 Gefen, LLC, All Rights Reserved
All trademarks are the property of their respective companies

Rev E2

CONTENTS

1	Introduction
2	Operation Notes
3	Features
4	Panel Layout
5	Panel Descriptions
6	Panel Descriptions
7	Front Panel Buttons
7	Navigation
7	Input Selection
9	Using The A/V Cinema Scaler Pro - Main LCD
9	LCD Screen
10	A/V Cinema Scaler Pro - Initial Startup
10	Powering On
12	A/V Cinema Scaler Pro - Main Screen
12	Main Display
13	Input Resolutions
14	Audio Input Type
14	Audio Formats
15	Sampling Rates
15	Number Of Channels
15	Output Screen
16	Surround Processing
17	Dynamic Range Compression
17	Reference Level Compensation
18	DVI Output Type
18	HDMI EDID Type
19	Audio Input Type
20	Product Title
21	A/V Cinema Scaler Pro - Configuration
21	Main Features Menu
22	A/V Cinema Scaler Pro - Picture Adjust
23	Mode
24	Contrast
25	Brightness
25	Hue
25	Saturation
26	Sharpness
26	Aspect Ratio
28	Noise Reduction
29	Horizontal Position
29	Vertical Position
29	Clock
30	Phase
30	Exit Picture Adjust
30	A/V Cinema Scaler Pro - Color Adjust
31	Color Temp
32	Red
33	Green

CONTENTS

33	Blue
33	Exit Color Adjust
34	A/V Cinema Scaler Pro - Lipsync Delay Adjust
34	Lipsync Delay
34	Exit Lipsync Adjust
35	A/V Cinema Scaler Pro - Surround Delay Adjust
35	Surround Right Delay
36	Rear Surround Right Delay
36	Rear Surround Left Delay
36	Exit Lipsync Adjust
37	A/V Cinema Scaler Pro - Output Selection
37	Output Timing 1080P
38	Output Timing 2K
38	Exit Output Selection
38	A/V Cinema Scaler Pro - On Screen Display Adjust
39	Horizontal Position
40	Vertical Position
40	Timeout
40	Background
41	Exit OSD Adjust
41	A/V Cinema Scaler Pro - Firmware
42	DB-25 Audio Input & Bypass Mode
42	A/V Cinema Scaler Pro - DB-25 Audio Bypass Mode
42	Enabling Bypass Mode
43	Analog Input And Output Pinout
44	Analog DB-25 Output
44	Analog DB-25 Input
45	RS-232 Serial Control Interface
45	RS-232 Settings
46	RS-232 Serial Control Commands
48	Rack Mount / Tabletop Installation
49	Specifications
52	Warranty

INTRODUCTION

Congratulations on your purchase of the A/V Cinema Scaler Pro. Your complete satisfaction is very important to us.

Gefen

Gefen delivers innovative, progressive computer and electronics add-on solutions that harness integration, extension, distribution and conversion technologies. Gefen's reliable, plug-and-play products supplement cross-platform computer systems, professional audio/video environments and HDTV systems of all sizes with hard-working solutions that are easy to implement and simple to operate.

The Gefen A/V Cinema Scaler Pro

The Gefen Cinema Scaler is a video and audio device that can accomplish a unique variety of video scaling and audio conversion tasks. Any signal can be scaled and displayed with total end user control. An On-screen display (OSD) and full featured settings allow you to fine-tune your viewing experience and get the most out of your current A/V setup.

How It Works

Simply connect your analog or digital A/V sources to the Gefen Cinema Scaler. Using the OSD menu system and controls, select your desired input and resolution, audio processing needs, and other adjustments. The Cinema Scaler will brilliantly scale your image to your digital cinema projector or DVI /HDMI display.

Note: This unit is fully HDCP compliant.

OPERATION NOTES

READ THESE NOTES BEFORE INSTALLING OR OPERATING THE A/V CINEMA SCALER PRO

- Audio from the analog DB-25 input is available in bypass mode only. No video will be output when using the bypass mode.
- Audio connection for each input is selectable between analog and digital. Selection of the audio input type is selectable using the front panel LCD menu system. For more information please see page 18.
- **Coaxial/Optical Digital Audio Format Support**

2 Channel LPCM:	32kHz – 96kHz
Multi-Channel AC-3	1-6 Channels Bitstream
- **HDMI Digital Audio Format Support**

2 Channel LPCM	32kHz – 96kHz
Multi-Channel AC-3	1-6 Channels Bitstream
8 Channel LPCM	32kHz - 96kHz
- **Audio Processing**

Dolby Pro Logic II *All analog/digital (No DB-25) inputs.
(See page 16 for a detailed description of this feature)
- **Maximum supported video input formats**

DVI-D:	Maximum resolution 1920x1200/60Hz
DVI-I:	Maximum resolution 1920x1200/60Hz (both analog and digital)
Component:	Maximum resolution 1920x1080/60Hz
VGA:	Maximum resolution 1920x1200/60Hz
HDMI:	Maximum resolution 1920x1080/60Hz
- **Supported video output formats:**

Digital:	1920x1080p 24/50/60Hz and 2K (2048x1080p 24/50/60Hz)
Analog:	1920x1080p 24/50/60Hz and 2K (2048x1080p 24/50/60Hz)

23.97/24/50/60Hz passthrough is supported via all inputs. (Detailed timings can be found on page 13)
- **Supported audio output formats:**

Analog:	8 channel discrete (balanced over DB-25)
---------	--
- **This product is fully HDCP compliant**

FEATURES

Features

- 1 DVI-I video + analog or digital audio inputs
- 1 DVI-D video + analog or digital audio inputs
- 2 Component video + analog or digital audio inputs
- VGA + analog or digital audio input
- HDMI input
- DB-25 analog audio input (7.1 discrete, balanced)
- Support resolutions of 1920x1080p 60Hz and 2048x1080p 60Hz
- Selectable digital or analog audio input for each source (except HDMI)
- Front panel source selection with “bypass” mode for DB-25 pass-through
- RS-232 for optional firmware updates/external control
- LCD screen for scaling preferences & audio settings
- Audio delay for precise video synchronization
- Capable of “black barring”/stretching 4:3 aspect ratio
- Floating balanced audio outputs with separate power supply for avoiding ground loop issues.

Package Includes

- (1) Cinema Scaler Pro I unit
- (1) 12V DC Power Supply
- (1) Set of Rack Ears
- (1) User's Manual

PANEL LAYOUT

Front Panel

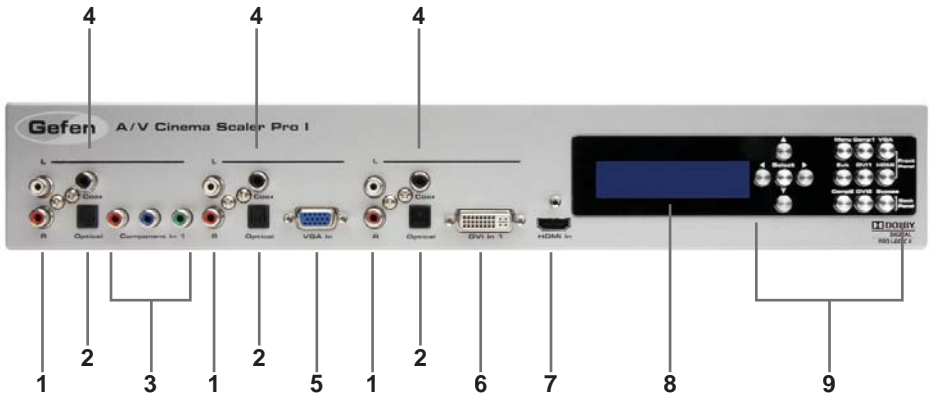

Back Panel

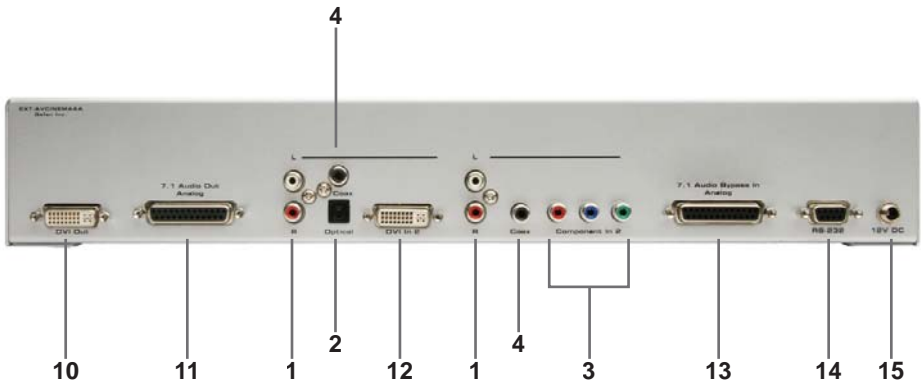

PANEL DESCRIPTIONS

1 Analog L+R RCA Audio Input

This input will accept 2 channel analog audio using 1 pair of RCA analog audio type connectors. There is a set of connectors available for all inputs except for the HDMI and DB-25 inputs. For a listing of accepted audio formats please see page 14.

2 Digital Optical Audio Input (TOSLINK)

This input will accept multi-channel digital audio using 1 optical type connector. There is a connector available for all inputs except for the HDMI, Component 2, and DB-25 inputs. For a listing of accepted audio formats, including supported audio channels, please see page 14-15.

3 Component Video Input

This input will accept component video (YPbPr) via 3 RCA type connectors. There is one set of connectors located on the front and back panels. For a listing of accepted resolutions please see page 13.

4 Digital Coaxial Audio Input (S/PDIF)

This input will accept multi-channel digital audio using 1 RCA type connector. There is a connector available for all inputs except for the HDMI and DB-25 inputs. For a listing of accepted audio formats, including supported audio channels, please see page 14-15.

5 VGA Video Input

This input will accept VGA video (RGBHV) via a HD-15 type connector. For a listing of accepted resolutions please see page 13.

6 DVI-I Video Input

This input will accept DVI-I video (RGB analog or digital) via a DVI-I type connector. Input format is automatically determined. For a listing of accepted resolutions please see page 13.

7 HDMI Input

This input will accept an HDMI (RGB, YCbCr) signal via an HDMI type A connector. Audio and video are both supported by this connector. For a listing of accepted resolutions and audio formats please see page 13.

8 High Contrast LCD Display

This display will show pertinent information for configuration control and status. For information on how to use this display please see page 12-19.

9 Navigation and Input Selection Buttons

These buttons are used to select the desired input source. Navigation buttons are also provided for easy user navigation and configuration of features. Please see page 7 for more information.

PANEL DESCRIPTIONS

10 DVI-D Output

This input will accept DVI-D (RGB digital) capable display device via a DVI-I type connector. This output port will support displays that are capable of accepting the two output resolutions; 1080p and 2K.

11 7.1 Channel Analog Audio Output

This output will accept a DB-25 type connector to connect to a multi-channel analog audio device. This port is always active. All audio from each input will be converted and output through this port. For pin-out information please see page 42-43.

12 DVI-D Input

This input will accept DVI-D video (digital) via a DVI-I type connector. Input format is digital only. For a listing of accepted resolutions please see page 13.

13 7.1 Channel Analog Audio Input

This input will accept a DB-25 type connector for multi-channel analog audio input. This port is only active when the bypass mode is selected (page 41). For pin-out information please see page 42-43.

14 RS-232 Serial Control Interface

This port is used for serial communication for multiple functions. Access to certain features are only through the RS-232 interface.

15 12V DC Power Receptacle

This port will accept power via the included 12V DC power supply. This is a locking type connector.

FRONT PANEL BUTTONS

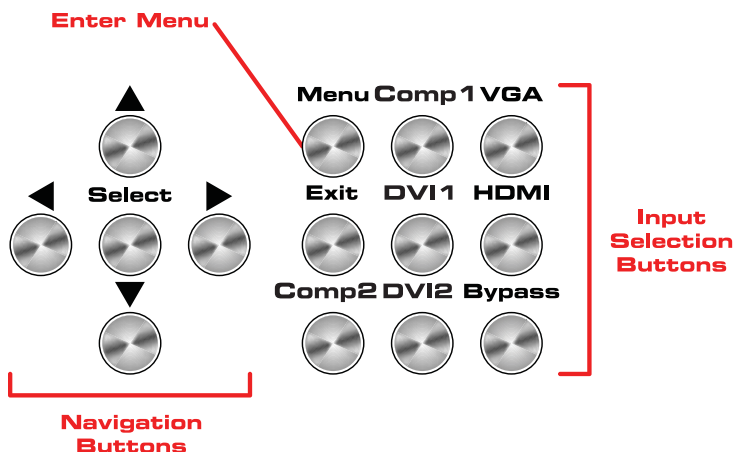

The front panel buttons are used for navigation, configuration, and input selection.

NAVIGATION

The directional buttons (◀▲▶▼) are used to navigate the user menu system. The **Select** button is used to confirm menu and item selections.

The **Menu** button is used to enter the configuration menu .

The **Exit** button is used to exit the configuration menu at any time.

INPUT SELECTION

The desired input port can be directly selected using the front panel input buttons. Simply press the desired input button. Source changing can take up to 10 seconds (longer when syncing digital video signals).

The bypass button will enable bypass mode (page 41).

CONNECTING AND OPERATING THE A/V CINEMA SCALER PRO

INSTALLING THE A/V CINEMA SCALER PRO

1. Connect video source devices to the A/V Cinema Scaler Pro's video inputs. The following inputs are available:

Front Panel

HDMI
DVI-I (analog and digital DVI)
VGA
Component

Back Panel

DVI-D (digital DVI)
Component

NOTE:

2. Connect audio sources to the A/V Cinema Scaler Pro's audio inputs. The following inputs are available:

Front Panel

HDMI:	Embedded audio
DVI-I:	Analog RCA L+R or Digital TOSLINK or S/PDIF
Component:	Analog RCA L+R or Digital TOSLINK or S/PDIF
VGA:	Analog RCA L+R or Digital TOSLINK or S/PDIF

Back Panel

DVI-D:	Analog RCA L+R or Digital TOSLINK or S/PDIF
Component:	Analog RCA L+R or Digital S/PDIF
DB-25:	Analog multi-channel audio. Please see page 42-43 for specific pin-out information

NOTE: All inputs, except for HDMI, is able to accept both analog and digital audio sources. Therefore, each input has a selector option in the OSD that will allow the user to choose which type of audio is used.

3. Connect the DVI capable output device to the A/V Cinema Scaler Pro's DVI-I input.

NOTE: This output is a DVI-I connector. Analog or digital type video can be output through this connector. Selection of the output format can be accomplished by using either the OSD (on-screen display) or the front panel LCD and buttons. Please see page 17 for instructions on how to change the DVI output type.

4. Connect the analog DB-25 audio output to the analog DB-25 input on the appropriate audio device.
5. Connect the included 12V power supply between the A/V Cinema Scaler Pro and an open power socket. Ensure that the input cable is properly secured to the unit.

USING THE A/V CINEMA SCALER PRO - MAIN LCD

A/V CINEMA SCALER PRO - NAVIGATION

The A/V Cinema Scaler Pro uses a series of buttons, located on the front panel, for all input selection and feature functions. All status information, such as the input and output resolutions, are always available on the front panel **LCD Screen**. User adjustable features, such as color correction and aspect ratio, can be navigated and adjusted by referencing either the **LCD Screen** or the On-Screen Display (**OSD**).

All menu navigation and adjustments are accomplished by using the front panel buttons. Please review the front panel buttons below.

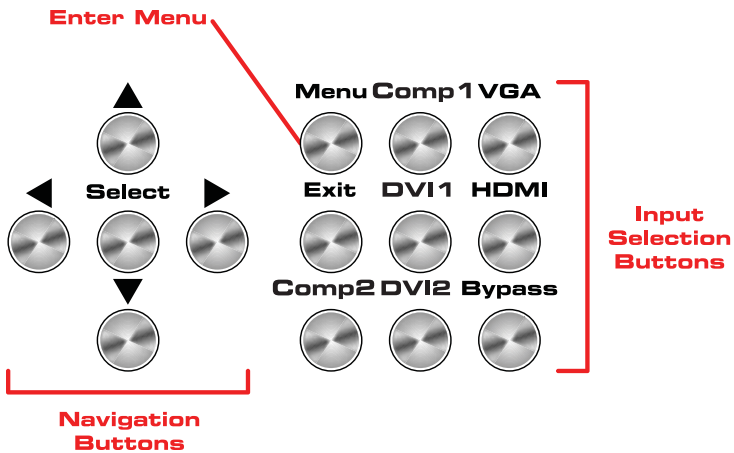

For a full description of each of these buttons please see the descriptions on page 7.

LCD SCREEN

The **LCD Screen** displays status information and can also be used to navigate and adjust functions on the A/V Cinema Scaler Pro. This display is a high contrast 2-line/16-character LCD. It will display information like in the example below.

Main Screen



USING THE A/V CINEMA SCALER PRO - MAIN LCD

A/V CINEMA SCALER PRO - INITIAL STARTUP

POWERING ON

Once all video and audio connections have been made and the power supply has been connected, the A/V Cinema Scaler Pro should automatically turn on. The front panel LCD should indicate this by displaying the text:

Product Title



GEFEN INC.
SIGNAL CONVERTER

This screen should be displayed for 3 seconds while the system is booting. Once this is complete, the **Main Screen** should appear.

There are 7 different information panes that are available to provide the user with useful information. These are the **Product Title**, **Main Screen**, **Output Screen**, **Surround Processing**, **DVI Output Type**, **HDMI EDID Type**, and **Audio Input Type** information panes. Please use the ▲ and ▼ buttons to cycle through the different information panes. The cycling order is displayed on the next page.

NOTE: The **Audio Input Type** pane will not be available when the **HDMI** input is selected.

USING THE A/V CINEMA SCALER PRO - MAIN LCD

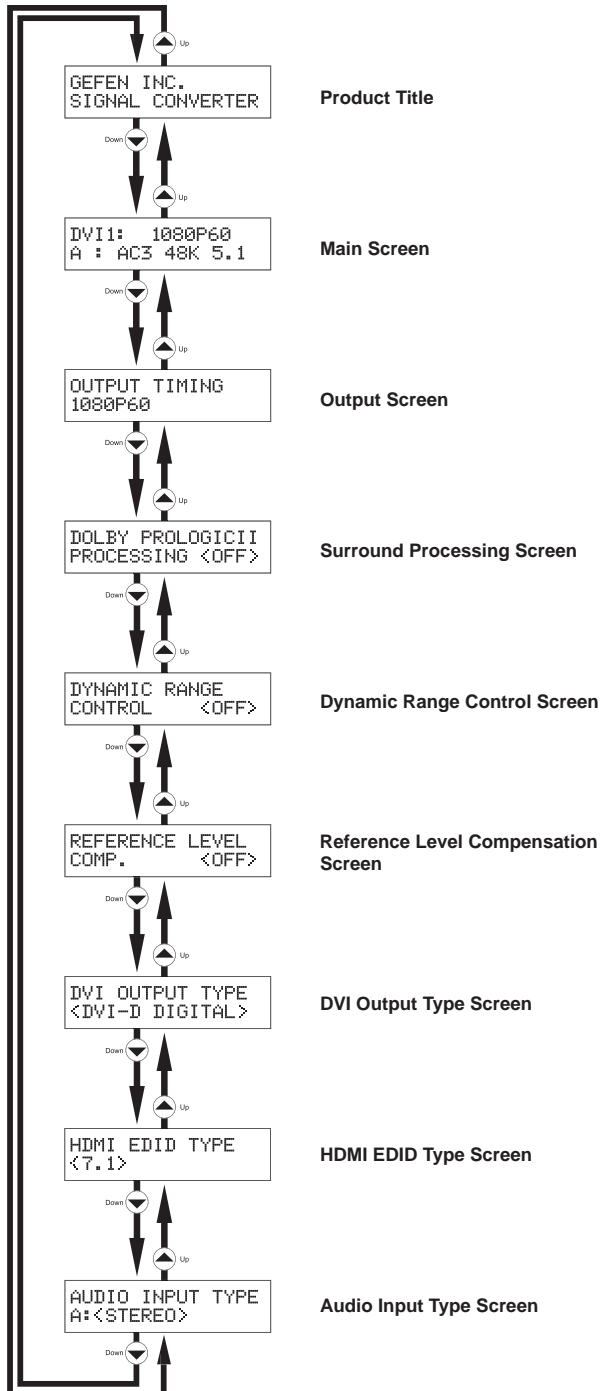

USING THE A/V CINEMA SCALER PRO - MAIN LCD

A/V CINEMA SCALER PRO - MAIN SCREEN

MAIN DISPLAY

The **Main Screen** will display useful information to the user. It displays the currently selected input port and audio input format. The currently used output format can also be displayed by pressing the ▼ button. Pressing the ◀ or ▶ buttons while on this screen will have no effect. Please see below for the **Main Screen** layout.

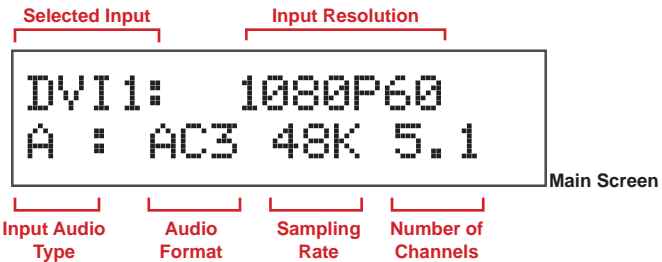

SELECTED INPUT

This portion of the screen will display the currently selected input. The available inputs, labels, and associated buttons are listed below:

LCD Display Name	Actual Input	Location	Front Panel Button
COMP1	Component	Front Panel	COMP1
PC	VGA	Front Panel	VGA
DVI-D1/DVI-A1	DVI-I	Front Panel	DVI1
HDMI	HDMI	Front Panel	HDMI
COMP2	Component	Back Panel	COMP2
DVI-D2	DVI-D	Back Panel	DVI2

USING THE A/V CINEMA SCALER PRO - MAIN LCD

INPUT RESOLUTIONS

This portion of the screen will display the currently selected input's resolution. The acceptable resolutions for each input type are listed below.

Input	Format	Resolution	Frequency
Component	YPbPr	480i/p	59/60Hz
		576i/p	50Hz
		720p	50/60Hz
		1080i/p	25/29.97/30/50/59.97/60Hz
PC (VGA)	RGBHV	VGA (640x480)	60Hz
		SVGA (800x600)	60Hz
		XGA (1024x768)	60Hz
		1152x864	60Hz
		SXGA (1280x1024)	60Hz
		1280x960	60Hz
		WXGA (1280x800)	60Hz
		WXGA (1360x768)	60Hz
		UXGA (1600x1200)	60Hz
		WUXGA (1920x1200)	60Hz
DVI-I (analog and digital)	RGBHV or RGB	VGA (640x480)	60Hz
		SVGA (800x600)	60Hz
		XGA (1024x768)	60Hz
		1152x864	60Hz
		SXGA (1280x1024)	60Hz
		1280x960	60Hz
		WXGA (1280x800)	60Hz
		WXGA (1360x768)	60Hz
		UXGA (1600x1200)	60Hz
		WUXGA (1920x1200)	60Hz
DVI-D & DVI-I (Digital Only) & HDMI	RGB or YCbCr	480i/p	59/60Hz
		576i/p	50Hz
		720p	50/60Hz
		1080i/p	23.97/24/25/29.97/30/50/59.97/60Hz

NOTE: 23.97/24/50/60Hz signal are pass-through. No framerate conversions will be applied.

USING THE A/V CINEMA SCALER PRO - MAIN LCD







AUDIO INPUT TYPE

This portion of the screen will display the currently selected input's audio type. All inputs, except for HDMI, will accept both an analog and digital type audio signals. The user can choose which type of audio is selected by using the **Audio Input Type** pane. Each input's audio type, except for HDMI, can be user selected. This is not available in bypass mode.

Input	Audio Input Type	LCD Display (Audio Type)
COMP1	Analog (L+R RCA)	A
	Digital (S/PDIF)/(TOSLINK)	D
VGA	Analog (L+R RCA)	A
	Digital (S/PDIF)/(TOSLINK)	D
DVI1	Analog (L+R RCA)	A
	Digital (S/PDIF)/(TOSLINK)	D
HDMI	Digital (S/PDIF)	D
COMP2	Analog (L+R RCA)	A
	Digital (S/PDIF)	D
DVI2	Analog (L+R RCA)	A
	Digital (S/PDIF)/(TOSLINK)	D

AUDIO FORMATS

This portion of the screen will display the currently selected input's audio format. When the input's audio type selector switch is set to analog, the display will only read "Stereo"; Sampling rate and number of channels will not be displayed. This does not cover the bypass mode.

Input	Audio Input Type	Supported Audio Formats
COMP1	Analog (L+R RCA)	Stereo
	Digital (S/PDIF)/(TOSLINK)	PCM /  (Dolby Digital)
VGA	Analog (L+R RCA)	Stereo
	Digital (S/PDIF)/(TOSLINK)	PCM /  (Dolby Digital)
DVI1	Analog (L+R RCA)	Stereo
	Digital (S/PDIF)/(TOSLINK)	PCM /  (Dolby Digital)
HDMI	Digital (S/PDIF)	PCM /  (Dolby Digital)
COMP2	Analog (L+R RCA)	Stereo
	Digital (S/PDIF)	PCM /  (Dolby Digital)
DVI2	Analog (L+R RCA)	Stereo
	Digital (S/PDIF)/(TOSLINK)	PCM /  (Dolby Digital)

Dolby, Pro Logic, and the double-D symbol are trademarks of Dolby Laboratories.

USING THE A/V CINEMA SCALER PRO - MAIN LCD

SAMPLING RATES

This portion of the screen will display the currently selected input's audio sampling rate. This will only display information when the input audio type is digital. This does not cover the bypass mode.

Input	Audio Input Type	Supported Sampling Rates
COMP1	Digital (S/PDIF)	32KHz-96KHz
VGA	Digital (S/PDIF)	32KHz-96KHz
DVI1	Digital (S/PDIF)	32KHz-96KHz
HDMI	Embedded Digital	32KHz-96KHz
COMP2	Digital (S/PDIF)	32KHz-96KHz
DVI2	Digital (S/PDIF)	32KHz-96KHz

NUMBER OF CHANNELS

This portion of the screen will display the number of audio channels that are being used by the currently selected input. This will only display information when the input audio type is digital. This does not cover the bypass mode.

Input	Audio Input Type	Supported PCM Channels	Supported  (Dolby Digital) Channels
COMP1	Digital (S/PDIF)	Up to 2	Up to 6 (5.1)
VGA	Digital (S/PDIF)	Up to 2	Up to 6 (5.1)
DVI1	Digital (S/PDIF)	Up to 2	Up to 6 (5.1)
HDMI	Embedded Digital	Up to 8	Up to 6 (5.1)
COMP2	Digital (S/PDIF)	Up to 2	Up to 6 (5.1)
DVI2	Digital (S/PDIF)	Up to 2	Up to 6 (5.1)

Dolby, Pro Logic, and the double-D symbol are trademarks of Dolby Laboratories.

OUTPUT SCREEN

Pressing the **▼** button when the **Main Screen** is displayed will take the user to the **Output Screen**. This screen is provided to easily determine and change the current output resolution setting.

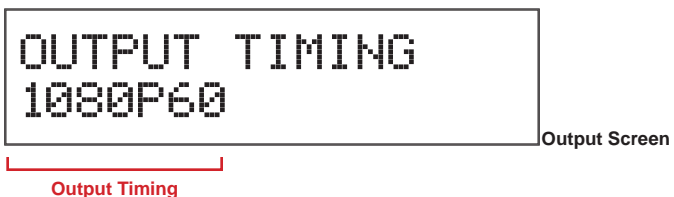

USING THE A/V CINEMA SCALER PRO - MAIN LCD

This A/V Cinema Scaler Pro supports only two output resolutions

Output	Resolution
1080P60	1920x1080 60Hz
2K	2048x1080 60Hz

The user has the option of changing the output resolution from the **Output Screen**. Use the ◀ or ▶ buttons to immediately change the output resolution.

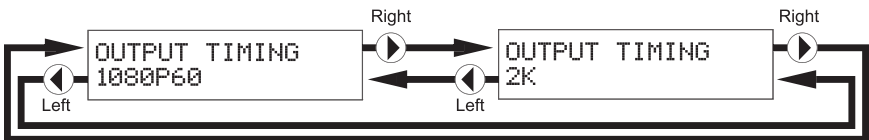

Pressing the ▲ button will return the user to the **Main Screen**. Pressing the ▼ will cycle the user to the **Product Title** screen.

NOTE: 1080p 24Hz is supported and will be passed through as either 1080p 24Hz or 2K 24Hz depending on the selected output resolution.

SURROUND PROCESSING

This unit features Dolby Pro Logic II surround sound processing. Dolby Pro Logic II processes any high quality stereo signal source into five separate full frequency channels. Dolby Pro Logic II also decodes 5 channels from stereo signals encoded in traditional four-channel Dolby Surround or five-channel Dolby Pro Logic II.

DOLBY PROLOGICII
PROCESSING <OFF>

This screen will display the current status of the surround processing mode. Pressing the ▲ button will return the user to the **Output Screen**. Pressing the ▼ will cycle the user to the **DVI Output Type** screen.

The user has the option of changing the processing mode from the **Surround Processing** screen. Use the ◀ or ▶ buttons to immediately change the processing mode on or off.

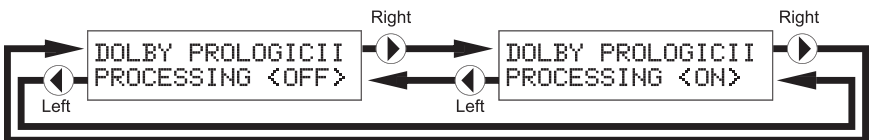

NOTE: When the processing mode is set to ON, it will only have an affect on 2 channel analog and digital sources.

USING THE A/V CINEMA SCALER PRO - MAIN LCD

DYNAMIC RANGE COMPRESSION

Dynamic Range Compression (DRC) is a feature that will apply compression of loud sounds over a certain threshold while quiet sounds remain untreated. This feature is useful for reducing loud noises that will overpower quieter sounds.

DYNAMIC RANGE
CONTROL < ON >

This screen will display the current **DRC** state. Pressing the ▲ button will return the user to the **Surround Processing** screen. Pressing the ▼ will cycle the user to the **RLC** screen.

The user has the option of changing the **DRC** state from this screen. Use the ◀ or ▶ buttons to immediately change the **DRC** state.

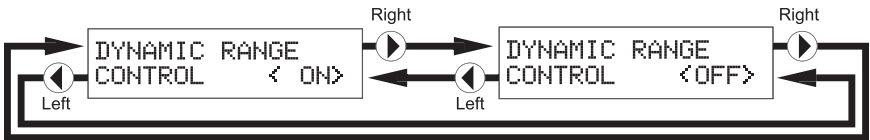

REFERENCE LEVEL COMPENSATION

Reference Level Compensation (RLC) features attenuation that can be used to apply a -3dB gain to the front right/left and center channels. This -3dB will be applied when RLC is on.

REFERENCE LEVEL
COMP. < ON >

This screen will display the current **RLC** state. Pressing the ▲ button will return the user to the **DVI Output Type** screen. Pressing the ▼ will cycle the user to the **DRC** screen.

The user has the option of changing the **RLC** state from this screen. Use the ◀ or ▶ buttons to immediately change the **RLC** state.

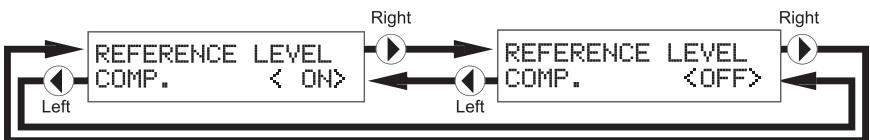

USING THE A/V CINEMA SCALER PRO - MAIN LCD

DVI OUTPUT TYPE

The DVI output is a DVI-I type which can be connected to either a digital or analog DVI device. This option will allow the user to change the output type at anytime. Please note that HDCP protected content will not be output when the modes is set to **DVI-A Analog**.

DVI OUTPUT TYPE
<DVI-D DIGITAL>

This screen will display the currently selected **DVI Output Type**. Pressing the ▲ button will return the user to the **RLC** screen. Pressing the ▼ will cycle the user to the **HDMI EDID Type** screen.

The user has the option of changing the **DVI Output Type** from this screen. Use the ◀ or ▶ buttons to immediately change the **DVI Output Type**.

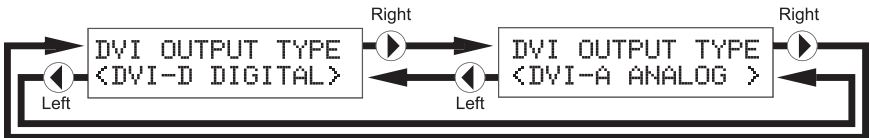

NOTE: In accordance with HDCP regulations, protected content will not be output via the DVI-I port when the **DVI Output Type** is set to **DVI-A Analog**.

HDMI EDID TYPE

This option will set the supported LPCM audio channels in the EDID (display/device information). This will allow the HDMI source device to output up 7.1 channels of LPCM audio or limit it to 5.1 channels.

HDMI EDID TYPE
<7.1>

This screen will display the currently selected **HDMI EDID Type**. Pressing the ▲ button will return the user to the **DVI Output Type** screen. Pressing the ▼ will cycle the user to the **Audio Input Type** screen.

The user has the option of changing the **HDMI EDID Type** from this screen. Use the ◀ or ▶ buttons to immediately change the **HDMI EDID Type**.

USING THE A/V CINEMA SCALER PRO - MAIN LCD

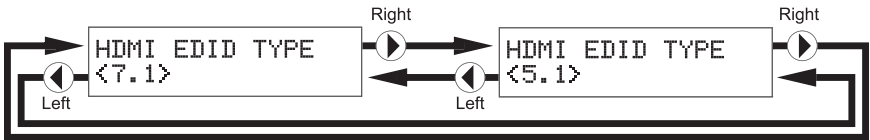

NOTE: This option will simply set the supported audio formats to include either 5.1 or 7.1 LPCM audio formats. The source must still be able to output these formats for this option to have any effect.

AUDIO INPUT TYPE

Each input, excluding the HDMI input, supports multiple audio input types. This option will allow the user to select the desired audio type for each input. For a complete listing of the supported formats for each input, please see page 14.

AUDIO INPUT TYPE
A: <STEREO>

This screen will display the currently selected **Audio Input Type**. Pressing the **▲** button will return the user to the **HDMI EDID Type** screen. Pressing the **▼** will cycle the user to the **Product Title** screen.

The user has the option of changing the **Audio Input Type** from this screen. Use the **◀** or **▶** buttons to immediately change the **Audio Input Type**.

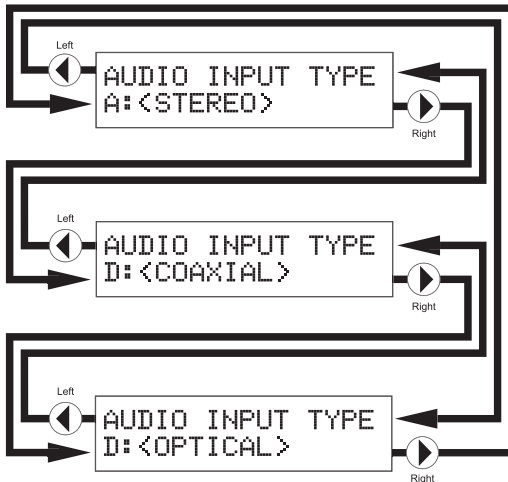

NOTE: This option is not available on the HDMI and Bypass inputs. The Component 2 input does not have an OPTICAL audio input.

USING THE A/V CINEMA SCALER PRO - MAIN LCD

PRODUCT TITLE

This screen will display the product title. Pressing the ▲ button will return the user to the **Output Screen**. Pressing the ▼ will cycle the user to the **Main Screen**. Pressing the ◀ or ▶ buttons while on this screen will have no effect.

GEFEN INC.
SIGNAL CONVERTER

MAIN FEATURES MENU

Once all connections have been made and a valid video input signal is detected, the **Main Features Menu** will become available. The following video/audio adjustment menus will also become available. From any of the information panes on the **Main LCD** screen, press the **Menu** button to enter the **Main Features Menu**. Use the **◀** and **▶** buttons to cycle through the **Main Features Menu**. The following illustrates the order of the features and the cycling order.

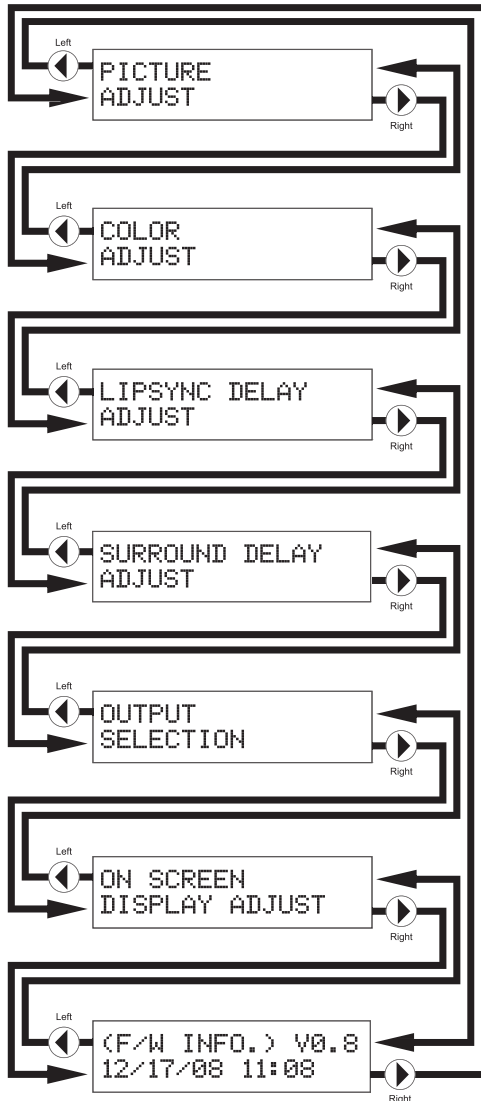

A/V CINEMA SCALER PRO - CONFIGURATION

The following are the **Main Features Menu** items and short descriptions:

- Picture Adjust** Options in this menu include preset video settings and user adjustable video settings. Items such as brightness, contrast, and sharpness are found here.
- Color Adjust** Options in this menu control the appearance of white. Preset settings are available, as well as a user setting with manual control.
- Lipsync Delay** This menu will allow the user to apply a lip sync delay that is input specific. Settings made for one input will not affect another input.
- Surround Delay** This menu will allow the user to apply a delay to each individual surround channel. Right surround, left surround, rear right surround, and rear left surround channel delay adjustments can be made. These settings are global and will affect all output audio, no matter which input is selected.
- Output Selection** This menu will control which output resolution is used.
- OSD Adjust** This menu controls options for the on-screen display system. Items such as OSD-timeout and opacity are found here.
- Firmware** The firmware revision and build date are listed here.

NOTE: The following pages will strictly reference what the **LCD Screen** displays when adjusting options. The **OSD** will mirror the options and functions in the following sections.

A/V CINEMA SCALER PRO - PICTURE ADJUST

The **Picture Adjust** menu will allow the user to select predefined picture modes that will help enhance the final video output. These presets will help by tuning the output video to compensate for different lighting and viewing environments. Presets can be bypassed by using the **User** setting. Once the **User** setting has been selected all individual options become modifiable.

To enter the **Picture Adjust** menu use the ◀ and ▶ buttons from the **Main Features Menu** to select **Picture Adjust**. Use the ▼ or **Select** button to enter the menu. The following page illustrates all possible options that are available in the **Picture Adjust** menu for all inputs.

NOTE: Some menu items will be input specific and will not appear in other input menu. All adjustments in this menu are global for all inputs except Bypass Mode.

A/V CINEMA SCALER PRO - CONFIGURATION

Menu for HDMI, DVI-D and DVI-I (Digital Portion) Inputs	Menu for Component Inputs	Menu for VGA and DVI-I (Analog Portion) Inputs
MODE: (STANDARD)	MODE: (STANDARD)	CONTRAST: 050
CONTRAST: 050	CONTRAST: 050	BRIGHTNESS: 050
BRIGHTNESS: 050	BRIGHTNESS: 050	HORIZONTAL POSITION: 050
HUE: 050	HUE: 050	VERTICAL POSITION: 050
SATURATION: 050	SATURATION: 050	CLOCK: 050
SHARPNESS: 050	SHARPNESS: 050	PHASE: 050
ASPECT RATIO (FULL)	ASPECT RATIO (FULL)	ASPECT RATIO (FULL)
EXIT PICTURE ADJUST	NOISE REDUCTION (OFF)	EXIT PICTURE ADJUST
	EXIT PICTURE ADJUST	

MODE

The preset picture modes are selectable with this option. Preset contrast, brightness, hue, saturation, and sharpness settings are stored for each mode. When the mode is switched to **User** all individual options will be available for adjustment.

MODE: (USER)

To cycle between the modes, use the ◀ or ▶ or **Select** buttons. The change will be immediate and no other buttons need to be pressed to confirm the change. The modes and cycle order is listed on the next page.

A/V CINEMA SCALER PRO - CONFIGURATION

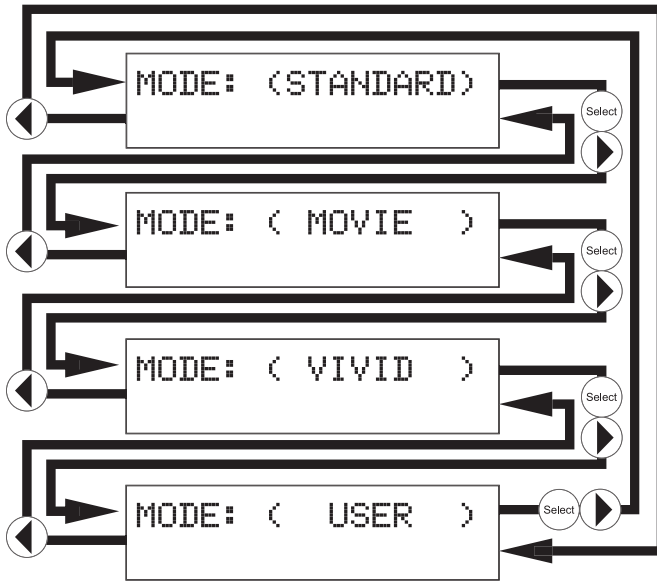

The preset modes are listed below:

- Standard** Useful for general content
- Movie** Useful for dimly lit environments
- Vivid** Useful for accentuating colors for a more vibrant image
- User** User configured settings

Once the **User** mode is selected, additional options will become available. Use the ▼ button to select the next option. Use the ▲ option to return to the previous option.

CONTRAST

This option will set the contrast level for the output video signal.

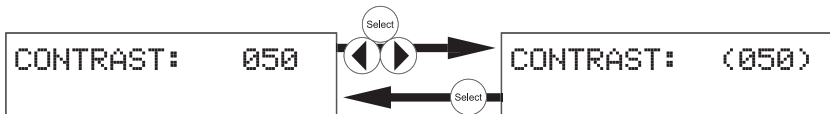

Press the ◀ or ▶ or **Select** buttons to begin adjusting this option. A < and > character will surround the numerical value to signify that user adjustment can begin. Use the ◀ and ▶ to adjust the value of this option. When adjustments are complete, press the **Select** button to save. Use the ▼ button to select the next option. Use the ▲ option to return to the previous option.

A/V CINEMA SCALER PRO - CONFIGURATION

BRIGHTNESS

This option will set the brightness level for the output video signal.

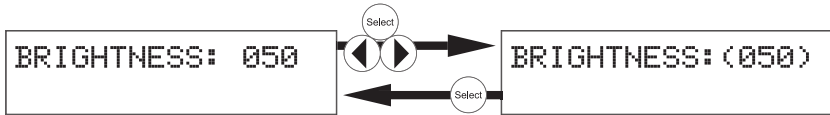

Press the ◀ or ▶ or **Select** buttons to begin adjusting this option. A < and > character will surround the numerical value to signify that user adjustment can begin. Use the ◀ and ▶ to adjust the value of this option. When adjustments are complete, press the **Select** button to save. Use the ▼ button to select the next option. Use the ▲ option to return to the previous option.

HUE

This option will set the hue balance for the output video signal. This option will not be available when the VGA or DVI-I (Analog portion) input is selected.

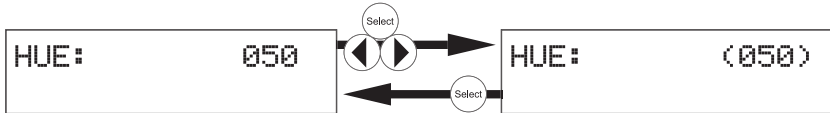

Press the ◀ or ▶ or **Select** buttons to begin adjusting this option. A < and > character will surround the numerical value to signify that user adjustment can begin. Use the ◀ and ▶ to adjust the value of this option. When adjustments are complete, press the **Select** button to save. Use the ▼ button to select the next option. Use the ▲ option to return to the previous option.

SATURATION

This option will set the saturation level for the output video signal. This option will not be available when the VGA or DVI-I (Analog portion) input is selected.

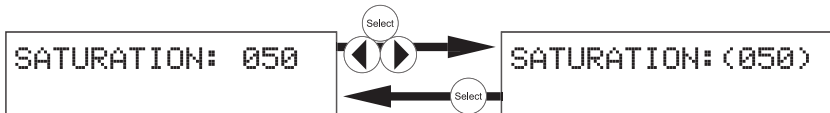

Press the ◀ or ▶ or **Select** buttons to begin adjusting this option. A < and > character will surround the numerical value to signify that user adjustment can begin. Use the ◀ and ▶ to adjust the value of this option. When adjustments are complete, press the **Select** button to save. Use the ▼ button to select the next option. Use the ▲ option to return to the previous option.

A/V CINEMA SCALER PRO - CONFIGURATION

SHARPNESS

This option will set the sharpness level for the output video signal. This option will not be available when the VGA or DVI-I (Analog portion) input is selected.

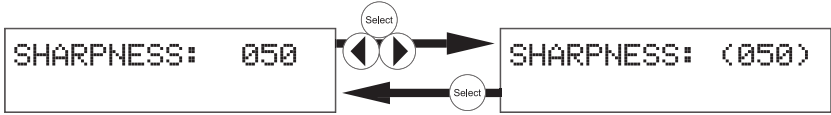

Press the ◀ or ▶ or **Select** buttons to begin adjusting this option. A < and > character will surround the numerical value to signify that user adjustment can begin. Use the ◀ and ▶ to adjust the value of this option. When adjustments are complete, press the **Select** button to save. Use the ▼ button to select the next option. Use the ▲ option to return to the previous option.

ASPECT RATIO

The aspect ratio of the output video is set with this option. There are 5 aspect ratio modes to choose from.

ASPECT RATIO
(FULL)

To cycle between the aspect ratio modes, use either the ◀ or ▶ or **Select** buttons. The change will be immediate and no other buttons need to be pressed to confirm the change. The aspect ratio modes and cycle order is listed below.

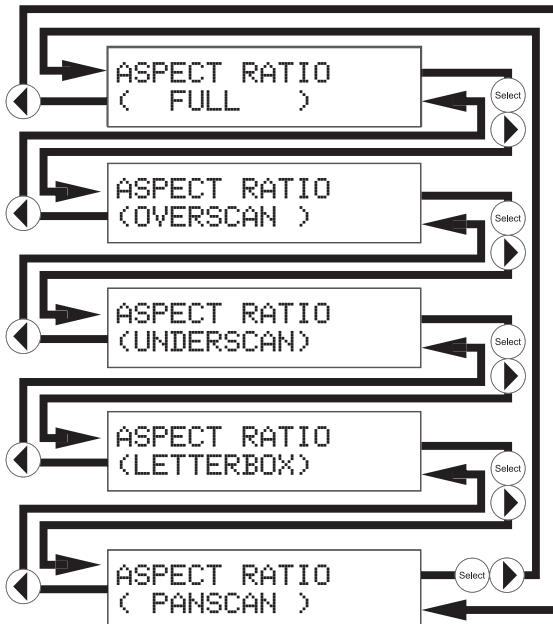

A/V CINEMA SCALER PRO - CONFIGURATION

The aspect ratio modes are listed below:

- Full** Stretches the image to fill the screen
- Overscan** Stretches the image to just beyond the border of the output resolution (a portion of the image may be cropped)
- Underscan** Stretches the image to just within the border of the output resolution (a black border will appear around the outside edges)
- Letterbox** Stretches the image to 16:9 aspect ratio without underscan
- Panscan** Stretches the image to 4:3 aspect ratio without underscan

Please use the examples below to determine which aspect ratio mode should be used. Please pay attention to the appearance of the circles. All circles that appear as ovals will result in an output image that appears stretched/Compressed.

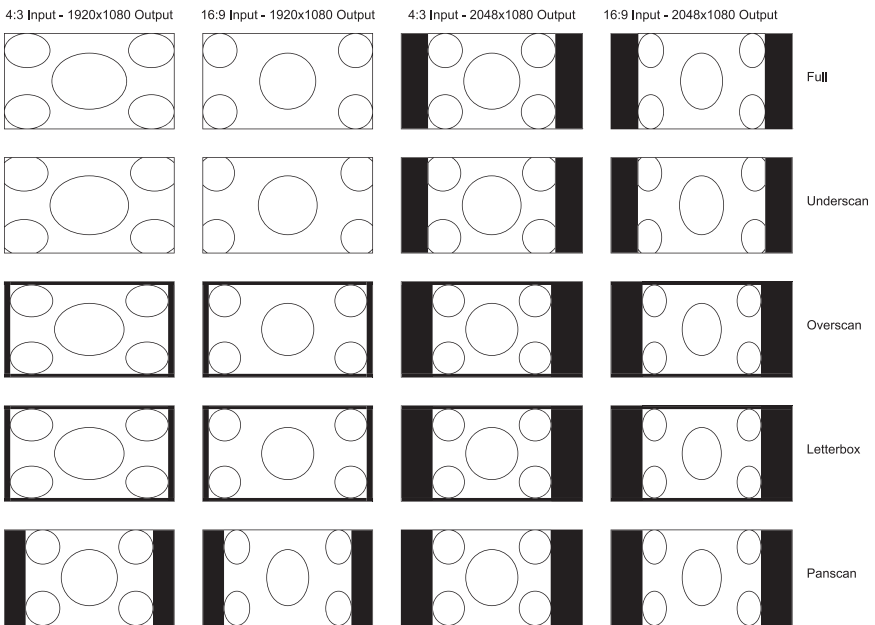

A/V CINEMA SCALER PRO - CONFIGURATION

Use the ▼ button to select the next option. Use the ▲ option to return to the previous option.

NOISE REDUCTION

This option will allow the user to apply a noise reduction filter to the component video input sources. This option will only be available when the input source is component video. The noise reduction filter reduces noise that commonly appears in analog video sources. There are 4 settings to choose from.

```
NOISE REDUCTION
( OFF )
```

To cycle between the noise reduction settings, use either the ◀ or ▶ or **Select** buttons. The change will be immediate and no other buttons need to be pressed to confirm the change. The aspect ratio modes and cycle order are listed below.

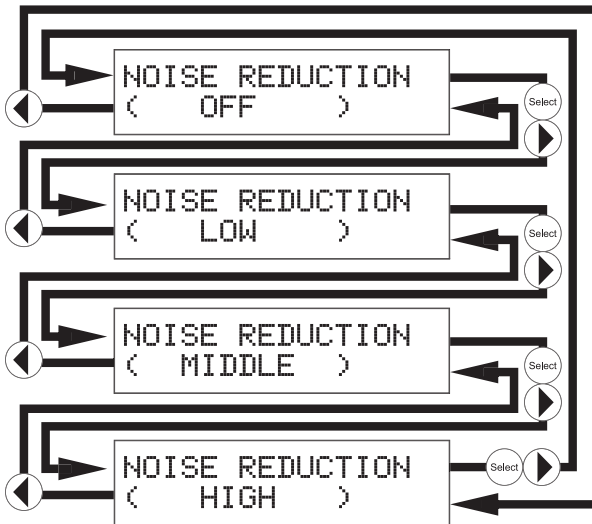

The noise reduction modes are listed below:

- Off** Noise reduction is off
- Low** Low level video noise reduction is applied
- Middle** Moderate level video noise reduction
- High** High level video noise reduction (may cause a slight ghosting effect on objects)

Use the ▼ button to select the next option. Use the ▲ option to return to the previous option.

A/V CINEMA SCALER PRO - CONFIGURATION

HORIZONTAL POSITION

This option will set the horizontal position of the video image in relation to the output border. This option is only available when using the VGA or DVI-I (Analog portion) inputs.

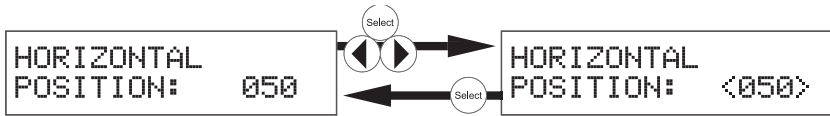

Press the ◀ or ▶ or **Select** buttons to begin adjusting this option. A < and > character will surround the numerical value to signify that user adjustment can begin. Use the ◀ and ▶ to adjust the value of this option. When adjustments are complete, press the **Select** button to save. Use the ▼ button to select the next option. Use the ▲ option to return to the previous option.

VERTICAL POSITION

This option will set the vertical position of the video image in relation to the output border. This option is only available when using the VGA or DVI-I (Analog portion) inputs.

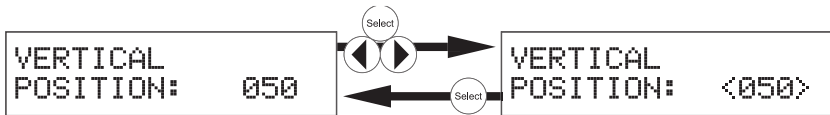

Press the ◀ or ▶ or **Select** buttons to begin adjusting this option. A < and > character will surround the numerical value to signify that user adjustment can begin. Use the ◀ and ▶ to adjust the value of this option. When adjustments are complete, press the **Select** button to save. Use the ▼ button to select the next option. Use the ▲ option to return to the previous option.

CLOCK

This option will adjust the clock timing to enable the user to adjust the video image. This option is only available when using the VGA or DVI-I (Analog portion) inputs.

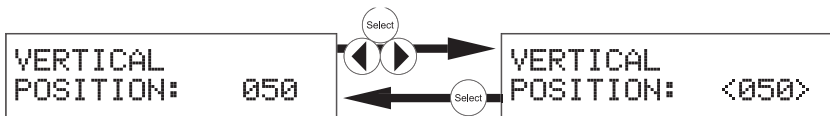

Press the ◀ or ▶ or **Select** buttons to begin adjusting this option. A < and > character will surround the numerical value to signify that user adjustment can begin. Use the ◀ and ▶ to adjust the value of this option. When adjustments are complete, press the **Select** button to save. Use the ▼ button to select the next option. Use the ▲ option to return to the previous option.

A/V CINEMA SCALER PRO - CONFIGURATION

PHASE

This option will adjust the phase to enable the user to adjust the video image. This option is only available when using the VGA or DVI-I (Analog portion) inputs.

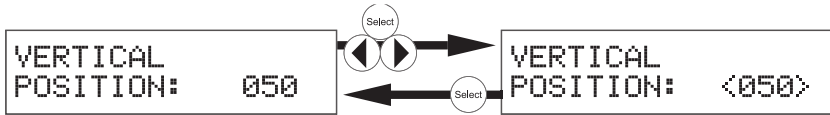

Press the ◀ or ▶ or **Select** buttons to begin adjusting this option. A < and > character will surround the numerical value to signify that user adjustment can begin. Use the ◀ and ▶ to adjust the value of this option. When adjustments are complete, press the **Select** button to save. Use the ▼ button to select the next option. Use the ▲ option to return to the previous option.

EXIT PICTURE ADJUST

This option will return the user to the **Main Features Menu**.

EXIT
PICTURE ADJUST

To return to the **Main Features Menu** press the **Select** button. Pressing the ▼ button will cycle to the **Mode** option. Use the ▼ button to select the next option. Use the ▲ option to return to the previous option.

A/V CINEMA SCALER PRO - COLOR ADJUST

The **Color Adjust** menu will allow the user to select predefined settings for the appearance of white (color temperature). Presets can be bypassed by using the **User** setting. Once the **User** setting has been selected all individual options become modifiable.

To enter the **Color Adjust** menu use the ◀ and ▶ buttons from the **Main Features Menu** to select **Color Adjust**. Use the ▼ or **Select** button to enter the menu. The following page illustrates all possible options that are available in the **Color Adjust** menu.

A/V CINEMA SCALER PRO - CONFIGURATION

COLOR ADJUST MENU OPTIONS

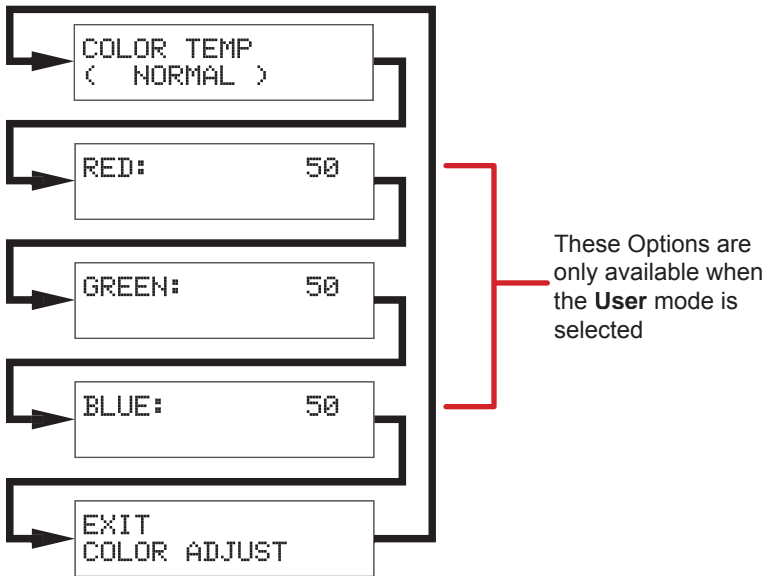

COLOR TEMP

The preset color temperature modes are selectable with this option. Preset red, green, and blue settings are stored in each mode. When the mode is switched to **User** all individual options will be available for adjustment.

```
COLOR TEMP  
( NORMAL )
```

To cycle between the modes, use the ◀ or ▶ or **Select** buttons. The change will be immediate and no other buttons need to be pressed to confirm the change. The modes and cycle order is listed on the following page.

A/V CINEMA SCALER PRO - CONFIGURATION

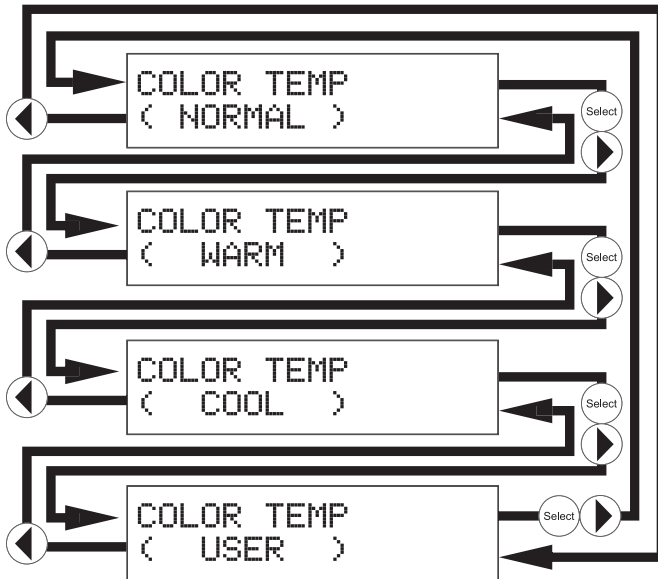

The preset color temperature settings are listed below:

- Normal** Colors/white will be neutral. White should not have an overly red or blue appearance.
- Warm** Colors/white will have a slightly red appearance.
- Cool** Colors/white will have a slightly blue appearance.
- User** User configured settings

Once the **User** mode is selected, additional options will become available. Use the ▼ button to select the next option. Use the ▲ option to return to the previous option.

RED

This option will set the amount of red in the output video signal.

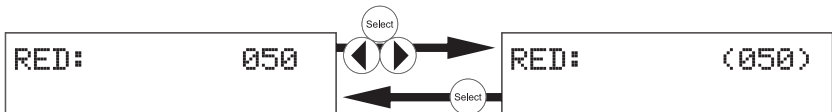

Press the ◀ or ▶ or **Select** buttons to begin adjusting this option. A < and > character will surround the numerical value to signify that user adjustment can begin. Use the ◀ and ▶ to adjust the value of this option. When adjustments are complete, press the **Select** button to save. Use the ▼ button to select the next option. Use the ▲ option to return to the previous option.

A/V CINEMA SCALER PRO - CONFIGURATION

GREEN

This option will set the amount of green in the output video signal.

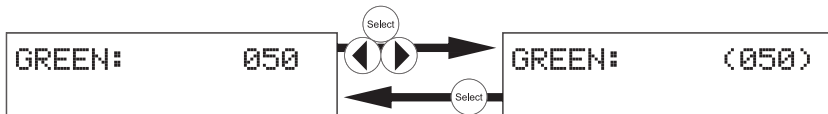

Press the ◀ or ▶ or **Select** buttons to begin adjusting this option. A < and > character will surround the numerical value to signify that user adjustment can begin. Use the ◀ and ▶ to adjust the value of this option. When adjustments are complete, press the **Select** button to save. Use the ▼ button to select the next option. Use the ▲ option to return to the previous option.

BLUE

This option will set the amount of blue in the output video signal.

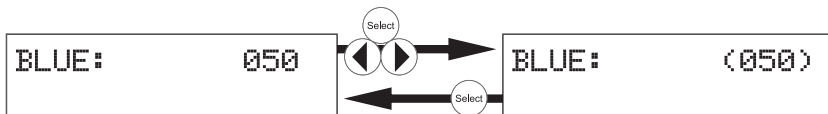

Press the ◀ or ▶ or **Select** buttons to begin adjusting this option. A < and > character will surround the numerical value to signify that user adjustment can begin. Use the ◀ and ▶ to adjust the value of this option. When adjustments are complete, press the **Select** button to save. Use the ▼ button to select the next option. Use the ▲ option to return to the previous option.

EXIT COLOR ADJUST

This option will return the user to the **Main Features Menu**.

EXIT
PICTURE ADJUST

This option will return the user to the **Main Features Menu**. To return to the **Main Features Menu** press the **Select** button. Pressing the ▼ button will cycle to the **Color Temp** option. Use the ▼ button to select the next option. Use the ▲ option to return to the previous option.

A/V CINEMA SCALER PRO - CONFIGURATION

A/V CINEMA SCALER PRO - LIPSYNC DELAY ADJUST

The **Lipsync Delay Adjust** menu will allow the user to apply a lip sync delay that is useful for correcting errors in synchronization between the audio and video. This delay has a maximum correction time of 80 milliseconds. Each input can have a separate lip sync adjustment value. This adjustment will not affect audio delay when in the Bypass Mode.

To enter the **Lipsync Delay Adjust** menu use the ◀ and ▶ buttons from the **Main Features Menu** to select **Lipsync Delay Adjust**. Use the ▼ or **Select** button to enter the menu. There is only one option in this menu.

LIPSYNC DELAY

This option will set the lip sync delay for the currently selected input.



```
LIPSYNC DELAY  
<  0 MS  >
```

Pressing the ▶ or **Select** buttons will advance the delay by 5 millisecond increments. Pressing the ◀ button will reduce the delay by 5 milliseconds. The maximum delay available is 80 milliseconds. Use the ▼ or ▲ button to select the **Exit LipSync Adjust** option.

EXIT LIPSYNC ADJUST

This option will return the user to the **Main Features Menu**.



```
EXIT  
LIPSYNC ADJUST
```

This option will return the user to the **Main Features Menu**. To return to the **Main Features Menu** press the **Select** button. Pressing the ▼ or ▲ button will return the user to the **LipSync Delay** option.

A/V CINEMA SCALER PRO - CONFIGURATION

A/V CINEMA SCALER PRO - SURROUND DELAY ADJUST

The **Surround Delay Adjust** menu will allow the user to apply a delay to compensate for the distance between the main and surround audio channels. Each surround delay has a maximum correction time of 150 milliseconds. The settings in this menu option are global and will affect the surround channels for every input. This adjustment will not affect audio delay when in the Bypass Mode.

To enter the **Surround Delay Adjust** menu use the ◀ and ▶ buttons from the **Main Features Menu** to select **Surround Delay Adjust**. Use the ▼ or **Select** button to enter the menu. The following illustrates all possible options that are available in the **Surround Delay Adjust** menu.

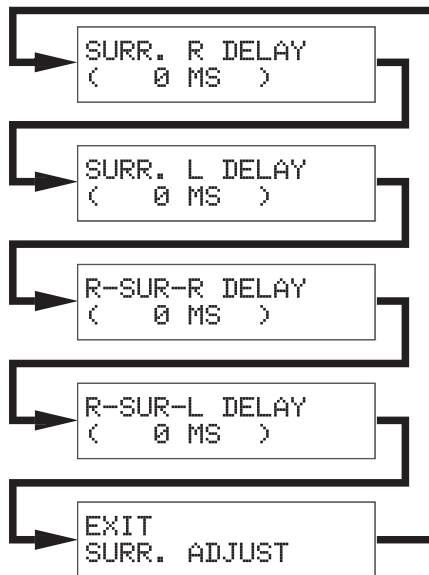

SURROUND RIGHT DELAY

This option will set the surround delay for the surround right channel.

```
SURR. R DELAY  
( 0 MS )
```

When this option is selected, pressing the ▶ or **Select** buttons will advance the delay by 5 millisecond increments. Pressing the ◀ button will reduce the delay by 5 milliseconds. The maximum delay available is 150 milliseconds. Use the ▼ button to select the next option. Use the ▲ option to return to the previous option.

A/V CINEMA SCALER PRO - CONFIGURATION

SURROUND LEFT DELAY

This option will set the surround delay for the surround left channel.

```
SURR. L DELAY  
( 0 MS )
```

When this option is selected, pressing the ► or **Select** buttons will advance the delay by 5 millisecond increments. Pressing the ◀ button will reduce the delay by 5 milliseconds. The maximum delay available is 150 milliseconds. Use the ▼ button to select the next option. Use the ▲ option to return to the previous option.

REAR SURROUND RIGHT DELAY

This option will set the surround delay for the rear surround right channel.

```
R-SUR-R DELAY  
( 0 MS )
```

When this option is selected, pressing the ► or **Select** buttons will advance the delay by 5 millisecond increments. Pressing the ◀ button will reduce the delay by 5 milliseconds. The maximum delay available is 150 milliseconds. Use the ▼ button to select the next option. Use the ▲ option to return to the previous option.

REAR SURROUND LEFT DELAY

This option will set the surround delay for the rear surround left channel.

```
R-SUR-L DELAY  
( 0 MS )
```

When this option is selected, pressing the ► or **Select** buttons will advance the delay by 5 millisecond increments. Pressing the ◀ button will reduce the delay by 5 milliseconds. The maximum delay available is 150 milliseconds. Use the ▼ button to select the next option. Use the ▲ option to return to the previous option.

EXIT LIPSYNC ADJUST

This option will return the user to the **Main Features Menu**.

```
EXIT  
SURR. ADJUST
```

This option will return the user to the **Main Features Menu**. To return to the **Main Features Menu** press the **Select** button. Use the ▼ button to select the next option. Use the ▲ option to return to the previous option.

A/V CINEMA SCALER PRO - CONFIGURATION

A/V CINEMA SCALER PRO - OUTPUT SELECTION

The **Output Selection** menu will allow the user to select the output video resolution.

To enter the **Output Selection** menu use the ◀ and ▶ buttons from the **Main Features Menu** to select **Output Selection**. Use the ▼ or **Select** button to enter the menu. The following illustrates all possible options that are available in the **Output Selection** menu.

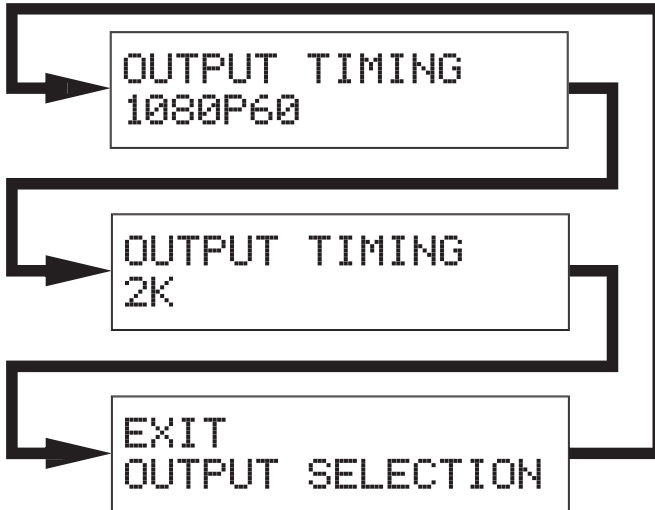

OUTPUT TIMING 1080P

This option will change the output resolution to a progressive 1920x1080 at 60Hz signal. All input formats will be scaled to this resolution.

OUTPUT TIMING
1080P60

Press the **Select** button to set this resolution. The change will be immediate. Pressing the ▼ button will cycle to the **Output Timing 2K** option. Use the ▼ button to select the next option. Use the ▲ option to return to the previous option.

A/V CINEMA SCALER PRO - CONFIGURATION

OUTPUT TIMING 2K

This option will change the output resolution to a progressive 2048x1080 at 60Hz signal. All input formats will be scaled to this resolution.



A rectangular box containing the text "OUTPUT TIMING" on the top line and "2K" on the bottom line, rendered in a pixelated font.

Press the **Select** button to set this resolution. The change will be immediate. Pressing the **▼** button will cycle to the **Exit Output Selection** option. Use the **▼** button to select the next option. Use the **▲** option to return to the previous option.

EXIT OUTPUT SELECTION

This option will return the user to the **Main Features Menu**.



A rectangular box containing the text "EXIT" on the top line and "OUTPUT SELECTION" on the bottom line, rendered in a pixelated font.

This option will return the user to the **Main Features Menu**. To return to the **Main Features Menu** press the **Select** button. Use the **▼** button to select the next option. Use the **▲** option to return to the previous option.

A/V CINEMA SCALER PRO - ON SCREEN DISPLAY ADJUST

The **On Screen Display Adjust** menu will allow the user to set options related to the on-screen display. Horizontal and vertical alignment, opacity, and time-out settings are found here.

To enter the **On Screen Display Adjust** menu use the **◀** and **▶** buttons from the **Main Features Menu** to select **On Screen Display Adjust**. Use the **▼** or **Select** button to enter the menu. The following page illustrates all possible options that are available in the **On Screen Display Adjust** menu.

A/V CINEMA SCALER PRO - CONFIGURATION

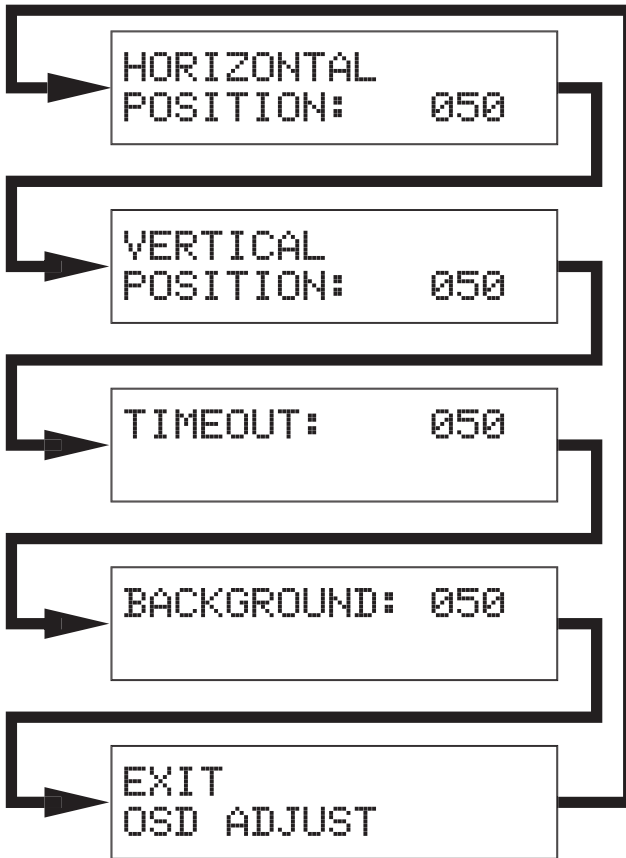

HORIZONTAL POSITION

This option will change the horizontal position of the on-screen display.

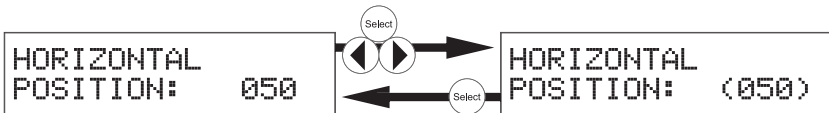

Press the ◀ or ▶ or **Select** buttons to begin adjusting this option. A < and > character will surround the numerical value to signify that user adjustment can begin. Use the ◀ and ▶ to adjust the value of this option. When adjustments are complete, press the **Select** button to save. Use the ▼ button to select the next option. Use the ▲ option to return to the previous option.

A/V CINEMA SCALER PRO - CONFIGURATION

VERTICAL POSITION

This option will change the vertical position of the on-screen display.

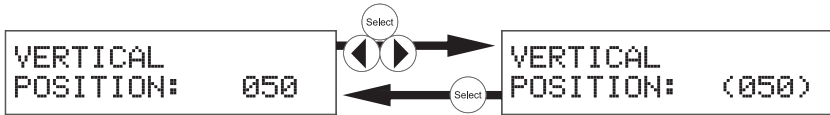

Press the ◀ or ▶ or **Select** buttons to begin adjusting this option. A < and > character will surround the numerical value to signify that user adjustment can begin. Use the ◀ and ▶ to adjust the value of this option. When adjustments are complete, press the **Select** button to save. Use the ▼ button to select the next option. Use the ▲ option to return to the previous option.

TIMEOUT

This option will change the amount of idle time before the on-screen display returns to the **Main Screen**.

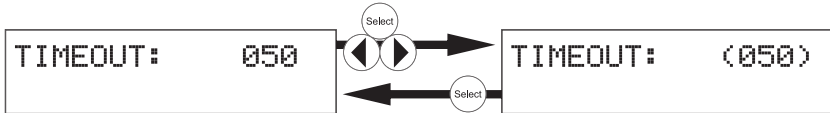

Press the ◀ or ▶ or **Select** buttons to begin adjusting this option. A < and > character will surround the numerical value to signify that user adjustment can begin. Use the ◀ and ▶ to adjust the value of this option. When adjustments are complete, press the **Select** button to save. Use the ▼ button to select the next option. Use the ▲ option to return to the previous option.

BACKGROUND

This option will change the opacity level of the on-screen display.

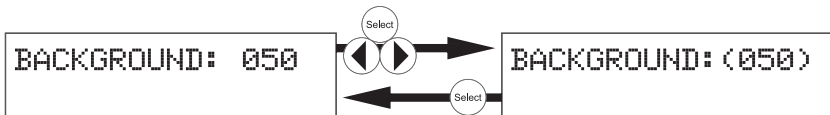

Press the ◀ or ▶ or **Select** buttons to begin adjusting this option. A < and > character will surround the numerical value to signify that user adjustment can begin. Use the ◀ and ▶ to adjust the value of this option. When adjustments are complete, press the **Select** button to save. Use the ▼ button to select the next option. Use the ▲ option to return to the previous option.

A/V CINEMA SCALER PRO - CONFIGURATION

EXIT OSD ADJUST

This option will return the user to the **Main Features Menu**.



A screenshot of a menu option. The text "EXIT" is on the top line and "OUTPUT SELECTION" is on the bottom line, both in a pixelated font. The text is enclosed in a thin black rectangular border.

This option will return the user to the **Main Features Menu**. To return to the **Main Features Menu** press the **Select** button. Use the ▼ button to select the next option. Use the ▲ option to return to the previous option.

A/V CINEMA SCALER PRO - FIRMWARE

The **Firmware** option will simply display the current firmware that is running on the A/V Cinema Scaler Pro. This information may be needed when calling technical support.

DB-25 AUDIO INPUT & BYPASS MODE

A/V CINEMA SCALER PRO - DB-25 AUDIO BYPASS MODE

The A/V Cinema Scaler Pro can accept high quality 8 channel analog audio via the DB-25 input located on the back panel. This input is only accessible from the bypass mode. The audio through this input will be directly passed to the analog DB-25 output.

ENABLING BYPASS MODE

To enable the bypass mode, locate the bypass mode button on the front panel. From the **Main Screen** press the **Bypass** button on the front panel to enable the bypass mode. The bypass mode will cycle in the following order. Each button press will progress to the next option.



Please note that there will be **NO VIDEO OUTPUT** when using the bypass function.

Analogue DB25 IN/OUT pinout Diagram

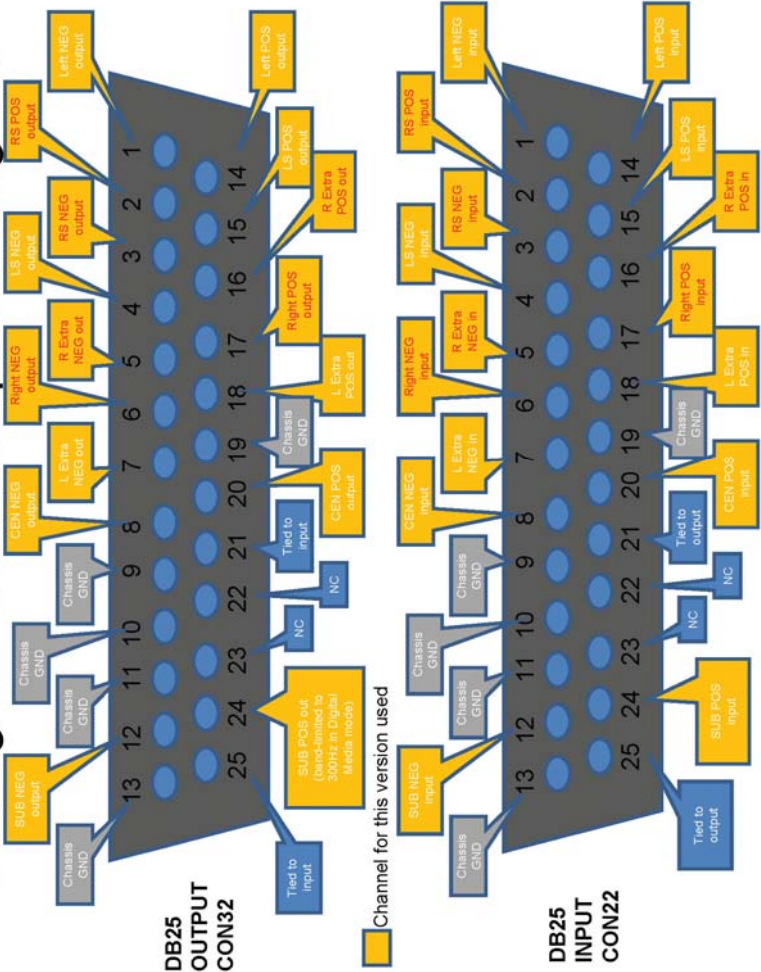

ANALOG INPUT AND OUTPUT PINOUT

ANALOG DB-25 OUTPUT

Pin	Function
1	Left Negative Output
2	Right Surround Positive Output
3	Right Surround Negative Output
4	Left Surround Negative Output
5	Right Extra Negative Output
6	Right Negative Output
7	Left Extra Negative Output
8	Center Negative Output
9	Chassis GND
10	Chassis GND
11	Chassis GND
12	Subwoofer Negative Output
13	Chassis GND
14	Left Positive Output

Pin	Function
15	Left Surround Positive Output
16	Right Extra Positive Output
17	Right Positive Output
18	Left Extra Positive Output
19	Chassis GND
20	Center Positive Output
21	Tied to Input
22	NC
23	NC
24	Subwoofer Positive Output (band-limited to 300Hz in DigitalMedia mode)
25	Tied to Input

ANALOG DB-25 INPUT

Pin	Function
1	Left Negative Input
2	Right Surround Positive Input
3	Right Surround Negative Input
4	Left Surround Negative Input
5	Right Extra Negative Input
6	Right Negative Input
7	Left Extra Negative Input
8	Center Negative Input
9	Chassis GND
10	Chassis GND
11	Chassis GND
12	Subwoofer Negative Input
13	Chassis GND
14	Left Positive Input

Pin	Function
15	Left Surround Positive Input
16	Right Extra Positive Input
17	Right Positive Input
18	Left Extra Positive Input
19	Chassis GND
20	Center Positive Input
21	Tied to Output
22	NC
23	NC
24	Subwoofer Positive Input (band-limited to 300Hz in DigitalMedia mode)
25	Tied to Output

RS232 pinout Diagram

 Pin for this version used

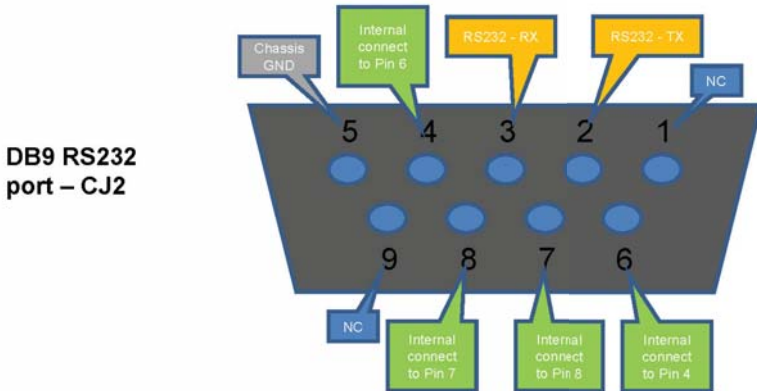

RS-232 SETTINGS

Bits per second	19200
Data bits	8
Parity	None
Stop bits	1
Flow Control	None

RS-232 SERIAL CONTROL COMMANDS

Set Commands

Command Code	Response	Description
S SOURCE 0	> SOURCE HDMI	HDMI
S SOURCE 1	> SOURCE DVI1	DVI1
S SOURCE 2	> SOURCE DVI2	DVI2
S SOURCE 3	> SOURCE YPbPr2	YPbPr2
S SOURCE 4	> SOURCE YPbPr1	YPbPr1
S SOURCE 5	> SOURCE PC	PC
S SOURCE 6	> SOURCE ANALOG_BYPASS	Analog Bypass
S SOURCE 7	> SOURCE DIGITAL_BYPASS	Digital Bypass(if available<---H/W exist)
S AUDIO 0	> AUDIO Stereo	Audio-Input select to Analog (Stereo)
S AUDIO 1	> AUDIO Coaxial	Audio-Input select to Digital (Coaxial)
S AUDIO 2	> AUDIO Optical	Audio-Input select to Digital (Optical)
REBOOT		Soft Reboot Machine
S OUTPUT 10	> OUTPUT 1080P60	1080P 60HZ RESOLUTION OUTPUT
S OUTPUT 19	> OUTPUT 2K	2K RESOLUTION OUTPUT
S SIZE 0	> SIZE FULL	SCALER FULL OUTPUT
S SIZE 1	> SIZE OVERSCAN	SCALER OVERSCAN OUTPUT
S SIZE 2	> SIZE UNDERSCAN	SCALER UNDERSCAN OUTPUT
S SIZE 3	> SIZE LETTERBOX	SCALER LETTERBOX OUTPUT
S SIZE 4	> SIZE PANSKAN	SCALER PANSKAN OUTPUT
S PICTUREMODE 0~3	> PICTUREMODE STANDARD~USER	0:STANDARD ; 1:MOVIE ; 2:VIVID ; 3:USER PICTURE MODE OUTPUT
S CONTRAST 0~100	> CONTRAST 0~100	CONTRAST 0~100 ADJUST [Default:50]
S BRIGHTNESS 0~100	> BRIGHTNESS 0~100	BRIGHTNESS 0~100 ADJUST [Default:45]
S HUE 0~100	> HUE 0~100	HUE 0~100 ADJUST [Default:50]
S SATURATION 0~100	> SATURATION 0~100	SATURATION 0~100 ADJUST [Default:60]
S SHARPNESS 0~100	> SHARPNESS 0~100	SHARPNESS 0~100 ADJUST [Default:32]
S NR 0~3	> NR OFF~HIGH	0:OFF ; 1:LOW ; 2:MIDDLE ; 3:HIGH ,NR CONTROL
S PCHPOSITION 0~100	> PCHPOSITION 0~100	H POSITION 0~100 ADJUST
S PCVPOSITION 0~100	> PCVPOSITION 0~100	V POSITION 0~100 ADJUST
S PCCLOCK 0~100	> PCCLOCK 0~100	PC MODE COLCK 0~100 ADJUST
S PCPHASE 0~63	> PCPHASE 0~63	PC MODE PHASE 0~63 ADJUST
S COLORTEMP 0~3	> COLORTEMP NORMAL~USER	0:NORMAL ; 1:WARM ; 2:COOL ; 3:USER ,COLOR TEMP SETTING
S RED 0~100	> RED 0~100	COLOR TEMP "RED" ADJUST [Default:47]
S GREEN 0~100	> GREEN 0~100	COLOR TEMP "GREEN" ADJUST [Default:47]
S BLUE 0~100	> BLUE 0~100	COLOR TEMP "BLUE" ADJUST [Default:47]
S OSDHPOSITION 0~100	> OSDHPOSITION 0~100	OSD H POSITION 0~100 ADJUST [Default:50]
S OSDVPOSITION 0~100	> OSDVPOSITION 0~100	OSD V POSITION 0~100 ADJUST [Default:50]
S OSDTIMEOUT 0~100	> OSDTIMEOUT 0~100	OSD TIMEOUT 0~100 SETTING [Default:10]
S OSDBACKGROUND 0~8	> OSDBACKGROUND 0~8	OSD OSDBACKGROUND 0~8 ADJUST [Default:5]
S RESET 1	> RESET ON	RESET ACTION
S OSDNOTICE 0	> OSDNOTICE ENABLE	ON SCREEN MENU is ON
S OSDNOTICE 1	> OSDNOTICE DISABLE	ON SCREEN MENU is OFF
AUDIO_DATA	AUDIO INFO. Like LCM shown	
PLIION	> PLII IS ON	DOLBY PROLOGICII PROCESSING ON
PLIOFF	> PLII IS OFF	DOLBY PROLOGICII PROCESSING OFF
DRCON	> DRC IS ON	DYNAMIC RANGE CONTROL ON
DRCOFF	> DRC IS OFF	DYNAMIC RANGE CONTROL OFF
RLCON	> RLC IS ON	REFERENCE LEVEL COMP. ON
RLCOFF	> RLC IS OFF	REFERENCE LEVEL COMP. OFF
DVIA	> DVI-A ANALOG	DVI OUTPUT TYPE IS DVI-A ANALOG
DVID	> DVI-D DIGITAL	DVI OUTPUT TYPE IS DVI-D DIGITAL
EDID51	> EDID 5.1	HDMI EDID TYPE 5.1

RS-232 SERIAL CONTROL COMMANDS

EDID71	> EDID 7.1	HDMI EDID TYPE 7.1
VGA_AUTO	> AutoConfig	VGA MODE AutoConfig
DVI?	> DVI-D DIGITAL or DVI-A ANALOG	SHOW DVI-D DIGITAL or DVI-A ANALOG
AUDSRC?	> AUDIO SRC=ANALOG or COAX or OPTICAL	SHOW AUDIO SRC=ANALOG or COAX or OPTICAL
INFO	> EXT-AVCINEMAA 3.21 07/02/2010	SHOW Latest F/W and date when F/W updated.

Status Commands

Command Code	Response	Description
R OUTPUT	> OUTPUT NATIVE~2K	SHOW OUTPUT STATUS
R SOURCE	> SOURCE HDMI	SHOW SOURCE STATUS
R SIZE	> SIZE FULL~PANSKAN	SHOW SIZE STATUS
R PICTUREMODE	> PICTUREMODE STANDARD~USER	SHOW PICTURE MODE STATUS
R CONTRAST	> CONTRAST 0~100	SHOW CONTRAST STATUS
R BRIGHTNESS	> BRIGHTNESS 0~100	SHOW BRIGHTNESS STATUS
R HUE	> HUE 0~100	SHOW HUE STATUS
R SATURATION	> SATURATION 0~100	SHOW SATURATION STATUS
R SHARPNESS	> SHARPNESS 0~100	SHOW SHARPNESS STATUS
R NR	> NR OFF~HIGH	SHOW NR STATUS
R PCHPOSITION	> PCHPOSITION 0~100	SHOW PC H-POSITION STATUS
R PCVPOSITION	> PCVPOSITION 0~100	SHOW PC V-POSITION STATUS
R PCCLOCK	> PCCLOCK 0~100	SHOW PC COLOK STATUS
R PCPHASE	> PCPHASE 0~63	SHOW PC PHASE STATUS
R COLORTEMP	> COLORTEMP NORMAL~USER	SHOW COLOR TEMP STATUS

NOTE: When using the Bypass Modes the only available commands are:

- **S SOURCE** commands
- **R SOURCE** command
- **INFO** command

RACK MOUNT / TABLETOP INSTALLATION

Rack mount ears are provided for installation of this unit into an equipment rack. Please refer to Figure 1 below. When using the product in a tabletop configuration, please install the provided rubber feet as shown in Figure 2.

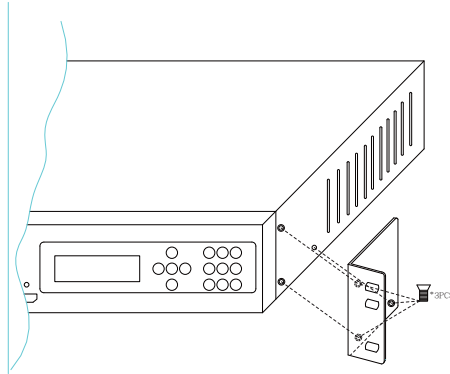

Figure 1. Rack-Mount Installation

1. Locate the side screws on the unit.
2. Remove the front 3 screws that are located closest to the front of the unit.
3. Using the removed screws, screw the rack mounting bracket into the unit.
4. Repeat the procedure on the opposite side of the unit.

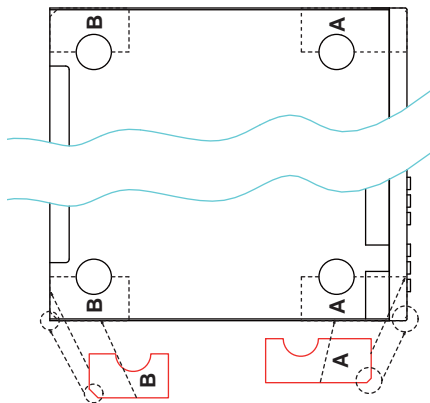

Figure 2. Desktop Installation

1. Turn the unit upside down.
2. Affix rubber feet to the unit, making sure you match up the correct shapes as shown in the diagram above.

SPECIFICATIONS

Video Section

Input Connectors

HDMI	1 – Type A 19pin Female
VGA	1 – HD-15 Female
DVI-I	1 – DVI-I 29pin Female
DVI-D	1 – DVI-I 29pin Female (Digital)
Component	2 – 3 RCA

Input Resolutions

640x480	(60Hz)HDMI/DVI-I/DVI-D/VGA
800x600	(60Hz)HDMI/DVI-I/DVI-D/VGA
1024x768	(60Hz)HDMI/DVI-I/DVI-D/VGA
1152x864	(60Hz)HDMI/DVI-I/DVI-D/VGA
1280x800	(60Hz)HDMI/DVI-I/DVI-D/VGA
1360x768	(60Hz)HDMI/DVI-I/DVI-D/VGA
1280x960	(60Hz)HDMI/DVI-I/DVI-D/VGA
1600x1200	(60Hz)HDMI/DVI-I/DVI-D/VGA
1920x1200	(60Hz)HDMI/DVI-I/DVI-D/VGA
720x480i	(59/60Hz)HDMI/Component/DVI-D
720x480p	(59/60Hz)HDMI/Component/DVI-D
720x576i	(50Hz)HDMI/Component/DVI-D
720x576p	(50Hz)HDMI/Component/DVI-D
1280x720p	(50/60Hz)HDMI/Component/DVI-D
1920x1080i	(50/60Hz)HDMI/Component/DVI-D
1920x1080p	(25/29/30/50/59/60Hz)HDMI/ Component/DVI-D
1920x1080p	(24Hz)HDMI/DVI-D (Passthrough)

Output Connectors

DVI-I (DVI-A/DVI-D Switchable)	1
--------------------------------	---

Output Resolutions

1920x1080p	(23.97/24/50/60Hz) DVI-I
2048x1080p	(23.97/24/50/60Hz) DVI-I

Component Input Sensitivity

1 Vp-p

HDMI Complyancy

1.2

HDCP Compliant

Yes

Input Colorspace

HDMI	RGB/YCbCr
VGA	RGBHV
DVI-I	RGBHV/RGB
DVI-D	RGB
Component	YPbPr

Output Colorspace

RGB

SPECIFICATIONS

Audio Section

Input Connectors

HDMI	1
RCA Type Analog L/R	5 (1 per input excluding HDMI)
Digital Coaxial	5 (1 per input excluding HDMI)
Analog DB-25	1

Output Connectors

Analog DB-25	1
--------------	---

THD < 0.001%

Stereo Input Max Voltage 2Vrms

Output Level

From Digital Source	-20dBFS 350mVrms
From Analog Source	0dBFS 3.5Vrms

Frequency Response < \pm 0.5dB

Signal-To-Noise Ratio*

Analog L/R Input	>90dB
Digital Input	>100dB
Analog DB-25 Input	>110dB

***20Hz-20kHz A weight filter, reference to full scale output of 3.5Vrms**

Coaxial Digital Audio Format Support

2 Channel LPCM	32kHz – 96kHz
Multi-Channel AC-3	2-6 Channels Bitstream

HDMI Digital Audio Format Support

2 Channel LPCM	32kHz – 96kHz
Multi-Channel AC-3	2-6 Channels Bitstream
8 Channel LPCM	32kHz - 96kHz

Audio Processing

Dolby Pro Logic II*	All analog/digital inputs
---------------------	---------------------------

***Analog DB-25 audio inputs bypass all audio processing**

SPECIFICATIONS

General Specifications

Operating Temperature	10 - 40° C Non-Condensing/Low Humidity
Control Terminal	RS-232 Serial Communications
Dimensions	16.9" W x 1.7"H x 8"D
Package Dimensions	18.5" W x 4.5"H x 12"D
Rack Mountable	1.5U (Rack Ears Included)
Shipping/Unit Weight	Estimate 12 lbs./ 9 lbs. (Final TBD)
Power	
Universal Power Supply	100-240Vac, 50/60Hz
Power Output	12Vdc
Power Consumption	6.67A (80 Watts Max)

WARRANTY

Gefen warrants the equipment it manufactures to be free from defects in material and workmanship.

If equipment fails because of such defects and Gefen is notified within two (2) years from the date of shipment, Gefen will, at its option, repair or replace the equipment, provided that the equipment has not been subjected to mechanical, electrical, or other abuse or modifications. Equipment that fails under conditions other than those covered will be repaired at the current price of parts and labor in effect at the time of repair. Such repairs are warranted for ninety (90) days from the day of reshipment to the Buyer.

This warranty is in lieu of all other warranties expressed or implied, including without limitation, any implied warranty or merchantability or fitness for any particular purpose, all of which are expressly disclaimed.

1. Proof of sale may be required in order to claim warranty.
2. Customers outside the US are responsible for shipping charges to and from Gefen.
3. Copper cables are limited to a 30 day warranty and cables must be in their original condition.

The information in this manual has been carefully checked and is believed to be accurate. However, Gefen assumes no responsibility for any inaccuracies that may be contained in this manual. In no event will Gefen be liable for direct, indirect, special, incidental, or consequential damages resulting from any defect or omission in this manual, even if advised of the possibility of such damages. The technical information contained herein regarding the features and specifications is subject to change without notice.

For the latest warranty coverage information, refer to the Warranty and Return Policy under the Support section of the Gefen Web site at www.gefen.com.

PRODUCT REGISTRATION

Please register your product online by visiting the Register Product page under the Support section of the Gefen Web site.



20600 Nordhoff St., Chatsworth CA 91311
1-800-545-6900 818-772-9100 fax: 818-772-9120
www.gefen.com support@gefen.com



This product uses UL listed power supplies.

Free Manuals Download Website

<http://myh66.com>

<http://usermanuals.us>

<http://www.somanuals.com>

<http://www.4manuals.cc>

<http://www.manual-lib.com>

<http://www.404manual.com>

<http://www.luxmanual.com>

<http://aubethermostatmanual.com>

Golf course search by state

<http://golfingnear.com>

Email search by domain

<http://emailbydomain.com>

Auto manuals search

<http://auto.somanuals.com>

TV manuals search

<http://tv.somanuals.com>