

7000/3 2T Art. 1494

D Gebrauchsanweisung

Benzinmotorpumpe

GB Operating Instructions

Petrol-driven Motor Pump

F Mode d'emploi

Pompe thermique pour arrosage

NL Gebruiksaanwijzing

2-taktmotorpomp

S Bruksanvisning

Pump med bensinmotor

I Istruzioni per l'uso

Motopompa

E Manual de instrucciones

Bomba con motor de gasolina

P Instruções de utilização

Bomba com motor a gasolina

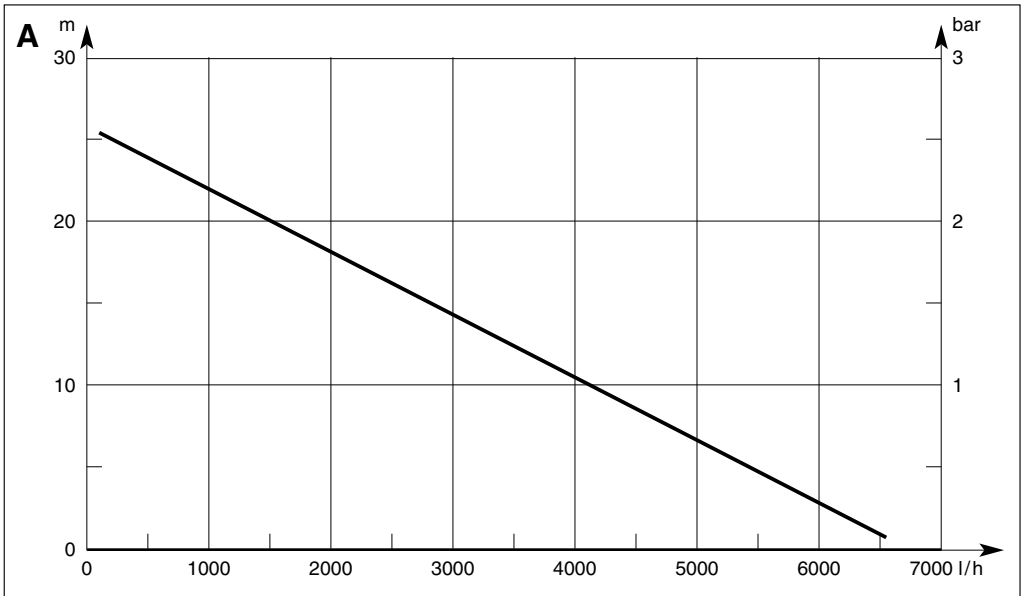

D

Bitte lesen Sie diese Gebrauchsanweisung vor Inbetriebnahme Ihres Gerätes sorgfältig. Beim Lesen der Gebrauchsanweisung bitte die Umschlagseite herausklappen.

Inhalt	Seite
Gebrauchsanweisung	4 - 8
Garantie	43

GB

Please read these operating instructions carefully before using the unit. Unfold inside cover page to read the operating instructions.

Contents	Page
Operating instructions	9 - 13
Guarantee	43

F

Nous vous remercions de bien vouloir lire attentivement ce mode d'emploi avant l'utilisation de votre pompe. Dépliez le 2ème volet de la couverture pour avoir les illustrations sous les yeux pendant la lecture du mode d'emploi.

Contenu	Page
Mode d'emploi	14 - 18
Garantie	43

NL

Lees deze gebruiksaanwijzing voor ingebruikname van het apparaat zorgvuldig door. Bij het lezen van de gebruiksaanwijzing de bladzijde met de afbeeldingen openslaan.

Inhoudsopgave	Pagina
Gebruiksaanwijzing	19 - 23
Garantie	43

S

Läs igenom bruksanvisningen noggrant innan Du tar Din GARDENA Pump i bruk. Ha omslaget utvikt när Du läser bruksanvisningen.

Innehåll	Sida
Bruksanvisning	24 - 27
Garanti	44

I

Prima di mettere in uso la nuova pompa, leggere attentamente le istruzioni tenendo aperto il pieghevole per avere sott'occhio i disegni esplicativi.

Indice	pagina
Istruzioni per l'uso	28 - 32
Garanzia	44

E

Antes de la puesta en marcha del aparato, aconsejamos una atenta lectura del presente manual de instrucciones. Para facilitar la lectura, desdoble la cubierta.

Índice	Página
Manual de instrucciones	33 - 37
Garantía	44

P

Por favor leia atentamente estas instruções de utilização antes de utilizar esta bomba. Desdobre a página na capa interior para ler as instruções de utilização.

Conteúdo	Página
Instruções de utilização	38 - 42
Garantia	44

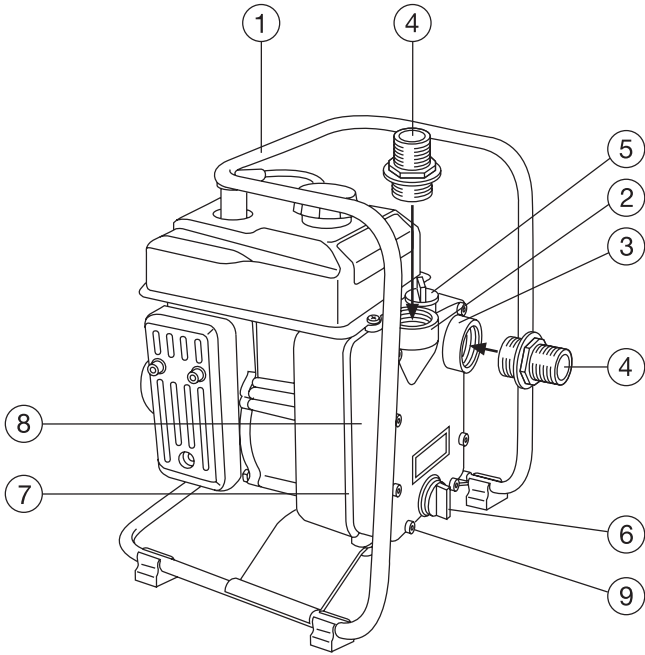
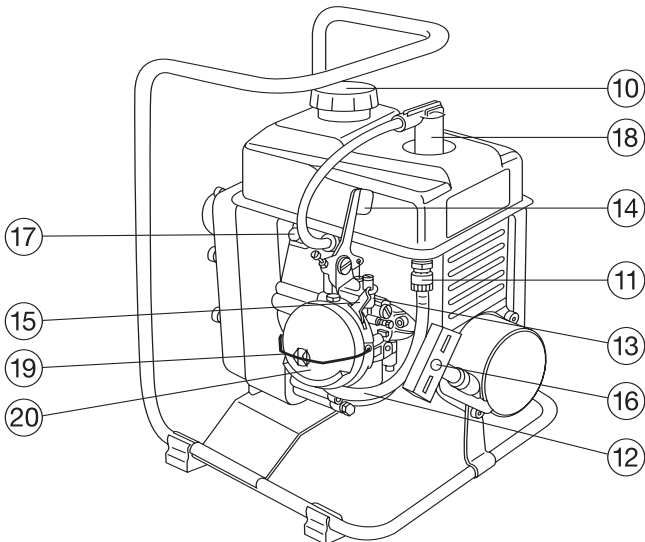
B**C**

GARDENA Petrol-driven Motor Pump 7000/3 2 T

1. Information concerning the Operating Instructions

Please read these operating instructions carefully. Follow the information given. Use the operating instructions to get acquainted with the proper use of your Petrol-driven Motor Pump.

 **For safety reasons, people who are not familiar with these operating instructions should not use this Petrol-driven Motor Pump.**

Keep these operating instructions in a safe place.

Following the operating instructions supplied by the manufacturer is a prerequisite for the proper use of the pump.

2. Proper Use

GARDENA Petrol-driven Motor Pumps have been designed for private use around your house and garden.

Petrol-driven Motor Pumps are predominantly used for operating watering equipment and systems in private gardens.

Besides, the GARDENA Petrol-driven Motor Pump can be used

for draining swimming pools, distribution of water-soluble fertilisers and pesticides as well as for pumping lime paints and water-soluble wood preservatives.

 **The GARDENA Petrol-driven Motor Pump is not designed for continuous operation (e.g. industrial appli-**

cation, continuous circulating operation).

 **Corrosive, easily combustible, aggressive or explosive substances (e.g. petrol, petroleum or nitro thinner, salt water as well as food) must not be pumped. The temperature of the liquid must not exceed 40 °C.**

3. Functional Parts (ill. B/C)

- | | | |
|---|--------------------------|-----------------------------------|
| ① Carrying frame | ⑤ Feed opening with seal | ⑭ Throttle lever |
| ② Outlet, delivery side
(female thread G 1) | ⑥ Outlet with seal | ⑮ Choke lever |
| ③ Inlet, suction side
(female thread G 1)
with backflow preventer | ⑦ Seal | ⑯ Starter handle |
| ④ 2 universal pump adaptors
33.3 mm (G 1) | ⑧ Hydraulics housing lid | ⑰ Stop button
(EMERGENCY STOP) |
| | ⑨ 8 Allen screws | ⑱ Spark plug connector |
| | ⑩ Fuel filler cap | ⑲ Clamp for air filter |
| | ⑪ Petrol cock | ⑳ Air filter lid |
| | ⑫ Petrol hose | |
| | ⑬ Carburettor | |

4. Measures before Operation

4.1 Positioning and Filling the Pump

-  ● **Locate pump at safe distance from the liquid.**
- **Fill the pump with at least 0.8 l of the liquid to be pumped via the feed opening ⑤ or the delivery side ② every time before you turn on the pump.**

4.2 Hose Connection

- Suction side ③**
- Screw one of the pump adaptors provided ④ **true-to-side** (ill. B) into the inlet side of the pump and screw tight **until the seal is pressed in.**
 - At the suction inlet, a vacuum-resistant suction hose has to be screwed tight onto the pump, e.g. GARDENA Suction Hose, art.no. 1412. The built-in backflow preventer at the suction inlet ③ prevents dry-

running of the suction hose when the operation is stopped. In addition it provides reduced suction time when starting the pump again.

 ● **For the suction inlet don't use any fittings of the hose connection system!**

Delivery side ②

- Screw the second pump adaptor **true-to-side** into the delivery side ② of the pump and screw tight. Ensure that the

seal of the pump adapter on the delivery side is tight.

- The pump fitting is equipped with a 33.3 mm (G 1) thread which allows hose connection of 13 mm (1/2"), 19 mm (3/4") and 16 mm (5/8") hoses by means of the GARDENA hose connection system fittings.
- For optimum output of the pump, connect 19 mm (3/4")

hoses with GARDENA Profi System fittings (e.g. Art. No. 1752) or 25 mm (1") hoses with GARDENA brass connection fittings (e.g. Art. No. 7142).

4.3 Engine

- Check the **fuel level**. The engine is designed to burn lead-free (premium) petrol (oil-mix). The mixing ratio for

lead-free petrol is 33:1 (33 parts petrol, 1 part oil). The petrol tank holds 0.7 l.

- **Always use a fresh petrol-oil mix.**
- Check the air filter insert. Loosen the clamp (19) to remove the air filter lid (20). Check the air filter insert for dirt and clean it, if necessary (see point 8. "Maintenance, Care, Storage").

5. Putting into Operation

5.1 Starting the Engine

1. **Open the petrol cock** (11).
2. Move the choke lever (15) to position C. If the engine is warm or if the ambient temperature is too high move the choke lever to position A.
3. Push the throttle lever (14) down a little.
4. Pull the starter handle (16) lightly until you feel resistance. Then pull the starter handle swiftly as far as the red mark-

ing on the wire. Avoid snapping back of the starter grip by guiding it slowly back with your hand. Thus, the starter will not be damaged.

5.2 Operation

1. When the engine is warm, gradually move the choke (15) to position A.
2. Set the throttle lever (14) to the desired speed.

5.3 Turning off the Engine

Push the throttle lever (14) all the way to the top and close the petrol cock (11). In emergency case the engine can be stopped by pressing the stop button (17).

5.4 Running-in Period

During the first 20 operating hours the engine should be operated at max. 2/3 of the full speed. During this running-in period full speed operation is only permissible for a short time (max. 10 min).

6. Safety Hints on Operation

- ⚠ ● **Keep combustible substances and other objects (e.g. petrol) away from the pump.**
- **Refuel in a well ventilated area. Take care that the pump is stopped. Remember that petrol is flammable and, under certain conditions, explosive.**
- **Don't overfill the tank. Make sure that the fuel filler cap (10)**

is closed securely. If petrol has spilt, wipe it away thoroughly before starting the engine.

- **Neither smoke nor allow flames or sparks when refuelling or where gasoline is stored.**
- **Exhaust gas contain poisonous carbon monoxide. Avoid inhalation of exhaust gas.**

Never operate the pump in closed rooms.

- **Operate the pump on even floor. If the engine tips, petrol may drain off.**
- **Do not place any objects on the engine. It could cause fire hazards.**
- **Children under the age of 16 are not allowed to operate the pump. Keep them away from the connected unit.**

7. Operation Hints

- ⚠ ● **Dry-running operation causes increased wear and is to be avoided. Therefore, the pump must be stopped immediately when water fails to flow.**
- **Avoid running the pump for more than max. 5 min**

against closed delivery side (2).

- **Sand and other abrasive material in the liquid cause increased wear and reduce the pump's output.**
- **The pump is not designed for continuous operation**

(e.g. industrial application, continuous circulating operation).

- **The min. flow rate is 80 l/h (= 1.3 l/min). Accessories with lower rate must not be operated.**

8. Maintenance, Care, Storage

After having pumped pesticides, lime paints or fertilisers, rinse the pump with lukewarm water (max. 35 °C). If necessary, add some soft cleansing agent (e.g. washing-up liquid). Remove residuals according to the waste disposal law.

If the turbine clogged due to contamination, it can be cleaned by removing the cover of the hydraulic casing (8). Unscrew all Allen screws (9) of the cover. When assembling the pump make sure that the seal (7) is not damaged and that the parts are assembled in the same order as they were disassembled.

Apart from the cover of the hydraulic casing (8), any other parts must only be disassembled by the GARDENA Service Centre.

Regular maintenance and adjustment is necessary to maintain the engine in good operating condition.

⚠ Caution! Stop the engine and disconnect spark plug (18) before carrying out any maintenance jobs on the pump. If, in case of certain jobs the motor must run, take care that the area is well ventilated. Exhaust gas contain poisonous carbon monoxide.

Maintenance

Check the air filter each time before you use the pump, every three months or after 50 operating hours and clean if necessary. Clean the spark plugs every 6 months or after every 100 operating hours and correct the distance between the electrodes.

Air Filter Service

A dirty air filter will restrict airflow to the carburettor. To prevent malfunction of the carburettor, service the air filter regularly. When operating the pump in extremely dusty areas, the pump must be serviced more frequently.

Open the clamp (19), remove the air filter cap (20) and take out the air filter insert. Wash the insert in a non-flammable solvent (for example washing-up liquid) and dry it. Soak the filter in clean engine oil and dry it. Replace the air filter insert and lid properly.

⚠ Never use petrol or solvents with low flash point for cleaning the air filter insert. Danger of fire or explosion.

Never operate your pump without air filter. Otherwise the engine wear is much higher.

Spark Plug Service

Remove the spark plug with the supplied wrench.

To ensure trouble-free engine operation, the spark plug must be free from residues of combustion. The plug gap (distance between the electrodes) should be 0.6 to 0.7 mm. If necessary, clean the spark plug and correct the distance between the electrodes by carefully bending the electrodes. Reinstall the spark plug. Tighten it as far as it will go by hand. A new spark plug should be tightened additionally with a wrench by a half turn to compress the washer. Old spark plugs are to be tightened by 1/8 to 1/4 turn.

In case of replacement of the spark plug, we exclusively recommend the type BR 6 HS (NGK).

Transport/Storage

In order to transport the pump, keep the pump in horizontal position to avoid fuel spillage. Petrol vapour or spilt petrol may ignite.

Empty the tank and carburettor if you are not intending to use the pump for longer periods of time (e.g. during the winter).

9. Technical Data

Engine	2-stroke / 1 kW
Max. delivery capacity	6,600 l/h
Max. pressure	2.6 bar
Max. pressure head	26 m
Max. suction height	7 m
Max. self-priming suction height	5 m
Working area related emission characteristic value $L_{pA}^{1)}$	90.5 dB (A)
Noise level $L_{WA}^{2)}$	measured: 100 dB (A) guaranteed : 101 dB (A)

Measuring method according to
1) DIN 45635-1 2) directive 2000/14/EC

Performance Characteristics (ill. A)

Technical data of the pump's performance characteristics was measured at a suction height of 0.5 m with a 25 mm (1") suction hose.

10. Recommended Accessories

- **GARDENA Suction Hoses**
Kink- and vacuum-resistant, sold by the metre without fittings or in fixed length, complete with fittings, as individually required.
- **GARDENA Fittings (art.no. 1723 / 1724) / Suction Filter with Backflow Preventer (art.no. 1726 / 1727 / 1728)**
To equip suction hoses sold by the metre.
- **GARDENA Preliminary Filter, art.no. 1731**
Especially recommended for pumping sandy liquids.
- **GARDENA Bore Hole Suction Hose, art.no. 1729**
For vacuum-resistant connection of the pump to bore holes or pipe networks. Length 0.5 m. With 33.3 mm (G 1) female thread at both ends.

11. Trouble-Shooting

Problem	Probable cause	Remedy
The motor doesn't start.	Empty fuel tank.	Refuel (see point 4.3.).
	Defective spark plug.	Check the spark plug or replace (see point 8).
Pump doesn't deliver.	Missing liquid, when priming action of the pump starts.	Fill up the pump with water (see point 4.1).
	Defect or leaky suction hose.	Replace the suction hose.
	Hydraulic casing ⑧ or turbine clogged.	Clean hydraulic unit or turbine (see point 8).
Pump engine runs, however, delivery capacity or pressure suddenly decrease.	Suction filter at the suction hose is sucked free.	Reduce flow rate at the delivery side ② via a control valve, e.g. GARDENA art.no. 977.
	Suction filter clogged.	Clean filter.
	Air cannot escape during priming action, since the delivery side is closed or remaining water is in the pressure line.	Open all shut-off devices (e.g. water stop) in the pressure line or drain the delivery hose.
	Suction height is too high.	Reduce the suction height (see point 9).

If you have any problem with your Petrol-driven Motor Pump, please contact our Customer Service or return the defective unit together with a short description of the problem and, if covered under guarantee, with a copy of the receipt, directly to one of the GARDENA Service Centres listed on the back of this leaflet.

We expressly point out that, in accordance with the product liability law, we are not liable for any damage caused by our units if it is due to improper repair or if parts exchanged are not original GARDENA

parts or parts approved by us, and if the repairs were not carried out by a GARDENA Service Centre or an authorised electrician. The same applies to spare parts and accessories.

EU Certificate of Conformity

The undersigned

GARDENA International GmbH · Hans-Lorenser-Str. 40 · D-89079 Ulm

hereby certifies that, when leaving our factory, the unit indicated below is in accordance with the harmonised EU guidelines, EU standards of safety and product specific standards.

This certificate becomes void if the unit is modified without our approval.

Description of the unit:

Petrol-driven Motor Pump

Type: 7000/3 T2

Art. no.: 1494

EU directives:

Machinery Directive 98/37/EC

Electromagnetic Compatibility

89/336/EC

Directive 93/68/EC

Directive 2000/14/EC

Harmonised

European standards:

EN 292-1

EN 292-2

Noise level:

measured: 100 dB (A)

guaranteed: 101 dB (A)

Year of CE marking:

1998

Ulm, 02.04.2002



Thomas Heint

Technical Dept. Manager

D

Garantie

GARDENA gewährt für dieses Produkt 2 Jahre Garantie (ab Kaufdatum). Diese Garantieleistung bezieht sich auf alle wesentlichen Mängel des Gerätes, die nachweislich auf Material- oder Fabrikationsfehler zurückzuführen sind. Sie erfolgt durch die Ersatzlieferung eines einwandfreien Gerätes oder durch die kostenlose Reparatur des eingesandten Gerätes nach unserer Wahl, wenn folgende Voraussetzungen gewährleistet sind:

- Das Gerät wurde sachgemäß und laut den Empfehlungen in der Gebrauchsanweisung behandelt.
- Es wurde weder vom Käufer noch von einem Dritten versucht, das Gerät zu reparieren.

Das Verschleißteil Turbine ist von der Garantie ausgeschlossen.

Diese Hersteller-Garantie berührt die gegenüber dem Händler/Verkäufer bestehenden Gewährleistungsansprüche nicht.

Im Reklamationsfall schicken Sie bitte das defekte Gerät zusammen mit einer Kopie des Kaufbelegs und einer Fehlerbeschreibung frankiert an die auf der Rückseite angegebene Serviceadresse.

Nach erfolgter Reparatur senden wir das Gerät frei an Sie zurück.

GB

Guarantee

GARDENA guarantees this product for 2 years (from date of purchase). This guarantee covers all serious defects of the unit that can be proved to be material or manufacturing faults. Under warranty we will either replace the unit or repair it free of charge if the following conditions apply:

- The unit must have been handled properly and in keeping with the requirements of the operating instructions.
- Neither the purchaser or a non-authorised third party have attempted to repair the unit.

The turbine is a wearing part and is not covered by the guarantee.

This manufacturer's guarantee does not affect the user's existing warranty claims against the dealer/seller.

In case of claim, please return the faulty unit together with a copy of the receipt and a description of the fault, with postage paid to one of the GARDENA Service Centres listed on the back of these operating instructions.

F

Garantie

Pour mieux vous servir, GARDENA accorde pour cet appareil une garantie contractuelle de 2 ans à compter du jour de l'achat. Elle est assurée par le remplacement gratuit des pièces défectueuses ou de l'appareil. Le choix en étant laissé à la libre initiative de GARDENA. En tout état de cause s'applique la garantie légale couvrant toutes les conséquences des défauts ou vices cachés (article 1641 et suivants du Code Civil).

Pour que ces garanties soient valables, les conditions suivantes doivent être remplies :

- L'appareil a été manipulé de manière adéquate, suivant les instructions du mode d'emploi.
- Il n'y a eu aucun essai de réparation, ni par le client, ni par un tiers.

La turbine est une pièce d'usure et est par conséquent exclue de la garantie.

Une intervention sous garantie ne prolonge pas la durée initiale de la garantie contractuelle.

Toutes les revendications dépassant le contenu de ce texte ne sont pas couvertes par la garantie, quel que soit le motif de droit.

Pendant la période de garantie, le Service Après-Vente et les Centres SAV agréés effectuent, à titre payant, les réparations nécessaires par suite de manipulations erronées.

En cas de réclamation, veuillez envoyer le produit en port payé avec le bon d'achat et une description du problème, à l'adresse du Service Après-Vente figurant au verso.

NL

Garantie

GARDENA geeft op dit product 2 jaar garantie (vanaf de aankoopdatum). Deze garantie heeft betrekking op alle wezenlijke defecten aan het toestel, die aanwijsbaar op materiaal- of fabriecagefouten berusten. Garantie vindt plaats door de levering van een vervangend apparaat of door de gratis reparatie van het ingestuurde apparaat, naar onze keuze, indien aan de volgende voorwaarden is voldaan:

- Het apparaat werd vakkundig en volgens de adviezen in de gebruiksaanwijzing behandeld.
- Noch de koper, noch een derde persoon heeft getracht het apparaat te repareren.

De aan slijtage onderhevige turbine valt niet onder de garantie.

Deze garantie van de producent heeft geen betrekking op de ten aanzien van de handelaar/verkoper bestaande aansprakelijkheid.

In geval van reclamatie het defecte apparaat samen met de kassabon en een beschrijving van de storing gefrankeerd op naar het op de achterzijde aangegeven serviceadres opsturen.

Deutschland / Germany

GARDENA
Manufacturing GmbH
Service Center
Hans-Lorenser-Straße 40
D-89079 Ulm
Produktfragen:
(+49) 731 490-123
Reparaturen:
(+49) 731 490-290
service@gardena.com

Argentina

Argensem® S.A.
Calle Colonia Japonesa s/n
(1625) Loma Verde
Escobar, Buenos Aires
Phone: (+54) 34 88 49 40 40
info@argensem.com.ar

Australia

Nylex Consumer Products
50-70 Stanley Drive
Somerton, Victoria, 3062
Phone: (+61) 1800 658 276
spare.parts@nylex.com.au

Austria / Österreich

GARDENA
Österreich Ges.m.b.H.
Stettnerweg 11-15
2100 Korneuburg
Tel.: (+43) 2262 7 45 45 36
kundendienst@gardena.at

Belgium

GARDENA Belgium NV/SA
Sterrebeekstraat 163
1930 Zaventem
Phone: (+32) 2 720 92 12
Mail: info@gardena.be

Brazil

Palash Comércio e
Importação Ltda.
Rua Américo Brasiliense,
2414 - Chácara Sto Antonio
São Paulo - SP - Brasil -
CEP 04715-005
Phone: (+55) 11 5181-0909
eduardo@palash.com.br

Bulgaria

DENEX LTD.
2 Luis Ahalier Str. - 7th floor
Sofia 1404
Phone: (+359) 2 958 18 21
office@denex-bg.com

Canada

GARDENA Canada Ltd.
100 Summerlea Road
Brampton, Ontario L6T 4X3
Phone: (+1) 905 792 93 30
info@gardenacanada.com

Chile

Antonio Martinic y Cia Ltda.
Cassillas 272
Centro de Cassillas
Santiago de Chile
Phone: (+56) 2 20 10 708
garfar_cl@yahoo.com

Costa Rica

Compania Exim
Euroberoamericana S.A.
Los Colegios, Moravia,
200 metros al Sur del Colegio
Saint Francis - San José
Phone: (+506) 297 68 83
exim_euro@racsa.co.cr

Croatia

KLIS d.o.o.
Stanciceva 79
10419 Vukovina
Phone: (+385) 1 622 777 0
gardena@klis-irgovina.hr

Cyprus

FARMOKIPIKI LTD
P.O. Box 7098
74, Digeni Akritra Ave.
1641 Nicosia
Phone: (+357) 22 75 47 62
condam@spidernet.com.cy

Czech Republic

GARDENA spol. s r.o.
Řípská 20 a. č.p. 1153
627 00 Brno
Phone: (+420) 800 100 425
gardena@gardenabrno.cz

Denmark

GARDENA Norden AB
Salgsafdeling Danmark
Box 9003
S-200 39 Malmö
info@gardena.dk

Finland

Habitec Oy
Martinkyläntie 52
01720 Vantaa

France

GARDENA
PARIS NORD 2
69, rue de la Belle Etoile
BP 57080
ROISSY EN FRANCE
95948 ROISSY CDG CEDEX
Tél. (+33) 0826 101 455
service.consommateurs@
gardena.fr

Great Britain

GARDENA UK Ltd.
27-28 Brenkley Way
Blezzard Business Park
Seaton Burn
Newcastle upon Tyne
NE13 6DS
info@gardena.co.uk

Greece

Agrokrip
G. Psomadopoulos & Co.
33 A, Ifestou str. -
Industrial Area
194 00 Koropi, Athens
Phone: (+30) 210 66 20 225
service@agrokrip.gr
www.agrokrip.gr

Hungary

GARDENA
Magyarország Kft.
Késmárk utca 22
1158 Budapest
Phone: (+36) 80 20 40 33
gardena@gardena.hu

Iceland

Ó. Johnson & Kaaber
Tunguhalsi 1
110 Reykjavik
ooj@ojk.is

Ireland

Michael McLoughlin & Sons
Hardware Limited
Long Mile Road
Dublin 12

Italy

GARDENA Italia S.p.A.
Via Donizetti 22
20020 Lainate (Mi)
Phone: (+39) 02.93.94.71
info@gardenaitalia.it

Japan

KAKUICHI Co. Ltd.
Sumitomo Realty &
Development Kojimachi
BLDG., 8F
5-1 Nibannoyo, Chiyoda-ku
Tokyo 102-0084
Phone: (+81) 33 264 4721
m_ishihara@kaku-ichi.co.jp

Luxembourg

Magasins Jules Neuberg
Grand Rue 30
Boîte postale 12
L-2010 Luxembourg
Phone: (+352) 40 14 01
info@neuberg.lu

Netherlands

GARDENA Nederland B.V.
Postbus 50176
1305 AD ALMERE
Phone: (+31) 36 521 00 00
info@gardena.nl

Neth. Antilles

Jonka Enterprises N.V.
Sta. Rosa Weg 196
P.O. Box 8200
Curaçao
Phone: (+599) 9 767 66 55
pgm@jonka.com

New Zealand

NYLEX New Zealand Limited
Building 2, 118 Savill Drive
Mangere, Auckland
Phone: (+64) 9 270 1806
lena.chapman@nylex.com.au

Norway

GARDENA Norden AB
Salgskontor Norge
Karihaugveien 89
1086 Oslo
info@gardena.no

Poland

GARDENA Polska Sp. z o.o.
Szymanów 9 d
05-532 Baniocza
Phone: (+48) 22 727 56 90
gardena@gardena.pl

Portugal

GARDENA Portugal Lda.
Recta da Granja do Marquês
Edif. GARDENA Algueirão
2725-596 Mem Martins
Phone: (+351) 21 922 85 30
info@gardena.pt

Romania

MADEX INTERNATIONAL SRL
Soseaua Odaii 117-123,
Sector 1,
București, RO 013603
Phone: (+40) 21 352 76 03
madex@ines.ro

Russia / Россия

АО АМИДА ТТЦ
ул. Мосфильмовская 66
117330 Москва
Phone: (+7) 095 956 99 00
amida@col.ru

Singapore

Hy-Ray PRIVATE LIMITED
40 Jalan Pemimpin
#02-08 Tat Ann Building
Singapore 577185
Phone: (+65) 6253 2277
hyray@singnet.com.sg

Slovak Republic

GARDENA Slovensko, s.r.o.
Bohrova č. 1
85101 Bratislava
Phone: (+421) 263 453 722
info@gardena.sk

Slovenia

Silk d.o.o.
Brodišče 15
1236 Irzin
Phone: (+386) 1 580 93 00
gardena@silk.si

South Africa

GARDENA
South Africa (Pty.) Ltd.
P.O. Box 11534
Vorna Valley 1686
Phone: (+27) 11 315 02 23
sales@gardena.co.za

Spain

GARDENA IBÉRICA S.L.U.
C/ Basauri, nº 6
La Florida
28023 Madrid
Phone: (+34) 91 708 05 00
atencioncliente@gardena.es

Sweden

GARDENA Norden AB
Försäljningskontor Sverige
Box 9003
200 39 Malmö
info@gardena.se

Switzerland / Schweiz

GARDENA (Schweiz) AG
Bitzberg 1
8184 Bachenbülach
Phone: (+41) 848 800 464
info@gardena.ch

Turkey

GARDENA / Dost Diş Ticaret
Mümesillik A.Ş. Sanayi
Çad. Adil Sokak No.1
Kartal - Istanbul
Phone: (+90) 216 38 93 939
info@gardena-dost.com.tr

Ukraine / Україна

ALTSEST JSC
4 Petropavlivska Street
Petropavlivska
Borschahivka Town
Kyiv Svvyatosyn Region
08130, Ukraine
Phone: (+380) 44 459 57 03
upyr@altsest.kiev.ua

USA

Melnor Inc.
3085 Shawnee Drive
Winchester, VA 22604
Phone: (+1) 540 722-9080
service_us@melnor.com

1494-20.960.04 / 0306

© GARDENA

Manufacturing GmbH

D-89070 Ulm

http://www.gardena.com

Free Manuals Download Website

<http://myh66.com>

<http://usermanuals.us>

<http://www.somanuals.com>

<http://www.4manuals.cc>

<http://www.manual-lib.com>

<http://www.404manual.com>

<http://www.luxmanual.com>

<http://aubethermostatmanual.com>

Golf course search by state

<http://golfingnear.com>

Email search by domain

<http://emailbydomain.com>

Auto manuals search

<http://auto.somanuals.com>

TV manuals search

<http://tv.somanuals.com>