

FUSION®

700 SERIES Manual MARINE ENTERTAINMENT SYSTEM

MS-IP700

True Marine Entertainment System for iPod

MS-AV700

True Marine DVD Entertainment System



FUSION®

Specifications and design are subject to change without notice

700 SERIES

WARNINGS AND CAUTIONS

Do not attempt to open the unit's chassis.

There are no user-serviceable parts or adjustments inside.

USING iPod

This unit has been tested with compatible authentic iPod models under normal expected operating conditions, free from any pre-existing defects in either the unit or the iPod.

No responsibility can be taken for use of the unit other than under normally expected operating conditions in conjunction with fully functional and undamaged iPod units which have been manufactured and authorized by Apple Inc.

USB Flash Drives

- **Drive format:** All USB flash drives used with this unit must be formatted to either FAT32 or NTFS format. These are the most commonly used format for USB flash drives.
- **Audio track format:** Audio tracks stored on USB flash drive must be in MP3 format to play on this unit.

Handling CD or DVD disc's (MS-AV700 model only)

- Avoid touching the surface of the disc.
- Avoid exposing the disc to direct sunlight.
- Ensure the disc is clean. If necessary, clean the disc with a clean, dry, soft, lint-free cloth.
- Ensure the disc is not scratched or damaged.
- Ensure the disc is dry when inserted into the unit.

Care and Maintenance

As with all products with a chrome finish exposed to the harsh marine environment, a little care will help preserve the finish and prevent corrosion. FUSION recommends that you clean any salt water and/ or salt residue from the stereo with a damp cloth soaked in fresh water.



© Copyright 2011 by FUSION Electronics Limited. All rights reserved. Product specifications, design and prices are subject to change without notice. Product availability may vary between sales regions. "Made for iPod," "Made for iPhone," mean that an electronic accessory has been designed to connect specifically to iPod, iPhone, respectively, and has been certified by the developer to meet Apple performance standards. Apple is not responsible for the operation of this device or its compliance with safety and regulatory standards. Please note that the use of this accessory with iPod or iPhone may affect wireless performance.

USER INTERFACE AND CONTROLS

CONTROL PANEL LAYOUT



BUTTON DESCRIPTION



Menu



Tuner source



Auxiliary

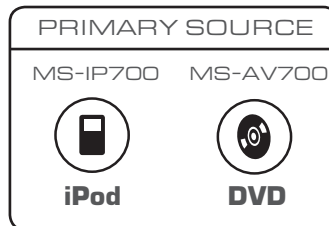

Rewind



Play/Pause



Forward



Power



Mute



Clock



Brightness

selecting audio tracks	25
settings, changing	27
VHF	
background noise, minimizing	19
region, setting	56
scan mode, turning on	19
setting up	19
tuner source, enabling/disabling	57
volume	
control, enabling/disabling in a zone	44
level, adjusting	10
limit, setting in a zone	42
wired remote control	30
zones	
enabling and disabling	40
for controlling balance and levels	41
linking zones 1 and 2	41
naming a zone	42
selecting and setting up	40
setting balance in a zone	41
sub-woofer level, setting	42
volume control, enabling/disabling	41
volume limit, setting	42



sub filter, setting.....	54
tel mute setting.....	56
tuner region, setting.....	56
VHF region, setting.....	56
VHF, setting up.....	19
shuffle setting on iPod, changing.....	23
SiriusXM	
activating the SiriusXM tuner.....	49
channel categories.....	51
channel locking/unlocking.....	53
channels.....	50
lock and arrow icons.....	51
menu options.....	50
parental mode.....	52
source screen.....	16
source screens	
auxiliary input.....	28
described.....	9
iPod.....	20
SiriusXM.....	16
tuner source screens.....	15
specifications for 700 Series.....	60
squelch level, setting.....	19
sub filter, setting.....	54
subtitles setting on iPod, changing.....	24
sub-woofer level	
adjusting.....	11
setting in a zone.....	42
support, sales and service, contact information.....	60
switching the unit on and off.....	8
tel mute setting.....	56
time, displaying.....	12
tone, adjusting.....	13
troubleshooting.....	58
tuner	
AM/VHF sources, enabling/disabling.....	57
listening to.....	15
region, setting.....	56
source screens.....	15
tuning methods.....	16
turning the unit on and off.....	8
USB flash drive	
controlling playback.....	25
format information.....	1
listening to your music.....	24
preparing for input.....	43

ROTARY ENCODER AND MENU KEY

Although the controls of the 700 Series are designed to be intuitive to use, we recommend that you familiarize yourself with the operation of the Encoder and Menu key before using the unit.



ROTARY ENCODER OPERATION

The Encoder can be used in three ways to control the operation of the 700 Series:

1		Rotary Encoder turn
2		Encoder press
3		Encoder press and hold down for at least one second

MENU KEY OPERATION

You can use the Menu key to open or to exit from menus:

	Menu key	Press the Menu key to open a menu.
	Menu exit	<p>In an open menu you can use the Menu key at any time to save changes and exit:</p> <ul style="list-style-type: none"> • Press the Menu to exit from the current menu level or control screen. • Press and hold down the Menu key to exit from the menu completely. Or press any other key. <p>Time out feature: After 10 seconds of inactivity, the menu exits and any changes are saved automatically.</p>

USING THE ROTARY ENCODER AND MENU KEY

You can use the Rotary Encoder and Menu key to adjust levels, access menus and open control screens.

Adjusting levels

Use the Encoder and Menu key to adjust levels on the 700 Series. For example, to adjust the volume level:

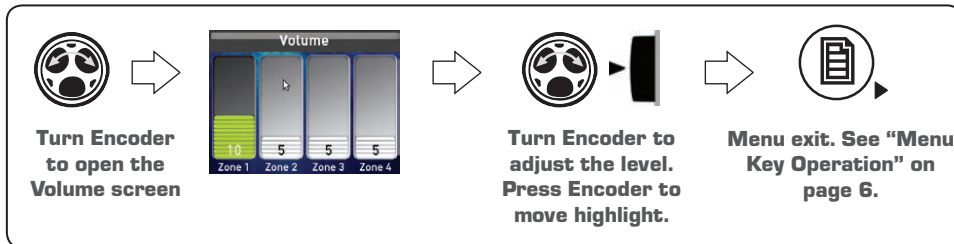

Accessing Menus

Use the Menu key and Encoder to access menus to change settings. For example, to access the Settings menu:

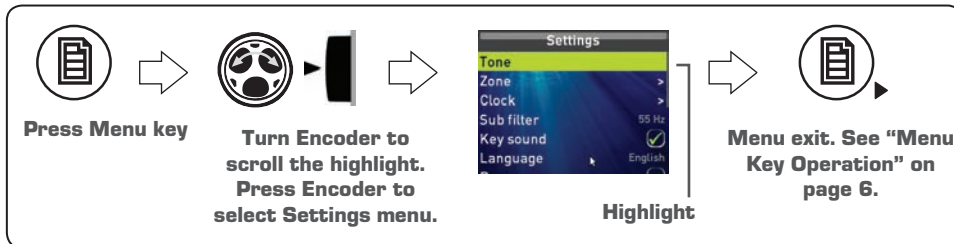

controlling playback.....	22
FAST menu search feature.....	23
playing content.....	20
preparing for iPod input.....	43
repeat setting, changing.....	23
selecting tracks from playlist.....	21
settings, changing.....	23
shuffle setting, changing.....	23
source screen.....	20
subtitles setting, changing.....	24
keys	
control key names and symbols.....	5
encoder key, operating.....	6
key sound (beep) enable/disable.....	55
menu key, operating.....	6
language for menu display, changing.....	55
linking zones 1 and 2.....	41
menus	
accessing.....	7
language for menu display, changing.....	55
menu key, operating.....	6
muting output.....	10
naming a zone.....	42
NMEA2000 data communication.....	29
noise (VHF, background), minimizing.....	19
output level	
adjusting.....	9
muting.....	10
parental mode on SiriusXM.....	52
power save option.....	55
powering the unit on and off.....	8
presets	
adding and removing.....	18
tuning to a channel.....	17
problem solving.....	See troubleshooting
remote controls	
infrared (IR).....	31
wired.....	30
repeat setting on iPod, changing.....	23
scan mode, tuning on.....	19
settings	
AM/VHF sources, enabling/disabling.....	57
clock time, setting.....	48
key sound (beep) enable/disable.....	55
language for menu display, changing.....	55
power save option.....	55

INDEX

700 Series	
control panel, layout	5
ethernet support	30
installing	33
setting up	40
specifications	60
troubleshooting	58
alarm, setting and clearing	13
album artwork setting on iPod, changing	24
auxiliary input	
adjusting input level	47
listening to auxiliary input	28
preparing for auxiliary input	47
source screen	28
brightness of display screen, adjusting	14
channels	
locking/unlocking on SiriusXM	53
skipping on SiriusXM	54
tuning to a channel	17
clock	
display mode - 12 or 24 hour, changing	49
displaying the time	12
setting the time	48
compact disks, handling correctly	1
connections	35
contact information for support, sales & service	60
controls	
control keys	See keys
control panel, layout	5
control screens, opening	8
FUSION-Link	39
infrared remote control	31
wired remote control	30
display screen brightness, adjusting	14
docking unit, for iPod or USB flash drive	44
encoder key, operating	6
ethernet support on 700 Series	30
FAST menu search feature on iPod	23
FUSION-Link control system	29
gain value, adjusting for auxiliary input	47
infrared (IR) remote control	31
installing the 700 Series	33
iPod	
compatibility	1

Opening Control Screens

Use the Encoder to open the Sub Level and Tone control screens to adjust levels:

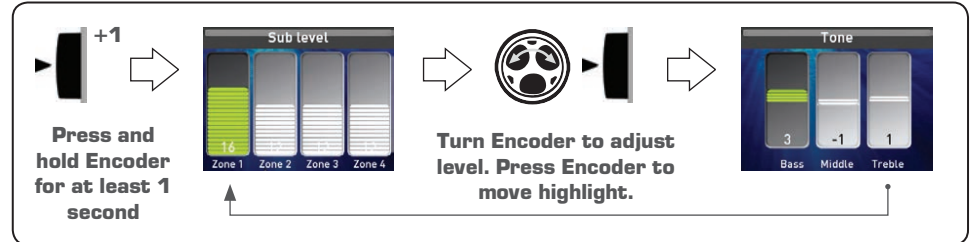

GETTING STARTED

POWERING THE UNIT ON OR OFF

When you power on the 700 Series it will automatically start playing music from the most recently selected input source.

To power the unit on or off.



Power

- Momentarily press the Power key to power on the unit. As the unit starts up, a splash screen is displayed for several seconds, followed by the current input source.
- When the unit is on, momentarily press the Power key to power off the unit.

INPUT SOURCE SCREENS

The 700 Series supports a wide range of input source types, depending on model:

- **MS-IP700.** AM/FM/VHF/SiriusXM; USB and iPod/iPhone via internal dock; auxiliary
- **MS-AV700.** AM/FM/VHF/SiriusXM; CD/DVD; USB and iPod/iPhone via external dock or cable; auxiliary.

Both models are also SiriusXM ready (requires optional Sirius receiver. USA only). For further details of setting up Sirius options see "Sirius XM Radio" on page 49.

When you select one of these sources, the 700 Series displays a source screen, similar to the AM source screen shown in Figure 1 below. The title bar always shows the current time and source name. Other information varies depending on the source type you have selected.

Figure 1 – Example source screen (AM input selected)

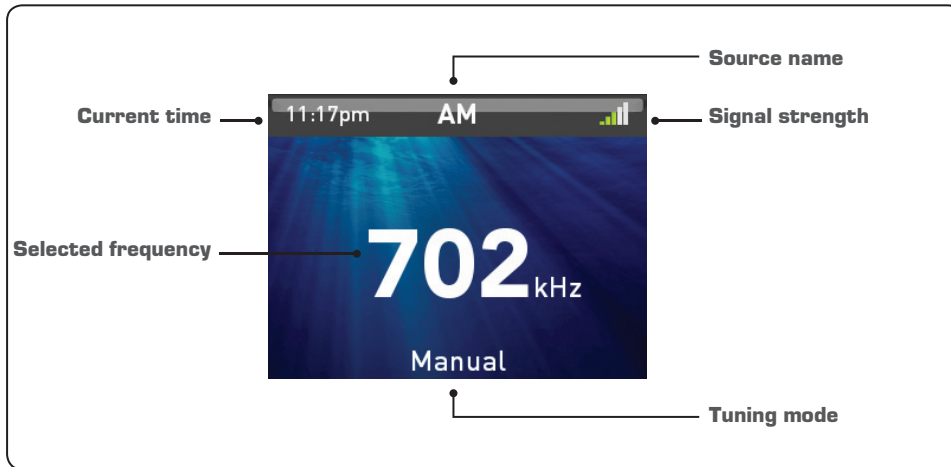

ADJUSTING VOLUME LEVEL

The 700 Series allows you to control speaker output volume level in up to four named areas called Zones. Note: Zone 3 and 4 require additional amplification.

If you wish, you can customize the settings for each Zone by defining a volume limit, a balance setting, a sub-woofer level and a personalized name (such as "Saloon" or "Galley"). For further details see "Zones" on page 40.

LICENSING



Apple, the Apple logo, iPod and iPhone are trademarks of Apple Computer, Inc., registered in the US and other countries.



©2011 Sirius XM Radio Inc. "Sirius XM" and Sirius XM logo are the trademarks of Sirius XM Radio Inc. All rights reserved.



NMEA 2000 – is a Registered Trademark of the National Marine Electronics Association, Inc.

Tuning range

Europe and Australasia

FM radio frequency range 87.5–108 MHz.

Frequency step 100 kHz

AM radio frequency range 522–1620 MHz.

Frequency step 9 kHz

USA

FM radio frequency range 87.5–107.9 MHz.

Frequency step 200 kHz

AM radio frequency range 530–1710 MHz.

Frequency step 10 kHz

Japan

FM radio frequency range 70–90 MHz.

Frequency step 50 kHz

AM radio frequency range 522–1620 MHz.

Frequency step 9 kHz

VHF tuning range

All regions

Frequency range: 156–164 MHz

To adjust the volume level:

1. Turn the Encoder.
 - The Volume screen is displayed with the Current Zone Selection Highlighted (remembered from previous use).
 - The volume is adjusted in the highlighted Zone (or Zones) only.



2. If required, press the Encoder to highlight the next Zone to adjust its volume level.
While the Volume screen is displayed, each press of the Encoder will highlight available Zones in the following order:

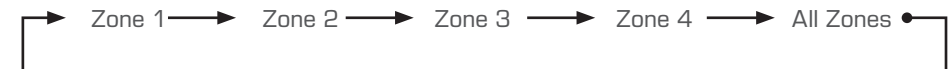

3. When finished, press the Menu key (or leave to time out) to save the current volume level and exit.

MUTING OUTPUT

To mute and unmute the volume:



Mute

- Press the Mute key to mute the audio output. The Mute icon is displayed over the top of the current input source screen.
- Press the Mute key again to unmute the audio output. The volume continues at the previously set level.

ADJUSTING SUB-WOOFER LEVEL AND TONE

Use the Sub level and Tone screens to set the sub-woofer levels and tone. Sub-woofer level can be adjusted for each Zone individually, but tone adjustments affect all Zones.

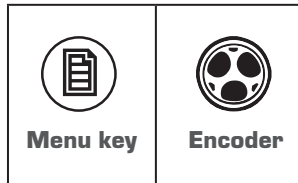

To set sub-woofer levels or tone:

1. Press and hold down the Encoder for at least one second. The Sub level screen is displayed.

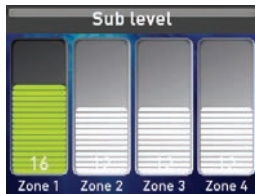

2. Turn the Encoder to adjust the sub-woofer level for the highlighted Zone, as required.
3. Press the Encoder to highlight the next Zone, and adjust as required. When you press the Encoder in the last Zone, the Tone screen is displayed.



SUPPORT, SALES AND SERVICE

FUSION Electronics in New Zealand	+ 64 9 369 2900
FUSION Electronics Australia	+ 61 1300 736 012
FUSION Electronics Europe	+31 76 572 3632
FUSION Electronics USA	+1 623 580 9000

Website: www.fusionelectronics.com

SPECIFICATIONS

FCC compliance statement

This device complies with part 15 of the FCC rules. Operation is subject to the following two conditions:

- this device may not cause harmful interference, and
- this device must accept any interference received, including interference that may cause undesired operation.

General specifications

Operating voltage	10.2–16 VDC negative ground
Fuse rating	15 amp

DVD player

Laser power	Class I
-------------------	---------

Power output

Maximum.....	70 W x 4
26 WRMS per channel at 4 ohms	
45 WRMS per channel at 2 ohms	
Pre-output voltage.....	3 VRMS

Auxiliary input sensitivity

The 700 Series AUX input sensitivity is 1V RMS when gain is set to 0dB.

- Increasing the gain by 6dB doubles the input sensitivity (0.5V RMS for same volume).



Problem	Solution
iPod	
Why does my FUSION Head unit keep locking up when connected to my iPod/iPhone?	<p>If you are experiencing software lock-ups or your unit freezes:</p> <ul style="list-style-type: none"> Reset the Head unit by pressing the reset button inside the face plate. Reset your iPod/iPhone (see Apple website from model-specific information). This should resume normal operation. Make sure you have the latest version of iTunes and the latest operating software in your iPod/iPhone. It is important to update software when Apple releases new versions. If you are connected via a dock, ensure you are using the correct sleeve and the connection to the Head unit is secure.
Will my iPod/iPhone connect to my FUSION product if the battery is flat?	No. It will take a number of minutes for the Apple product to get a minimum level of charge before it can connect and become operational. Please connect and wait for the unit to initialise.
My iPod/iPhone will not connect to the Head unit while in the dock.	<p>If your Head unit displays "Not Connected" while using iPod as input source:</p> <ul style="list-style-type: none"> Check that you are using the correct sleeve combination. If you have the incorrect sleeve combination this could prevent the iPod connector from mating correctly. It could also damage the connector in the dock or your iPod/iPhone itself. If you are uncertain which iPod model you have, go to http://www.apple.com/support/ to get the correct model information for your iPod and sleeve. If you are still unable to connect once you know for certain you have the correct iPod/iPhone–sleeve combination: Ensure that you have the latest version of operating software installed in your iPod/iPhone and the latest iTunes version. To do this, connect your iPod/iPhone to iTunes and it will check and, if necessary, prompt you to download the latest version. If you are still unable to connect once you have confirmed that you have the latest software or you have updated your iPod/iPhone: Reset the iPod/iPhone (see the user manual for your Apple product) and also reset the Head unit (see FUSION user manual). If you are still unable to connect: Contact your FUSION dealer or contact FUSION via the tech email on the FUSION website.
My Apple Device has gone into thermal protection	<p>Caution: The internal dock temperature of the MS-IP700 will be slightly higher than the ambient temperature outside the head unit. Should your Apple iPhone or iPod shut down due to exceeding the operating temperature please carefully remove it from the MS-IP700 and allow it to cool down before using again. Using your Apple device in a low charged state will increase the heat generated whilst it is charging. For more information relating to this please follow the Apple support web site link below. http://support.apple.com/kb/ht2101</p>

- Turn the Encoder to left or right to adjust the Bass level, if required.
- Press the Encoder to highlight each tone control, and adjust as required. When you press the Encoder on the Treble tone control, the Sub level screen is displayed again.
- Press any key to exit

DISPLAYING THE CLOCK

Use the Clock key to display the current time. If the time is incorrect, see "Clock Setting" on page 48.

Note: The current time is also displayed in the title bar of each input source screen.

 <p>Clock</p>	<ul style="list-style-type: none"> Press the Clock key to display the current time 
---	---

SETTING AND CLEARING THE ALARM

Use alarm mode to turn on the 700 Series at a pre-defined time.

When the alarm is activated, your 700 Series will play the last selected input source at the volume level in use when the unit was turned off.

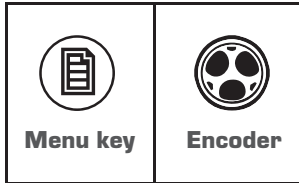

To set the alarm:

1. Press the Menu key.
2. Turn and then press the Rotary Encoder to select **Settings > Clock > Set alarm**.
3. Do one or both of the following:
 - Turn the Rotary Encoder to change the hour setting.
 - Press the Rotary Encoder to move to the minutes field. Adjust the minutes setting as required.
 - Press the Rotary Encoder to move to the AM/PM field (if enabled). Turn encoder to select AM or PM.
4. Press the Menu key to save the time settings and exit (the time out feature does not operate here).
5. Highlight the **Alarm enabled** checkbox and press the Encoder to enable it ().
6. Press any key to exit

To clear the alarm:

1. Press the Menu key.
2. Turn and then press the Rotary Encoder to select Settings > Clock.
3. Highlight the Alarm enabled checkbox and press the Rotary Encoder to disable it ().
4. Press any key to exit

APPENDICES

TROUBLESHOOTING

Problem	Solution
General	
The unit does not respond to key presses.	<ul style="list-style-type: none"> • Reset the unit by pressing the Reset button inside the control panel door. <p>The diagram shows the back of the control panel with the door open. A white circle highlights a small button on the inner surface of the door, with a line pointing to it from the label 'Reset Button'.</p>
What is the best way to prevent corrosion on my 700 Series chrome finish?	As with all products with a chrome finish exposed to the harsh marine environment, a little care will help to preserve the finish and prevent corrosion. FUSION recommends that you clean any salt water and/or salt residue from the front panel with a damp cloth soaked in fresh water.
iPod	
Why do I get an error message when I dock my iPhone to my FUSION iPod inside product?	Some iPhone models may intermittently display the message: "This accessory is not made to work with the iPhone. Would you like to turn on airplane mode to reduce audio interference? You will not be able to make or receive calls." when initially docked with any FUSION iPhone compatible product. All FUSION iPhone-supported products have been tested and certified by Apple, and passed Apple's stringent "Works with iPhone" self-certification test. Despite this message, all FUSION iPhone-compatible products are fully functional and compatible with Apple's iPhone product line. Please choose "NO", or simply wait for this message to time out.
My Head unit keeps turning itself off then back on when connected to my iPod	This could be happening due to corrupt files and/or a corrupted version of the operating software on your iPod. If you connect to your computer you may get a message on the iPod similar to this: "The iPod 'John's iPod' could not be updated because the firmware was corrupt. Click this link to get a step-by-step guide to solve this issue: http://support.apple.com/kb/ts1813 ."

Sources

Use this option to turn the AM or VHF tuner source on or off, if required. This is useful if you only listen to FM and do not wish to step through AM and VHF when selecting a tuner source.

To enable or disable the AM or VHF tuner sources:

1. Press the Menu key.
2. Turn and then press the Encoder to select the **Settings > Sources**.
3. If required, press the Encoder to enable the AM source () or disable the AM source ().
4. If required, turn the Encoder to select **VHF** then, press the Encoder to enable the VHF source () or disable the VHF source ().
5. Press any key to exit.

ADJUSTING SCREEN BRIGHTNESS

Note: LCD and button backlight brightness can be linked to the ambient lighting level. For further details, see “Installing the 700 Series” on page 33.



To adjust the brightness of the display screen:

1. Press the Brightness key. The Brightness screen is displayed.

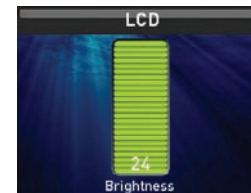

2. Turn the Rotary Encoder to adjust the brightness setting.
3. Press any key to exit

TUNER

LISTENING TO THE TUNER

To select one of the available tuner bands:

 <p>Tuner</p>	<ul style="list-style-type: none">Press the Tuner key to select input from each of the following in turn: AM, FM, VHF or SiriusXM (requires optional Sirius tuner module SVX-100, USA only). The applicable input source screen is displayed for each band.
--	---

TUNER SOURCE SCREENS

AM/FM/VHF

An example of a typical tuner input source screen is shown in Figure 2 below.

Figure 2 – Example AM band input source screen

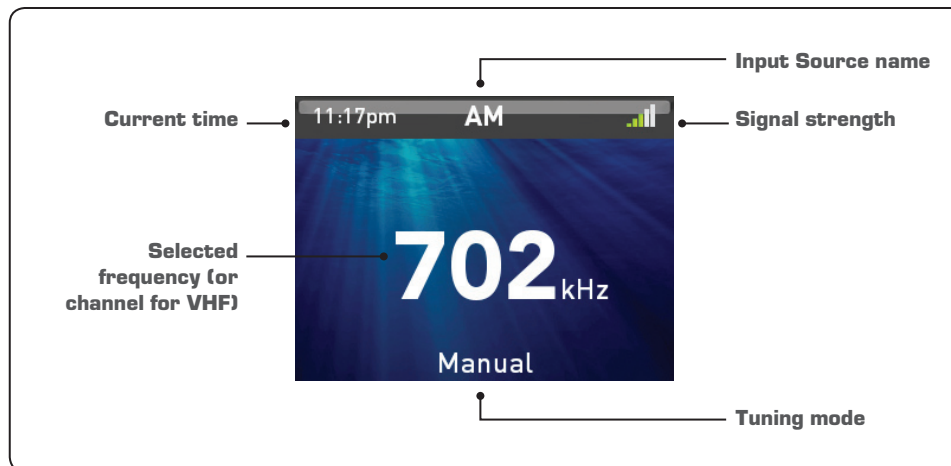

Tel mute

Use this option to control which action is taken when the 700 Series is connected to a cellphone hands-free kit.

To change the Tel mute setting:

1. Press the Menu key.
2. Turn and then press the Encoder to select **Settings > Tel mute**.
3. Turn the Encoder to select the required option:
 - **Mute**. Mutes the audio output from the 700 Series when a call is received on your cellphone.
 - **Aux**. Allows the received call to be broadcast through the Auxiliary input on the 700 Series.

Note: This feature may not operate all available hands-free kits. Hands free kit must be connected to the TELMUTE input and AUX input.
4. Press the Rotary Encoder to save the setting and exit.
5. Press any key to exit

Tuner region

Use this option to select the correct region .

To change the tuner region setting:

1. Press the Menu key.
2. Turn and then press the Rotary Encoder to select **Settings > Tuner region**.
3. Turn the Rotary Encoder to select the required region.
4. Press the Rotary Encoder to save the setting and exit.
5. Press any key to exit

VHF region

Use this option to select the correct VHF tuning region.

To change the VHF region setting:

1. Press the Menu key.
2. Turn and then press the Rotary Encoder to select the **Settings > VHF region**.
3. Turn the Rotary Encoder to select the required region.
4. Press the Rotary Encoder to save the setting and exit.
5. Press any key to exit

To change the sub filter setting:

1. Press the Menu key.
2. Turn and then press the Rotary Encoder to select **Settings > Sub filter**.
3. Turn the Rotary Encoder to select the required filter frequency.
4. Press the Rotary Encoder to save the setting and exit.
5. Press any key to exit

Key sound

The 700 Series makes a short beeping sound when any key is pressed. This feature can be turned on or off, as required.

To enable or disable the key sound:

1. Press the Menu key.
2. Turn and then press the Rotary Encoder to select Settings > Key sound.
3. Press the Rotary Encoder to turn on key sound (audible beeps) () or turn off key sound (silent) ().
4. Press any key to exit

Language

The 700 Series can display menus and screens in English, Dutch, French, German, Italian or Spanish.

To select the required display language:

1. Press the Menu key.
2. Turn and then press the Encoder to select **Settings > Language**.
3. Turn the Encoder to select the required language.
4. Press the Encoder to save the setting and exit.
5. Press any key to exit

Power save

If you are operating the 700 Series on battery power, you can turn on the power save option to reduce drain on the battery. The LCD screen shuts down automatically after 1 minute of inactivity (press any key to restore display).

To enable or disable power saving mode:

1. Press the Menu key.
2. Turn and then press the Encoder to select **Settings > Power save**.
3. Press the Encoder to turn on power saving () or turn off power saving ().
4. Press any key to exit

SiriusXM

An example of the SiriusXM input source screen is shown in Figure 3 below.

Figure 3 – Example SiriusXM input source screen

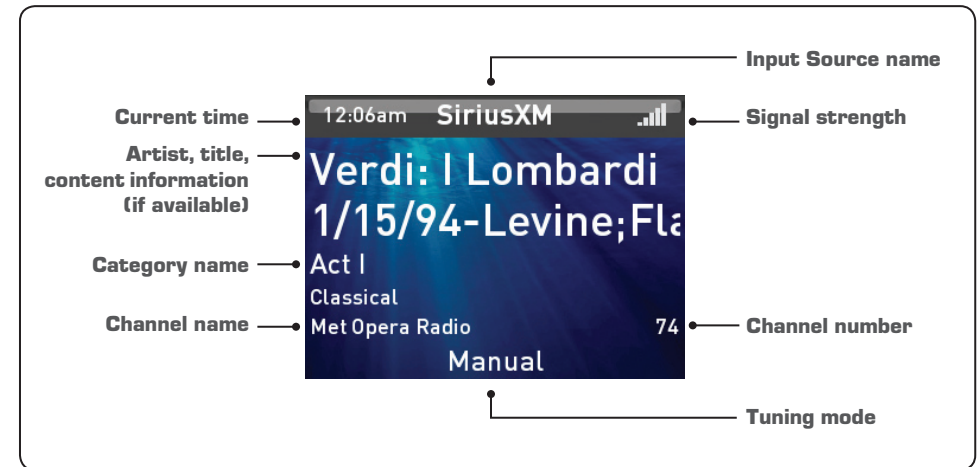

TUNING METHODS

You can use three methods to tune the 700 Series: manual, automatic and preset.

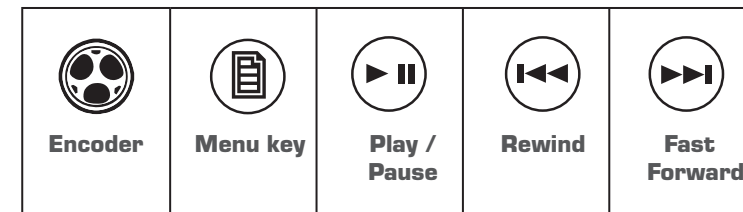

To tune to a required frequency, channel or preset:

Press the Play / Pause key to step through the available tuning methods for each band:

Note: Preset function only available if 2 or more presets are saved

Tuning Method	Applies to...	When tuning with this method...
Manual	All bands	<ul style="list-style-type: none"> Press the Forward or Backward key to step through the range of frequencies or channels one at a time. Press and hold down the key for rapid scanning of frequencies or channels.
Manual	SiriusXM	<ul style="list-style-type: none"> Press the Forward or Backward key to step through all channels one at a time.
Category	SiriusXM	<ul style="list-style-type: none"> Press the Play / Pause, Forward or Backward key to step through the channels in the selected category. Only available when a category is selected in the Category menu item. For further details see "Category" on page 51.
Auto	AM/FM	<ul style="list-style-type: none"> Press the Forward or Backward key to start searching for available stations. Press the Play / Pause, Forward or Backward key to stop the search.
Scan	VHF	<ul style="list-style-type: none"> Scans through preset channels, pausing on a channel while it is transmitting. Only available if there are two or more presets saved. If there is any background noise, the scan will stop. For further details see "Minimizing background noise" on page 19. Press the Play / Pause, Forward or Backward key to turn scan mode off. For further details see "Turning scan mode on" on page 19. <p>NOTE: The Scan function is activated from the settings menu, see 'Setting up VHF'</p>
Preset	All bands	<ul style="list-style-type: none"> Press the Forward or Backward key to step through available presets. Only available if there are two or more presets saved. To tune to a specific preset: <ul style="list-style-type: none"> a. Press the Menu key, and then press the Encoder to select Presets. b. Turn the Encoder to highlight the required preset. c. Press the Encoder to tune to the highlighted preset. <p>For further details, see "Adding and Removing Presets" on page 18.</p>

- (if required) turn and then press the Encoder to select **Parental > Unlock**. Enter your access code.
- Select the **Lock/Unlock** menu item.
- Turn the Encoder to highlight a channel then press the Encoder to lock () or unlock () the channel, as required.
- Press the Menu key (or leave to time out) to exit.

Channel Skipping

Channel skipping gives the user the ability to set a channel to be skipped / missed while navigating via the Forward and Back key in the Sirius Source Screen. The user still able to navigate to a skipped channel via the channel list found in the menu.

To set or unset a channel from being skipped:

- Press the Menu key.
- (if required) turn and then press the Encoder to select Parental > Unlock. Enter your access code.
- Select the Skip/UnSkip menu item.
- Turn the Encoder to highlight a channel then press the Encoder to turn on () or turn off () skip, as required.
- Press the Menu key (or leave to time out) to exit.

ADVANCED SETTINGS

The settings described in this section are usually set up when the unit is installed and not changed again.

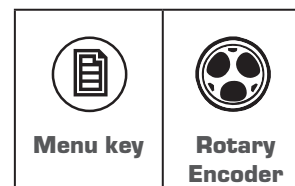

Sub filter

Use the sub filter setting to control the sub-woofer cutoff frequency. Audio signals above the selected frequency will not be passed on to the sub-woofer. The sub filter settings apply to all sub-woofer outputs.

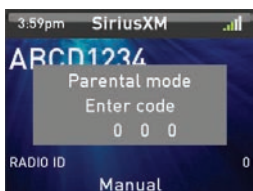

3. Enter the old (current) access code by turning the Encoder to change the highlighted digit, then press the Encoder to select the next digit. When you have entered all four digits correctly, you will be prompted to enter the new access code.
4. Enter the new access code by turning the Encoder to change the highlighted digit, then press the Encoder to select the next digit. When you have entered all four digits correctly, you will be prompted to enter the new access code for a second time.
5. Press the Menu key (or leave to time out) to save the new code and exit.

Channel Locking / unlocking

Any channels (not just mature content channels) can be locked. Locked channels cannot be seen in the Sirius Source Screen or when changing channels with the Forward and Backward keys. Locked channels can be accessed in parental mode only.

To access a locked channel:

1. Press the Menu key.
2. Do one of the following:
 - a. Turn and then press the Encoder to select **Parental > Unlock**.
 - OR
 - a. Turn and then press the Encoder to select **Parental > Channels**.
 - b. Tune to the channel you require. This channel will display a padlock icon, to the right of the screen.
3. Enter your access code.
4. Press the Menu key to return to the Sirius Source Screen.

To lock or unlock a channel:

1. Press the Menu key.

ADDING AND REMOVING PRESETS

The 700 Series allows you to set up your favorite AM/FM stations, VHF or SiriusXM channels as presets for easy recall.

Note: Up to 15 presets can be stored for each radio band.



To add a new preset:

Do one of the following.

1. Tune the 700 Series to the required frequency or channel.
 2. Press and hold down the Play / Pause key. The message: "Preset saved" is displayed briefly.
- or**
1. Press the Menu key.
 2. Turn and then press the Encoder to select **Presets > Save current**. The message: "Preset saved" is displayed briefly.

To remove one or more presets:

1. Press the Menu key.
2. Turn and then press the Encoder to select **Presets > Remove presets**.
3. Do one of the following (there is no warning or confirmation prompt before deletion):
 - Select **Remove all presets** and press the Encoder to remove all current presets.
 - Select a preset and press the Encoder to remove the selected preset.
4. Press any key to exit

SETTING UP VHF

Note: A marine FM antenna is required for VHF reception, DO NOT connect to a VHF splitter.

Minimizing background noise

Use the Squelch feature to reduce background noise on VHF input. Select a VHF channel, and then adjust the squelch control while there is nothing being transmitted on the channel.

To set the squelch level:

1. Press the Menu key.
2. Turn and then press the Encoder to select **Squelch**.
3. Turn the Encoder to adjust the squelch level:
 - Increase the squelch level until the background noise is muted.
 - Reduce the squelch level if the audio transmission is not heard.
4. Press any key to exit

Turning scan mode on

Scan mode allows the 700 Series to scan through preset VHF channels, looking for active channels.

Note: If the Squelch level is adjusted so that you can hear a constant hissing sound, the unit will not scan correctly. To correct this, see “Minimizing background noise”, above.

To turn scan mode on:

1. Press the Menu key.
2. Turn the Encoder to highlight the **Scan** menu item.
3. Press the Encoder to select the checkbox (). Scan mode is turned on and the menu exits automatically.

Note: Pressing the Play / Pause, Forward or Rewind key turns scan mode off.

- To disable the Category tuning method, press the Encoder to select All channels. The Sirius Source Screen is displayed with the Tuning mode indicated set to 'Manual'.

4. Press the Menu key to exit the current menu or press and hold the Menu key to close the menu completely.

Parental mode

Parental mode provides a way of preventing access channels marked by Sirius as “Mature” or “Locked”. You must enter a 4-digit access code to enter Parental mode. When in Parental mode you can also change the 4-digit access code.

Note: The factory setting for the access code is 0000. You can reset the access code to 0000 by pressing and holding down the Mute key for 15 seconds.

To enter Parental menu:

1. Press the Menu key.
2. Turn and then press the Encoder to select Parental > Unlock. The following access screen is displayed with the first digit highlighted:

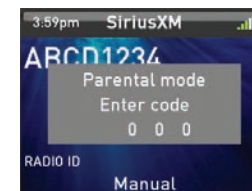

3. Enter the access code by turning the Encoder to change the highlighted digit, then press the Encoder to select the next digit. When you have entered all four digits correctly, Parental mode is unlocked.

To change the Parental mode access code:

1. Press the Menu key.
2. Turn and then press the Encoder to select Parental > Change code. The following access screen is displayed with the first digit highlighted:

Special icons

When you select a channel in the channels list you may see two different icons at the right hand side of the list.

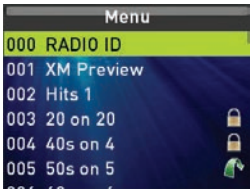

- The padlock icon means the channel is locked or considered mature content. If you select this channel you will be asked to unlock parent mode, if it is not already unlocked.
- The green arrow icon means the channel has been setup to be skipped when using the Forward and Backward keys in the Sirius Source Screen. However, you can always access a skipped channel via this channel list.

Category

You can use the Category menu item to control which categories of channels are available (Rock, for example) when you are using the Category tuning method (see "Tuning Methods" on page 16).

To select a Category:

1. Press the Menu key.
2. Turn and then press the Encoder to select Category.
3. Do one of the following:
 - To enable the Category Tuning method, turn and then press the Encoder to select the required category name, "Rock" for example:

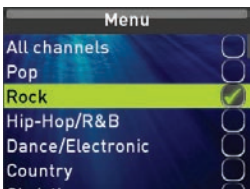



The Sirius Source Screen is displayed with the Tuning mode indicator set to 'Category'.

iPod

PLAYING CONTENT

Before you can use your iPod as an input source you must first connect the device to the 700 Series. For further details, see "Preparing for iPod or USB Input" on page 43.

To listen to input from your iPod:

MS-IP700	 iPod	<ul style="list-style-type: none"> • Press the iPod key. The iPod input source screen is displayed. The most recently selected track starts playing at the current play point.
MS-AV700	 Auxiliary	<ul style="list-style-type: none"> • Press the Auxiliary key. Keep pressing the key until the iPod source screen is displayed.

iPod SOURCE SCREEN

An example of a typical iPod input source screen is shown in Figure 4 below.

Figure 4 – Example iPod input source screen



CONTROLLING iPod PLAYBACK

Selecting tracks from a playlist

There can be thousands of tracks stored on an iPod, so you need to select the tracks you wish to play from one of the groupings available (such as Playlists, Artists, Albums). For example, to select tracks by artist:

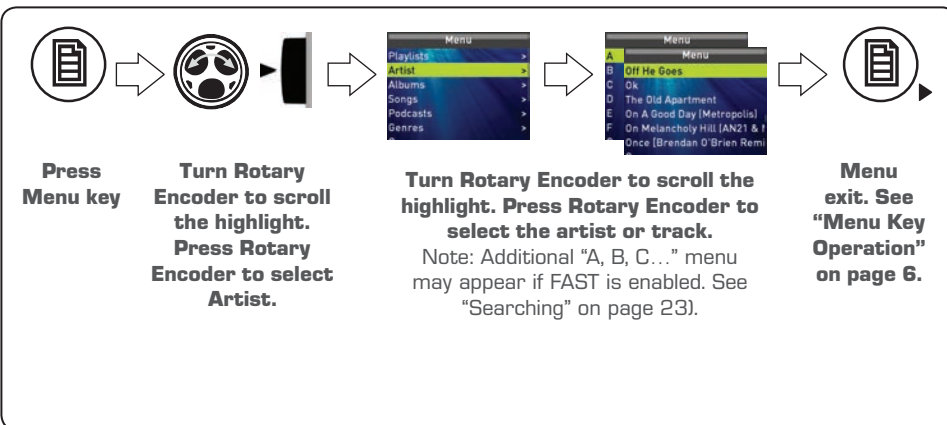

Sirius XM menu options

Press the Menu key to display the Sirius XM menu that provides access to various control options. Read on to learn more about using the Channels, Category and Parental options.

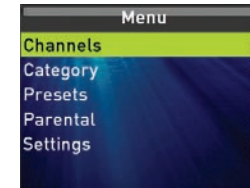

Channels

You can use the Channels menu item to access a specific channel either through All channels or via a specific category.

To select a channel:

1. Press the Menu key.
2. Turn and then press the Encoder to select **Channels**. The Channels menu is displayed.

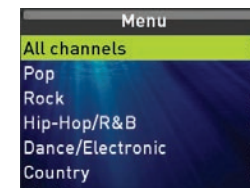

3. Do one of the following:
 - To select a channel from the list of all channels, press the Encoder to select All channels.
 - To select a channel in a specific category, turn and then press the Encoder to select a category name (Pop, for example).
4. Turn and press the Encoder again to select the channel you wish to play.
5. Press the Menu key to exit the current menu or press and hold the Menu key to close the menu completely.

5. If required, press the Encoder to move to the AM/PM field (displayed in 12 hour clock mode only. See Step 7 below). Turn the Encoder to change the AM/PM setting.
6. Press the Encoder to save the time and exit (the time out feature does not operate here).
7. If you want to use the 24 hour clock display (13:09 rather than 1:09 pm, for example), make sure the **24 hour** checkbox is selected (). See Steps 2–3 below.
8. Press the Menu key (or leave to time out) to save the current setting and exit.

To select 12 or 24 hour clock display mode:

1. Press the Menu key.
2. Turn and then press the Encoder to select Settings > Clock > 24 hour.
3. Press the Encoder to select the 24 hour clock display (13:09 rather than 1:09 pm, for example) ()
4. Press any key to exit

SIRIUS XM RADIO

The 700 Series is ready to connect to a Sirius XM radio receiver (USA only). The Sirius XM tuner is an optional extra that must be purchased separately. Sirius XM Tuner Model SVX100 is required.

Activating your Sirius XM tuner

You must activate the Sirius XM tuner before you can begin to receive the Sirius XM Radio Service.









In order to activate your radio subscription, you will need the Sirius XM ID (SXID) which uniquely identifies your tuner. The 12 digit SXID is displayed on the LCD on initialization. MS-IP700 and MS-AV700 will display the SXID on Channel 0.

Power on your system and make sure that you are receiving good signal, you are able to hear audio on the Sirius XM Preview channel (Ch-184)

Note: Have your credit card handy and contact Sirius XM on the Internet at <https://care.siriusxm.com/> and follow the prompts to activate your subscription. You can also call Sirius XM toll-free at 1-866-635-2349. Once activated, you will be able to begin enjoying Sirius XM Radio's digital entertainment and can tune to other channels.

Controlling Playback

You can control iPod playback with the Play / Pause, Forward and Rewind keys. The selected track starts playing automatically.

If you want to:	Use:	Notes:
Play / Pause a track	 Play / Pause	<ul style="list-style-type: none"> • Press the key to pause the current track. The pause icon () is displayed top right in the input source screen. • Press the key again to resume play. The play () icon is displayed in the input source screen.
Skip to next track	 Forward	<ul style="list-style-type: none"> • Press the key to skip to the start of the next track.
	 Rewind	<ul style="list-style-type: none"> • Press the key to skip to the start of the current track. • Press the key twice to skip to the start of the previous track.
Fast forward / rewind	  Forward, or Rewind	<ul style="list-style-type: none"> • Press and hold down the key to fast forward (or Rewind) the playback. The fast forward () (or Rewind) icon is displayed in the input source screen.

CHANGING iPod SETTINGS

Additional iPod control features are available through the **iPod settings** menu.

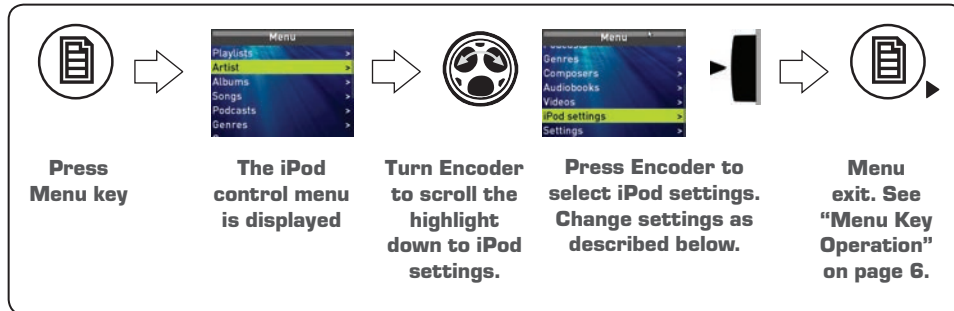

To change a setting in the iPod settings menu:

Turn and then press the Rotary Encoder to select one of the following settings to change. Then:

- Turn and then press the Rotary Encoder to select the required setting

Repeat

- **Off.** Repeat mode is turned off
- **One.** Repeat the current song
- **All.** Repeat all songs in the current playlist

Shuffle

- **Off.** Random play shuffle is turned off
- **Tracks.** Shuffle tracks on the current album
- **Albums.** Shuffle albums in the current playlist

Searching

If your iPod contains more than 100 artists, songs or albums, you can use FUSION Alpha Search Technology (FAST) to quickly navigate by letter or number. Use this option to control when to display the FAST menu.

- **Off.** The song/album list is displayed but not the FAST menu.
- **100–800.** Display the FAST menu when your iPod contains more than the selected number of items.

Recommended settings are listed below:

AUX Device	AUX gain setting (dB)
Portable media player with headphone output	-9dB to -6dB
CD/DVD player with line output	-6dB
Portable media player with line output	0dB
Game console with line output	0dB
Older audio/visual equipment with line output (for example: VHS or cassette deck)	6dB to 9dB

Note: When using the headphone output of a portable device, it may be necessary to adjust the device's own volume control for best audio quality.

CLOCK SETTING

The 700 Series unit has a built-in clock that can display the time in 12-hour or 24-hour mode.

To set the clock:

1. Press the Menu key.
2. Turn and then press the Encoder to select **Settings > Clock > Set clock**.
The Set Clock screen is displayed.

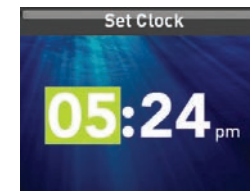

3. Turn the Encoder to change the hour setting.
4. If required, press the Encoder to move to the minutes field. Turn the Encoder to change the minutes setting.

Supported iPod sleeves

Full details of included iPod sleeves are printed on a separate card included in the box with the 700 Series.

PREPARING FOR AUXILIARY INPUT



Connecting auxiliary device

Connect the auxiliary device to the AUX IN cable (White and Red RCA sockets) at the rear of the 700 Series.

Adjusting Auxiliary input level

Many different types of auxiliary device (TV, DVD, Game Console, Media player) can be connected to the 700 Series, and these devices will have either a line output or headphone output jack.

To allow for the wide range of input levels from these devices, the AUX input has adjustable input gain. This should be adjusted to achieve a similar volume level to the other (fixed gain) input sources on the 700 Series.

To adjust auxiliary input level by changing the gain:

- Increase gain (volume) by pressing the Forward key (1 dB steps up to 9dB)
- Decrease gain by pressing the Rewind key (1 dB steps down to -9dB).

Subtitles

- **Off.** Subtitles are not displayed when the iPod is playing video
- **Subtitles.** Subtitles are displayed
- **Closed caption.** Provides additional information about the track (if available)

Album artwork

- Display album artwork if available
- Do not display album artwork

USB FLASH DRIVE

LISTENING TO YOUR MUSIC

Before you can use the USB flash drive as an input source you must first insert the device into the 700 Series. For further details, see "Preparing for iPod or USB Input" on page 43.

To listen to music from your USB flash drive:

MS-IP700	 Auxiliary	• Press the Auxiliary key. The USB input source Storage screen is displayed.
MS-AV700		• Press the Auxiliary key. Keep pressing the key until the USB source screen is displayed.

USB SOURCE SCREEN

An example of a typical USB flash drive input source screen is shown in Figure 5 below.

Figure 5 – Example USB flash drive source screen

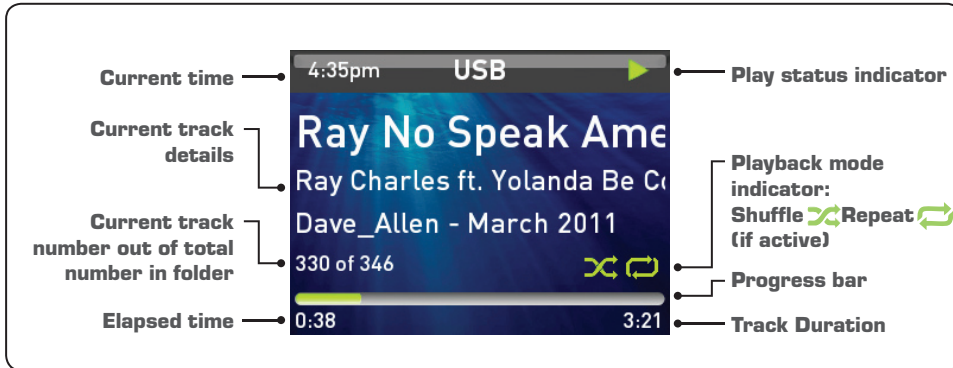

CONTROLLING USB FLASH DRIVE PLAYBACK

Selecting audio tracks from USB flash drive

You can store audio tracks (MP3 format only) on a USB flash drive for playback on the 700 Series. Audio tracks can be stored in folders on the flash drive and selected for playback, as required. The flash drive must be formatted to FAT32 or NTFS format (these are the most commonly used flash drive format).

For example, to select a Folder then track.:

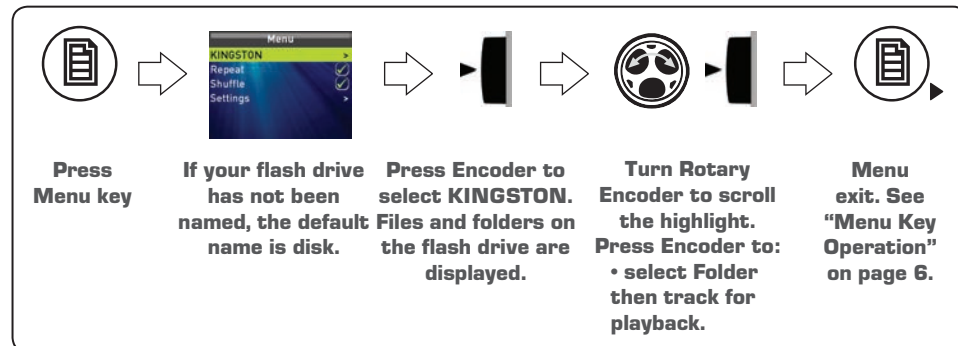

To connect your iPod or USB flash drive to the 700 Series via a MS-DKIPUSB dock:

1. Press the door catch and open the door of the dock.



Portable media device dock (MS-DKIPUSB)

2. Insert your USB flash drive into the USB connector or insert your iPod in its correct sleeve. Make sure that the device is firmly pushed onto the connector socket.
3. Close the door firmly.
4. Select input from the device, as required.

To connect your iPod to the 700 Series via an Apple Sync cable (AV700 only):

1. Plug the USB plug of your Sync Cable into the USB socket of the external USB cable on the MS-AV700.
2. Connect your iPod or iPhone to the 30-pin Connector of your Apple Sync Cable.
3. Select input from the device, as required.

2. Insert your USB flash drive onto the USB socket or insert your iPod in its sleeve (see iPod compatibility sheet supplied separately)). Make sure that the device is firmly pushed onto the connector socket.



3. Close the control panel door firmly.
4. Select input from the device, as required.

MS-AV700 model

To connect your iPod, you will need:

- Portable media device dock (MS-DKIPUSB), or
- Apple Sync Cable.





To connect your USB flash drive, you will need:

- Portable media device dock (MS-DKIPUSB), or
- USB cable (the USB cable on the MS-AV700 unit must be accessible).

Note: If you select iPod or USB input without first connecting the device, the message "Not connected" is displayed on the screen.

Controlling playback

You can control playback with the Play / Pause, Forward and Rewind keys. The selected track starts playing automatically.

If you want to:	Use:	Notes:
Play / Pause a track	 Play / Pause	<ul style="list-style-type: none"> • Press the key to pause the current track. The pause icon () is displayed top right in the input source screen. • Press the key again to resume play. The play (▶) icon is displayed in the input source screen.
Skip	 Forward	<ul style="list-style-type: none"> • Press the key to skip to the start of the next track.
	 Rewind	<ul style="list-style-type: none"> • Press the key to skip to the start of the current track. • Press the key twice to skip to the start of the previous track.
Fast forward / rewind	  Forward, or Rewind	<ul style="list-style-type: none"> • Press and hold down the key to fast forward (or Rewind) the playback. The fast forward (▶▶) (or Rewind) icon is displayed in the input source screen.

CHANGING USB FLASH DRIVE SETTINGS

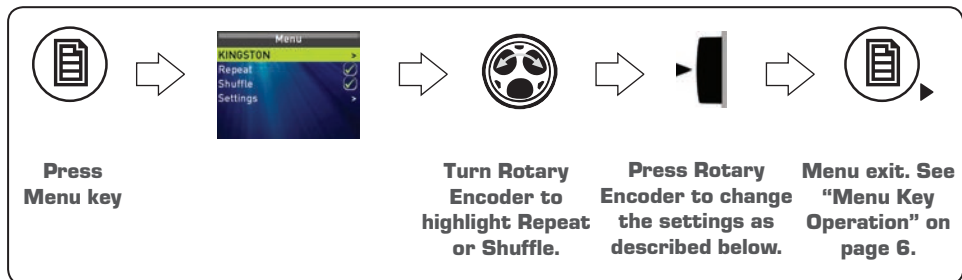

To change a highlighted setting in the USB settings menu:

1. Press the Encoder to toggle the value on or off.

Repeat

- Repeat mode is turned off.
- Repeat the current selection.

Shuffle

- Random play shuffle is turned off.
- Shuffle tracks in the current folder.

MS-IP700 model

Note: If you select iPod or USB input without first inserting the device, the message "Not connected" is displayed on the screen.

Before inserting iPod

To avoid damage and ensure safe operation, please read the following information before using your iPod.

- Please ensure iPod dock connector is clean, dry and free from damage.
- Check that the unit's iPod dock is free from obstructions.
- Insert correct sleeve combination to match your iPod (never insert iPod without the correct sleeve).
- Ensure iPod is inserted with display facing upwards.
- Never force your iPod into the dock, if the iPod does not mate with reasonable ease, the sleeve/iPod combination is most likely incorrect.
- Take care when removing iPod from unit as surfaces may be warm.

To insert your iPod or USB flash drive:

1. Press the door catch and open the control panel door.



To enter the name for the selected Zone:

- a. Select the Name menu item. The current Zone name is displayed with the first character highlighted.

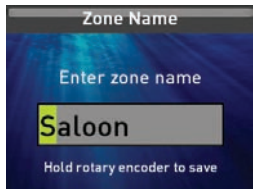

- b. If required, press the Forward (or Backward) key to highlight the character you wish to change.
- c. Turn the Encoder to display the required value for the highlighted character.
- d. Press the Encoder to accept the displayed value and move to the next character.
- e. Repeat Steps b–d until you have worked through all the characters you wish to change.
- f. Press and hold down the Encoder to save the changes and exit.

PREPARING FOR iPod OR USB INPUT

This section describes how to prepare for iPod and USB input for the MS-IP700 and MS-AV700 models.

When using your iPod with either model:

- Always disconnect your iPod from the unit when not in use and do not leave in your vessel. This helps reduce risk of theft or damage as vessel cabins can reach extreme temperatures.
- Do not remove iPod or use stereo in a distracting manner while operating the vessel. Check and obey all marine laws in association with use.

AUXILIARY INPUT

LISTENING TO AUXILIARY INPUT

The 700 Series can accept audio input from a TV, games console, portable player, computer, DVD player or any compatible device.

To listen to input from an alternate auxiliary device:

 Auxiliary	<ul style="list-style-type: none">• Press the Auxiliary key:• On the first press:<ul style="list-style-type: none">MS-IP700: the USB input source Storage screen is displayed.MS-AV700: the iPod input source screen is displayed.• On the second press:<ul style="list-style-type: none">MS-AV700: the input source screen for an alternate auxiliary input device is displayed (see below).
---	---

AUXILIARY SOURCE SCREEN

The input source screen displayed when you select alternate auxiliary input will depend on how the unit has been set up. The screen to display can be selected from one of the screens shown in Figure 6, below.

Figure 6 – Examples of auxiliary input source screens



Input level for the selected device can be adjusted if required. For further details, see "Preparing for Auxiliary Input" on page 47.

ADDITIONAL FEATURES

FUSION-Link

FUSION-Link has the ability to fully control on-board FUSION Entertainment systems (Supported models), by utilizing FUSION-Link capable multi-function displays installed at the helm, flybridge or nav station of the vessel, providing integrated entertainment control and a less cluttered console.

You can control one or more FUSION-Link capable stereo units from a single location on the boat with the touch of a button. FUSION-Link operates over existing industry standard networks including Ethernet, NMEA2000 and WiFi.

Link Zones or manage the entire audio system from the steering station on the boat. The partnered multi-purpose display becomes the portal to which all audio on the vessel is controlled, no matter where on the vessel the stereo is installed. The FUSION-Link equipped stereo can be installed out of sight if space is an issue and users need to visit the unit only to replace removable media.

For a list of FUSION-Link capable products from companies that are partnering with FUSION, please visit www.fusionelectronics.com for further details.

TOTAL AUDIO CONTROL VIA NMEA2000

NMEA2000 is the most popular marine standard for data communication within vessels. It has become the standard for sending navigation and engine management data within vessels. FUSION introduces an industry-first product by incorporating NMEA2000 functionality in its audio remote control devices. This will enable the user to monitor a series of available NMEA sentences. Visit www.fusionelectronics.com for a full list of supported NMEA sentences

FUSION MS-NRX200 Remote Control

The MS-NRX200 Remote Control has a full-featured user interface identical to the main unit. To the user, operating the entertainment system from the remote control is identical to operating it from the main unit. It includes a full size LCD screen and provides full functionality for navigating iPods.

The remote control will also serve as an NMEA repeater displaying NMEA navigation data or vessel performance data from other NMEA devices on the network.

Volume limit

This feature is useful to limit the volume level to prevent excessive noise levels in specific Zones.

To specify the volume limit for the selected Zone:

- a. Select the **Volume Limit** menu item.
- b. Turn the Encoder to adjust the volume limit for the selected Zone.
- c. Press any key to exit

Sub-woofer level

External amplifiers are required to add up to 4 subwoofers to the system. A single screen is used to set the sub-woofer level for all Zones.

You can access the screen:

- directly from any input source screen by pressing and holding down the Encoder, or
- from a selected Zone's **Sub level** menu item, as described below.

To specify the sub-woofer level for the selected Zone:

- a. Select the **Sub level** menu item. The Sub level screen is displayed with the first Zone highlighted.
- b. Turn the Encoder to adjust the sub level for the highlighted Zone.
- c. If required, press the Encoder to accept the sub level and move automatically to the next Zone.
- d. Press any key to exit

Name

Initially, the Zones are named Zone 1–4, but you can give each zone a name of your choice (up to 10 characters in length). The available characters include all the uppercase letters, all the lowercase letters, space and numbers. While changing the Zone name, you can:

- Exit without saving any changes: press the Menu key.
- Exit and save any changes: press and hold down the Encoder.

Important: If a Zone is disabled, you cannot change any of the following settings for that Zone.

Volume control

Zones 3 and 4 can have volume control disabled. You should disable volume control for a Zone that has its volume controlled from another amplifier or Head unit. If volume control is:

- **Enabled:** turning the Encoder will change line level output for the selected Zone only.
- **Disabled:** turning the Encoder will not change line level output for the selected Zone.

To enable or disable volume control:

- a. Select the Volume Control menu item.
- b. Press the Encoder to enable () or disable () volume control.
- c. Press any key to exit

Link to zone 1

Zones 1 and 2 can be linked so that any volume or sub-woofer level changes are applied to both Zones. A small “+” sign is displayed on screen between Zones 1 and 2 when this feature is enabled.

To link Zone 2 level to Zone 1 level:

- a. Select the **Link to zone 1** menu item.
- b. Press the Encoder to link the two Zones () or unlink () the Zones.
- c. Press any key to exit

Balance

To specify the balance for the selected Zone:

- a. Select the **Balance** menu item.
- b. Turn the Encoder to the left or right to adjust the Balance for the selected Zone.
- c. Press any key to exit

ETHERNET SUPPORT

Add a Wi-Fi wireless router to the 700 Series entertainment system and Apple® devices like the iPad, iPhone and iPod touch® can wirelessly control the audio around the boat. Apps are available for download to enable iPad, iPhone or iPod touch wireless control.

For further connection details, see www.fusionelectronics.com

WIRED REMOTE

The 700 Series Marine Stereo can be controlled by MS-NRX200 wired remote controls installed in the various audio Zones throughout the vessel. There are different cable requirements depending on whether the 700 Series and remote controls are connected to an existing NMEA2000 bus or in a FUSION-only installation.

NMEA-2000 bus installation

FUSION's MS-NRX200 wired remote controls can connect to the NMEA 2000 bus, removing the need to wire back to the stereo unit. The communication is both ways, as FUSION's MS-NRX200 remote can repeat NMEA data like depth, speed and wind direction on the remote's screen. You will require a FUSION NMEA 2000 starter kit (MS-N2KSTART – to create a NMEA Bus) if you wish to connect the remote to the existing NMEA 2000 Bus, you will require a MS-N2KCONN.

FUSION-only installation

Smaller or older vessels without NMEA 2000 can still have FUSION MS-NRX200 wired remotes in almost any location.

No starter kit is required as the MS-NRX200 wired remote package includes everything necessary to connect it directly to the 700 Series unit.







INFRARED (IR) REMOTE

MS-AV700 model only



You can use the IR remote to navigate through most functions in all sources



The following keys work the same way as the matching Head unit keys in all sources.

	Power On / Off		Mute all sound
	Play / Pause		Display clock
	Skip back		Skip forward

The following keys work the same way in all sources.

	Change source
	Volume Up / Down

SETTING UP THE 700 SERIES

ZONES

Zone 1 and 2 are powered by the on board Class-D amplifier. External amplifiers are required to utilize the 4 line outputs and 4 subwoofer outputs. You can pre-set the balance, volume limit, sub-woofer level and name for each of the four Zones available on the 700 Series. If required, you can also:

- Enable or disable Zones 2, 3 and 4 (Zone 1 is always enabled).
- Enable or disable volume control (Zones 3 and 4 only).
- Link Zones 1 and 2.

For further details, see instructions below.

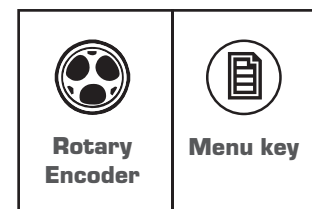

Selecting and setting up a zone

To select a Zone and modify its settings:

1. Press the Menu key.
2. Turn and then press the Encoder to select **Settings > Zone**.
3. Turn and then press the Encoder to select the Zone you wish to work with.
4. Use any of the following instructions to update settings for the selected Zone.

Enabled

Zones 2–4 can be disabled if required. This is useful, for example, if only two Zones have been set up, as disabled Zones are not displayed in any screens when setting levels.

To enable or disable the selected Zone:

- a. Select the **Enabled** menu item.
- b. Press the Encoder to enable () or disable () the selected Zone.
- c. Press any key to exit

700 SERIES CONNECTION EXAMPLE

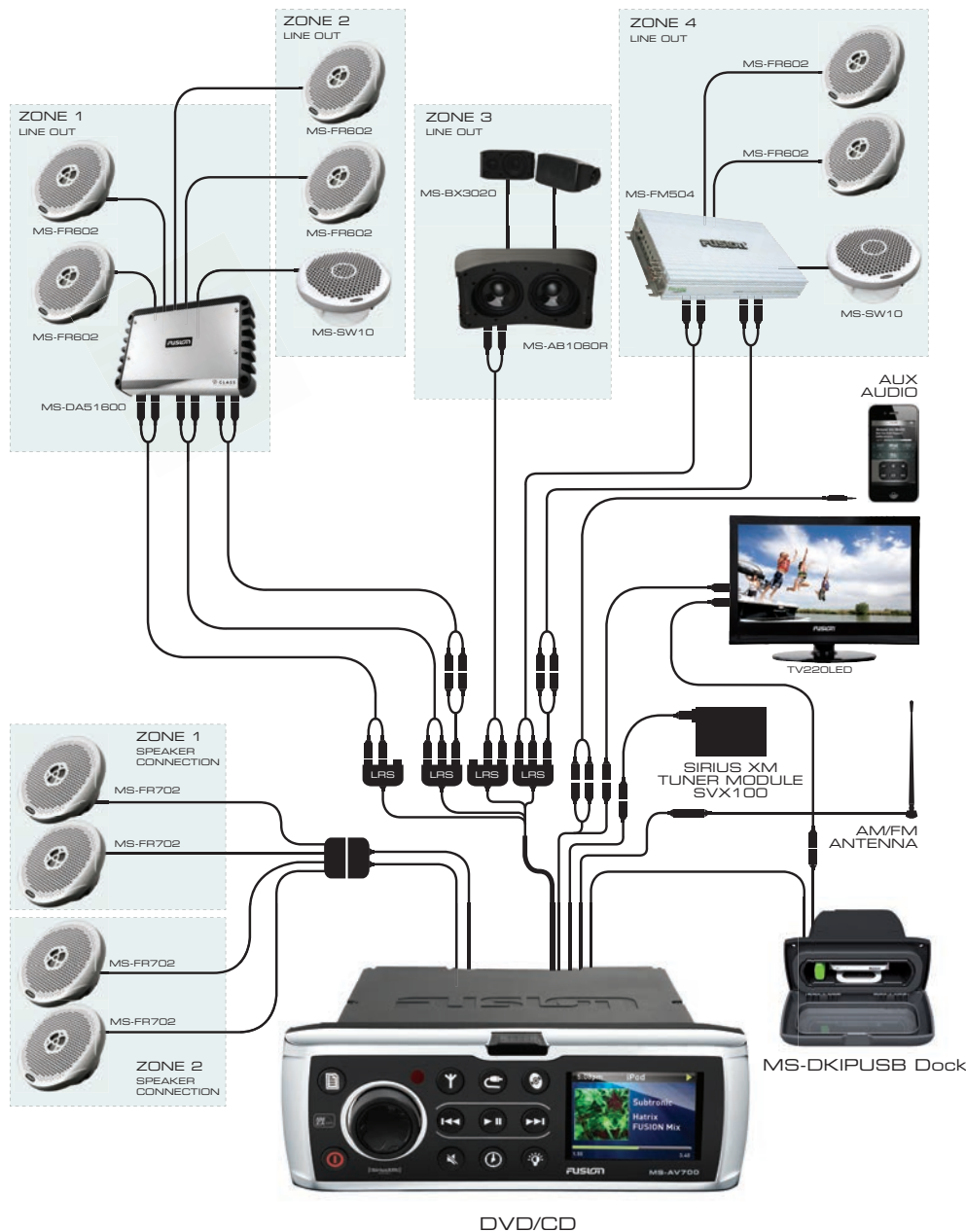

The following keys work for DVD / iPod / USB sources only.

	Random / Shuffle
	Cycle through repeat options

DVD source selected.

When the DVD source is selected, use the following keys to control specific features.

	Open a menu in the TV display.
	Display on the TV display which CD track, DVD chapter and title you are currently watching or listening to.
	Zoom in on the picture for the currently playing DVD.
	Cycle through the available subtitle languages found in the playing DVD.
	Open the DVD setup menu on the TV display.

DVD source not selected

When the DVD source is not selected, use the following keys for navigating the 700 Series menu.

	Open the menu for navigation.
	Use the arrow keys to navigate through menu, and press select (SEL) to choose the highlighted menu item.

INSTALLING THE 700 SERIES

Dimensions are in millimeters (mm) and inches ("). Not to scale.

Figure 7 – Dimensions - top view

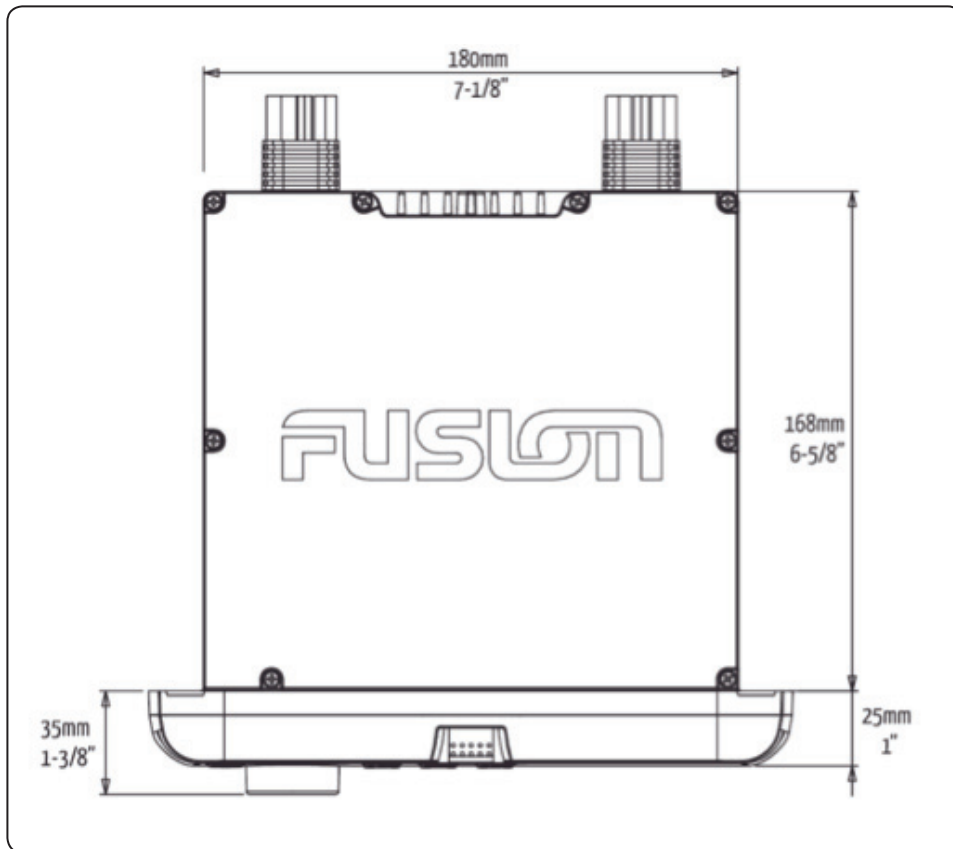

INSTALLATION

IF ANY MODIFICATION TO THE VESSEL IS REQUIRED, SUCH AS DRILLING HOLES ETC, FUSION RECOMMENDS CONSULTATION WITH YOUR BOAT DEALER OR MANUFACTURER BEFOREHAND.

- >> Fit mounting gasket
- >> Insert the unit into the mounting hole
- >> Pull down the front face to expose the mounting screw locations
- >> Use either the supplied 4 x wood screws, or 4 x machined screws and metal clamps to affix the unit into position.
- >> The unit must be mounted within 30 degrees of the horizontal plane.

Note: In some circumstances a back strap or brace may be required at the rear of the unit (Back Strap / Brace is not included).

Appropriate mounting is very important to ensure correct operation. Select a location that allows both free/open airflow around the rear of the chassis, whilst minimizing exposure to moisture. Allow adequate room at the rear of the unit for the cable looms (approx 2 - 3").

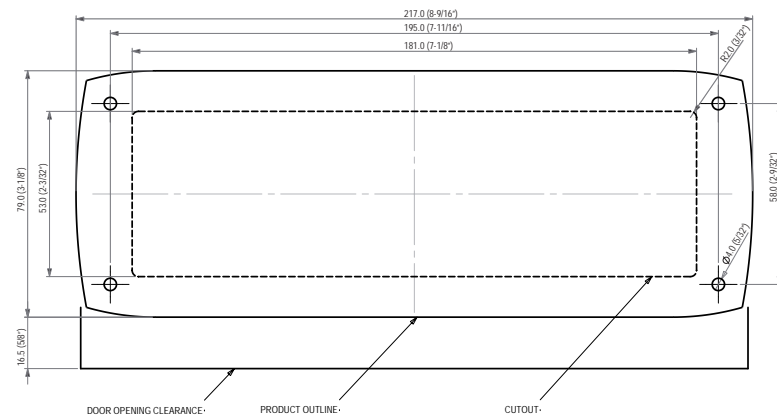
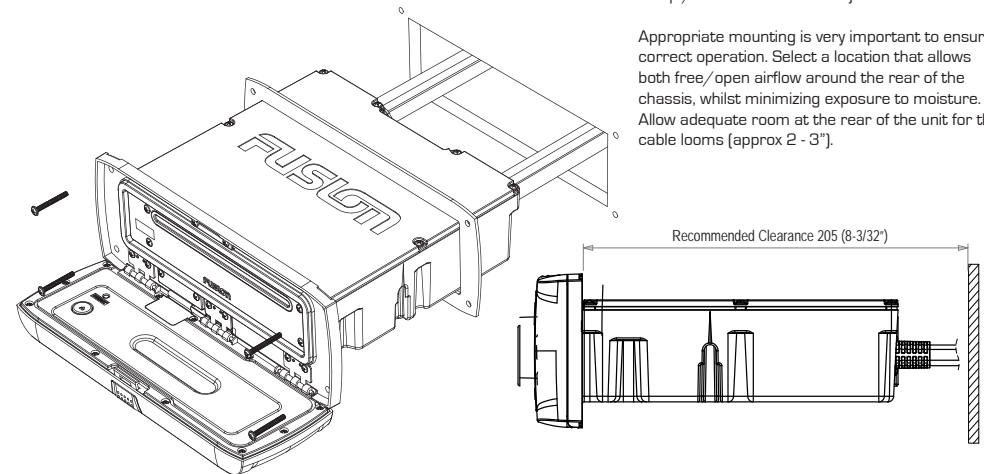

ELECTRICAL WIRING

Caution: The MS-IP700 and MS-AV700 are designed for vessels with a 12V DC Negative ground electrical system.

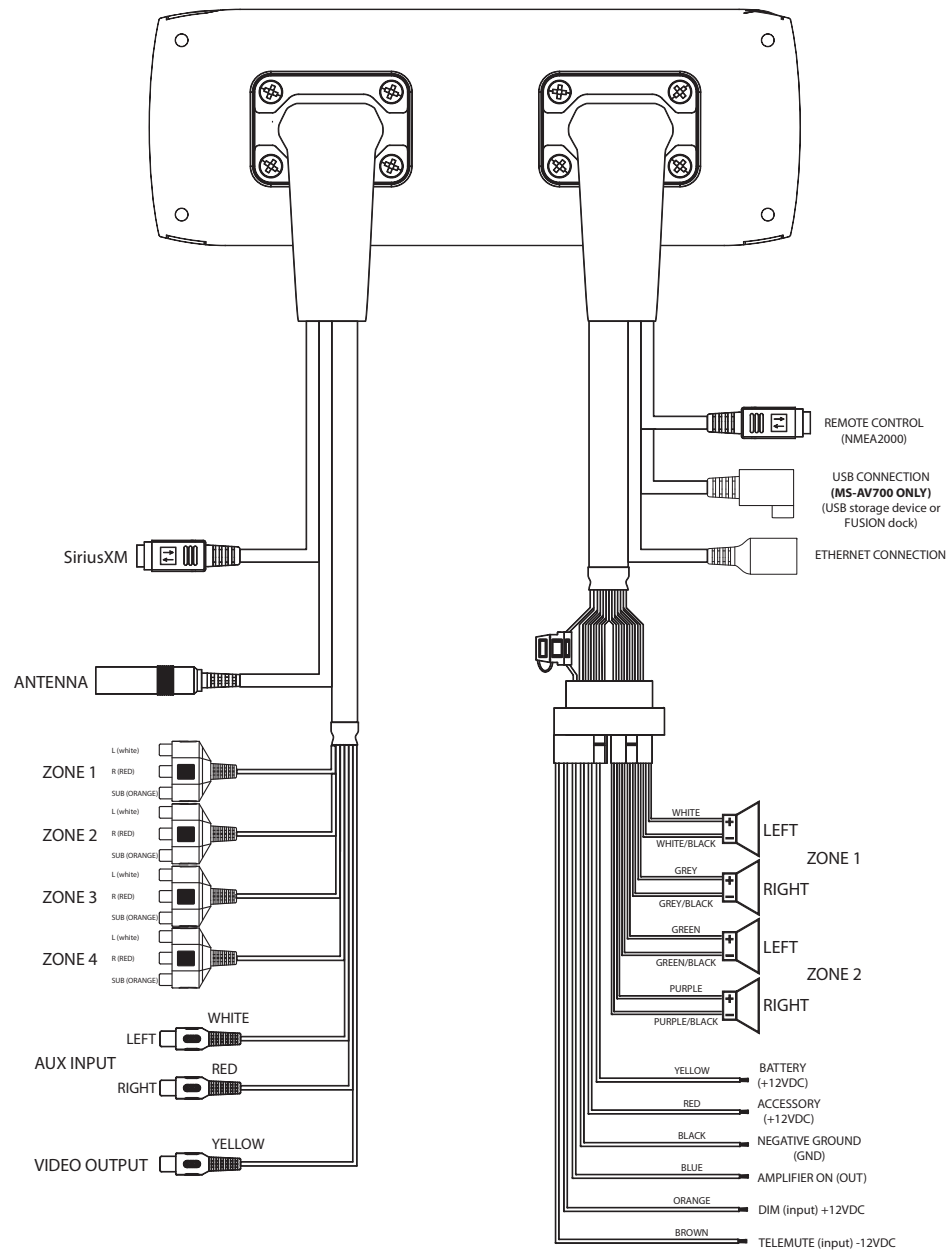

Figure 8 – Dimensions - side view

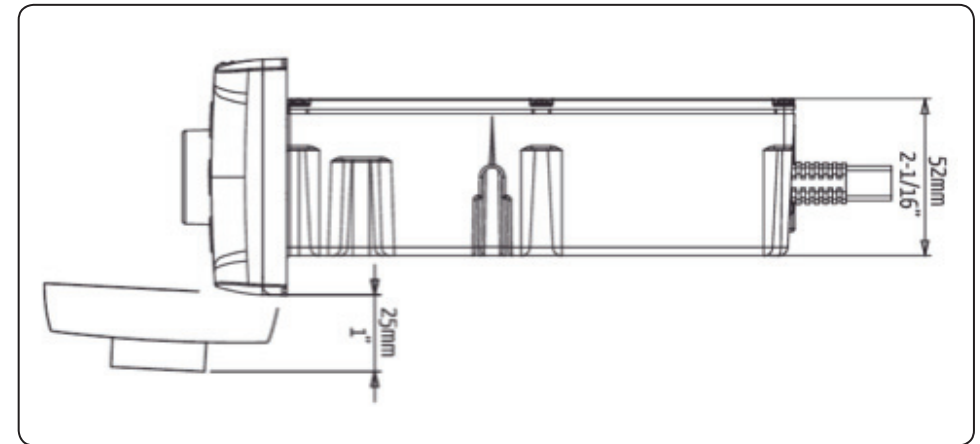
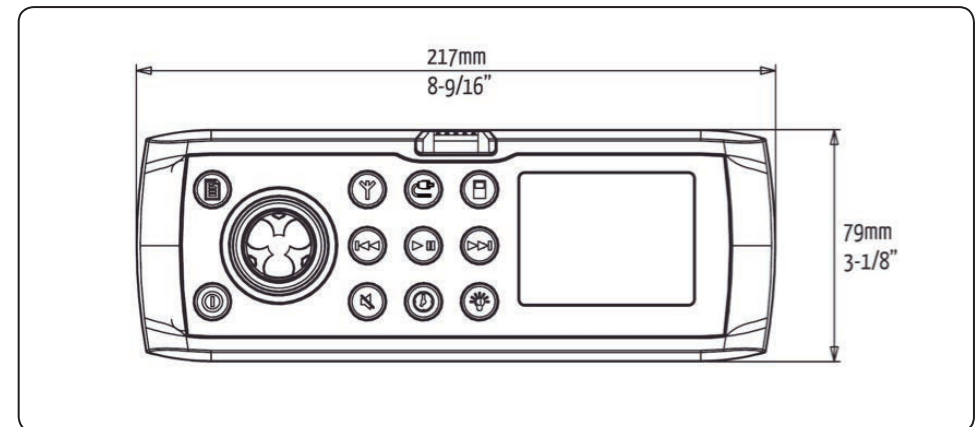

Figure 9 – Dimensions - front view



CONNECTIONS

DESCRIPTION	COLOUR
-------------	--------

Battery +12VDC	Yellow
Accessory +12V switched	Red
Negative Ground	Black
Remote Amplifier Enable output	Blue/White
Dim input [12VDC active]	Orange
Telemute input [GND active]	Brown

Note: All +12V wiring MUST be fused at the power source end of your cable, with a 15 A fuse. When the red "Accessory +12V switched" wire is not required in your installation, it MUST be connected together with the Yellow "Battery +12V" wire at the MS-700 head unit wiring loom.

When connecting the Dim input ensure the wire gauge used is suitable for the fuse supplying the circuit being connected to.

ANTENNA CONNECTION

Connect an AM/FM marine antenna.
Note: Do Not Connect to a VHF splitter

AUX INPUT

Connect an Auxiliary source to the left and right RCA (White = L, Red = R).

VIDEO CONNECTION

(MS-IP700 iPod/iPhone video only, MS-AV700 DVD video only)
 Connect the composite video output (Yellow = Video) to a TV / LCD monitor

USB CONNECTION (MS-AV700 only)

Connect an Apple sync cable (not included), or USB Flash Drive (not included) or connect the MS-DKIPUSB Portable Media Device Dock (not included)
Note: MS-IP700 has internal USB socket

NMEA2000 / WIRED REMOTE

For connection to a MS-NRX200 Remote (not included).
 For connection to an existing NMEA2000 Bus a MS-N2KCONN is required (not included)
 To install a new NMEA2000 Bus a MS-N2KSTART is required (not included)

ETHERNET CONNECTION

For connection to a DHCP Ethernet Router for communication with FUSION-Link capable devices.

SIRIUS XM SATELLITE RADIO (For use in USA only)

Connect to Sirius XM tuner module SVX100 (not included)

ZONE	CONNECTIONS
Zone 1	White = Speaker Left Positive White / Black = Speaker Left Negative Grey = Speaker Right Positive Grey / Black = Speaker Right Negative
Zone 2	Green = Speaker Left Positive Green / Black = Speaker Left Negative Purple = Speaker Right Positive Purple / Black = Speaker Right Negative

Note: Speaker connection (2 Ohm Stereo minimum). 2 pairs of 4 Ohm speakers per channel can be connected in parallel to achieve 2 Ohm configuration

Zone 1 Line Out (Red wire)	Low level output (For connection to external amplifier) White RCA = Left Output Red RCA = Right Output Brown RCA = Subwoofer Output
Zone 2 Line Out (White wire)	Low level output (For connection to external amplifier) White RCA = Left Output Red RCA = Right Output Brown RCA = Subwoofer Output
Zone 3 Line Out (Grey wire)	Low level output (For connection to external amplifier) White RCA = Left Output Red RCA = Right Output Brown RCA = Subwoofer Output
Zone 4 Line Out (Black wire)	Low level output (For connection to external amplifier) White RCA = Left Output Red RCA = Right Output Brown RCA = Subwoofer Output

Free Manuals Download Website

<http://myh66.com>

<http://usermanuals.us>

<http://www.somanuals.com>

<http://www.4manuals.cc>

<http://www.manual-lib.com>

<http://www.404manual.com>

<http://www.luxmanual.com>

<http://aubethermostatmanual.com>

Golf course search by state

<http://golfingnear.com>

Email search by domain

<http://emailbydomain.com>

Auto manuals search

<http://auto.somanuals.com>

TV manuals search

<http://tv.somanuals.com>