

OM-E4363-1A

FURUNO

OPERATOR'S MANUAL

*GPS/PLOTTER/
SOUNDER*

Model **GP-1800F**

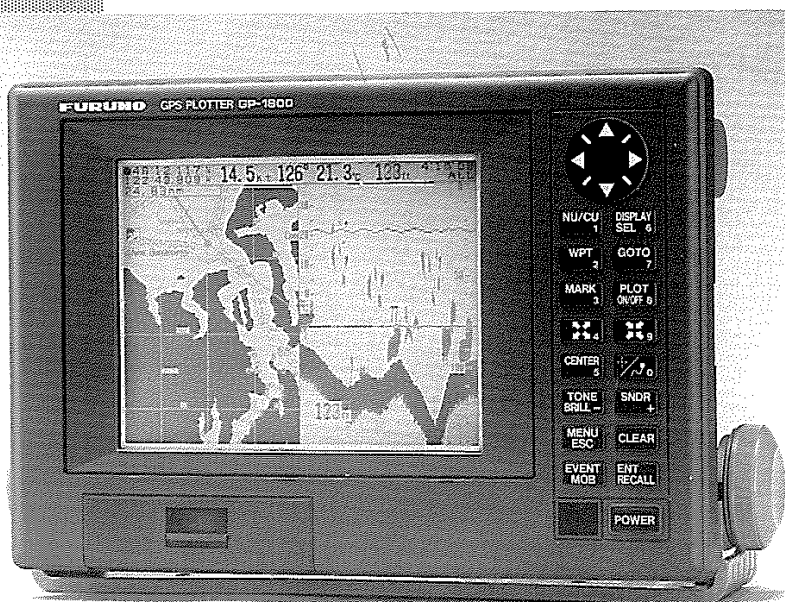

940950KY
(9409,teko)

IMPORTANT—Read This First

- No single navigation aid (including this unit) should ever be relied upon as the exclusive method for navigating your vessel. The navigator is responsible for checking all aids available to confirm his position. Electronic aids are intended to assist, not replace, the navigator.
- The [EVENT/MOB] key can function to mark man overboard position, when “MOB Data” is turned on in the DISPLAY SETUP menu. When the key is pressed, the position at that exact moment is stored in the unit and the event mark appears at that position. The display continuously shows the range and bearing from present position to the man overboard position.
- This unit is not a fail-safe record-keeping device. Important data should be recorded in a log or saved to a memory card.
- The GPS satellites are under control of the US Department of Defense. Thus their position-fixing accuracy is subject to change.
- If an autopilot is connected with this device, the ship can be automatically steered to a destination. However, always maintain a vigilant watch to prevent collision or grounding.
- If nothing appears on the display when the power is turned on, operate the [TONE BRILL] key and the [Arrow] keys to adjust display tone and brilliance.
- Keep the display unit out of direct sunlight or at least shaded to maintain display tone control by avoiding an excess heat that can build up inside the cabinet.

Table of Contents

Foreword 1

A Word to GP-1800F Owners	1
Features	1
About This Manual	2

PART 1: System Introduction

1.1 System Configuration	1-2
1.2 Controls	1-3
1.3 What Appears on the Displays	1-4
Plotter Displays	1-4
Video Sounder Displays	1-5
Plotter and Video Sounder Combination Display	1-7
Navigation Data Display	1-8
1.4 Getting Acquainted With the GP-1800F—A Tutorial	1-10
Step 1: Preparation in port	1-10
Step 2: Sailing to destination	1-12
Step 3: Return to port	1-13
Step 4: Quitting operation	1-14

PART 2: GPS Plotter Operation

2.1 Selecting Plotter Displays	2-2
Types of Plotter Displays	2-2
Display Orientation	2-3
2.2 The Cursor	2-4
2.3 Coastline Data Cards	2-5
Displaying Charts	2-5
Display Range	2-6
2.4 Shifting the Plotter Display	2-7
Centering Ship's Position	2-7
Centering a Location	2-7
Scrolling the Display	2-7
2.5 Waypoint Navigation	2-8
Registering Waypoints	2-8
Changing Waypoint Data	2-11
Deleting Waypoints	2-11
Hiding/Showing Waypoints	2-12

Setting Destination Waypoint	2-12
Cancelling Destination Waypoint	2-15
2.6 Route Navigation.....	2-16
Registering Routes	2-16
Changing Route Contents	2-19
Deleting Route Waypoints	2-19
Following a Route	2-20
Cancelling Route Navigation.....	2-21
2.7 Mark Operations.....	2-22
Entering Marks	2-22
Changing Mark Size	2-22
Changing Mark Shape and Tone.....	2-23
Erasing Marks	2-23
Connecting Marks.....	2-24
2.8 The Event Mark.....	2-25
Entering an Event Mark	2-25
Viewing Past Event Positions	2-25
Erasing Event Marks	2-25
Setting Past Event Position as Destination	2-26
Changing Event Mark Shape	2-26
2.9 The MOB Function	2-27
2.10 Stopping, Resuming Plotting of Track.....	2-28
2.11 Changing Track Plotting Interval	2-29
2.12 Erasing Tracks, Marks	2-31

PART 3: Video Sounder Operation

3.1 Principle of Operation	3-2
3.2 Selecting Video Sounder Displays	3-3
3.3 Basic Operation of the Video Sounder	3-6
Automatic Operation	3-6
Manual Operation	3-7
3.4 Adjusting the Video Sounder Picture.....	3-9
Eliminating Low Level Noise.....	3-9
Brightening Fish Echoes.....	3-10
Eliminating Interference	3-10
Displaying Strong Echoes Only	3-10
Selecting Picture Advance Speed	3-10
3.5 Measuring Depth	3-12
3.6 Fish and Bottom Alarms.....	3-13
Setting the Alarms	3-13
Silencing the Aural Alarm and Closing Alarm Message Window.....	3-14
3.7 Displaying the Water Temperature Graph	3-15
Procedure	3-15
Correcting Water Temperature Readout	3-15

3.8 Changing Video Sounder Settings on the SYSTEM SETUP Menu 3-16

PART 4: Application

4.1 Alarms 4-2
Arrival Alarm, Anchor Watch Alarm 4-2
Cross Track Error (XTE) Alarm, Border Alarm 4-2
Ship's Speed Alarm 4-3
Water Temperature Alarm 4-3
Enabling the Alarms 4-3
Deleting Aural and Visual Alarms 4-4
Disabling Alarms 4-4

4.2 Chart, GPS Position Correction 4-5
Chart Position Correction 4-5
GPS Position Correction 4-5

4.3 Displaying Loran LOPs 4-7

4.4 Memory Card Operations 4-9
Formatting Memory Cards 4-9
Recording Data 4-10
Write Protecting Data 4-10
Replaying Data 4-11
Deleting Data 4-11

4.5 Customizing the Display on the DISPLAY SETUP Menu 4-12

4.6 Changing Plotter-related Settings on the SYSTEM SETUP Menu 4-15

PART 5: Maintenance & Troubleshooting

5.1 Maintenance 5-2
Maintenance Program 5-2
Replacement of Fuse 5-3
Replacement of Memory Card Battery 5-3

5.2 Self-Tests 5-4

5.3 GPS Monitor Display 5-6

5.4 GPS Receiver Status Indicator 5-7

5.5 Troubleshooting Table 5-8

Appendix

Specifications A-2
Geodetic Chart List A-3

***Index* INDEX-1**

A Word to GP-1800F Owners

Congratulations on your choice of the FURUNO GP-1800F GPS Plotter and Video Sounder. We are confident you will see why the FURUNO name has become synonymous with quality and reliability.

For over 40 years FURUNO Electric Company has enjoyed an enviable reputation for innovative and dependable marine electronics equipment. This dedication to excellence is furthered by our extensive global network of agents and dealers.

Your unit is designed and constructed to meet the rigorous demands of the marine environment. However, no machine can perform its intended function unless properly installed and maintained. Please carefully read and follow the operation and maintenance procedures set forth in this manual and the installation instructions contained in the installation manual.

We would appreciate hearing from you, the end-user, about whether we are achieving our purposes.

Thank you for considering and purchasing FURUNO equipment.

Features

- Receives and tracks eight GPS channels simultaneously to ensure accurate position fixing.
- Numerical and graphical displays of navigational data.
- Menu-driven operation.
- Position display in latitude and longitude or Loran LOPs.
- Outputs steering information to FURUNO Autopilots FAP-50/55/300/330.
- Sensor inputs: water temperature, ship's speed.
- Three tone monochrome echo presentation.
- Wide variety of alarms: arrival, anchor watch, border, XTE, water temperature, speed, fish, bottom.
- Automatic video sounder operation—range and gain automatically adjusted according to depth.
- Universal 10.2 to 30 VDC power supply drawing 20 W of power maximum.

About This Manual

This manual is laid out in as “user-friendly” a manner as possible. It is our intention to guide the user along in the use of the gear as gently and as comfortably as possible in a series of short, easy-to-digest sections that start at a very basic level and proceed forward in complexity. This manual consists of the following parts.

PART 1: System Introduction. This chapter introduces the GP-1800F system, and includes a tutorial which presents the basic functions of your unit.

PART 2: Plotter Operation. This chapter tells you how to operate the GPS plotter.

PART 3: Video Sounder Operation. This chapter provides the information necessary for operating the video sounder.

PART 4: Application. This chapter describes how to use your unit effectively.

PART 5: Maintenance and Troubleshooting. This chapter provides maintenance and troubleshooting procedures.

PART 1

System Introduction

1.1 System Configuration

Overview

The GP-1800F mainly consists of a display unit, a GPS antenna and a video sounder transducer. The memory card drive in the display unit provides for storage and replay of memory cards and replay of electronic charts. An autopilot can be connected to automatically steer vessel to destination. External sensors, such as ship speed and temperature indicators, can also be connected.

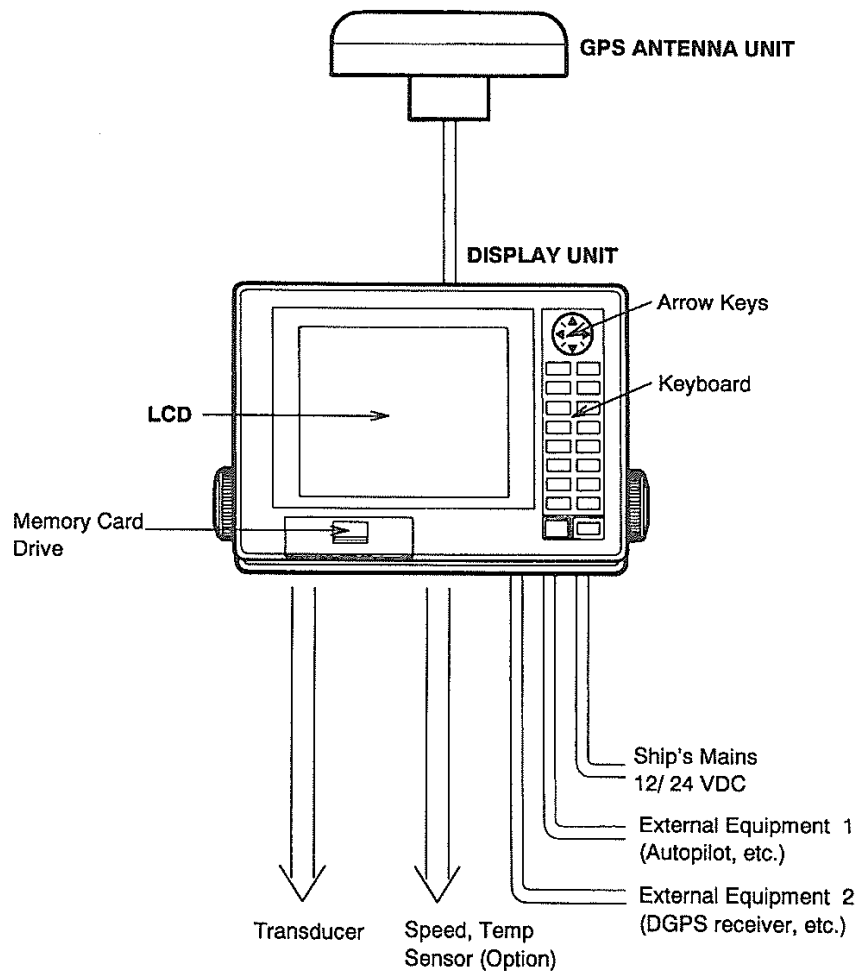

Figure 1-1 System configuration

1.2 Controls

Description of Controls

All operations of the GP-1800F are carried out with the controls on the front panel of the display unit. All controls respond immediately to your command and the unit emits a beep to signify it has accepted your command. (Invalid key input emits several beeps.)

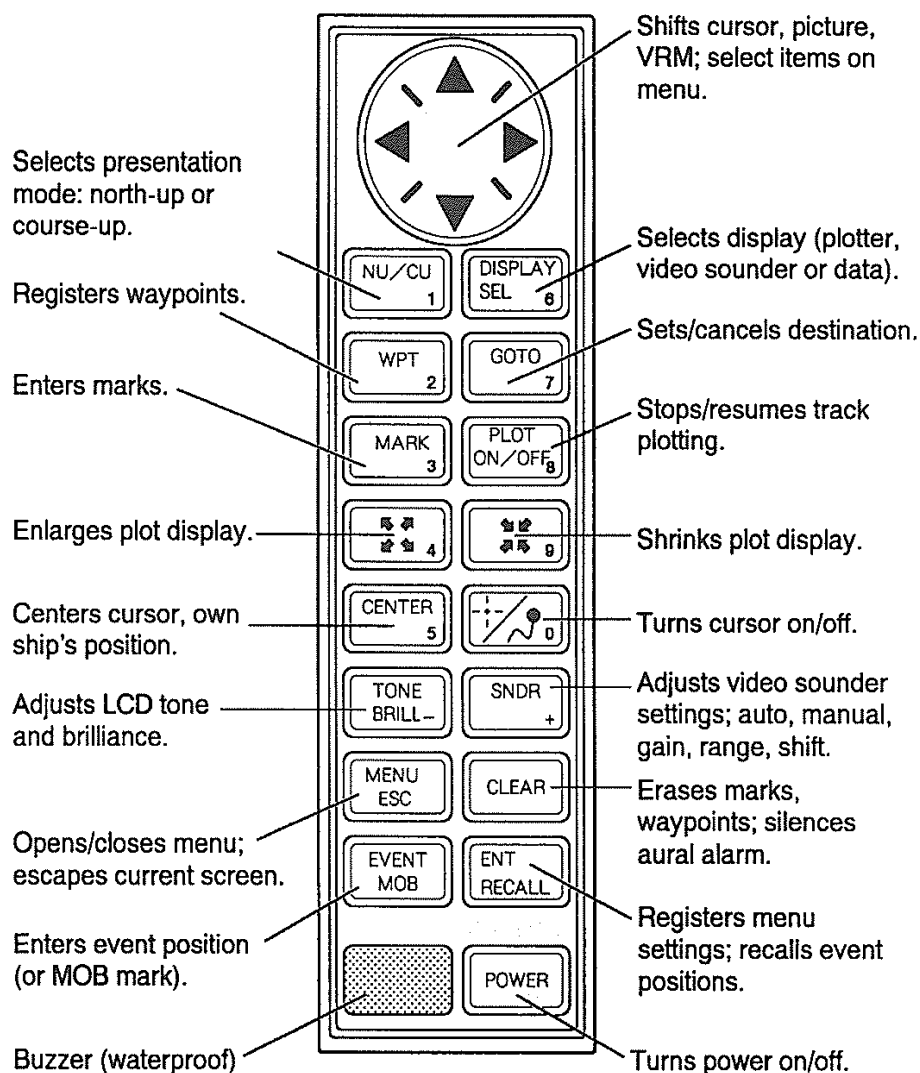

Figure 1-2 Front panel controls

1.3 What Appears on the Displays

Overview

The [DISPLAY SEL] key selects plotter, video sounder, plotter/video sounder, and data displays. Press it to open the display selection menu.

Plotter Displays

North-up presentation

North is at the top of the display.

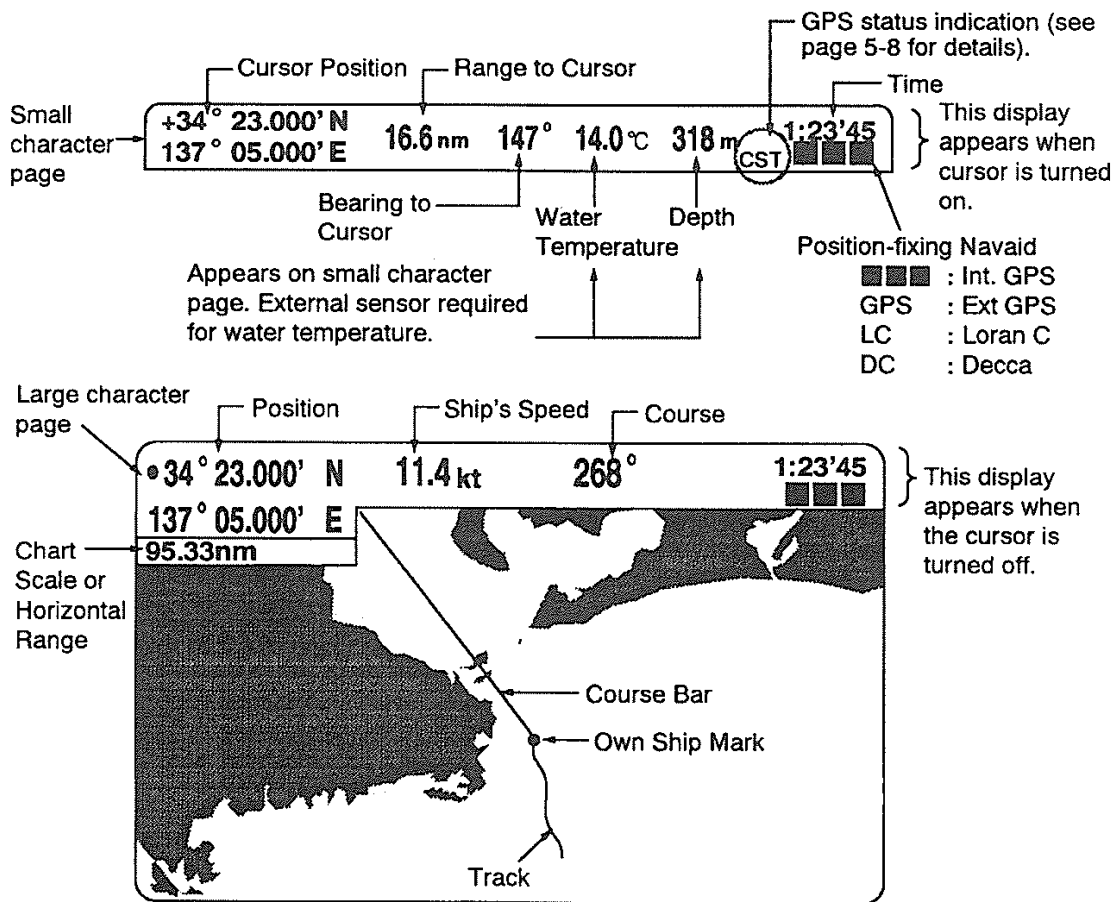

Figure 1-3 Plotter display, north-up presentation

Course-up presentation

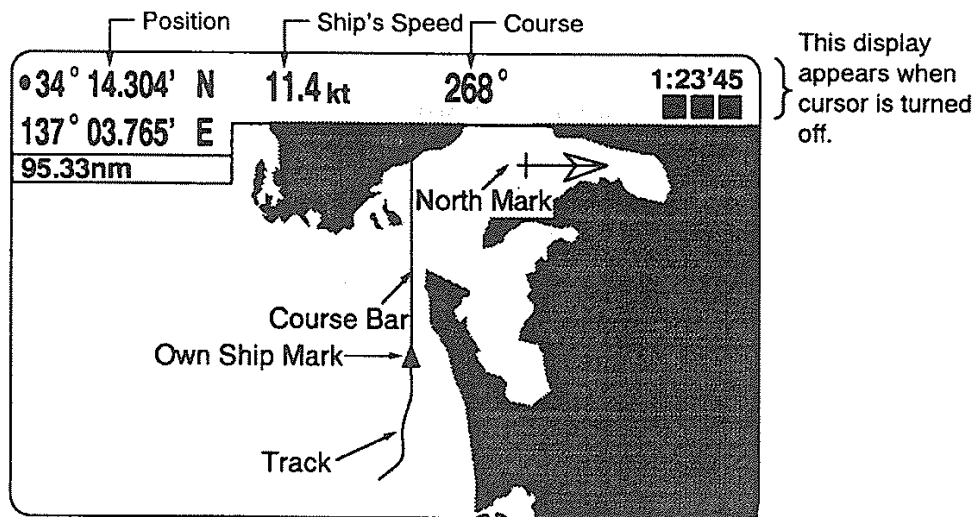

Figure 1-4 Plotter display, course-up presentation

NOTE: The enlarged character display does not show water temperature or depth. It shows range and bearing from own ship to cursor, or ship's speed and course.

Video Sounder Displays

One of the following four display modes is preselected on the VIDEO SOUNDER SETUP menu. Press the [MENU] and [7] keys to open the menu.

Normal display

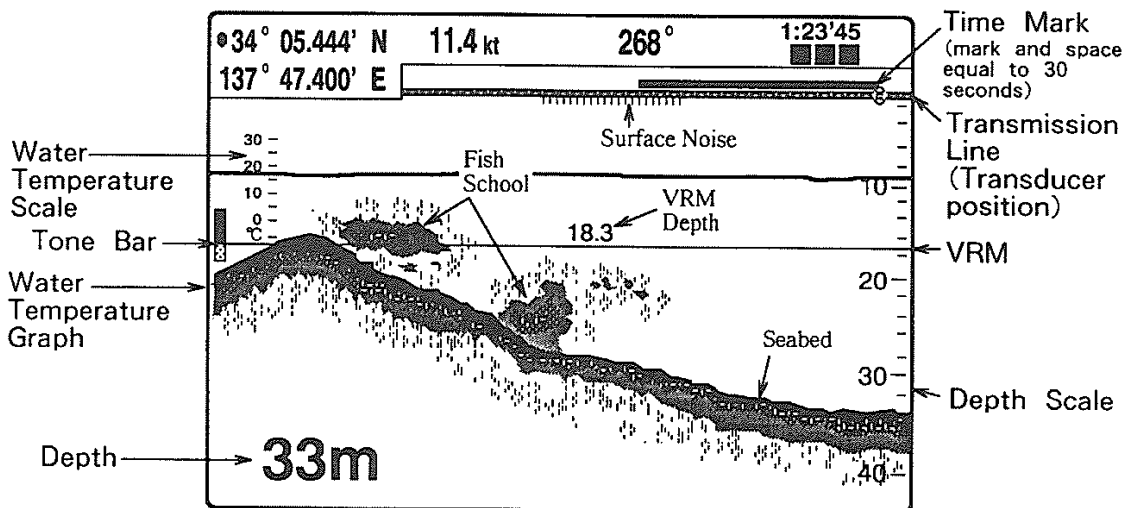

Figure 1-5 Normal video sounder display

NOTE: The water temperature graph and water temperature display require a triducer or water temperature indicator (option).

Marker zoom

This display provides an expanded view of the area within the Variable Range Marker (VRM) and the zoom marker. It is useful for judging the size of midwater fish.

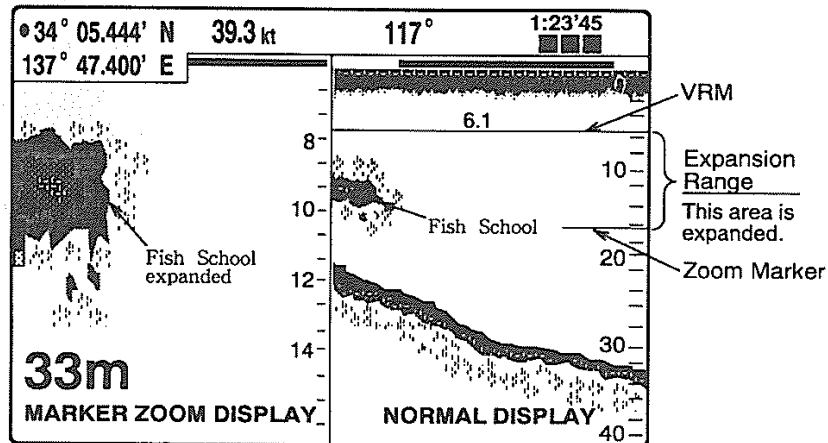

Figure 1-6 Marker zoom display plus normal display

Bottom zoom

This display is useful for discerning the shape and material of the seabed. The seabed is automatically tracked so bottom echoes locate on the lower half of the screen.

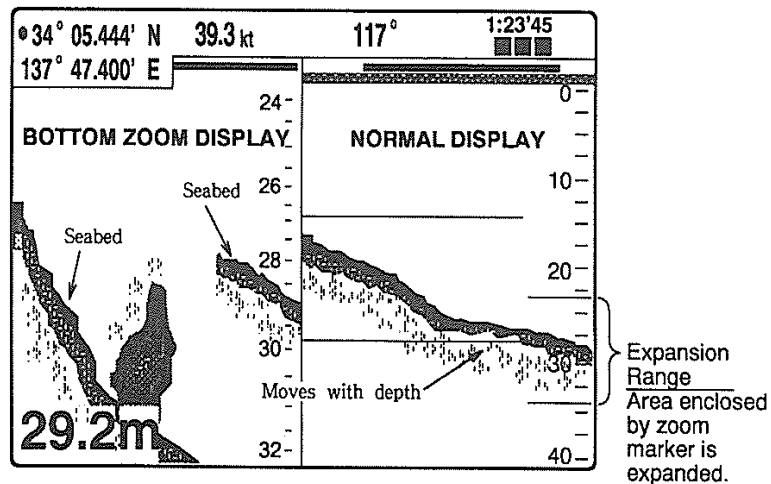

Figure 1-7 Bottom zoom display plus normal display

Bottom-lock

The bottom lock display provides an expanded “wide” or “narrow” view (distance depends on unit of measurement) of the area above the seabed. This display is useful for discriminating fish near the seabed.

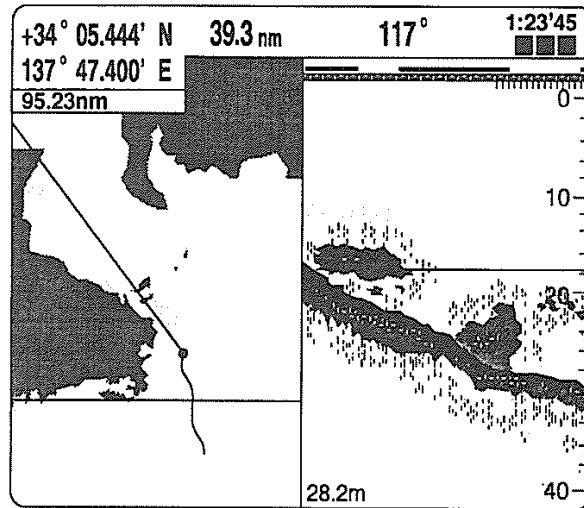

Figure 1-8 Bottom-lock display plus normal display

Plotter and Video Sounder Combination Display

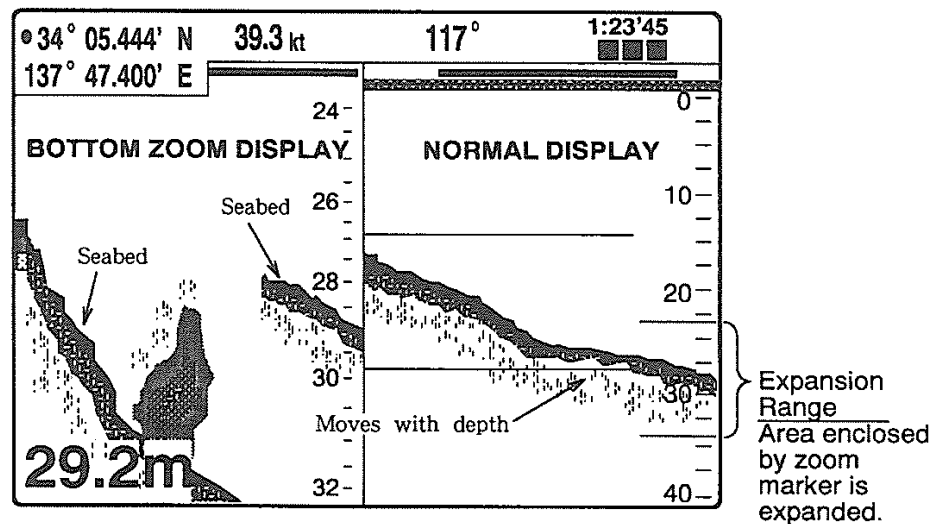

Figure 1-9 Plotter and video sounder combination display

Navigation Data Display

The navigation display consists of two or three displays: the digital or analog course display, and the video sounder display, the plotter display.

Analog data display

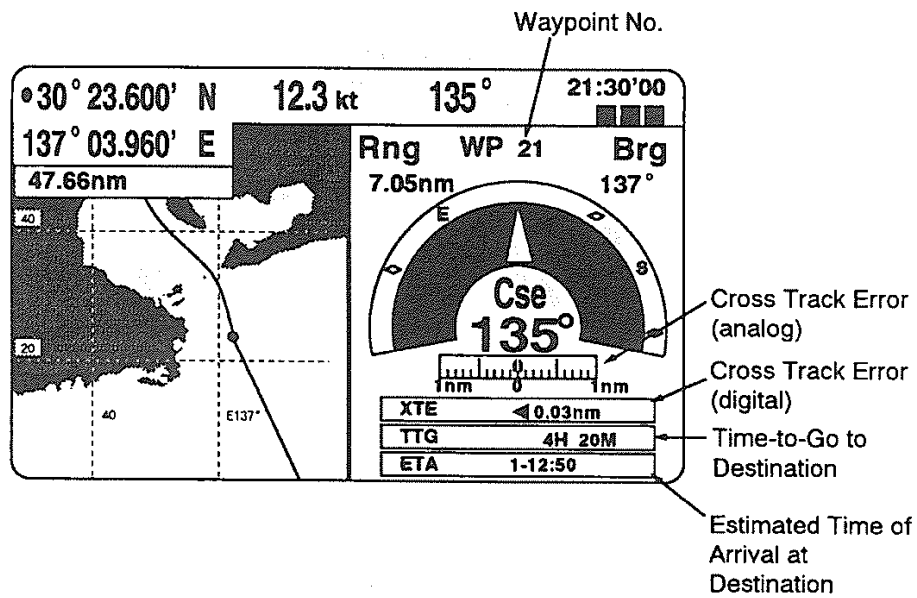

Figure 1-10 Plotter display plus Analog display

Analog data display, autopilot connection

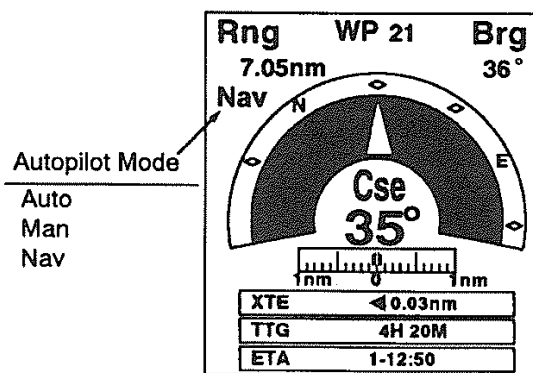
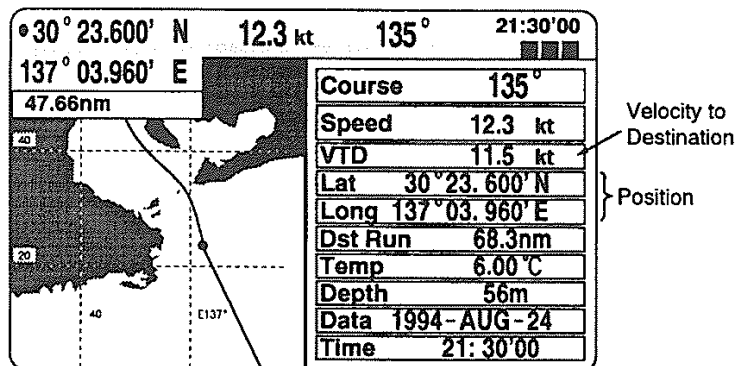

Figure 1-11 Analog display, autopilot FAP-300/330 connection

Digital data display



Dst Run (distance run) is reset to zero by pressing the CLEAR key.

Figure 1-12 Plotter display plus digital data display

1.4 Getting Acquainted With the GP-1800F—A Tutorial

Overview

This section introduces the basic functions of your unit, in tutorial form. You will learn how to sail from your port to a destination and return to port. For sake of illustration, the procedures which follow explain how to sail between points A and B and vice versa in Figure 1-13. If your unit is installed and you have time for a short cruise, try operating the unit as you review this section. Don't worry if you don't understand everything which appears on the display. You will learn more about your unit in later sections.

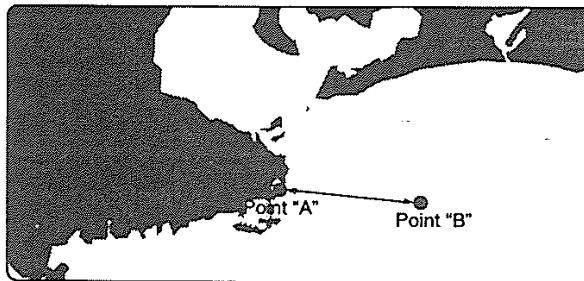

Figure 1-13

Step 1: Preparation in port

Insert coastline data card

- 1) Open the memory card drive lid.
- 2) Insert the coastline data card label side up, arrow forward.
- 3) Close the lid.

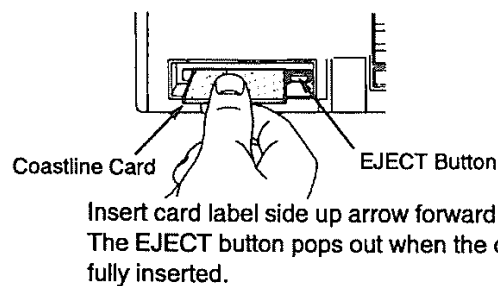

Figure 1-14

Turn on the power, adjust tone and brilliance

- 1) Press the [POWER] key.
- 2) Press the [TONE BRILL] key.

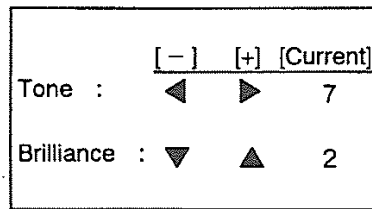

Figure 1-15



- 3) Operate the [◀] or [▶] keys to adjust display tone.
- 4) Press the [▲] or [▼] key to adjust display brilliance.

Select plotter display

- 1) Press the [DISPLAY SEL] key and the [◀] key to select "Plotter."
- 2) Press the [NU/CU] key to select the north-up mode.

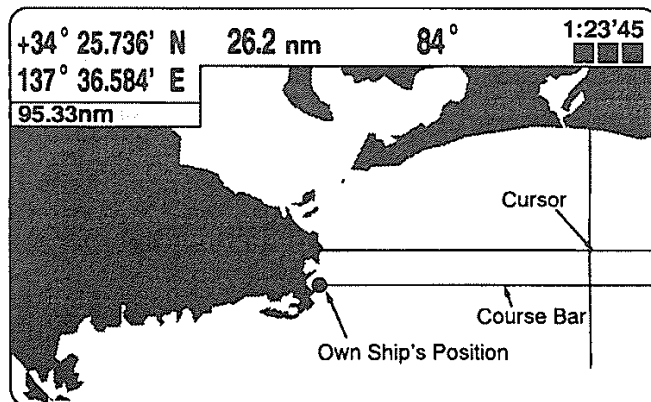
Figure 1-16



- 3) Press the [0] key to turn off the cursor.
- 4) Press the [CENTER] key to center own position.
- 5) Press the [Scale] keys ( , ) so the chart can be easily viewed.

Mark own ship's position

This will enable you to use your current position as destination waypoint, when returning to port.

- 1) Press the [WPT] key. The display shown in Figure 1-17 appears.

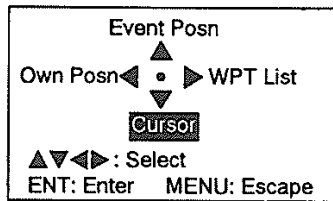

Figure 1-17

- 2) Press the [◀] key to select "Own Posn."
- 3) Press the [ENT] key.
- 4) Enter waypoint number. As an example, enter "01."
- 5) Press the [ENT] key.
- 6) Press the [MENU] key to escape.

Set destination by cursor

There are several ways by which you can set destination. Two are presented in this tutorial: by the cursor and by waypoint number. First, by cursor.

- 1) Press the [GOTO] key. The destination selection display appears.

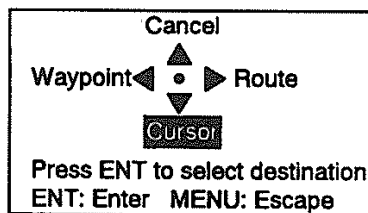

Figure 1-18

- 2) Press the [▼] key to select "Cursor," if it is not already selected.
- 3) Press the [ENT] key.
- 4) Operate the [Arrow] keys to set cursor on destination.
- 5) Press the [ENT] key.

Step 2: Sailing to destination

Navigation information

A flag marks destination and a dashed line runs between it and own ship's position, shown on the display as waypoint "00." The dashed line shows the shortest possible course to destination. Range and bearing to the destination appear at the bottom of the display.

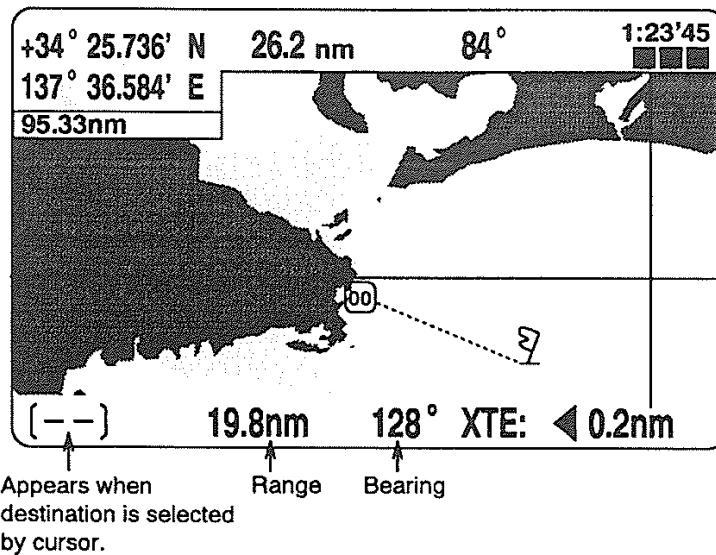

Figure 1-19

Steering to destination

Set ship's course to be the same as the bearing of the destination. While sailing, confirm that ship's track on the display traces the dashed line. Watch the "XTE" (cross-track error) indication at the bottom right-hand corner to help stay on course. It shows the direction (by arrows) and amount (in nautical miles) to steer your boat to return to course set.

Step 3: Return to port

Select your port as destination

Set your port as destination, using waypoint 01, which you entered in step 1.

- 1) Press the [GOTO] key.
- 2) Press the [◀] key to select "Waypoint."
- 3) Enter waypoint "01."
- 4) Press the [ENT] key. The display would now look like Figure 1-20.

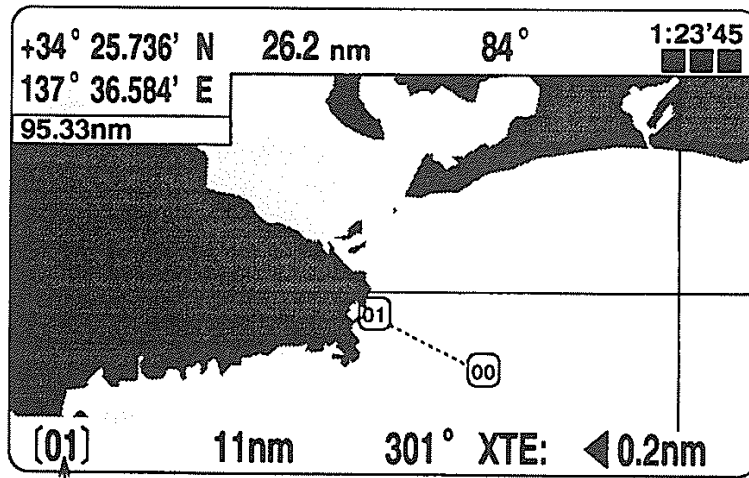

Waypoint No.

Figure 1-20

5) Steer ship's wheel just as in "Step 2: Sailing to destination."

Step 4: Quitting operation

Press the [POWER] key to turn off the unit.

PART 2

GPS Plotter Operation

2.1 Selecting Plotter Displays

Overview

The plotter display traces the ship's track. Ship's track is plotted continuously, even when viewing the video sounder display.

Selecting Plotter Displays

- 1) Press the [DISPLAY SEL] key. The following display appears.

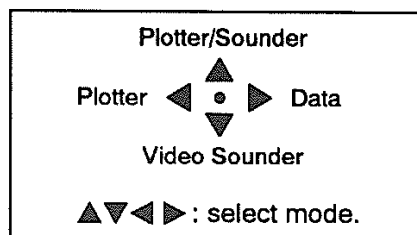

Figure 2-1 Display selection menu

- 2) Press appropriate [Arrow] key to select a Plotter display among Plotter, Plotter/Sounder and Data.
- 3) Press the same [Arrow] key if you want to change a display page.

Types of Plotter Displays

Plotter display

The plotter display traces the ship's track on the entire screen. Coastline charts, provided on coastline data ROM cards (option), display the coastline of your area. Navigation data is digitally displayed.

Plotter/Sounder display

The plotter/sounder display provides the plotter display on the left half and video sounder picture on the right half. They are useful for monitoring the seabed while cruising.

NOTE: *The Plotter and Plotter/Sounder and Video Sounder displays have both normal and enlarged character displays. You can alternately display them by pressing appropriate [Arrow] key, while the display selection menu is displayed.*

Data display

The navigation data display combines the plotter display, the video sounder display, and the analog ship's course display or the digital navigation data display. The analog ship's course display is useful for monitoring your boat's progress during automatic steering by autopilot. The analog and digital displays can be alternately displayed by pressing the [▶] key, while the display selection menu is displayed.

Display Orientation

Two types of display orientations are provided: north-up and course-up.

North-up

North is at the top of the display. This mode is useful for long-range navigation.

Course-up

Ship's course is at the top of the display. This mode is useful for finding course error and the relation between own ship and waypoint.

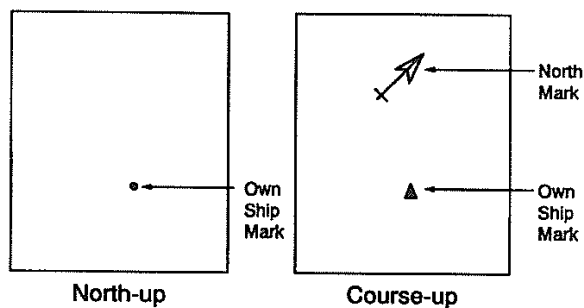

Figure 2-2 North-up and course-up display orientations

Selecting display orientation

Press the [NU/CU] key. Each time the [NU/CU] key is pressed the orientation changes to either course-up or north-up. When course-up is selected, the north-up mark appears on the display and the own ship mark's shape is a triangle.

2.2 The Cursor

Function

The cursor functions to

- find latitude and longitude of a location
- find range and bearing from your ship to cursor position, and
- enter and erase marks and waypoints.

Operation

The [0] key turns the cursor on/off. You can shift the cursor by operating the [Arrow] keys. The cursor moves in the direction of the [Arrow] key pressed.

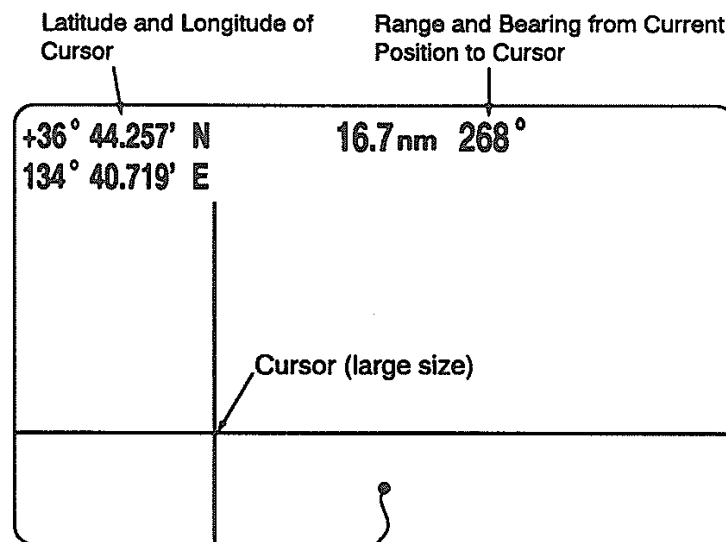

Figure 2-3 Plotter display, showing location of cursor data

NOTE: The size of the cursor can be set for large or small on the DISPLAY SETUP menu. For details, see 4.6 "Customizing the Display on the DISPLAY SETUP Menu."





2.3 Coastline Data Cards

Overview

The coastline data cards display nautical charts. When you insert a suitable card in the drive and your boat is near land, a chart appears with the land portion filled.

When a wrong card is inserted or improper chart scale is selected, the land will be hollow. Chart icons appear to help you select suitable chart scale. Table 2-1 explains chart icons and their meanings.



Table 2-1 Chart icons and their meanings

Icon	Meaning
	Proper card is not inserted or chart scale is too small (chart is overenlarged). Press the  key to adjust chart scale.
	Chart scale is too large. Press the  key to adjust chart scale.
	Suitable chart scale is selected.

Displaying Charts

- 1) Open the memory card drive lid. Insert the card label side up, arrow forward. Close the lid.

NOTE: Always keep the lid completely closed. Foreign material or water may damage the drive and void the warranty.

- 2) Press the [Scale] keys ( , ) to display the chart.
Watch the chart icon to help you find suitable chart scale.

NOTE: When changing cards, press the [Scale] keys to display the chart. It takes several seconds to display the chart.

Display Range

When the [Scale] keys are pressed, you will see several frames. These frames are called indices and they show you what parts of the chart can be enlarged in the current chart scale. The areas circumscribed with smaller frames can be enlarged, but the area enclosed by the largest frame cannot.

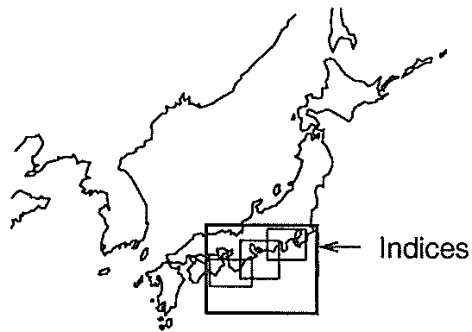

Figure 2-4 Sample chart (Japan and South Korea)

2.4 Shifting the Plotter Display

Centering Ship's Position

- 1) Press the [0] key to turn off the cursor if it is currently displayed.
- 2) Press the [CENTER] key.

Centering a Location

- 1) Press the [0] key to turn on the cursor if it is not currently displayed.
- 2) Operate the [Arrow] keys to set the cursor on the location you want to center.
- 3) Press the [CENTER] key.

Scrolling the Display

- 1) Press the [0] key to turn off the cursor if it is currently displayed.
- 2) Operate the [Arrow] keys to scroll the display.

2.5 Waypoint Navigation

Overview

In navigation terminology, a **waypoint** is a particular location on a voyage whether it be a starting, intermediate or destination point. A waypoint is the simplest piece of information the GP-1800F requires to get you to a destination, in the shortest distance possible.

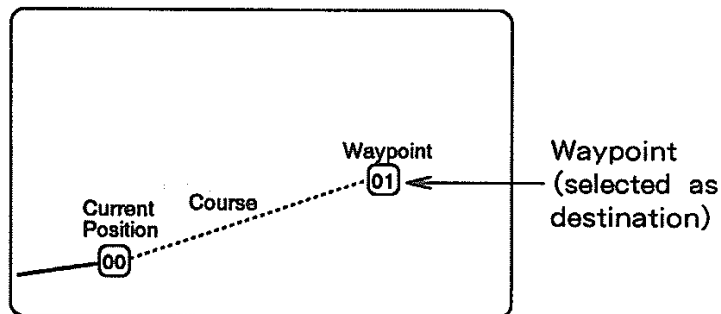

Figure 2-5 Waypoint 01 selected as destination

Registering Waypoints

About entry of waypoints

This unit has 98 waypoints into which you can enter position information. It numbers them 01 to 98. Waypoints “00” and “99” are special waypoints. Waypoint “00” marks own ship’s position when a destination is selected, and waypoint “99” is reserved for event mark position from external navaid.

There are four methods by which you can enter a waypoint:

- by event position
- by the cursor
- through the waypoint list (manual input of latitude and longitude), or
- by own ship’s position.

Entry by event position

- 1) Press the [WPT] key.

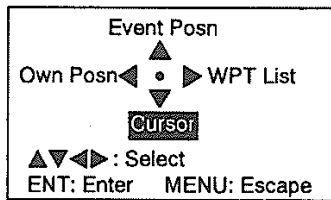

Figure 2-6 Display for selection of waypoint entry method

- 2) Press the [▲] key to select “Event Posn.”
- 3) Press the [ENT] key. The display shows the event data window.

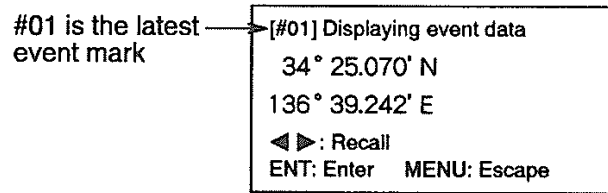

Figure 2-7 Display for selection of event position

- 4) Press the [◀] or [▶] key to recall desired event data.
- 5) Press the [ENT] key. The display shows the event position.

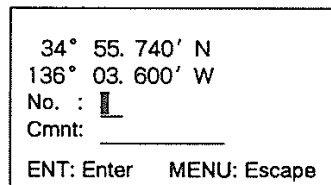

Figure 2-8 Display for entering waypoint number

- 6) Enter waypoint number.

NOTE: You can let your unit automatically assign waypoint number, if desired. Simply press the [ENT] key. The unit saves waypoint position information to the youngest empty waypoint.

- 7) Press the [▼] key to enter comments, if desired. The following display appears. (If you don't want to enter a comment, press the [ENT] key after entering waypoint number.)

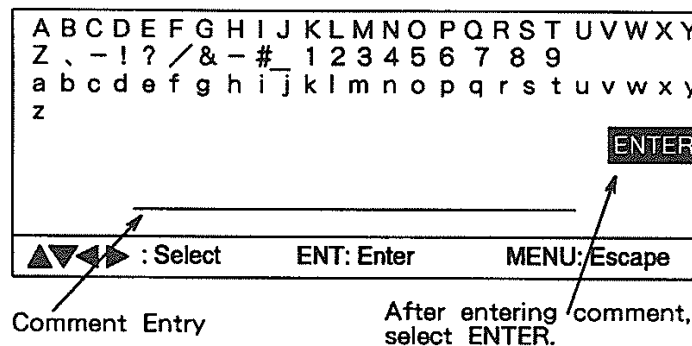

Figure 2-9 Characters available for waypoint comment

About comments: *You may attach a comment to waypoints during or after entry. A comment may contain up to ten characters. All comments are stored in the waypoint list. See "Changing Waypoint Data," page 2-11.*

- 8) Operate the [Arrow] keys to select character. You can enter figures, + and - by direct keyboard input.
- 9) Press the [ENT] key.
- 10) Repeat steps 8 and 9 to complete comment.
- 11) Operate the [Arrow] keys to select "ENTER."
- 12) Press the [ENT] key twice.

Entry by the cursor

- 1) Press the [WPT] key.
- 2) Press the [▼] key to select "Cursor."
- 3) Press the [ENT] key.
- 4) Operate the [Arrow] keys to place the cursor on the position desired. Cursor latitude and longitude appear at the top of the display.
- 5) Press the [ENT] key.
- 6) Enter waypoint number and comments as explained above, or enter waypoint number and press the [ENT] key to register waypoint and escape.
- 7) Press the [MENU] key to escape.

Entry by own ship's position

- 1) Press the [WPT] key.
- 2) Press the [◀] key to select "Own Posn."
- 3) Press the [ENT] key.
- 4) Enter waypoint number.
- 5) Press the [▼] key to enter comments as explained above, or press the [ENT] key to register waypoint and escape.

Entry through the waypoint list

- 1) Press the [WPT] key.
- 2) Press the [▶] key to select "WPT List."
- 3) Press the [ENT] key. The waypoint list appears.

WAYPOINT LIST					
No.	Lat	Long	Display	Comment	
01	34° 44. 567' N	135° 22. 321' W	Yes	CRAB	
02	34° 45. 567' N	135° 23. 321' W	Yes	LOBSTER	Route
03	-34° 46. 567' N	135° 24. 321' W	No	BUOY	
04	34° 47. 567' N	135° 25. 321' W	Yes	_____	In Use
05	° . . . ' N	° . . . ' W	Yes	_____	
06	° . . . ' N	° . . . ' W	Yes	_____	
07	° . . . ' N	° . . . ' W	Yes	_____	
08	° . . . ' N	° . . . ' W	Yes	_____	
09	° . . . ' N	° . . . ' W	Yes	_____	
10	° . . . ' N	° . . . ' W	Yes	_____	

▲▼◀▶ : Cursor ENT: Enter MENU : Escape

Figure 2-10 Sample waypoint list

- 4) Press the [▲] or [▼] key to select waypoint number.
- 5) Enter latitude and longitude. (For South latitude or East longitude, press the [-] or [+] key.)
- 6) The cursor should be in the “Display” column and “Yes” selected. You will learn a little while later what this column means. For now, press the [▶] key once if you want to enter comments, or press the [ENT] key to register the waypoint.
- 7) Press the [ENT] key.
- 8) Press the [MENU] key to escape.

Changing Waypoint Data

You may change the latitude and longitude position and comments of waypoints you have entered, through the waypoint list.

- 1) Press the [WPT] key.
- 2) Press the [▶] key to select “WPT List.”
- 3) Press the [ENT] key. The waypoint list appears.
- 4) Operate the [▲] or [▼] key to select waypoint number.
- 5) Operate the [◀] or [▶] key to select column in which to edit or add data. Change data as necessary.
- 6) Press the [ENT] key.
- 7) Press the [MENU] key to close the window.

Deleting Waypoints

The GP-1800F provides two ways by which you can delete waypoints:

- by the cursor, or
- through the waypoint list.

Waypoints which are part of a route cannot be deleted except through the route list. Note that you can easily delete all waypoints by clearing the Plotter memory. More on this later.

By the cursor

- 1) Operate the [Arrow] keys to set the cursor on the waypoint you want to delete.
- 2) Press the [CLEAR] key.

Through the waypoint list

- 1) Press the [WPT] key.
- 2) Press the [▶] key to select "WPT List."
- 3) Press the [ENT] key.
- 4) Press the [▲] or [▼] key to select waypoint number.
- 5) Press the [CLEAR] key.
- 6) Press the [ENT] key.
- 7) Press the [MENU] key.

Hiding/Showing Waypoints

You may choose to hide or show waypoints on the display.

- 1) Press the [WPT] key.
- 2) Press the [▶] key to select "WPT List."
- 3) Press the [ENT] key.
- 4) Press the [▲] or [▼] key to select waypoint number.
- 5) Press the [▶] key several times to set the cursor in the "Display" column.
- 6) Press the [-] key to hide the waypoint. "No" replaces "Yes."
- 7) Press the [ENT] key.
- 8) Press the [MENU] key.

When you want to show the waypoint, press the [+] key in step 6 of the above procedure.

Setting Destination Waypoint

The GP-1800F offers four methods by which you can set destination waypoint:

- by the cursor
- by waypoint number

- by route number (discussed in next chapter), or
- by event position (discussed in “2.8 The Event Mark”).

When you select a destination waypoint, range and bearing from own ship to that point appear at the bottom of the display.

By the cursor

Setting a destination by the cursor allows you to enter multiple points leading to the ultimate destination. In the next section you will learn how to set multiple points, and store them as a route. The procedure which follows shows you how to set ultimate destination (single waypoint).

- 1) Press the [GOTO] key. The following display appears.

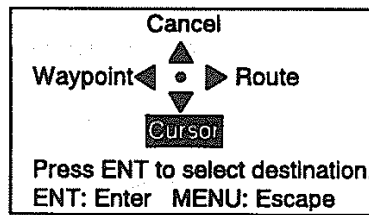
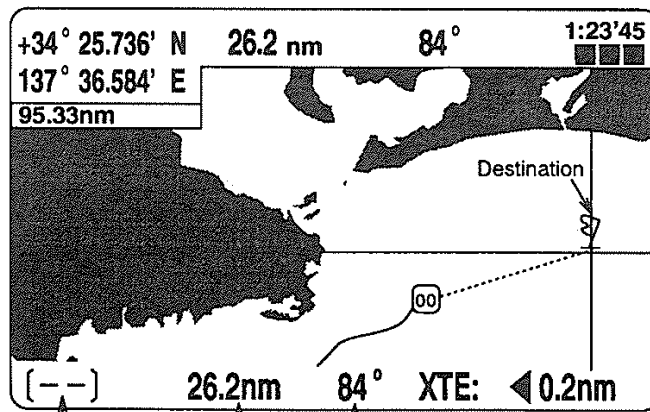

Figure 2-11 Display for selection of destination

- 2) Press the [▼] key to select “Cursor.”
- 3) Press the [ENT] key.
- 4) Operate the [Arrow] keys to set the cursor on destination.
- 5) Press the [ENT] key.

When a single destination point is selected by cursor;

- A flag marks destination and a dashed line runs between it and own ship’s position, marked as “00.”
- The range and bearing to the destination appear at the bottom of the display.



Appears when destination is selected by cursor. Range Bearing

Figure 2-12 Appearance of display when destination is selected by cursor

By waypoint number

- 1) Press the [GOTO] key.
- 2) Press the [◀] key to select "Waypoint."

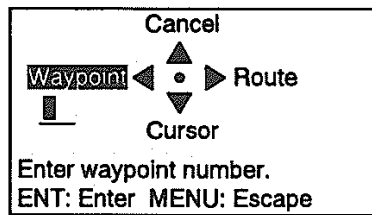
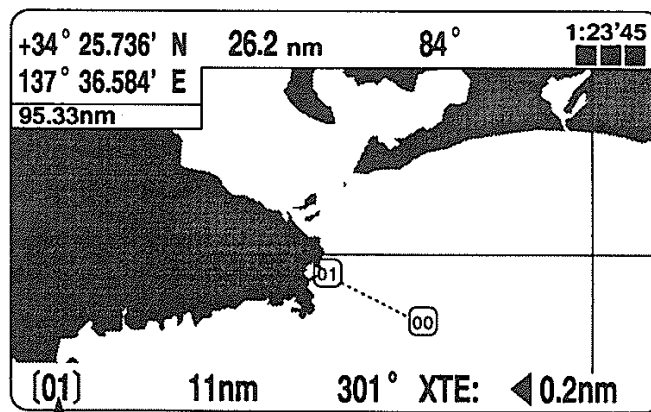

Figure 2-13 Display for selection of destination by waypoint number

- 3) Enter waypoint number in two digits.
- 4) Press the [ENT] key.

When a waypoint is selected as destination;

- A dashed line runs between waypoint selected and own ship's position.
- The range and bearing to the destination appear at the bottom of the display.



Waypoint No.

Figure 2-14 Appearance of display when destination is selected by waypoint

Cancelling Destination Waypoint

- 1) Press the [GOTO] key.

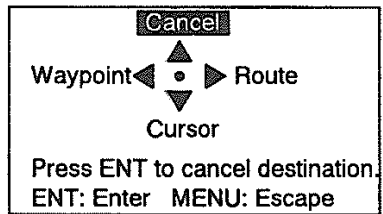

Figure 2-15 Cancelling destination

- 2) Press the [▲] key to select "Cancel."
- 3) Press the [ENT] key.

2.6 Route Navigation

Overview

Often a trip from one place to another involves several course changes, requiring a series of route points (waypoints) which you navigate to, one after another. The sequence of waypoints leading to the ultimate destination is called a **route**. The GP-1800F can automatically advance to the next waypoint on a route, so you do not have to change the destination waypoint repeatedly.

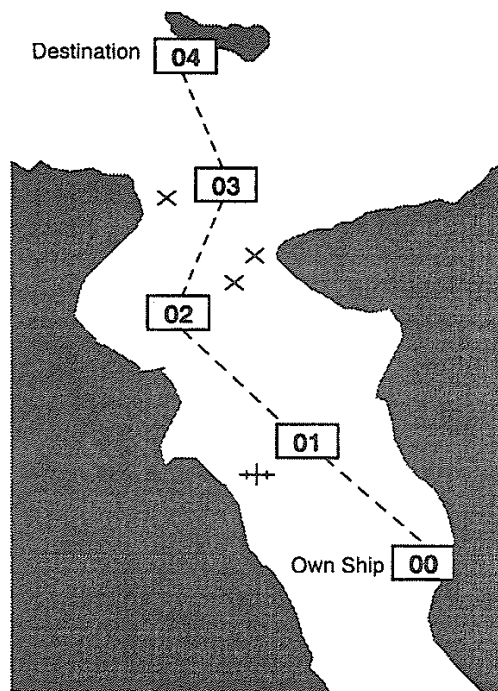

Figure 2-16 Sample route

Registering Routes

You can store up to 10 routes and each route may contain up to 30 points. The GP-1800F numbers them from 01 to 10, on the route list.

A route can be constructed two ways: through the route list or by using the cursor.

By the cursor

- 1) Press the [GOTO] key.

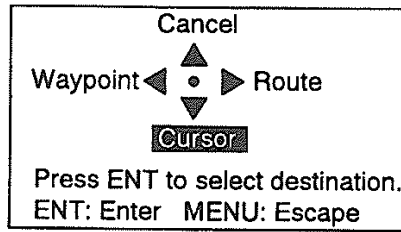
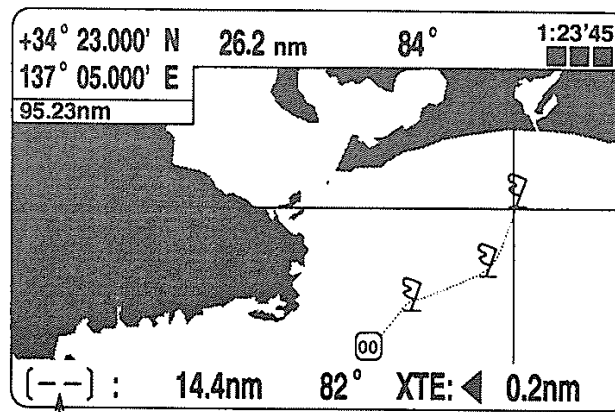

Figure 2-17 Display for selection of destination

- 2) Press the [▼] key to select "Cursor."
- 3) Press the [ENT] key.
- 4) Operate the [Arrow] keys to place the cursor on the first destination waypoint.
- 5) Press the [+] key. (You can clear a wrong entry by pressing the [-] key.)
- 6) Repeat steps 4 and 5 to complete the route.
- 7) Press the [ENT] key.
- 8) Enter route number. (If you do not want to store the route permanently, press the [ENT] key to escape.)
- 9) Press the [ENT] key.

Flags mark waypoints and a dashed line connects all waypoints including own ship's position. The range and bearing to the first waypoint appear at the bottom of the display.



Appears when following cursor-created route.

Figure 2-18 Appearance of cursor-created route selected for navigation

Through the route list

One advantage of this method is that you can use waypoints which you have already entered.

- 1) Press the [MENU] key.
- 2) Press the [4] key to select "ROUTE/ROUTE LIST."

ROUTE/ROUTE LIST				
No.	Pts.	Total Dist	TTG(H:M)	Status
01	5	1234. 56nm	62 : 69	
02	10	2345. 67nm	51 : 78	In Use
03	15	3456. 78nm	21 : 89	
04	0	0. 00nm		
05	0	0. 00nm		
06	0	0. 00nm		
07	0	0. 00nm		
08	0	0. 00nm		
09	0	0. 00nm		
10	0	0. 00nm		

▲▼ : Cursor ► : Select MENU : Escape

Figure 2-19 ROUTE/ROUTE LIST

- 3) Press the [▲] or [▼] key to select route number.
- 4) Press the [►] key.

ROUTE/ROUTE LIST		Route: 04			
WPT	LAT	LONG	LEG	TTG (H:M)	
01	20 34° 44. 567' N	131° 22. 320' E	0. 00nm	0:00	
02	21 35° 43. 568' N	132° 23. 321' E	78. 96nm	6:14	
03	-22 36° 42. 569' N	133° 24. 322' E	89. 95nm	7:35	
04	23 37° 41. 560' N	134° 25. 323' E	98. 94nm	3:68	
		⋮			
		⋮			
		⋮			
		⋮			
		⋮			

▲▼◀▶ : Cursor MENU : Escape ENT: Enter
+ : N, E, Restore - : S, W, Skip

Minus sign means waypoint is skipped.

Figure 2-20 ROUTE/ROUTE LIST, waypoint entry display

- 5) Enter waypoint numbers in the order in which you will traverse them. (If a waypoint is already registered its position appears. Any waypoints you newly register here will also be registered on the waypoint list.)
- 6) Press the [ENT] key.

NOTE: The Time-To-Go (TTG) between legs on routes is calculated based on the trial speed entered on the last page of a route. The default speed is 10 knots.

- 7) Press the [MENU] key.

Changing Route Contents

Skipping route waypoints

- 1) Press the [MENU] key.
- 2) Press the [4] key.
- 3) Press the [▲] or [▼] key to select route number.
- 4) Press the [▶] key.
- 5) Press the [Arrow] keys to set the cursor in the WPT column of the route waypoint you want to skip.
- 6) Press the [-] key to skip that point temporarily. A minus sign appears to the left of route waypoint.
- 7) Press the [ENT] key.
- 8) Press the [MENU] key twice to escape.

Restoring route waypoints

Press the [+] key in step 6 of the above procedure to erase the minus sign.

Changing L/L position of route waypoints

- 1) Press the [MENU] key.
- 2) Press the [4] key.
- 3) Press the [▲] or [▼] key to select route number.
- 4) Press the [▶] key.
- 5) Press the [Arrow] keys to set the cursor in the LAT (or LONG) column of the route point you want to change position.
- 6) Enter new position.
- 7) Press the [ENT] key.
- 8) Press the [MENU] key twice to escape.

Deleting Route Waypoints

- 1) Press the [MENU] key.
- 2) Press the [4] key.
- 3) Press the [▲] or [▼] key to select route number.
- 4) Press the [ENT] key.
- 5) Press the [▲] or [▼] key to select route waypoint which you want to delete.
- 6) Press the [CLEAR] key.
- 7) Press the [ENT] key.
- 8) Press the [MENU] key twice to escape.

NOTE: *To delete entire route, delete all waypoints.*

Following a Route

Following a route is the process by which you use a registered route for navigation. This unit displays navigation information to guide you from one waypoint to the next, as it automatically switches from one waypoint to another in sequence.

- 1) Press the [GOTO] key.
- 2) Press the [▶] key to select "Route."

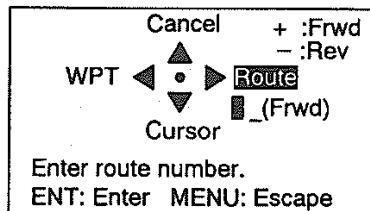

Figure 2-21 Display for selection of destination by route

- 3) Enter route number.
- 4) If you want to navigate the waypoints of the route in the reverse order, press the [-] key.
- 5) Press the [ENT] key.

Route appearance on the display

- A dashed line connects all waypoints including own ship's position.
- Range and the bearing to the first waypoint appear at the bottom of the display.
- For cursor-created routes, flags denote waypoints.

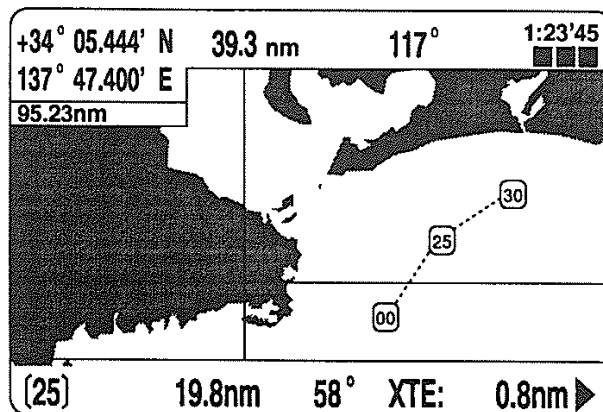

Figure 2-22 Appearance of waypoint-created route selected for navigation

Cancelling Route Navigation

- 1) Press the [GOTO] key.
- 2) Press the [▲] key to select “Cancel.”
- 3) Press the [ENT] key.

NOTE: *For cursor-created registered routes, waypoint “flags” remain on the screen after cancelling route navigation. If you do not require the route and want to erase the flags, delete all route waypoints of the route through the route list.*

2.7 Mark Operations

Overview

You can inscribe marks on the display to denote important locations; for example, buoy, fishing point, wreck. Further, marks can be connected with lines to depict important areas such as a hot fishing spot or danger area.

Entering Marks

To enter a mark at cursor location;

- 1) Press the [0] key to turn on the cursor.
- 2) Operate the [Arrow] keys to place cursor on location.
- 3) Press the [MARK] key.

To enter a mark at ship's position;

- 1) Press the [0] key to turn off the cursor.
- 2) Press the [MARK] key.

The mark currently selected on the TRACK/MARK SETUP menu appears at the location selected.

Changing Mark Size

You may change the size of marks to small or large.

- 1) Press the [MENU] key.
- 2) Press the [1] key to select "DISPLAY SETUP."

DISPLAY SETUP		▼ : Next Page	
Display	Normal	Reverse	
Land Pattern	Dark	Med	Light OFF
Place-Name	Dark	Light	OFF
Grid	Dark	Light	OFF
Course Bar	Dark	Light	OFF
Time Mark	Dark	Light	OFF
MOB Data	ON	OFF	
Waypoint Mark Size	Large	Small	
Mark Size	Large	Small	
Cursor Size	Large	Small	
▲▼◀▶ : Select ENT: Enter MENU: Escape			

Figure 2-23 DISPLAY SETUP menu

- 3) Operating the [Arrow] keys, select “Mark Size” and “Large” or “Small.”
- 4) Press the [ENT] key.
- 5) Press the [MENU] key.

Changing Mark Shape and Tone

- 1) Press the [MENU] key.
- 2) Press the [2] key to select “TRACK/MARK SETUP.”

TRACK/MARK SETUP	
Track Rec	Auto Time (00'10) Dist (00.10nm)
Mark Shape	○ □ ◇ × ▣ ▤ •
Mark Tone	Dark Light
Mark Line	• — - - - -
Event Mark	△ ▽ ⊙ ☆

▲▼◀▶ : Select
 ENT: Enter
 MENU: Escape

Figure 2-24 TRACK/MARK SETUP menu

- 3) Operating the [Arrow] keys, select “Mark Shape” and shape desired.
- 4) Operate the [Arrow] keys to select “Mark Tone” and tone desired.
- 5) Press the [ENT] key.
- 6) Press the [MENU] key.

Erasing Marks

Marks can be erased individually, collectively, or within an area you specify. How to erase marks collectively and by area will be discussed in “2.12 Erasing Tracks, Marks.”

- 1) Press the [0] key to turn on the cursor.
- 2) Operate the [Arrow] keys to place the cursor on the mark to erase.
- 3) Press the [CLEAR] key.

Connecting Marks

Marks can be connected with solid or dashed lines. This feature is useful for denoting important areas. You can even construct your own charts, and save them to a memory card for future replay.

- 1) Press the [MENU] key.
- 2) Press the [2] key to select "TRACK/MARK SETUP."
- 3) Operate the [Arrow] keys to select "Mark Line" to other than "single dot."
- 4) Press the [ENT] key.
- 5) Press the [MENU] key to close the menu.
- 6) Press the [0] key to turn on the cursor.
- 7) Press the [Arrow] keys to place the cursor on location desired for mark.
- 8) Press the [MARK] key.
- 9) Repeat steps 7 and 8 to continue entering and connecting marks.

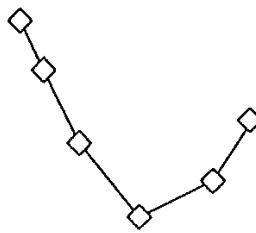

Figure 2-25 Marks connected with lines

To return to individual entry of marks, set "Mark Line" to "single dot" in step 3 of the above procedure and then press the [ENT] and [MENU] keys.

2.8 The Event Mark

Overview

The event mark is used to mark present position. It is useful for denoting important locations, such as good fishing spots or wrecks. You may enter 99 event marks.

The GP-1800F saves and numbers event positions from 01 to 99, 01 being the latest. When the event position memory is full the oldest event position is erased to make room for the latest.

Entering an Event Mark

Press the [EVENT/MOB] key. The event mark appears at present position.

Viewing Past Event Positions

You can view past event positions as follows.

- 1) Press the [ENT/RECALL] key. The latest event position (01) appears.

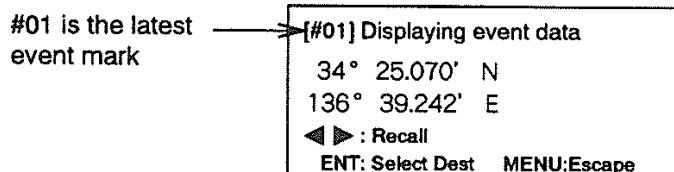

Figure 2-26 Event position display

- 2) Press the [◀] or [▶] key to display event position desired. You can press and hold down those keys to scroll the display faster.
- 3) Press the [MENU] key to escape.

Erasing Event Marks

- 1) Press the [0] key to turn on the cursor, if it is not currently displayed.
- 2) Operate the [Arrow] keys to place the cursor on the event mark you want to erase.
- 3) Press the [CLEAR] key.

Setting Past Event Position as Destination

- 1) Press the [ENT/RECALL] key.
- 2) Press the [◀] or [▶] key to display event position desired.
- 3) Press the [ENT] key.

Changing Event Mark Shape

- 1) Press the [MENU] key.
- 2) Press the [2] key to select “TRACK/MARK SETUP.”
- 3) Operate the [Arrow] keys to select “Event Mark” and shape desired.
- 4) Press the [ENT] key.
- 5) Press the [MENU] key to close the menu.

2.9 The MOB Function

Overview

The MOB (Man OverBoard) function can be enabled on the DISPLAY SETUP menu. When enabled, the [EVENT/MOB] key functions to mark man overboard position. The range and bearing to the MOB position are continuously updated on the display, to help you navigate to the MOB position.

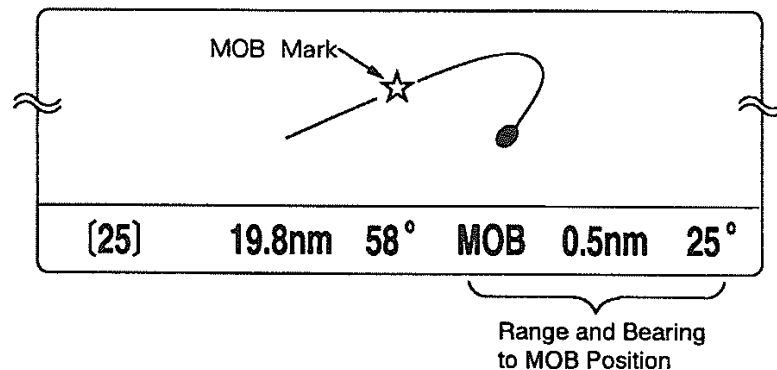
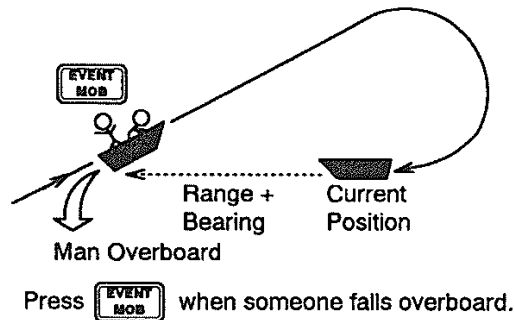

Figure 2-27 The MOB function

Enabling the MOB Function

- 1) Press the [MENU] key.
- 2) Press the [1] key to display the DISPLAY SETUP menu.
- 3) Operate the [Arrow] keys to display "MOB Data On."
- 4) Press the [ENT] key.
- 5) Press the [MENU] key.

2.10 Stopping, Resuming Plotting of Track

Overview

When your boat is at anchor or returning to port you probably won't need to record its track. You can stop recording the track, to conserve the track memory, by pressing the [PLOT ON/OFF] key. The message "Stopping plotting of track." appears momentarily, "H" is displayed, and own ship mark becomes hollow. To resume recording, press the key again. The message "Resuming plotting of track." appears momentarily.

2.11 Changing Track Plotting Interval

Overview

In drawing the track, the ship's position (fed from the navigation aid) is stored into this unit's memory at an interval of time, distance or automatic recording. A shorter interval provides better reconstruction of the track, but the storage time of the track is reduced. When the track memory becomes full, the oldest track is erased to make room for the latest.

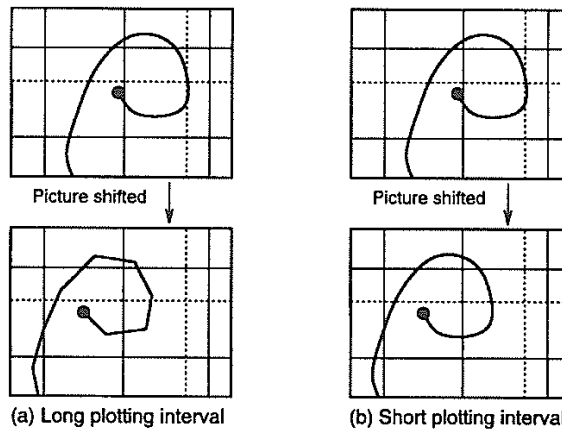

Figure 2-28 Track reconstruction and plotting interval

- 1) Press the [MENU] key.
- 2) Press the [2] key to select "TRACK/MARK SETUP."

TRACK/MARK SETUP	
Track Rec	Auto Time (00'10) <u>Dist</u> (00.10nm)
Mark Shape	○ □ ◇ × ▽ ▢ ·
Mark Tone	<u>Dark</u> Light
Mark Line	· — ·····
Event Mark	△ ▽ ⊙ ☆
▲▼◀▶ : Select ENT: Enter MENU: Escape	

Figure 2-29 TRACK/MARK SETUP menu

- 3) Operate the [Arrow] keys to select Auto, Time or Dist on the "Track Rec" line. (*Auto* stores ship's track at a rate of Rec Resolution set on the SYSTEM SETUP 1/3 menu. See page 4-16 for details. *Dist* plots ship's track only when the boat is moving, thus no track is saved to the memory when your boat is dead in water.)
- 4) For time or distance, enter interval.
- 5) Press the [ENT] key.
- 6) Press the [MENU] key to close the menu.

2.12 Erasing Tracks, Marks

Overview

You can erase track and marks individually, collectively or by area.

- 1) Press the [MENU] key.
- 2) Press the [3] key to select "ERASE TRACK/MARK."

ERASE TRACK/MARK			
Erase	Track	Mark	Track+Mark
Erasure Rng	No	All	Area
		Track Pts Used	: 1984/2000Pt
		Mark Pts Used	: 5/2000Pt
▲▼◀▶ : Select ENT: Enter MENU: Escape			

Figure 2-30 ERASE TRACK/MARK menu

- 3) Operate the [Arrow] keys to select item(s) to erase; track, mark, or both track and mark.
- 4) Operate the [Arrow] keys to select erasure range; All or Area (by cursor).
- 5) Press the [ENT] key.
- 6) If you selected "All," go to step 8. For erasure by area, move the cursor to a beginning point which will enclose items to erase. Press the [ENT] key.
- 7) Operate the [Arrow] keys to enclose track/marks by rectangle cursor.

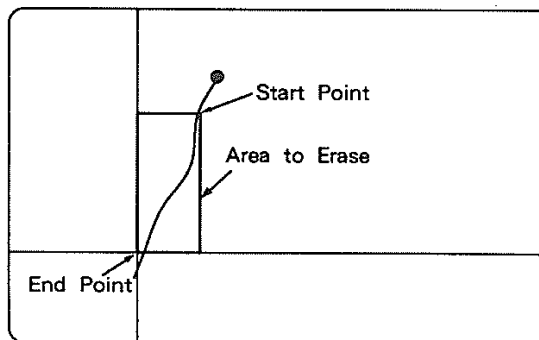

Figure 2-31 How to erase track, marks by the cursor

- 8) Press the [ENT] key twice.

PART 3

Video Sounder Operation

3.1 Principle of Operation

How the Video Sounder Works

The Video Sounder of the GP-1800F determines the distance between its transducer and underwater objects such as fish, lake bottom or seabed and displays the results on an 8-inch LCD screen. It does this by utilizing the fact that an ultrasonic wave transmitted through water travels at a nearly constant speed of 4800 feet (1500 meters) per second. When a sound wave strikes an underwater object such as fish or sea bottom, part of the sound wave is reflected back toward the source. Thus by calculating the time difference between the transmission of a sound wave and the reception of the reflected sound wave, the depth to the object can be determined.

The entire process begins in the display unit. Transmitter power is sent to the transducer as a short pulse of electrical energy. The electrical signal produced by the transmitter is converted into an ultrasonic signal by the transducer and transmitted into the water. Any reflected signals from intervening objects (such as a fish school) are received by the transducer and converted back into an electrical signal. It is then amplified in the amplifier section, and finally, displayed on the screen.

The picture displayed is made up of a series of vertical scan lines, one for each transmission. Each line represents a "snapshot" of what has occurred beneath the boat. The series of snapshots are accumulated side by side across the screen, and the resulting contours of the bottom and fish between the bottom and surface are displayed.

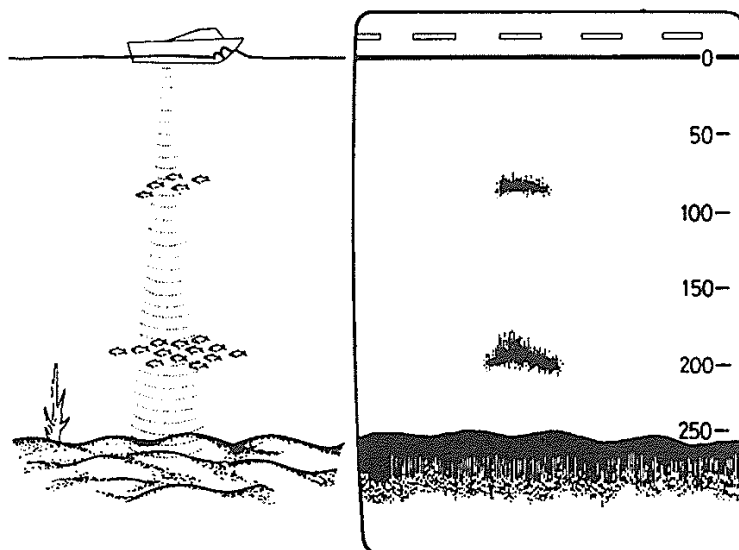

Figure 3-1 Typical video sounder display

3.2 Selecting Video Sounder Displays

Overview

The GP-1800F provides four types of video sounder displays: normal, bottom zoom, bottom-lock, and marker zoom. Each display has its advantages and disadvantages. You should select appropriate video sounder display, on the VIDEO SOUNDER SETUP menu, considering current sea area and target fish.

To view the seabed echo while plotting ship's track, select the Plotter/Sounder combination display with the [DISPLAY SEL] key.

Normal Display

This is a basic display mode for observing fish school and seabed.

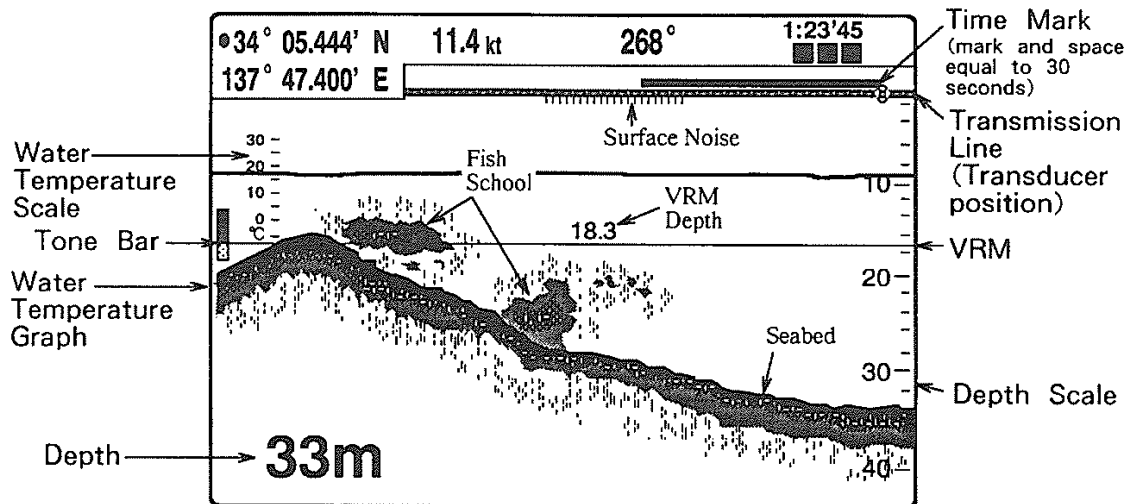

Figure 3-2 Sample normal display

Expansion (Zoom) Displays

Three types of the zoom displays are available: bottom-lock, bottom zoom, and marker zoom.

Bottom-lock

The bottom-lock expansion display provides a compressed normal display on the right side and a “narrow” or “wide” layer (distance depends on unit of measurement) in contact with the seabed onto the rest of the screen with the seabed contour displayed by a straight line on the bottom-lock display. The range of expansion is marked by a dotted line on the normal display. This display offers excellent bottom fish discrimination, which is vital for bottom trawling.

NOTE: *For the bottom-lock expansion display, the seabed contour must be steadily and distinctly plotted in dark tone. Adjust the Gain if necessary. You may select the bottom-lock expansion range (EXP Range) and turn on the expansion marker (EXP Marker) on the SYSTEM SETUP menu.*

Bottom zoom

The bottom zoom display expands bottom and bottom fish echoes two, three, four or five times on the left half of the screen. The zone expanded is indicated by the zoom range markers on the normal display.

The zone automatically moves so that the bottom echoes locate on the lower half screen.

This mode is useful for observing hardness of the bottom closely together with bottom fish. Many fishermen find the place where bottom fish are likely to be from the shape of bottom profile and length of bottom echoes. The length of the bottom echo is an indication of bottom hardness: the longer the echo, the harder the bottom. In addition, as you become acquainted with this mode, you may find a small school of bottom fish which might otherwise be overlooked on other displays.

NOTE: *The zoom range (EXP Range) and the zoom range marker (EXP Marker) can be selected on the SYSTEM SETUP menu.*

Marker zoom

This mode expands any location on the normal display to full vertical size of the screen on the left half of the screen. You may specify the portion to expand with the VRM and the zoom marker.

How to Preselect a Video Sounder Display

- 1) Press the [MENU] key.
- 2) Press the [7] key to open the VIDEO SOUNDER SETUP menu.

VIDEO SOUNDER SETUP	
◆ Clutter	4 (Low 0 – 9 High)
Pic Advance	Stop Slow Normal Fast
EXP Display	Btm Zm Btm Lk Mkr Zm Off
Bright Echo	On Off
Water Temp Graph	On Off
Noise Limiter	Off Low Med High
Erase Signal	On Off
 : Select ENT: Enter MENU: Escape	

Figure 3-3 Video sounder setup menu

- 3) Operate the [Arrow] keys to select “EXP Display” and display type desired. The Off position is for normal display.
- 4) Press the [ENT] key.
- 5) Press the [MENU] key to close the menu.

3.3 Basic Operation of the Video Sounder

Overview

The video sounder can be operated automatically or manually. Automatic operation is useful when you are preoccupied with other tasks and do not have the time to adjust the display.

Automatic Operation

How it works

In automatic video sounder operation, the proper gain and range scale are automatically selected according to depth. It works as follows:

- Range changes automatically to locate the bottom on the lower half of the screen. It jumps to one step shallower range when bottom echoes reach a half way point of the full scale from the top and to one step deeper range when they come to the lower edge of the scale.
- The gain is automatically adjusted to display the bottom echo in dark tone.
- Clutter level (on the VIDEO SOUNDER SETUP menu) is automatically adjusted.

Basic procedure

- 1) Press the [SNDR] key to open the video sounder operation window.

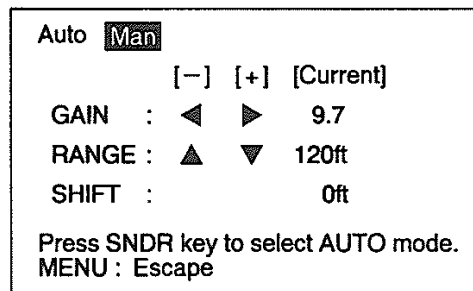

Figure 3-4 Video sounder setup display

- 2) If the “Man” position is highlighted, press the [SNDR] key to select “Auto” operation.
- 3) Press the [MENU] key to close the window.

Manual Operation

Manual operation is useful for observing fish schools and the seabed using fixed gain, range and shift settings.

Basic procedure

- 1) Press the [SNDR] key followed by the [▶] key to select “Man” (manual operation), if not already selected.
- 2) Press the [Arrow] keys or the [Scale] keys to change settings, if required.
- 3) Press the [MENU] key to close the window.

Selecting display range

The basic range and range shifting functions used together give you the means to select the depth you can see on the screen. The basic range can be thought of as providing a “window” into the water column and the range shifting as moving the “window” to the desired depth.

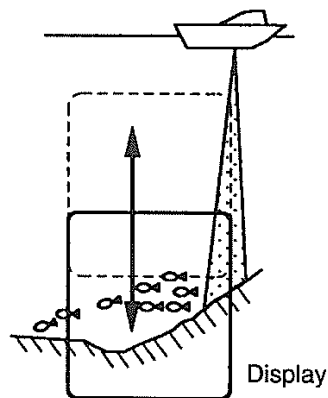

Figure 3-5 Basic range and range shifting concept

NOTE: *The unit of depth measurement may be selected on the SYSTEM SETUP menu.*

Adjusting gain

The [◀] or [▶] key adjusts the sensitivity of the receiver. Normally, set it to the point where excessive noise does not appear on the screen. As a general rule of thumb, use a higher gain setting for greater depths and a lower setting for shallower waters.

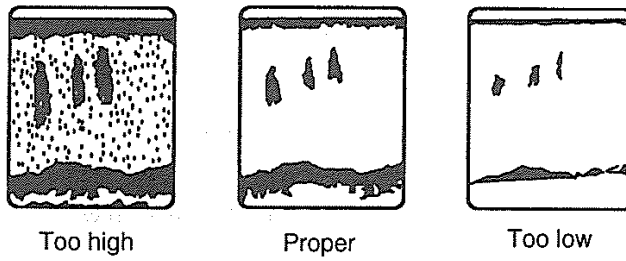

Figure 3-6 Examples of proper and improper gain

3.4 Adjusting the Video Sounder Picture

Overview

Sea conditions and electrical noise from external equipment can disturb the video sounder picture. This chapter shows you how to adjust the picture. All functions mentioned in this chapter are carried out through the VIDEO SOUNDER SETUP menu.

VIDEO SOUNDER SETUP	
◆ Clutter	4 (Low 0 – 9 High)
Pic Advance	Stop Slow Normal Fast
EXP Display	Btm Zm Btm Lk Mkr Zm Off
Bright Echo	On Off
Water Temp Graph	On Off
Noise Limiter	Off Low Med High
Erase Signal	On Off

▲▼◀▶ : Select ENT: Enter MENU: Escape

Figure 3-7 VIDEO SOUNDER SETUP menu

Eliminating Low Level Noise

When blue dots appear on a large part of the screen mainly due to water contamination or unit's internal noise, adjust "Clutter" to eliminate them.

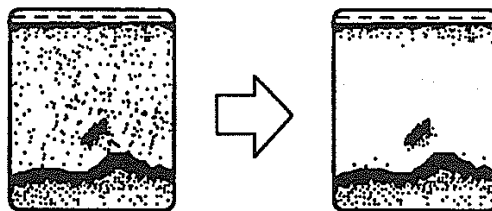

Figure 3-8 How the clutter function works

Brightening Fish Echoes

When you wish to display fish schools in dark tone. Turn on the Bright Echo feature, in the VIDEO SOUNDER SETUP menu.

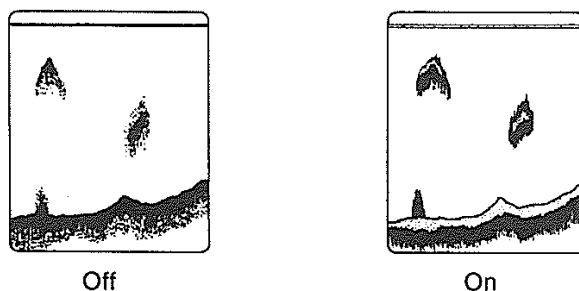

Figure 3-9 Bright echo display

Eliminating Interference

Interference from other acoustic equipment or other electronic equipment may show itself on the display as depicted in the figure below. Adjust the “Noise Limiter” to eliminate it.

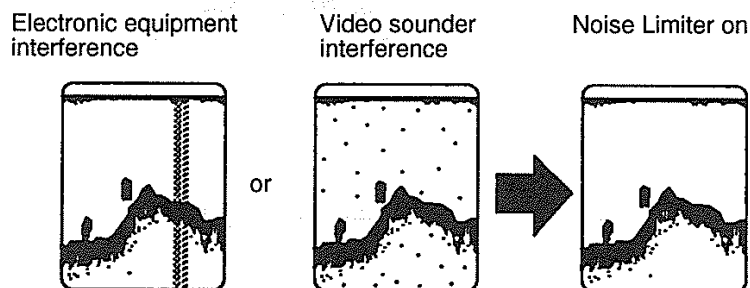

Figure 3-10 How the noise limiter function works

Displaying Strong Echoes Only

You can erase the lowest strength level echo, to clear the picture, by turning on the “Erase Signal” on the VIDEO SOUNDER SETUP menu.

Selecting Picture Advance Speed

“Pic Advance” sets the picture advance speed. “Stop” freezes the picture indefinitely.

When selecting an advance speed, keep in mind that a fast advance speed will expand the size of the fish school horizontally on the screen and a slow advance speed will contract it.

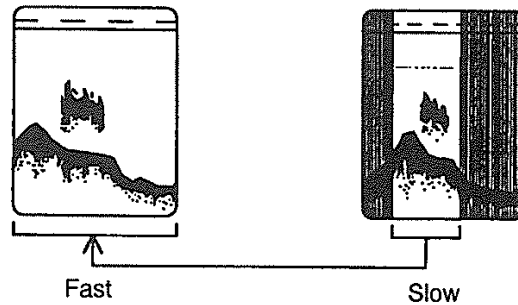

Figure 3-11 Comparison of picture advance speeds

Procedure

- 1) Press the [MENU] key.
- 2) Press the [7] key.
- 3) Operate the [Arrow] keys to select the items desired.
- 4) Press the [ENT] key.
- 5) Press the [MENU] key.

3.5 Measuring Depth

Measuring Depth by the VRM

The VRM (Variable Range Marker), which is always displayed, measures depth. Place it on the object you wish to know the depth by pressing the [▲] or [▼] key. Depth is digitally displayed above the VRM.

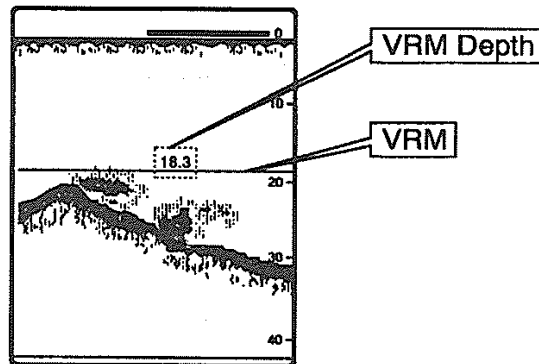

Figure 3-12 How to use the VRM

3.6 Fish and Bottom Alarms

Fish Alarm

This alarm alerts you by aural and visual alarms when a fish echo is within the preset alarm range.

Bottom Alarm

This alarm function alerts you when the seabed enters into the specified alarm zone.

Setting the Alarms

- 1) Press the [MENU] key.
- 2) Press the [5] key to select "ALARM SETTINGS."
- 3) Press the [▲] or [▼] key to select Fish or Bottom alarm.
- 4) Press the [◀] key to turn on the alarm.
- 5) Enter alarm range with numeral keys.
- 6) Press the [ENT] key.
- 7) Press the [MENU] key to close the menu.

When echo corresponding to active alarm enters alarm range, aural and visual alarms are released.

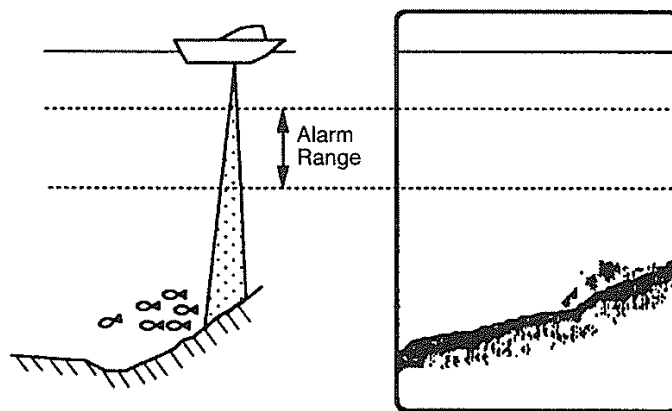

Figure 3-13 How the alarms work

Silencing the Aural Alarm and Closing Alarm Message Window

- 1) Press the [CLEAR] key, and the aural alarm is silenced, but the alarm message window is still open.
- 2) Press the [CLEAR] key to close the alarm message window.

NOTE:

- 1) *The alarm icon (🔔) remains on the screen until alarm is disabled.*
- 2) *The alarms will be released the next time an alarm setting (s) is violated.*

3.7 Displaying the Water Temperature Graph

Overview

By connecting a water temperature indicator, a water temperature graph can be displayed.

Procedure

- 1) Press the [MENU] key.
- 2) Press the [7] key to select the VIDEO SOUNDER SETUP menu.
- 3) Operate the [Arrow] keys to display “Water Temp Graph On.”
- 4) Press the [ENT] key.
- 5) Press the [MENU] key.

Correcting Water Temperature Readout

In some instances the water temperature readout may be off by a few degrees. You can correct it as follows.

- 1) Press the [MENU] key.
- 2) Press the [9] key to select the SYSTEM SETUP menu.
- 3) Press the [Arrow] keys to select “Temperature Offset” on page 2/3 of the menu.
- 4) Enter correction with numeral keys.
- 5) Press the [ENT] key.
- 6) Press the [MENU] key.

3.8 Changing Video Sounder Settings on the SYSTEM SETUP Menu

Overview

The SYSTEM SETUP menu, menu 9, contains several items related to video sounder operation. You can adjust them to suit your operating needs.

Water depth offset

To read actual sea depth, the zero line can be offset by the depth of the transducer.

Output power

Output power is normally set to "Normal," maximum power. However, you may want to lower it (on "TX Power" on page 2/3 of the menu) in the following cases.

- Reduce strong seabed echoes when in shallow waters.
- Avoid mutual interference when operating nearby other video sounders.

Expansion range

You can set the expansion range to x2, x3, x4, or x5.

Expansion markers

The expansion markers can be turned on or off.

Reducing near surface reflections (TVG)

Raise the TVG setting when echoes near the surface clutter the picture.

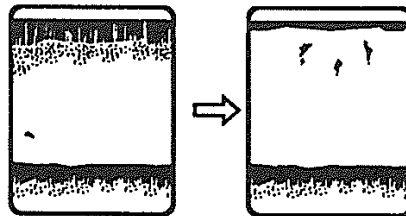

Figure 3-14 Effect of TVG

Echo level offset

This value determines minimum echo sensitivity. Reduce the setting when sensitivity appears to be too high.

Bottom-lock range

The bottom-lock range can be set to wide or narrow. (In meters, this is 5 and 10 meters, respectively.)

Fish alarm level

This sets the minimum fish echo strength which will trigger the fish alarm.

Seabed level

This sets the minimum seabed echo strength which triggers the bottom alarm.

Operation on the SYSTEM SETUP Menu

- 1) Press the [MENU] key.
- 2) Press the [9] key to select the SYSTEM SETUP menu.
- 3) Press the [▼] key to select page 2/3 of the menu page and item.
- 4) Press the [◀] or [▶] key to change setting or select location where to enter data.
- 5) Press the [ENT] key.
- 6) Press the [MENU] key.

PART 4

Application

4.1 Alarms

Overview

There are eight conditions (including fish and bottom alarms) which generate both aural and visual alarms in this unit. For fish and bottom alarms, see page 3-13.

Arrival Alarm, Anchor Watch Alarm

Arrival alarm (waypoint arrival alarm)

The arrival alarm informs you that your boat is approaching a destination waypoint. The area that defines an arrival zone is that of a circle which you approach from the outside of the circle. The alarm will be released if your boat enters the circle.

Anchor watch alarm

The anchor watch alarm sounds to warn you that your boat is moving when it should be at rest.

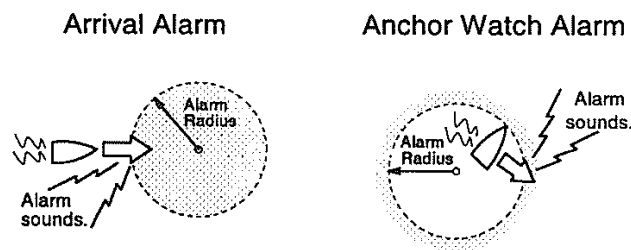

Figure 4-1 How the arrival and anchor watch alarms work

Cross Track Error (XTE) Alarm, Border Alarm

XTE alarm (Off-course to waypoint alarm)

The XTE alarm warns you when your boat is off its intended course.

Border alarm (Border proximity alarm)

The border defines an area, comprised of a starting and destination waypoint, which you do not want your boat to cross. The alarm sounds when the boat crosses the area defined by the two waypoints.

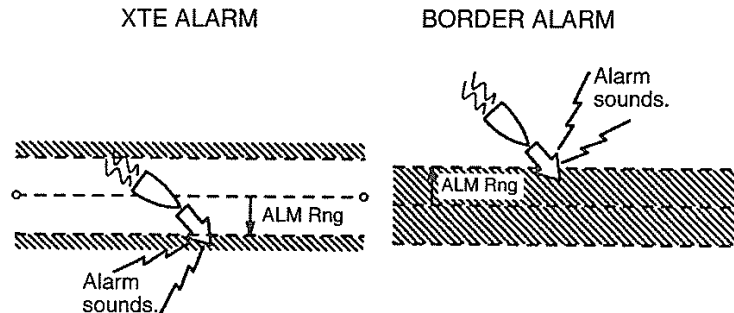

Figure 4-2 How the XTE and border alarms work

Ship's Speed Alarm

The ship's speed alarm sounds when your boat's speed is either within or over the alarm range set.

Water Temperature Alarm

The water temperature alarm sounds when the water temperature is either within or over the preset temperature range. This alarm is useful for searching for specific species of fish, since each species of fish has its own habitable water temperature. (This alarm requires connection of a water temperature sensor.)

Enabling the Alarms

- 1) Press the [MENU] key.
- 2) Press the [5] key to select "ALARM SETTINGS."

ALARM SETTINGS			
Arrival/Anchor	Arrival	Anchor	OFF
Alarm Range	00. 500nm		
XTE/Border	XTE	Border	OFF
Alarm Range	00. 250nm		
Ship Speed	Within	Over	OFF
Speed Range	10. 0kt-12.0kt		
Water Temperature	Within	Over	OFF
Temp. Range	+11.0~+15.0 °C		
Fish Alarm	ON (011.0ft-015.0ft)		OFF
Bottom Alarm	ON (011.0ft-015.0ft)		OFF
▲▼◀▶: Select ENT: Enter MENU: Escape			

Figure 4-3 ALARM SETTINGS menu

- 3) Operate the [Arrow] keys to select alarm desired.
- 4) For other than Fish and Bottom alarms, press the [▼] key.
- 5) Enter alarm range.
- 6) Press the [ENT] key.
- 7) Press the [MENU] key to close the menu.

NOTE: Avoid exceeding the default arrival alarm range (00.500 nm) to prevent release of the alarm on a distant waypoint.

Deleting Aural and Visual Alarms

When an alarm setting is exceeded, both aural and visual alarms are released. You can silence the aural alarm by pressing the [CLEAR] key. To erase the visual alarm, press the [CLEAR] key again. The aural and visual alarms will be generated at the next violation of the active alarm(s).

Disabling Alarms

Select "OFF" in step 3 in "Enabling the Alarms" and then press the [ENT] and [MENU] keys.

4.2 Chart, GPS Position Correction

Chart Position Correction

In some instances chart position may be off by a few minutes. For example, the position of the ship is shown to be at sea while it is in fact moored at a pier. You can compensate for this error by applying chart correction.

- 1) Press the [MENU] key.
- 2) Press the [0] key to select "CHART OFFSET."
- 3) Press the [▶] key to select "Cursor."

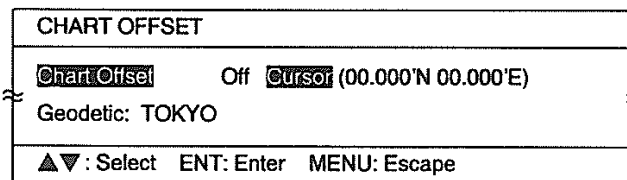



Figure 4-4 CHART OFFSET display

- 4) Press the [ENT] key.
- 5) Set the cursor on correct position.
- 6) Press the [ENT] key. The chart offset icon () appears on the display.
- 7) Press the [MENU] key.

To remove the correction, select "Off" in step 3 of the above procedure and press the [ENT] and [MENU] keys.

GPS Position Correction

You may correct the GPS position to further refine position accuracy.

- 1) Press the [MENU] key.
- 2) Press the [9] key to select "SYSTEM SETUP."
- 3) Operate the [Arrow] keys to go to page 3/3 of the menu and select "Position Offset."

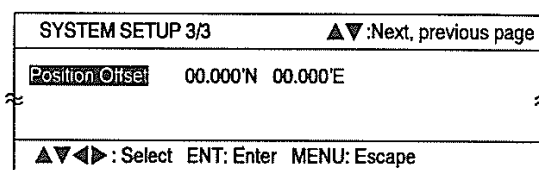

Figure 4-5 SYSTEM SETUP menu page 3/3

- 4) Enter correction value with numeral keys.
- 5) Press the [ENT] key.
- 6) Press the [MENU] key.

“L/L” appears on the left-hand side of the display. To remove the correction, enter zeroes at step 3 in the above procedure and press the [ENT] and [MENU] keys.

4.3 Displaying Loran LOPs

Overview

Ship's position can be displayed in either latitude and longitude or Loran A or C LOPs. To display position in Loran A or C LOPs, do the following.

- 1) Press the [MENU] key.
- 2) Press the [9] key to select "SYSTEM SETUP."

SYSYTEM SETUP1/3		▲▼:Next, previous page	
Memory Apportion	Trk=2000Pt/4000Pt		
Unit of Distance	<input type="text" value="nm"/>	km	sm
Unit of Depth	m	<input type="text" value="ft"/>	Fa ㄷ □ PB
Unit of Temp	<input type="text" value="°C"/>	°F	
Navaid	<input type="text" value="Int. GPS"/>	Ext. GPS	LC DC All
Scale/ Range	<input type="text" value="Scale"/>	Range	
Rec Resolution	2		
Posn Display	Lat/Long	<input type="text" value="LOP"/>	
LOP Display	<input type="text" value="LA"/>	LC	No
LA Chain	00-01 △ +000.0 μ s △ +000.0 μ s		
LC Chain	00:11-26 △ +000.0 μ s △ +000.0 μ s		

Figure 4-6 SYSTEM SETUP menu, position display method

- 3) Operating the [Arrow] keys, select "LOP" on the "Posn Display" line on page 1/3.
- 4) Operating the [Arrow] keys, select "LA" or "LC" on the "LOP DISPLAY" line.
- 5) Enter Loran A (or Loran C) data with the numeral keys.

for Loran A, enter station code

00: 1L0	01: 1L1	02: 1L4	03: 1L5	04: 1L6
05: 1L7	06: 1S1	07: 1S2	08: 1S3	09: 1S4
10: 1S6	11: 2HS	12: 2H4	13: 2H5	14: 2H6
15: 2S0	16: 2S1	17: 2S2	18: 2S3	19: 2S4
20: 2S5	21: 2S6	22: 2S7		

For example, if you are somewhere between Japan Loran A stations 2S3 and 2S4, enter 18(2S3)-19(2S4).

for Loran C, enter GRI and secondary codes

Chain	GRI	S1	S2	S3	S4	S5
Central Pacific	08: 4990	11	29	-	-	-
Canadian East Coast	11: 5930	11	25	38	-	-
Command Lion (Korea)	12: 5970	11	31	42	-	-
Canadian West Coast	05: 5990	11	27	41	-	-
South Saudi Arabia	16: 7170	11	26	36	52	-
Labrador Sea	13: 7930	11	26	-	-	-
Eastern Russia	15: 7950	11	30	46	61	-
Gulf of Alaska	06: 7960	11	26	-	-	-
Norwegian Sea	00: 7970	11	26	46	60	-
Southeast USA	02: 7980	11	23	43	59	-
Mediterranean Sea	10: 7990	11	29	47	-	-
Western Russia	18: 8000	11	25	50	65	-
North Central USA	20: 8290	11	27	42	-	-
North Saudi Arabia	17: 8990	11	25	40	56	69
Great Lakes	03: 8970	11	28	44	-	-
South Central USA	19: 9610	11	25	40	52	65
West Coast USA	04: 9940	11	27	40	-	-
Northeast USA	01: 9960	11	25	39	54	-
Northeast Pacific	09: 9970	11	30	55	81	-
Icelandic	14: 9980	11	30	-	-	-
North Pacific	07: 9990	11	29	43	-	-

For example, if you are currently in Osaka Bay, Japan, enter 09(GRI 9970), 30(S2) and 55(S3).

- 6) Press the [ENT] key.
- 7) Press the [MENU] key.

Entering LOP Correction

You may wish to correct the Loran LOPs shown on the display to further refine position accuracy. After entering Loran chain information, enter correction at step 5 in the above procedure.

4.4 Memory Card Operations

Overview

This chapter shows you how to use the optional RAM memory cards, which record and replay plotter data. (The video sounder picture or data display cannot be recorded.)

Formatting Memory Cards

Before you can use a memory card it must be formatted. Formatting prepares the card for use with the system. *You can format cards which you have previously used in which case all data will be erased.*

- 1) Insert a new memory card into the memory card drive label side up, arrow pointing forward.
- 2) Press the [MENU] key.
- 3) Press the [6] key to select "MEMORY CARD OPERATIONS."

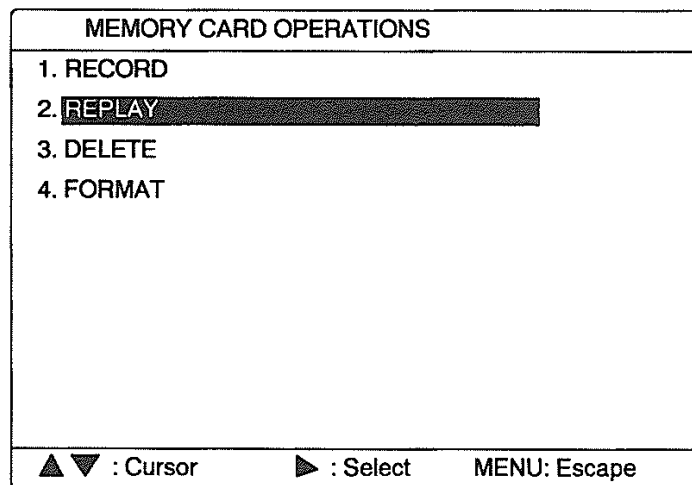

Figure 4-7 MEMORY CARD OPERATIONS menu

- 4) Press the [4] key to select "FORMAT."
- 5) Press the [ENT] key to format the card.
- 6) Press the [MENU] key to close the menu.

Recording Data

- 1) Press the [MENU] key.
- 2) Press the [6] key to select "MEMORY CARD OPERATIONS."
- 3) Press the [1] key to select "RECORD."

RECORD		
Track	<input checked="" type="checkbox"/> YES	<input type="checkbox"/> NO
Mark/ Line	<input checked="" type="checkbox"/> YES	<input type="checkbox"/> NO
Waypoint/ Route	<input checked="" type="checkbox"/> YES	<input type="checkbox"/> NO
Initial Data	<input checked="" type="checkbox"/> YES	<input type="checkbox"/> NO
▲▼◀▶ : Cursor ENT: Enter MENU : Escape		

Figure 4-8 RECORD menu

- 4) Operate the [Arrow] keys to choose items to record.
- 5) Press the [ENT] key.
- 6) Press the [ENT] key again to make a file name under which to record items. (You may write over an existing file if you wish; press the [▲] or [▼] key to select file and press the [ENT] key twice.)
- 7) Enter file name, using up to 16 characters. Press [Arrow] keys to select character and then press the [ENT] key. Repeat to complete file name. Figures, + and - may be entered by direct keyboard input.
- 8) Select "ENTER" and press the [ENT] key.
- 9) Press the [MENU] key to close the menu.

Write Protecting Data

The memory card contains a switch which can prevent writing of information to the card. This prevents accidental erasure of important information. To write protect a memory card, set the switch at the base of the card rightward as shown in the figure below.

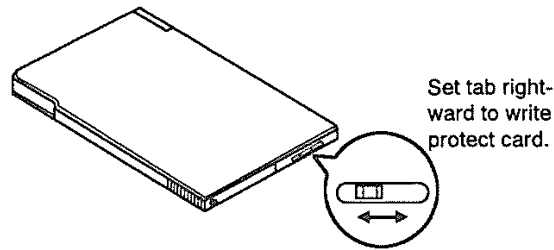

Figure 4-9 Location of writing enable/disable switch on memory card

Replaying Data

Data stored on a memory card can be replayed on the display. This feature is useful for analyzing past track, restoring menu settings, displaying user-constructed charts, etc.

- 1) Press the [MENU] key.
- 2) Press the [6] key to select "MEMORY CARD OPERATIONS."
- 3) Press the [2] key to select "REPLAY."
- 4) Operate the [Arrow] keys to choose items to replay.
- 5) Press the [ENT] key.
- 6) Press the [▲] or [▼] key to select file.
- 7) Press the [ENT] key.
- 8) Press the [MENU] key to close the menu.

Deleting Data

Unwanted data on memory card files can be deleted.

- 1) Press the [MENU] key.
- 2) Press the [6] key to select "MEMORY CARD OPERATIONS."
- 3) Press the [3] key to select "DELETE."
- 4) Operate the [▲] or [▼] key to choose items to delete.
- 5) Press the [ENT] key.
- 6) Press the [▲] or [▼] key to select file.
- 7) Press the [ENT] key.
- 8) Press the [MENU] key to close the menu.

4.5 Customizing the Display on the DISPLAY SETUP Menu

Overview

This chapter shows you how to turn items on or off and change their tone and size, on the DISPLAY SETUP menu.

Procedure

- 1) Press the [MENU] key.
- 2) Press the [1] key to select "DISPLAY SETUP."

DISPLAY SETUP		▼ : Next page		
Display	Normal	Reverse		
Land Pattern	Dark	Med	Light	OFF
Place-Name	Dark	Light	OFF	
Grid	Dark	Light	OFF	
Course Bar	Dark	Light	OFF	
Time Mark	Dark	Light	OFF	
MOB Data	ON	OFF		
Waypoint Mark Size	Large	Small		
Mark Size	Large	Small		
Cursor Size	Large	Small		
▲▼◀▶ : Select ENT: Enter MENU : Escape				

Figure 4-10 DISPLAY SETUP menu

- 3) Press the [Arrow] keys to both select item and set option.
- 4) Press the [ENT] key.
- 5) Press the [MENU] key to close the menu.

Description of DISPLAY SETUP Menu

Display

Select normal (black characters on white background) or reverse tone.

Land Pattern

Select land pattern; hollow or filled (choose tone).

Place-Name

Select tone of place-name shown on chart.

Grid

Select tone of grid.

Course Bar

Select tone of ship's course bar.

Time Mark

Turn time mark on or off.

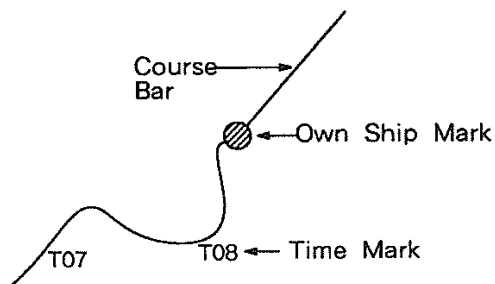

Figure 4-11 Time mark

MOB Data

Select function of the [EVENT MOB] key to event mark (OFF) or MOB (ON).

Waypoint Mark Size

Select size of waypoint mark to large or small.

Mark Size

Select size of mark to large or small.

Cursor Size

Select size of cursor to large or small.

Depth Contours

Select tone of depth contours.

Contours Data

Select tone of depth contour's depth figure.

Other Features

Select tone of other chart features; for example, lighthouses, buoys, etc.

4.6 Changing Plotter-related Settings on the SYSTEM SETUP Menu

Overview

The SYSTEM SETUP menu, menu 9, contains several items related to plotter operation which you may change according to your operating needs. To display the menu, press the [MENU] and [9] keys.

Description of SYSTEM SETUP Menu

Memory Apportion

This unit can store up to 4,000 points of track and marks. The default track storage capacity is 2,000 points. If you want to change track storage capacity to 2,500 points, for example, enter [2], [5], [0], [0] here.

Unit of Distance

You may set the unit of distance measurement to nautical miles, kilometers, or statute miles.

Unit of Depth

The unit of depth measurement can be set to meters, feet, fathoms, hiro, or passi/braza.

Unit of Temperature

Select Centigrade or Fahrenheit.

Navaid

Select navaid which is to feed position data; internal GPS, external GPS, Loran C, Decca, or All. Select "All" for multiple navaid connection. In this case position data is read in the order of GPS, Loran C, Decca, etc.

Scale/Range

Select chart scale display (plotter display) to scale or range.

Rec Resolution

Set the number of dots to record when the plotting interval is set to automatic. (Automatic plotting stores ship's track every 10 seconds or 0.1 nautical miles.) The equation for determining number of dots to record is 5×2^k . For example, if k is "2", the number of dots to record per plotting interval would be twenty; $5 \times 2^2 = 20$ dots.

Position Display

Select position display format; latitude and longitude or Loran LOPs.

LOP Display

If "Posn Display" is selected to LOP, enter Loran chain here. For further details, see "4.4 Displaying Loran LOPs."

Smoothing Factor

Even when the vessel is sailing a straight line the track shown on the display looks crooked. This is due to signal variation of the external navaid. To smooth out this irregularity, change the smoothing factor.

In the following figure, the actual ship's track is shown by a wide hatched arrow and the position being fed from the navaid is shown by black dots. If no smoothing is applied, the track shown on the display will look irregular due to signal variations.

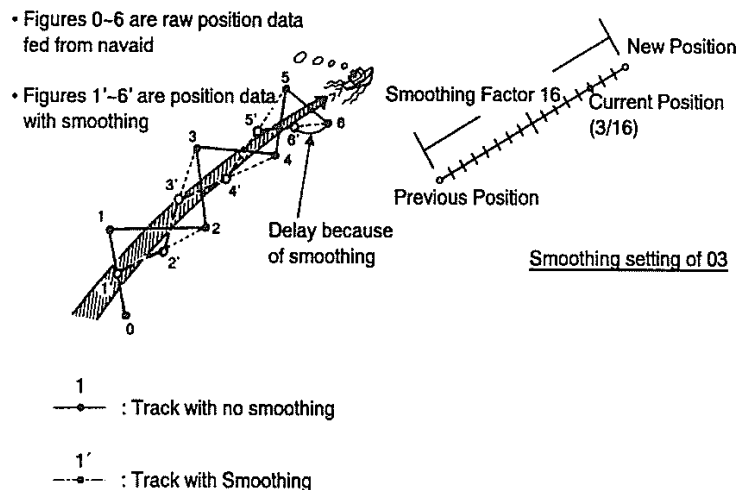

Figure 4-12 Comparing track with smoothing and no smoothing

For instance, number 3 provides a weighting factor of 13/16 for new data and 3/16 for previous data. The higher the smoothing, the slower the position update becomes. In the following figure, the track shown by the broken line has a time delay more than the one shown by the dot-dash line, because of higher smoothing.

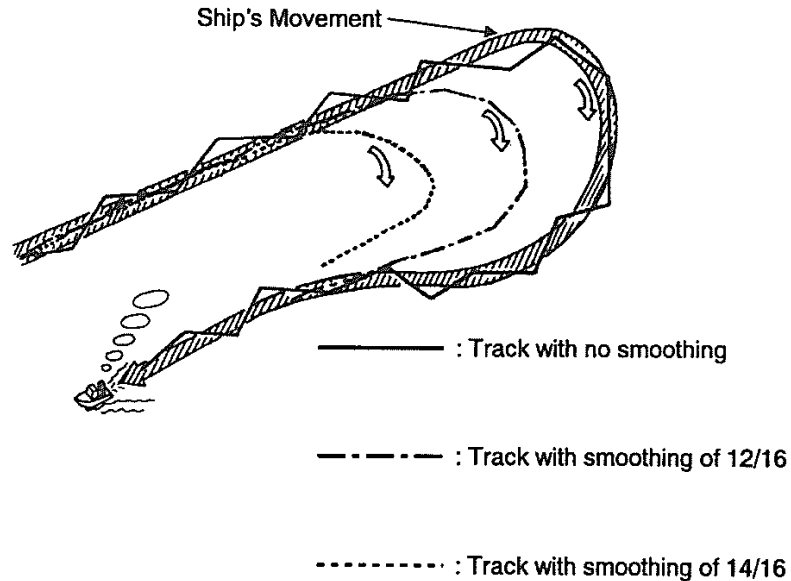

Figure 4-13 Comparing track and different smoothing factors

Spd Average Time

Calculation of ETA and TTG, etc. is based on an average ship's speed over a given period. If the period is too long and the ship's speed is changed suddenly, calculation error will result. The default setting is "01." Increase the setting if time calculations are in error.

Bearing Ref.

You may display bearing data in true bearing (relative to True North) or magnetic bearing (relative to magnetic North).

Mag. Variation

The location of the magnetic pole is different from the geographical North pole. This causes a difference between the true and magnetic North direction. The difference is called magnetic variation, and varies by the observation point on the earth.

This unit is programmed with the earth's magnetic variations. However, you may wish to further refine variation for a particular area. If you enter compensation manually, be sure to change it when magnetic variation changes.

Output Data Format

Select the format of data output to external equipment.

External Device

Select external device connected to the GP-1800F.

Time Difference

The GPS uses UTC time. If you would rather use local time, enter the difference in hours between local time and UTC. Use the [+] and [-] keys for times later or earlier than UTC.

GPS Posn Smooth

When the DOP or receiving condition is unfavorable, the GPS fix may change greatly, even if the vessel is dead in water. This change can be reduced by smoothing the raw GPS fixes. A setting between 0 and 9 is available. The higher the setting the more smoothed the raw data. Note however that too high a setting slows response time to change in latitude and longitude. This is especially noticeable at high ship's speeds. "0" is the normal setting; increase the setting if the GPS fix changes greatly.

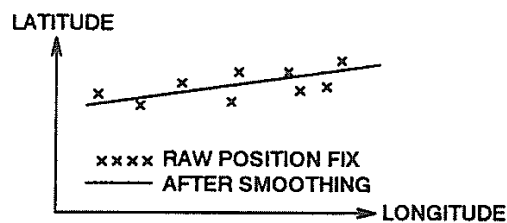

Figure 4-14 GPS position smoothing

GPS Speed Smooth

During position fixing, ship's velocity (speed and course) is directly measured by receiving GPS satellite signals. The raw velocity data may change randomly depending on receiving conditions and other factors. You can reduce this random variation by increasing the smoothing. Like with latitude and longitude smoothing, the higher the speed and course smoothing the more smoothed the raw data. If the setting is too high, however, the response to speed and course change slows. For no smoothing, enter "0." "5" is suitable for most conditions.

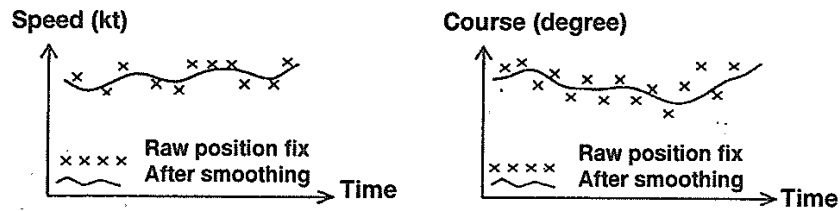

Figure 4-15 GPS speed smoothing

Antenna Height

Enter antenna height above the waterline, for accurate determination of GPS position.

DOP Threshold

This is the index for position-fixing accuracy. When the HDOP threshold is lower than the preset HDOP, position reliability worsens. The default setting is 20, which is suitable for most all conditions.

Fix Mode

Select position-fixing mode. 2D, marine vessels; 3D, land mobile vehicles.

Geodetic Datum

Select the geodetic chart system you are using. WGS-84 (standard GPS chart system), WGS-72 or Tokyo can be directly selected. For other charts, select "Other" and enter chart number referring to "Geodetic Chart List" in the Appendix.

Position Offset

You may apply an offset to position generated by the internal GPS receiver, to further refine position accuracy.

Disabled Satellite

Every GPS satellite is broadcasting abnormal satellite number(s) in the Almanac. Using this information, the GPS receiver eliminates any malfunctioning satellite from the GPS satellite schedule. Once the malfunctioning satellite is returned to on-line status it is automatically restored to the satellite schedule when the Almanac is received. In some instances however the Almanac may not contain information which announces that a satellite is now back on line. If you hear of this through another source, you can manually restore the satellite to the satellite schedule. This is called "enable." Conversely, you can manually "disable" a healthy satellite if you hear it is "unhealthy."

DGPS Mode

Select to ON if the GP-1800F is connected to a Differential GPS Receiver.

RTCM Version, Byte Format, First Bit, Parity Bit, Bit Rate, Baud Rate

These are for use by service technicians. Do not change the settings.

Clear Memory

There are times you may wish to clear the Plotter memory or GPS memory (or both) to start afresh. The Plotter memory stores marks, lines, waypoints, routes and settings of the DISPLAY SETUP and SYSTEM SETUP menus. If you wish to restart operation with the items stored in the Plotter memory and your settings on the menus mentioned above, save them to a memory card before clearing the Plotter memory.

- 1) Press the [Arrow] keys to select PLT, GPS, or All.
- 2) Press the [ENT] key.
- 3) Press the [ENT] key again to clear selected memory.

PART 5

Maintenance & Troubleshooting

5.1 Maintenance

Overview

No machine can perform to the utmost of its ability unless properly maintained. This section provides maintenance and troubleshooting procedures for keeping your unit in good working order.

Maintenance Program

Regular maintenance is essential for good performance. A maintenance program should be established and should at least include the items listed in Table 5-1.

Table 5-1 Recommended maintenance program

Item	Check Point	Remedy
Antenna	Check for loosened and corroded bolts.	Tighten loosened bolts. Replace heavily corroded bolts.
Antenna cable	Check connection point for watertightness.	Replace damaged parts.
	Check connector for tightness and corrosion.	
	Check cables for damage.	
Display unit connectors	Check for tight connection.	Tighten loosened connectors.
Ground terminal	Check for tight connection and corrosion.	Clean or replace as necessary.
Display unit	Dust and foreign material on the display unit and screen.	Dust on the display dims the picture. Dust may be removed with a soft cloth. If necessary anti-static cleaner may be used. Never use chemical solvents to clean the display; they can remove paint and markings.
Transducer	Check for marine life on transducer face, each time the boat is docked.	Carefully remove any marine life with a piece of wood or sandpaper.

Replacement of Fuse

The fuse on the power cable protects the system from reverse polarity of the ship's mains and equipment fault. If the fuse blows, find the cause before replacing the fuse. Be sure to use a 5A fuse. Using the wrong fuse will damage the unit and void the warranty.

Replacement of Memory Card Battery

The life of a memory card battery is about three years. The first time you use a memory card record the date on the card. When battery voltage is low, the "battery" icon (🔋) appears on the display. Replace battery at earliest convenience, to be sure data stored on the card will not be lost. *The battery must be replaced within 10 minutes after its removal to prevent erasure of data.*

- 1) Using a jeweler's phillips head screwdriver, unfasten the screw at the base of the card. Remove the battery.
- 2) Insert a new battery plus side facing up. Refasten cover. Record date of replacement on card.

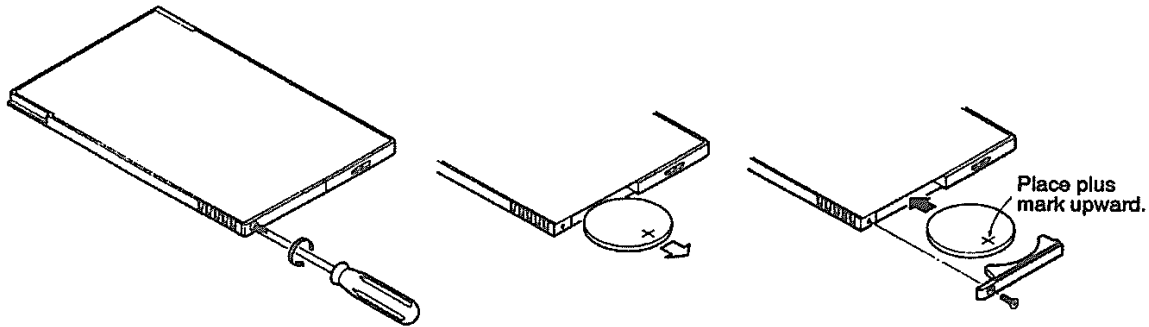

Figure 5-1 Replacement of memory card battery

5.2 Self-Tests

Overview

This unit contains various self-tests which check the display unit and antenna unit for proper operation. Self-tests may be selected on the SELF-TEST menu, which you can display by pressing [MENU] and [8].

Memory, I/O Port Test

This test conducts a general check of the display unit and the antenna unit. Press the [2] key at the SELF-TEST menu to start the test. The unit displays the check results for each device or component as either "OK" or "NG" (No Good). The following figure shows sample memory, I/O port test results.

Note that nothing appears for SIO AUX.

Memory, I/O Port Test	
ROM	OK
SRAM	OK
VRAM	OK
Memory Card	OK
Internal Battery	OK
Card Battery	OK
SIO(GPS)	OK
SIO(AUX)	
MENU: Escape	

Figure 5-2 Sample memory, I/O port test results

Keyboard Test

This test checks the keys of the display unit for proper operation.

- 1) Press the [3] key at the SELF-TEST menu to start the test.

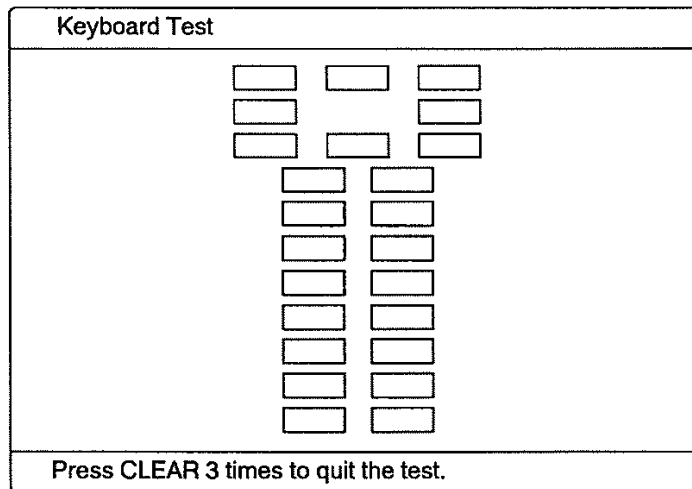

Figure 5-3 Keyboard test

- 2) Press a key. The key's location on the display "lights" in dark tone if the key is functioning normally.
- 3) To escape, press the [CLEAR] key three times.

Test Pattern

The test patterns check whether the display circuit is working properly or not. Press the [4] key at the SELF-TEST menu to start the test. Press the [ENT] key to display other test patterns.

Automatic Testing

This test continuously executes the memory, I/O test and keyboard test self-tests. It is mainly for use by service technicians. Press the [5] key at the SELF-TEST menu to start the test. You may escape at anytime by pressing the [MENU] key.

5.3 GPS Monitor Display

Overview

The GPS monitor display provides information on all GPS satellites. To display the GPS monitor display;

- 1) Press the [MENU] key.
- 2) Press the [8] key to select "SELF-TEST."
- 3) Press the [1] key to select "GPS Monitor Display."

GPS Monitor Display			
Fix Mode	2D	Altitude	--- m
DOP	1.3	Unhthy Sat	
Freq. Dev.	- 270Hz	Program No.	
RX Status			
	No.	ELV	AZM LVL
	03	28	034 89
	14	05	000 27
	18	08	321 38
	11	11	196 11
Data RX:		Ref Sta:	
MENU: Escape			

Figure 5-4 Sample GPS monitor display

Description

Table 5-2 Description of GPS monitor display

Indication	Description
Fix Mode	This shows current position-fixing mode; 2D, 3D and D2D, D3D (DGPS mode turned on).
Altitude	Shows present altitude of GPS receiver when position fixing mode is set to 3D.
DOP (Dilution of Precision)	This is the index for position-fixing accuracy. The lower the value the higher the accuracy. If the index exceeds 20, position fixing may not be possible.
Unhthy Sat.	Unhealthy satellite numbers appear here.
Freq. Dev.	If this figure exceeds +3000 Hz, it may take a long time to fix position.
Rx Status	This section shows elevation angle, azimuth and signal levels.
Data Rx	Shows external Nav device normal or abnormal.
Ref Sta	Shows status of DGPS transmitting station.

5.4 GPS Receiver Status Indicator

Overview

The GPS receiver status is shown on the top right-hand corner on the display. In the normal state, three squares filled appears and reliable position fixing is performed. The table below explains about the GPS receiver status indicated by three characters.

Table 5-3 GPS Receiver status indicator

GPS Receiver Status Indicator	Descriptions
ACQ:	indicates that the GPS receiver is acquiring the GPS satellites referring to the Almanac. If it remains unchanged for a long period of time, the GPS satellite signals may be not received.
ALM:	indicates that the GPS receiver is collecting the Almanac of the GPS satellites being broadcast from each satellite. The Almanac contains estimated arrival time of all GPS satellites. If the unit is not operated for a while and the Almanac becomes too old, the GPS receiver cannot pick up the GPS receiver for a long period of time with "ACQ" indicated. In this state, cold start the GPS receiver to collect the latest Almanac using the SYSTEM SETUP menu, Memory Clear.
CST:	indicates the GPS receiver is cold starting to collect the latest Almanac. This is performed on the first power application or after clearing memory contents using the SYSTEM SETUP menu, Memory Clear.
IMP:	Impossible to receive satellite signals. Check the antenna unit is not blocked by any obstacles within line-of-sight.
INT:	Position fixing is interrupted with a loss of necessary satellite signals. Position fixing is resumed when lost satellite signal reappears.

5.5 Troubleshooting Table

Overview

The table which follows provides common operating problems and the means with which to restore normal operation.

Table 5-4 Troubleshooting table

If...	Then...
General	
you cannot turn on the power	check for blown fuse.
	check that the power connector is firmly tightened.
	check for corrosion on power cable connector.
	check for damaged power cable.
	check battery for proper voltage output (10.2 to 30 V).
power is on but nothing appears	press the [TONE BRILL] key and [Arrow] keys to adjust display brilliance and tone.
there is no response when a key is pressed	turn on the power again.
Plotter	
position is not fixed within 10 minutes	check for loosened antenna connector.
	check for frequency deviation of GPS receiver.
	check that three satellites are being received; three filled squares should appear at the top right-hand corner on the display. Check a GPS receiver status indicator. See pages 5-6 and 5-7.
position is wrong	check that the correct geodetic chart system is selected (on the SYSTEM SETUP menu).
	enter chart correction value (on the SYSTEM SETUP
	check that correct antenna height is entered.
position fixing availability is shorter in comparison with other ship	lower DOP value. The normal setting is 20.
track is not plotted	plotting is stopped. "H" appears on the display in this case.
bearing is wrong	check that correct magnetic compensation is entered.
Loran LOPs do not appear	check that proper Loran chain codes are entered, on the SYSTEM SETUP menu.
Loran LOPs are wrong	enter correction value.
ship's speed display is not zero after ship is stopped	try to decrease ship speed smoothing setting.

If...	Then...
Video Sounder	
no picture but marks and characters appear	check if picture advance speed is set to "0."
	check for loosened transducer connector.
picture appears but no zero line	range is shifted; set shifting to zero to correct.
picture sensitivity is too low	check gain setting, if using manual operation.
	marine life or air bubbles may be clinging to transducer face.
	water may be dirty.
	bottom may be too soft to return a suitable echo.
depth is not displayed	adjust gain to display bottom echo in dark tone.
noise or interference obstructs the display	check if transducer cable is not near ship's engine. If it is, relocate it.
	check ground.
	other video sounders may be operating nearby and on same frequency.
water temperature graph appears but no or wrong readout	check for loosened sensor cable.

Appendix

Specifications
Geodetic Chart List

Specifications

Display Unit	
Type	8-inch monochrom LCD, 640 x 480 dot
Tone	Three levels
Video Sounder	
Frequency	50 kHz or 200 kHz (Specify when ordering)
Display range	5, 10, 20, 40, 80, 150, 300, 500 m (feet, fathoms, and passi/braza also available)
Shift	0 to 500 m
GPS Receiver	
Receiver format	8 channels all in view
Tracking system	Parallel
Accuracy	Horizontal: 15 m RMS (2D, HDOP \leq 3 SA OFF) Velocity: 0.1 kt RMS (2D, HDOP \leq 3 SA OFF) GPS accuracy controlled by U.S. Department of Defense.
Plotter Section	
Chart projection	Mercator (85° latitude or below)
Display range	0.14 to 6144 nm (above equator)
Chart display	Land filled in
Memory capacity	Track + Mark: 4,000 pts.
Waypoint capacity	198 pts. + external waypoint + starting waypoint
Route storage capacity	10 routes, 30 points per route
Alarms	Arrival, anchor watch, border, XTE (cross track error) ship's speed, water temperature, fish, bottom
I/O Data Format	
Input format	NMEA 0183, Ver. 1.5 or 2.0
Output format	NMEA 0180, NMEA 0183, Ver 1.5 or 2.0
General	
Dimensions (mm) and mass	Display unit: 308(W) x 198(H) x 120(D), 2.4 kg Antenna unit: \varnothing 90 x 50(H), 300 g
Power	10.2 to 30 VDC, 20 W
Useable temperature	Display unit: 0°C to 50°C Antenna unit: -30°C to 70°C
Waterproofing	Display unit: IEC529 IPX5 Antenna unit: IEC529 IPX6

Geodetic Chart List

How to Use the List

The GP-1800F can use almost any geodetic chart system. Chart type can be selected on "Geodetic Datum" in the SYSTEM SETUP menu. WGS-84 (standard GPS chart system), WGS-72 or Tokyo can be selected directly. For other charts, select "OTHER" and enter chart code number referring to the chart list.

001 : WGS84		086 : NAMIBIA	: Namibia
002 : WGS72		087 : MAPARIMA, BWI	: Trinidad and Tobago
003 : TOKYO	: Mean Value (Japan, Korea, and Okinawa)	088 : NORTH AMERICAN 1927	: Western United States
004 : NORTH AMERICAN 1927	: Mean Value (CONUS)	089 :	: Eastern United States
005 : EUROPEAN 1950	: Mean Value	090 :	: Alaska
006 : AUSTRALIAN GEODETIC 1984	: Australia and Tasmania Island	091 :	: Bahamas (Excluding San Salvador Island)
007 : ADINDAN	: Mean Value (Ethiopia and Sudan)	092 :	: Bahamas - San Salvador Island
008 :	: Ethiopia	093 :	: Canada (Including Newfoundland Island)
009 :	: Mali	094 :	: Alberta and British Columbia
010 :	: Senegal	095 :	: East Canada
011 :	: Sudan	096 :	: Manitoba and Ontario
012 : AFG	: Somalia	097 :	: Northwest Territories and Saskatchewan
013 : AIN EL ABD 1970	: Bahrain Island	098 :	: Yukon
014 : ANNA 1 ASTRO 1965	: Cocos Island	099 :	: Canal Zone
015 : ARC 1950	: Mean Value	100 :	: Caribbean
016 :	: Botswana	101 :	: Central America
017 :	: Lesotho	102 :	: Cuba
018 :	: Malawi	103 :	: Greenland
019 :	: Swaziland	104 :	: Mexico
020 :	: Zaire	105 : NORTH AMERICAN 1983	: Alaska
021 :	: Zambia	106 :	: Canada
022 :	: Zimbabwe	107 :	: CONUS
023 : ARC 1960	: Mean Value (Kenya, Tanzania)	108 :	: Mexico, Central America
024 :	: Kenya	109 : OBSERVATORIO 1966	: Corvo and Flores Islands (Azores)
025 :	: Tanzania	110 : OLD EGYPTIAN 1930	: Egypt
026 : ASCENSION ISLAND 1958	: Ascension Island	111 : OLD HAWAIIAN	: Mean Value
027 : ASTRO BEACON "E"	: Iwo Jima Island	112 :	: Hawaii
028 : ASTRO B4 SOR, ATOLL	: Tern Island	113 :	: Kauai
029 : ASTRO POS 71/4	: St. Helena Island	114 :	: Maui
030 : ASTRONOMIC STATION 1952	: Marcus Island	115 :	: Oahu
031 : AUSTRALIAN GEODETIC 1966	: Australia and Tasmania Island	116 : OMAN	: Oman
032 : BELLEVUE (IGN)	: Etate and Erromango Islands	117 : ORDNANCE SURVEY OF GREAT BRITAIN 1936	: Mean Value
033 : BERMUDA 1957	: Bermuda Islands	118 :	: England
034 : BOGOTA OBSERVATORY	: Colombia	119 :	: England, Isle of Man, and Wales
035 : CAMPO INCHAUSPE	: Argentina	120 :	: Scotland and Shetland Islands
036 : CANTON ISLAND 1966	: Phoenix Islands	121 :	: Wales
037 : CAPE	: South Africa	122 : PICO DE LAS NIVIES	: Canary Islands
038 : CAPE CANAVERAL	: Mean Value (Florida and Bahama Islands)	123 : PITCAIRN ASTRO 1967	: Pitcairn Island
039 : CARTHAGE	: Tunisia	124 : PROVISIONAL SOUTH CHILEAN 1963	: South Chile (near 53° S)
040 : CHATHAM 1971	: Chatham Island (New Zealand)	125 : PROVISIONAL SOUTH AMERICAN 1956	: Mean Value
041 : CHUA ASTRO	: Paraguay	126 :	: Bolivia
042 : CORREGO ALEGRE	: Brazil	127 :	: Chile - Northern Chile (near 19° S)
043 : JAKARTA (BATAVIA)	: Sumatra Island (Indonesia)	128 :	: Chile - Southern Chile (near 43° S)
044 : DOS 1968	: Gizo Island (New Georgia Islands)	129 :	: Colombia
045 : EASTER ISLANDS 1967	: Easter Island	130 :	: Ecuador
046 : EUROPEAN 1950 (Cont'd)	: Western Europe	131 :	: Guyana
047 :	: Cyprus	132 :	: Peru
048 :	: Egypt	133 :	: Venezuela
049 :	: England, Scotland, Channel, and Shetland Islands	134 : PUERTO RICO	: Puerto Rico and Virgin Islands
050 :	: England, Ireland, Scotland, and Shetland Islands	135 : QATAR NATIONAL	: Qatar
051 :	: Greece	136 : OORNOO	: South Greenland
052 :	: Iran	137 : ROME 1940	: Sardinia Islands
053 :	: Italy - Sardinia	138 : SANTA BRAZ	: Sao Maguei, Santa Maria Islands (Azores)
054 :	: Italy - Sicily	139 : SANTO (DOS)	: Espiritu Santo Island
055 :	: Norway and Finland	140 : SAPPER HILL 1943	: East Falkland Island
056 :	: Portugal and Spain	141 : SOUTH AMERICAN 1969	: Mean Value
057 : EUROPEAN 1979	: Mean Value	142 :	: Argentina
058 : GANDAJIKA BASE	: Republic of Maldives	143 :	: Bolivia
059 : GEODETIC DATUM 1949	: New Zealand	144 :	: Brazil
060 : GUAM 1963	: Guam Island	145 :	: Chile
061 : GUX 1 ASTRO	: Guadalcanal Island	146 :	: Colombia
062 : HJORSSEY 1955	: Iceland	147 :	: Ecuador
063 : HONG KONG 1963	: Hong Kong	148 :	: Guyana
064 : INDIAN	: Thailand and Vietnam	149 :	: Paraguay
065 :	: Bangladesh, India, and Nepal	150 :	: Peru
066 : IRELAND 1965	: Ireland	151 :	: Trinidad and Tobago
067 : ISTS 073 ASTRO 1969	: Diego Garcia	152 :	: Venezuela
068 : JHONSTON ISLAND 1961	: Jhonston Island	153 : SOUTH ASIA	: Singapore
069 : KANDAWALA	: Sri Lanka	154 : SOUTHEAST BASE	: Porto Santo and Madelra Islands
070 : KERQUELEN ISLAND	: Kerguelen Island	155 : SOUTHWEST BASE	: Faial, Graciosa, Pico, Sao Jorge, and Terceira Islands
071 : KERTAUI 1948	: West Malaysia and Singapore	156 : TIMBALAI 1948	: Brunei and East Malaysia (Sarawak and Sadah)
072 : LA REUNION	: Mascarene Island	157 : TOKYO	: Japan
073 : L.C. 5 ASTRO	: Cayman Brac Island	158 :	: Korea
074 : LIBERIA 1964	: Liberia	159 :	: Okinawa
075 : LUZON	: Philippines (Excluding Mindanao Island)	160 : TRISTAN ASTRO 1968	: Tristan da Cunha
076 :	: Mindanao Island	161 : VITI LEVU 1916	: Viti Levu Island (Fiji Islands)
077 : MAHE 1971	: Mahe Island	162 : WAKE-ENIWETOK 1960	: Marshall Islands
078 : MARCO ASTRO	: Salvage Islands	163 : ZANDERIJ	: Suriname
079 : MASSAWA	: Eritrea (Ethiopia)	164 : BUKIT RIMPAH	: Bangka and Belitung Islands (Indonesia)
080 : MERCHICH	: Morocco	165 : CAMP AREA ASTRO	: Camp Mcmurdo Area, Antarctica
081 : MIDWAY ASTRO 1961	: Midway Island	166 : G. SEGARA	: Kalimantan Islands (Indonesia)
082 : MINNA	: Nigeria	167 : HERAT NORTH	: Afghanistan
083 : NAHRWAN	: Masirah Island(Oman)	168 : HU-TZU-SHAN	: Taiwan
084 :	: United Arab Emirates	169 : TANANARIVE OBSERVATORY 1925	: Madagascar
085 :	: Saudi Arabia	170 : YACARE	: Uruguay

A

Alarms 3-13 - 3-14, 4-2 - 4-4. *See also*

individual alarms

- anchor watch alarm 4-2
- arrival alarm 4-2
- border alarm 4-3
- bottom alarm 3-13
- cross track error (XTE) alarm 4-2
- fish alarm 3-13
- ship's speed alarm 4-3
- silencing aural alarm 3-14, 4-4
- water temperature alarm 4-3

Alarm message window 3-14

Analog data display 1-8

Antenna height 4-19

Aural alarm 3-14, 4-4

Autopilot connection 1-8

B

Bearing reference 4-17

Border (proximity) alarm 4-3

Bottom alarm 3-13

Bottom zoom display 1-6, 3-4

Bottom-lock display 1-7, 3-4, 3-17

Bright echo 3-10

C

Centering location/ship's position 2-7

Chart position correction 4-5

Clearing the memory 4-20

Clutter removal 3-9

Coastline data card 1-10, 2-5

Comments for waypoints 2-10

Contours data 4-14

Course bar 4-13

Course-up orientation 2-3

Cross track error (XTE) alarm 4-2

Cursor 2-4, 4-13

D

Data display 2-3

Depth 3-12

Depth contours 4-13

Destination waypoint

setting

by past event position 2-26

by the cursor 1-12, 2-13

by waypoint number 2-14

cancelling 2-15

DGPS mode 4-20

Disabled satellite 4-19

Display orientation 2-3

Display range 2-6, 3-7

DISPLAY SEL key 1-11

DISPLAY SETUP menu 4-12

DOP threshold 4-19

E

Echo level offset 3-17

Erase signal 3-10

Event mark

entering 2-25

erasing 2-25

shape 2-26

EVENT/MOB key 2-27

Event position

entering 2-25

setting as destination 2-26

viewing past 2-25

Expansion (zoom) displays 3-3

Expansion markers 3-16

Expansion range 3-16

External device 4-18

F

Fish alarm 3-13, 3-17

Fix mode 4-19

Fuse replacement 5-3

G

Gain 3-7

Geodetic datum 4-19

GOTO key 1-12

GPS monitor display 5-6

GPS position correction 4-5

GPS position/speed smoothing 4-18

Grid 4-13

I

Interference removal 3-10

K

Keyboard test 5-4

L

Land pattern 4-12

Loran LOPs

displaying 4-7

entering correction 4-8

Low level noise 3-9

M

Magnetic bearing variation 4-17

Marker zoom display 1-6, 3-4

Marks

changing shape and tone 2-23

- changing size 2-22
- connecting with lines 2-24
- entering 2-22
- erasing all 2-31
- erasing in specific area 2-31
- erasing individual 2-23
- Memory apportion 4-15
- Memory card 4-11
 - battery replacement 5-3
- Memory, I/O port test 5-4
- MOB (Man OverBoard) 2-27, 4-13

N

- Navaid 4-15
- Navigation data display 1-8
- Noise limiter 3-10
- Normal display 3-3
- North-up orientation 1-4, 2-3
- NU/CU key 1-11, 2-3

O

- Off-course to waypoint alarm 4-2
- Output data format 4-18
- Output power 3-16

P

- Picture advance speed 3-10
- Place-name 4-13
- Plotter display 1-4, 1-11, 2-2
- Plotter-related settings 4-15
- Plotter/sounder display 1-7, 2-2
- Position display 4-16
- Position offset 4-19

R

- Recording resolution 4-16
- Route
 - cancelling route navigation 2-21
 - changing L/L position 2-19
 - deleting route waypoints 2-19
 - following a route 2-20
 - registering
 - by the cursor 2-16
 - through the route list 2-17
 - restoring skipped route waypoints 2-19
 - skipping route waypoints 2-19

S

- Scale/range 4-15
- Scale keys 1-11
- Scrolling the display 2-7
- Seabed level 3-17
- Self-test 5-4
- Ship's position 1-11
- Ship's speed alarm 4-3
- Smoothing factor 4-16
- SNDR key 3-6

- Speed averaging 4-17
- Surface reflections 3-16

T

- Test pattern 5-5
- Time difference 4-18
- Time mark 4-13
- Time-To-Go (TTG) 2-18
- TONE BRILL key 1-11
- Track
 - erasing 2-31
 - plotting interval 2-29
 - stopping, resuming plotting 2-28

- Tutorial 1-10

- TVG setting 3-16

U

- Units
 - depth 4-15
 - distance 4-15
 - temperature 4-15

V

- Video sounder
 - automatic operation 3-6
 - manual operation 3-7
 - preselecting display 3-4
 - principle of operation 3-2
 - settings 3-16
- Visual alarm 4-4
- VRM (Variable Range Marker) 1-6, 3-4

W

- Water depth offset 3-16
- Water temperature
 - alarm 4-3
 - correction 3-15
 - graph 3-15
- Waypoint
 - arrival alarm 4-2
 - changing data 2-11
 - deleting waypoints
 - by the cursor 2-11
 - through the waypoint list 2-12
 - entry
 - by event position 2-8
 - by own ship's position 2-10
 - by the cursor 2-10
 - through the waypoint list 2-10
 - hiding/showing 2-12
 - waypoint mark size 4-13
- WPT key 1-12

X

- XTE alarm 4-2
- See also* Cross track error alarm

Z

- Zoom marker 3-4



FURUNO ELECTRIC CO., LTD.

No. 9-52, ASHIHARA-CHO,
NISHINOMIYA-CITY, JAPAN

TELEPHONE : 0798-65-2111
CABLE : FURUNO NISHINOMIYA
TELEX : 5644-325/326 FURUNO J
TELEFAX : 0798-65-4200 (G III)

YOUR LOCAL AGENT/DEALER

Free Manuals Download Website

<http://myh66.com>

<http://usermanuals.us>

<http://www.somanuals.com>

<http://www.4manuals.cc>

<http://www.manual-lib.com>

<http://www.404manual.com>

<http://www.luxmanual.com>

<http://aubethermostatmanual.com>

Golf course search by state

<http://golfingnear.com>

Email search by domain

<http://emailbydomain.com>

Auto manuals search

<http://auto.somanuals.com>

TV manuals search

<http://tv.somanuals.com>