

FURUNO

OPERATOR'S MANUAL

**Electronic Chart Display and
Information System (ECDIS)**

MODEL FEA-2100/2105

(VER. 04.02)



FURUNO ELECTRIC CO., LTD.
NISHINOMIYA, JAPAN

PRINTED IN JAPAN

© **FURUNO ELECTRIC CO., LTD.**

9-52 Ashihara-cho,
Nishinomiya 662-8580, JAPAN

Telephone : 0798-65-2111

Fax : 0798-65-4200

Your Local Agent/Dealer

All rights reserved.

Printed in Japan

Pub. No. OME-41200

FEA-2100/2105 V402

FIRST EDITION : SEP. 1999

H1 : SEP. 28, 2004



* 0 0 0 8 0 9 7 2 0 0 *



* O M E 4 1 2 0 0 H 1 0 *

Operators Manual

ECDIS EC1000

with Conning Display

By Furuno Finland Oy



801013

APPLICATION FOR MANUAL REVISIONS

Upon receipt of this manual, please fill in the necessary data. It is important that the addressee be the end user so that the operating personnel will receive all revisions to the manual.

EQUIPMENT NAME

SERIAL No**MODEL**

MANUAL TITLE

..... **MANUAL PART NUMBER**

ISSUE INDEX **REVISION INDEX**

PURCHASING AGENCY

NAME OF USER

ADDRESS OF USER

.....

.....

ATTN:.....

CHANGE RECORD

RCS CODE/REV. INDEX	DATE	PURPOSE OF THE CHANGE	CHANGE REQUESTED BY
1.1	07.09.1999	New release of Operators Manual for software release B1.18	
1.11	3.11.1999	New release of Operators Manual for software release B1.19	
2.0	24.01.2000	New release of Operators Manual for software release 02.00	
2.01	26.04.2000	New release of Operators Manual for software release 02.01	
2.02	08.12.2000	New release of Operators Manual for software release 02.02	
3.00	25.03.2002	New release of Operators Manual for software release 03.00	
3.02	10.10.2002	New release of Operators Manual for software release 03.01	
3.03	04.03.2003	New release of Operators Manual for software release 03.02	
3.04	01.04.2003	New release of Operators Manual for software release 03.03	
3.1	15.05.2003	New release of Operators Manual for software release 04.00	
3.2	19.08.2003	New release of Operators Manual for software release 04.01	
3.3	14.05.2004	New release of Operators Manual for software release 04.02	

Contents

Changes since release 04.01	1
Overall operation related changes.....	1
Chart related changes.....	2
Conning Display related changes.....	2
Sensor related changes.....	2
Display alternatives	2
Changes since release 04.00	3
Overall operation related changes.....	3
Chart related changes.....	3
Changes since release 03.02	4
Overall operation changes	4
Changes since release 03.01	5
Overall operation related changes.....	5
Chart related changes.....	6
Changes since release 03.00	7
Overall operation related changes.....	7
Changes since release 02.02	8
Overall operation related changes.....	8
Display alternatives	9
Route Planning and Monitoring related changes	9
User Chart related changes	10
Pilot data related changes	10
Ref. target related changes.....	10
Chart related changes.....	11
Changes since release 02.01	13
Overall operation related changes.....	13
Chart related changes.....	14
Changes since release 02.00	15
Overall operation changes	15
Chart related changes.....	15
Introduction	17
Manual Applicability	17
How to read this manual	18
System Configuration	19
Configuration for One Workstation.....	19

Configuration for Multi Workstations.....	20
Navigation Tasks	21
Overview	21
Voyage planning.....	22
Route Planning.....	22
Route Calculation.....	22
Chart planning.....	23
User Chart planning	23
Positioning.....	24
Direct Positioning sensors	24
Dead Reckoning equipment	24
Reference Targets.....	24
Manual Correction	24
Monitoring.....	25
Display of electronic sea chart	25
Alarms.....	25
Man Over Board.....	25
Data Logging.....	25
Data Distribution	25
ECDIS Screen	27
Overview	27
Electronic chart area	28
Electronic charts in ECDIS	28
Upper statusbar	30
List of Indications on Upper Status bar	30
Lower Status bar.....	32
Dialogbox area	32
Information Area	33
Control Panel	35
Overview	35
Operative push buttons.....	36
Direct function push buttons.....	36
Menu push buttons.....	38
INFO & HELP pushbutton	47
Standby mode	49
Switch ON and OFF	49
Set up before departure	51
Update Chart material.....	51
Display and Approve date for S57 charts and manual updates.....	51
Create or update User chart	51
Create or update Reference targets	51
Create or update Pilot data	52
Set Chart Alarm calculation.....	52
Set Depth alarm limit for Echo Sounder.....	52
Create or update Route	53
Check your route against Chart Alarms.....	53
Recalculate timetable and ETA values	54
Check and prepare Route to be monitored.....	55
Select To Waypoint.....	55
Select Final Waypoint	55
Center line for ARPA radar.....	55

Channel borders for ARPA radar	55
Use Checked conditions of the Route Plan.....	56
Use planned User Chart.....	56
Use planned Pilot Data	57
Verify configuration of navigation sensors.....	58
Verify source of navigation sensors.....	58
Verify SPEED settings	58
Verify RADAR settings.....	58
Verify GYRO settings	58
Verify POSITION sensors.....	59
Verify KALMAN FILTER.....	59
Verify ALIGNMENT	59
Reset Distance and Trip Counters	60
Verify Datum.....	60

Conditions required to replace paper charts 61

Introduction	61
How to detect ENC coverage in S57 Chart display	64

Vector Chart material 67

Introduction	67
S57 Charts	67
Introduction	67
Chart legend of S57 chart	69
Permanent warnings of S57 charts.....	70
How to load S57 charts.....	71
Flow chart of the loading of S57 Charts into ECDIS	71
How to load S57 charts from a CD-ROM, floppy or LAN.....	73
How to load S57 charts, which are not fully compliant with the standards	79
S57 SENC Conversion details	80
How to make SENC conversion faster	80
How to select automatic SENC conversion and Display Until date	80
How to view progress of SENC conversion	81
How to use Failed SENC conversion window.....	82
How to use SENC Conversion history log	83
How to use SENC convert window to initiate SENC conversion.....	85
Some features of Chart Plan menu.....	86
Overview of Chart Plan menu	86
Catalogue of S57 cells.....	88
Group of S57 Chart cells	89
How to view status and date dependency of S57 Chart cells and their updates..	93
How to later use CD Catalogue created during load of S57 charts.....	94
How to remove S57 Charts from the system	95
Introduction to the S57 chart service from a RENC	96
Introduction	96
Permits.....	96
Product List	96
Authentication	96
Available service types.....	97
Subscription types	97
Service provided by a RENC.....	98
How to view the Coverage of the RENC service.....	98
How to know up-to-date status of a chart from a RENC	99
How to know up-to-date status of the RENC Product List.....	100
How to manage Permits from a RENC.....	101
How to manage Public key from a RENC.....	102
CD-ROM service from a RENC	103
How to get started with S57 charts using a RENC	103

How to keep S57 charts up to date using a RENC	104
How to enlarge chart coverage using a RENC	105
A BASE CD-ROM from a RENC	106
An UPDATE CD-ROM from a RENC	108
How to view Coverage of a BASE or UPDATE CD-ROM from a RENC	110
A Permit CD-ROM or floppy disk from the RENC	111
RENC security system.....	113
Standard messages in S57 Chart Load	113
Additional messages in S57 Chart Load.....	113
Standard messages in S57 SENC conversion.....	115
Additional messages in S57 SENC conversion	115
Vector chart display.....	116
How to select Vector chart material in use.....	116
How to select charts for viewing.....	116
How to select a chart by its name on display.....	117
Control of visible chart features	118
Display Base.....	121
Control of visible navigation features	121
Store and recall of Chart Display Settings for visible chart and navigational features	124
Sailing directions, Tidal tables etc. features of Vector charts.....	125
Date dependent and periodical features of Vector chart	126
Introduction.....	126
How to approve and highlight Vector chart updates	126
How to set Display Until date	127
How to set Approve Until date.....	127
A little learning about date dependency of S57 standard	128
Symbology used in Vector charts	133
How to change presentation library used for Vector chart features.....	133
Request information about Vector chart objects.....	134
How to set visible Vector chart features.....	134
How to select desired object from the list of found objects.....	134
How to view properties of a Vector chart object.....	135
A little learning about Vector Chart coding	136
Seldom used features of Vector charts	142
Cell Status	142
S57 Cell Details.....	142
How to use Cell Status window to initiate SENC conversion	143

Raster Chart material 145

ARCS Charts	145
Chart legend of ARCS chart.....	145
T&P Notices, Details and Warnings of ARCS	146
Datum and ARCS Charts.....	149
Difference between ARCS chart local datum and positions in WGS84 datum	149
Permanent warnings of ARCS.....	154
ARCS chart managing.....	155
Chart plan.....	155
Subscription of ARCS	156
ARCS Navigator	156
ARCS skipper.....	156
ARCS licence information	156
How to get started with ARCS charts.....	157
How to load chart permits for ARCS Navigator license.....	158
How to load chart permits for ARCS Skipper license	159
How to remove chart permits	160
How to load a new ARCS chart into the system.....	161
How to update ARCS chart	164
How to view chart load and update history of ARCS.....	166

How to view update status of your ARCS charts.....	167
ARCS Catalogue	168
Group of ARCS charts.....	170
How to remove ARCS chart from the system.....	174
ARCS chart display	175
How to select ARCS chart material on display.....	175
How to select used Datum	175
How to view different charts	177
How to select an ARCS chart by its number on display	179
Control of visible chart features	180
Control of visible navigation features.....	184
Store and recall of Chart Display Settings for visible chart and navigational features.....	187

Manual Updates 189

Introduction	189
Which symbols to use with Manual Updates	190
Display of Manual Updates	190
How to control visibility of Orange symbols from Manual Updates.....	190
How to control visibility of True symbols from Manual Updates	190
Control of date dependency of Manual updates.....	191
How to set current date for viewing.....	191
Use of Manual Update editor with Orange symbols.....	192
Manual Update Planning	192
How to insert a new Orange symbols.....	193
How to delete existing Orange symbol.....	195
How to edit position of an Orange symbols.....	196
Use of Manual Update editor with True symbols	199
Manual Update Planning	199
How to delete existing chart object	200
How to modify existing chart object.....	201
How to insert a new chart object	202
How to edit properties of a manual update chart object	208
Seldom used features of Manual updates.....	211
How to check in details the creation and usage history of manual updates	211

Chart Alarms 213

General	213
Chart alarms.....	214
How to select safety contour	214
How to select objects used in Chart Alarms	215
How to highlight Chart Alarm.....	217
How to include User Chart Symbols, Lines and Areas in Chart Alarm	217
How to activate own ship check	219
Route planning.....	221
How to find Chart Alarms leg by leg.....	222
How to find Chart Alarms by their category.....	223
Route monitoring.....	224
Chart Alarm using ARCS charts.....	225

Navigation tools 227

Display mode and Orientation of Chart	227
How to select desired Display Mode and orientation of Chart	228
Navigation marks.....	229
How to move EBL.....	230
How to move VRM	230
How to move Reference point.....	230

Route planning	233
Introduction	233
Route planning main menu	234
Select datum	235
How to create a new route	236
Introduction of Waypoint sheet	237
Introduction of Alarms sheet	238
Introduction of Check sheet	239
Introduction of Parameter sheet	240
Introduction of Prepare sheet	241
How to modify already existing route	242
Parameters	242
How to select waypoint to be modified	242
Change waypoint position	243
Change other waypoint data	244
Add a new waypoint in the end of a route	245
Insert a waypoint	245
Delete a waypoint	245
Import waypoint from other routes	246
Reverse sailing order of a route	246
Geometry check of route	246
Optimization	247
Available Optimization strategies	247
How to optimize	247
How to plan a speed profile	248
Backup to floppy	249
Restore from floppy	249
Move to planning or navigation station	249
Read from planning or navigation station	249
WP table report	249
How to change font of report	250
Full WP report	250
Passage Plan report	251
Route monitoring	253
Introduction	253
How to select route to be monitored	254
How to select To waypoint	255
How to select Final waypoint	255
How to view waypoint information	255
Display of the route on the electronic chart screen	256
Display of the route on the ARPA radar screen	256
Route assistant	257
How to monitor route	259
How to ask ETA	260
Route monitoring related alarms	262
User chart control	263
Introduction	263
Objects of User Chart	263
Modes of User Chart	264
What is a User Chart Point and for which purpose it is used ?	266
Select datum	268
How to select User Chart for Monitor mode	268
How to select User Chart for Plan mode	269
How to create User Chart	270
Introduction of Point sheet	271

Introduction of Symbol sheet	272
Introduction of Line sheet	273
Introduction of Tidal sheet	274
Introduction of Area Sheet	275
Add a new Point, Symbol, Line or Tidal to User chart.....	278
How to select Point, Symbol, Line or Tidal to be modified	278
Change position of Point, Symbol, Line or Tidal	278
Change other data of Point, Symbol, Line or Tidal	279
Delete a Point, Symbol, Line or Tidal	279
Import Points, Symbols, Lines or Tidal from other User chart	280
How to join two or more User Charts together	281
Display on ECDIS screen	282
Backup to floppy	285
Restore from floppy.....	285
Move to planning or navigation station	285
Read from planning or navigation station.....	285
How to load User Chart in the old Vector system format	285
How to save User Chart in the old Vector system format	285
Point report	286
Line report	287
Area Object report	287
Symbols report.....	288
Full report	288
Report for Radar	289

Reference Targets 291

Introduction	291
Modes of Reference Target	292
How to select Reference target for Monitor mode.....	294
How to select Reference Target for Plan mode	295
How to create Reference Target	296
Introduction of Target sheet	297
Add a new Reference target record	298
How to select Reference target to be modified	299
Change Reference target position.....	299
Change other data of Reference target.....	299
Delete a Reference target record	300
Import record of Reference target from other chart.....	300
Associated alarms	301
Backup to floppy	301
Restore from floppy.....	301
Move to planning or navigation station	301
Read from planning or navigation station.....	301
How to load Reference Targets in the old Vector system format	301
How to save Reference Targets in the old Vector system format	301
Reference target report	302

Pilot Data 303

Introduction	303
Modes of Pilot Data.....	304
How to use normally.....	305
How to select Pilot Data for Monitor mode.....	306
Introduction of View sheet	307
Introduction of Current sheet.....	307
How to select Pilot Data for Plan mode.....	308
Introduction of Edit sheet	309
How to create a new Pilot data	310
Add new Pilot Data record	310

How to select Pilot Data record to be modified	311
Change Pilot data record position	311
Change other data of Pilot Data record	311
Delete a Pilot Data record	311
Import Pilot data from other routes	312
Backup to floppy	312
Restore from floppy.....	312
Move to planning or navigation station	312
Read from planning or navigation station.....	312
Pilot Data report	312

Backup Operations 313

Introduction	313
How to find out right file category	314
How to make a copy of file.....	314
How to copy a file to an other name.....	315
Backup to floppy	315
Restore from floppy.....	315
How to delete file	315
Move to planning or navigation station	315
Read from planning or navigation station.....	316
How to load chart and route files in the old Vector system format.....	316
How to save chart and route files in the old Vector system format	316
How to save route as ASCII text file	317
How to restore route from ASCII text file	317
Backup of chart material.....	318
Restore of chart material.....	319

Common Reference System 321

Introduction	321
Control of common reference system.....	322
Shared Alarm management	322
Harmonised databases on Workstations.....	323
Shared User selections	324
Usage rights.....	325
How to set Usage rights as MASTER	325
How to set Usage rights as MULTI or SLAVE.....	325
How to set Usage rights as PLAN.....	326
Sensor source for the System.....	327
Mode of Workstations	328
How to change Mode to Single or Multi workstation.....	328
Troubleshooting.....	329
What to do if pending Access Server window remains on screen	329
Access Server log.....	330
Human Interface log.....	330

Navigation Sensors 331

How to select Navigation sensors.....	331
How to set initial value of a Gyro1.....	332
Source of position.....	336
Primary and Secondary position of own ship	337
Position discrepancy alarm.....	337
Source of SOG, COG, speed, heading, rot, drift and docking speed components	338
Alarm related to SOG, COG, speed, heading, rot, drift and docking speed components	340
Double Gyro interface for DNV NAUT-AW	341
Indication of gyro source.....	341

Associated alarms.....	342
Filter Operation	343
Filter and automatic Route Steering	343
How to use position alignment.....	345
Position alignment by means of the ECDIS.....	345
How to reset position alignment.....	346
Position alignment by means of the ARPA radar	347
Gyro error correction	349
How to enable Gyro error correction.....	350
Use Reference targets for automatic Gyro error correction	352
Wind sensor	353
Depth sensor	354
Sensor related alarms.....	355
ARPA Target functions	357
Display of ARPA radar targets	357
Display of dangerous ARPA radar targets.....	357
Display of lost ARPA radar targets	358
Display of True or Relative speed vectors.....	358
Display of ARPA target data	359
How to view ARPA target tracking data of normal targets	359
How to view ARPA target tracking data of reference targets.....	360
Source of ARPA radar targets	362
Source of ARPA radar targets related alarms.....	362
Display ARPA target past positions.....	363
ARPA Target recording functions	364
Using ARPA targets for chart align.....	364
Using ARPA targets for position calculation.....	364
Using ARPA targets for gyro error correction.....	364
AIS target functions	365
Introduction	365
Display of AIS target.....	366
Display of dangerous AIS targets.....	367
Display of lost AIS targets.....	367
Display of True or Relative speed vectors.....	367
Maximum count and range for displaying AIS targets on ECDIS.....	367
Source of AIS targets related alarm.....	368
Display of AIS target data	368
Display of AIS interface status	370
Radar Echo Overlay	371
Introduction	371
How to activate radar echo overlay on the ECDIS	372
Source of radar echo overlay	372
Display modes of radar echo overlay	373
How to adjust radar echo overlay visual image	374
Radar overlay source	374
Gain.....	374
Sea clutter filter	374
Rain clutter filter	375
Echo trail time and trail presentation mode	375
Interference reject.....	376
Noise display	376
Transparency	376
Echo Stretch	377
Echo Overload situation	377

How to adjust radar echo overlay to match positions of chart features	378
Error sources of radar echo image and chart display miss match	378
Error sources of radar echo image and display of ARPA target miss match	378
How to adjust bearing error	379
How to adjust position error	380
Recording functions	381
Introduction	381
Events and Man Over Board functions	381
Voyage recording	382
Details log	382
Voyage log	383
Danger targets log	386
How to save past track of a selected ARPA or AIS target.....	387
Chart usage log.....	388
How to print Details, Voyage or Danger Targets log	388
How to make backup copy from Details, Voyage or Danger Targets log	390
How to reset Voyage and Danger Targets logs	390
How to make an User chart from the log (Past track).....	391
Alarms log.....	392
Distance and Trip counters	393
How to reset distance counter and trip counter	393
Datum	395
General	395
Paper charts	395
Electronic sea charts	395
Positioning devices and Datum.....	395
ECDIS and Datum.....	396
ECDIS and user selectable local Datum	396
Parameters setup	397
Parameters	397
How to access to installation parameters.....	398
How to select Datum.....	398
Navigation parameters setting	399
Optimization parameters setting.....	402
Colour Calibration	403
Settings of colour calibration.....	403
Colour test for ARCS charts.....	403
Colour Differentiation test for S57 charts	404
Grey Scale test.....	405
Conning Display	407
System Configuration	407
Display Interpretation	408
Rate of Turn information.....	409
Heading information.....	409
Speed information	409
Rudder information	409
Position information	410
Drift and radius information	410
Track Pilot information	410
Route information	411
Weather information	411

Depth information	412
Fuel consumption information.....	412
Thrusters information	412
Propellers information.....	413
Azimuth propulsion.....	413
Speed Pilot Information.....	414
Messages	414
Main engine start air pressure information	414
Modes of Conning Display	415
How to select mode of Conning Display	415
How to select background of Conning Display	415
How to change colour palette of Conning Display.....	415
Alarms	417
Overview	417
Alarms generated by Navigation Calculation	417
Alarms generated by Chart Calculation	417
Description of the alarm priority system.....	418
List of alarms	419
List of Navigation alarms	419
List of Chart alarms.....	429
Definition of Terms	431
List of terms.....	431
Figure 1	434
Figure 2	434
Appendix 1	435
IHO ECDIS chart 1.....	435
Appendix 2	441
Short introduction to interpret display of S57 charts	441
Paper Chart or Simplified Symbols	441
Two colour or Multi colour Depth	441
Plain or Symbolised Boundaries.....	442
Limited or Full Light sectors	442
Shallow, Safety and Deep Contours	442
Shallow pattern.....	443
Sheet Standard: Unknown object or Presentation.....	443
Sheet Standard: Chart data coverage	444
Sheet Standard: Land features	444
Sheet Standard: Water and seabed features	444
Sheet Standard: Traffic routes	445
Sheet Standard: Cautionary areas	445
Sheet Standard: Information areas.....	445
Sheet Standard: Buoys and beacons	446
Sheet Standard: Lights.....	446
Sheet Standard: Fog signals.....	446
Sheet Standard: Radars.....	446
Sheet Standard: Services	447
Sheet Other: Information about chart data.....	447
Sheet Other: Land features	447
Sheet Other: Soundings	448
Sheet Other: Depth contours, current magnetic.....	448
Sheet Other: Seabed and Obstructions	448
Sheet Other: Services and small craft facilities	449
Sheet Other: Special areas	449

Sheet Other: Additional information available	449
Sheet Other: Important text	450
Sheet Other: Other text	450

Appendix 3 **453**

C-MAP Charts	453
Introduction	453
S57 Chart Legend with C-MAP charts	453
S57 chart managing with C-MAP charts	454
Licence system used by the C-MAP	454
How to get started with C-MAP charts	454
How to keep up to date your C-MAP charts	454
How to define subscription of C-MAP charts	454
How to load C-MAP charts from a CD into the system	459
Use of CD Catalogue	463
Catalogue of S57 cells with C-MAP charts	464
Group of S57 cells with C-MAP charts	466
How to make conversion into SENC and set display date automatically with C-MAP charts	469
How to remove C-MAP charts from the system	469
How to view status and history of C-MAP charts by a group	470

Appendix 4 **471**

Route backup & restore in ASCII format	471
An example to move ECDIS Route data into an Excel file	472
An example to move Route data from Excel file into ECDIS	473

Appendix 5 **475**

Declaration of conformity	475
EC type examination (module B) certificate	475
EC quality system (module D) certificate	475

Changes since release 04.01

Overall operation related changes

Following alarms have been made available for recording into the Voyage log:

- 2007, 2008, 2009, 2010, 2013, 2478, 2480, 2488, 2489, 2492, 2493, 2494, 2495, 2496, 2497, 2498, 2498, 2501, 2503, 2504, 2505, 2506, 2507, 2509, 4027, 4028, 4029, 4030, 4031, 4033, 4034, 4036, 4037 and 4055

Following alarms have been removed from recording into the Voyage log:

- 2471 and 3201

Changed behaviour for following alarms

- Alarm "2010 Filter: Pos source change" : Kalman Filter and two GPS. Before change alarm 2010 was activated also if only one DGPS lost differential signal. After change alarm 2010 is activated for above case only if positions of two GPS separates more than 30 meters. The new behaviour remove unnecessary alarms for short periods of lost DGPS, if there are no other consequences than lost differential mode.
- Alarm "2013 SOG COG unreliable"
 - This has been too aggressive in rough sea condition (for ex. 40-50 separate alarms per 4 hours period). After change the alarm condition lasts for 10 minutes, if second alarm occurs within 10 minutes. This will change separate alarms as one long alarm condition.
 - This has been problematic for fast vessels and fast manual manoeuvres. Logic has been changed: Alarm is not generated, if autopilot is not used or it is used in Heading Control mode. Vessels with fast manoeuvres ("Max rate of turn" limit > 150 deg/min) use increased detection level for COG/SOG unreliable condition.

AIS and ARPA targets viewing limitations

- Before change common limit for AIS and ARPA targets displayed on top of chart was 1:1 000 001 both for ARCS and S57 charts. This was a problem for Ocean areas with ARCS charts, because large enough ARCS charts were not available. After the change ARCS has display limit set so that AIS and ARPA targets are displayed on top of the largest scale Ocean charts (original scale 1 : 3 500 000) when they are zoomed to overscale.

AIS target data display

- Repeated messages received from shore station, following rules apply:
 - If direct message from a target is not received then repeated message can be accepted.
 - If direct message from a target is received then repeated message is not accepted.

Activation of Kalman Filter

- New behaviour includes a reset to position before activation of the Kalman Filter. This removes possibility that own ship position jumps a lot after activation of Kalman Filter.

Changed Wind indication

- Before change the system indicated "True Wind" value based on the standard IEC 61162-1. After change the system indicates "True Wind" as commonly understood by mariners. In practise old mode indication NORTH and TRUE are replaced by indications TRUE and RELATIVE.

Following formats for Route Backup & Restore are available:

- Old formats: a) INC, b) ANTS, c) ASCII PROPRIETARY (previously name was ASCII)
- New formats: d) ASCII POSITION, e) ASCII WPNAME POSITION, f) ASCII POSITION WPNAME, g) ASCII FULL. The idea behind the new formats is to enable exchange of route data between ECDIS and common Office software for PC.

Chart related changes

ARCS charts

- ARCS Skipper service level is now available.

S57 charts

- Telecomm service from a RENC has removed (Primar-Stavanger will close this service from 6 of May 2004).

Conning Display related changes

Changed terminology in Track Pilot window:

- Previously used term "AUTOPILOT" is changed to "RADIUS Ctrl" or "HEADING Ctrl" depending on selection on Track Pilot.
- Previously used term "ROUTE" is changed to "Goto WP" or "Goto Track" depending on selection on Track Pilot.

Sensor related changes

Closed contact based interface for Central Alarm Systems has been added. This interface operates through B-adapter. It is possible a) to acknowledge any alarm or B) mute the buzzer without acknowledge

Display alternatives

Display aspect ratio (Width : Height)

- Now displays with aspect ratio (4:3) or (5:4) can be used. Previously only displays with aspect ratio (5:4) could be used. This change was done because many new flat screen models are based on (4:3) aspect ratio.

Changes since release 04.00

Overall operation related changes

AIS target data display

- the system remembers if user has preference to view AIS target details or no details

Chart related changes

Additional Military Layers (AML)

- Support for S57 based AML layers (CLB, ESB, IWC, LBO, MFF, RAL, SBO).
- support is available both over S57 and ARCS charts.

Changes since release 03.02

Overall operation changes

There are no changes since 03.01. Version 03.02 has been withdrawn.

Changes since release 03.01

Overall operation related changes

Presentation of Position (Numerical presentation, where available)

- minute marks added for Latitude and Longitude values.
 - Information of Route Monitoring on ECDIS (available on Upper Information Area)
 - changed terminology for WP information
 - **Plan CTS** changed to **Plan**
 - **Next WP** changed to **To WP**
 - **Next CTS** changed to **Next**
 - **ETA** changed to **Time**
 - changed terminology for indication of "Goto WP" or "Goto Track" steering modes
 - **Plan**
 - **Next**

Information of Route Monitoring on Conning display

- changed terminology for WP information
- **Next WP** changed to **To WP**
- **ETA** changed to **Time**
 - Indication in red text (**corr**) is available for following planned course, if the value is gyro error compensated:
- **Next**

Position sensor related alarms

- Scattered SOG and/or COG from sensors causes a new alarm "**2013 SOG&COG unreliable**"
- If alarm 2013 is active, the system does not use dynamic WP for turns in "Goto WP" steering mode
- Alarm "**2007 Position Discrepancy**" is activated if set limit is exceeded between "Primary" and any "Secondary" position sources or set limit is exceeded between own ship position and any position sensor. If Kalman filter is in "ON" position the sensor who caused alarm 2007 is excluded from position calculation of Kalman filter.

Position sensor related indications

- Together with alarm "**2007 Position Discrepancy**" a textual indication "Discrepancy" is shown for position sensor in **Pos** page of Sensor.
- If position sensor has been excluded from position calculation by Kalman filter, a textual indication "Excluded" is shown for position sensor in **Pos** page of Sensor.

New indication window for pending state and progress of Harmonization of Multi workstations operation mode

- Permanently shown with smaller window when harmonization is in pending state or in progress
- Details of harmonization in progress can be viewed or hidden on display

Route Monitoring

- It is now impossible to select a Planned Route as Monitored Route, if it contains geometry check errors (for example waypoints are too close to each other etc.)
- Waypoint names are displayed together with waypoint number (before only number)
- List of waypoints is also available as narrow window on information area
- changed terminology for WP information
 - **Next WP** changed to **To WP**
 - **Time** changed to **ETA**

Route Planning

- Optional Voyage Optimization System (VOS) has not been available since 01.01.2000.

Alarms in general

- If an alarm is based on a state - for example missing sensor signal - then a silent pending alarm stay after acknowledge of the alarm until the state changes.
- New relay output from B-Adapter for IEC 62065 Track Control standard related alarms. This relay open if any of related alarms is unacknowledged for 30 seconds.

Operation mode of ECDIS

- A new mode for ECDIS has been added, which is called "Standby". Standby mode is intended for staying in a harbour, when you need to switch off audible alarms from the ECDIS.

Chart related changes

ARCS charts

- A history log has been added to record load and update of charts

S57 charts

- SENC conversion speed has been improved in general. Also the SENC converter can perform multiple updates in one sequence without writing the intermediate results into Harddisk. This further speed up SENC conversion for large amount of updates.

Changes since release 03.00

Overall operation related changes

Radar echo overlay

- Radar echo trails on ECDIS has been changed from green to blue colour.

Navigation tools (Tool Set 1 and Tool Set 2):

- In Tool Set 1 presentation of VRM, EBL and Parallel Index are as dashed line type.
- In Tool Set 2 presentation of VRM, EBL and Parallel Index are as dotted dashed line type

Navigation sensors:

- Distance and Trip counters have separate fields both through water and over ground distances.

Presentation of Time and Date in ECDIS:

- In ECDIS local time is indicated with text "LOCAL TIME" (before it was used specific name for local time zone).

Changes since release 02.02

Overall operation related changes

Terminology used in ECDIS is harmonised to comply with IMO resolution MSC 64 for Integrated Bridge System (IBS).

- Terms Speed Made Good (SMG) and Course Made Good (CMG) have been changed to terms Speed Over Ground (SOG) and Course Over Ground (COG).
- Term Course, where it was used to mean the horizontal direction in which the longitudinal axis of a ship actually points or heads at any instant, has been changed to Heading (Hdg):
 - Alarm "**2002 No course available**" has been changed to "**2002 No heading available**"
 - In Spd/Crs page of Sensor **Manual Course** has been changed to **Manual Heading**.

AIS Targets

- It is now possible to display AIS targets top of ECDIS chart presentation.
- New alarms include :
 - alarm "**3500 AIS target overflow**" if Maximum count of AIS targets set to be displayed on ECDIS has been exceeded within defined Maximum range.
 - alarm "**3501 AIS target storage full**" if Maximum count of AIS targets which can be stored for displaying on ECDIS has been exceeded.
 - alarm "**3502 Dangerous AIS target**" if AIS target has met dangerous target limit set by CPA and TCA.
 - alarm "**3503 Lost AIS target**" if no update information received from AIS target within defined reporting interval of vessel type.
 - alarm "**4037 AIS receive error**" if connection to AIS transponder fails.

Common reference system

- It is now possible to configure multiple ECDIS workstation to use common harmonised data bases (i.e. Charts, User Charts, Routes, Pilot Data etc.), common Alarm management, common Sensors and common Navigation features. See more in chapter "Common Reference System".

Navigation sensors:

- Alarm "**2008 Filter. Speed below 4kt**" has been changed to **2008 Filter. Speed below XXkt**" where value of *XX* is set in Installation Parameter of ECDIS.
- Alarm "**2010 Filter: Pos source change**" has now a time out which prevent alarm from short momentary loss of D-signal in DGPS
- If no data from gyro when using Program Track Turn, an alarm "**2493 ProgTurn: Stop-Sensor Fail**"
- If no data from gyro when using route steering (goto WP or goto Track), an alarm "**2497 Route: Stop-Sensor Fail**"
- The system generates an alarm "**4038 Datum mismatch**" (alarm numbers are from 4038..4043 depending of position receiver), if output Datum of a selected Position sensor (status any other than Off) is changed from WGS84 to another Datum. This feature requires that the position receiver is type approved based on IEC 61162-1 Ed2 (July 2000).
- The system generates an alarm "**4044 Datum change**" (alarm numbers are from 4044..4049 depending of position receiver), if output Datum of a selected Position sensor is changed from another Datum to WGS84 and

if the user has used selection **Primary** or **Secondary**. This feature requires that the position receiver is type approved based on IEC 61162-1 Ed2 (July 2000).

Various orientation of chart are available:

- **North Up with True Motion and Relative Motion** (these were available before)
- **Course Up with True Motion and Relative Motion** (new)
- **Route Up with Relative Motion** (new)
- **Head Up with Relative Motion** (new)

Speed vectors

- The time of speed vectors is now permanently indicated.

Predictor

- It is now possible to select the prediction time. Another improvement is that the predictor display shows 5 predicted positions instead of one displayed earlier. Also the time of predictor is permanently indicated.

Past track

- Past track resolution has been increased from 1 minute to 10 seconds

Danger Target Log

- Before only dangerous targets were logged. After all targets are logged if at least one target is dangerous.

Display alternatives

Flat panel

- Before the colour calibration model included only required calibration model for CRT based displays. After a change the software include also colour calibration model for Flat panel. This calibration model require remote control of Flat panel from ECDIS computer unit.

Route Planning and Monitoring related changes

Route Planning

- A new alternative method has been added for entering the waypoints: you can now define also new waypoint by direction and distance.
- Route plan can include links to User Chart and Pilot Data, which user has planned to be used together with a planned route during Route Monitoring. This feature is called Route assistant.
- Check feature of the Route Plan has been changed. It now uses a separate set of Chart Alarm categories and separate value of Safety Contour. This new arrangement allows user to plan routes for different conditions than the current condition for real-time navigation. This feature is called Route assistant.

Route Monitoring

- It is now possible to view list of waypoints for Monitored Route
- Planned Routes can include links to User Chart and Pilot Data, which user has planned to be used together with the planned route during Route Monitoring. The system automatically warn, if you use any other User Chart or Pilot Data than the ones specified during planning. This feature is called Route assistant.
- Route Plans use now separate set of Chart Alarm categories and separate value of Safety Contour. The system automatically warn, if you use other values than the planned ones. This feature is called Route assistant.

User Chart related changes

Introduction of separate Plan and Monitor mode for User Charts

- In version 02.0xx User Chart did not have separate Plan and Monitor modes and a single User chart was in use at any moment
- From version 03.00 User Chart has two separate modes: Plan and Monitor. The system has parallel two different User chart in use
 - Monitored User chart is used for A) sending it to ARPA radars, B) create User Chart danger related alarms
 - Planned User chart is used for editing
 - The system can draw only one User Chart on the ECDIS screen. Upper bar indicates status of Monitored User Chart.
 - Black or white colour and name of User chart indicates that ECDIS screen display Monitored User Chart
 - Red colour and name of User chart indicates that ECDIS screen display Planned User Chart, while the ECDIS has also a User Chart for monitoring
 - Red colour and no name of User chart indicates that ECDIS screen display Planned User Chart while the ECDIS has no User Chart for monitoring
- If you have multiple workstations, the Monitored User Chart is system wide selection. Planned User Chart is always local for a single workstation.

Pilot data related changes

Introduction of separate Plan and Monitor mode for Pilot Data

- In version 02.0xx Pilot Data did not have separate Plan and Monitor modes and a single Pilot Data was in use at any moment
- From version 03.00 Pilot Data has two separate modes: Plan and Monitor. The system has parallel two different Pilot Data in use
- Monitored Pilot Data is used for A) sending it to ARPA radars, B) create Pilot Data related alarms
- Pilot Data chart is used for editing
- The system can draw only one Pilot Data on the ECDIS screen. Upper bar indicates status of Monitored Pilot Data.
- Black or white colour and name of Pilot Data indicates that ECDIS screen display Monitored Pilot Data
- Red colour and name of Pilot Data indicates that ECDIS screen display Planned Pilot Data, while the ECDIS has also a Pilot Data for monitoring
- Red colour and no name of Pilot Data indicates that ECDIS screen display Planned Pilot Data while the ECDIS has no Pilot Data for monitoring
- If you have multiple workstations, the Monitored Pilot Data is system wide selection. Planned Pilot Data is always local for a single workstation.

Ref. target related changes

Introduction of separate Plan and Monitor mode for Ref. Targets

- In version 02.0xx Ref. Targets did not have separate Plan and Monitor modes and a single Ref. Targets was in use at any moment

- From version 03.00 Ref. Targets has two separate modes: Plan and Monitor. The system has parallel two different Ref. Targets in use
 - Monitored Ref. Targets is used for measuring own ship position
 - Planned Ref. Targets is used for editing
 - The system can draw only one Ref. Targets on the ECDIS screen. Upper bar indicates status of Monitored Ref. Targets .
 - Black or white colour and name of Ref. Targets indicates that ECDIS screen display Monitored Ref. Targets
 - Red colour and name of Ref. Targets indicates that ECDIS screen display Planned Ref. Targets , while the ECDIS has also a Ref. Targets for monitoring
 - Red colour and no name of Ref. Targets indicates that ECDIS screen display Planned Ref. Targets while the ECDIS has no Ref. Targets for monitoring
 - If you have multiple workstations, the Monitored Ref. Targets is system wide selection. Planned Ref. Targets is always local for a single workstation.

Chart related changes

S57 and ARCS charts

- Method to display availability information such as "larger scale available" has been chart harmonised between S57 and ARCS
- The system maintain internal availability catalog and stores it into the harddisk. This has speed up operations such as "Initial delay during start up", "Date dependent" dialog, use of "Catalog" etc.
- Default used Presentation library for ECDIS has been changed from version 3.1 to 3.2 as IHO has published a new one.

S57 charts

- All attributes, which were previously only available as coded text strings, are now displayed in plain text. Before on "Tidal panel data" had this feature.
- A new selection to display cancelled charts in RENC using S57 Catalogue.

ARCS charts

- ARCS catalogue uses now common backdrop chart with S57. It is always automatically available. Use of low resolution ARCS charts in this system is discontinued after this improvement.
- ARCS charts can be used with new Skipper licence for non-SOLAS purposes. SOLAS users continue to use Navigator licence as before. The main difference of Skipper and Navigator licence schema is that Skipper licence do not include updating and thus the charts are not maintained up-to-date as required for SOLAS purposes.
- In ARCS Catalogue available up-to-date situation of chart with different colours based on ARCS weekly Update CD-ROM information which is loaded into ECDIS last time.
- If ENC chart is available from the area of ARCS chart it is now indicated.

Manual Update editor

- A new method to keep the charts up-to-date using easily detectable Standard orange symbols. Later these symbols are called as "**Orange symbols**".
- To add additional mariner information using easily detectable orange symbols.

This page is intentionally left blank

Changes since release 02.01

Overall operation related changes

Navigation sensors

- If position alignment is used then user is reminded of it every 30 minutes. Alarm "**2011 ChartAlign: over 30 min**".
- In multiple sensor case the Kalman filter indicates changes in its position sources with a new alarm "**2010 Filter: Pos source change**".
- Kalman filter uses always higher priority for known high precision position sensors than for normal position sensors (i.e. A DGPS has always higher influence to estimate than a GPS or LORAN)
- Alarm "**4027 DGPS pos source change**" uses now always a continuous beep until acknowledged. Before the beep style was dependent of the steering mode. Also the priority of this alarm is readjusted (before some less important alarm could suppress it in the priority list).
- Alarm "**2008 Filter. Speed below 4kt**" is now based on ground speed (before water speed). The Kalman filter indicates this situation also with an permanent indication of BAD FILTER.
- Reference target based gyro error correction has now an alarm for lost correction value. Alarm "**2353 RefTgt: Lost gyro corr.**".
- Activation of Reference target requires that there is at least 8 free tracking channels available. If the connected ARPA radar has less than 8 free tracking channels then there is an alarm "**2353 RefTgt: Tracking full**".

Route Monitoring

- Selection of "Center and border lines for ARPA radar display" .in route monitoring window is dependent of used radar display type.
- Alarm "**2457 Route: Outside channel limit**" is activated once when the ship goes out of the channel limits. Before the alarm was reactivated every 5 minute. NOTE the permanent indication of "OUTSIDE CHANNEL" operates as before and give always an indication of route tracking status.

Past Tracks

Own ship has now three separate past tracks:

- "System", which is the past track of the system position used for navigation and steering.
- "Primary", which is the past track of a position sensor selected as Primary.
- "Secondary", which is the past track of position sensors selected as Secondary.

Speed Vectors

- There is now a selection between true and relative speed vectors for own ship and ARPA targets. Before only true vectors were available.

Radar echo overlay

- There is now a selection between true and relative radar echo trails. Before only relative trails were available.

Details log

- details log for last 12 hours include now course over ground and gyro correction in order to provide more complete recording

Chart related changes

S57 and ARCS charts

- chart display has more alternatives to individually select visibility of different text on chart
- Info Request has now transparent area fill for better indication of the area in question
- Info Request show now the coded text for each picked object. Before only attributes and their values were available. This change eases for example usage of light descriptions.

S57 Chart

- Chart Catalogue uses colour coding to indicate up-to-date chart and non up-to-date charts.
- Telecomm order of Charts and updates open now automatically "Order queue window" and inform the user about end of orders when all requested transactions are complete.

Changes since release 02.00

Overall operation changes

Route Planning

- The maximum value of radius in a waypoint has been increased from 2.0 nm to 3.0 nm.

Chart related changes

S57 charts

- Compatibility with the official encrypted ENC chart service from a RENC has been added. This service is available using CD-ROMs and Telecomm, see chapter "Introduction to the S57 charts service from a RENC"
- Load using CD Catalogue identifies the issue data of a CD-ROM, see "How to load S57 Charts from a CD-ROM, floppy or LAN"
- Load using CD Catalogue has a new selector "Missing only", see chapter "How to load S57 Charts from a CD-ROM, floppy or LAN"
- Remove has been added in Load or View CD Catalogue "How to load S57 Charts from a CD-ROM, floppy or LAN"
- A world chart at scale 1:12 000 000 has been added as a backdrop in the Catalogue. It makes easier to view the coverage of S57 charts.

This page is intentionally left blank

Introduction

Manual Applicability

The Operators Manual of ECDIS EC 1000 provides information of following things:

- System Configuration.
- Screen interpretation and use of Control panel.
- Set up before departure.
- Rules to replace paper charts with electronic ones.
- Chart material handling.
- Manual Updates which are used to manually enter Notices to Mariners and Navtex warnings.
- Chart Alarm calculation.
- Route planning and monitoring.
- Various user tools such as User Charts, Pilot Data, Reference Targets and Navigation tools.
- Backup operations.
- Common Reference System
- Use of navigation sensors.
- Use of ARPA targets.
- Use of AIS targets
- Radar Echo Overlay.
- Various recording functions.
- Essential information of the Datum used by the charts and the ECDIS.
- Steering related operations.
- List of alarms.

The Technical Manual of ECDIS EC 1000, which is published separately, provides information of following things:

- Hardware configurations.
- Installation instructions.
- Troubleshooting.
- Failure mode analysis.

How to read this manual

The ECDIS is build on the platform of Windows NT. So the windows, menus and dialogues outfit seem same as in other Windows application. If you are not familiar with Windows NT refer for more information to manuals of Windows NT.

Below are explanations for a few terms used in this manual:

Set time
Parameter Backup Digitizer Backup and Restore
Installation parameters Navigation parameters ▶ Chart Alarm parameters Optimization parameters ▶
Print Navigation parameters ▶
Print Optimization parameters ▶
Selftest Standby
Presentation library
Access Server and Diagnostic ▶

This is typical menu of ECDIS. From this menu user can execute appropriate function. There can be two kinds of function in the menu:

1. Command, which executes directly function.
2. Command followed small triangle. By selecting function like that it will appear submenu where user can select appropriate function to execute.

There can also be command which is grey. Greyed commands are not active or they are for future use. They are not selectable.

A list box:

An edit box:

Safety contour m

Selected check box:

Name

A check box not selected:

Permit

System Configuration

ECDIS EC1000 Workstation displays electronic seachart and operates as user interface for the System.

ECDIS processor is connected to various sensors, does navigation calculations and route monitoring. Connections to interfaces are typically made with serial communication lines.

ECDIS processor can be used for both route planning and route monitoring. If required, there can be additional identical ECDIS EC1000 Workstation(s) connected to the same Local Area Network to share tasks of ECDIS. If more than one ECDIS EC1000 Workstations are connected into the System, one or more Workstation(s) can be used as user interface (with full usage rights) and one or more workstation(s) are used as planning station (Usage rights as Planning).

If the System has two or more Workstations connected together as Multi workstation, the system keeps data on Workstations harmonised and also tracks selections and settings made on any Workstation.

Typically there can be following kind of configurations of Workstations:

- Mode as **Single**, only one Workstation is used in the System.
- Mode as **Multi**, two or more Workstations are used in the System where **Usage rights** and **Sensor source** of Workstations can be changed by the user.

For more information, see chapter "Common Reference System".

Configuration for One Workstation

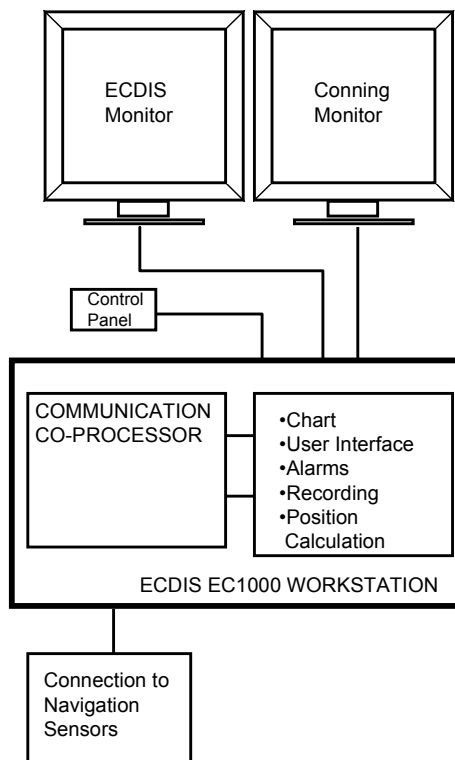

Single Workstation with connection to navigation sensors.

Configuration for Multi Workstations

Multiple Workstation configuration (navigation Workstation and planning Workstation), where one Workstation is used as **Sensor source** of navigation sensors and other Workstation(s) are using Sensor source workstation to communicate with sensors (receiving and transmitting data from/to Workstation via LAN).

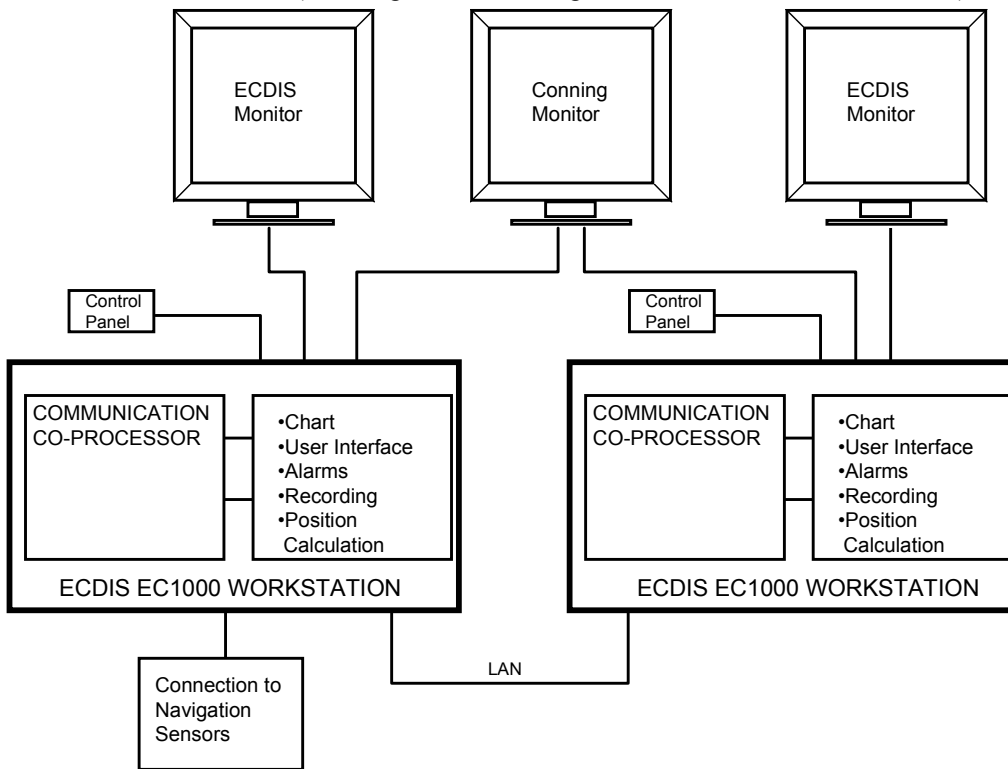

Multiple Workstation configuration (two fully redundant navigation Workstations), where Navigation sensors are connected to two or more Workstations. In this kind of configuration it is possible to change **Sensor source** and still have possibility to receive and transmit information from/to the System to/from navigation sensors. One user defined Workstation is responsible of Sensors at the time.

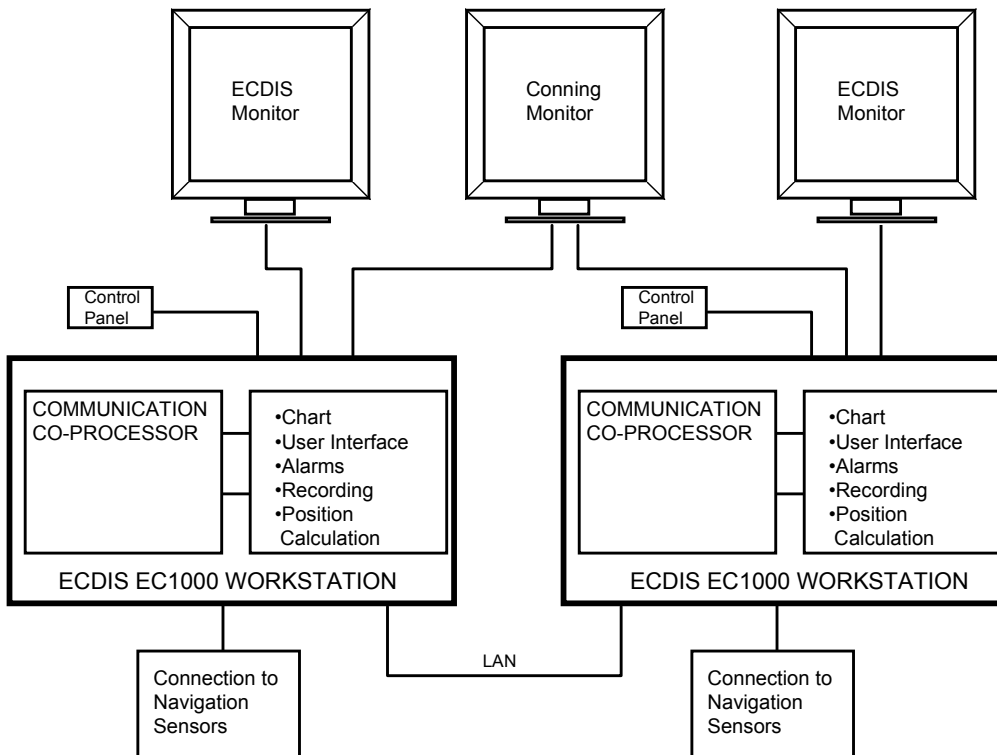

Navigation Tasks

Overview

Navigation tasks can be divided to four basic tasks:

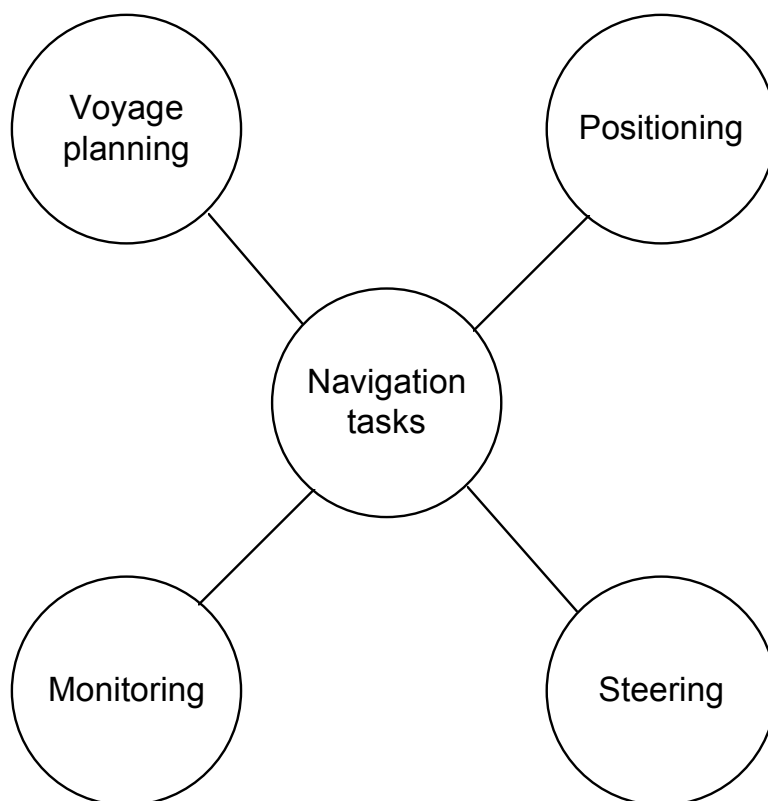

Navigation Tasks

Voyage planning

Voyage planning is a preparation phase for coming voyage. Preparation includes route definition, route calculation and optimisation.

Required sea charts are also prepared in voyage planning either by updating existing charts or creating new ones.

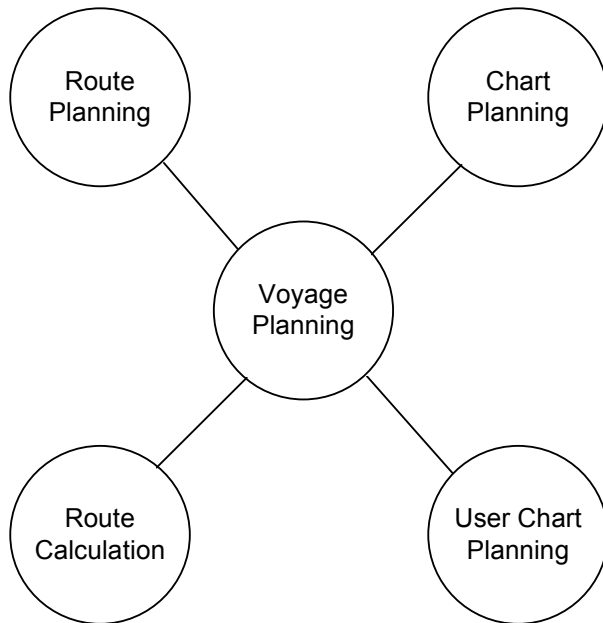

Route Planning

Modification an existing route or creating the whole new route is the way to do Route planning.

Definition of route consists following:

- Position of each waypoint
- Turning instruction for each waypoint
- Safety limits between waypoints (channel limits)
- Safe water calculation based on Safety limits
- Required steering accuracy for individual leg
- Speed restrictions for a leg

Information notebook:

- Information pages to alert operator at a given waypoint or in the selected area.
- Automatic and/or manual notebook function to tell operator position based information.

Voyage optimisation parameters.

Route Calculation

Route calculation for voyage planning includes following:

Route profile calculation:

- Distance between consecutive waypoints
- Course between waypoints
- Calculation of wheel over point
- Total distance
- Estimated time for voyage
-

Route check

- Grounding alarm based on available depth information in digital chart data base

Voyage optimisation:

- Time table optimisation
- Optimisation based on economical factors
- The ECDIS processor calculates optimum speed and course between each waypoint, ETA and fuel consumption, based on the defined data. There are 4 calculation strategies: Max. Speed, Timetable, Lowest Cost and Best Profit. In case of great circle sailing between two waypoints the ECDIS calculates max. and min latitudes and if needed adds an extra waypoint not to go over min or max. latitude.

Chart planning

1. Loading of new S57 and ARCS charts
2. Updating on existing S57 and ARCS charts
3. Handling of chart permits
4. Manual update

User Chart planning

1. User generated navigation charts
2. User defined chart alarms based on symbols, lines and areas of User chart

Positioning

Positioning means all available methods to calculate and keep updated ship's position during a voyage.

The calculation of ship's position is based on available navigation sensors. The system integrates valid information from different sensors and uses the Kalman filter technology for final position calculation.

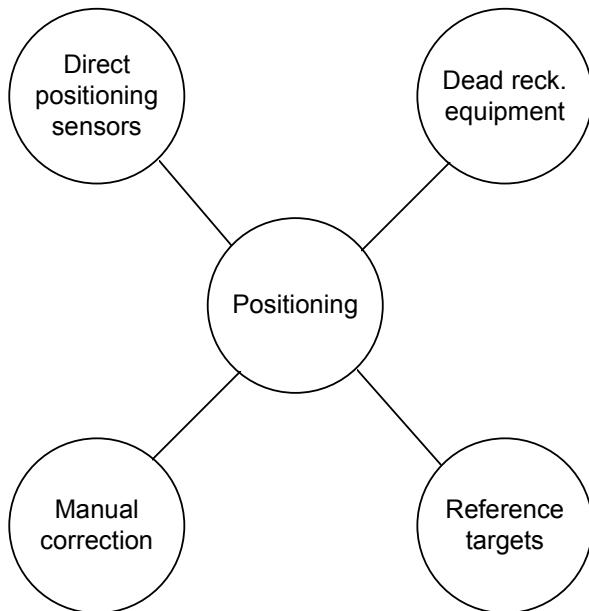

Direct Positioning sensors

Radio navigation equipment:

- Decca navigator
- Loran-C navigator
- Syledis navigator
- Local position fixing systems

Satellite navigation systems:

- GPS navigator
- GPS navigator with a differential correction, DGPS

Dead Reckoning equipment

Ship's heading measurement devices:

- Gyro compass
- Magnetic compass
- GPS gyro compass

Speed measuring devices:

- Single axis speed logs
- Dual axis speed logs
- Radio navigation equipment
- Satellite navigation equipment

Reference Targets

Ship position calculation based on selected radar object called Reference Target. Selection of radar objects is carried out in chart planning phase.

Manual Correction

User activated position correction where radar echoes and information of synthetic chart are combined and verified by operator, and adjusted if necessary.

Monitoring

Monitoring is a continuous check of navigation data, user actions and performance of the system. Part of the monitoring is also the display of electronic sea chart and conning information.

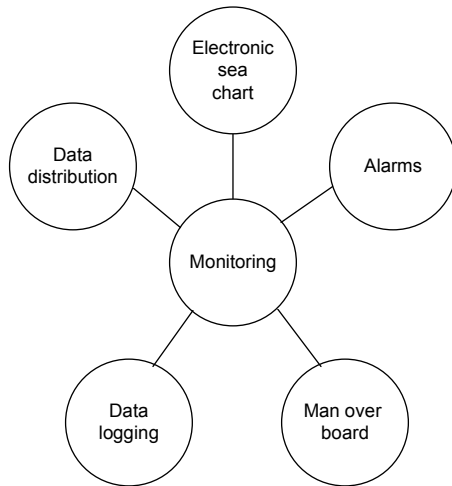

Display of electronic sea chart

Following information is available:

Own ship position

Planned track

Planned safety lines

Ship's predictor

Chart alarms

ARPA targets

Chart information

Alarms

Following information is available:

Route monitoring alarms

Position calculation alarms

Position monitoring alarms

Waypoint approach alarms

Alarms for sensor failure

Alarms for system failure

Alarms for incorrect operator action

Alarm based on chart database

Man Over Board

Built-in function for man over board.

Data Logging

Following information is available:

Past track history

Events

Dangerous targets

Voyage recording

Data Distribution

- Connection to on board computer system

This page is intentionally left blank

ECDIS Screen

Overview

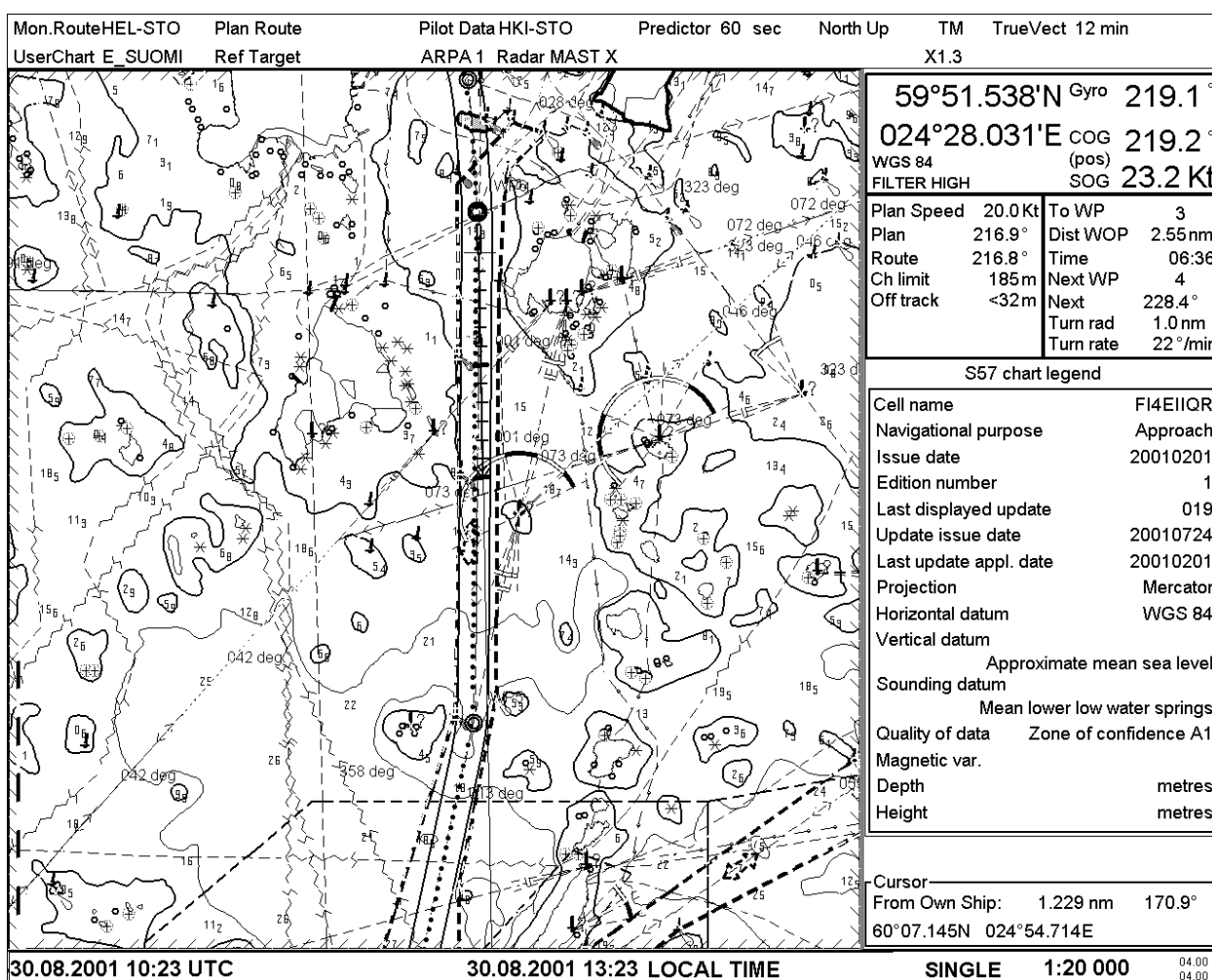

Parts of the ECDIS display.

The ECDIS (Electronic Chart Display and Information Systems) screen includes several areas. There is statusbar at the top and the bottom of the screen, which are shown permanently. The upper and lower right hand corner is taken up by permanently shown information in Information area. Between these areas there is a Dialog box area where user can fill or choose appropriate options. The left hand part of the ECDIS screen is the Electronic chart area. When the push button is pressed from the Control Panel appropriate menu opens up top of chart legend.

Electronic chart area

The ECDIS can use the following types of charts:

- S57ed3 ENC charts (vector)
- CM-93 charts (vector)
- ARCS charts (raster)

There can also be displayed following information:

- cursor moved by trackball
- planned route
- EBL (Electronic Bearing Line) and VRM
- symbol of ownship with speed vector
- targets acquired by ARPA

Electronic charts in ECDIS

The electronic navigational charts are displayed in Electronic chart area. There are two kinds of electronic navigational charts available to use in the ECDIS:

- S57ed3 ENC or CM-93 vector format
- ARCS raster format

S57ed3 ENC and ARCS electronic charts may substitute official paper charts. User should check the current situation from his flag country administration and if in doubt use the paper charts as primary source of navigational information.

ECDIS combines chart and navigational information. It should be noted that modern navigation systems (e.g., differential GPS) may offer a more accurate positioning than was available to position some of the surveys from which the electronic navigational chart was derived.

S57 vector format:

ECDIS is compatible with S57 release 3 ENC format. From this format the ECDIS generates the “System ENC”, = SENC, which is used for actually for operations the ECDIS.

When opening a chart it is displayed with default scale called compilation scale. It is possible to modify details of chart displayed in Electronic chart area. You can change scale of chart by pressing ZOOM IN and ZOOM OUT pushbuttons. Scale range is 1:1 000 - 1:50 000 000.

CM-93:

Compatibility with CM-93 format depends on commercial agreements. Some versions of this ECDIS are compatible and others are not. The compatibility is controlled by the security device called dongle. From CM-93 format the ECDIS generates SENC which is used for actual operations of the ECDIS. The difference between S57ed3 ENC charts and CM-93 charts is that the CM-93 charts are from a private source and they cannot be used as a substitute of paper chart under any condition. To highlight that part they are later called as NON-HO charts in this manual.

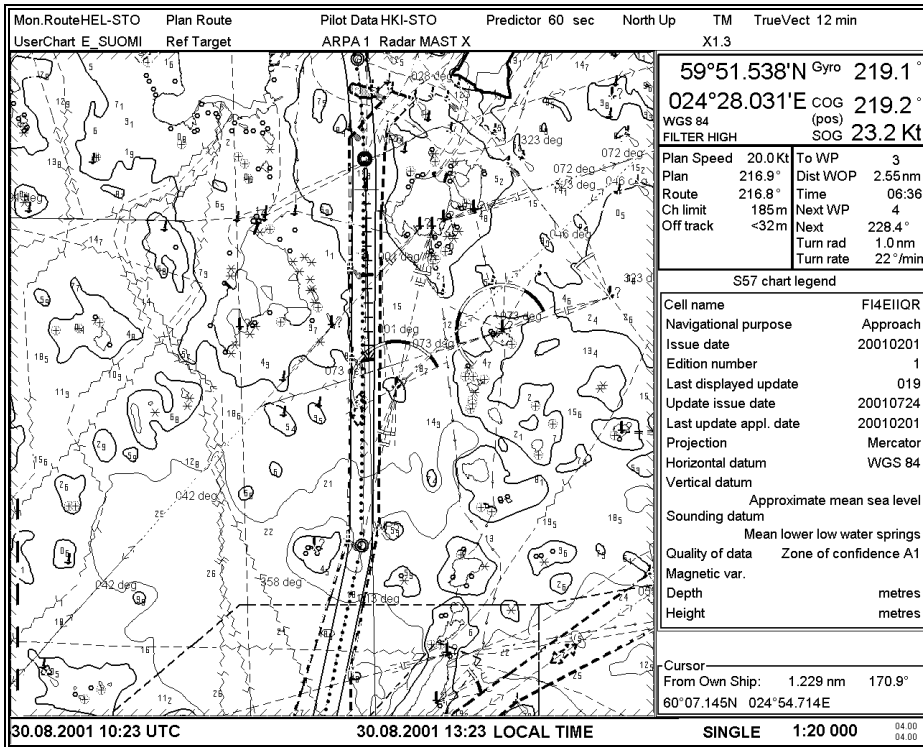

S57 vector chart presentation

ARCS raster format:

ARCS charts are digital reproductions of British Admiralty (BA) paper charts. They retain the same standards of accuracy, reliability and clarity as paper charts.

Zooming into the ARCS chart can be useful for magnifying complex detail, but decreases the density of data displayed, and can give a false impression of distance from danger. Therefore it is possible to zoom 2*original paper chart's scale or 1/2*original paper chart's scale.

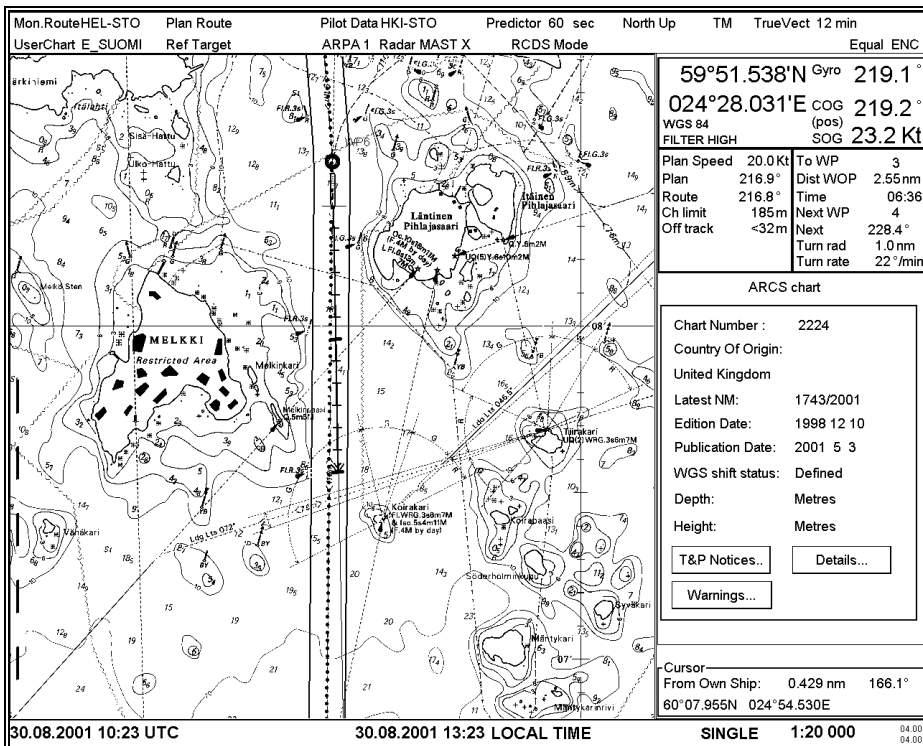

ARCS raster chart presentation

Upper statusbar

Upper Status bar is used to display selections made by user and information based on chart data base stored on hard disk. See example below how to find out description of Upper Status bar (In this example Upper Status bar is divided into two parts and fields are separated by dashed lines).

List of Indications on Upper Status bar

1.	2.	3.
Mon.Route HKI-TAL	Plan Route BRH-ZEE	Pilot Data HKI-TAL
UserChart HKI	Ref Target HKI	ARPA 1 Radar MAST X
4.	5.	6. 7.
8.	9.	10. 11.
Predictor 60 sec	North Up TM	TrueVect 12 min TrueTrail
RCDS Mode	TM RESET off	Overscale Larger RNC Equal ENC
12.	13.	14. 15.

See table below to find description of indications on Upper Status bar.

The list of fields and all possible indications :

Number	Indication
1.	Mon. Route The name of selected Route in monitor mode.
2.	Plan Route The name of selected Route in planning mode.
3.	Pilot data The name of selected Pilot Data in monitoring mode.
4.	UserChart The name of selected User Chart in monitoring mode.
5.	Ref Target The name of selected Reference Target in monitoring mode.
6.	ARPA X The number of ARPA radar, which is the current source of ARPA target data.

7.	<p>Radar</p> <p>The source of radar video overlay.</p>
8.	<p>Predictor</p> <p>Set time of displayed predictor in seconds</p>
9.	<p>Orientation of displayed chart and Presentation mode of own ship . Available modes are:</p> <ul style="list-style-type: none"> • North Up TM (True Motion) • North Up RM (Relative Motion) • Course Up TM (True Motion) • Course Up RM (Relative Motion) • Head Up RM (Relative Motion) • Route Up RM (Relative Motion)
10	<p>Presentation mode of speed vectors (own ship and ARPA targets) and set time. Available modes are:</p> <ul style="list-style-type: none"> • True vectors, TrueVect • Relative vectors, RelVect
11.	<p>Trails of radar video overlay. Available modes are:</p> <ul style="list-style-type: none"> • When selected true trails of radar echoes, TrueTrails • When selected relative trails of radar echoes, RelTrails
12.	<p>Indication of displayed chart material:</p> <ul style="list-style-type: none"> • When there is no indication, then official ENC chart is displayed. • When ARCS chart is displayed on ECDIS, RCDS (Raster Chart Display System mode). • When displayed chart is from unofficial vector chart material, NON ENC. • When Radar video overlay is displayed on top of chart, Radar Over Chart. • When only Radar video overlay is displayed, Radar Video Only.
13.	<p>Indication of automatic TM reset of own ship if it is set off:</p> <ul style="list-style-type: none"> • TM Reset Off • Ship off screen
14.	<p>Indication of selected scale of displayed chart referred to the original scale of chart.</p> <p>With ARCS following are available:</p> <ul style="list-style-type: none"> • Displayed Chart is in smaller scale than original paper chart, Underscale • Displayed Chart is in larger scale than original paper chart, Overscale <p>With S57 (ENC)</p> <ul style="list-style-type: none"> • If selected scale of chart is larger than compilation scale of chart, it is indicated as X nn (for example "X10.7" or "X2.0")

15.	<p>Indication of availability of charts:</p> <ul style="list-style-type: none"> • If TM reset is active, then indication is from own ship position • If automatic TM reset is set off, then indication is from current cursor location <p>With ARCS following indications are used:</p> <ul style="list-style-type: none"> • If larger scale ARCS are available, Larger RNC • If same scale ARCS available, Eq RNC • If larger compilation scale ENC available, Larger ENC • If same compilation scale ENC available, Eq ENC • If smaller compilation scale ENC available, Smaller ENC <p>With S57(ENC) following indication is used</p> <ul style="list-style-type: none"> • If larger compilation scale ENC available, Larger scale data exists
-----	---

Lower Status bar

Find below description of Information available on Lower Status bar:

01.06.2001 09:02 UTC	01.06.2001 12:02 LOCAL TIME	MULTI	1:1 000 000	03.00 03.00
----------------------	-----------------------------	-------	-------------	----------------

The data displayed in lower statusbar includes the following listed from left to right:

Field	Description
UTC time	Co-ordinated Universal Time. The UTC time indicates time on Greenwich Meridian.
Local time zone	User can select local time zone to be displayed in this field.
Mode of Workstation	Mode of Workstation is indicated with text MULTI, SINGLE, PLAN or SLAVE.
Scale	Scale of displayed chart is shown in this field.
Software release	Current software release is shown here. Upper value is software release of the ECDIS chart. Lower value is software release of the ECDIS navigation interface.
Alarms:	Alarms generated by the system (replace UTC time) and by the steering (replace local time) is shown in lower status bar.

Find below a few examples of Lower Status bar:

01.06.2001 09:02 UTC	01.06.2001 12:02 LOCAL TIME	MULTI	1:1 000 000	04.00 04.00
----------------------	-----------------------------	-------	-------------	----------------

Lower status bar in normal operation.

2009 Position source change	01.06.2001 12:02 LOCAL TIME	MULTI	1:1 000 000	04.00 04.00
-----------------------------	-----------------------------	-------	-------------	----------------

Lower status bar, when the system has generated an alarm.

01.06.2001 09:02 UTC	2468 Disabled: Steering off	MULTI	1:1 000 000	04.00 04.00
----------------------	-----------------------------	-------	-------------	----------------

Lower status bar, when the steering has generated an alarm.

Dialogbox area

Content of Dialogbox area is depending on status of ECDIS. This is the area where user can discuss with application. If user has pressed a pushbutton of Control panel and chooses desired menu command from the menu there will appear the corresponding dialog box in the Dialog box area.

Information Area

In Information area where is permanently displayed information about the position of own ship and the route monitoring (upper part of the area) and information of cursor's location on the chart (lower part of area).

Information from the positioning sensors:

- Latitude and Longitude
- GYRO readings and source of it if it is not real gyro
- COG (Course over ground) and source of it
- SOG (Speed over ground)
- Positioning source, which can be: Dead Reckoning, GPS, DGPS, LORAN, FILTER etc.
- Datum in use, which is shown above positioning source. (WGS 72, WGS 84, European 1950 etc.)

59°51.538'N	Gyro	219.1 °
024°28.031'E	COG	219.2 °
WGS 84	(pos)	
FILTER HIGH	SOG	23.2 Kt

Information from Route monitoring:

- **Plan Speed**; planned speed to approach "To WP".
- **Plan**; planned course between previous and "To WP".
- **Route**; calculated set course to follow the Monitored route including off track, drift and gyro error compensation.
- **Ch limit**; planned width of channel to approach "To WP".
- **Off track**; perpendicular distance of the ship from the track.
- **To WP**; the waypoint which the ship is approaching.
- **Dist WOP**; distance to the point where rudder order for course change at "To WP" will be given.
- **Time**; time left to WOP (dd:hh:mm:ss).
- **Next WP**; the wp following the "To WP".
- **Next**; planned course between "To WP" and "Next WP"
- **Turn rad**; planned turning radius at "To WP".
- **Turn rate**; calculated rate of turn which bases on current speed and planned turning radius.

Plan Speed	20.0 Kt	To WP	3
Plan	216.9 °	Dist WOP	2.55 nm
Route	216.8 °	Time	06:36
Ch limit	185 m	Next WP	4
Off track	<32 m	Next	228.4 °
		Turn rad	1.0 nm
		Turn rate	22 °/min

Additional textual information is available if any of following steering mode is in use:

- "Goto WP", "GotoWP Great circle", "Ass. Turn enabled" and "Assisted turn" in Goto Waypoint mode
- "Goto Track", "Track Great circle", "Track Turn" in Go Track mode

Permanent alarms are available regardless of the used steering mode:

- "Outside channel" is indicated by red colour of the "Off track" value and by orange text
- "Out of gate" is indicated by orange text. Out of gate indicates that, if the vessel continues using the current course, then the vessel will be outside of the channel at wheel over point.

Information, which has calculated from data of positioning sensors and from data of Route monitoring by the system:

- **Route**
- **Off track**
- **Dist WOP**
- **Time**
- **Next**

Position of cursor, co-ordinates displayed in selected Datum.

Range and bearing from own ship position.

Cursor		
From Own Ship:	2.180 nm	185.5 °
59°49.370'N	024°27.615'E	

This page is intentionally left blank

Control Panel

Overview

The user controls the ECDIS with the Control Panel. The Control Panel includes the pushbuttons and the trackball. The trackball is used as a mouse by rolling the ball and using the pushbuttons SELECT. The user can control the cursor's position on the display, select the menu items and alter values of various parameters.

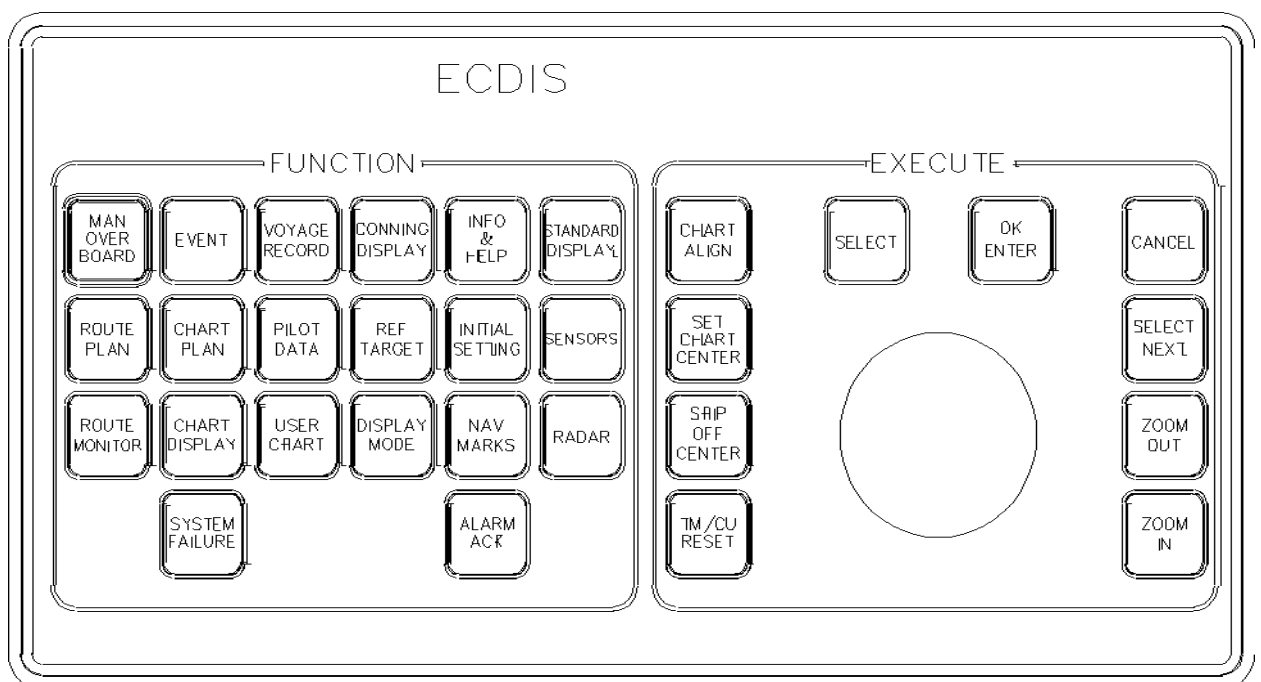

Layout of the Control Panel.

Operative push buttons



SELECT

Used in window dialog to push soft keys, tick boxes etc. It is also used to insert WPs, User Chart objects etc. when corresponding sheet is open in a Dialog box area.



OK/ENTER

It is used in window dialog to select OK or ENTER option.



SELECT NEXT

If dialog box has two or more sheets, SELECT NEXT is used to open next sheet.



CANCEL

It is used to close window dialog on display. To get Chart legend to be displayed, press CANCEL in the Control Panel until panel appears with Chart Number as top item.

Direct function push buttons



STANDARD DISPLAY

It is used to make displayed object selection as defined by IMO performance standard.



CHART ALIGN

User can move own ship over chart to new position. It is used to align chart correctly if used position method does not give accurate position. Moves also waypoints etc. to a new position if corresponding window is open in dialog box area.



ZOOM OUT

This is used to change the scale of displayed chart. The scales of chart have defined by system. Pushing once the zoom out pushbutton you get next smaller scale of chart on display (e.g. before ZOOM OUT scale was 1:10000 and after ZOOM OUT it is 1:20000). The scale of chart is indicated as fraction in lower statusbar.



ZOOM IN

This is used to change the scale of chart display. The scales of chart have defined by system. Pushing once the zoom in pushbutton user gets next greater scale of chart on display (e.g. before ZOOM IN scale was 1:20000 and after ZOOM IN it is 1:10000). The scale of chart is indicated as fraction in lower statusbar.



SET CHART CENTER

User can set the current cursor position as new chart center position by pushing SET CHART CENTER button. Automatic true motion reset is disabled, when user presses SET CHART CENTER button. This can be used to view ahead, route planning etc.



SHIP OFF CENTER

User can set the current cursor position as new position of ship on the display. This enables automatic true motion reset. If the cursor position was in true motion reset area then an automatic true motion reset happens.



TM/CU RESET

Pressing this button performs true motion reset and enables automatic true motion resets.



LOGBOOK M.O.B.

This button is used to record a predefined Man Over Board event to logbook. Position of this event is also displayed on chart as a red mark.



LOGBOOK EVENT

This button is used to record an event to logbook. You can also write a comment for this event.

Note, it is displayed only if Events is selected to display in Chart display dialog box.



ALARM ACK

Alarm is displayed in the lower status bar. Also a red lamp is activated for this pushbutton. High priority alarm has also an audible sound.



lamp SYSTEM FAILURE

This lamp is lit in case of internal failure which has serious effects for operation.

Menu push buttons

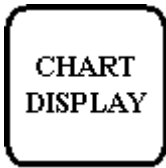
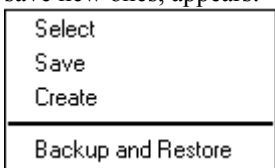

CHART DISPLAY PUSH BUTTON IS USED TO CONTROL VISIBILITY OF CHART DETAILS OF BOTH ARCS RASTER CHARTS AND S57 VECTOR CHARTS.

For more information, see Chapter "Control of visible chart features" in ECDIS EC 1000 Operators Manual.

Press Chart Display button once, a Chart display window appears. To open another page of Chart Display (Chart, Standard, Other, Tracking, Mariner, Route or ARCS details), use SELECT NEXT button.

Press Chart display button once more a Chart display menu, where you can select predefined settings or create and save new ones, appears:



ROUTE PLAN

ROUTE PLAN PUSH BUTTON IS USED TO CONTROL ROUTE PLANNING FUNCTION.

For more information, see Chapter "Route Planning" in ECDIS EC 1000 Operators Manual.

Press Route Plan button once, a Route Plan window, which shows information of selected route, appears in Dialog box area.

To open another page (WP, Check, Alarms, Params or Prepare), use SELECT NEXT button

Press Route Plan button once more a Route Plan menu, where you can select another route for planning or create a new one, etc., appears:

- Select
- Cancel
- Create

- Exchange with Monitored
- Copy from Monitored

- Backup and Restore

- Report
- Full WP Report
- Passage Plan Report

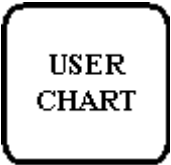

USER CHART PUSH BUTTON IS USED TO CONTROL USER CHARTS.

For more information, see Chapter "User Chart Control" in ECDIS EC 1000 Operators Manual.

Press User Chart button once, a User Chart window, which shows information of selected User Chart, appears in Dialog box area.

To open another page (Point, Line, Area, Symbol or Tidal), use SELECT NEXT button.

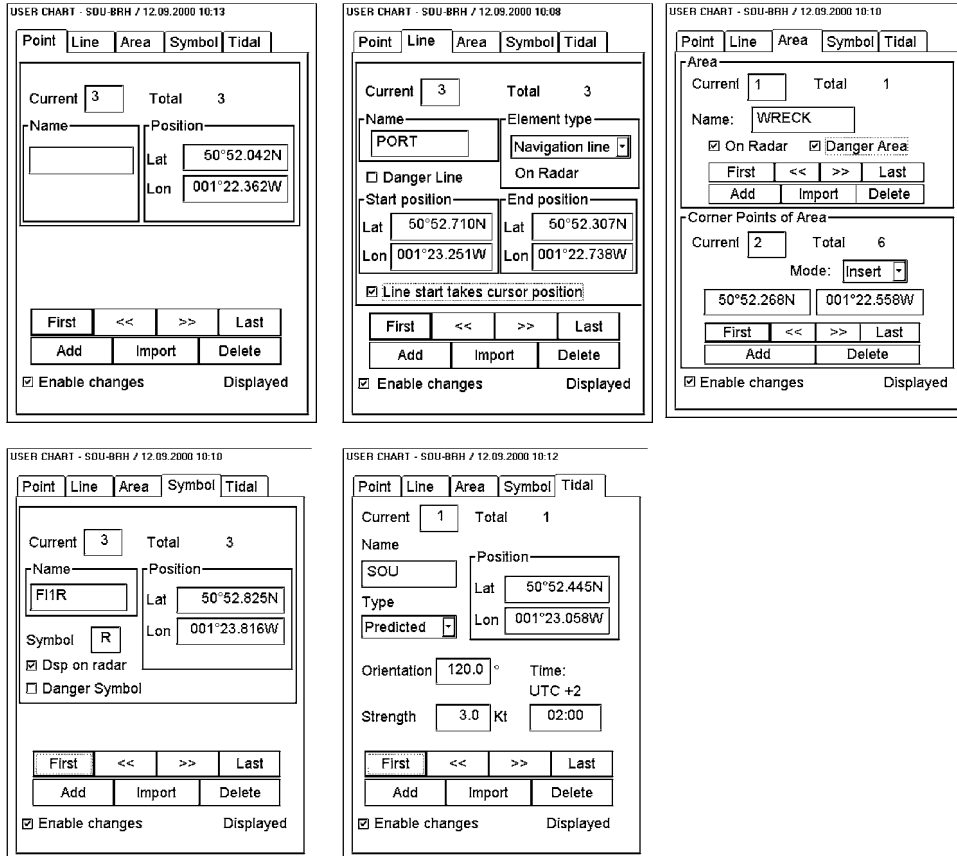

Press User Chart button once more a User Chart menu, where you can select another User Chart for use or create a new one, etc., appears:

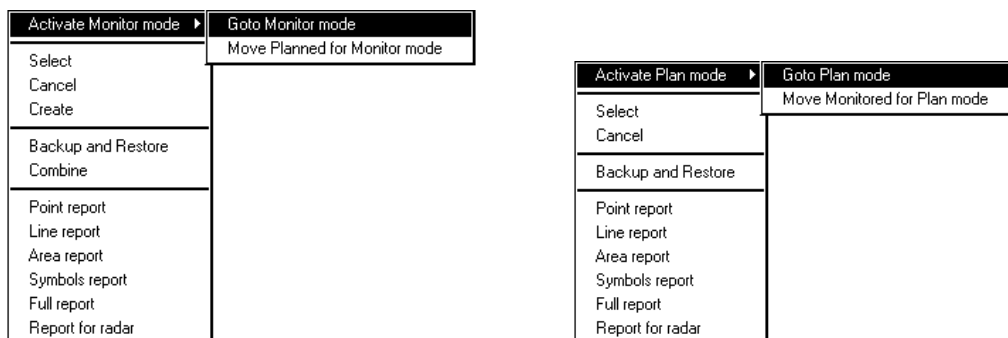

Menu for Plan mode

Menu for Monitor mode

PILOT DATA

PILOT DATA PUSH BUTTON IS USED TO CONTROL PILOT DATA.

For more information, see Chapter "Pilot data" in ECDIS EC 1000 Operators Manual.

When you press Pilot Data button once, a Pilot Data window, which shows information of selected Pilot Data, appears in Dialog box area.

Dialog boxes for Plan and Monitor modes:

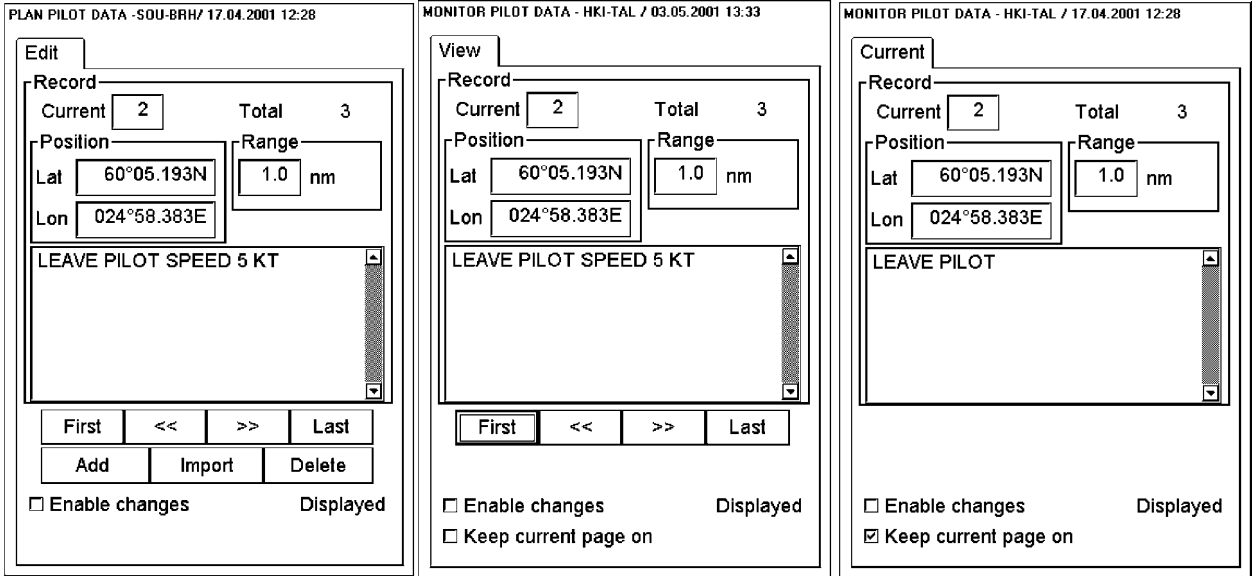

When you press Pilot Data button once more a Pilot Data menu, where you can select another Pilot Data for use or create a new one, etc., appears:

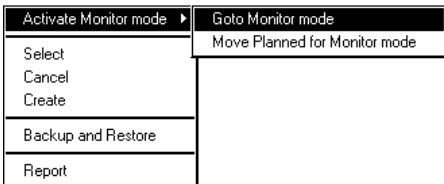

Menu for Plan mode

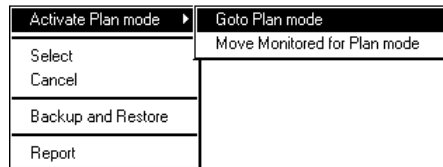

Menu for Monitor mode



ROUTE MONITOR PUSH BUTTON IS USED TO MONITOR ROUTE.

For more information, see Chapter "Route Monitoring" in Operators Manual ECDIS EC 1000.

Press Route Monitor button once, a Route Monitor window, which shows information of selected route, appears in Dialog box area.

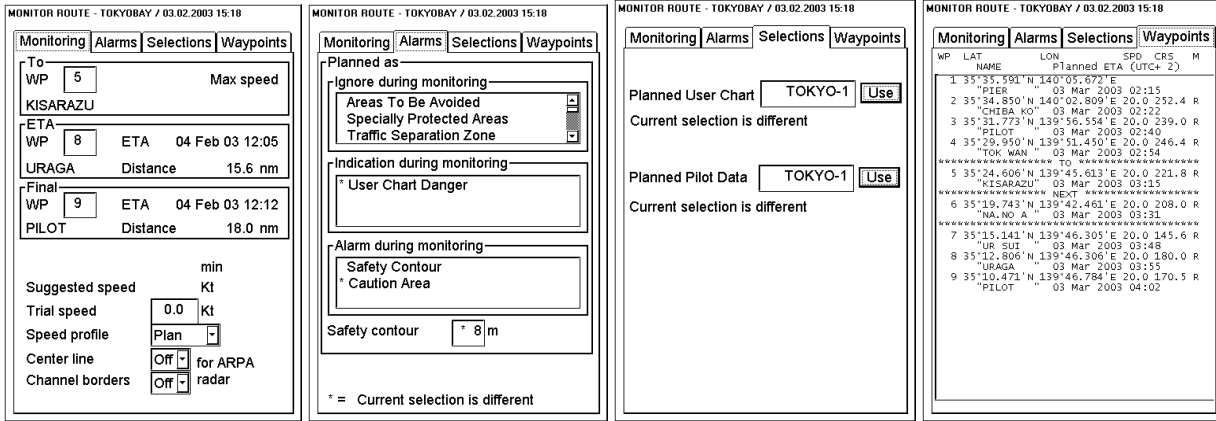

Press Route Monitor button once more a Route Monitor menu, where you can select another route for monitoring, appears:



REF TARGET PUSH BUTTON IS USED TO CONTROL REFERENCE TARGETS.

For more information, see Chapter "Reference targets" in ECDIS EC 1000 Operators Manual.

Press Ref Target button once, a Reference Target window, which shows information of selected Reference Target, appears in Dialog box area.

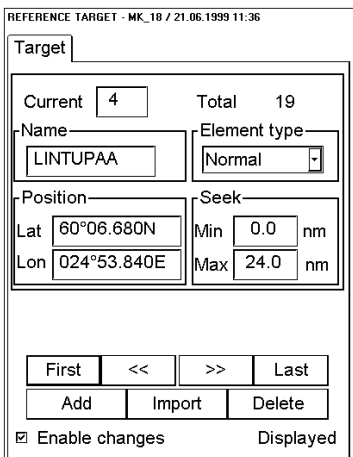

Press Reference Target button once more a Reference Target menu, where you can select another Reference Target, for use or create a new one, activate Reference target as position device:

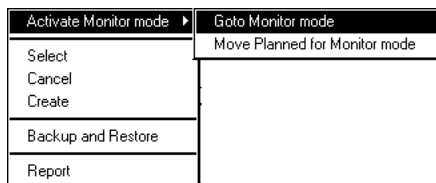

Menu for Plan mode

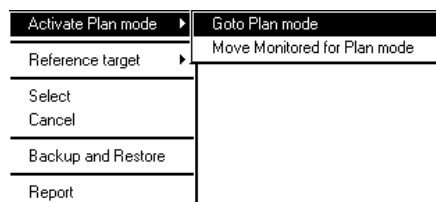

Menu for Monitor mode

NAV MARKS

NAV MARKS PUSH BUTTON IS USED TO DEFINE EBL, VRM, PARALLEL INDEX AND RANGE RINGS.

For more information, see Chapter "Navigation marks in ECDIS EC 1000 Operators Manual."

Navigation marks consist of two independent sets of tools. Both tools have REFERENCE POINT, EBL, VRM, PARALLEL INDEX and RANGE RINGS which are displayed in the Electronic Chart Area.

NAVIGATION MARKS

Tool set 1 | Tool set 2

Centered reference point Reset

Move Display

Reference point

VRM

EBL

Parallel index

Range rings 1 nm

Info

Data

EBL 224.7 ° VRM 2.175 nm

34°56.507N 129°10.415E

Ref. 34°58.053N 129°12.273E

NAVIGATION MARKS

Tool set 1 | Tool set 2

Centered reference point Reset

Move Display

Reference point

VRM

EBL

Parallel index

Range rings 1 nm

Info

Data

EBL 224.7 ° VRM 2.175 nm

34°56.507N 129°10.415E

Ref. 34°58.053N 129°12.273E

SENSORS

SENSORS PUSH BUTTON IS USED TO SELECT SENSORS USED BY ECDIS.

For more information, see Chapter "Navigation Sensors" in ECDIS EC 1000 Operators Manual.

To open another page (Speed/Course, Pos, Other or Record), use SELECT NEXT button.

SELECT SENSORS - Source: EC1000

Speed/Course | Pos | Other | Record

Manual speed Kt

Log 16.9 Kt

Dual log > 0.0 Kt
(bottom) ^ 16.9 Kt

ARPA 16.9 Kt
257.5 °

Manual heading °

Gyro 1 257.3 °

Gyro 2 257.3 °

Rate gyro (calc.) -2.0 °/min

SELECT SENSORS - Source: EC1000

Speed/Course | Pos | Other | Record

Alignment Start

Enable chart align

Range 0.0 nm Bearing 0.0 °

Dead reckoning

Lat 55°59.330N Lon 011°34.757E

Kalman filter Off

10.0Kt 243.2 °

Lat 60°04.693N Lon 024°47.970E

GPS1 Primary Diff

10.0Kt 243.2 °

Lat 60°04.729N Lon 024°48.099E

GPS2 Secondary

10.0Kt 243.2 °

Lat 60°04.680N Lon 024°47.924E

SELECT SENSORS - Source: EC1000

Speed/Course | Pos | Other | Record

Wind

True Wind 7.8 Kt 65 °

Set and Drift

(log) Angle 0.0 ° Manual

Set 345.0 ° Drift 0.0 Kt

Pitch and Roll

Pitch ° Roll °

Depth below transducer m

Gyro correction 0.0 °

Over Ground

Distance counter 910.9 nm

Trip counter 910.9 nm

Through Water

Distance counter 910.8 nm

Trip counter 910.8 nm

AIS Targets

Danger and Lost Target Alarms

Received data Ok

Display Ok

Storage Ok

SELECT SENSORS - Source: STBD ECDIS

Speed/Course | Pos | Other | Record

Device: GP-80

Lat: 55°59.281N Lon: 011°34.600E

Record

CHART PLAN

CHART PLAN PUSH BUTTON IS USED TO CONTROL BOTH ARCS RASTER CHARTS AND S57 VECTOR CHARTS MENUS.

For more information about ARCS charts, see Chapter "ARCS charts" and about S57 charts see chapter "S57 charts" in ECDIS EC 1000 Operators Manual.

Chart Plan menu when S57 is in use

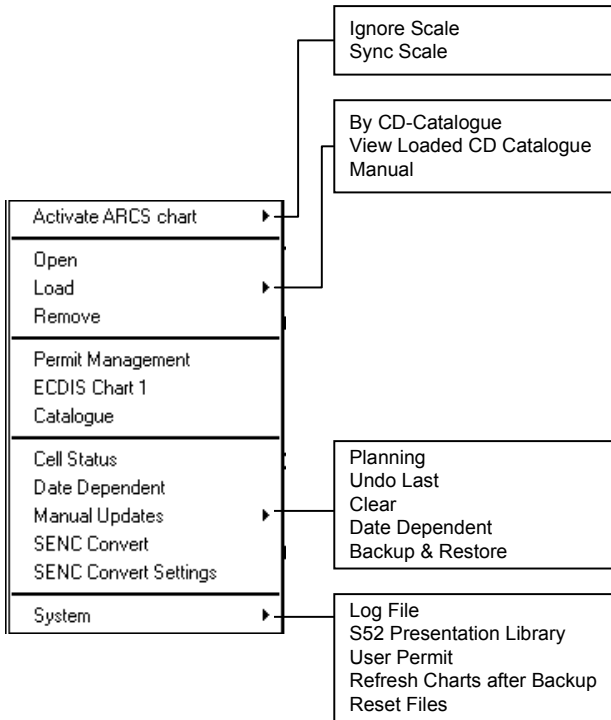
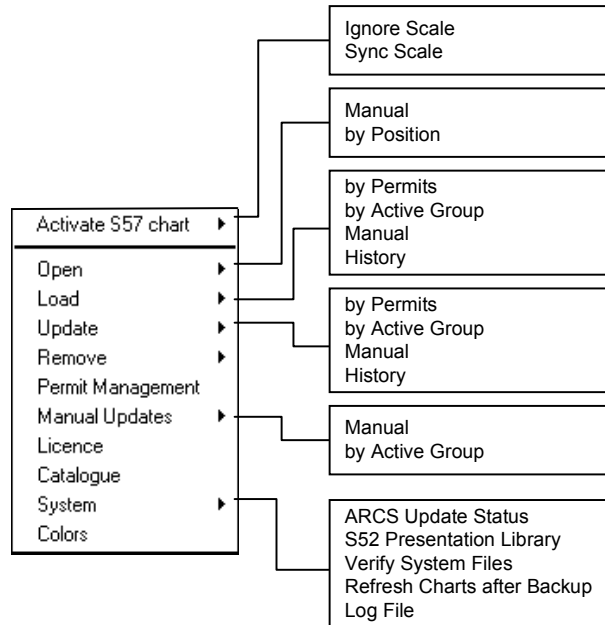

Chart Plan menu when ARCS is in use



INITIAL SETTING

INITIAL SETTING PUSH BUTTON IS USED TO CONTROL SETUP AND CONFIGURATIONS OF THE SYSTEM.

For more information, see Chapter "Parameters setup" in ECDIS EC 1000 Operators Manual.

Press Initial Setting button once, a Initial settings window, where you can select Datum, appears in Dialog box area.

INITIAL SETTINGS

Set values

Datum

Set Gyro

Position discrepancy limit nm

INITIAL SETTINGS

Set values

Datum

Set Gyro

Position discrepancy limit nm

Workstation

Usage rights

Sensor source

Mode

Lower part of dialog appears only if in Installation Parameters of ECDIS has been configured as Multi workstation. You can set Usage rights, Sensor source and Mode of Workstation in this dialog.

Press Initial setting button once more a Initial Settings menu, where you can change settings of parameters etc., appears:

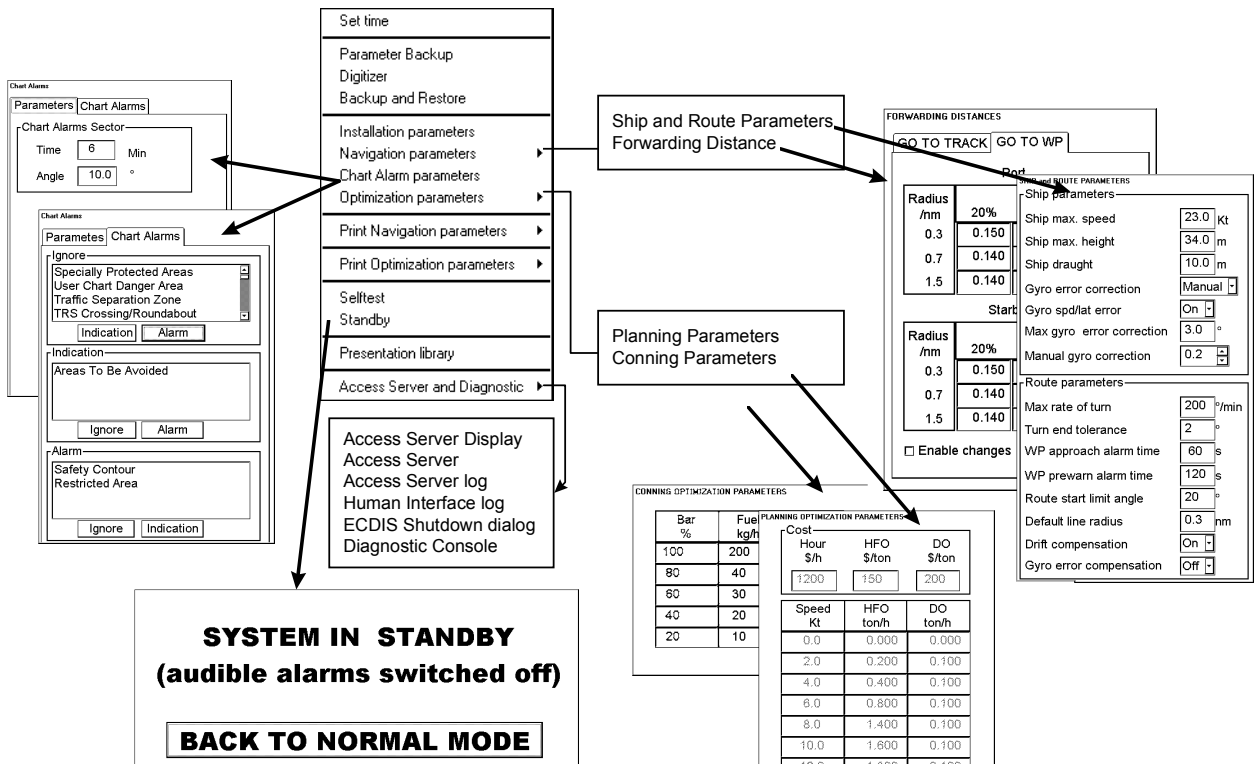

VOYAGE RECORD

VOYAGE RECORD PUSH BUTTON IS USED TO SELECT VOYAGE RECORDING RELATED THINGS.

For more information, see Chapter "Recording functions" in ECDIS EC 1000 Operators Manual.

When VOYAGE RECORD button is pressed a menu appears where various logs can be viewed, set conditions for recordings, etc.

The screenshot shows several windows from the ECDIS interface:

- Details log - ANTS Event viewer**: A table with columns Date, Time, Type, Lat, Lon, Algn (nm), Algn (ft), Spd (kt). It shows data for 29.11.2000 at 07:46:00.
- Total voyage log - ANTS Event viewer**: A table with columns Date, Time, Type, Lat, Lon, Spd (kt), Grd (T), Hdg (T). It shows data for 29.11.2000 at 04:00:00.
- Danger targets log - ANTS Event viewer**: A table with columns Date, Time, Type, Lat, Lon, Spd (kt), Grd (T), Hdg (T). It shows target data for 27.11.2000 at 09:44:00.
- ALARMS_LDG.TXT - TextView**: A log window showing messages such as "Log File checked but not truncated", "4005: Gyro Error (3)", "2002: No course available", "4008: Log Error (3)", "4009: Dual-Axis Log Error (3)", "2457: Route: Outside chl limits (3)", "1150: New system parameters (7)", "2009: Position source change (1)", "2568: MD RDERR:IT_GEN\rfcr.tmp (0)", "2056: ARPA Radar comm. Error (1)", "2457: Routes outside chl limits (3)", "1150: New system parameters (7)", "Log File checked but not truncated".
- Alarm Queue**: A list of alarms including "2 5100 Safety Contour", "2 5103 User Chart Dam...", and "8 2001 No sp...".
- chart_usage.txt - TextView**: A log window showing chart usage details like Scale, Chart Number, Edition Date, Call ID, and Edition.
- Settings Menu**: A dialog box for "Danger Targets Voyage" with fields for:
 - Danger Target Limits: CPA (3.0 nm), TCPA (12 min)
 - Log interval: 1 min
 - Log Single:
 - Speed/Course Change Limits: Speed (5.0 Kt), Course (5.0 °)
 - Log interval: 4 hours
 - Alarms: Record (checked), Don't Record (unchecked)
 - Record list: 2451, 2452, 2456, 2457, 2471, 2475, 2476

A central menu box lists the following options:

- Details Log
- Voyage Log
- Danger Target Log
- Alarms Log
- Current Alarms
- Chart Usage Log
- Backup and Restore
- Settings
- Reset

Arrows indicate that the "Voyage Log" option points to the "Total voyage log" window, "Danger Target Log" points to the "Danger targets log" window, "Alarms Log" points to the "Alarm Queue" window, "Chart Usage Log" points to the "chart_usage.txt" window, and "Settings" points to the "Danger Targets Voyage" settings dialog.

DISPLAY MODE

DISPLAY MODE PUSH BUTTON IS USED TO CONTROL SELECTION BETWEEN TRUE AND RELATIVE MOTION AND ORIENTATION OF CHART

For more information, see chapter "Display mode" in ECDIS EC 1000 Operators Manual.

- True Motion North Up
- True Motion Course Up
- Relative Motion North Up
- Relative Motion Course Up
- Relative Motion Head Up
- Relative Motion Route Up
- Set Center

Selection for Display Mode and Chart Orientation



RADAR PUSH BUTTON IS USED TO CONTROL ARPA TARGET SOURCE AND RADAR ECHO OVERLAY SETTINGS on ECDIS display.

Note, Radar overlay is an option which is not available all devices. For more information, see Chapter "Radar video overlay" in ECDIS EC 1000 Operators Manual.

RADAR OVERLAY SETTINGS

Radar Overlay source MAST X

Gain %

Sea clutter filter %

Rain clutter filter %

Echo trail time min

Echo trails TRUE

Interference reject OFF

Echo stretch OFF

Noise display OFF

Mode ECDIS and Radar

Transparency Opaque

ARPA target source 1

INFO & HELP pushbutton



INFO & HELP push button operates together with the cursor on display.

- If cursor is located outside chart area, then it activates help function.
- If cursor is located in chart area over ARPA target, then you will get the information of that target.
- If cursor is located over Pilot data, User Chart or Reference target object, or over M.O.B or Event symbol, then you get information of pointed object.
- If cursor is located in chart area, then you will get information from chart database about the pointed cartographic object.
- If cursor is located over alarm text, then it activates Alarm Queue

Alarm Queue

2 5100 Safety Contour

2 5103 User Chart Danger Area

8 2001 No speed available

This page is intentionally left blank

Standby mode

Switch ON and OFF

Standby mode is intended for staying in a harbour, when you need to switch off audible alarms from the ECDIS. To switch **Standby mode ON**, you have to proceed as follows:



1. Press INITIAL SETTING button.
2. Select Standby from the menu.
3. A following window appears top on ECDIS display to indicate that audible alarms are switched off.

Set time
Parameter Backup Digitizer Backup and Restore
Installation parameters Navigation parameters ▶ Chart Alarm parameters Optimization parameters ▶
Print Navigation parameters ▶
Print Optimization parameters ▶
Selftest
Standby
Presentation library
Access Server and Diagnostic ▶



To switch **Standby mode OFF**, press "BACK TO NORMAL MODE" button.

This page is intentionally left blank

Set up before departure

Update Chart material

Update your ARCS and S57 chart material before departure to a new voyage. To get more information about updating ARCS charts, see Chapter "Raster Charts" and about updating S57 charts, see chapter "S57 vector charts".

Note that if you have an installation with a back-up station, you can make a backup of your chart to back-up station in an easy way, see Chapter "Backup of chart material".

Display and Approve date for S57 charts and manual updates

NOTE! It is very important that you set Display and Approve date for S57 charts as current date.

There may be features which are Date dependent or periodical in S57 charts, therefore if you not have set Display and Approve dates as current date there is possibility that you may have wrong presentation or some feature may completely be absent. To get more information about to set Display and Approve date, see Chapter "Date dependent and periodical features of S57 chart".

Create or update User chart

If it is necessary, create a new User chart or modify existing one for a new voyage. To get more information about User chart, see Chapter "User Chart Control".

Create or update Reference targets

If it is necessary, create a new Reference targets file or modify existing one for a new voyage. To get more information about Reference targets, see Chapter "Reference targets" in ECDIS EC 1000 Operators Manual.



By pressing this button a following menu appears

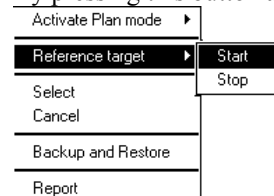

If you have made a Reference target (min. 8 fix points), activate Monitor mode and then select **Reference target > Start** to activate this function. After this Reference target is one of the position sensors. For more information, see chapter "Reference Targets".

Create or update Pilot data

If it is necessary, create a new Pilot data or modify existing one for a new voyage. To get more information about pilot data, see Chapter "Pilot Data".

Set Chart Alarm calculation

Set Chart Alarms areas suitable for your coming voyage. For more information, see chapter "Chart Alarms".

To open Chart Alarms window, press INITIAL SETTING button and select **Chart Alarms Parameters** from the menu.

Chart Alarms Parameters Chart Alarms

Chart Alarms Sector

Time Min

Angle °

Chart Alarms Parameters Chart Alarms

Ignore

Specially Protected Areas
User Chart Danger Area
Traffic Separation Zone
TRS Crossing/Roundabout

Indication Alarm

Indication

Areas To Be Avoided

Ignore Alarm

Alarm

Safety Contour
Restricted Area

Ignore Indication

Set Depth alarm limit for Echo Sounder



To change Depth alarm limit take cursor to Echo alarm depth edit box and press SELECT button..

Chart display - ALL-ON

ARCS details Tracking Mariner Route

Chart	Standard	Other
Echo alarm depth	<input type="text" value="5"/>	m
Shallow contour	<input type="text" value="10"/>	m
Safety depth	<input type="text" value="30"/>	m
Safety contour	<input type="text" value="30"/>	m
Deep contour	<input type="text" value="50"/>	m

Use **Echo alarm depth** to set the Depth alarm limit for Echo Sounder.

Note, that the ECDIS will alarm based on information received from Echo Sounder. This is an option which is not available with all installations.

Create or update Route



By pressing ROUTE PLAN button twice a following menu appears. Use this menu to select a route for Planning.

Select
Cancel
Create
Exchange with Monitored
Copy from Monitored
Backup and Restore
Report
Full WP Report
Passage Plan Report

If it is necessary, create a new route or modify existing one for a new voyage. To get more information about creating or updating a route, see Chapter "Route Planning".

Check your route against Chart Alarms

Before you sail your route, you should always check your route again for Chart Alarms. This is important because your S57 charts and manual updates may contain any amount of date dependent information. Check of Chart Alarms can be done on **Check** page. Following information is stored with the Route during Route Plan:

- Conditions for Chart Alarms during Route Monitoring, which includes Safety contour and other Chart Alarms.
- Name of the User Chart planned to be used during Route Monitoring together with this Planned Route
- Name of the Pilot Data planned to be used during Route Monitoring together with this Planned Route

PLAN ROUTE - TOKYOYBAY / 31.08.2001 10:23

WP | Alarms | Check | Params | Prepare

Legs: Alarms:

Leg:

Alarms:

Alarm:

Legs:

Planned User Chart

Planned Pilot Data

This route has not been checked

PLAN ROUTE - TOKYOYBAY / 31.08.2001 10:23

WP | Alarms | Check | Params | Prepare

Legs: 8 Alarms: 4

Leg:

Alarms:

Safety Contour

Alarm:

Legs:

Planned User Chart

Planned Pilot Data

When **Start** button is pressed selections of Alarms page is stored. Also name of User Chart and name of Pilot Data which were selected as Plan mode are stored in this Route.

Recalculate timetable and ETA values

Recalculation can be done on **Params** page. Set at least ETD to correspond departure time and perform desired optimization.

Set at least ETD to date and time edit box in ETD/UTC field to correspond departure time.

PLAN ROUTE - TOKYO/BAY / 30.08.2001 10:26

WP	Alarms	Check	Params	Prepare
Description				
ROUTE DRAUGHT LESS THAN 8 M				
ETD/UTC+ 3				
WP	1	30 Aug 01 09:49		
ETA/UTC+ 3				
WP	12	31 Aug 01 20:00		
31 Aug 01 20:00				
Total Length: 94.6 nm				
Speed limit		Max. power		
20.0	Kt	100	%	
Optimize		Income		
Time table		5.000 x1000\$		
<input checked="" type="checkbox"/> Enable changes		Partly Displayed		

After check of Chart Alarms and set of ETD, cancel selection of the Planned Route in order to enable the selection of it for route to be monitored. Use **Cancel** from above menu to do it or use **Exchange with Monitored** to select it directly as Monitored Route.

Check and prepare Route to be monitored

Select a route for the next voyage; double click Route monitor push button and select recalculated route. For more information selection of route, see Chapter "How to select route to be monitored".

The screenshot shows the 'ROUTE MONITOR' window with the following content:

- Monitoring** | Alarms | Selections | Waypoints
- To**
WP 5 Max speed
KISARAZU
- ETA**
WP 8 ETA 04 Feb 03 12:05
URAGA Distance 15.6 nm
- Final**
WP 9 ETA 04 Feb 03 12:12
PILOT Distance 18.0 nm
- Suggested speed min Kt
- Trial speed 0.0 Kt
- Speed profile Plan
- Center line Off for ARPA
- Channel borders Off radar
- Checked conditions are different

If text "Checked conditions are different" appears to window, it indicates that conditions selected during Route Planning were different than conditions selected to be used during Route Monitoring, for more information to use Checked conditions, see chapters "Use Checked conditions of the Route Plan" on page 56 and "Use planned User Chart" on page 56.

Select To Waypoint

The system selects To waypoint automatically, check that it is correct one. Note that waypoint number 1 is not accepted. Use above menu to do it.

Select Final Waypoint

This selection is used ONLY in case that the last waypoint should be different to that one defined last in your route. If needed use above menu to do it.

Center line for ARPA radar

Select ON to display the center line of the route on the radar display. Displayed part of the route consists of one leg before next waypoint and four legs after that. Select OFF to disable display of the center line on the radar display.

NOTE! This option is available with selected ARPA radar models.

Channel borders for ARPA radar

Select ON to display the channel limit lines of the route on the radar display. Displayed part of the route consists of one leg before next waypoint and four legs after that. Select OFF to disable display of the channel limit lines on the radar display.

NOTE! This option is available with selected ARPA radar models.

Use Checked conditions of the Route Plan

You can check on **Alarms** sheet if checked conditions are used with the route during monitoring..

If text "Current selection is different" is displayed, press **Use** button to select used condition during monitoring as planned. (Differences between used and planned conditions are displayed with (*) marks).

MONITOR ROUTE - TOKYO8AY / 03.02.2003 15:18

Monitoring | Alarms | Selections | Waypoints

Planned as

Ignore during monitoring

- * Areas To Be Avoided
- Traffic Separation Zone
- TRs Crossing/Roundabout

Indication during monitoring

- * Specially Protected Areas
- Restricted Area
- Caution Area

Alarm during monitoring

- Safety Contour
- User Chart Danger

Safety contour * 8 m Use

* = Current selection is different

Use planned User Chart

To check if planned User Chart is selected, open **Selections** sheet to check that you have correct User Chart in Monitoring Mode.

If text "Current selection is different" is displayed, press **Use** button to select User Chart as Monitor Mode.

If text "This has been changed after Route Planning Check", Re-check your Route against Chart Alarms.

MONITOR ROUTE - TOKYO8AY / 03.02.2003 15:18

Monitoring | Alarms | Selections | Waypoints

Planned User Chart TOKYO Use

Current selection is different

Planned Pilot Data TOKYO Use

Current selection is different

MONITOR ROUTE - TOKYO8AY / 03.02.2003 15:18

Monitoring | Alarms | Selections | Waypoints

Planned User Chart TOKYO

This has been changed after Route Planning Check

Planned Pilot Data TOKYO Use

Current selection is different

Use planned Pilot Data

To check if planned Pilot Data is selected, open **Selections** sheet to check that you have correct Pilot Data in Monitoring Mode.

If text "Current selection is different" is displayed, press **Use** button to select Pilot Data as Monitor Mode.

Text "This has been changed after Route Planning Check" reminds you that Pilot Data has been modified after Route Planning Check.

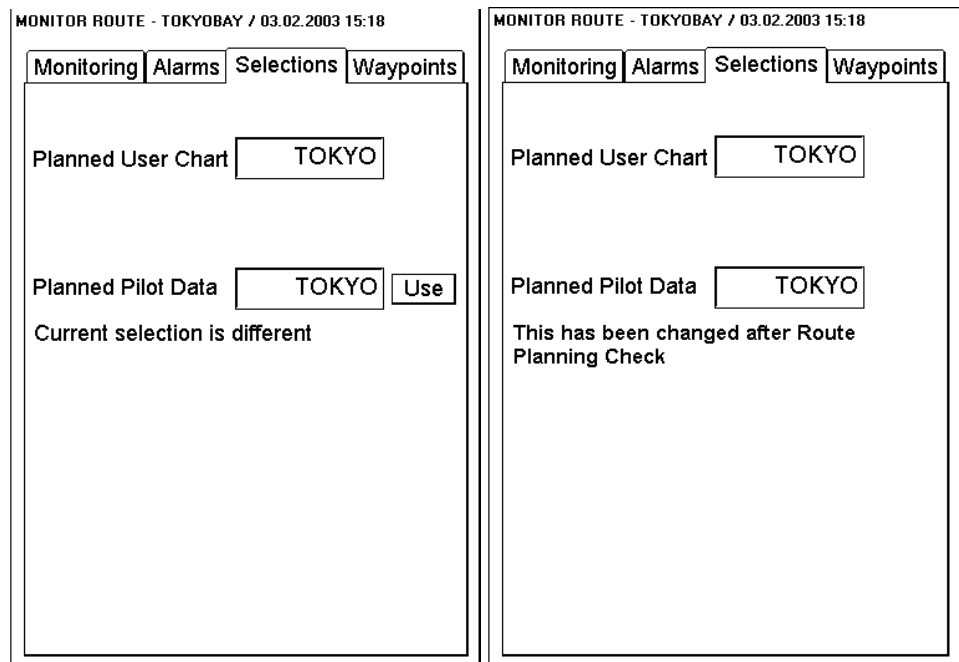

Verify configuration of navigation sensors

User can select navigation sensors used in navigation and view their current values.

Checkbox status shows whether to use the sensor for integrated navigation or not. If there is no value with sensor it indicates that sensor is not valid. Note, that content of these sheets is depending on sensors which are in use on the ship.



*SENSORS
push button
To select
between
Speed/Course
and Position
sheets to be
opened either
press button*



*or go by
cursor above
Speed/Course
or Position text
and press
SELECT*

SELECT SENSORS - Source: STBD ECDIS			
Speed/Course	Pos	Other	Record
<input type="checkbox"/> Manual speed			Kt
<input checked="" type="checkbox"/> Log			16.9 Kt
<input checked="" type="checkbox"/> Dual log (bottom)	> ^	0.0 Kt 16.9 Kt	
<input type="checkbox"/> ARPA			16.9 Kt 257.5 °
<input type="checkbox"/> Manual heading			°
<input checked="" type="checkbox"/> Gyro 1			257.3 °
<input checked="" type="checkbox"/> Gyro 2			257.3 °
<input checked="" type="checkbox"/> Rate gyro	(calc.)		-2.0 °/min

Verify source of navigation sensors

In a multiple Workstation environment verify that Sensor source indicated Initial Setting is the intended one.

Verify SPEED settings

Select both LOG and DUAL LOG, if they are available. Or select one of them.

Note that MANUAL SPEED should be used in only emergency state when no other speed reference is available. Remember that position sensors are also available as speed reference sources.

Verify RADAR settings

If LOG and DUAL LOG are not available, you can use radar as source for speed and course.

Verify GYRO settings

Select GYRO1 or GYRO2. Note that in typical installation GYRO1 is connected to a traditional gyro compass, while GYRO2 receives gyro value from either Trackpilot or a DGPS sensor.

Note that MANUAL heading should be used in only emergency state when no other heading reference is available.

Rate gyro is always automatically selected.

Verify POSITION sensors



*SENSORS push button
To select between
Speed/Course and Position
sheets to be opened either
press button*



*or go by cursor above
Speed/Course or Position text
and press SELECT*

SELECT SENSORS - Source: STBD ECDIS

Speed/Course	Pos	Other	Record
<input type="checkbox"/> Alignment	Start		
<input type="checkbox"/> Enable chart align	Range 0.0 nm	Bearing 0.0°	
<input type="checkbox"/> Dead reckoning	Lat 60°04.726N	Lon 024°48.089E	
Kalman filter	Off		
10.0Kt 243.2°	Lat 60°04.693N	Lon 024°47.970E	
GPS1	Primary	Diff	
10.0Kt 243.2°	Lat 60°04.729N	Lon 024°48.099E	
GPS2	Secondary		
10.0Kt 243.2°	Lat 60°04.680N	Lon 024°47.924E	

The data field of a position sensor contains a label (here GPS1, GPS2) which indicates the type of the sensor, **Primary-Secondary-OFF** status that indicates, if the sensor is included or not, position in local datum, speed and course. A DGPS position sensor has additional text **Diff**, if differential signal is in use.

Position sensors have priority, which is indicated using Primary and Secondary. Only one sensor can be primary while the others can be secondary or off position. After OFF-state a position sensor is changed to secondary-state. After secondary-state a position sensor is changed to primary-state and if there was already a position sensor with primary-state it will be changed automatically to secondary-state.

SWITCH "Primary" THAT SENSOR WHICH IS CONSIDERED TO BE MOST RELIABLE.

SWITCH "Secondary" OTHER SENSORS.

Verify KALMAN FILTER

The Kalman filter is an automatic process that will calculate the most probable position based on all position sensors. The filter uses in its process all sensor that has not OFF as selection. For more information about Kalman Filter, see Chapter "Filter operation".

Verify ALIGNMENT

The alignment is a correction given by the Chart Align function. It is used to move vessel "Correct" position if position devices define "incorrect" position. Normally switch OFF in the start up procedure. For more information about alignment, see Chapter "How to use position alignment".

Reset Distance and Trip Counters



Use this button to open
Voyage record menu.

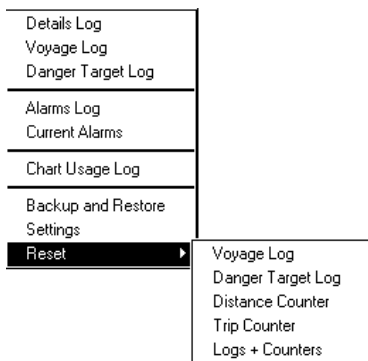

Press **Voyage Record** push button and select **Reset Trip Counter** and **Reset Distance Counter**.

Verify Datum

Datum is used to select between different models of the earth. It is essential that you use Datum in a consistent way.

If you use paper charts together with electronic chart material, it is recommended that you use the same Datum as your current paper chart to avoid misalignment between your electronic system and points taken or plotted on your current paper chart.

Once you have selected a datum, all numerical latitude-longitude position values are presented in your selected datum.

Note: ARCS raster charts contain some rasterized position information, like scales in the edges of ARCS charts, which is true only if you have selected native datum of that ARCS chart.

To select datum proceed as follows:



1. Press **Initial setting** push button.
2. Select desired datum from a list box of **Datum**.
3. Selected datum is shown on the Upper information area.

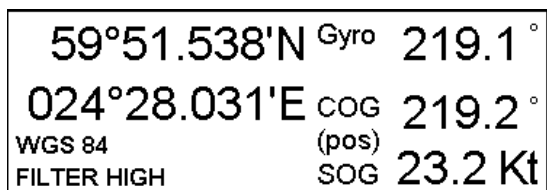

Selected datum is shown on Upper information area (in this case WGS 84).

Conditions required to replace paper charts

Introduction

Carriage requirement for adequate and up to date charts for intended voyage can be found from SOLAS Chapter V/20 of the 1974. In resolution A.817(19) IMO has specified how requirement of the V/20 of the 1974 can be fulfilled with a device called ECDIS. In resolution A.817(19), Appendix 7 (RCDS 1998) IMO has specified how requirement of the V/20 of the 1974 can be fulfilled when an ECDIS uses RCDS mode. The traditional alternative way to fulfil requirements of the SOLAS chapter V/20 of the 1974 has been the use of paper charts.

If you use type approved version of this ECDIS (BSH type approval certificate number 6579 / 080 138 / 99. If in doubt, contact your supplier of the ECDIS to check the status of your system) and if following conditions are met, then your system fulfils IMO A.817(19).

- own ship area is covered with updated ENC charts
- your selected display area is covered with updated ENC charts
- you have a backup system which fulfils IMO A.817 requirements. One example is a second ECDIS

Note that ENC producers provide their conditions of use in the Publisher notes, which you should read always when loading new material into the ECDIS. See chapter "How to load S57 charts from a CD-ROM, floppy or LAN" on page 73.

In areas where ENCs are not available raster chart material called ARCS from UK HO can be used in the ARCS mode of this ECDIS, if following additional conditions are met:

- own ship area is covered with updated ARCS charts
- your selected display area is covered with updated ARCS charts
- appropriate folio of up-to-date paper chart is carried onboard and available, if required by your flag country administration

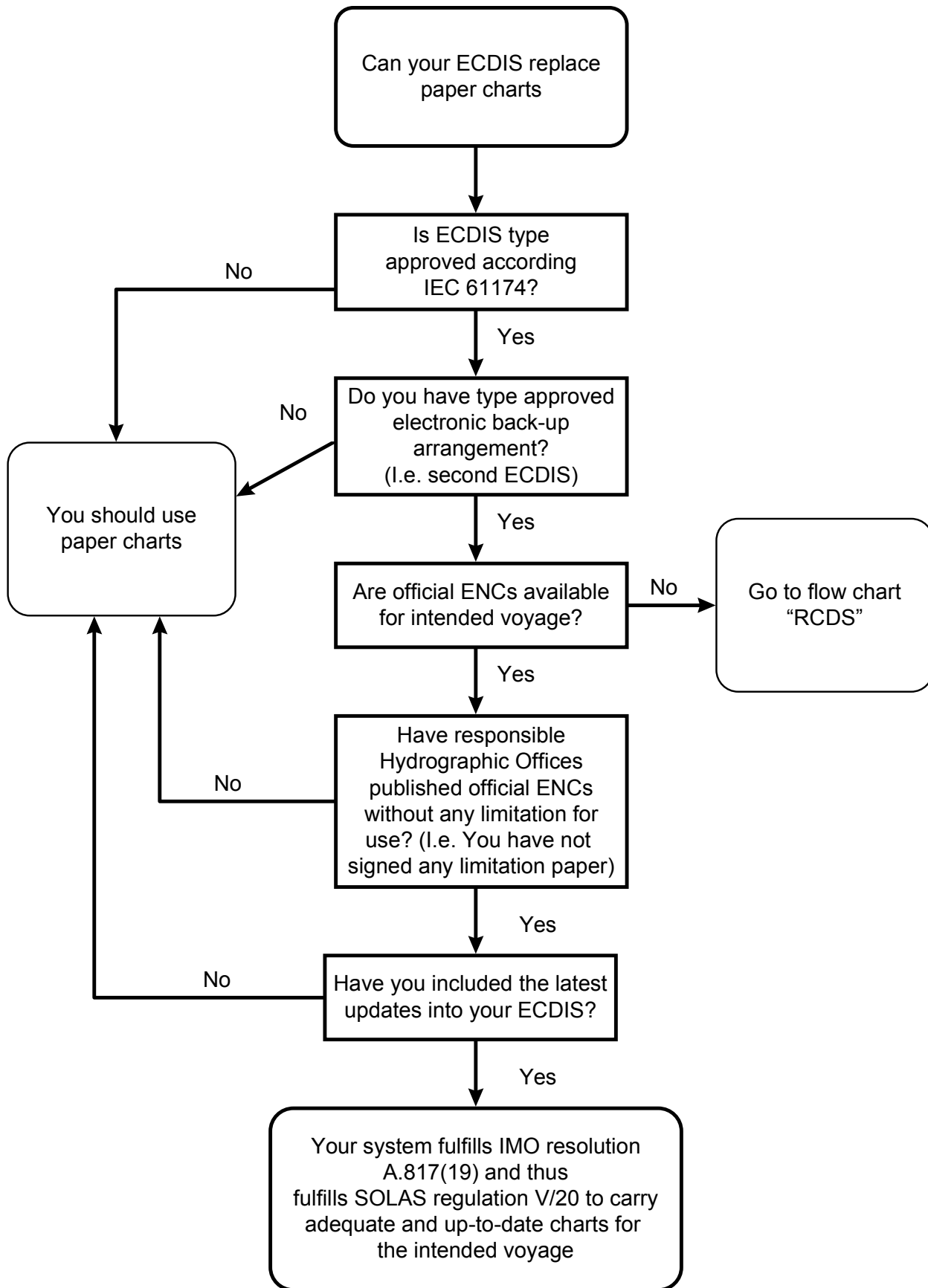

Data flow chart for replacing paper chart with ENC chart material

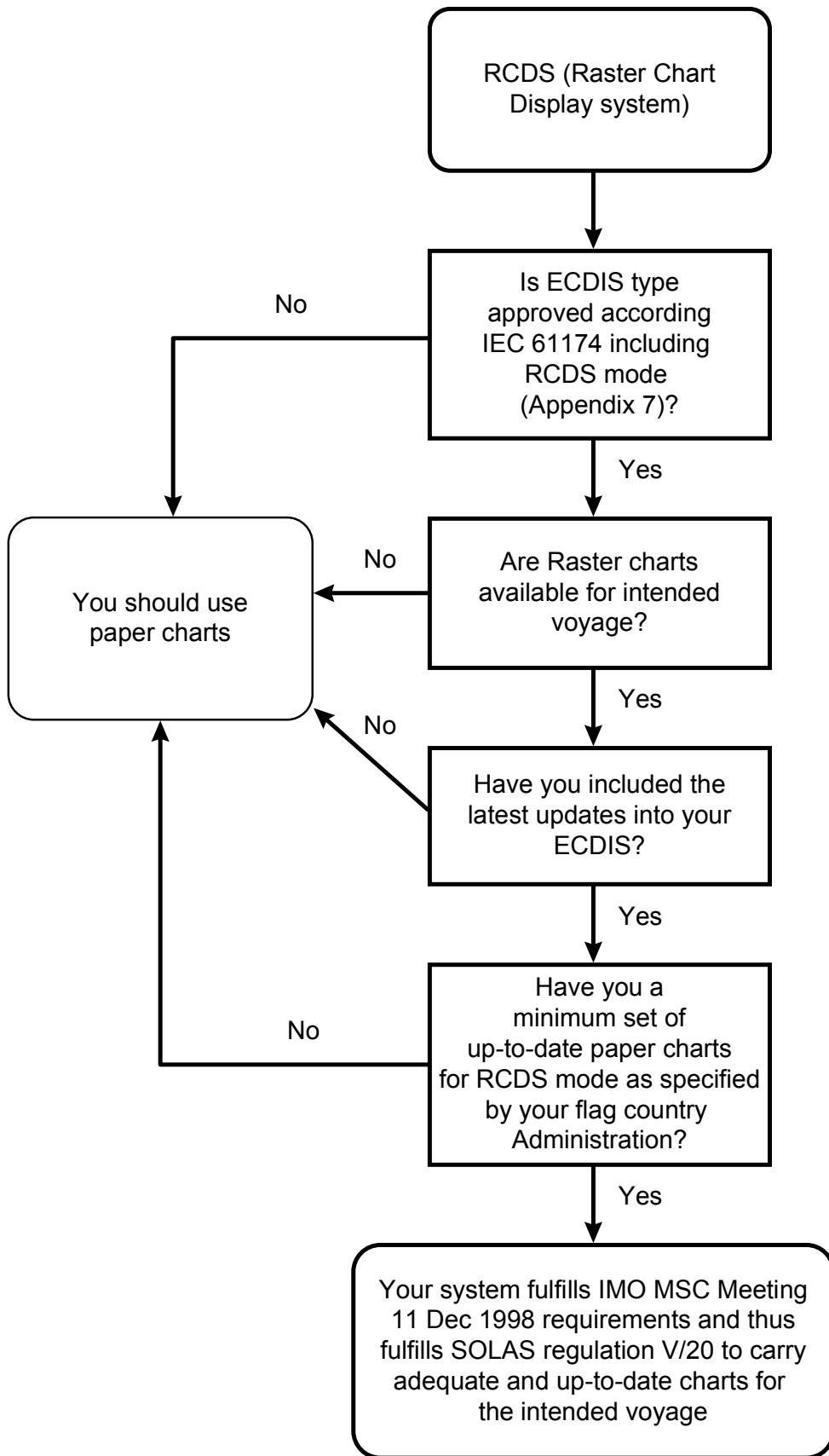

Data flow chart for replacing paper chart with Raster chart material

How to detect ENC coverage in S57 Chart display

This Electronic Chart System has capability to show more than one S57 Chart cell at the same time. This feature is called multi cell display. If one S57 Chart cell does not cover the whole display the system will open more S57 Chart cells to be displayed, if they are available in displayed area. The Upper Status bar shows information about S57 Chart cells displayed on the Electronic chart display area. When automatic TM reset is active, the information is displayed from position of own ship. When automatic TM Reset is OFF, then the information is displayed from current position of cursor.

The list of possible indications:

Pilot Data	Depth Metres	Height Metres
ARPA 1 Radar	RCDS Mode	Ship off

RCDS mode: Raster chart material is displayed on electronic chart display area.

Pilot Data	Depth metres	Height metres
ARPA 1 Radar	Non ENC Data	Ship off

Non ENC Data: The S57 Chart at cursor location is not official ENC material.

Pilot Data	Depth metres	Height metres
ARPA 1 Radar		

No indication: The S57 Chart at cursor location is official ENC material

Areas which are covered by legal ENC data are indicated with ENC coverage symbol (This symbology is used by IHO S-52 Ed. 3.2. or earlier Presentation Library). See following examples.

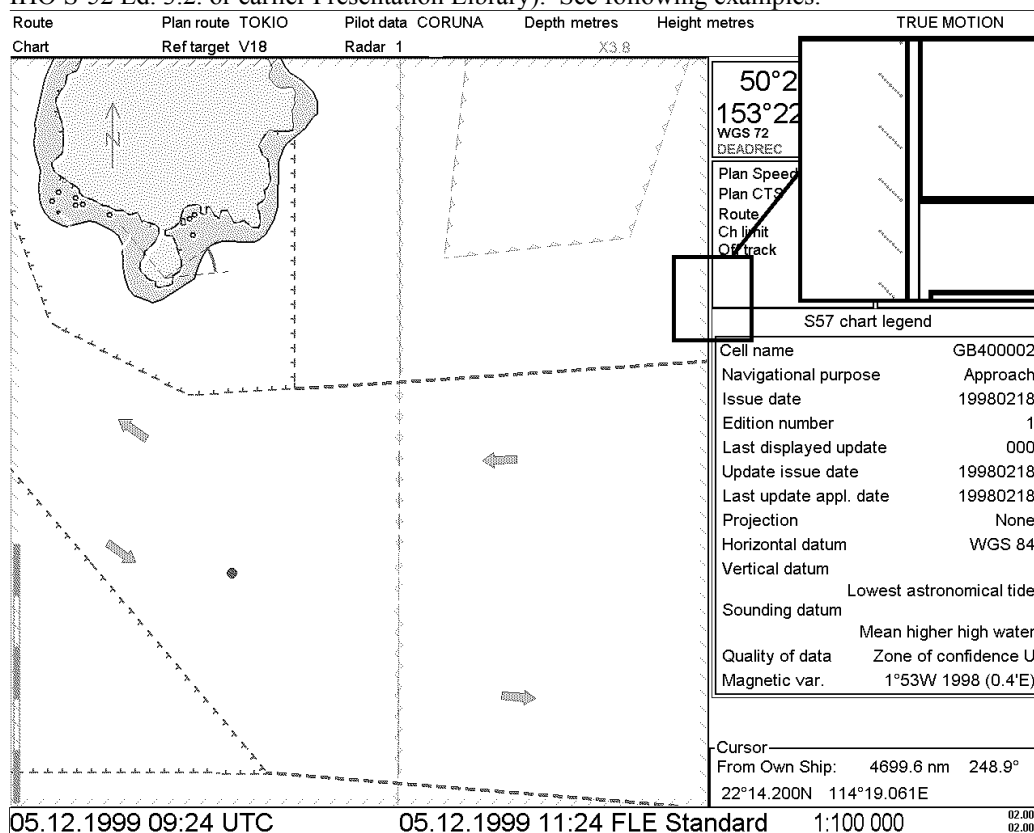

Full ENC coverage.

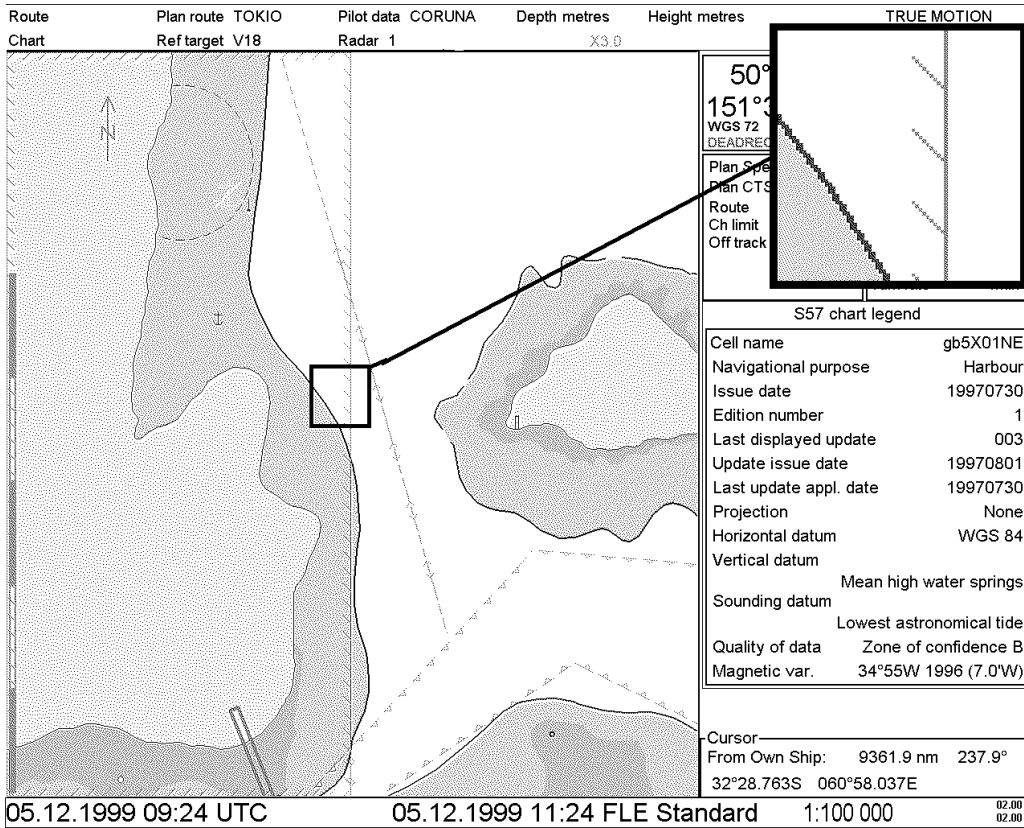

Partial ENC coverage.

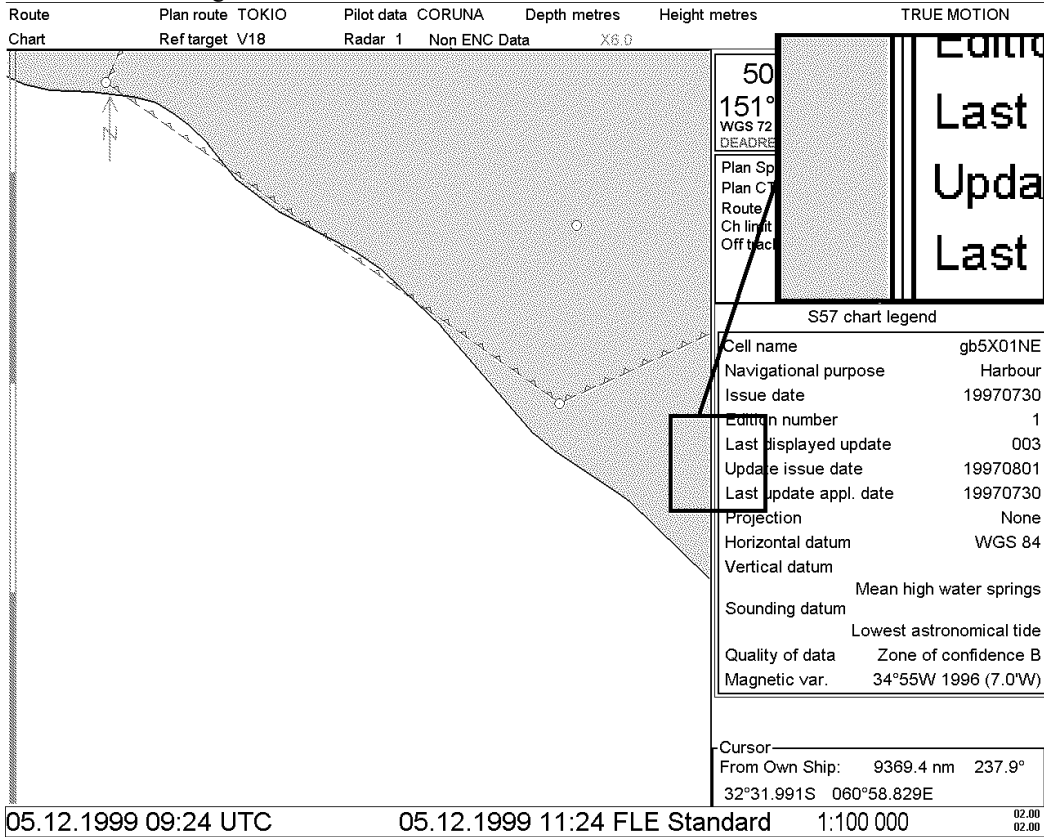

No ENC coverage.

This page is intentionally left blank

Vector Chart material

Introduction

Theoretically a chart can be coded for computer as raster or vector chart. There is a special chapter for raster coded charts in this manual. Vector coded charts can be coded using different techniques. One technique is called S57ed3 and this technique has been selected by IMO as the only alternative for SOLAS compliant electronic charts. If a S57ed3 coded chart is published by government authorised Hydrographic Office, then it is called ENC. If a S57ed3 coded chart is published by private industry, then it is called as NON ENC. Another technique is known as CM-93/2. It is used by private company C-MAP to publish electronic charts. All CM-93/2 charts are NON ENC. There is a special chapter about C-MAP charts in this manual. You can read more about ENC and related legal issues in chapter "Conditions required to replace paper charts". Later in this manual all references to Vector Chart material are under name S57 Charts regardless of the source of them.

Sometimes you may wish to add manually Notices to mariners or Navtex warnings into your S57 charts. In this system this kind of things are called as Manual Updates. Manual updates are valid for both S57 and ARCS charts so that you need to define them only once. Also manual updates are valid for all scales so that you don't need to repeat them for charts published in different scales from the same area. See more details in chapter "Manual Updates" .

S57 Charts

Introduction

This Electronic Chart System is compatible with official IHO S57 release 3 chart material produced by Hydrographic offices (HO). This material, when issued by government authorised Hydrographic Office, is called ENC (electronic navigational chart). Use, presentation and display of S57 charts are based on International Maritime Organisation (IMO), International Hydrographic Organisation (IHO) and International Electrotechnical Commission (IEC) regulations and rules (S52ed3.1). When this ECS (Electronic Charts System) uses ENC (S57 release 3 chart produced by a government authorised Hydrographic Office), it is an ECDIS as defined by IMO, IHO and IEC.

An ENC could be encrypted to prevent unauthorised use and then the user needs a permit to view the ENC. This permit could be entered manually from control panel or loaded from a floppy disk.

Before any ENC can be used in the ECDIS, it is loaded into the hard disk and converted into the system's own internal format (SENC). Some parts of the charts may be date dependent i.e. they are visible after a set date or they are visible only for a limited period etc. In this Electronic Charts System you control all date dependent objects with Display Until and Approve Until dates. In paper chart world the Preliminary and Temporary Notices to Mariners represent the date dependency described above for S57 charts.

An important part of ENCs are the updates. Hydrographic Offices can issue two kinds of updates:

- incremental updates, which are small additions to original base cells
- reissues and new editions, which are complete replacements of previous base cells and their updates

All updates are date stamped and they may also contain date dependent parts. You control also usage of updates in this Electronic Charts System from Display Until and Approve Until dates. Using Display Until and Approve Until dates you can view your charts correctly drawn on any date in the past or in the future.

Chart material will be available stored in media such as CD-ROMs and floppies or electronically from LAN (Local Area Network) in which it could have arrived from RENCs, CD-ROMs or floppies. Such material can contain only basic cells, cells and updates or only updates. This Electronic Chart System contains as standard delivery the software to access CD-ROMs, floppies and LAN.

Each S57 chart may contain beside the chart itself links to additional textual descriptions or pictures. Typically additional textual descriptions and pictures contain important sailing directions, tidal tables and other traditional paper chart features, which do not have any other method to be included into the S57 chart. This ECDIS copies these textual descriptions and pictures into its hard disk and allow you as user to cursor pick them for viewing purposes.

An appendix of this manual provides short introduction for interpretation of S57 ENC chart display.

Definitions of terms

- Cell** A cell is a geographical area containing ENC data. Each cell has separate unique name. Hydrographic Offices divide their responsibility area into the cells which they publish.
- S57 chart** A database, standardized as to content, structure and format, issued for use with ECDIS without any authority of government authorized Hydrographic Office. The difference of S57 chart and ENC is that non-ENC charts require complete up-to-date paper charts to be used as primary aid of navigation.
- ENC** A database, standardized as to content, structure and format, issued for use with ECDIS on the authority of government authorized Hydrographic Offices. The ENC contains all the chart information necessary for safe navigation and may contain supplementary information in addition to that contained in the paper chart (e.g. sailing directions) which may be considered necessary for safe navigation. The name of coding standard for ENC is S57ed3.
- SENC** A database resulting from the transformation of the ENC by ECDIS for appropriate use, updates to the ENC by appropriate means, and other data added by the mariner. It is this database that is actually accessed by ECDIS for the display generation and other navigational functions, and is the equivalent to an up-to-date paper chart. The SENC may also contain information from other sources.
- RENC** A service provider offering ENC delivery and update service as defined in IHO standard S52e3. Often a RENC provides CD-ROM based service to ECDIS users. One example of a RENC is the RENC in Stavanger operating under marketing name PRIMAR-Stavanger.

Chart legend of S57 chart

CHART LEGEND is not a pushbutton, but it is a front-page, which is displayed as a base. If you push CANCEL enough you will finally get CHART LEGEND.

This system is capable to show more than one S57 Chart at the same time. This feature is called multi chart display. If one S57 Chart does not cover the whole display, the system will open more S57 Chart to be displayed, if they are available in displayed area. The Chart Legend shows information about S57 Charts displayed on the Electronic chart display area. The information is displayed from position of own ship, if automatic TM reset is active or from current position of cursor, if automatic TM Reset is OFF.

S57 chart legend	
Cell name	FI4EIIQR
Navigational purpose	Approach
Issue date	20010201
Edition number	1
Last displayed update	019
Update issue date	20010724
Last update appl. date	20010201
Projection	Mercator
Horizontal datum	WGS 84
Vertical datum	
	Approximate mean sea level
Sounding datum	
	Mean lower low water springs
Quality of data	Zone of confidence A1
Magnetic var.	
Depth	metres
Height	metres

Cell name:

Name of chart.

Navigational purpose:

S57 Charts are compiled for a variety of navigational purposes. The navigational purpose, for which an individual S57 Chart has been compiled by a Hydrographic Office, is indicated in this field. Alternatives are: Overview, General, Coastal, Approach, Harbour and Berthing

Issue date:

Issue date of the base cell of the chart.

Edition number:

Edition number of the chart.

Last displayed update:

Number of last update, which is visible on the chart screen.

Update issue date:

Issue date of last update, which is visible on the chart screen

Last update appl. date:

Date to which the last update, which is visible on the chart screen, is effective.

Projection:

Projection of the chart. The projection is always Mercator.

Horizontal datum:

Horizontal datum of the chart data as published by the producer of it. By definition this must be WGS 84.

Vertical datum:

Vertical datum of the chart.

Sounding datum:

Datum used for soundings.

Quality of data:

This is a quantitative estimate of the accuracy of chart features given by chart producer.

Magnetic var.:

Amount of magnetic variation. A positive value indicates a change in an easterly direction and a negative value indicates a change in a westerly direction.

Depth:

Indication of used measurement units of depth.

Height:

Indication of used measurement units above sea level (for example clearance height).

Permanent warnings of S57 charts

Permanent warning help you to keep the S57 charts up-to-date. Only up-to-date S57 charts can be legal replacement of the paper charts. Permanent warnings indicate, if the system detects a condition which may cause your system to use not up-to-date charts.

NOTE! The system can powerfully assist you to keep your charts up-to-date for the charts which you have got from a RENC. For charts which has been loaded from other sources than a RENC, the system is unable to know the exact up-to-date situation.

See more details in chapter "Date dependent and periodical features of Vector chart".

You have loaded updates into the hard disk, but these updates are not included into the SENC. This kind of charts are drawn in orange colour in the Chart Plan - Catalogue.

Perform SENC conversion for these charts. See more details in chapter "How to use SENC convert window to initiate SENC conversion".

See more details in chapter "How to know up-to-date status of the RENC Product List".

You have loaded an update which contained cancel information for a chart. You selected not to remove the canceled chart. This permanent indication reminds you about your intended use of a canceled chart.

Consider removal of the chart. See more "How to remove S57 Charts from the system" on page 95.

Permanent Warning

At least one of used charts has more than 1 week between "Approved Until" and/or "Displayed Until" and current system date. Use Chart Plan - Date Dependent to set dates

Permanent Warning

At least one of used charts is not up-to-date. At least one update is loaded in harddisk, but not in SENC format. Use Chart Plan - Catalogue to check charts

Permanent Warning

At least one of used charts is not up-to-date. Get or load latest edition and/or updates from your RENC service. Use Chart Plan - Date Dependent to check charts

Permanent Warning

At least one of used charts is canceled. Use Chart Plan - Catalogue to check charts. Use Chart Plan - Remove to remove canceled chart.

How to load S57 charts

Flow chart of the loading of S57 Charts into ECDIS

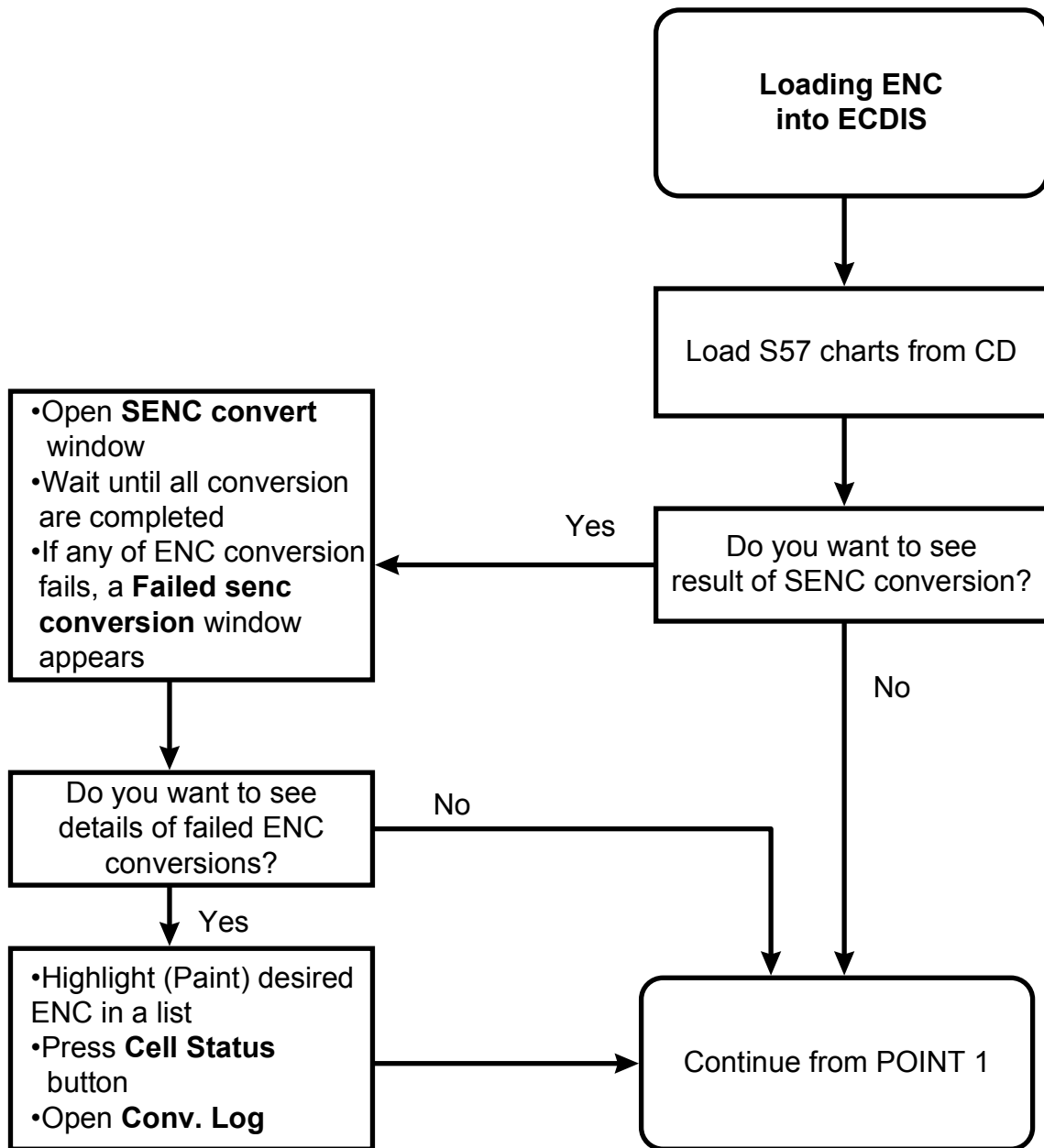

Data flow chart, How to load S57 charts into ECDIS.

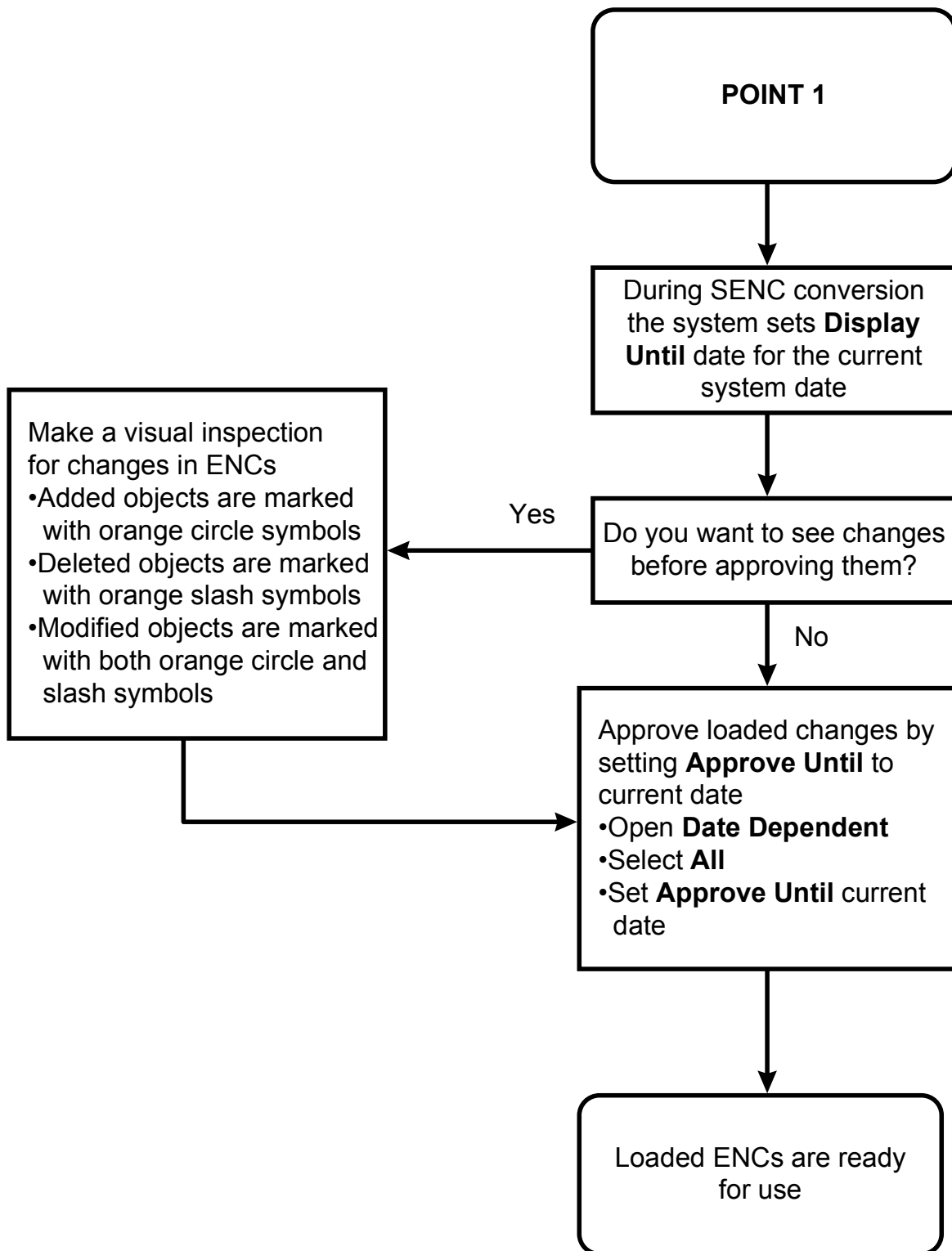

Data flow chart continue, How to load S57 charts into ECDIS.

How to load S57 charts from a CD-ROM, floppy or LAN

When you load S57 charts by CD Catalogue, the system first load a CD catalog, which stores certain information into the hard disk such as cells ID, their position, edition number, from your LAN (Local Area Network) connection, floppy or CD-ROM. After that the system asks which charts will be loaded from the selected media.

After building the CD catalogue you can view the contents of it using S57 catalogue command.

Note: All CD-ROMs, floppies or LAN (Local Area Network) connections from one single National Hydrographic Office have equal names although their contents could be totally different. You can use your own unique names to identify them separately and correctly later.

To load by CD catalogue proceed as follows:

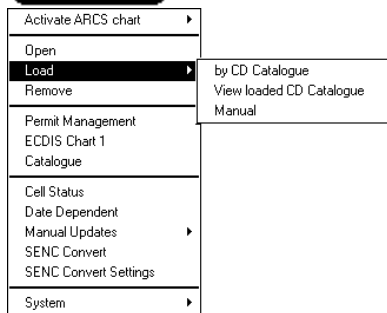
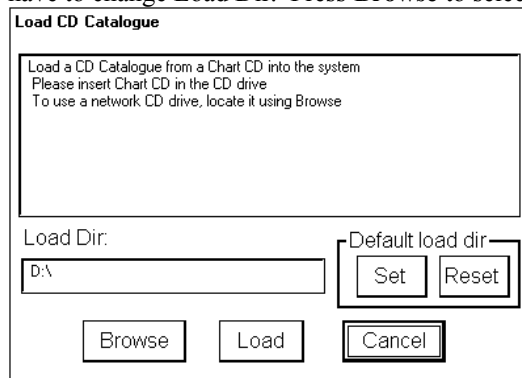
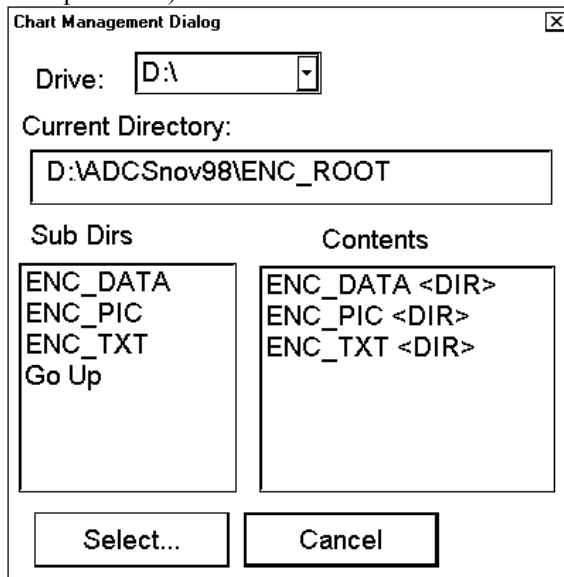

CHART PLAN push button

1. Press CHART PLAN push button.
2. Select **Load** from the menu and **by CD Catalogue** from the sub menu. A Load CD Catalogue dialog box appears. The default load source is CD-ROM. Press **Load** and continue from step 5, if you use CD-ROM. If you want to load from a floppy disk or from another ECDIS using LAN, you have to change Load Dir. Press **Browse** to select a new Load Dir



3. If you use a floppy disk, select **A:** in **Drive:**. If you use another ECDIS using LAN, select suitable **Drive:** and **Sub Dir**. Note that a correct load source has "\ENC_ROOT" in the end of the **Current Directory:** (see example below).



Press **Select** when you are ready.

4. You return back to S57 Load dialog. Press **Load** .

Note, if you are loading PRIMAR official ENC service Base CD or Update CD, the ECDIS will automatically give name "PRIMAR" or "PRIMARUPD" for CD Catalog and you can continue step 7.

5. A keyboard dialog box appears. Enter name for CD Catalog and press **OK**. System will load catalog information into the hard disk.

6. The system automatically copies all Text and Pictures files associated with Charts from a CD Catalogue. The system keeps only the latest version of these. If your system had already in use newer Text and Picture files you will get the notice below.

7. Following dialog box appears

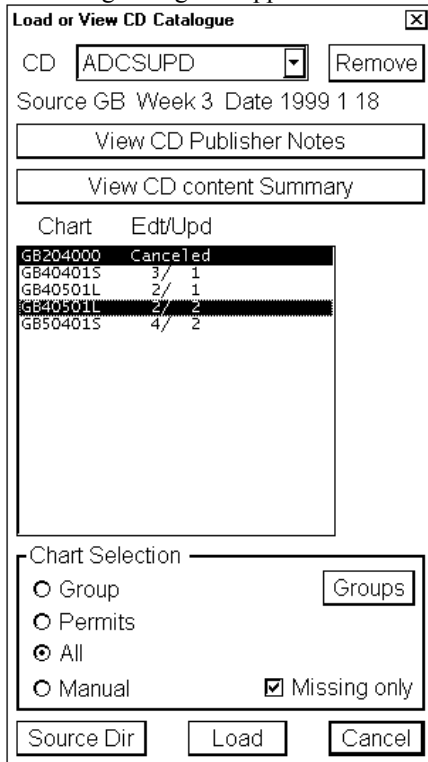

Select a named "CD" you want to load from CD -field. A list of charts appears into a list box which contains information about charts (edition and update number). In a **Chart Selection** you can choose, which charts are loaded from the CD-ROM. Selection "**Missing only**" loads only Charts and their updates which are not already loaded into the ECDIS.

Note, If you want to remove loaded CD Catalogue, select desired CD from the list box and press **Remove** button.

8. Press **Load** button to load selected charts.
9. If any of chart conversion fails, a **Failed SENC conversion** window appears, which has a list of failed conversions. Use this window to find out the reason for failure. For more information, see chapter "How to use Failed SENC conversion window" on page 82.
10. If you want to view the progress of SENC conversion, you can activate the **SENC convert** window. For more information, see chapter "How to view progress of SENC conversion" on page 81

NOTE 1! If you want to make chart selection by group, press **Group** button and select desired group. If in selected group and list of charts have common charts, they are highlighted in the list box.

NOTE 2! If your system has LAN (Local Area Network) and you want load your charts from another drive than your system CD-ROM drive, press **Source Dir** button. Then you can define drive and path from where you load your charts.

NOTE 3! The System can make conversion into the SENC and set the "Display Until" date automatically. This is the recommended way. More information to set them, see chapter "How to select automatic SENC conversion and Display Until date" on page 80.

NOTE 4! You should read the text file associated into each catalog. The text file typically contains **very important notices for the usage of the charts from the producing Hydrographic Office**.

1. Press **View CD Publisher Notes** button in the S57 Load dialog box.
2. A viewer shows you the Publisher Notes of the selected "CD".
3. If you want to make a hard copy of Publisher Notes, select **Print** in the **File** menu.
4. To close this program, select in **Exit** in the **File** menu.

NOTE 5! You can view the Summary of the content of the CD. It contains information about charts you are going to load.

1. Press **View CD content Summary** button in the S57 Load dialog box.
2. A viewer shows information about the selected "CD". Each row contain:
 - CellID Name of the chart
 - Edition Edition number of the chart
 - Base Included update number and issue date of base cell of the chart
 - First Update Update number and issue date of the first update included
 - Last Update Update number and issue date of the last update included
3. If you want to make a hard copy of the Summary of Catalog, select **Print** in the **File** menu.
4. To close this program, select in **Exit** in the **File** menu.

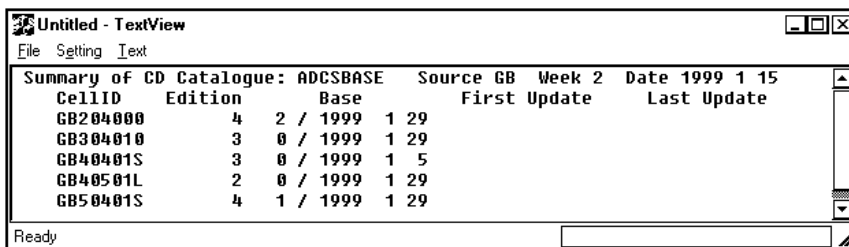

The example above contain only base cells and reissues of the charts. Charts GB204000 and GB50401S are called as reissues, because they already include updates (GB204000 include updates 1 and 2. Gb50401S include update 1). Charts GB304010, GB40401S and GB40501L are called as base cells, because they do not contain any updates i.e. their update number is 0.

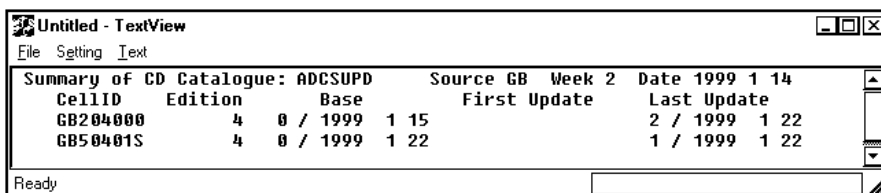

The example above contain both base cells and all updates of the charts from issue of base cell up to the last update.

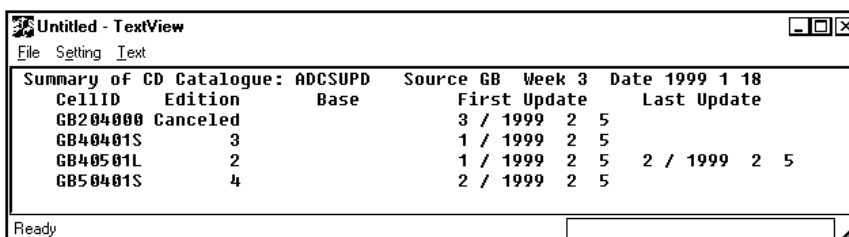

The example above contain only updates. In example above update 3 is available for chart GB204000, update 1 is available for chart GB40401S, updates 1 and 2 are available for chart GB40501L and update 2 is available for chart GB50401S.

Messages, which control reload

If you try to load charts with the same edition already loaded into your hard disk or if you try to load the same update already loaded into your hard disk, you get following messages after pressing **Load** button.

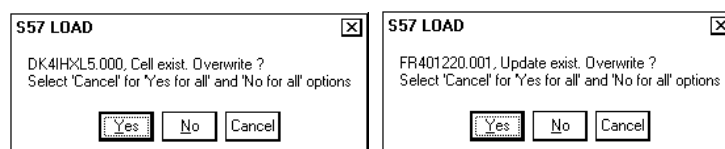

If you press **Cancel** button, you will get following dialog box:

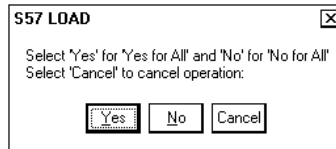

If you want to avoid very time consuming reload of charts which you already have, then you should select **No** ("No for all" option in above window).

However if you want to reload charts, then select **Yes** ("Yes for all" option in above window).

Messages, which contain only notice

If you tried to load older chart data than you already have in your hard disk, you will get one of the following messages:

This indicates that you already use a newer edition of the chart.

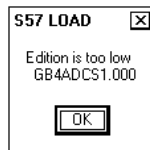

This indicates that you already use a newer reissue of the chart, which includes this update

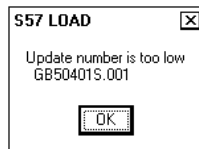

This indicates that you already use a newer reissue of the chart

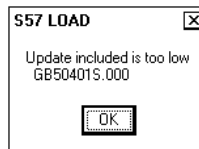

This indicates that you already use these updates



NOTE! You can not replace chart data, which is already in use unless you only replace the latest base cell or update. If you want to reload older data again, you must first remove the chart from your hard disk (See chapter "How to remove S57 chart cells from the system").

Messages, which require careful attention

All messages in this chapter change the legal status of the charts in your system. Study these message extremely careful because you may need to use paper charts to fulfil SOLAS requirements

Test before ENC to SENC conversion fails

CRC checksum is tested before the SENC conversion and if it fails you get this message

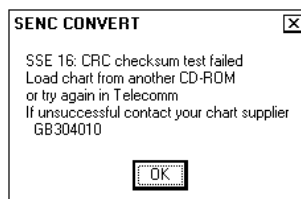

Conversion from ENC to SENC fails partly

If conversion fails partly due to internal booking error of the chart.

Load the chart and updates again into the system.

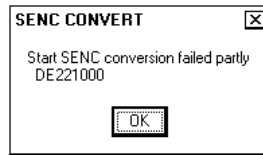

ENC to SENC conversion fails or detects errors

If the SENC conversions detect anything abnormal you get following message window:

See more information in chapter "S57 SENC Conversion details" on page 80.

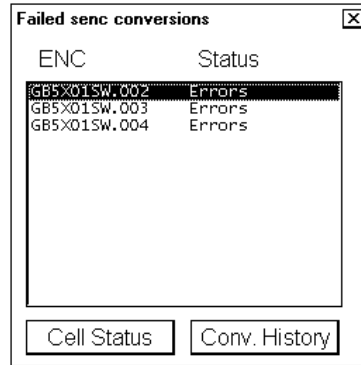

A new edition of the chart has been published and you miss it

If you tried to load updates for a chart for which you do not have new enough base cell or reissue in your hard disk, you will get following message:



The message above clearly indicate that this chart is not up-to-date and thus it does not fulfil SOLAS requirements. Get immediately from the publisher of this chart the new edition of the chart.

You do not have all the published updates

If you tried to load updates and you miss one or more updates between updates already loaded into your hard disk and updates that you are loading, then you get following message:



The message above indicates that you tried to load updates number 3, 4 and 5 when at least update 2 and possibly update 1 were not available in your hard disk. Check the content of your CD-ROMs to find the missing update/updates or contact your chart supplier.

The message above clearly indicate that this chart is not up-to-date and thus it does not fulfil SOLAS requirements. Get immediately from the publisher of this chart the missing updates of the chart.

Unsafe Chart has been cancelled by the publisher

If you load an update, which contain cancellation of the chart instruction by the publisher of it, you get following message:

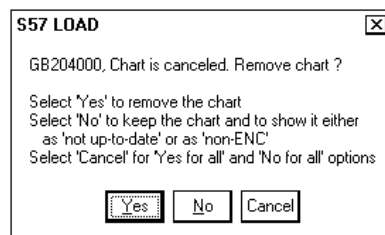

Normally you should accept the cancellation and you should press **Yes**. Then the system automatically removes the chart from the hard disk and from your chart screen.

You may insist to keep the chart although the publisher of it has told you that the content of the chart is so unsafe that they have cancelled it. The reason might be that you do not have anything better available. In this case you press **No**. Then the system automatically remove the ENC status from the chart, because the publisher has told so in his special cancellation update.

Note that the cancellation message above clearly indicate that the publisher says that this chart is unsafe for navigation and thus it does not fulfil SOLAS requirements. Get immediately from the publisher of this chart the new chart/charts, which replace the unsafe cancelled chart.

How to load S57 charts, which are not fully compliant with the standards

The ECDIS could in some cases load S57 charts, which does not have full compliance with S57 standard coding for transfer media. Minimum requirement for loading manually is legally coded:

- XXXXXXXX.000 file, which includes a base cell
- XXXXXXXX.NNN file, in which NNN is a number from 001 to 999, and which includes an update

To load charts without building a named "CD Catalog" proceed as follows:

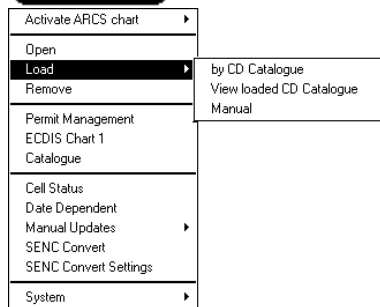
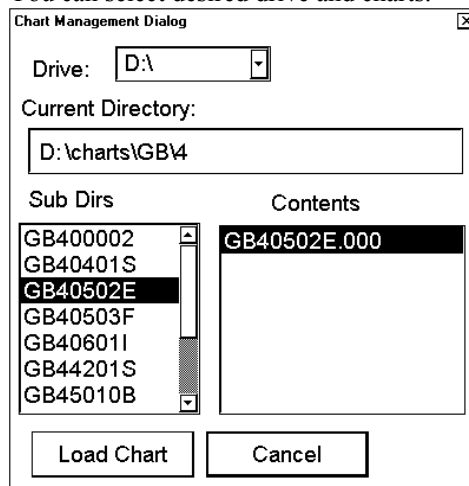

CHART PLAN push button

1. Press CHART PLAN push button, select **Load** from the menu and **Manual** from submenu.
2. You can select desired drive and charts.



When ready to load charts, press **Load Chart** button.

3. The System may also make conversion into the SENC and setting of Display Until date automatically. This can take a few minutes.

S57 SENC Conversion details

S57 charts from Hydrographic offices are called ENC's. An ENC has to be converted into SENC format before it can be used in the ECDIS. The ECDIS can convert ENC into SENC format automatically. If the conversion is successful, the Failed SENC conversion window does not appear.

If the system fails to convert ENC into SENC or if the system detects an coding error in an ENC, a **Failed SENC conversion** window appears with a list of failed ENC's. In this window you can select any of the charts to see reason for failure in conversion.

Normally the conversion is initiated automatically from loading of the charts. Chapter "How to load S57 charts" on page 71 describes the loading process. Chapter "How to select automatic SENC conversion and Display Until date" on page 80 describes how you can select automatic conversion. You can also initiate conversion from a SENC convert window or from a Cell Status window.

How to make SENC conversion faster

The SENC conversion speed depends about how many other tasks the system has. The system can do SENC conversion as background process during any other possible operational use of the system, but you can greatly improve the speed of the SENC conversion, if you do following things:

1. Disable Radar echo overlay. Select Radar overlay mode as **ECDIS ONLY**. Select control of visible navigation features as OFF for Radaroverlay (the Radaroverlay visibility control is located in "Tracking" sheet of "Chart details").
2. Select Display Mode as **TRUE MOTION**
3. Press **Set Chart Center** push button and allow the system to operate either in TM RESET OFF or SHIP OFF SCREEN state
4. Press **Zoom In** until you reach scale of 1:1 000

How to select automatic SENC conversion and Display Until date

When you are loading new S57 charts base cells and/or their updates into hard disk, it is possible make automatic conversion to SENC format. It is also possible to set display dates as issue dates automatically. Proceed as follows to set these options:

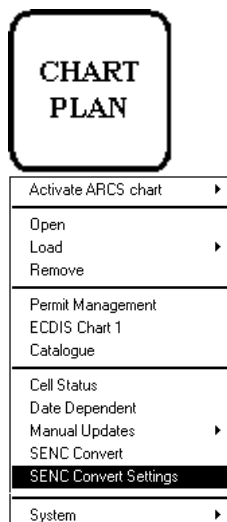

1. Press CHART PLAN button, select **SENC Convert Settings** from the menu.
2. A S57 Settings dialog box appears:

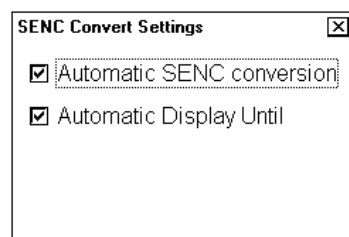

Select **Automatic SENC Conversion** and **Automatic Display Until** options.

How to view progress of SENC conversion

If you want to view the progress of SENC conversion, you can activate SENC convert window. Proceed as follows:

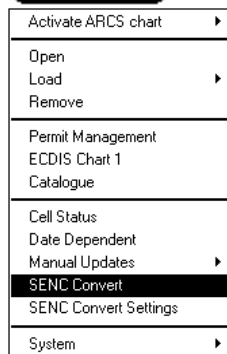

1. Press CHART PLAN button, select **SENC Convert** from the menu.
2. A SENC Convert window appears:

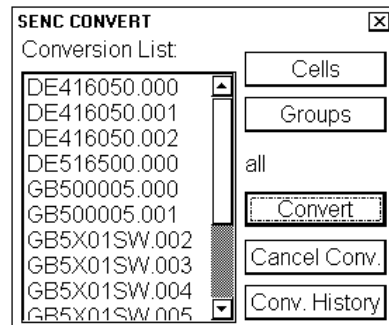

Example above shows a queue of unfinished SENC conversions.

Note!. You can at any moment remove charts from the conversion list. You paint with the cursor any amount of chart names in the Conversion List. And then you press **Cancel Conv.** to remove your painted charts from the SENC conversion queue.

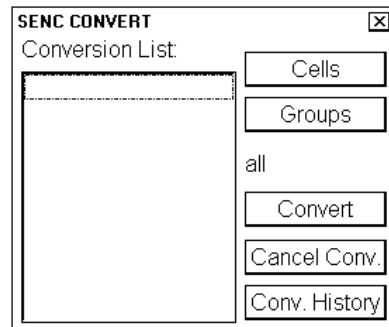

Example above shows that all SENC conversions have been finished.

Note!. You can at any moment view the results of the finished SENC conversions. Press **Conv. History** and you get a Conversion log for viewing.

How to use Failed SENC conversion window

If the system is unable to convert ENC into SENC without any error or failure, a **Failed SENC conversion** window appears with a list of failed ENCs. Status of Failure means that the system completely failed to convert the ENC into the SENC and thus the ENC cannot be used.

Status of **Errors** means that the system detected minor or major errors in the conversion of the ENC into the SENC. Check carefully the content of Conv history and Cell status to see, if the error was minor or major. Major errors are indicated as NON ENC in Conv History. **Note that the status of Errors together with NON ENC in Conv History clearly indicate that this chart is not up-to-date and thus it does not fulfil SOLAS requirements.** Get immediately from the publisher of the chart the new edition of this chart.

Status of **Failed** means that the system completely failed to convert the ENC into the SENC and thus the ENC cannot be used. **Note that the status of Failure clearly indicate that this chart is not up-to-date and thus it does not fulfil SOLAS requirements.** Get immediately from the publisher of the chart the new edition of this chart.

The **Failed SENC conversion** window contains two buttons. One to open conversion history log **Conv. History** and another to open **Cell Status** window of selected item in the list of **Failed SENC conversions** window.

If you use **Conv. History** button, a Conversion Log appears. Conversion Log shows the status of converted ENCs. More information about the results of conversions, see chapter "How to use SENC Conversion history log" on page 83.

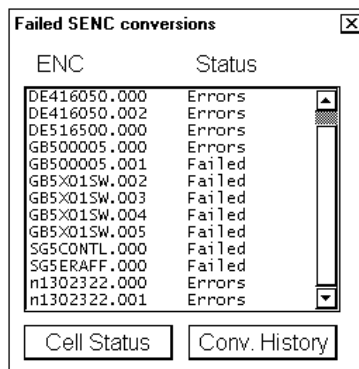

If you use **Cell Status** button, a Cell Status window appears.

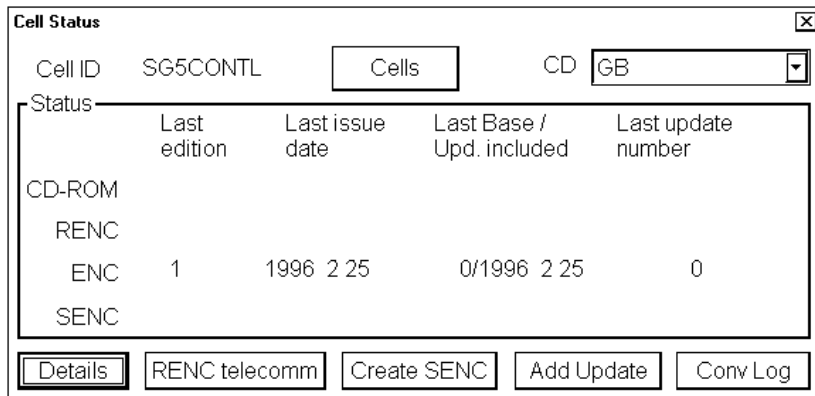

Then you can push **Conv Log** button to open view detailed description of errors and failures detected during SENC conversion (see example on next page).

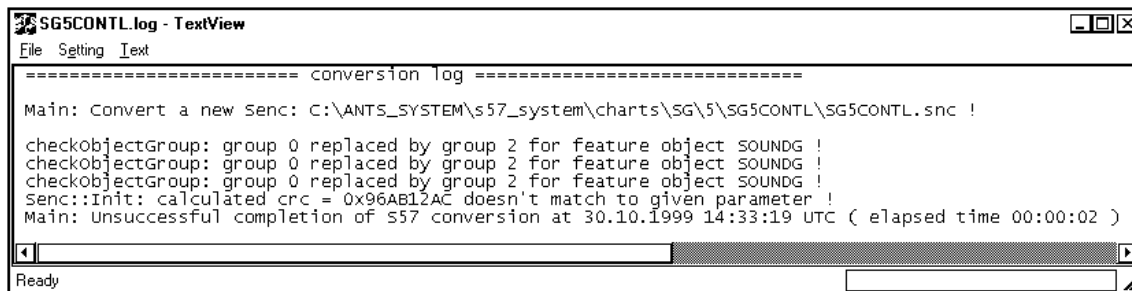

In the example above the reason of the SENC conversion failure is a miss match of checksum (calculated crc number differs from the expected).

How to use SENC Conversion history log

The system automatically records the results of all conversion into the Conversion history log. You can at any moment view the content of this log. Proceed as followed:

1. Press CHART PLAN button, select **SENC Convert** from the menu.
2. A S57 SENC CONVERT dialog box appears:

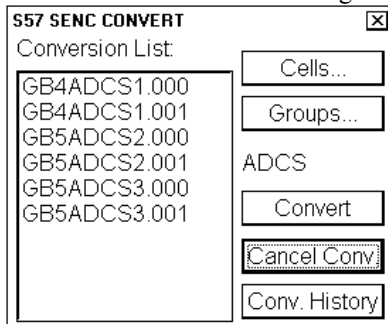

After conversion (Conversion list is empty), press **Conv. History** button.

NOTE! You can also activate the **Conv. History** from the "Failed SENC conversions" window.

3. A list of converted charts appears:

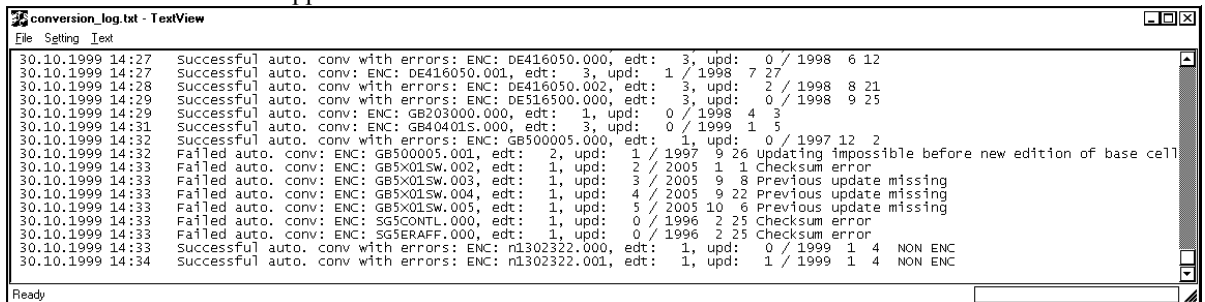

You can view here status of converted charts.

4. Close TextView program from **File** menu.
Below are example of all possible results of conversion:

Perfect chart

Successful auto. conv: ENC: GB203000.000, edt: 1, upd: 0 / 1999 4 3

Perfect Chart, which is produced by a private chart producer (i.e. chart doesn't have ENC status)

A private chart cannot fulfil SOLAS requirements and you must refer to a paper chart as legal primary aid of navigation, when you navigate in the area covered by this chart.

Successful auto. conv: ENC: AS31MATT.000, edt: 1, upd: 0 / 1999 4 8 NON ENC

Conversion errors, but the chart is partly usable

Use Cell Status to check details of errors. Note that the chart is still ENC.

Successful auto. conv with errors: ENC: DE416050.000, edt: 3, upd: 0 / 1998 6 12

Conversion errors, but the chart is partly usable as NON ENC

Use Cell Status to check details of errors. Note that the chart is not anymore ENC, if it was produced by an Hydrographic Office, and you must refer to a paper chart as legal primary aid of navigation, when you navigate in the area covered by this chart.

Successful auto. conv with errors: ENC: n1302322.000, edt: 1, upd: 0 / 1999 1 4 NON ENC

Failed conversion

Chart is not usable and you cannot view the chart. You must refer to a paper chart as legal primary aid of navigation, when you navigate in the area covered by this chart.

Failed automatic conversion: ENC: DK3EIOXE.000, edt: 1, upd: 0 / 1999 2 17

Failed conversion of an update

Chart is partly usable, but it is not up-to-date and you need a "new edition" of the chart from the publisher of it. Note that the chart is still ENC, but it does not anymore fulfil the SOLAS requirement that you have included the latest update into your chart. You must refer to a paper chart as legal primary aid of navigation, when you navigate in the area covered by this chart.

Failed auto. conv: ENC: GB500005.001, edt: 2, upd: 1 / 1997 9 26 updating impossible before new edition of base cell

Failed conversion. Checksum is not correct

Chart is not usable and you cannot view it. Try to reload the base cell or update from original media. And if that doesn't help order a new CD-ROM from your chart supplier. You must refer to a paper chart as legal primary aid of navigation, when you navigate in the area covered by this chart.

Failed automatic conversion: ENC: SG5CONTL.000, edt: 1, upd: 0 / 1996 2 25 CHECKSUM ERROR

Failed conversion. Checksum of an update is not correct

Chart is partly usable, but it is not up-to-date. Try to reload the update from original media. And if that doesn't help order a new CD-ROM from your chart supplier. Note that the chart is still ENC, but it does not anymore fulfil the SOLAS requirement that you have included the latest update into your chart. You must refer to a paper chart as legal primary aid of navigation, when you navigate in the area covered by this chart.

Failed automatic conversion: ENC: GB5X01SW.002, edt: 1, upd: 2 / 2005 1 1 CHECKSUM ERROR

Failed conversion. At least one of the previous updates has failed in its SENC conversion

The system cannot accept additional updates unless all previous updates have been successfully converted into the SENC. Chart is partly usable, but it is not up-to-date. Try to reload first the failed previous update from original media (in this example the failed previous update is GB5X01SW.002). And if that doesn't help order a new CD-ROM from your chart supplier. Note that the chart is still ENC, but it does not anymore fulfil the SOLAS requirement that you have included the latest update into your chart. You must refer to a paper chart as legal primary aid of navigation, when you navigate in the area covered by this chart.

Failed automatic conversion: ENC: GB5X01SW.003, edt: 1, upd: 3 / 2005 9 8 PREVIOUS UPDATE MISSING

Failed conversion. The base cell has failed in its SENC conversion

The system cannot accept updates unless the base cell has been successfully converted into the SENC. Chart is not usable and you cannot view it. Try to reload the base cell from original media (in this example the failed base cell is GB5X01SW.000). And if that doesn't help order a new CD-ROM from your chart supplier. You must refer to a paper chart as legal primary aid of navigation, when you navigate in the area covered by this chart.

Failed automatic conversion: ENC: GB5X01SW.001, edt: 1, upd: 1 / 1998 9 8 PREVIOUS BASE CELL OR UPDATE MISSING

NOTE! Always study both the "Failed SENC conversion" dialog and "Conversion history log" very carefully, because they contain important information about the legal status of the charts. Specially note that a chart may lose its legal status to fulfil SOLAS requirements and you may need to refer to a paper chart as legal primary aid of navigation.

How to use SENC convert window to initiate SENC conversion

Normally the "Automatic SENC conversion" is selected and there is no need to initiate SENC conversions from the SENC convert window. If you do not use the "Automatic SENC conversion", you need to manually initiate SENC conversion. Another case in which you need to manually initiate SENC conversion is, if you upgraded or reloaded the ECDIS software from the ECDIS software CD-ROM.

To initiate SENC conversions manually proceed as follows:

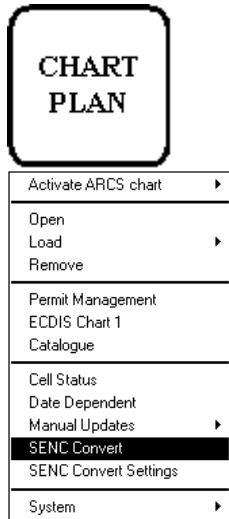

1. Press CHART PLAN button, select **SENC Convert** from the menu.
2. A SENC Convert window appears:

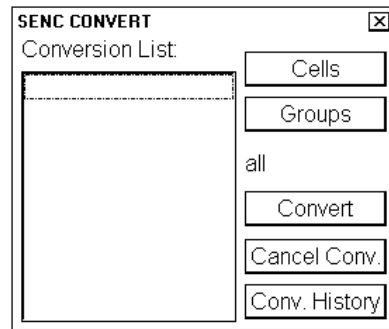

3. Use **Cells** to select an individual chart or use **Groups** to select a group of charts. Then press **Convert** to initiate the SENC conversion of the charts. Note that the **Convert** only do conversion of those charts, which are not currently converted into the SENC format. If your selected chart or all members of your selected group are already in the SENC format, the Conversion list remains empty. If all or some charts are not yet in the SENC format, they are added into the Conversion list (see example below). If you need for some reason to force SENC conversion of an already converted charts, you read instructions in chapter "Seldom used features of Vector charts" on page 142.

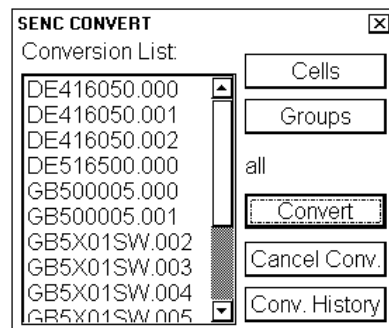

Note 1! You can at any moment remove charts from the conversion list. You paint with the cursor and by pressing SELECT button any amount of chart names in the Conversion List. And then you press **Cancel Conv.** to remove your painted charts from the SENC conversion queue.

Note 2! You can at any moment view the results of the finished SENC conversions. Press **Conv. History** and you get a Conversion log for viewing.

Some features of Chart Plan menu

Overview of Chart Plan menu

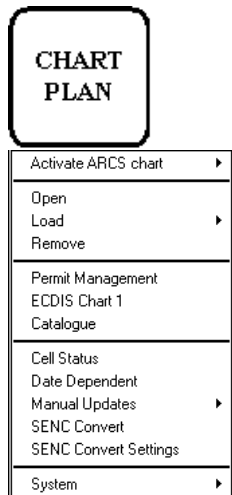

Activate ARCS chart:

This function activates ARCS chart into the screen. You have two options to select the chart to be opened into the display: **Ignore scale** opens ARCS chart with a scale which was used last time when you used ARCS charts, **Sync scale** opens ARCS chart with a scale which is as close as possible to the scale which was used with S57 charts.

Open:

You can open S57 chart by its number. See chapter "How to select charts for viewing" on page 116.

Load:

You can load ENC's into the hard disk using CD-ROMs, floppies or LAN (Local Area Network); see chapter "How to load S57 charts" on page 71.

Remove:

You can remove cells from your hard disk; see chapter "How to remove S57 Charts from the system" on page 95.

Permit Management:

You can load permits for encrypted charts to enable their use in your ECDIS. Currently PRIMAR and CMAP uses encryption.

ECDIS Chart 1:

This is used to open chart set "IHO ECDIS Chart 1". You can get familiar with symbology of chart used with ECDIS. See also Chapter "Symbology used in Vector charts" on page 133.

Catalogue:

You can manage S57 charts using this; see chapter "Catalogue of S57 cells" on page 88.

Cell Status:

You can view status of the cells (edition number and date, number of updates of the cell) stored into your hard disk, CD-ROMs or RENC. You can compare that you have the latest cell with latest update in use. For more information, see chapter "Seldom used features of Vector charts" on page 142.

Date Dependent:

You can view date dependency of the cells (RENC status query date, number of updates available, Update Display dates, Update Approve Dates of the cells) in the SENC format; see chapter "Date dependent and periodical features of Vector chart" on page 126.

Manual Update Planning

You can update your charts manually. For more information, see chapter Manual Updates.

SENC Convert:

You can convert ENC's (base cells and/or updates) into the SENC by individual cell or group of cells basis; see chapter "How to use SENC convert window to initiate SENC conversion" on page 85.

SENC Convert Settings:

You can select automatic conversion from ENC format into the SENC format when you load charts into the hard disk. You can also select automatic set of Display until date to current date after the SENC conversion; see chapter "How to select automatic SENC conversion and Display Until date" on page 80.

System:

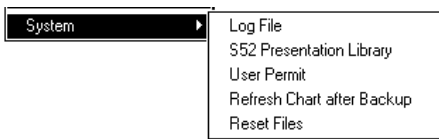

System has a set of further selections. They are described below:

Log File

The log file contain various system events, which might be useful when your system supplier try to find reason of the unexpected behaviour of the system reported by you.

S52 Presentation Library

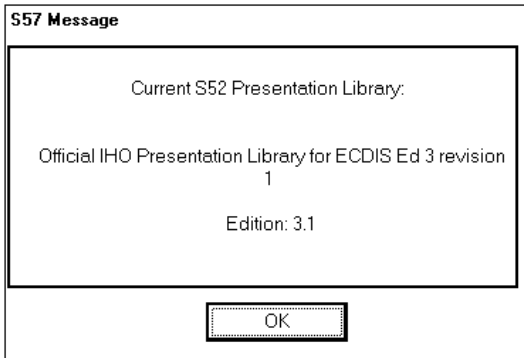

You can check used presentation library for S57 charts. The current official Presentation library is shown in this example.

User Permit

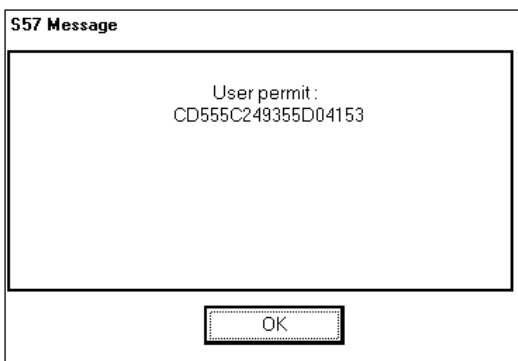

You can check your User Permit., which is used as your identifier in security systems such as PRIMAR and CMAP. See example below:

Refresh Charts after Backup.

This is used to refresh available charts and updates after somebody made Backup of all charts and updates from another ECDIS to this ECDIS.

Reset Files

This is only used for demonstrations. Reset Files run a script, which can be defined only by the factory experts, and which returns the content of the chart database into a such state that an demonstration of chart loading and updating could be demonstrated again.

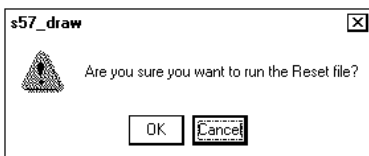

If you by accident select this option, you get this question:

Select **Cancel** for any other case than rerunning of the demonstration.

Catalogue of S57 cells

A S57 catalogue is used to view graphical coverage of the charts stored into the hard disk, available in a named "CD" or available from the RENC. Available charts are displayed using their limits of charts. Note that sometimes the real coverage of the charts may be considerably less than the declared limits of it. You can cursor pick any chart by going over its limit and then you can view the information of it

Catalogue window appears when you press CHART PLAN button and select **Catalogue** from the menu.

1. View Filters

- **Name**, if selected displays also cell names in graphical coverage display
- **Permit**, if selected displays only charts for which you have permit
- **RENC Cancelled Charts**, if selected also charts, which are cancelled in a RENC, are displayed on Catalogue.
- **Navigation purpose**, displays charts from selected Navigation purposes
- **Group Charts**, displays charts, which are members of the active group
- **Catalogue Charts**, you have three option to select:
 - **RENC**, display charts available from the RENC
 - **SENC**, display charts stored into the hard disk in SENC format.
 - **CD**, display charts available in a named "CD"

2. Selected Chart

- **Cell ID**, name of the chart
- **Permit**, existence of the permit
- **SENC**, existence of SENC in your hard disk

3. Group. See more in the chapter "Group of S57 cells"

4. The chart limit boxes are colour coded as follows:

- Green** The chart is available for use in SENC format. If the source of the chart is a RENC then the chart is also up-to-date. If the source of the chart is something else than a RENC then all loaded updates are included into the SENC.
- Orange** The chart is available for use in SENC format but the chart is either not up-to-date or canceled. Either the SENC is from old edition, the SENC misses latest updates or the chart has been canceled..
- Red** If the chart is permit free, you do not have it available for use in SENC format and thus you cannot use the chart currently.
If the chart requires permit, you do not have the permit for the chart and you cannot use the chart currently..
- Blue** The chart is available either in ENC format, in SENC format for another software version or in SENC format for another ECDIS. For example chart is blue during SENC conversion and if you loaded a chart into the ECDIS and the system could not convert the chart into SENC format.
- Magenta** You have a permit to use the chart, but the chart is not available in SENC format and thus you cannot use the chart currently.

Group of S57 Chart cells

In S57 catalogue you have possibility to define groups of S57 Charts. This means that you can collect charts together - for example all cells, which cover a route from Liverpool to New York or all cells available from one National Hydrographic Office. This makes easier to perform many SENC maintenance functions such as loading base cells and updates, setting Display Until and Approve Until dates etc. Below an example how to make a group and add Charts into it.

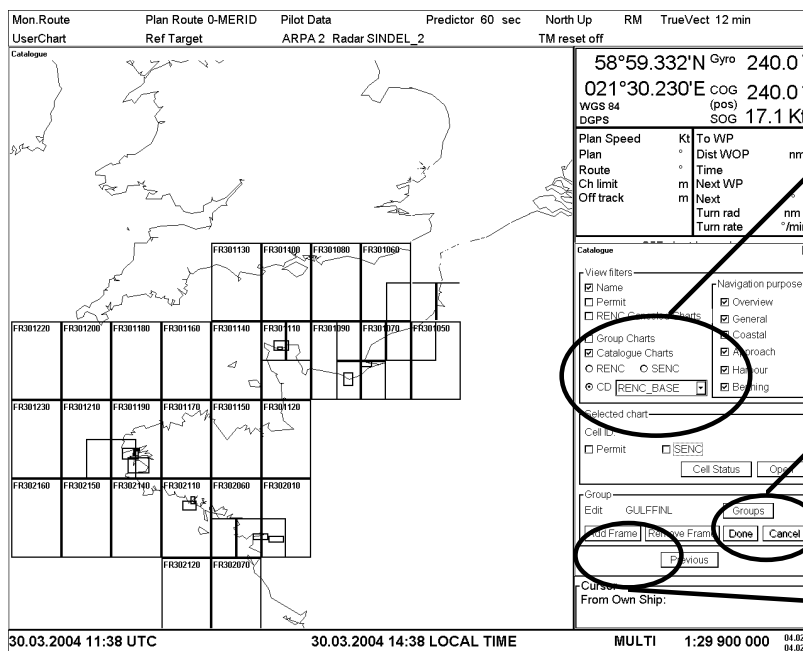

1. Select Catalogue Charts as RENC, HD or CD

2. Press Groups button

4. Press Add Frame button

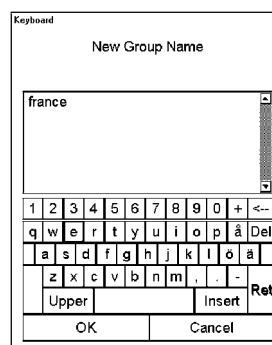
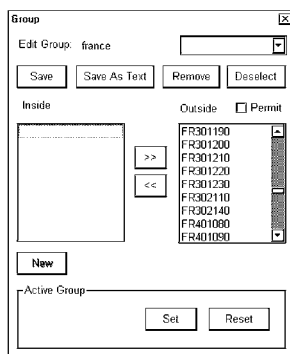

3. Enter Name for new Group

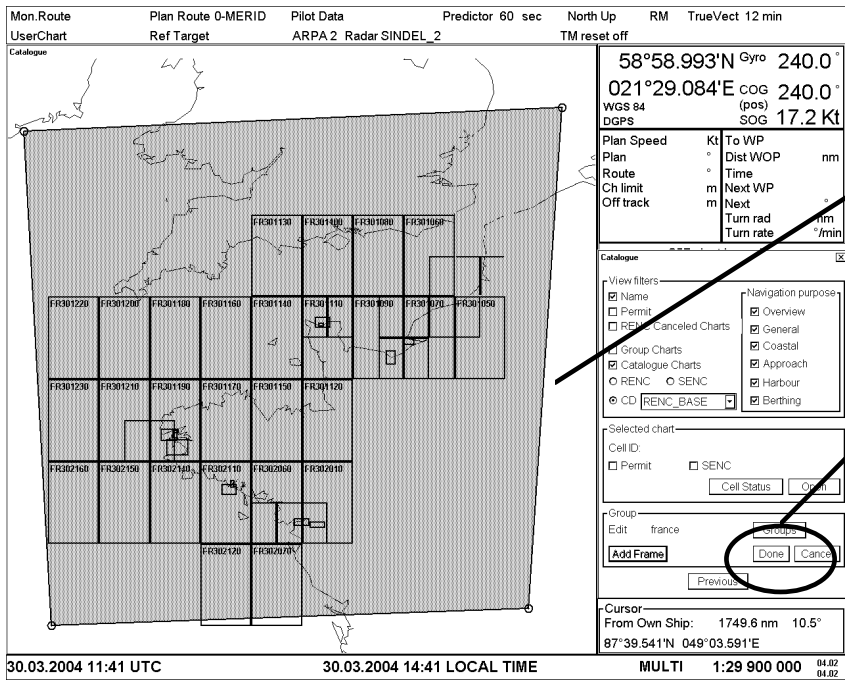

5. Use SELECT button to define frame for group

6. Press Done button

7. Press Save button

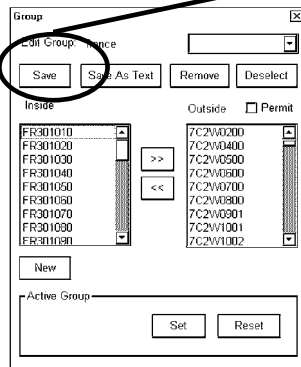

You can save your chart cells also into text file, if you like to have a list of chart cells in text format. To do this press **Save As Text...** button. A “Save As” dialog box appears.

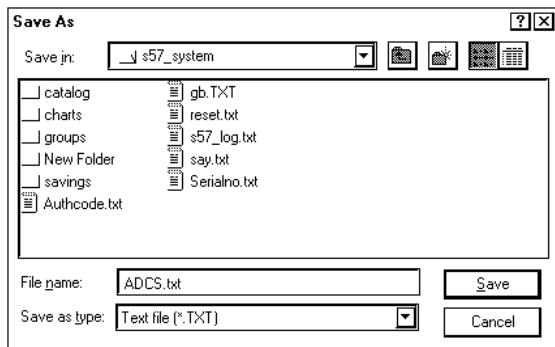

Select directory and drive to where you want save your group. You can use Windows NotePad application to view and to make a hard copy from the list of group.

How to remove S57 Chart cells from a group

You can remove chart cells from a defined group. To remove proceed as followed:

1. Press CHART PLAN push button. Select **Catalog** from the menu.
2. Press **Groups** button in S57 Catalog dialog box.
3. Select desired group from **Edit group** list box.
4. Select desired chart cell(s) from Inside list box.
5. Press >> button. Selected Chart cell is removed to Outside list box and it is no more member of defined group

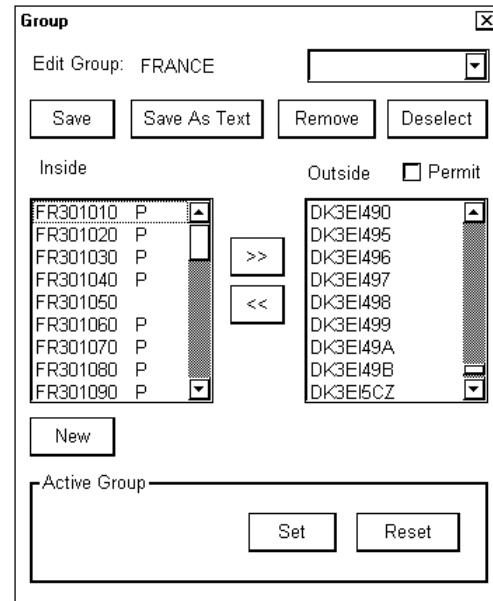

How to delete a group

You can delete a defined group. To remove proceed as followed:

1. Press CHART PLAN push button. Select **Catalog** from the menu.
2. Press **Groups** button in S57 Catalog dialog box. A Chart group dialog box appears.
3. Select desired group from **Edit group** list box.
4. Press **Remove** button. Confirm deleting a group, press **OK**.

How to select active group for viewing with catalog

To select active group proceed as follows:

1. Press CHART PLAN push button. Select **Catalog** from the menu.
2. Press **Groups** button in S57 Catalog dialog box.
3. Select desired group from **Edit group** list box.
4. In **Active Group** -field press **Set** button. The name of active group appears to **Active Group** -field.

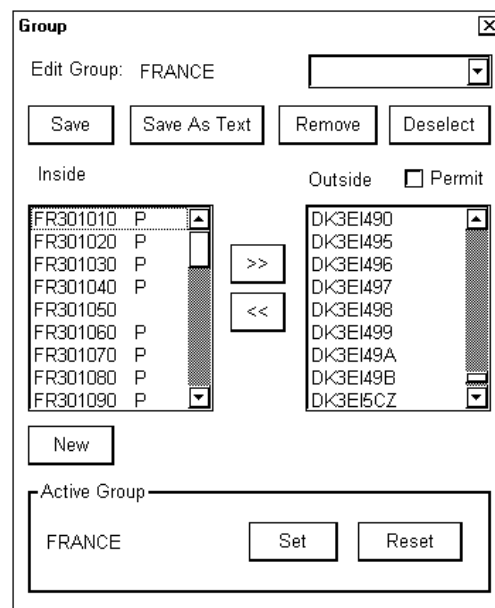

How to view active group with catalogue

To view active group proceed as follows:

1. Press CHART PLAN push button. Select **Catalog** from the menu.
2. Select Group Chart in Catalogue dialog box. In Catalogue window it is shown charts which are member of active group.

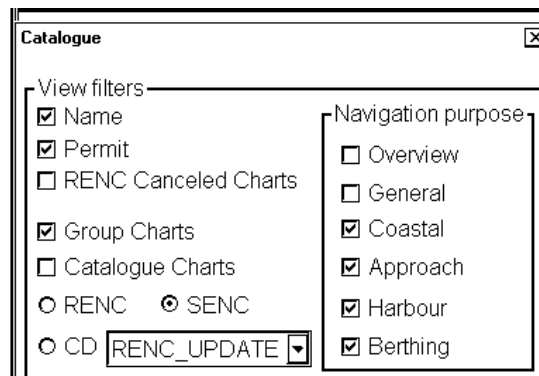

How to view status and date dependency of S57 Chart cells and their updates

When you load S57 Chart cell(s) and/or their updates the system sets **Display until** of S57 Chart cell(s) as current date of the System. To set **Approve until** as current date of the System you must open Date Dependent and perform Approve Until. You can view status and date dependency of S57 Chart cells and their updates. To view status and date dependency, proceed as followed:

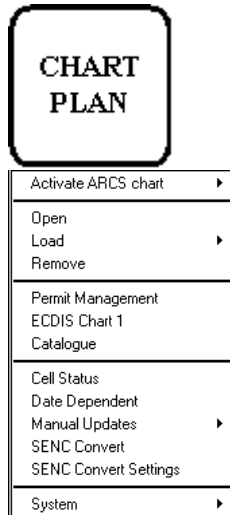

1. Press CHART PLAN push button and select **Date Dependent** from the menu.
2. A Date Dependent dialog box appears.

Date Dependent										
Cell Status										
Cell ID	RENC edt/ upd	SENC edt/ upd	Updates Displayed until	Updates Approved until						
AA5C1000	-/ -	2/ 0	2001 11 28	(-)	2001 11 28	(-)				
AA5C1V00	-/ -	2/ 0	2001 11 28	(-)	2001 11 28	(-)				
AA5C1W00	-/ -	2/ 0	2001 11 28	(-)	2001 11 28	(-)				
DE316004	2/ 8	<<< 2/ 9	2001 11 28	(-)	2001 11 28	(-)				
DK3DHWHE	Cancelled	XXX Cancelled	2001 11 28	(-)	2001 11 28	(-)				
DK3DIOXC	Cancelled	XXX Cancelled	2001 11 28	(-)	2001 11 28	(-)				
DK3EHXLD	2/ 0	2/ 0	2001 11 28	(-)	2001 11 28	(-)				
DK3EHXLE	1/ 4	1/ 4	2001 11 28	(-)	2001 11 28	(-)				
DK3EHYPD	2/ 0	2/ 0	2001 11 28	(-)	2001 11 28	(-)				
DK3EHYPE	23/ 2	23/ 2	2001 11 28	(-)	2001 11 28	(-)				
DK3EIOXD	2/ 1	2/ 1	2001 11 28	(-)	2001 11 28	(-)				
DK3EIOXE	2/ 0	2/ 0	2001 11 28	(-)	2001 11 28	(-)				
DK3EI21D	1/ 0	1/ 0	2001 11 28	(-)	2001 11 28	(-)				
DK5HHYPE	13/ 0	13/ 0	2001 11 28	(-)	2001 11 28	(-)				
DK5IHYPE	6/ 1	6/ 1	2001 11 28	(-)	2001 11 28	(-)				
FI49IGID	1/ 0	1/ 0	2001 11 28	(-)	2001 11 28	(-)				
FI4EIHME	1/ 1	>>> 1/ 0	2001 11 28	(-)	2001 11 28	(-)				
FI4EITQR	1/ 21	>>> 1/ 0	2001 11 28	(-)	2001 11 28	(-)				
NL303371	1/ 6	1/ 6	2001 11 28	(-)	2001 11 28	(-)				
Latest RENC			Oldest date	2001 11 28	2001 11 28					
Product List			Newest date	2001 11 28	2001 11 28					
2001 10 31			Manual Updates	---NVLD---	---NVLD---					
<input checked="" type="checkbox"/> Sync Manual Update Dates				Display until		Approve until				
Manual Update Dates				<input checked="" type="checkbox"/> All SENCs						

Recommended settings in Date Dependent are:

- Sync Manual Update Dates as ON position
- All SENCs ON position

RENC edt / upd : Column "RENC" contain edition/update status from Product List.

SENC edt / upd : Column "SENC" contain edition/update status from "SENC", i.e. loaded and converted in the ECDIS.

Updates displayed until: View the date until updates is displayed. You can enter desired date by using **Display until** button. The number after date shows the number of updates involved to displayed cell (number of displayed updates / number of updates in SENC format).

Updates approved until: View the date until updates is approved. You can enter desired date by using **Approve until** button (number of approved updates / number of updates in SENC format).

The issue date of the used Product list is displayed as "Latest RENC Product List". The RENC product list contains information about charts stored in RENC the date when Product list was issued. If the ECDIS do not contain any Product List, then the date of the Product List is displayed as "—NVLD—".

A Mark ">>>>" is used to indicate that a chart is not up-to-date. A Mark "<<<<" is used to indicate that SENC contains newer information than based on information in RENC Product list (You may need to load newer RENC Product List). Cancelled charts are indicated as "cancelled" instead of "edtn/updn". If SENC contain a cancelled chart then the indication ">>>>" is replaced by "XXX".

How to later use CD Catalogue created during load of S57 charts

The CD Catalogue was created during loading of S57 charts. A CD Catalogue contains important information from the chart producer such as Publisher Notes and Summary of the charts. Sometimes you may need to load charts from the CD-ROM. These things can be done as shown below.

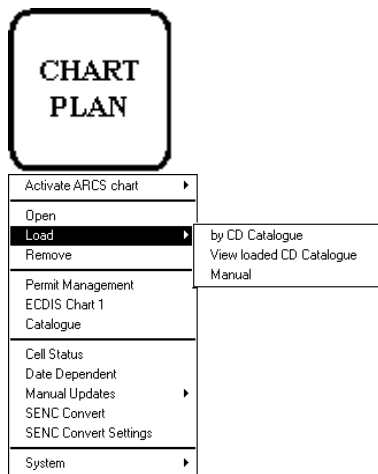

1. Press CHART PLAN push button, select **Load** from the menu and **View loaded CD Catalogue** from submenu.
2. Select a named "CD Catalogue" you want to use in CD list box. The content of the catalog appears as a list of charts in the list box and information of source CD-ROM.

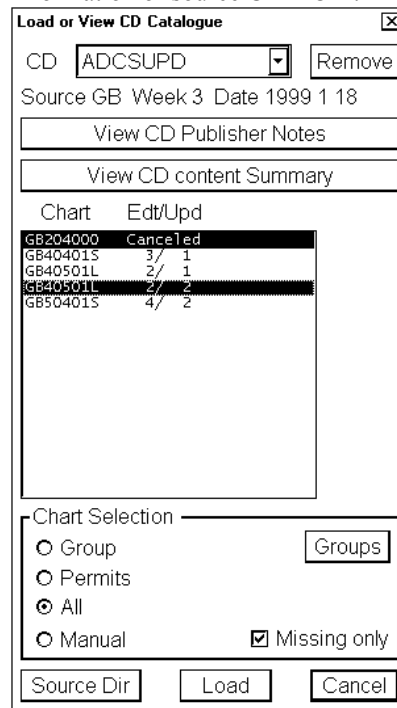

Note! If you also want to load chart, you must use the same "CD" as you used to make a named "CD Catalogue". The system checks that the content of the CD-ROM is equal and in case of miss match following message appears:

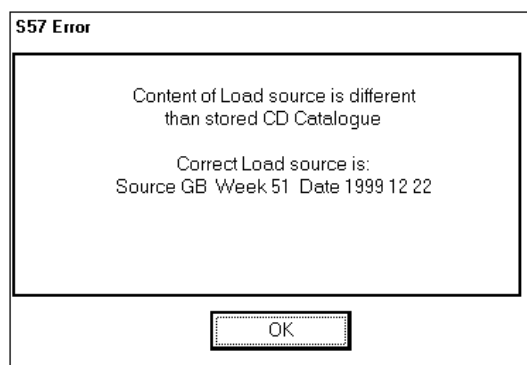

How to view Publisher Notes and/or CD content Summary

You can view the Publisher notes as follows.

1. Press **View CD Publisher Notes** button in the S57 Load dialog box.
2. A viewer shows you the Publisher Notes of the selected "CD".
3. If you want to make a hard copy of Publisher Notes, select **Print** in the **File** menu.
4. To close this program, select in **Exit** in the **File** menu.

You can view the Summary of the content of the CD. See chapter "How to load S57 charts from a CD-ROM, floppy or LAN" on page 73."

How to remove S57 Charts from the system

To remove S57 format vector chart cell from the system, proceed as follows:

1. From the Control panel press Chart Plan push button.
2. Select **Remove** from the menu. There will appear a chart list dialog.
3. Select desired chart cells to remove them from the system. You can remove base cell (000), updates (001...) and SENC format (.snc).

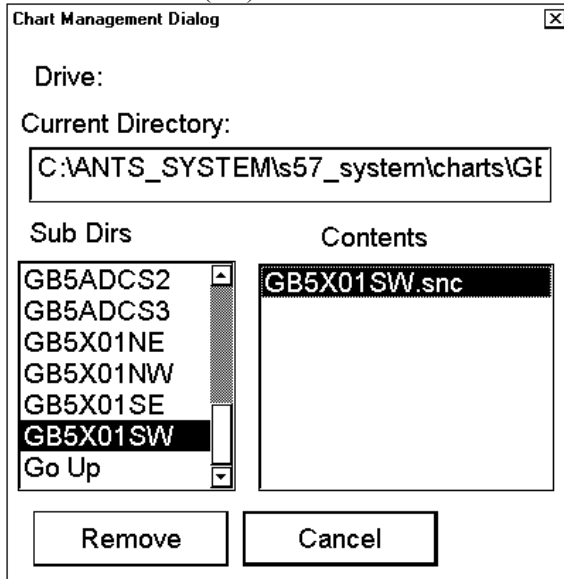

4. Press **Remove** button. System will remove file(s) from the hard disk.

Introduction to the S57 chart service from a RENC

Introduction

RENC concept is based on IHO standard S-63.

Before you can use RENC service, you have to be authorized as Customer of RENC. To be authorized you have to contact official distributor (Chart Agent) of RENC. From a RENC you can get permits, charts and updates.

Permits

Permits are used to control the permission to use a chart. A permit in RENC security is connected to an edition.

Permits are issued as two different types

- Subscription Permit. These include updates for subsequent 12 months. It is assumed that a typical user is a SOLAS class vessel, which is required to use up-to-date charts.
- One-Off Permit. These include only updates up to the issue date of the Permit. It is assumed that a typical user is a non-SOLAS class vessel, which is not required to use up-to-date charts.

Each Permit includes also the expiry date.

The expiry date of a Permit controls the ENC to SENC conversion. If the issue date of a chart or update is older or equal to the Permit expiry date, then the system can convert an ENC into the SENC. There are no viewing time limits as used in some other security systems such as ARCS. The user has a right to view a chart forever and more over he has a right to convert a chart from its ENC format into the SENC forever.

A RENC can publish Permits in two different formats

- “*.pmt” format. This format does not include the applicable chart edition and does not include applicable permit type.
- PERMIT.TXT format. This format does include the applicable chart edition and does include applicable permit type.

Both permit formats are fully operational, but the older “*.pmt” format creates confusion, because it cannot support the user, when chart edition changes.

The system display warnings associated with expiry date. Examples are “will expire” warning 30 days before the expiry date and “have expired” after the expiry date. These warning are relevant only for Subscription Permits. Only the new PERMIT.TXT format support the system to suppress irrelevant warning associated with expiry date.

Product List

A Product List is maintained by a RENC. When you load charts using "Load By CD Catalogue", ECDIS will automatically load Product list from the CD-ROM of a RENC. This list contains an up-to-date list of available charts and their edition/update status in the RENC. When you load a CD-ROM from a RENC, the ECDIS checks the issue date of the Product List. If the issue date indicates newer Product List, then it is copied into the ECDIS. If the issue date indicates older Product List, then ECDIS shows a notice to the user that newer already loaded.

Authentication

Normally the authentication process is invisible for the user. Only if the Authentication fails, then the user gets appropriate notice. From user point of view the Authentication is similar to CRC checksum test. If CRC checksum test or Authentication fails then the chart is unusable.

Authentication uses private key and public key. A digital signature associated with each chart contains private key. Public key is stored in the ECDIS and it is really public. RENC may publish a new public key. This public key will be available as text by fax, by post, by front page of a newspaper etc. and as a text file called for example PRIMAR.PUB. The day, when a RENC publish a new public key, will be similar milestone than the change of millennium.

Available service types

CD-Service

If you are using CD-Service, you receive from the RENC following:

- Base CD contain all Base Cells that are available in the RENC database when CD was released.
- Update CD contain all updates to the Base CD, but it will also contain any new Base Cells and New Edition, Re-issues received from the contributing Hydrographic Offices. Update CD will be issued once a week.

If you want to enlarge your chart coverage, you have to contact your Distributor to order more permits for new charts.

Subscription types

Charts and their Updates stored in RENC are decrypted and you have to get key (Permit) to load chart into the ECDIS. There are two different kinds of Permit to choose suitable one for your purpose.

Subscription

Subscription period is 12 months and it starts when you order first Permit(s) from the RENC.

- User subscribes to a updating service
- Updating service has a renewable expiration date
- ENC is still available after expiration, but can not apply any new information
- User will receive during the service period:
 - all updates issued to the ENC
 - any re-issues for the ENC
 - any new edition of the ENC

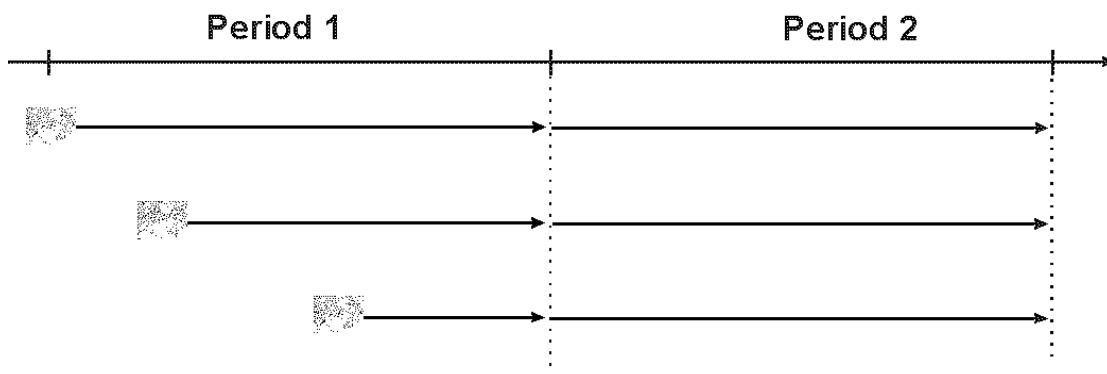

If you enlarge your chart coverage during your subscription period as shown above, will expire date of subscription for all charts be the same date.

One-Off

If you use One-Off Permit, you order permit for chart and updates which are valid until date you order permit (i.e. Chart is up-to-date when you ordered it). No more information can be retrieved for this chart, which is published after order date.

One-Off Current Edition; permit for a chart, which is based on data on the hard disk of the ECDIS.

One-Off the latest Edition; permit for a chart, which is the latest available based on the Product List of a RENC.

Service provided by a RENC

How to view the Coverage of the RENC service

Whenever you like to see Product List in graphical presentation, use Catalog to view it. The Catalog of S57 Chart shows the situation when you loaded the latest BASE or UPDATE CD-ROM into the ECDIS.

Note, the ECDIS keeps automatically the latest available Product List. Thus the ECDIS do not load the Product List if it is older than already loaded into the ECDIS.

1. Select Catalogue Charts as RENC

2. Selection of Displayed Charts

The chart limit boxes are colour coded as follows:

- Green** The chart is available for use in SENC format. If the source of the chart is a RENC then the chart is also up-to-date. If the source of the chart is something else than a RENC then all loaded updates are included into the SENC.
- Orange** The chart is available for use in SENC format but the chart is either not up-to-date or cancelled. Either the SENC is from old edition, the SENC misses latest updates or the chart has been cancelled..
- Red** If the chart is permit free, you do not have it available for use in SENC format and thus you cannot use the chart currently.
If the chart requires permit, you do not have the permit for the chart and you cannot use the chart currently.
- Blue** The chart is available either in ENC format, in SENC format for another software version or in SENC format for another ECDIS. For example chart is blue during SENC conversion and if you loaded a chart into the ECDIS and the system could not convert the chart into SENC format.
- Magenta** You have a permit to use the chart, but the chart is not available in SENC format and thus you cannot use the chart currently.

How to know up-to-date status of a chart from a RENC

To keep Charts up-to-date you have to check situation in a RENC about at weekly basis. The ECDIS compares used charts to Product List of RENC. If a **Permanent Warning** appears to Chart display of ECDIS, it is an indication that at least one of used charts is not up-to-date compared to the Product List, see below:

Permanent Warning

At least one of used charts is not up-to-date. Get or load latest edition and/or updates from your RENC service.
Use Chart Plan - Date Dependent to check charts

The information of available charts and their up-to-date status is available both in Catalogue and in Date Dependent window.

The easiest method to check up-to-date status is to view Catalogue and check that all required charts are indicated as green. Charts which are not up-to-date are indicated as orange. See more "How to view the Coverage of the RENC service" on page 98.

You can also use Date Dependent window on demand when you have doubt that some charts are not up-to-date or you have the Permanent Warning shown above.

Date Dependent

Cell ID	RENC edt/ upd	SENC edt/ upd	Updates Displayed until	Updates Approved until
AA5C1Q00	-/ -	2/ 0	2001 11 28 (-)	2001 11 28 (-)
AA5C1V00	-/ -	2/ 0	2001 11 28 (-)	2001 11 28 (-)
AA5C1W00	-/ -	2/ 0	2001 11 28 (-)	2001 11 28 (-)
DE316004	2/ 8 <<<	2/ 9	2001 11 28 (-)	2001 11 28 (-)
DK3DHWE	Canceled	XXX Canceled	2001 11 28 (-)	2001 11 28 (-)
DK3DI0XC	Canceled	XXX Canceled	2001 11 28 (-)	2001 11 28 (-)
DK3EHXLD	2/ 0	2/ 0	2001 11 28 (-)	2001 11 28 (-)
DK3EHXLE	1/ 4	1/ 4	2001 11 28 (-)	2001 11 28 (-)
DK3EHYPD	2/ 0	2/ 0	2001 11 28 (-)	2001 11 28 (-)
DK3EHYPE	23/ 2	23/ 2	---NVLD---	(1) ---NVLD---
DK3EI0XD	2/ 1	2/ 1	2001 11 28 (-)	2001 11 28 (-)
DK3EI0XE	2/ 0	2/ 0	2001 11 28 (-)	2001 11 28 (-)
DK3EI21D	1/ 0	1/ 0	2001 11 28 (-)	2001 11 28 (-)
DK5HHYPE	13/ 0	13/ 0	2001 11 28 (-)	2001 11 28 (-)
DK5IHYPE	6/ 1	6/ 1	2001 11 28 (-)	2001 11 28 (-)
FI49IGID	1/ 0	1/ 0	2001 11 28 (-)	2001 11 28 (-)
FI4EIHME	1/ 1 >>>	1/ 0	2001 11 28 (-)	2001 11 28 (-)
FI4EIIQR	1/ 21 >>>	1/ 0	2001 11 28 (-)	2001 11 28 (-)
NL303371	1/ 6	1/ 6	2001 11 28 (-)	2001 11 28 (-)

Latest RENC Oldest date 2001 11 28 2001 11 28
 Product List Newest date 2001 11 28 2001 11 28
 2001 10 31 Manual Updates ---NVLD--- ---NVLD---

Sync Manual Update Dates

 All SENCs

Interpret Date Dependent window as follows:

1. **RENC edt / upd**; in this field is displayed chart's edition and it's update in the RENC. The information is based on Product List you last time ordered.
2. **SENC edt / upd**; in this field is displayed chart's edition and it's update in the ECDIS.
3. Chart is not available in the RENC but it is in the ECDIS (RENC edt/upd as -/ -).
4. Chart in the ECDIS is newer than chart in the RENC (RENC edt/upd as 2/ 8 and SENC edt/ upd as 2/ 9).
5. Chart Displayed and Approved until are set based on Updates number (Updates Displayed and Approved until as NVLD indication).
6. Chart in the ECDIS is older than Chart in the RENC (RENC edt/upd as 1/ 21 and SENC edt/ upd as 1/ 0).

How to know up-to-date status of the RENC Product List

The ECDIS checks time to time when you have last time loaded the Product List from the RENC. If period of time when you loaded the Product List (i.e. newest Base CD or Update CD which is loaded into ECDIS is older than 30 days) is more than 30 days then the ECDIS gives a S57 Message as shown below:

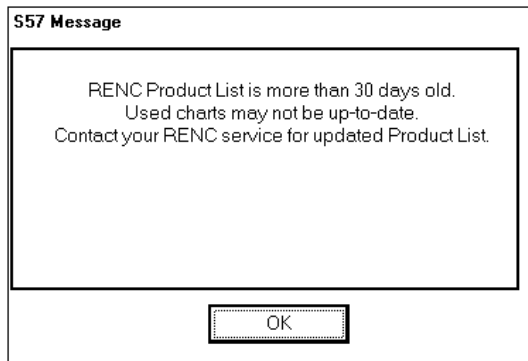

To check the date when you have last time loaded Product List of RENC, proceed as follows:

1. Press CHART PLAN push button.
2. Select **Date Dependent** from the menu.

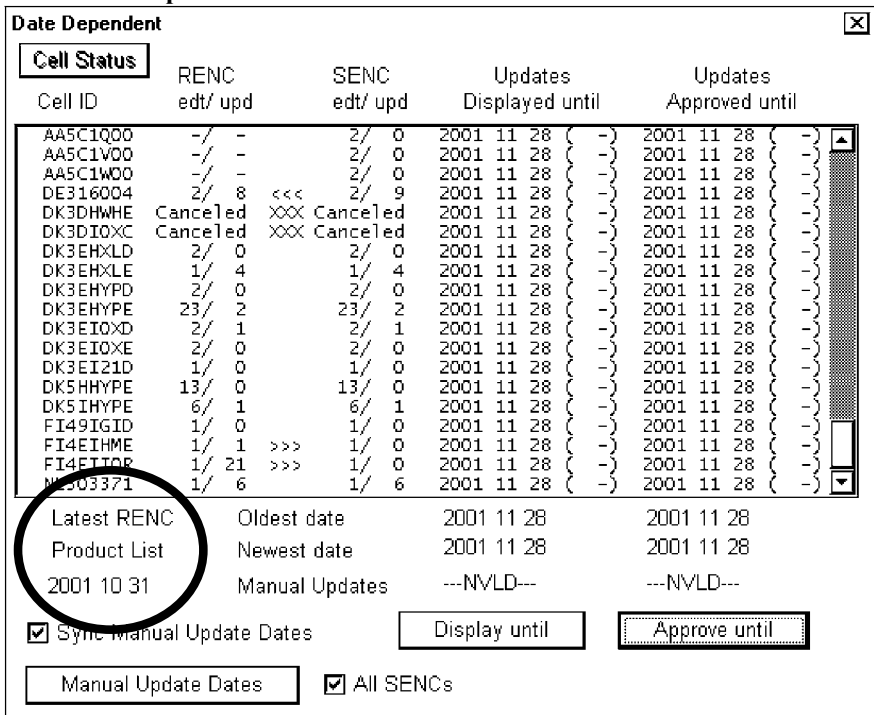

3. In lower left corner there is a date field indicating when you load last time a Product List from the RENC.

How to manage Permits from a RENC

Permits are used control the right to use a chart in the ECDIS. A permit in RENC ENC Service is connected to an edition of chart. Permits are issued as two different types:

- Subscription Permit; This include updates for subsequent 12 months.
- One-Off Permit; This include only updates up to the issue date of the Permit.

The expiry date of the Permit controls loading base charts and it's updates to the ECDIS. The ECDIS will warn you when you are loading Charts or Updates which are issued less than 30 days before expire date of the Permit. If the Permit is expired it is impossible to load Chart or it's update issued after expire date of the Permit. The user has a right to view a chart forever, but it will not comply demands for up-to-date charts.

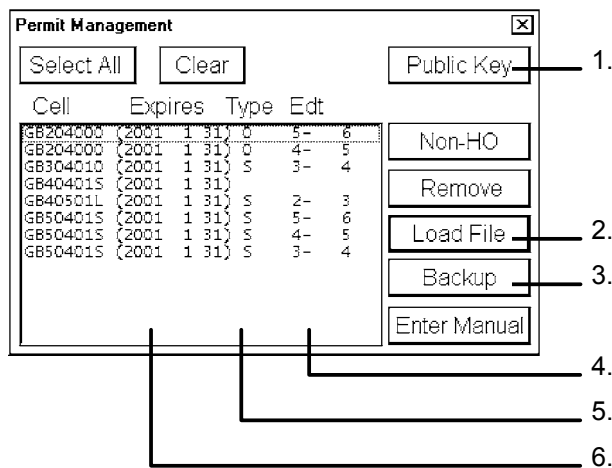

1. You can view Public Key or load a new one.
2. When you receive Permits from the RENC loading is done using Load File.
3. You can make a back-up copy of the Permits using **Backup**.
4. In a list of Permits this field indicates edition number of chart to which the Permit is valid. Note that when a new edition of Chart is issued also new Permit is needed. You can have Permit for different edition of the same Chart as shown above.
5. Type of Permit (Subscription or One-off).
6. Expiry date of permits. All Permits as subscription type will expire at the same date.

Subscription warnings

If you have at least one Permit of Subscription type, the system will automatically warn you about the expire date of your subscription licence.

Warning about soon to be expired subscription is activated every 12 hour when it is less than 30 days for expire date.

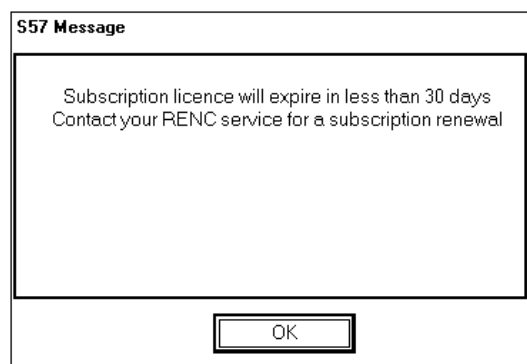

Warning about expired subscription is activated every 12 hour after the subscription expired (see lower part of the example).

NOTE!

The upper part of the example contains also a warning that the Product List is too old.

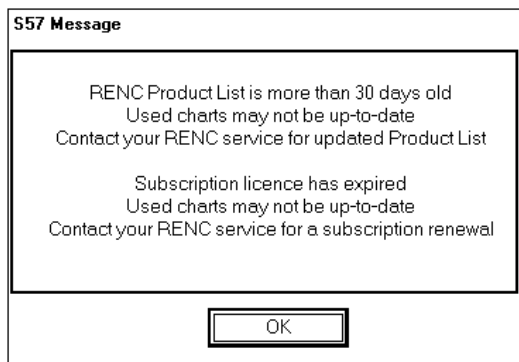

How to manage Public key from a RENC

To view Public Key or to load Public Key into the ECDIS, access to Public Key is in **Permit Management** window. Press **Public Key** button

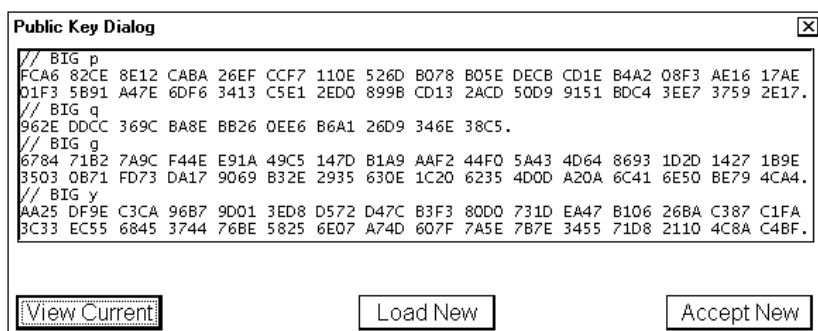
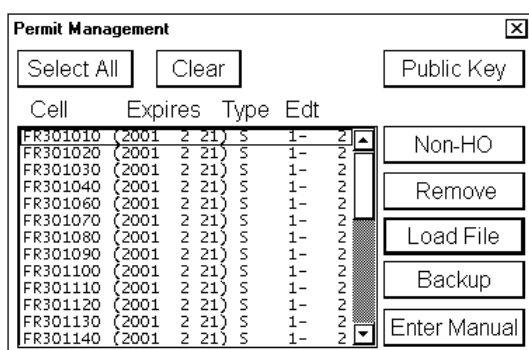

“View Current” displays current Public Key. “Load New” loads a new Public Key from *.PUB file (for example PRIMAR.PUB) and displays the content of it.

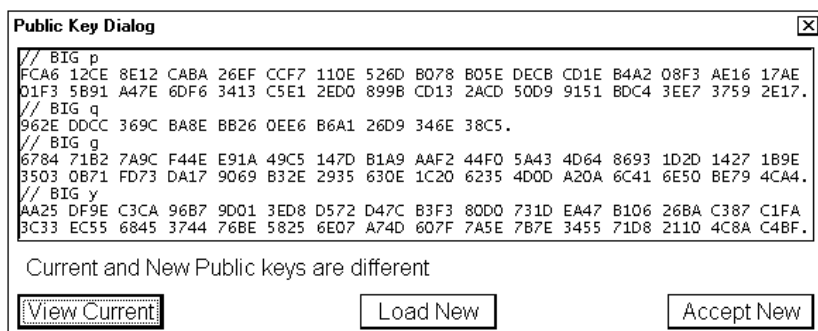

Compare the content of the loaded new Public Key to the known content of the Public Key of the RENC you use. If the content is ok, you can take the loaded new Public Key in use by "Accept New".

CD-ROM service from a RENC

How to get started with S57 charts using a RENC

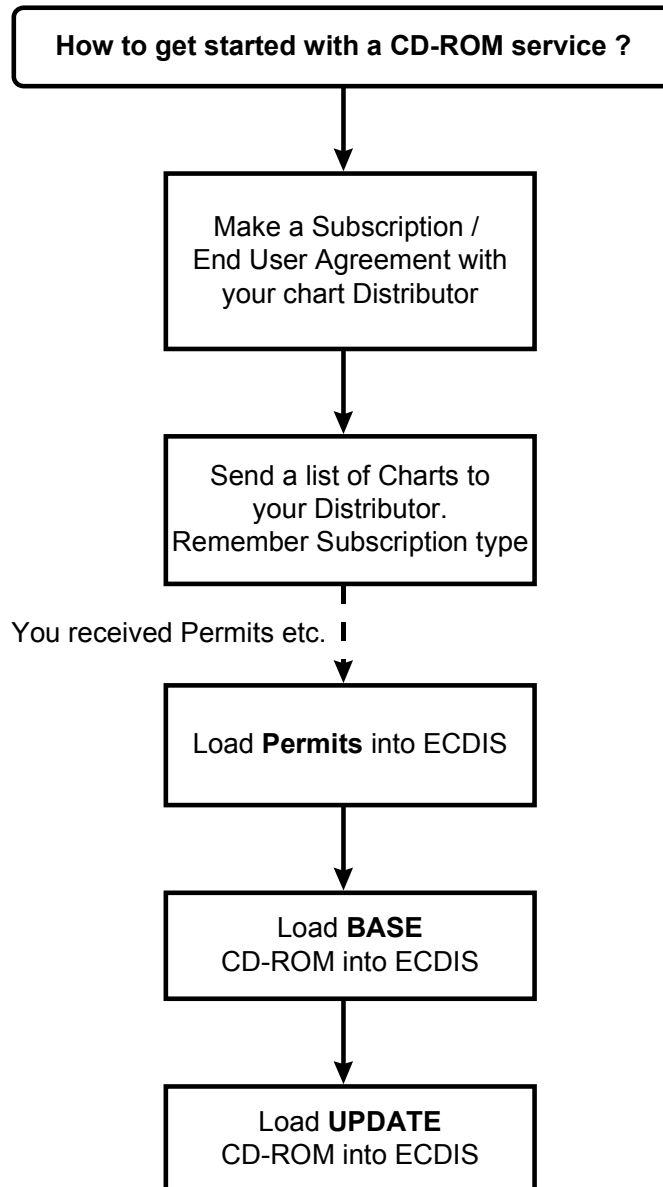

How to keep S57 charts up to date using a RENC

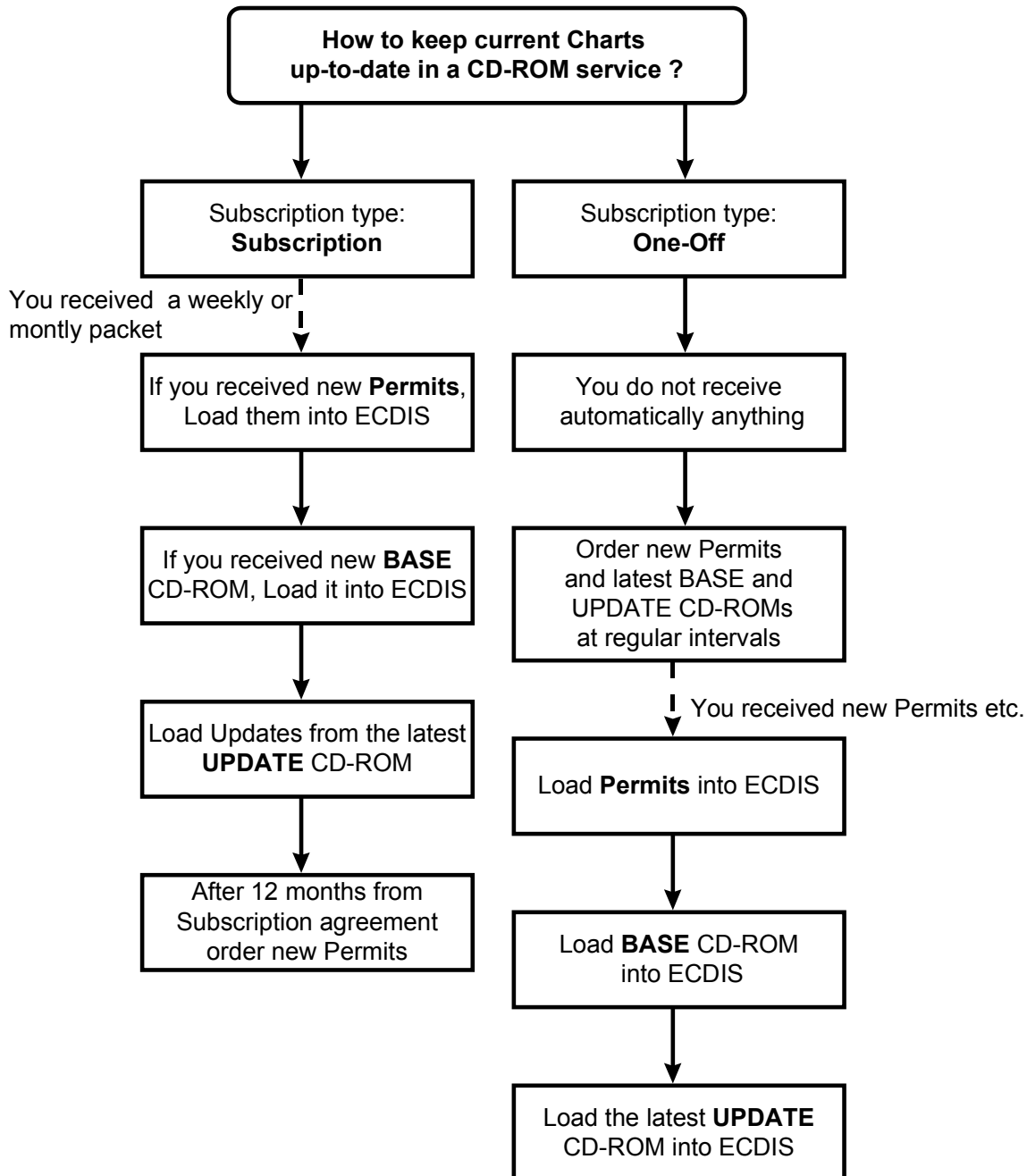

How to enlarge chart coverage using a RENC

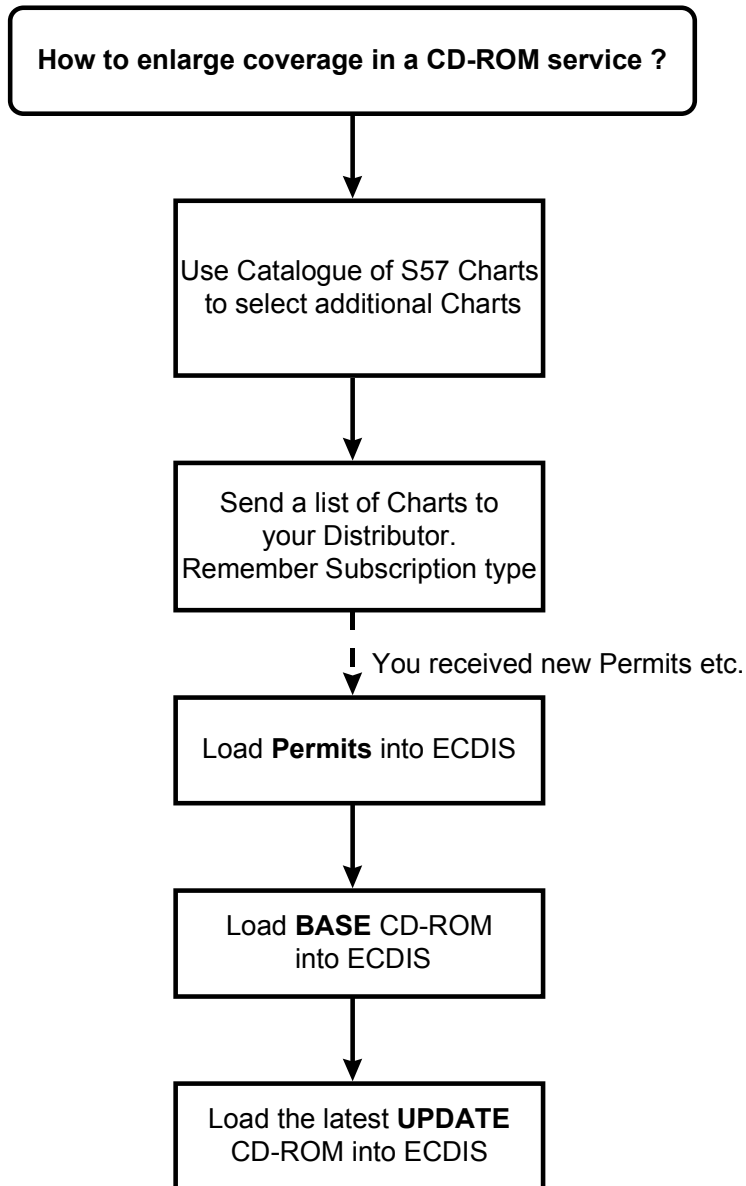

A BASE CD-ROM from a RENC

A BASE CD-ROM from a RENC contains all the Charts stored in the RENC when it was issued. When you load Charts by **CD-Catalogue** also following information is loaded into the ECDIS hard disk:

- The Content Summary of the BASE CD-ROM.
- Publisher Notes.
- The Product List.

When you receive a new BASE CD-ROM from the RENC, load Charts into the ECDIS as follows:

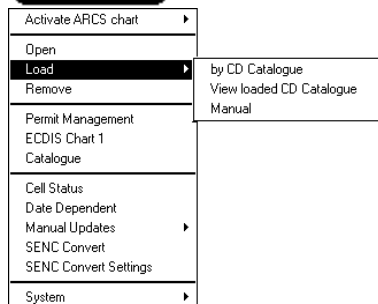
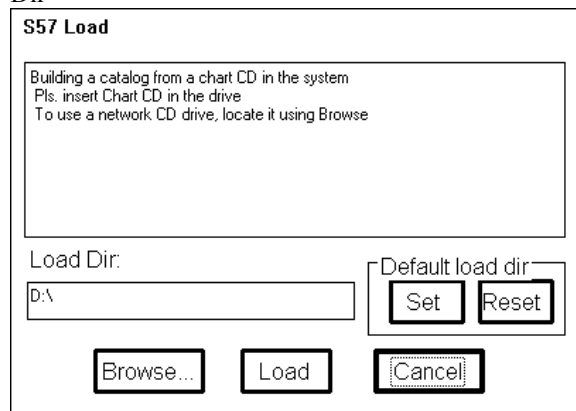

CHART PLAN push button

1. Press **CHART PLAN** push button.
2. Select **Load** from the menu and **by CD Catalogue** from the sub menu. The default load source is CD-ROM. Press **Load**, if you use CD-ROM. If you want to load from another ECDIS using LAN, you have to change Load Dir. Press **Browse** to select a new Load Dir



3. When you press **Load** button in S57 Load window, the ECDIS loads Content Summary, Publisher Notes and Product List from CD-ROM and opens **Load or View CD Catalogue** window.
4. In **Load or View CD Catalogue** window you select Charts which will be loaded into ECDIS and after selection press **Load** button to load Charts into the ECDIS. See also "Interpretation of Load or View CD Catalogue" on next page.

If you had a newer Product List already in use, you get following notice.

NOTE

It is very typical that the Product List of a BASE CD-ROM is older than the Product List in use.



Interpretation of **Load or View CD Catalogue** window:

1. The source and edition date of CD is displayed here.
2. View CD Publisher Notes
3. View CD content Summary
4. List of Charts stored in CD-ROM and also information about Edition number of Chart and amount of updates included in the Chart.
5. In Chart Selection field you can select method how to pick desired Charts from the List:
 - **Group**; if you have predefined Group of Charts the ECDIS will highlight the Charts which are available in CD-ROM.
 - **Permits**; the ECDIS will highlight the Charts which are available in CD-ROM and you have Permits.
 - **All**; the ECDIS will highlight all the Charts which are available in CD-ROM.
 - **Manual**; you can highlight desired Charts from the List.
6. Selection "Missing only" loads only Charts and their updates which are not already loaded into the ECDIS.
7. When you press **Load** button highlighted Charts are loaded into the ECDIS.

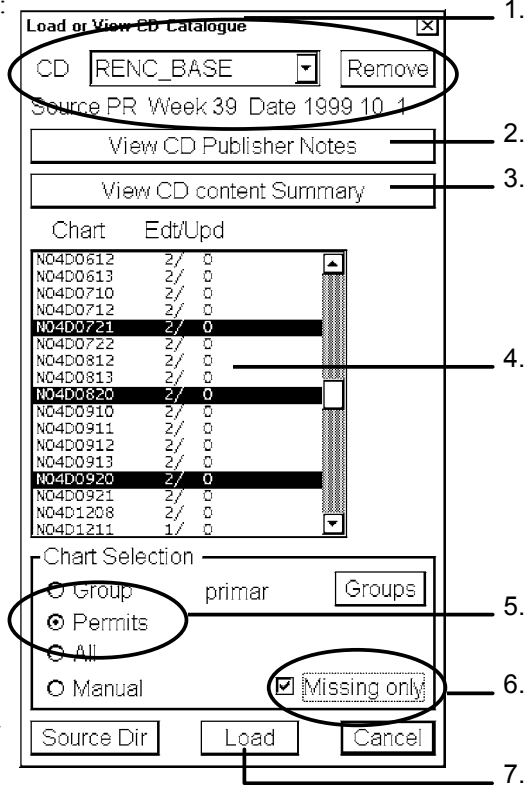

An UPDATE CD-ROM from a RENC

An UPDATE CD-ROM from a RENC contains all the Updates included to Charts stored in the RENC when the latest BASE CD-ROM was issued. When you load Charts by **CD-Catalogue** also following information is loaded into the ECDIS hard disk:

- The Content Summary of the UPDATE CD-ROM.
- Publisher Notes.
- The Product List.

When you receive a new UPDATE CD-ROM from the RENC, load Charts into the ECDIS as follows:

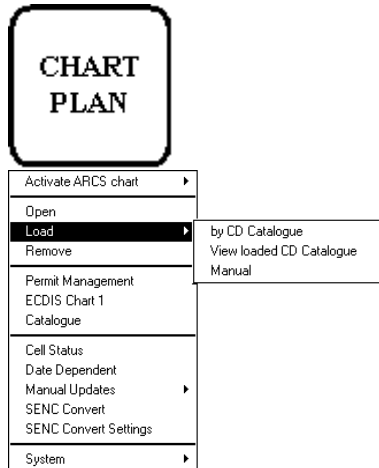
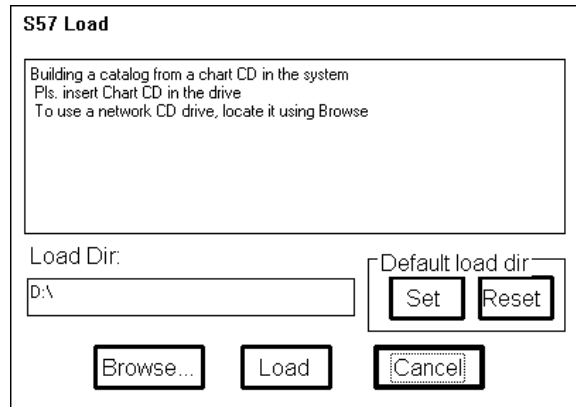

CHART PLAN push button

1. Press **CHART PLAN** push button.
2. Select **Load** from the menu and **by CD Catalogue** from the sub menu. The default load source is CD-ROM. Press **Load**, if you use CD-ROM. If you want to load from another ECDIS using LAN, you have to change Load Dir. Press **Browse** to select a new Load Dir



3. When you press **Load** button in S57 Load window, the ECDIS loads Content Summary, Publisher Notes and Product List from CD-ROM and opens **Load or View CD Catalogue** window.
4. In **Load or View CD Catalogue** window you select Charts which will be loaded into ECDIS and after selection press **Load** button to load Charts into the ECDIS. See also "Interpretation of Load or View CD Catalogue" on next page.

If you had a newer Product List already in use, you get following notice.



Interpretation of **Load or View CD Catalogue** window:

1. The source and edition date of CD is displayed here.
2. View CD Publisher Notes
3. View CD content Summary
4. List of Charts stored in CD-ROM and also information about Edition number of Chart and amount of updates included in the Chart.
5. In Chart Selection field you can select method how to pick desired Charts from the List:
 - **Group**; if you have predefined Group of Charts the ECDIS will highlight the Charts which are available in CD-ROM.
 - **Permits**; the ECDIS will highlight the Charts which are available in CD-ROM and you have Permits.
 - **All**; the ECDIS will highlight all the Charts which are available in CD-ROM.
 - **Manual**; you can highlight desired Charts from the List.
6. Selection "Missing only" loads only Charts and their updates which are not already loaded into the ECDIS.
7. When you press **Load** button highlighted Charts are loaded into the ECDIS.

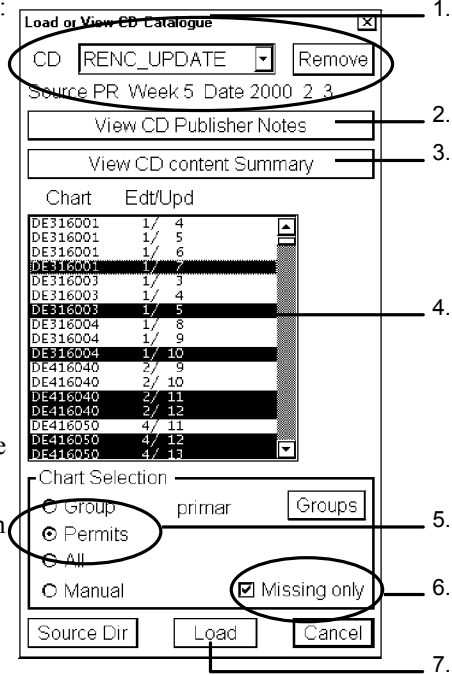

How to view Coverage of a BASE or UPDATE CD-ROM from a RENC



1. Press CHART PLAN push button and select **Catalogue** from the menu.
2. A Catalogue window appears. Below is an example, when the CD Catalogue is from an UPDATE CD-ROM from a RENC

Activate ARCS chart	▶
Open	
Load	▶
Remove	
Permit Management	
ECDIS Chart 1	
Catalogue	
Cell Status	
Date Dependent	
Manual Updates	▶
SENC Convert	
SENC Convert Settings	
System	
	▶

Mon.Route	Plan Route 0-MERID	Pilot Data	Predictor 60 sec	North Up	RM	TrueVect 12 min																																																																																																																																					
UserChart	Ref Target	ARPA 2 Radar SINDEL_2		TM reset off																																																																																																																																							
<table border="1"> <tr> <td colspan="2">Catalogue</td> <td colspan="2">58°59.332'N Gyro 240.0°</td> <td colspan="2">021°30.230'E COG 240.0°</td> <td colspan="2">WGS 84 (pos)</td> </tr> <tr> <td colspan="2"></td> <td colspan="2">DGPS</td> <td colspan="2">SOG 17.1 Kt</td> <td colspan="2"></td> </tr> <tr> <td>Plan Speed</td> <td>Kt</td> <td>To W/P</td> <td></td> <td>Dist WOP</td> <td>nm</td> <td></td> <td></td> </tr> <tr> <td>Plan</td> <td>°</td> <td>Time</td> <td></td> <td>Next W/P</td> <td></td> <td></td> <td></td> </tr> <tr> <td>Route</td> <td>m</td> <td>Next</td> <td></td> <td>Turn rad</td> <td></td> <td></td> <td></td> </tr> <tr> <td>Ch limit</td> <td>m</td> <td>Turn rate</td> <td></td> <td></td> <td></td> <td></td> <td></td> </tr> <tr> <td>Off track</td> <td>m</td> <td></td> <td></td> <td></td> <td></td> <td></td> <td></td> </tr> </table>							Catalogue		58°59.332'N Gyro 240.0°		021°30.230'E COG 240.0°		WGS 84 (pos)				DGPS		SOG 17.1 Kt				Plan Speed	Kt	To W/P		Dist WOP	nm			Plan	°	Time		Next W/P				Route	m	Next		Turn rad				Ch limit	m	Turn rate						Off track	m																																																																																			
Catalogue		58°59.332'N Gyro 240.0°		021°30.230'E COG 240.0°		WGS 84 (pos)																																																																																																																																					
		DGPS		SOG 17.1 Kt																																																																																																																																							
Plan Speed	Kt	To W/P		Dist WOP	nm																																																																																																																																						
Plan	°	Time		Next W/P																																																																																																																																							
Route	m	Next		Turn rad																																																																																																																																							
Ch limit	m	Turn rate																																																																																																																																									
Off track	m																																																																																																																																										
<table border="1"> <tr> <td colspan="7">View filters</td> </tr> <tr> <td><input checked="" type="checkbox"/> Name</td> <td colspan="2"><input type="checkbox"/> Navigation purpose</td> <td colspan="4"></td> </tr> <tr> <td><input type="checkbox"/> Permit</td> <td colspan="2"><input checked="" type="checkbox"/> Overview</td> <td colspan="4"></td> </tr> <tr> <td><input type="checkbox"/> RENC Cancelled Charts</td> <td colspan="2"><input checked="" type="checkbox"/> General</td> <td colspan="4"></td> </tr> <tr> <td colspan="7">Group Charts</td> </tr> <tr> <td><input checked="" type="checkbox"/> Catalogue Charts</td> <td colspan="2"><input checked="" type="checkbox"/> Coastal</td> <td colspan="4"></td> </tr> <tr> <td><input type="radio"/> RENC</td> <td><input type="radio"/> SENC</td> <td colspan="2"><input checked="" type="checkbox"/> Approach</td> <td colspan="3"></td> </tr> <tr> <td><input checked="" type="radio"/> CD</td> <td><input type="radio"/> RENC_BASE</td> <td colspan="2"><input checked="" type="checkbox"/> Harbour</td> <td colspan="3"></td> </tr> <tr> <td></td> <td></td> <td colspan="2"><input checked="" type="checkbox"/> Berthing</td> <td colspan="3"></td> </tr> <tr> <td colspan="7">Selected chart</td> </tr> <tr> <td colspan="7">Cell ID:</td> </tr> <tr> <td><input type="checkbox"/> Permit</td> <td colspan="2"><input type="checkbox"/> SENC</td> <td colspan="4"></td> </tr> <tr> <td colspan="7">Cell Status Open</td> </tr> <tr> <td colspan="7">Group</td> </tr> <tr> <td>Edit</td> <td colspan="2">GULFFINL</td> <td colspan="4">Groups</td> </tr> <tr> <td>Add Frame</td> <td>Remove Frame</td> <td>Done</td> <td colspan="4">Cancel</td> </tr> <tr> <td colspan="7">Previous</td> </tr> <tr> <td colspan="7">Cursor</td> </tr> <tr> <td colspan="7">From Own Ship:</td> </tr> </table>							View filters							<input checked="" type="checkbox"/> Name	<input type="checkbox"/> Navigation purpose						<input type="checkbox"/> Permit	<input checked="" type="checkbox"/> Overview						<input type="checkbox"/> RENC Cancelled Charts	<input checked="" type="checkbox"/> General						Group Charts							<input checked="" type="checkbox"/> Catalogue Charts	<input checked="" type="checkbox"/> Coastal						<input type="radio"/> RENC	<input type="radio"/> SENC	<input checked="" type="checkbox"/> Approach					<input checked="" type="radio"/> CD	<input type="radio"/> RENC_BASE	<input checked="" type="checkbox"/> Harbour							<input checked="" type="checkbox"/> Berthing					Selected chart							Cell ID:							<input type="checkbox"/> Permit	<input type="checkbox"/> SENC						Cell Status Open							Group							Edit	GULFFINL		Groups				Add Frame	Remove Frame	Done	Cancel				Previous							Cursor							From Own Ship:						
View filters																																																																																																																																											
<input checked="" type="checkbox"/> Name	<input type="checkbox"/> Navigation purpose																																																																																																																																										
<input type="checkbox"/> Permit	<input checked="" type="checkbox"/> Overview																																																																																																																																										
<input type="checkbox"/> RENC Cancelled Charts	<input checked="" type="checkbox"/> General																																																																																																																																										
Group Charts																																																																																																																																											
<input checked="" type="checkbox"/> Catalogue Charts	<input checked="" type="checkbox"/> Coastal																																																																																																																																										
<input type="radio"/> RENC	<input type="radio"/> SENC	<input checked="" type="checkbox"/> Approach																																																																																																																																									
<input checked="" type="radio"/> CD	<input type="radio"/> RENC_BASE	<input checked="" type="checkbox"/> Harbour																																																																																																																																									
		<input checked="" type="checkbox"/> Berthing																																																																																																																																									
Selected chart																																																																																																																																											
Cell ID:																																																																																																																																											
<input type="checkbox"/> Permit	<input type="checkbox"/> SENC																																																																																																																																										
Cell Status Open																																																																																																																																											
Group																																																																																																																																											
Edit	GULFFINL		Groups																																																																																																																																								
Add Frame	Remove Frame	Done	Cancel																																																																																																																																								
Previous																																																																																																																																											
Cursor																																																																																																																																											
From Own Ship:																																																																																																																																											

1. Select Catalogue Charts as CD and select desired name from list box

2. Selection of Displayed Charts

For more information about colours of border line on Catalogue window, see chapter "Catalogue of S57 cells" on page 88.

A Permit CD-ROM or floppy disk from the RENC

The RENC can deliver Permits either stored in CD-ROM or stored in floppy disk. When you received new permits from the RENC you have to load them into the ECDIS. The permit is a key which is used to decrypt the Chart you want to use in the ECDIS. To load Permits, proceed as follows:

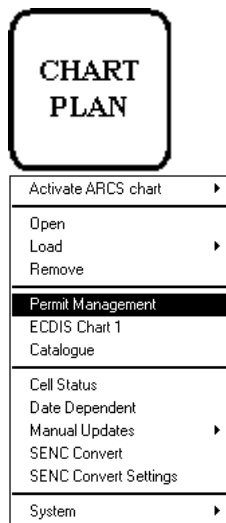
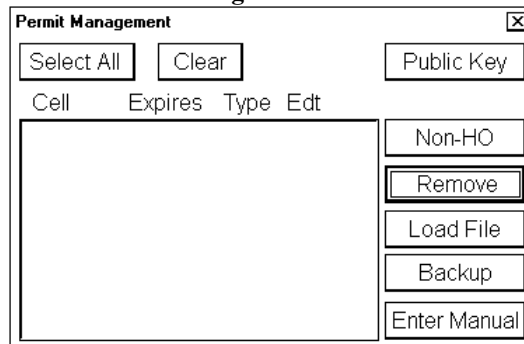

CHART PLAN push button

1. Press CHART PLAN push button.
2. Select **Permit Management** from the menu.



Press **Load File** in Permit Management window.

3. Select correct drive from **Look in** list box

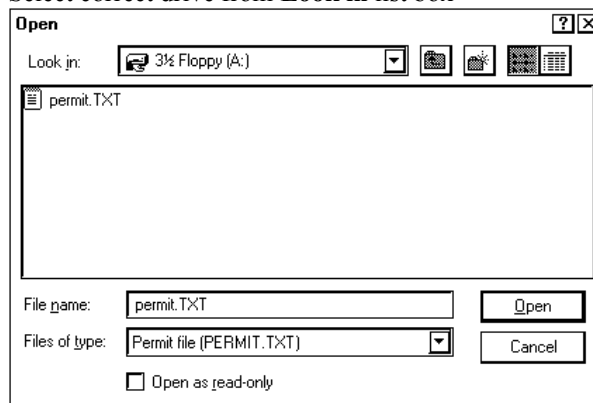

Permits can be available in two formats.

- **PERMIT.TXT** which contain Permits, their editions and subscription types. This is the preferred format.
- *.PMT which as received from a RENC contain Permits, but no edition or subscription information. NOTE! *.PMT format is used by the system for backup of Permits. As a backup it contain also subscription type and edition.

Select suitable permit file and press **Open** button to load Permits.

4. In Permit Management window displays Permits which are loaded into the ECDIS.

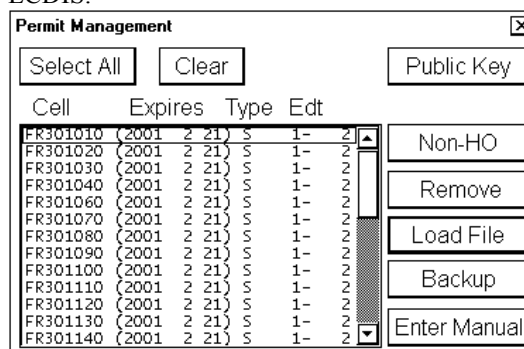

Messages in Permit load

If you try to load One-off Permit for a Chart for which you already have a Subscription Permit, you get following message:

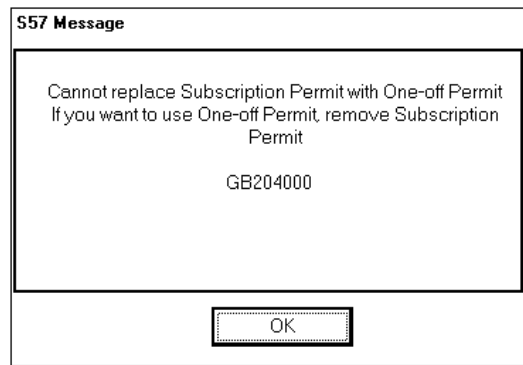

If you load Permits for different ECDIS, you get following message:

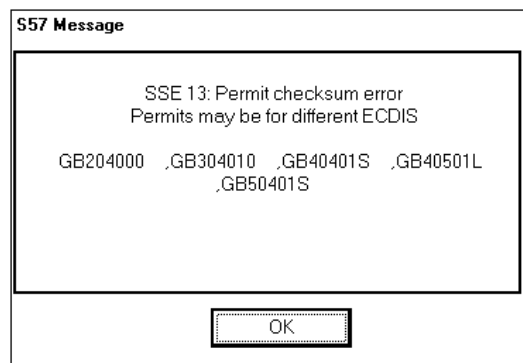

RENC security system

Standard messages in S57 Chart Load

During loading S57 Charts into the ECDIS you may get different kind of messages. For more information of standard messages in S57 Chart Load, see chapters "Messages, which contain only notice" and "Messages, which require careful attention" on page77.

Additional messages in S57 Chart Load

Issue control of BASE and UPDATE CD-ROM from RENC

CD-ROMs from a RENC has issue control. If you later use CD Catalogue created during load of S57 charts, you get following messages for a wrong CD-ROM.

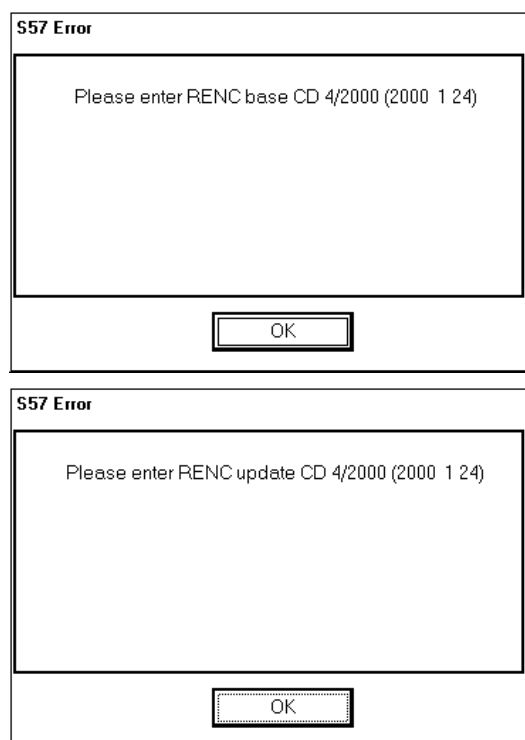

Messages, which contain only notice

If you tried to load charts for which you do not have permit, you will get one of the following messages:

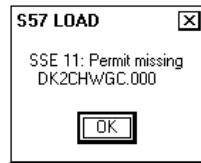

Messages, which require careful attention

All messages in this chapter change the legal status of the charts in your system. Study these message extremely careful because you may need to use paper charts to fulfil SOLAS requirements

You do not have a valid Permit

A Chart was not converted into SENC because the Permit has expired.

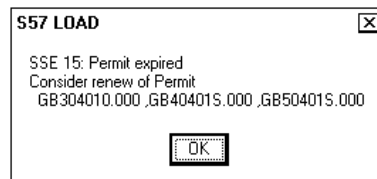

A Chart was not converted into SENC because a Permit with unknown edition was for different edition.

You can check edition of the Permit using Permit Management window and the edition of Chart using Cell Status window.

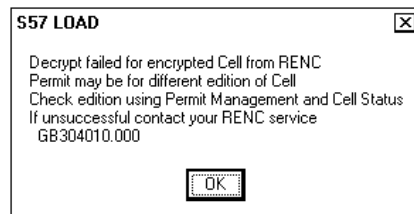

Typical reason is that the chart has been updated too many times as new edition instead of update. Ask for new permits from your chart agent.

A Chart was not converted into SENC because your Permit was for different edition.

You can check edition of the Permit using Permit Management window and the edition of Chart using Cell Status window.

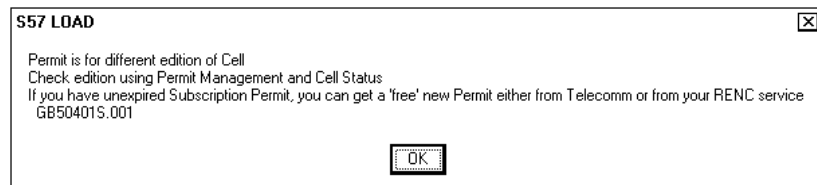

Typical reason is that the chart has been updated too many times as new edition instead of update. Ask for new permits from your chart agent.

A Chart was not converted into SENC because the software, data and system time in the ECDIS indicates tampering.

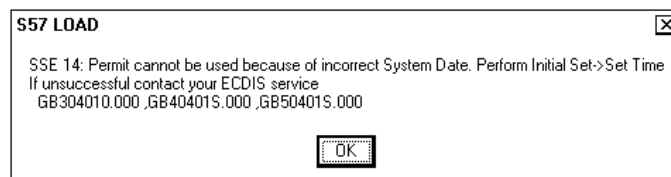

Typical reason is that RENC released chart before the issue date of the chart.

Authentication of chart failed

The Chart is not loaded because of missing Signature.

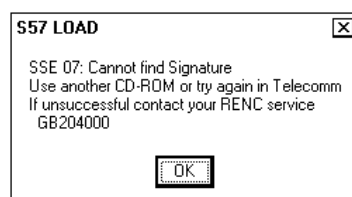

The Chart is not loaded because of coding error in Signature.

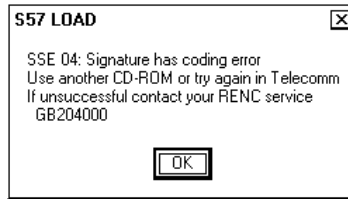

The Chart is not loaded because of tampered Signature or not valid Public Key

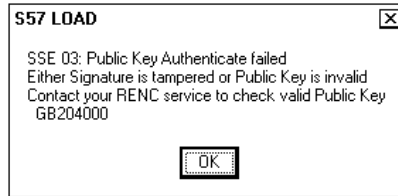

The Chart is not loaded because of invalid or tampered Signature

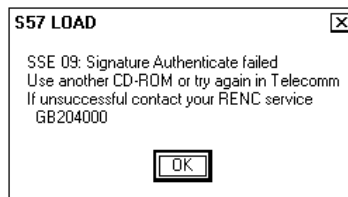

Standard messages in S57 SENC conversion

When converting S57 Charts into the ECDIS you may get different kind of messages. For more information of standard messages in S57 SENC conversion, see chapters "Messages, which contain only notice" and "Messages, which require careful attention" on page77.

Additional messages in S57 SENC conversion

Messages, which contain only notice

You do not have a Permit

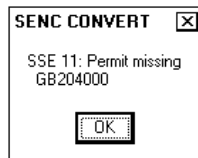

Messages, which require careful attention

Your Permit has expired

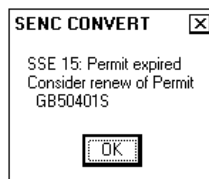

You have a Permit, but it is valid for another edition of the Cell.

You can check edition of the Permit using Permit Management window and the edition of Chart using Cell Status window.

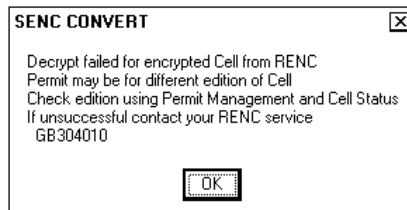

Typical reason is that the chart has been updated too many times as new edition instead of update. Ask for new permits from your chart agent.

Vector chart display

How to select Vector chart material in use

To select S57 chart material onto the display proceed as follow:

1. From Control Panel press **CHART PLAN** push button.
2. From menu check that there is a following text in first line: **Activate ARCS chart**. If it is, then go to step 4.
3. If there is text **Activate S57 chart** choose this command.
4. You have now selected S57 charts on display.

How to select charts for viewing

Select a chart from catalogue

To select a chart for viewing from **Catalogue**, proceed as follow:

1. From Control Panel press **CHART PLAN** push button.
2. Select **Catalogue** command from the menu.
3. From the catalogue window pick by cursor the desired chart. For more information, see chapter "Catalogue of S57 cells" on page 88.
4. Press button **Open**.

Browsing around your charts

Viewing S57 charts from different positions and using different scales is very easy. Basic tools to browse around are push buttons **ZOOM IN**, **ZOOM OUT**, **SET CHART CENTER**, **SHIP OFF CENTER** and **TM/CU RESET**.

You can use **SET CHART CENTER** to look ahead any other place than your own ship position. Pressing it set automatic True Motion Reset OFF. When TM Reset is OFF you have on upper right hand part of the display either indication **Ship out of dsp** or **TM RESET OFF** depending of the view.

You can enter numerical values for center of the chart display. Press **DISPLAY MODE** push button and select **Set Center** from the menu, a Chart Center dialog box appears:

True Motion North Up True Motion Course Up Relative Motion North Up Relative Motion Course Up Relative Motion Head Up Relative Motion Route Up <hr/> Set Center	Chart Center Lat: <input type="text" value="60°13.686N"/> Lon: <input type="text" value="024°57.897E"/> -- - + ++ -- - + ++ <input type="button" value="Set Center"/>
---	---

Enter desired values for center of chart display.

If you want immediately back to your own ship position, push **TM/CU RESET**.

ZOOM IN and **ZOOM OUT** are used to change scale of chart. If TM reset is active, **ZOOM IN** and **ZOOM OUT** keep the relative position of the own ship respect to the display. If TM Reset is OFF, **ZOOM IN** and **ZOOM OUT** keep the relative position pointed by cursor respect to the display.

The system has a logical way to automatically select next larger or smaller scale. The system has an indication of **LARGER SCALE DATA EXISTS**, if there exist a chart with larger compilation scale available at your current viewing position.

Look charts around your own ship

You can use either **TRUE MOTION** or **RELATIVE** motion. Refer to **DISPLAY MODE** chapter. In True motion your own ship moves until it reaches the true motion reset borderline. Then it will jump back to opposite position on screen based on its course. In relative motion your own ship stays in a fixed position, while the chart under it moves on screen.

If you use true motion and you press **TM/CU RESET**, your ship will immediately jump to true motion reset position.

If you use true motion and you press **SHIP OFF CENTER**, your ship will go to that position on screen and continue true motion movement from that position. When it reaches true motion reset borderline it will automatically jump to true motion reset position.

If you use relative motion and you press **TM/CU RESET**, your ship will immediately jump to true motion reset position and use that position as fixed position to stay on screen.

If you use relative motion, you can select a new fixed position to your ship by pressing **SHIP OFF CENTER** push button.

Use **ZOOM IN** and **ZOOM OUT** push buttons to select desired scale of the chart display.

How to select a chart by its name on display

To select a specific S57 chart cell onto the display use **Open** menu command. Proceed as follows:

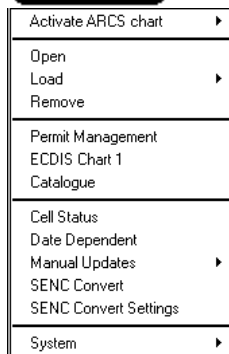

1. From Control Panel press Chart Plan pushbutton.
2. From menu check that there is a following text in first line: **Activate ARCS chart**. If it is, then go to step 4.
3. If there is text **Activate S57 chart** choose this command.
4. Select **Open** command from the menu.

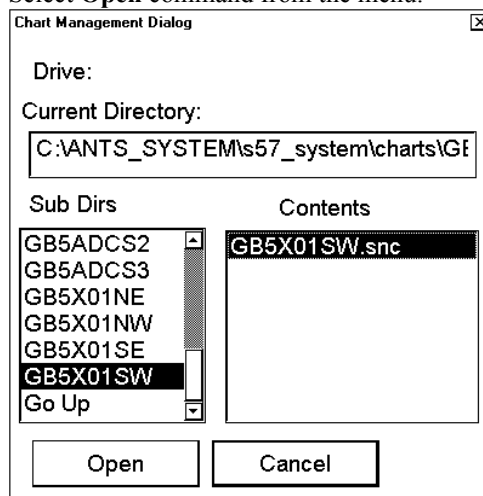

5. Choose desired chart from chart list dialog and press **Open** button.
6. When you select a chart it will be displayed automatically in the Electronic chart area.

Control of visible chart features

When you press **CHART DISPLAY** pushbutton, you get Chart details window, which have several sheets to control visible chart features.

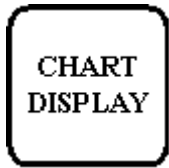

CHART DISPLAY push button. Dialog box which appears after pressing chart display push button.

Chart display - ALL-ON		
Tracking	Mariner	Route
Chart	Standard	Other
Echo alarm	2 m	
Shallow contour	2 m	
Safety depth	15 m	
Safety contour	10 m	
Deep contour	20 m	
Speed Vectors	12 min	TRUE
TM reset margin	80 %	
Scale	1:20000	
Palette	DAY BRIGHT	
Symbols	SIMPLIFIED	
Depths	TWO COLOUR	
Boundaries	SYMBOLIZED	
Light sectors	LIMITED	
Shallow pattern	NONE	
Update highlight	ALL EFFECTS	

"Chart"-sheet

Echo alarm depth:

User can set alarm limit for echosounder. If depth of water below transducer of the Echosounder is below the limit, an alarm will be generated.

Shallow contour:

User can set value of shallow water contour.

Safety depth:

User can set the value of safety depth. Spot soundings below the Safety depth are displayed as highlighted.

Safety contour:

User can set value of safety contour. Visible safety contour is equal to set value or if the contour of set value is not available then the visible safety contour is next deeper contour than safety contour.

Note, the system uses Safety contour also for Chart Alarms.

Deep contour:

User can set deep water contour.

Speed Vectors:

User can set vector time and presentation type for speed vectors displayed on ECDIS screen. Selected presentation type and length for speed vectors is indicated Upper right hand corner of ECDIS screen.

True Vectors = TrueVect

Relative Vectors = RelVect

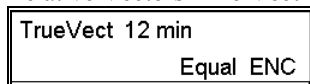

TM reset margin:

In True motion your own ship moves until it reaches the true motion reset borderline. Then it will jump back to opposite position on screen based on its course. User can set the limit for TM reset.

Scale:

This function determines the displayed scale of the electronic chart.

Black and grey colour symbol:



This symbol is used to verify that you can distinguish black (frame of symbol) and grey (inner part of symbol) colours with current contrast and brilliance settings.

Palette:

Enable user to choose appropriate palette for display depending on brightness of the bridge.

Symbols:

Enable user to choose how to display symbols of the chart. The options are:

- **Simplified**, the shape of symbols is of modern design and the sea mark symbols use colour fill
- **Paper Chart**, the shape of symbols imitates traditional symbols used in paper charts

Depth:

User can set how to display different depth zones on the chart display. If user selects multicolour, the chart display uses 4 different colours:

- deeper than user-selected deep contour
- between deep contour and user-selected safety contour
- between safety contour and user-selected shallow water contour
- between shallow water contour and coastline.

If user selects two colours, the chart display uses only two colours:

- deeper than safety contour
- shallower than safety contour

Boundaries:

User can set how to display boundaries of some chart features. The options are:

- **Plain**, the used line styles are limited to plain solid and dashed lines.
- **Symbolized**, some of the used line styles use symbols to highlight the purpose of a line

Light sector:

User can set how to display light sectors. The options are:

- **Limited**, the length of light sector is fixed at 25 mm independently of the displayed scale.
- **Full**, the length of light sector represent its nominal range as defined by the chart producer.

Shallow pattern:

User can set how to display shallow water area. The options are:

- **None**
- **Diamond**, is provided to distinguish shallow water at night

Update Highlight:

User can set how the updates are highlighted on the screen before they are approved by the user. The options are

- **Detailed**, system try to highlight updates so that only those objects, which has visible changes, are highlighted. Use this option to see the practical change of an update.
- **All effects**, system highlights updates so that all the objects, which has something to do with updates, are highlighted although some of them has not been changed from practical point of view.

CHART DISPLAY

Press **CHART DISPLAY** button to open Chart details dialog box. Standard display includes chart features shown here. The system will show these chart features, when button **STANDARD DISPLAY** is pressed.

Chart display - ALL-ON *		
Tracking	Mariner	Route
Chart	Standard	Other
<input checked="" type="checkbox"/>	<input type="checkbox"/>	<input type="checkbox"/>
Unknown object or presentation		
<input checked="" type="checkbox"/>	<input type="checkbox"/>	<input type="checkbox"/>
Chart data coverage		
<input checked="" type="checkbox"/>	<input type="checkbox"/>	<input type="checkbox"/>
Land features		
<input checked="" type="checkbox"/>	<input type="checkbox"/>	<input type="checkbox"/>
Water and seabed features		
<input checked="" type="checkbox"/>	<input type="checkbox"/>	<input type="checkbox"/>
Traffic routes		
<input type="checkbox"/>	<input type="checkbox"/>	<input type="checkbox"/>
Cautionary areas		
<input checked="" type="checkbox"/>	<input type="checkbox"/>	<input type="checkbox"/>
Information areas		
<input checked="" type="checkbox"/>	<input type="checkbox"/>	<input type="checkbox"/>
Buoys and beacons		
<input checked="" type="checkbox"/>	<input type="checkbox"/>	<input type="checkbox"/>
Lights		
<input checked="" type="checkbox"/>	<input type="checkbox"/>	<input type="checkbox"/>
Fog signals		
<input checked="" type="checkbox"/>	<input type="checkbox"/>	<input type="checkbox"/>
Radar		
<input checked="" type="checkbox"/>	<input type="checkbox"/>	<input type="checkbox"/>
Services		

“STANDARD”-sheet

Sheet STANDARD contains chart features as defined by IMO to form so called Standard Display. You can recall at any time the Standard Display by single operator action (by pressing STANDARD DISPLAY push button from Control Panel).

CHART DISPLAY

Other includes chart features shown here. The system will not show these features, when button **STANDARD DISPLAY** is pressed.

Chart display - ALL-OFF *		
Tracking	Mariner	Route
Chart	Standard	Other
<input type="checkbox"/>	<input type="checkbox"/>	<input type="checkbox"/>
Information about chart data		
<input checked="" type="checkbox"/>	<input type="checkbox"/>	<input type="checkbox"/>
Land features		
<input checked="" type="checkbox"/>	<input type="checkbox"/>	<input type="checkbox"/>
Soundings		
<input type="checkbox"/>	<input type="checkbox"/>	<input type="checkbox"/>
Depth contours, Currents, Magnetics		
<input type="checkbox"/>	<input type="checkbox"/>	<input type="checkbox"/>
Seabed and Obstructions		
<input type="checkbox"/>	<input type="checkbox"/>	<input type="checkbox"/>
Services and Small craft facilities		
<input type="checkbox"/>	<input type="checkbox"/>	<input type="checkbox"/>
Special areas		
<input checked="" type="checkbox"/>	<input type="checkbox"/>	<input type="checkbox"/>
Additional information available		
Important Text		
<input checked="" type="checkbox"/>	<input type="checkbox"/>	<input type="checkbox"/>
Clearances, Bearings, Radio channels		
Other Text		
<input checked="" type="checkbox"/>	<input type="checkbox"/>	<input type="checkbox"/>
Names for position reporting		
<input checked="" type="checkbox"/>	<input type="checkbox"/>	<input type="checkbox"/>
Light descriptions		
<input type="checkbox"/>	<input type="checkbox"/>	<input type="checkbox"/>
Nature of Seabed		
<input type="checkbox"/>	<input type="checkbox"/>	<input type="checkbox"/>
Geographic names, etc.		
<input type="checkbox"/>	<input type="checkbox"/>	<input type="checkbox"/>
Swept depths, Magnetics		
<input type="checkbox"/>	<input type="checkbox"/>	<input type="checkbox"/>
Berth and Anchorage numbers		
<input type="checkbox"/>	<input type="checkbox"/>	<input type="checkbox"/>
National language, Land elevation		

“OTHER”-sheet

Sheet OTHER contains chart features, for which you can control visibility and which are not part of IMO defined Standard Display.

Note! If you want to use Info request by cursor pick, you have to select desired chart features to be displayed from this sheet.

Note! Chart details window appears, when user press CHART DISPLAY push button. Use SELECT NEXT to open desired sheet in Chart details windows.

Display Base

A subset of chart features is called as Display base. As required by IMO, these features cannot be made invisible under any user selection. The **Display Base** consist of following chart features:

- coastline (high water)
- own ship's safety contour, which is selected by the user
- indication of isolated underwater dangers of depths less than the safety contour, which lie within the safe waters defined by the safety contour
- indication of isolated dangers, which lie within the safe water defined by the safety contour such as bridges, overhead wires, etc., and including buoys and beacons whether or not these are being used as aids to navigation
- traffic routine systems
- scale, range, orientation and display mode
- units of depth and height

Control of visible navigation features

Visibility control of the navigation features is divided into three sheets. Sheet Route controls Planned and Monitored route. Sheet Tracking control past tracks and some other features. Sheet Mariner control Pilot data, User charts and Chart alarms. Press CHART DISPLAY button to open Chart details window. Use SELECT NEXT to open desired sheet in Chart details window.

User can define settings for chart details which are displayed over chart area. This means that user can select different layers to be **Off**, **Std** or **Other**. Selection of **Off** is self explanatory. Selection of **Std** is set as visible, if the STANDARD DISPLAY button is pressed. Selection of **Other** is set as invisible, if the STANDARD DISPLAY button is pressed

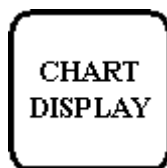

Monitored and planned routes are non-chart information. All the selected items are shown on top of chart data

Chart details - ALL-ON *		
Chart	Standard	Other
Tracking	Mariner	Route
-Monitored route-		
Off	Std	Other
<input type="radio"/>	<input checked="" type="radio"/>	<input type="radio"/>
	Center line	
<input type="radio"/>	<input checked="" type="radio"/>	<input type="radio"/>
	Channel borders	
<input type="radio"/>	<input type="radio"/>	<input checked="" type="radio"/>
	WP - mark	
<input type="radio"/>	<input type="radio"/>	<input checked="" type="radio"/>
	Leg mark	
<input checked="" type="radio"/>	<input type="radio"/>	<input type="radio"/>
	Wheel over line	
-Planned route-		
Off	Std	Other
<input type="radio"/>	<input checked="" type="radio"/>	<input type="radio"/>
	Center line	
<input type="radio"/>	<input type="radio"/>	<input checked="" type="radio"/>
	Channel borders	
<input type="radio"/>	<input type="radio"/>	<input checked="" type="radio"/>
	WP - mark	
<input type="radio"/>	<input type="radio"/>	<input checked="" type="radio"/>
	Leg mark	

"ROUTE" sheet

Sheet ROUTE contain selection of route related navigation features

Monitored route, user can select which part of monitored route is displayed.

Planned route, user can select which part of planned route is displayed.

CHART DISPLAY

*Past tracks,
Predictor ship,
Events & Positions,
ARPA targets,
Reference targets
and Radaroverlay
are non-chart
information. All the
selected items are
shown on top of
chart data.*

Chart display - ALL-ON		
<input type="radio"/> Chart	<input type="radio"/> Standard	<input type="radio"/> Other
<input checked="" type="radio"/> Tracking	<input type="radio"/> Mariner	<input type="radio"/> Route
Past tracks		
<input type="radio"/> Off <input type="radio"/> Std <input checked="" type="radio"/> Other		
<input type="radio"/> Ship System		
<input checked="" type="radio"/> Ship Primary		
<input type="radio"/> Ship Secondary		
Length	<input type="text" value="20"/> min	Labels <input type="text" value="5"/> min
<input type="radio"/> ARPA targets		
Length	<input type="text" value="20"/> min	Labels <input type="text" value="5"/> min
<input type="radio"/> Off <input type="radio"/> Std <input checked="" type="radio"/> Other		
<input type="radio"/> Predictor ship <input type="text" value="180"/> sec		
<input type="radio"/> User Events		
<input type="radio"/> Automatic Events		
<input type="radio"/> Positions		
Show	<input type="text" value="Not older than 3 months"/>	
<input type="radio"/> Radar Overlay		
<input type="radio"/> ARPA targets		
<input type="radio"/> AIS targets		
<input type="radio"/> AIS target names		
Max. count	<input type="text" value="200"/>	Max. range <input type="text" value="48"/> nm
Ship true symbol scale <input type="text" value="1:50000"/>		

“TRACKING” sheet

Past Tracks

- **Ship System**, if selected as **Std** or **Other**, own ship track is displayed based on the position used by the system
- **Ship Primary**, if selected as **Std** or **Other**, own ship track is displayed based on the primary position sensor
- **Ship Secondary**, if selected as **Std** or **Other**, own ship track is displayed based on the secondary position sensor.
- **ARPA targets**, if selected as **Std** or **Other**, ARPA target past tracks are displayed.

Predictor ship, if selected as **Std** or **Other**, predicted own ship position is displayed with 5 own ship symbols. Predictor time can be selected from 30 seconds to 180 seconds.

Note: The Predictor is visible only, if the own ship true scale symbol is also displayed.

Events marks (These marks are based on Voyage log records, for more information, see chapter "Voyage log".)

- **User Events**, if selected as **Std** or **Other**, event symbol is displayed on ECDIS where system has recorded an event based on conditions you have set (Type: User and Auto).
- **Automatic Events**, if selected as **Std** or **Other**, event symbol is displayed on ECDIS where system has recorded an event based on conditions you have set. (Type: Ship and Alarm)
- **Positions**, if selected as **Std** or **Other**, Positions are displayed. (Type: Posdev.)
Note MOB event is always visible.

You can select period of time to be displayed in a list box of **Show**.

Radaroverlay, if selected as **Std** or **Other**, Radar Echo Overlay is displayed.

Note! Radar overlay has its own mode control. Radar echo overlay can be visible only if the selected mode something else than ECDIS ONLY. For more information about radar echo overlay, see chapter "Radar Echo Overlay".

ARPA targets, if selected as **Std** or **Other**, ARPA targets are displayed.

Control of AIS targets

- **AIS targets**, if selected as **Std** or **Other**, Symbol of AIS targets are displayed.
- **AIS targets names**, if selected as **Std** or **Other**, name for AIS targets are displayed.
- **Max count**, setting for maximum count of AIS targets to be displayed on ECDIS.
- **Max. range**, setting for maximum range of AIS targets from own ship to be displayed on ECDIS.

Ship true symbol scale limit, own ship is displayed as true scale symbol, if the displayed chart scale is larger than selected limit scale here and if the size of the true scale symbol is longer than 6 mm on the chart display.

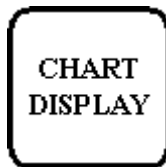

Pilot data, User chart and Chart alarms are non-chart information. All the selected items are shown on top of chart data

Chart display - ALL-ON		
Chart	Standard	Other
Tracking	Mariner	Route
Pilot data		
Off Std Other		
<input type="radio"/>	<input type="radio"/>	<input checked="" type="radio"/> Position
<input type="radio"/>	<input type="radio"/>	<input checked="" type="radio"/> Range
<input type="radio"/>	<input checked="" type="radio"/>	<input type="radio"/> Text
User chart		
Off Std Other		
<input type="radio"/>	<input checked="" type="radio"/>	<input type="radio"/> Points
<input type="radio"/>	<input checked="" type="radio"/>	<input type="radio"/> Lines
<input type="radio"/>	<input type="radio"/>	<input checked="" type="radio"/> Symbols and Tiduals
<input type="radio"/>	<input type="radio"/>	<input checked="" type="radio"/> Areas <input type="text" value="50% Transparent"/>
<input type="radio"/>	<input checked="" type="radio"/>	<input type="radio"/> Display only radar part of Lines, Symbols and Areas
Chart Alarm warning area		
Off Std Other		
<input type="radio"/>	<input checked="" type="radio"/>	<input type="radio"/> Highlight
Reference target		
Off Std Other		
<input type="radio"/>	<input checked="" type="radio"/>	<input type="radio"/> Position
Manual Updates		
Off Std Other		
<input type="radio"/>	<input checked="" type="radio"/>	<input type="radio"/> Standard Orange

“MARINER” sheet

Pilot data:

- **Position**, if selected as **Std** or **Other**, positions of Pilot Data records are displayed as a symbol on the chart.
- **Range**, if selected as **Std** or **Other**, range circles around Pilot Data records are displayed. Size of circle depends on value set in Pilot Data.
- **Text**, if selected as **Std** or **Other**, text of Pilot Data records are displayed on the chart.

User chart

- **Points**, if selected as **Std** or **Other**, Points are displayed.
- **Lines**, if selected as **Std** or **Other**, Lines are displayed
- **Symbols and Tiduals**, if selected as **Std** or **Other**, Symbols and Tiduals are displayed.
- **Area**, if selected as **Std** or **Other**, Areas are displayed. Colour fill of the areas can be selected as transparent from 25 to 75% and as No colour fill. If No colour fill is selected, only the boundaries of the areas are visible.
- **Display only radar part of Lines, Symbols and Areas**, if selected as **Std** or **Other**, only those Lines, Symbols and Areas are displayed, which has user selection "on radar" activated for them in the User Chart. This selector is used to view only that part of the User Chart, which will be sent to the ARPA radar connected to the system.

Chart Alarm warnings Area, if selected as **Std** or **Other**, Chart Alarm warnings areas are displayed in red highlight colour.

Reference target, if selected as **Std** or **Other**, reference targets are displayed.

Manual Updates, if selected as **Std** or **Other**, Manual Updates made as Orange symbol are displayed. NOTE, Visibility of Manual Updates made as True symbols are controlled through Standard and Other pages of Chart Display.

Store and recall of Chart Display Settings for visible chart and navigational features

You can define Chart Display Settings for chart details, which are displayed over S57 charts cells. You can save these Chart Display Settings into the hard disk and later recall them on demand.

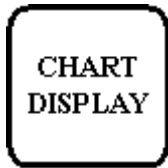

Press twice *CHART DISPLAY* button.

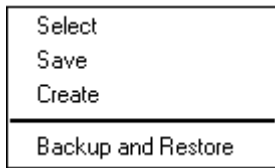

If you press twice *CHART DISPLAY* pushbutton, a menu will appear.

Select:

You select from the saved Chart Display Settings one for recall.

Save:

You save Chart Display Settings.

Create:

You create a new Chart Display Settings.

Backup and Restore:

You can make backups of your Chart Display Settings into a floppy disk. Or you can restore backups of your Chart Display Settings from your floppy disk.

How to create a new Chart Display Settings

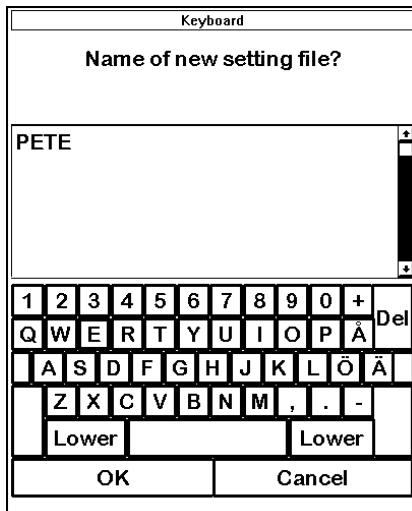

1. Press *CHART DISPLAY* button twice.
2. Select **Create** from the menu.
3. Enter desired name for Chart Display Settings and press **OK** in dialog box.

How to select Chart Display Settings

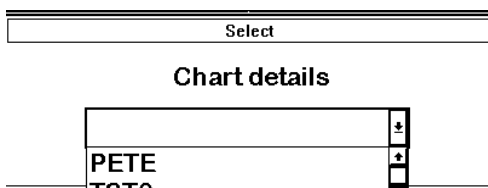

1. Press *CHART DISPLAY* button twice.
2. Choose **Select** from the menu.
3. Select desired Chart Display Settings from list box.

How to save changes to Chart Display Settings

1. Press *CHART DISPLAY* button twice.
2. Choose **Save** from the menu.
3. Current Chart Display Settings are saved automatically.

Sailing directions, Tidal tables etc. features of Vector charts

Vector charts contain Sailing directions, Tidal tables and other textual and picture information, which is not immediately visible on the chart. These information form an integral part of the legal ENC chart, which can fulfil SOLAS requirements and thus replace a paper chart. As a navigator you should check them as well as you check the visible chart when you do your planning and when you perform navigation.

Because these features are not permanently visible on the chart as they used to be in case of paper chart, the ECDIS has special symbols to highlight the locations from which you can cursor pick by Info request these kind of additional information. Below are example of these symbols. See also chapter "Request information about Vector chart objects" on page 134.



A grey box is used to show that Tidal information is available for Info request by cursor pick. **Note!** The visibility of the grey box symbol is controlled by the "Depth contours, currents, magnetics" selector of the "Other"-sheet of Chart Display window.



A magenta symbol is used to show that additional textual or picture information such as Sailing directions is available for Info request by cursor pick. **Note!** The visibility of the magenta symbol is controlled by the "Additional information available" selector of the "Other"-sheet of Chart Display window.

Date dependent and periodical features of Vector chart

Introduction

Vector charts contain date dependent features. Updating in general including reissues, new editions and updates creates date dependency. In addition to the obvious date dependency some features of S57 charts creates additional date dependency. These features include "Date Start", "Date End", "Periodical date start" and "Periodical date end". Hydrographic offices use these features to publish Temporary and Preliminary Notices to Mariners as their paper chart equivalent updates are called. The ARCS equivalent is called T&P Notices. "Periodical date start" and "Periodical date end" are used for seasonal chart features such as summer only sea marks, seasonal yacht race areas etc. See also chapter "A little learning about date dependency of S57 standard" on page 128.

You can efficiently use Date Dependency to use the real valid data for any given date applicable for your navigation or planning purposes. For example you can check existence of changes and restrictions weeks before they became valid. Date Dependency is a part of new electronic method to keep your chart up-to-date and valid for your intended use. Normally you should set **Display Until** and **Approve Until** once per week to keep your chart up-to-date.

Note! When you load charts and their updates into your system, the **Display Until** date is set as current date of the System. You must yourselves set **Approve Until** date. Make sure that you have set **Display Until** and **Approve Until** dates to the current date or to your planning date, whichever is applicable to your current usage of charts. For more information how to set Display/Approve date, see following chapter "How to approve and highlight Vector chart updates". If you use currently charts, which has Display Until and/or Approved Until set more than 1 week from current system date, you have a permanent reminder on your chart display.

Permanent Warning

At least one of used charts has more than 1 week between "Approved Until" and/or "Displayed Until" and current system date. Use Chart Plan - Date Dependent to set dates

How to approve and highlight Vector chart updates

Before you approve updates, you can display (highlight) updates, which are included into S57 Charts. Normally you have selected set "Automatic Display Until" after the SENC conversion. In this case after all the SENC conversions have been finished, all updates are automatically highlighted and you can view them and approve them after viewing. See chapter "How to set Approve Until date" on page 127.

If you - later after the initial approval of the updates - want to review updates, you can proceed as follows:

1. Use Approve Until to set the begin date for the update highlight. See chapter "How to set Approve Until date" on page 127.
2. Use Display Until to set the end date for the update highlight. See chapter "How to set Display Until date" on page 127.
3. Review the changes. Added features are highlighted with orange circles. Removed features are highlighted with orange slashes. Changed features are highlighted with both orange circles and slashes. See the picture right. See also for the presentation of highlighted updates chapter "An example of changes known to happen in the future." on page 129.
4. After review set Approve Until and Display Until back to the current system date.

Point

Line

Area

Insertion

Deletion

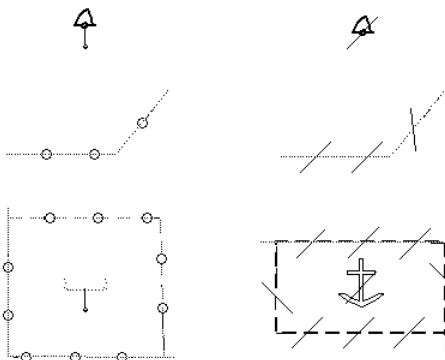

How to set Display Until date

1. Press CHART PLAN push button.
2. Select **Date Dependent** from the menu.
3. Date in **Updates Displayed until** field is shown as follows.

Date Dependent					
Cell Status	RENC	SENC	Updates	Updates	
Cell ID	edt/ upd	edt/ upd	Displayed until	Approved until	
AA5C1Q00	-/ -	2/ 0	2001 11 21 (-)	2001 11 21 (-)	
AA5C1V00	-/ -	2/ 0	2001 11 21 (-)	2001 11 21 (-)	
AA5C1W00	-/ -	2/ 0	2001 11 21 (-)	2001 11 21 (-)	
DE316004	2/ 8 <<<	2/ 9	2001 11 21 (-)	2001 11 21 (-)	
DK3DHWHE	Cancelled	XXX Cancelled	2001 11 21 (-)	2001 11 21 (-)	
DK3DI0XC	Cancelled	XXX Cancelled	2001 11 21 (-)	2001 11 21 (-)	
DK3EHXLD	2/ 0	2/ 0	2001 11 21 (-)	2001 11 21 (-)	
DK3EHXLE	1/ 4	1/ 4	2001 11 21 (-)	2001 11 21 (-)	
DK3EHYPD	2/ 0	2/ 0	2001 11 28 (-)	2001 2 9 (-)	
DK3EHYPE	23/ 2	23/ 2	2001 11 21 (-)	2001 11 21 (-)	
DK3EI0XD	2/ 1	2/ 1	2001 11 21 (-)	2001 11 21 (-)	
DK3EI0XE	2/ 0	2/ 0	2001 11 21 (-)	2001 11 21 (-)	
DK3EI21D	1/ 0	1/ 0	2001 11 21 (-)	2001 11 21 (-)	
DK5HHYPE	13/ 0	13/ 0	2001 11 28 (-)	2001 10 16 (-)	
DK5IHYPE	6/ 1	6/ 1	2001 11 21 (-)	2001 11 21 (-)	
FI49IGID	1/ 0	1/ 0	2001 11 21 (-)	2001 11 21 (-)	
FI4EIHME	1/ 1 >>>	1/ 0	2001 11 21 (-)	2001 11 21 (-)	
FI4EITQR	1/ 21 >>>	1/ 0	2001 11 21 (-)	2001 11 21 (-)	
NL303371	1/ 6	1/ 6	2001 11 21 (-)	2001 11 21 (-)	

Latest RENC Oldest date 2001 11 21 2001 2 9
 Product List Newest date 2001 11 28 2001 11 21
 2001 10 31 Manual Updates ---NVLD--- ---NVLD---

Sync Manual Update Dates
 All SENCs

Press **Display Until** button to define which updates are displayed. The system will display changes to S57 Chart cells before entered date.

Date to display until:

Date 28.Nov.2001 Time

How to set Approve Until date

1. Press CHART PLAN push button.
2. Select **Date Dependent** from the menu.
3. Date in **Updates Approved until** field is shown as follows

Date Dependent					
Cell Status	RENC	SENC	Updates	Updates	
Cell ID	edt/ upd	edt/ upd	Displayed until	Approved until	
AA5C1Q00	-/ -	2/ 0	2001 11 28 (-)	2001 11 21 (-)	
AA5C1V00	-/ -	2/ 0	2001 11 28 (-)	2001 11 21 (-)	
AA5C1W00	-/ -	2/ 0	2001 11 28 (-)	2001 11 21 (-)	
DE316004	2/ 8 <<<	2/ 9	2001 11 28 (-)	2001 11 21 (-)	
DK3DHWHE	Cancelled	XXX Cancelled	2001 11 28 (-)	2001 11 21 (-)	
DK3DI0XC	Cancelled	XXX Cancelled	2001 11 28 (-)	2001 11 21 (-)	
DK3EHXLD	2/ 0	2/ 0	2001 11 28 (-)	2001 11 21 (-)	
DK3EHXLE	1/ 4	1/ 4	2001 11 28 (-)	2001 11 21 (-)	
DK3EHYPD	2/ 0	2/ 0	2001 11 28 (-)	2001 2 9 (-)	
DK3EHYPE	23/ 2	23/ 2	2001 11 28 (-)	2001 11 21 (-)	
DK3EI0XD	2/ 1	2/ 1	2001 11 28 (-)	2001 11 21 (-)	
DK3EI0XE	2/ 0	2/ 0	2001 11 28 (-)	2001 11 21 (-)	
DK3EI21D	1/ 0	1/ 0	2001 11 28 (-)	2001 11 21 (-)	
DK5HHYPE	13/ 0	13/ 0	2001 11 28 (-)	2001 10 16 (-)	
DK5IHYPE	6/ 1	6/ 1	2001 11 28 (-)	2001 11 21 (-)	
FI49IGID	1/ 0	1/ 0	2001 11 28 (-)	2001 11 21 (-)	
FI4EIHME	1/ 1 >>>	1/ 0	2001 11 28 (-)	2001 11 21 (-)	
FI4EITQR	1/ 21 >>>	1/ 0	2001 11 28 (-)	2001 11 21 (-)	
NL303371	1/ 6	1/ 6	2001 11 28 (-)	2001 11 21 (-)	

Latest RENC Oldest date 2001 11 28 2001 2 9
 Product List Newest date 2001 11 28 2001 11 21
 2001 10 31 Manual Updates ---NVLD--- ---NVLD---

Sync Manual Update Dates
 All SENCs

Press **Approve Until** button to define which updates are approved. The system will approve changes to chart cells before entered date

Date to approve until:

Date 28.Nov.2001 Time

A little learning about date dependency of S57 standard

How the issue date of updates change the visibility of the changes

Study the example below to understand the behaviour of updates relative to date

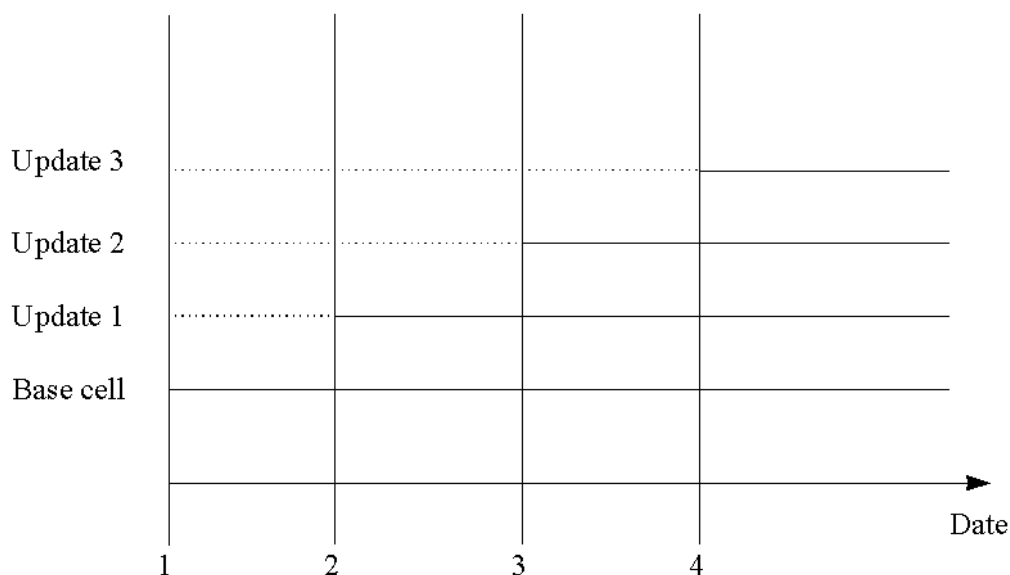

Figure above shows how updates are dependent on Display/Approve date set by user. Actions from 1 to 4 are follows:

1. Base cell including three updates is converted into SENC. Display date is set as current date of the System. Approve date has to set current date.
2. The date in which update 1 was issued. Display and Approve dates have to set to correct date in order to see the chart with Update 1.
3. The date in which update 2 was issued. Display and Approve dates have to set to correct date in order to see the chart with Update 1 and Update 2.
4. The date in which update 3 was issued. Display and Approve dates have to set to correct date in order to see the chart with Update 1, Update 2 and Update 3.

NOTE! In order to display charts with correct updated situation, use **always** current date during your voyage. If your voyage lasts more than one week set current date at least once per week during your voyage.

NOTE! In order to display charts with correct updated situation during route planning, use **always** planned date of each waypoint to check your plan.

How Temporary and Preliminary Notices to Mariners behave with Vector charts

In some cases the producer of chart (Hydrographic Office) is aware of changes which happen in the future. The Hydrographic Office is able to include this kind of updates into the chart for later use. In paper chart world these changes are published in Preliminary and Temporary Notices to Mariners. In ARCS these are known as T&P Notices.

An example of changes known to happen in the future.

Data Dependent

Cell Status	Latest RENC status query	Updates Displayed until	Updates Approved until
Cell ID	---	2005 1 2 (2/ 5)	2005 1 2 (2/ 5)
GB5X015W	---NVL0---	(X)	

Data Dependent

Cell Status	Latest RENC status query	Updates Displayed until	Updates Approved until
Cell ID	---	2005 9 8 (3/ 5)	2005 8 9 (2/ 5)
GB5X015W	---NVL0---	(X)	

Data Dependent

Cell Status	Latest RENC status query	Updates Displayed until	Updates Approved until
Cell ID	---	2005 9 8 (3/ 5)	2005 9 8 (3/ 5)
GB5X015W	---NVL0---	(X)	

Oldest date	---NVL0---	2005 9 8	2005 9 8
Newest date	---NVL0---	2005 9 8	2005 9 8
Manual Updates		1999 5 21	1999 5 21

Sync Manual Update Dates

Display until: Approve until:

Manual Update Dates: All Cells Cells Groups GB5X015W

Display/Approve date is set to 2005-01-02.
You can see a box shaped Caution Area displayed

Display date is set now 2005-09-08 and Approve date is 2005-08-09
You can see new area (Restricted Area) inserted together with existing area (Caution Area)

Display/Approve date is set to 2005-09-08.
You can see only Restricted Area without any Caution Area.

How periodical features are coded in Vector charts

There are following alternatives, how the chart producer can define a chart feature to use periodical date start and end:

- YYYYMMDD (Full date for date start and date end)
- --MMDD (The same date every year)
- --MM (The same month every year)

An example below shows how user can find out using Info query (periodical) full date for starting date. (YYYYMMDD)

The screenshot shows the 'Object' dialog box for a 'Restricted area'. The 'Object' field is 'Restricted area' and the 'Drawing Type' is 'Area'. The 'Used in' field shows 'From 2 / 2005 1 1' and 'updates to 2 / 2005 9 8'. A small preview window shows a square area with a circle and a horizontal line through it. The 'Properties' section has a 'Date start' field with the value '20050220' and a text field containing 'A Restriction' and 'entry prohibited'. The 'Position' section shows 'Point 4 / 4', 'Lat: 32°33.100S', and 'Lon: 060°56.700E'. There are 'Goto Master' and 'Goto Slave' buttons, and a 'View Presentation Details' button at the bottom.

An example below shows how user can find out using Info query (periodical) full date for ending date. (YYYYMMDD)

The screenshot shows the 'Object' dialog box for a 'Caution area'. The 'Object' field is 'Caution area' and the 'Drawing Type' is 'Area'. The 'Used in' field shows 'From 2 / 2005 1 1' and 'updates to 2 / 2005 9 8'. A small preview window shows a square area with a circle and an exclamation mark inside. The 'Properties' section has a 'Date end' field with the value '20050220' and a text field containing 'A Information' and 'Prohibited Entry Area to be'. The 'Position' section shows 'Point 2 / 4', 'Lat: 32°33.100S', and 'Lon: 060°56.700E'. There are 'Goto Master' and 'Goto Slave' buttons, and a 'View Presentation Details' button at the bottom.

An example below shows how user can find out using Info query periodical starting and ending month and day in every year. (--MMDD)

Feature Object [X]

Object: Caution area

Geometric Type: Area

Used in From 0 / 1998 5 25
updates to

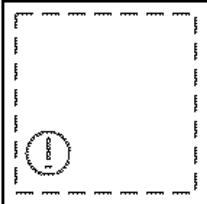

Feature Attributes

Information	YACHT RACE AREA
Periodic date end	--1115
Periodic date start	--0401
Scale minimum	139996

Position

Point 14 / 15 Lat: 55°59.595N
Lon: 012°34.279E

Position Attributes

Master: [Goto Master]

Slaves: [Goto Slave]

[View Presentation Details]

An example below shows how user can find out using Info query periodical starting and ending month in every year. (--MM)

Feature Object [X]

Object: Buoy, special purpose/general

Geometric Type: Point

Used in From 0 / 1998 2 25
updates to

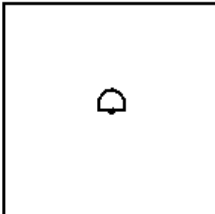

Feature Attributes

Category of special purpose	yachting mark
Colour	yellow
Periodic date end	--10
Periodic date start	--03

Position

Point 1 Isol / 1 Lat: 50°46.200N
Lon: 001°17.595W

Position Attributes

Master: [Goto Master]

Slaves: Top mark [Goto Slave]

[View Presentation Details]

An example of periodical chart feature.

Next two figures show a Caution area which is valid from date 1st April to date 15th November.

Date Dependent

Cell Status	Latest RENC	Updates Displayed until	Updates Approved until
Cell ID	status query		
n1300131	---NVLD---	(X) 1999 3 31 (6/ 6)	1999 3 31 (6/ 6)

Oldest date: ---NVLD--- 1999 3 31 1999 3 31
 Newest date: ---NVLD--- 1999 3 31 1999 3 31
 Manual Updates: 1999 5 21 1999 5 21

Sync Manual Update Dates

 All Cells n1300131

Date Dependent

Cell Status	Latest RENC	Updates Displayed until	Updates Approved until
Cell ID	status query		
n1300131	---NVLD---	(X) 1999 4 1 (6/ 6)	1999 3 31 (6/ 6)

Oldest date: ---NVLD--- 1999 4 1 1999 3 31
 Newest date: ---NVLD--- 1999 4 1 1999 3 31
 Manual Updates: 1999 5 21 1999 5 21

Sync Manual Update Dates

 All Cells n1300131

Display/Approve date has been set to to 1999-3-31.
 Caution Area is NOT displayed because the date is NOT valid for displaying it.

Display date has been set to to 1999-4-1.
 Caution Area is displayed because the date is valid for displaying it.

Figure below show the content of the attributes of the Caution area in the example above as shown in the Info request window.

Object

Object: Caution area
 Drawing Type: Area
 Used in From 0 / updates to

Properties

Information	Value
Periodic date end	YACHT RACE AREA
Periodic date start	--1115
Scale minimum	--0401
	139996

Position

Point 4 / 15 Lat: 56°00.145N
 Position remarks Lon: 012°35.230E

Master:
 Slaves:

Symbology used in Vector charts

As a user you can familiarise yourself with the used presentation by browsing IHO ECDIS Chart 1, which is included in this ECDIS. Note that it behaves as any S57 Chart and it follows your selections. See "Control of visible chart features" on page 118.

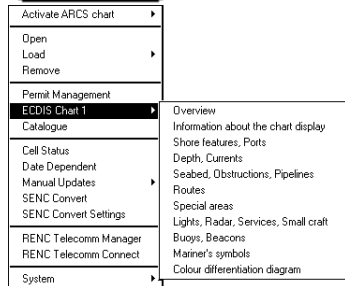

1. From Control Panel press Chart Plan pushbutton.
2. Select ECDIS Chart 1 from the menu.
3. Select desired chart symbols from the submenu to be displayed on ECDIS.
4. A following window appears, which is used to go back to previous chart.

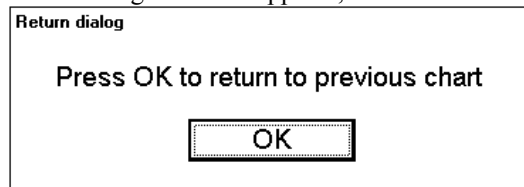

An appendix contains example plots of used symbology.

An example of **Overview** chart.

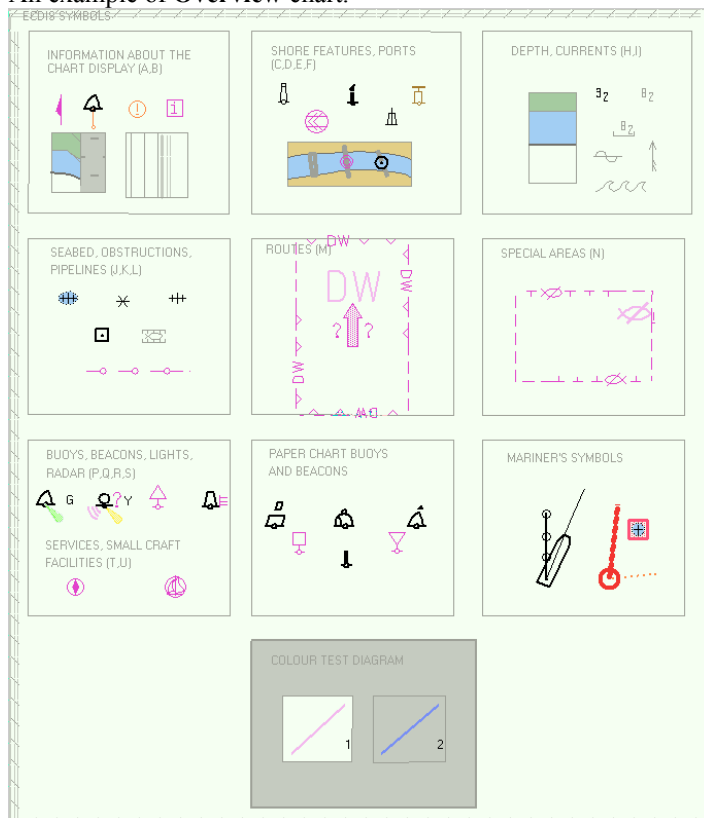

How to change presentation library used for Vector chart features

An ECDIS uses official IHO presentation library to draw Vector charts. Used presentation library is replaceable, but this feature is only intended to be used by qualified service personal and type approval authorities.

When this manual was published the official presentation library was "pslb03_2.dai" known as "Official IHO presentation library for ECDIS Ed 3 revision 1, Edition: 3.2".

Request information about Vector chart objects

The ability to cursor-pick on an object for the additional information that lies behind the object is an important part of ECDIS capability. However, an unprocessed cursor pick, which does discriminate or interpret and merely dumps on the interface panel all the information available at that point on the display, will normally result in pages of unsorted and barely intelligible attribute information.

How to set visible Vector chart features

The request information about S57 chart objects is given only objects which are set to displayed by user. How to set chart details to be displayed, see chapter "Control of visible " on page 118.

How to select desired object from the list of found objects

To select desired SENC and object for information request, proceed as follows:

1. Move cursor above desired object.
2. Press INFO & HELP push button. Two dialog boxes appear: **Object** and **Objects by Cell**
3. Use Object by Cell dialog box to select desired chart cell and desired object from which you need information. If there are different navigation purpose S57 charts over area you make an information request, you can select desired S57 chart cell in **Object by Cell** dialog box. A list of S57 chart cell is displayed in **Cell** list box. Select desired S57 chart cell from a list.

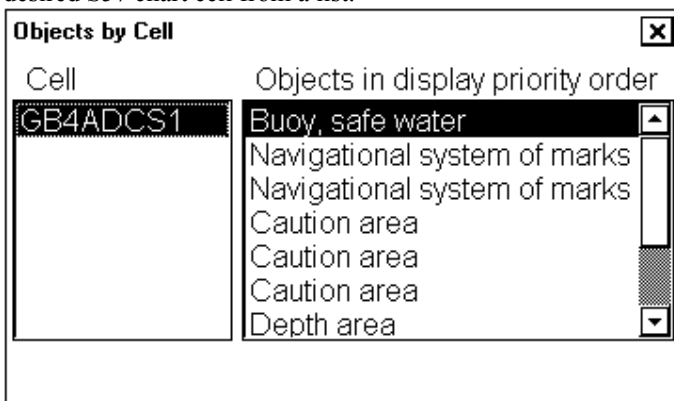

Select desired object from an **Object in display priority order** list box.

4. Selected object in the chart is displayed with mark of information.

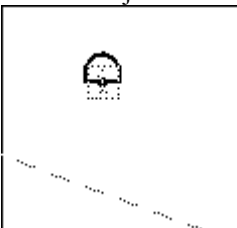

- The detailed information of selected object is displayed in an **Object** dialog box

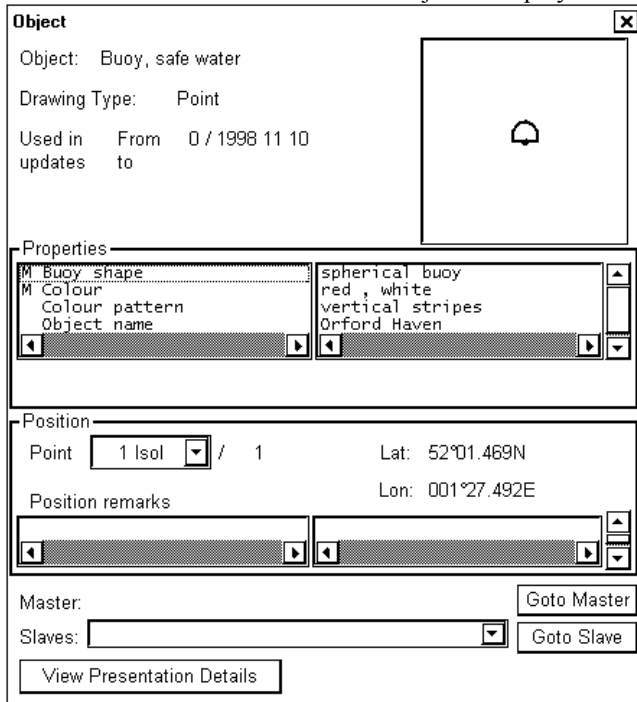

- To close dialog boxes press CANCEL in Control Panel.

How to view properties of a Vector chart object

After you have selected a Vector chart object, you can view detailed information of it in an **Object** dialog box:

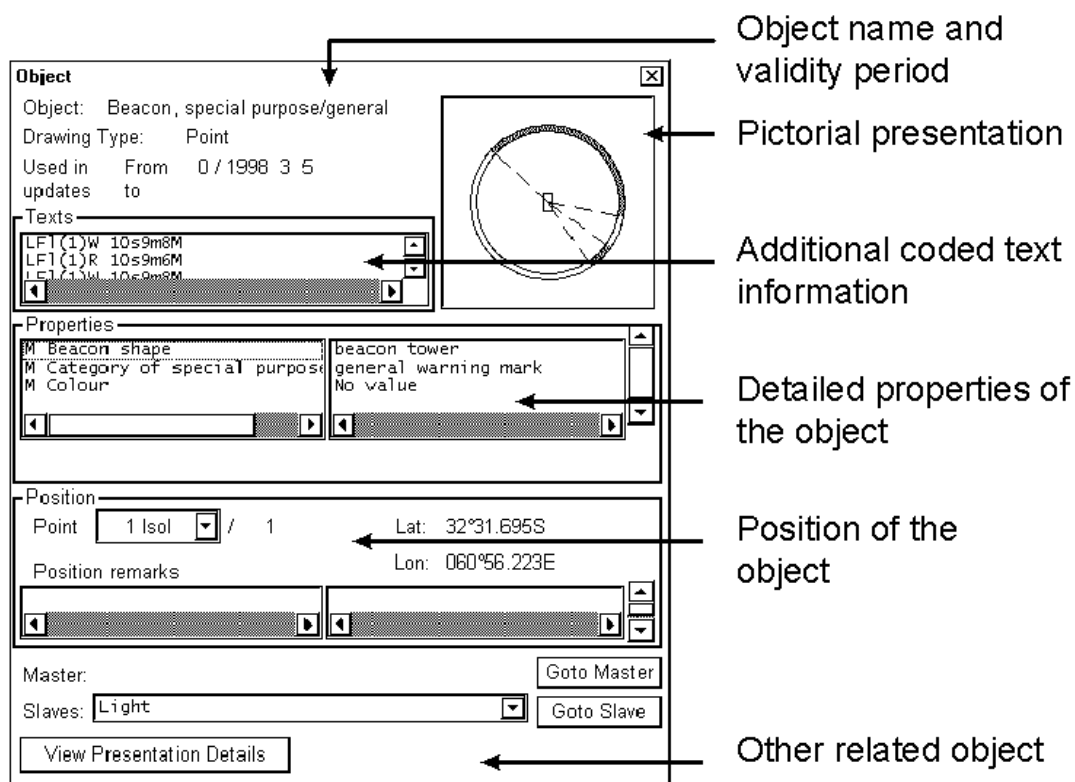

A little learning about Vector Chart coding

Tidal information is available as a table

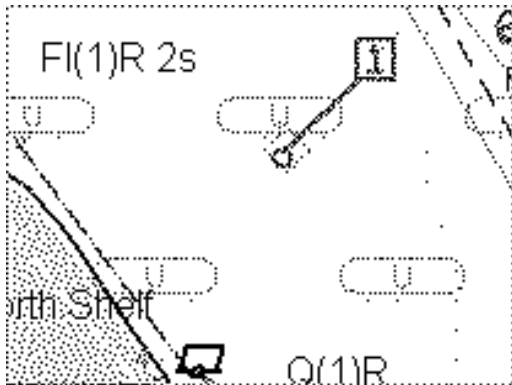

Object [X]

Object: Tidal stream panel data

Drawing Type: Point

Used in From 0 / 1998 11 10 updates to

Properties

Object name	H
Textual description	GB0TG969.TXT
Tidal stream - panel value	0131 ,HARWICH ,HW ,297,0.2,339

View content

Position

Point 1 Isol / 1 Lat: 51°57.904N

16.802E

Untitled - TextView

File Setting Text

Tidal stream panel values:

```
0131 HARWICH HW
```

Hour	Dir[°]	Rate[kt]
-6	297	0.2
-5	339	1.0
-4	335	1.0
-3	341	0.9
-2	339	1.2
-1	338	0.8
0	327	0.3
1	156	0.7
2	154	1.5
3	159	1.4
4	156	1.1
5	161	0.7
6	235	0.1

Goto Master

Goto Slave

More information is available as a text

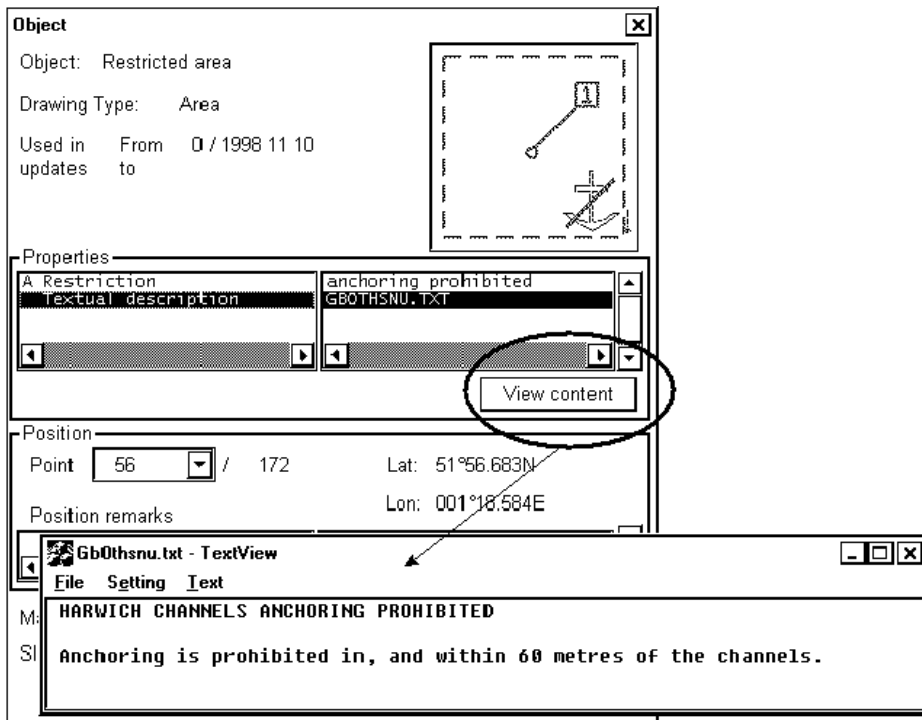

More information is available as a picture

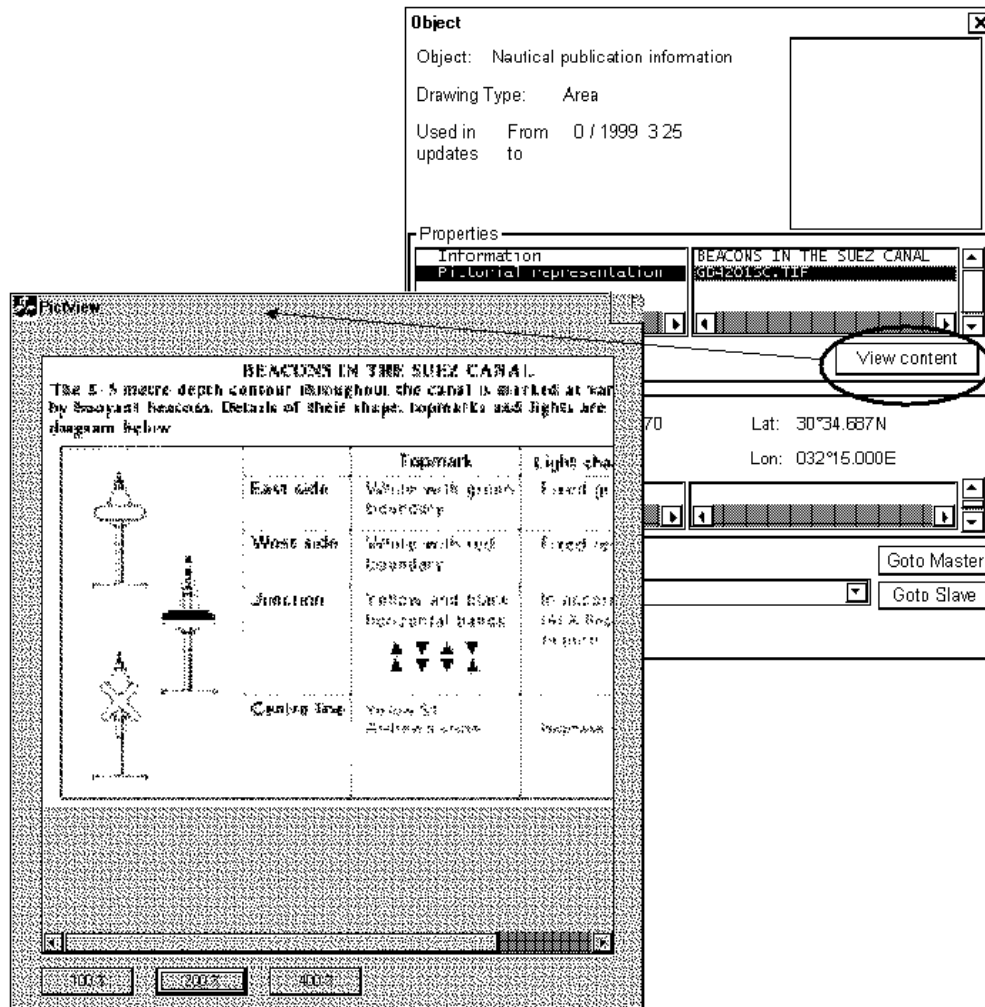

Linked objects

Often a group of chart object are linked together. Most common example is **beacon** or **buoy**, in which body and top mark are defined separately. One examples is lights and **recommended track**. Another example is **measurement mile**. There are also other similar cases.

Body and top hat of a beacon or buoy

The screenshot displays two overlapping windows from a chart software interface. The top window, titled "Object", shows the configuration for a "Top mark". It includes a drawing type of "Point" and a preview of a small black triangle. The "Properties" section lists: Colour (black, yellow), Colour pattern (No value), M Top mark shape (2 cones (points upward)), and Floating platform (On floating platform). The bottom window, also titled "Object", shows the configuration for a "Buoy, cardinal". It includes a drawing type of "Point" and a preview of a buoy with a top mark. The "Properties" section lists: M Buoy shape (pillar buoy), M Category of cardinal mark (north cardinal mark), M Colour (black, yellow), and Colour pattern (horizontal stripes). The "Position" section shows "Point" set to "1 Isol" and "Position remarks" with coordinates: Lat: 50°53.697N and Lon: 001°24.910W. A "Master" field is set to "Buoy, cardinal" and a "Slaves" field is set to "Top mark". A red oval highlights the "Slaves" field and the "Goto Slave" button. A "View Presentation Details" button is located at the bottom of the window. A small inset image in the bottom left shows a buoy with a top mark on a chart background.

Recommended track defined by two beacons

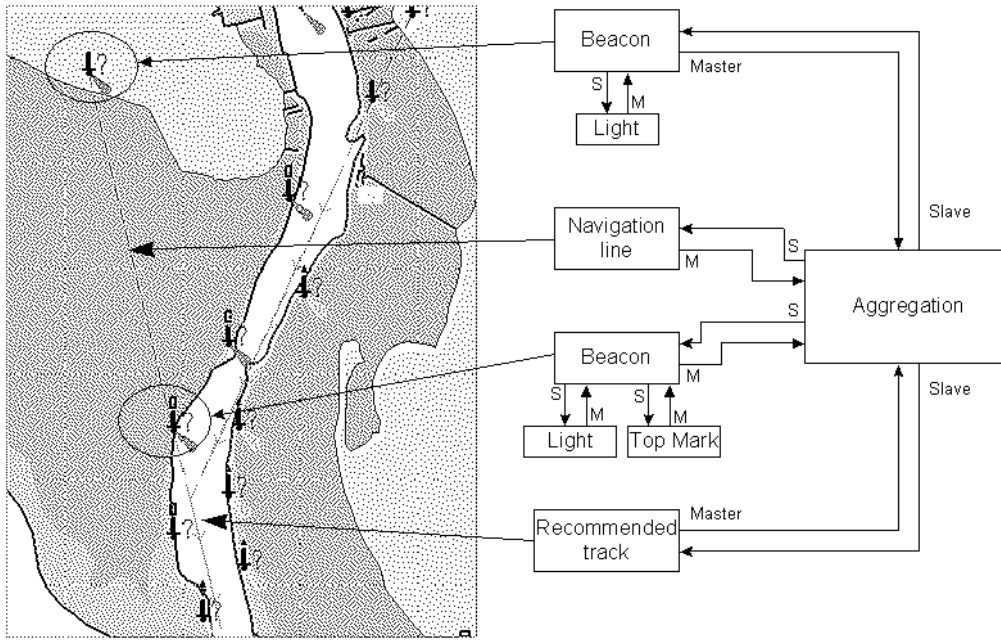

Object
Object: Recommended track
Drawing Type: Line
Used in From 0/1998 2 25
updates to

Properties
M Category of recommended track based on a system of fixed n 345.50
M Orientation inbound
M Traffic flow

Position
Point 1 Con / 3 Lat: 50°50.541N
Lon: 001°18.792W

Position remarks

Master: Aggregation
Slaves: Goto Slave
View Presentation Details

Goto Master

Object
Object: Beacon, lateral
Drawing Type: Point
Used in From 0/1998 2 25
updates to

Properties
M Beacon shape No value
M Category of lateral mark port-hand lateral mark
M Colour red
Conspicuous, visually not visually conspicuous

Position
Point 1 Isol / 1 Lat: 50°50.624N
Lon: 001°18.826W

Position remarks

Master: Aggregation
Slaves: Light, Top mark
Goto Slave

Goto Master

Object
Object: Aggregation
Drawing Type:
Used in From 0/1998 2 25
updates to

Properties

Position
Point / 0 Lat: 50°50.541N
Lon: 001°18.792W

Position remarks

Master: Aggregation
Slaves: Navigation line, Recommended track, Beacon, lateral, Beacon, special purpose/general
Goto Slave

Goto Master

Object
Object: Light
Drawing Type: Point
Used in From 0/1998 2 25
updates to

Properties
M Category of light Leading light, front light
M Colour red
M Light characteristic occulting
Signal group (C)

Position
Point 1 Isol / 1 Lat: 50°50.624N
Lon: 001°18.826W

Position remarks

Master: Beacon, lateral
Slaves: Goto Slave

Goto Master

Recommended track defined by a building and a beacon

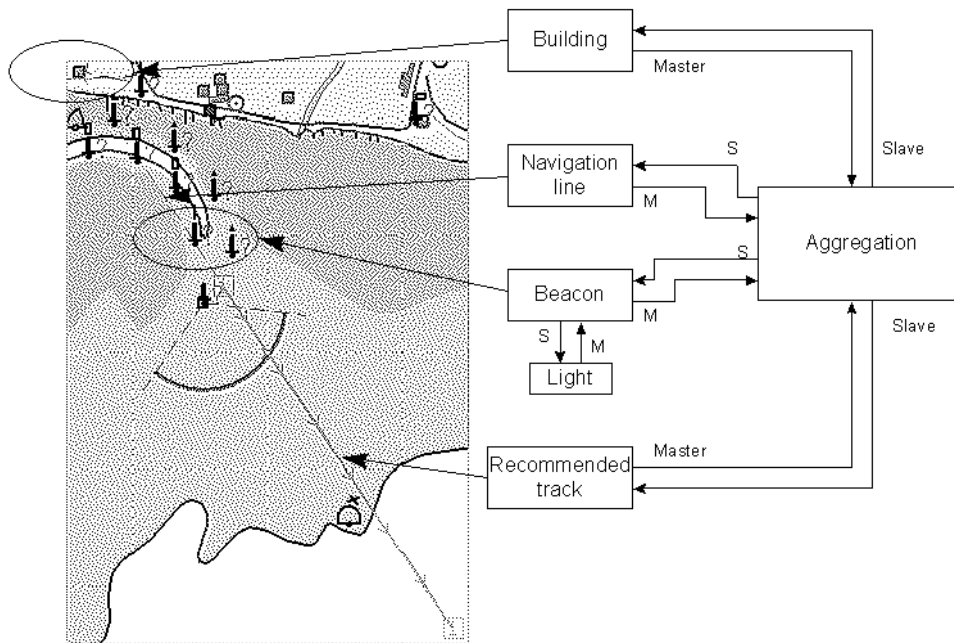

Object
Object: Recommended track
Drawing Type: Line
Used in From 0 / 1988 2 25
updates to

Properties
M Category of recommended track based on a system of fixed marks
M Orientation 324.00 °
M Traffic flow inbound

Position
Point 2 Con / 2 Lat: 50°46.467'N
Lon: 001°21.246'W

Master: Aggregation Goto Master
Slaves: Goto Slave

Object
Object: Beacon, special purpose/general
Drawing Type: Point
Used in From 0 / 1988 2 25
updates to

Properties
M Colour orange, red
M Colour pattern No value
M Information conspicuous, visually not visually conspicuous
Also Port hand lateral mark

Position
Point 1 Isol / 1 Lat: 50°46.934'N
Lon: 001°21.782'W

Master: Aggregation Goto Master
Slaves: Top mark Goto Slave

Object
Object: Aggregation
Drawing Type:
Used in From 0 / 1988 2 25
updates to

Properties

Position
Point / 0 Lat: 50°46.962'N
Lon: 001°21.722'W

Master: Goto Master
Slaves: Building, single Goto Slave
Building, single
Navigation line
Recommended track

Object
Object: Top mark
Drawing Type: Point
Used in From 0 / 1988 2 25
updates to

Properties
M Information
M Top mark shape Pentagonal other shape (see IHO IHO M)
M

Position
Point 1 Isol / 1 Lat: 50°46.934'N
Lon: 001°21.782'W

Master: Beacon, special purpose/general Goto Master
Slaves: Goto Slave

Measurement mile

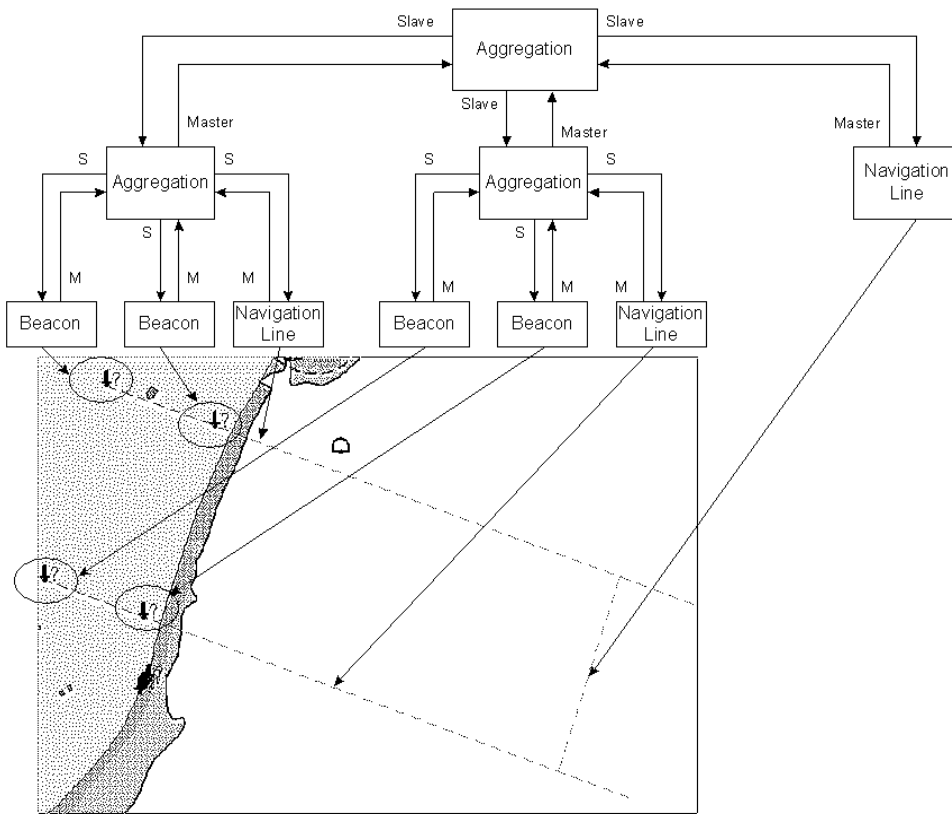

Object
 Object: Navigation line
 Drawing Type: Line
 Used in From 0 / 1998 11 10
 updates to

Properties
 Category of navigation line
 Orientation
 Transit line
 No value

Position
 Point: 2 Can / 3
 Lat: 52°00.956N
 Lon: 001°29.507E

Master: Aggregation
 Slaves: [Goto Slave]
 [Goto Master]

Object
 Object: Aggregation
 Drawing Type:
 Used in From 0 / 1998 11 10
 updates to

Properties

Position
 Point: [] / 0
 Lat: 52°00.152N
 Lon: 001°29.070E

Master: Aggregation
 Slaves: [Goto Slave]
 [Goto Master]

Object
 Object: Aggregation
 Drawing Type:
 Used in From 0 / 1998 11 10
 updates to

Properties

Position
 Point: [] / 0
 Lat: 52°00.152N
 Lon: 001°29.070E

Master:
 Slaves: [Goto Slave]
 [Goto Master]

Object
 Object: Aggregation
 Drawing Type:
 Used in From 0 / 1998 11 10
 updates to

Properties

Position
 Point: [] / 0
 Lat: 52°00.152N
 Lon: 001°29.070E

Master: Aggregation
 Slaves: [Goto Slave]
 [Goto Master]

Object
 Object: Beacon, special purpose/general
 Drawing Type: Point
 Used in From 0 / 1998 11 10
 updates to

Properties
 Beacon shape
 Category of special purpose
 Colour
 No value
 mark with unknown purpose
 No value

Position
 Point: 1 Isol / 1
 Lat: 52°01.576N
 Lon: 001°26.586E

Master: Aggregation
 Slaves: [Goto Slave]
 [Goto Master]

Seldom used features of Vector charts

There are some functions or features which are not used as daily or weekly basis, but sometimes there is a need to use them.

Cell Status

Use Cell Status function to find out the status of individual cell in your system, in a CD-ROM or in a RENC.

Status of CD-ROM -field: This information is based on information in CD-Catalog you have loaded and selected here from CD list box.

Status of RENC -field: This information is based on information in the RENC. One example of a RENC is PRIMAR.

Status of ENC -field: This information is based on information on hard disk of the system. The ENC is here S57ed3 delivery formatted chart. Before it can be displayed as a chart it has to be converted into System internal display format SENC.

Status of SENC -field: This information is based on information on hard disk of the system. A SENC is the System internal display format.

Status	Last edition	Last issue date	Last Base / Upd. included	Last update number
CD-ROM	1	1998 11 12		4
RENC				
ENC	1	1998 11 12	0/1998 11 2	4
SENC	1	1998 11 12	0/1998 11 2	4

Use **Conv Log** button to view detailed conversion log of S57 Chart cell.

S57 Cell Details

You may need to check when an update has been added into your ECDIS. Also you may need to check what was shown in your chart display 3 weeks ago. There are also many other rare cases when you need to know what was known by your ECDIS.

If you press **Details** button in S57 Cell Status, you will get a S57 Cell Details window, where you can view updates by their numbers.

To check any situation in the past you can use **Displayed Update** and **Approved Update** -fields to specify directly number of Update.

Edition number	Update number	Issue date	Upd. appl. date
1	0	1998 11 2	1998 11 2
1	1	1998 11 3	
1	2	1998 11 11	
1	3	1998 11 11	
1	4	1998 11 12	

How to use Cell Status window to initiate SENC conversion

Cell Status window can be used to force a new conversion into the SENC format for any chart cell, which is already in the SENC format. Normally you do not need this feature, but it could be useful if for example somebody try to analyse why an update cannot be converted etc.

Use **Create Senc** to initiate SENC conversion of the base cell.

Cell ID: GB5X01SW Cells CD: GB

Status	Last edition	Last issue date	Last Base / Upd. included	Last update number
CD-ROM				
RENC				
ENC	1	2005 10 6	0/1998 3 5	5
SENC	1	1998 3 5	0/1998 3 5	5

Buttons: Details, Create Senc, Add Update, Conv Log

If the base cell is already converted in the SENC format then the system ask you this question.

Select **OK** to overwrite the existing SENC.

Create S57 Senc

Overwrite existing Senc: GB5X01SW

Buttons: OK, Cancel

If following S57 Error window appears, a permit for the Chart is another edition.

S57 Error

Cell NO4D1621. Test before SENC convert failed

Decrypt failed for encrypted Cell from RENC
Permit may be for different edition of Cell
Check edition using Permit Management and Cell Status
If unsuccessful contact your RENC service

Button: OK

Then the content of Cell Status window changes as in this example.

Note that the SENC row is now empty.

Cell ID: GB5X01SW Cells CD: GB

Status	Last edition	Last issue date	Last Base / Upd. included	Last update number
CD-ROM				
RENC				
ENC	1	2005 10 6	0/1998 3 5	5
SENC				

Buttons: Details, Create Senc, Add Update, Conv Log

After the SENC conversion is completed, the content of the Cell Status changes as in this example.

Note that the last update number for SENC row is now 0 to indicate that only the base cell is included into the SENC.

Now use **Add Update** to include an update in the SENC.

Cell ID: GB5X01SW Cells CD: GB

Status	Last edition	Last issue date	Last Base / Upd. included	Last update number
CD-ROM				
RENC				
ENC	1	2005 10 6	0/1998 3 5	5
SENC	1	1998 3 5	0/1998 3 5	0

Buttons: Details, Create Senc, Add Update, Conv Log

After the SENC conversion for the added update is completed, the content of the Cell Status changes as in this example.

Note that the last update number for SENC row is now 1 to indicate that also the first update is included into the SENC.

Now repeat **Add Update** to include the rest of the updates in the SENC. In this example you need to repeat it still 4 times more for updates 2, 3, 4 and 5.

Cell Status				
Cell ID	GB5X01SW	<input type="button" value="Cells"/>	CD	GB
Status				
	Last edition	Last issue date	Last Base / Upd. included	Last update number
CD-ROM				
RENC				
ENC	1	2005 10 6	0/1998 3 5	5
SENC	1	1998 3 5	0/1998 3 5	1

Raster Chart material

ARCS Charts

Around 2700 ARCS charts are available on 11 Chart CD-ROMs, covering the world's major trading routes and ports. Regionally based Chart CD-ROMs RC1 to RC10 contain standard BA navigation charts, while RC11 contains ocean charts at scales of 1:3,500,000 and smaller. ARCS charts are facsimile copies of BA paper charts, and as such share a common numbering system. New Editions and New Charts for ARCS and BA paper charts are issued simultaneously. They are supplied on each weekly Update CD-ROM until incorporated into the Chart CD-ROMs at the next issue.

Occasionally, it is necessary to issue new charts in advance of their intended date of validity, for example a change in regulations commencing on a future date. In such cases the current chart will co-exist with the new chart until the date of implementation, the earlier chart being indicated with a suffix "X" after the chart number. The system will allow access to both charts for the period of overlap by issue of new chart permits.

Sometimes you may wish to add manually Notices to mariners or Navtex warnings into your ARCS charts. In this system this kind of things are called as Manual Updates. Manual updates are valid for both ARCS and S57 charts so that you need to define them only once. Also manual updates are valid for all scales so that you don't need to repeat them for charts published in different scales from the same area. See more details in chapter Manual Updates.

Chart legend of ARCS chart

CHART LEGEND is not a push button, but it is the front-page that is displayed as a base. If you push CANCEL enough you will finally get CHART LEGEND. The chart legend gives information to the user about edition date and updates of the displayed chart

Chart number:

Number of current chart is shown in this field.

Country Of Origin:

The country which has produced original chart.

Latest NM:

Date when the latest Notice to Mariners included to chart.

Edition Date:

Date when the chart was issued.

Publication Date:

Issue date of Update CD used to update the system.

WGS shift status:

Datum shift between local Datum and WGS84 datum is known (=Defined), unknown or user defined (=Undefined)

ARCS chart

Chart Number :	2224
Country Of Origin:	United Kingdom
Latest NM:	1743/2001
Edition Date:	1998 12 10
Publication Date:	2001 5 3
WGS shift status:	Defined
Depth:	Metres
Height:	Metres
<input type="button" value="T&P Notices.."/> <input type="button" value="Details.."/>	
<input type="button" value="Warnings.."/>	

or shift is known only some parts of chart (=Partially defined).

Depth:

Indication of used measurement units of depth.

Height:

Indication of used measurement units above sea level (for example clearance height).

T&P Notices, Details and Warnings of ARCS

Access to view T&P Notices, Details or Warnings of ARCS is in a Legend of ARCS chart. In lower part of the Legend there are three buttons to activate corresponding window.

T&P Notices...

T&P Notices are also known as Temporary and Preliminary Notices to Mariners. Press **T&P Notices** button to open text window, providing chart information that does not warrant permanent chart correction, can be viewed.

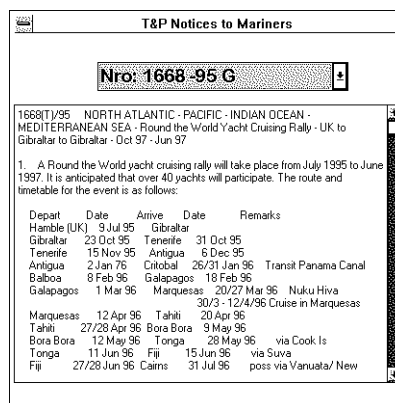

Details...

Press **Details** button to open window where detailed information of chart is shown.

Projection:

Projection of current chart. By pressing projection button user gets more information of latitude of true scale and rotation angle.

Orig. Scale:

The scale of the origin paper chart is shown here.

Hor Datum:

Horizontal datum used with current chart.

Depth Unit:

Unit of depth used with current chart.

Depth Datum:

Vertical datum of depth used with current chart.

Height Unit:

Unit used for objects locating above sea

Height Datum:

Vertical datum for objects locating above sea.

Panels:

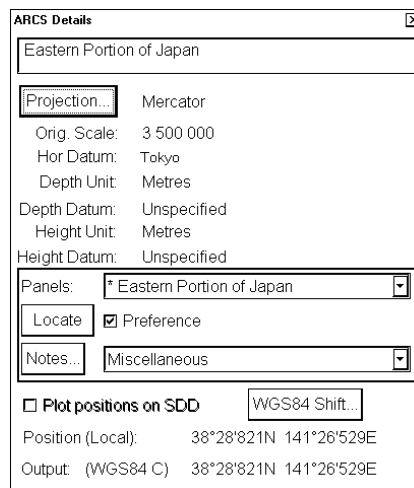

This can be used to select desired inset (Panel) from the combo box. This function also co-operates with Locate, Preference and Notes.

Locate:

This function selects to display an inset, which is selected in **Panels** combo box.

Warnings of ARCS chart

There could be warnings of last minutes not included to Notices to Mariners.

How to set Preference for Inset (Panel)

If there are in the same chart different insets with the same position, the user can select preferred inset, which displays own ship position.

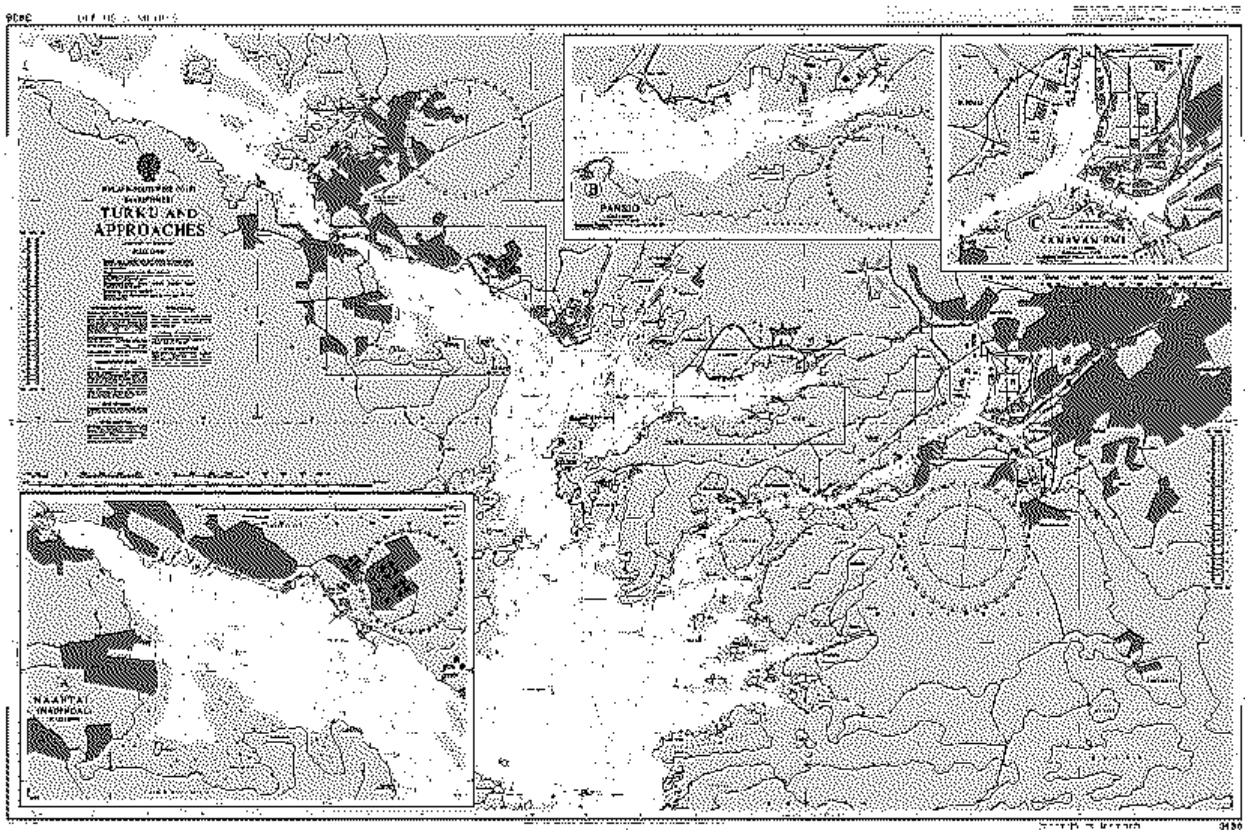

The chart with three insets.

1. Select desired inset from **Panels** combo box
2. Select **Preference** check box as shown below

Panels:	* Eastern Portion of Japan
Locate	<input checked="" type="checkbox"/> Preference

How to view Notes of ARCS chart

User can select from combo box desired item in order to view note. After selection in Panels press **Notes...** button and there will appear a text window. The window will be closed by pressing **CANCEL**.

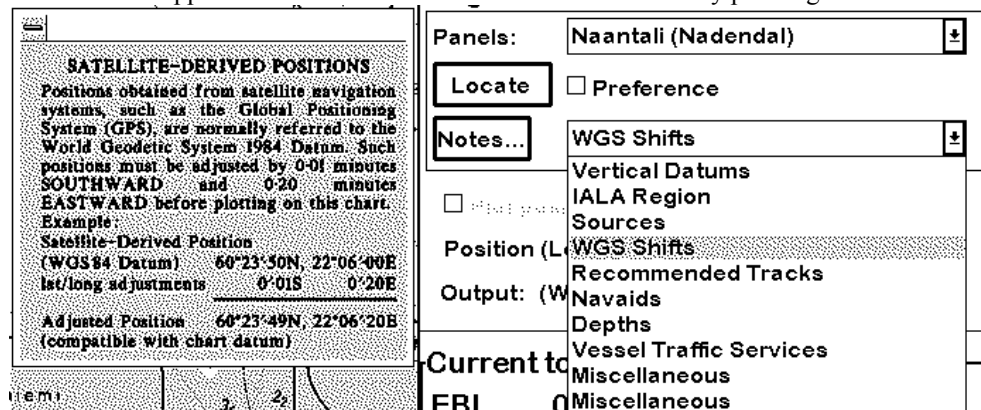

How to use Source Data Diagram

A Source Data Diagram (SDD) consists of two parts, a graphic showing the areas covered by each type of source material from which the chart was compiled, and a tabulation, keyed to graphic, giving details of source dates and scales. The layout of graphic corresponds to the layout of the chart, and the borders of the diagram equate to the limits of the chart panels. If this option is selected it is possible to click by cursor ARCS chart to plot origin on SDD. If Plot positions on SDD is not active there is no SDD on the chart.

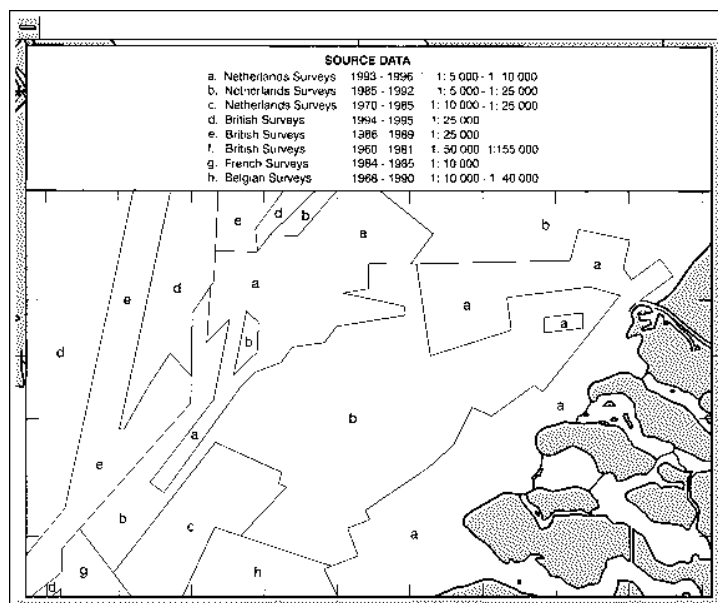

Datum and ARCS Charts

Difference between ARCS chart local datum and positions in WGS84 datum

The difference between ARCS chart local datum and WGS84 datum is known as WGS84 Shift. For most of the ARCS charts this is known and the system can do conversion automatically. For some ARCS chart this is unknown and the user is responsible to define it. For some ARCS charts this is partially known and the user is responsible to define it for the unknown areas of partially known ARCS charts. See chapter "How to define User WGS84 Shift" on page 153.

See also ARCS Navigator User Guide. It has a chapter "Use with GPS" about the datum question.

How the state of WGS Shift is indicated permanently

Cursor window does not have any warning. The cursor position operates in user selected working datum (see chapter "How to select Datum").

Cursor
From Own Ship: 2.180 nm 185.5°
59°49.370'N 024°27.615'E

Cursor window does have warning **WGS undefi.** in red colour.

Cursor
From Own Ship: 2.180 nm 185.5°
59°49.370'N 024°27.615'E WGS undefi.

The system still operates in user selected working datum (see chapter "How to select Datum"). But the system is unable to correctly do the transformation between local paper chart datum and the user selected working datum.

Cursor window does have warning **WGS user** in red colour.

Cursor
From Own Ship: 2.180 nm 185.5°
59°49.370'N 024°27.615'E WGS user

The system still operates in user selected working datum (see chapter "How to select Datum"). But the system use user defined WGS shift to perform the transformation between local paper chart datum and the user selected working datum.

How to check WGS shift status of the used chart

There is a WGS shift status -field in ARCS legend. Alternatives are as below:

WGS shift is defined for this chart. All latitude / longitude positions of cursor, Routes, User Charts, Pilot data etc. are correctly displayed on ARCS chart.

ARCS chart	
Chart Number :	2224
Country Of Origin:	United Kingdom
Latest NM:	1743/2001
Edition Date:	1998 12 10
Publication Date:	2001 5 3
WGS shift status:	Defined
Depth:	Metres
Height:	Metres
<input type="button" value="T&P Notices.."/>	
<input type="button" value="Details..."/>	
<input type="button" value="Warnings..."/>	

WGS shift is not defined for this chart. Latitude / longitude positions of cursor, Routes, User Charts, Pilot data etc. may not be correctly displayed on ARCS chart.. You can use User WGS shift to define correct transformation from WGS84 co-ordinates to local datum of the ARCS chart.

ARCS chart

Chart Number :	2264
Country Of Origin:	United Kingdom
Latest NM:	2276/2000
Edition Date:	1999 8 5
Publication Date:	2000 8 31
WGS shift status:	Not Defined
Depth:	Metres
Height:	Metres
<input type="button" value="T&P Notices.."/> <input type="button" value="Details..."/>	
<input type="button" value="Warnings..."/>	

WGS shift is partially defined for this chart. Some parts or panels of this chart do not have defined WGS shift. Latitude / longitude positions of cursor, Routes, User Charts, Pilot data etc. may not be correctly displayed on ARCS chart.. You can use User WGS shift to define correct transformation from WGS84 co-ordinates to local datum of the ARCS chart for the parts or panels of this chart, which do not have defined WGS shift.

ARCS chart

Chart Number :	1358
Country Of Origin:	United Kingdom
Latest NM:	4003/2000
Edition Date:	1998 10 22
Publication Date:	2001 1 11
WGS shift status:	Partially Defined
Depth:	Metres
Height:	Metres
<input type="button" value="T&P Notices.."/> <input type="button" value="Details..."/>	
<input type="button" value="Warnings..."/>	

How to view cursor position in local datum of an ARCS chart

On demand you can view the cursor position in local datum of an ARCS chart. This is useful when you need to refer to the corresponding paper chart. You can access ARCS Details from **Details** button of the Chart legend of ARCS.

In this example the used ARCS chart has WGS84 shift defined.

Cursor Position panel show cursor position in local ARCS chart datum (indicated as **Local Datum**) and in WGS84 datum as defined in the used ARCS chart (indicated as **WGS84 Chart**).

NOTE ! The permanent **Cursor** panel below the ARCS Details window show cursor position always in user selected working datum (see chapter "How to select Datum").

ARCS Details	
Baltic Sea Northern Sheet and Gulf of Finland	
Projection...	Mercator
Orig. Scale:	750 000
Hor Datum:	Undetermined
Depth Unit:	Metres
Depth Datum:	Approx Mean Sea Level
Height Unit:	Metres
Height Datum:	Mean Sea Level
Panels:	* Baltic Sea Northern Sheet and Gulf
Locate	<input checked="" type="checkbox"/> Preference
Notes...	Miscellaneous
<input type="checkbox"/> Plot positions on SDD	WGS84 Shift...
Cursor Position	
Local Datum	60°04'159N 029°15'443E
WGS84 Chart	60°04'159N 029°15'243E
Cursor	
From Own Ship:	358.2 nm 112.3°
60°04.159N 029°15.243E	

In this example the used ARCS chart has WGS84 shift not defined.

Cursor Position panel show cursor position only in local ARCS chart datum (indicated as **Local Datum**).

NOTE ! The permanent **Cursor** panel below the ARCS Details window has warning WGS undefi to highlight that the system is unable to do a correct transformation from local ARCS chart datum to the user selected working datum (see chapter "How to select Datum").

ARCS Details	
Gulf of Finland - Eastern Part	
Projection...	Mercator
Orig. Scale:	200 000
Hor Datum:	Undetermined
Depth Unit:	Metres
Depth Datum:	Approx Mean Sea Level
Height Unit:	Metres
Height Datum:	Mean Sea Level
Panels:	* Gulf of Finland - Eastern Part
Locate	<input checked="" type="checkbox"/> Preference
Notes...	Miscellaneous
<input type="checkbox"/> Plot positions on SDD	WGS84 Shift...
Cursor Position	
Local Datum	60°03'261N 029°22'862E
Local Datum	60°03'261N 029°22'862E
Cursor	
From Own Ship:	362.8 nm 112.2°
60°03.261N 029°22.862E WGS undefi.	

In this example the used ARCS chart has WGS84 shift not defined.

Cursor Position panel show cursor position in local ARCS chart datum (indicated as **Local Datum**) and in WGS84 datum as defined by the User WGS shift (indicated as **WGS84 User**).

NOTE ! The permanent **Cursor** panel below the ARCS Details window has warning WGS undefi to highlight that the system uses user defined transformation from local ARCS chart datum to the user selected working datum (see chapter "How to select Datum").

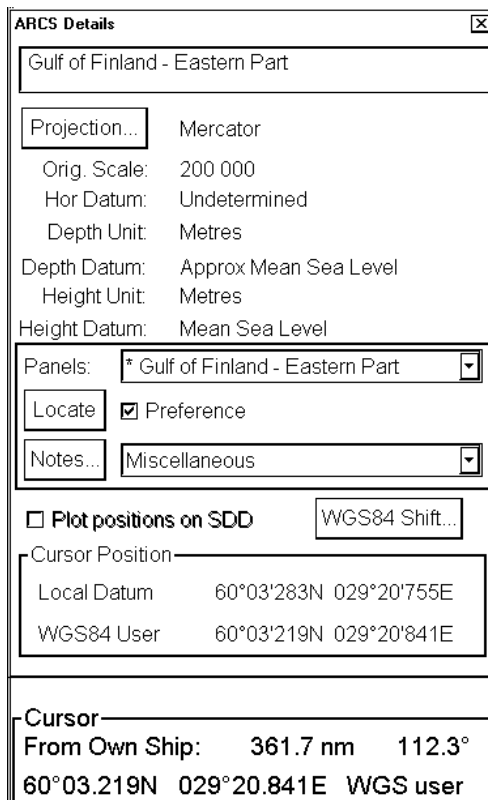

How to view value of WGS84 Shift

On demand you can view the value of WGS84 shift of an ARCS chart. You can access ARCS WGS84 shift from **WGS84 Shift** button of **ARCS Details** window.

In this example the used ARCS chart has WGS84 shift defined.

Chart Shift:

The shifts between WGS84 datum and the local datum.

Accuracy:

This field contains accuracy as defined by the chart producer.

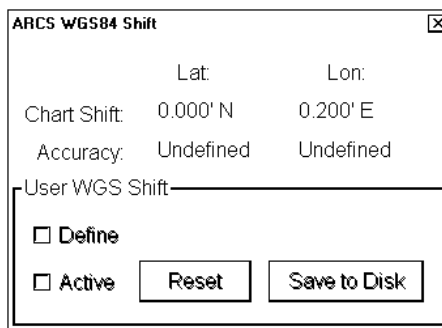

In this example the used ARCS chart has WGS84 shift not defined.

Chart Shift:

Undefined indicates that this ARCS chart do not have defined WGS84 shift

Accuracy:

This field contains accuracy as defined by the chart producer

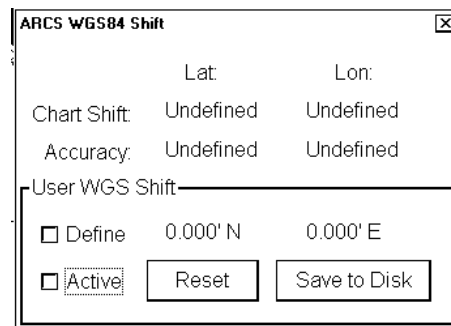

In this example the used ARCS chart has WGS84 shift not defined.

Chart Shift:

Undefined indicates that this ARCS chart do not have defined WGS84 shift

Accuracy:

This field contains accuracy as defined by the chart producer.

User WGS shift

The shifts between WGS84 datum and the local datum as defined by user.

Active

Indicates that the user defined WGS84 shift is in use.

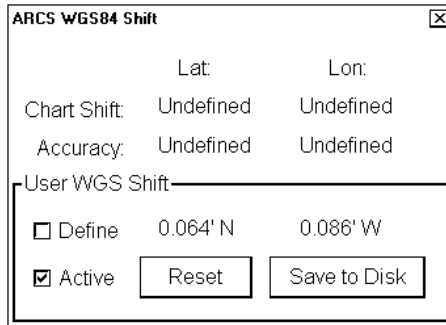

How to define User WGS84 Shift

You can define WGS84 shift for those ARCS charts, which do not include defined WGS84 shift. You cannot redefine WGS84 shift for any ARCS chart, which has defined WGS84 shift by the chart producer.

To define User WGS84 shift proceed as follows

1. Select first Active and then Define in ARCS WGS84 Shift window.
2. Press **Chart align** button and move the cursor. You can view the value of user WGS shift and when you have correct value depress the **Chart Align** button.

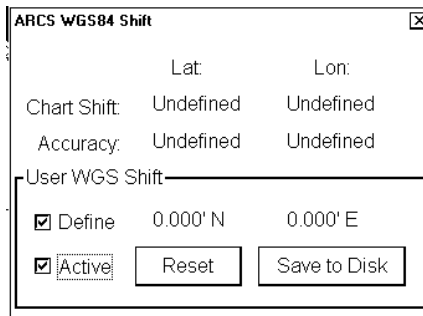

Use **Save to Disk** to save the user defined WGS84 shift for later use of the same ARCS chart.

Use **Reset** to reset the value of the user defined WGS84 shift.

Use **Active** to control use of user defined WGS84 shift.

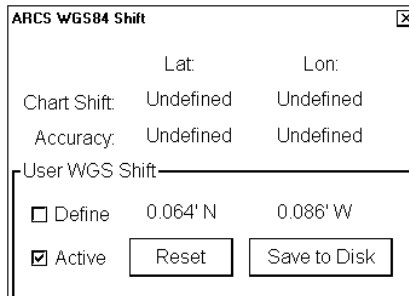

Permanent warnings of ARCS

The system can powerfully assist you to keep your charts up-to-date for the charts which you have got from ARCS. Chart producer of ARCS has stored up-to-date situation on ARCS weekly update CD-ROM (System Files). This information is loaded into the ECDIS when you Update either By Permits or By Active Group. Based on this information, ARCS Permanent Message is used to assist you to keep the ARCS up-to-date.

Chart is loaded from RCxx CD, but not updated using ARCS weekly Update CD.

Perform Update for the chart.

ARCS Permanent Message
This Chart is not up to date. UNSAFE FOR NAVIGATION
Reason: Missing update

Chart is not updated using ARCS weekly update CD from which ARCS system files are loaded.

Use Correct ARCS weekly Update CD to load updates for chart.

ARCS Permanent Message
This Chart is not up to date. UNSAFE FOR NAVIGATION
Reason: Chart not updated using current System files

Updates for the chart are not for same edition as chart. Load chart from the latest RCxx CD-ROM and Update chart using latest Update CD-ROM

ARCS Permanent Message
This Chart is not up to date. UNSAFE FOR NAVIGATION
Reason: Edition mismatch in last update (ARCS 03 or 04)

Chart is cancelled and not kept up-to-date by chart producer anymore.

ARCS Permanent Message
This Chart is not up to date. UNSAFE FOR NAVIGATION
Reason: Chart is canceled (Not in the System files)

ARCS license has expired.

Contact Chart Agent to renew your license.

ARCS Permanent Message
Chart 259 cannot be seen
Reason: License expired (ARCS 10)

ARCS chart managing

Chart plan

CHART PLAN is used for managing chart database.

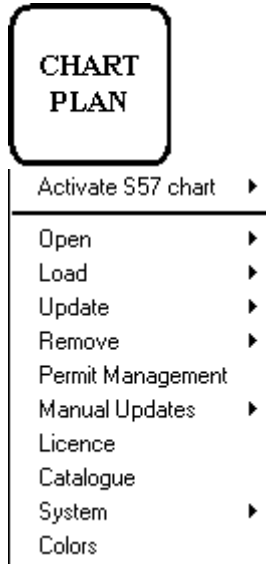

CHART PLAN push button

menu:

Activate S57 chart:

The function activates S57 chart onto the display. You have two options to select chart to be opened onto display; **Ignore scale** opens S57 chart cell with scale that was used last time you use S57 charts. **Sync scale** opens S57 chart with scale that was used with ARCS charts.

Open:

User can open appropriate ARCS chart on the display.

Load:

User can load ARCS chart from CD-ROM to hard disk.

Update:

User can update ARCS charts stored hard disk. Updates are delivered by British Admiralty in CD-ROM weekly.

Remove:

User can remove charts from hard disk.

Permits:

User can load from floppy disk the permit by this function.

Licence:

User can view license information of using ARCS chart by this function.

Catalogue:

User can manage ARCS charts. See "ARCS Catalog" on page 167.

System:

- ARCS Update Status: Displays information of ARCS Update CD which is loaded in the system.
- S52 Presentation Library; View information of used presentation library with manual updates.
- Verify system files: Compares loaded system files with files on Update CD.
- Refresh Charts after backup; Use this after backup from another ECDIS.
- Log File: User can view log file including ARCS depending functions.

Colors:

This enable s the user to see if the individual colours can be distinguished when viewing. See also chapter "Colour Calibration"

Subscription of ARCS

ARCS customers can subscribe to one of two service levels, ARCS Navigator or ARCS Skipper.

ARCS Navigator

ARCS Navigator users receive a comprehensive weekly updating service on CD, which mirrors the Admiralty Notices to Mariners (NMs) used to correct Admiralty paper charts. The update information is cumulative, ensuring that only the most recent Update CD need to use. ARCS Navigator license is valid period of 12 months. During this period weekly updates will be delivered on Weekly Update CDs. ARCS Navigator is intended for SOLAS class users which require that their chart are up-to-date.

Content of ARCS Navigator Pack:

- 1 or more Chart CDs (RC1-RC11), containing ARCS charts
- 1 Update CD containing the latest ARCS chart corrections
- 1 floppy disk storing ARCS Chart Permits

ARCS skipper

For ARCS Skipper user, the charts you have licensed were fully up-to-date at the day of sale. They can be updated for NMs whenever you like by buying a new ARCS skipper license, which is again fully up-to-day for the day of sale.

Content of ARCS Skipper Pack:

- 1 or more Chart CDs (RC1-RC11), containing ARCS charts
- 1 Update CD containing the latest ARCS chart corrections
- 1 floppy disk storing ARCS Chart Permits

Note, if you are holding more than one ARCS Skipper Packs onboard, only one Pack can be loaded into the ECDIS at the same time.

ARCS licence information

ARCS Licence information can be viewed in License Information window:

If ARCS format is active, you can select ARCS Licence from the menu. There will appear Licence information window into Dialog box area. This window consists information about owner of licence, user permit and type of licence.

License Information [X]

Licencee: Mr. Ship Owner
Vessel: MT Motortanker
Company: Shipping Company Ltd
Homestreet 12
FIN-01234 HELSINKI
FINLAND

Host
User: AAAABBBBCCCCDDDD
PIN: XXXX
Licence Type/Number: Navigator YYYYYZ

This licence is only valid if the chart permits on this system are licensed to the person or company named above. If you are not the named person or do not represent the named company, you may be in breach of the licence conditions relating to the use of these charts. If in doubt please contact your nearest ARCS supplier.

How to get started with ARCS charts

In order to get charts in the system and be displayed you have to go on a few steps:

1. Load Permit from the floppy disk by using **Permits** command. For more information, see chapter "How to load chart permits for ARCS Navigator license" on page 158.
2. Load chart from ARCS *RCnn* CD-ROMs. To make sure how to load chart, see "How to load a new ARCS chart into the system" on page 161.
3. Load update from Weekly CD-ROM. To make sure how to update chart, see "How to update ARCS chart" on page 164.
4. Open desired chart by using **Open** command or by using **Catalogue** command.

If new update CD-ROM arrives continue from step 3.

If you order more charts continue from step 1.

How to load chart permits for ARCS Navigator license

Permits are usually delivered in floppy disk. To load chart permit into the system, proceed as follows:

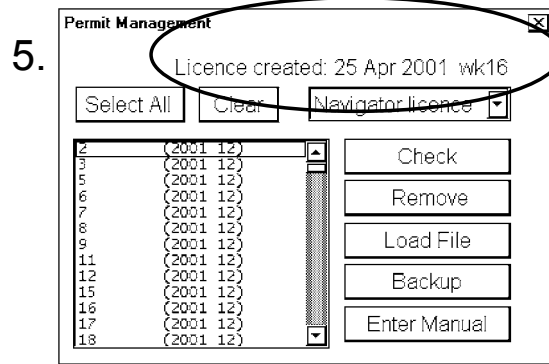
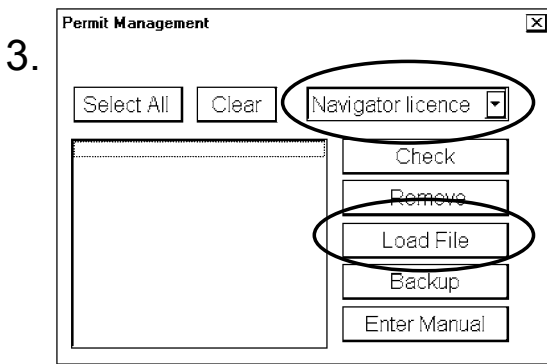
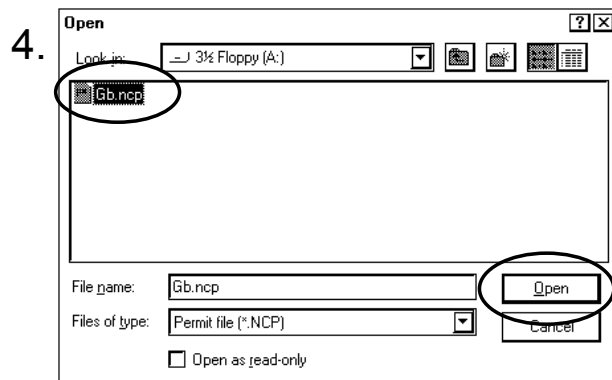
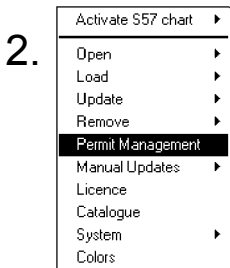

1. From the Control Panel press Chart Plan push button.
2. Select **Permit Management** from the menu.
3. Select Navigator licence as a type of license. Insert a permit floppy disk to floppy disk drive. Press **Load file** button.
4. Select **Gb.ncp** and press **Open**.
5. Check in **Permit Management** that permits are displayed here with correct information. That is all what need to do when loading permits. Close window, press CANCEL in ECDIS Control Panel.

Enter Manual button:

This function enables enter manually permit string which is delivered for example by telex. After typing the string user can accept it by pressing Add button or reject by Cancel button.

Backup button:

This button opens "Save As" dialog. User is able to make backup copy from Chart Permit file.

How to load chart permits for ARCS Skipper license

Permits are usually delivered in floppy disk. To load chart permit into the system, proceed as follows:

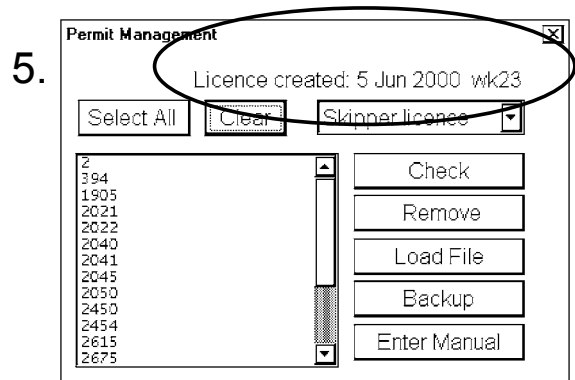
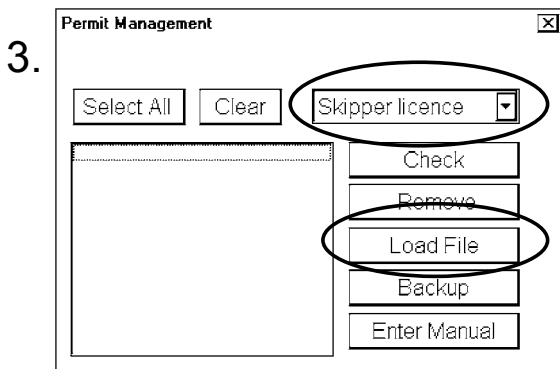
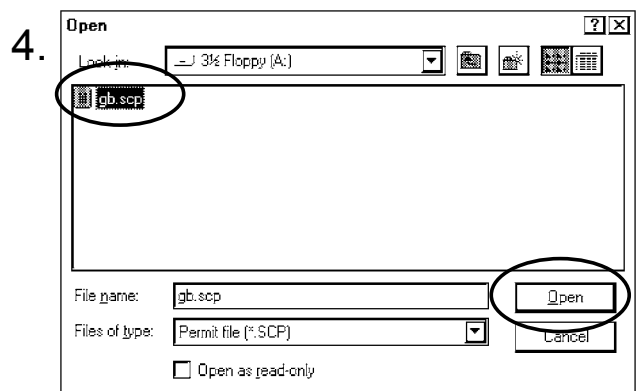
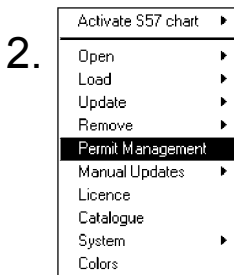

1. From the Control Panel press Chart Plan push button.
2. Select **Permit Management** from the menu.
3. Select Skipper licence as a type of license. Insert a permit floppy disk to floppy disk drive. Press **Load file** button.
4. Select **Gb.scp** and press **Open**.
5. Check in **Permit Management** that permits are displayed here with correct information. That is all what need to do when loading permits. Close window, press CANCEL in ECDIS Control Panel.

Note, if you are holding more than one ARCS Skipper Packs onboard, only one Pack can be loaded into ECDIS at the same time. If you load a new ARCS Skipper permit floppy disk into ECDIS you must load charts and weekly updates from CDs delivered with and listed in your License Agreement also known as "Schedule A".

How to remove chart permits

Normally you do not need to remove permits during normal operation. Sometimes however it may be necessary to remove chart permits from the system.

To remove chart permit, proceed as follows:

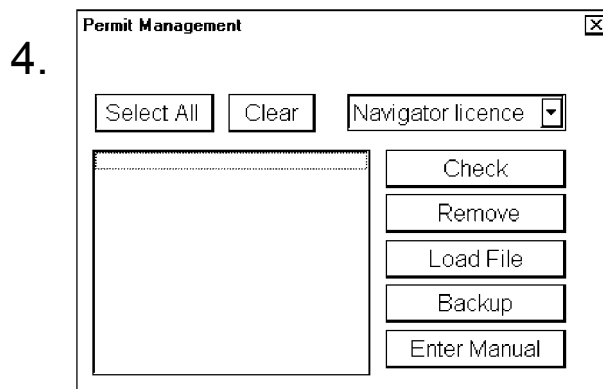
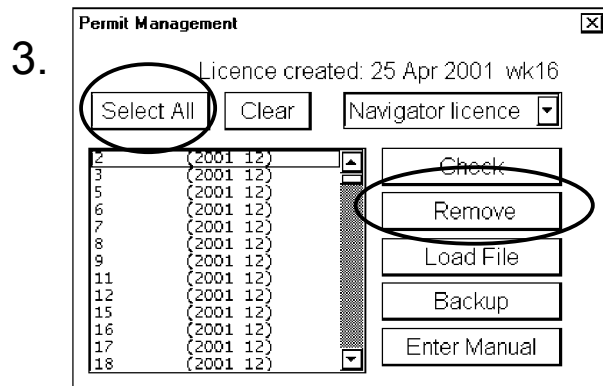
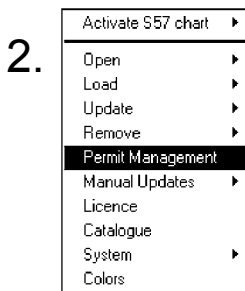

1. From the Control Panel press Chart Plan push button.
2. Select **Permit Management** command from the menu.
3. Press **Select All** button and then press **Remove** button. If you want to remove individual Permit, use cursor and SELECT button to highlight it in list of Permits
4. Check that selected permits has been removed. Close window, press CANCEL in ECDIS Control Panel.

How to load a new ARCS chart into the system

To load ARCS format raster chart into the system which ones you have a permit.

- **Load by permit.** You can load all the charts which are involved in your licence. The system will load them automatically.
- **Load by active group.** You can define a group of charts to be loaded into the system. It will be useful to define groups to make it easier to maintain your database.
- **Load manual.** You can select manually the charts, which will be loaded into the system.

Load by permits

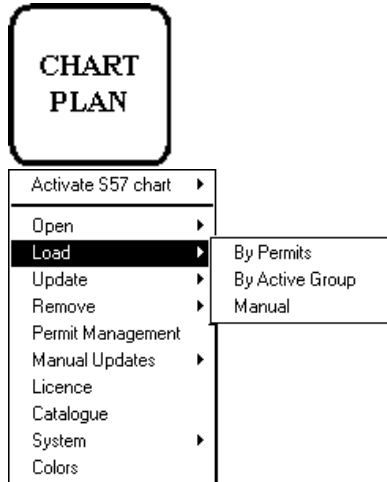

1. Press CHART PLAN push button.
2. Select **Load** from the menu and **by permits** from the sub menu

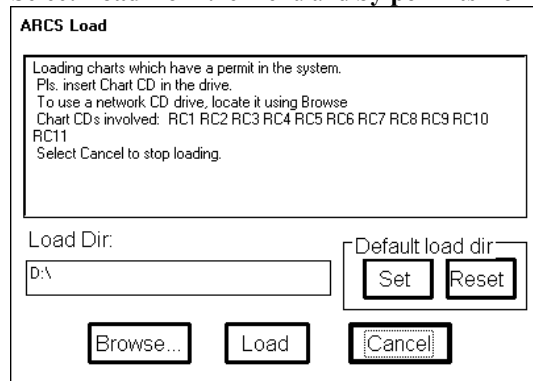

3. Insert desired CD-ROM into drive and press **Load**. A progress indicator of loading appears.

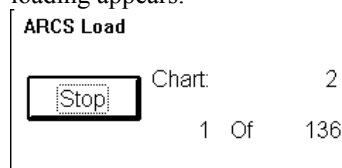

This dialog box displays status of loading.

4. Repeat step 3 until you have loaded all the CD-ROMs involved your licence, after you have load all the CD-ROMs, press **Cancel** to close **ARCS Load** dialog box.

Load by active group

Loading by active group is used when you want to load only ARCS charts which you have designed to include to defined group. This is very useful if your licence includes lot of charts all around the world and you are going to use only a part of charts to which you have permit. You just define a group from charts you need for voyage and load them into the system. To load by active group, proceed as followed:

1. Define a group, if does not exist. For more information, see chapter "Group of ARCS charts" on page 170.
2. Set group as an Active group. To set group as Active group, "How to select active group" on page 173.

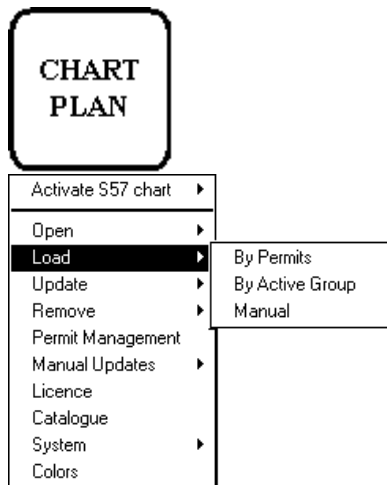

3. Press CHART PLAN push button, select **Load** from the menu and **by Active group** from the sub menu.
4. An **ARCS Load** dialog box appears, which indicates active group and desired ARCS CD-ROMs

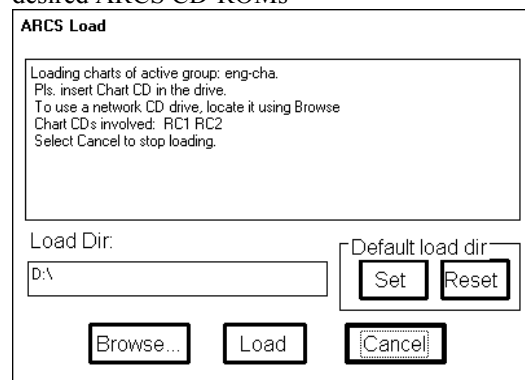

5. Insert desired CD-ROM to CD-ROM drive and press **Load**.
6. Repeat step 5 until you have loaded all the CD-ROMs involved the active group, after you have load all the CD-ROMs, press **Cancel** to close **ARCS Load** dialog box.

Load manual

You can also load ARCS charts manual into the system, to load charts proceed as follows:

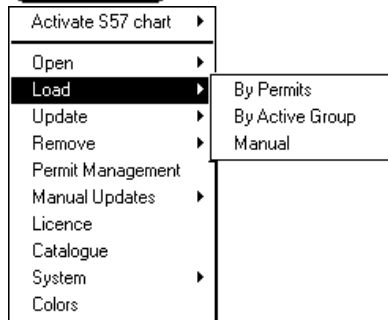

1. Insert desired ARCS CD-ROM into CD-ROM drive.
2. Press CHART PLAN push button, select **Load** from the menu and **manual** from the sub menu.
3. A Chart Operations dialog box appears, select desired chart from list box.

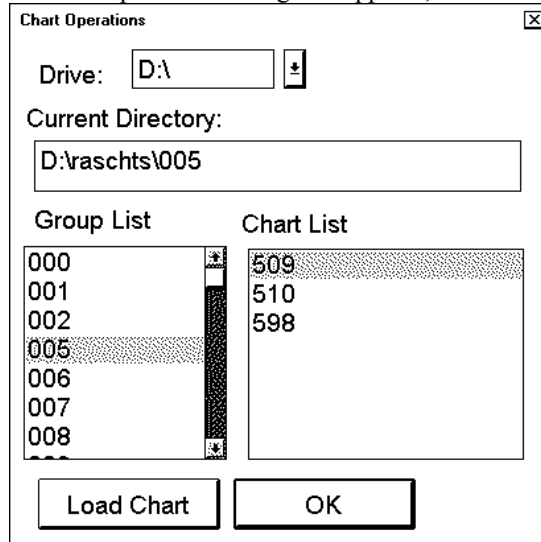

To load chart into the system press **Load Chart** button. To close this dialog box press **OK** button.

Note! If you want to use another CD-ROM drive connected in your network, use **Chart Operations** window to select another CD-ROM drive.

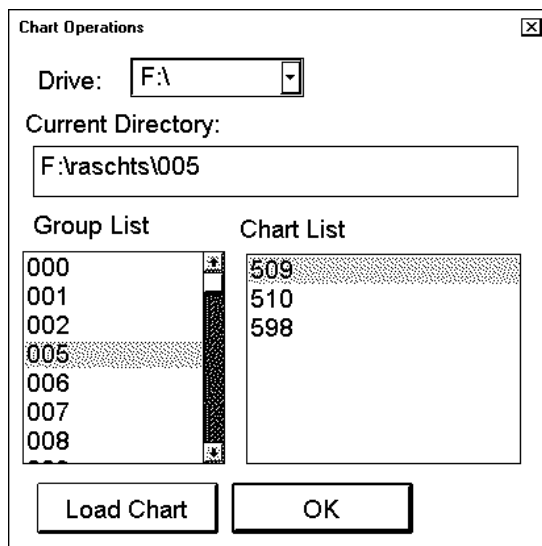

D: local CD-ROM drive.

F: other station CD-ROM drive.

How to update ARCS chart

The updates are delivered separately in update CD-ROM. To update ARCS format raster chart into the system, you can use one of following procedures:

- **Update by permit.** You can update all the charts which are involved in your licence. The system will update them automatically.
- **Update by active group.** You can define a group of charts to be updated. It will be useful to define groups to make it easier to maintain your database.
- **Loading updates manual.** You can select manually the charts, which will be updated into the system.

Loading updates by permits

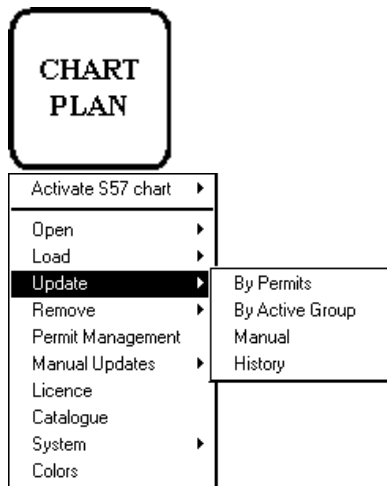

1. Press CHART PLAN push button.
2. Select **Update** for the menu and **by permits** from the sub menu.

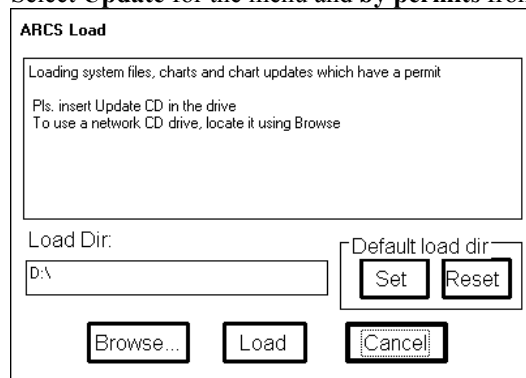

3. Insert update CD-ROM to drive and press **Load**. A progress indicator of loading appears.

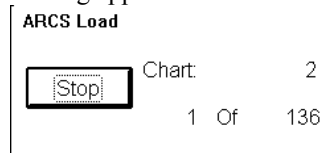

System will update automatically charts you have permit.

Loading updates by Active group

Loading updates by active group is used when you want to update only ARCS charts which you have designed to include to defined group. This is very useful if your licence includes lot of charts all around a world and you are going to use only a part of charts to which you have permit. You just define a group from charts you need for voyage and update them into the system. To update by active group, proceed as followed:

1. Define a group, if does not exist. For more information, see chapter "Group of ARCS charts" on page 170.
2. Set group as an Active group. To set group as Active group, see "How to select active group" on page 173.
3. Press CHART PLAN push button, select **Update** from the menu and **Active group** from the sub menu.
4. An **ARCS Update** dialog box appears, which indicates active group

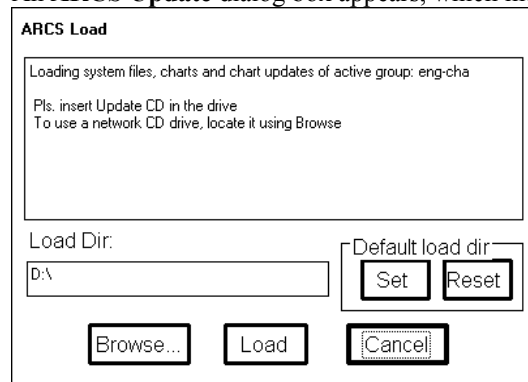
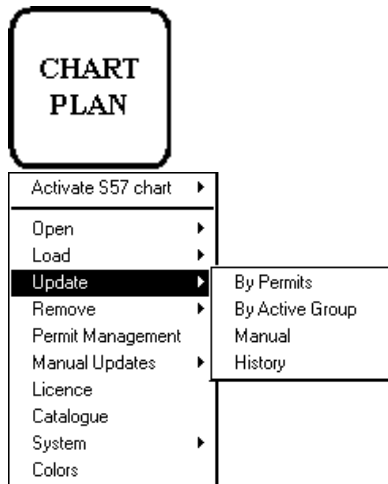

5. Insert Update CD-ROM to CD-ROM drive and press **Load**.

Loading updates manual

You can also load updates for ARCS charts manual. To load chart updates manual, proceed as follows:

1. Insert Update ARCS CD-ROM into CD-ROM drive.
2. Press CHART PLAN push button, select **Update** from the menu and **manual** from the sub menu.
3. A Chart Operations dialog box appears, select desired chart from list box.

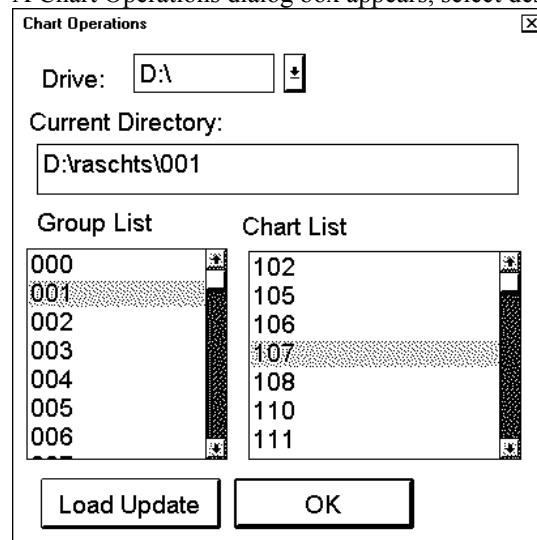
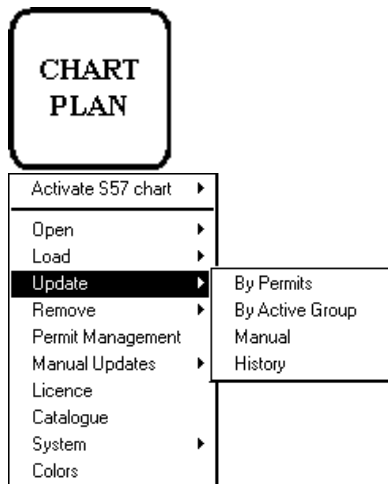

To load updates into the system press **Load Update** button. To close this dialog box press **OK** button.

Note! If you want to use another CD-ROM drive connected in your network, use **Chart Operations** window to select another CD-ROM drive.

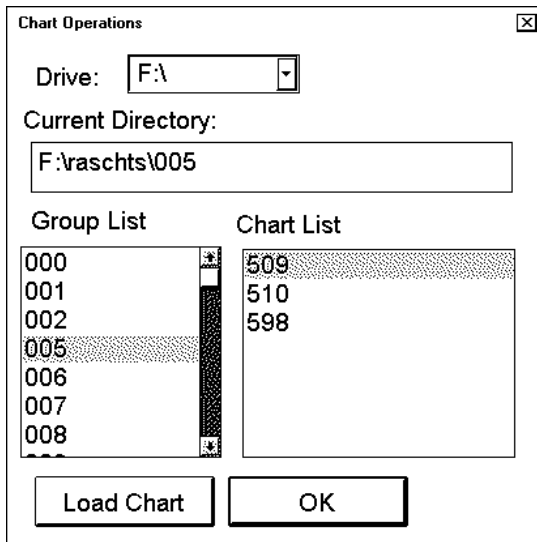

D: local CD-ROM drive.

F: other station CD-ROM drive.

How to view chart load and update history of ARCS

It is possible to view all history of chart load and updates (Notices to Mariners) of ARCS. There are a log book to keep tracking which Chart and Updates are loaded to the ECDIS. Proceed as follows to open log book of loaded ARCS Updates:

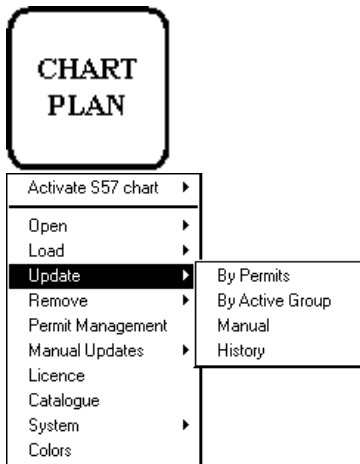

1. Press CHART PLAN push button, select **Update** from the menu and **History** from the submenu.
2. Log file of loaded ARCS Update appears:

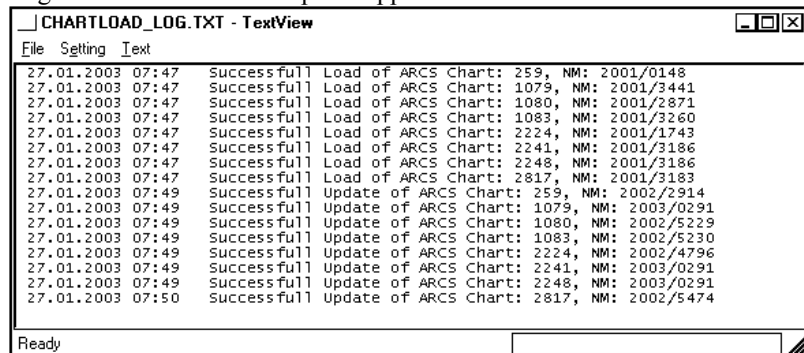

You can view all loaded NM to the ECDIS.

How to view update status of your ARCS charts

You can easily check at any moment, which has been the latest Update CD introduced to your system.

To view update status of ARCS charts, proceed as followed:

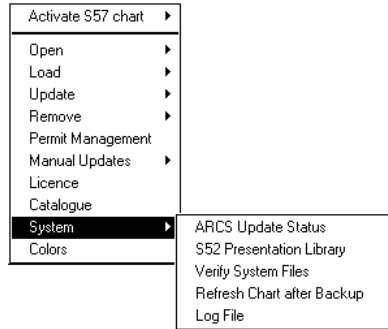

1. Press CHART PLAN push button and select **System** from the menu, select **ARCS Update Status** from the submenu
2. ARCS Message dialog box appears.

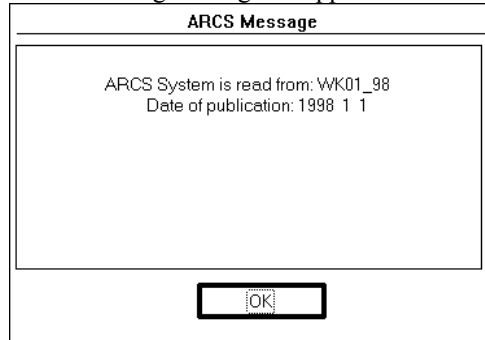

In this dialog is shown information of Latest Update CD, which is loaded into the system.

ARCS Catalogue

For the managing of ARCS charts it is possible to use ARCS Catalogue command. This command is available from CHART PLAN menu. By choosing this command an ARCS Catalogue window opens up in the Electronic chart area and ARCS Catalogue dialog appears in the dialog box area.

Mon.Route	Plan Route TOKYO	Pilot Data HKI-TAL	Depth	Height	North Up	TM	TrueVect
UserChart	Ref Target	ARPA 1 Radar	RCDS Mode	Ship off screen			

Arcs Catalogue																																									
	<p>59°51.538'N Gyro 219.1°</p> <p>024°28.031'E COG 219.2°</p> <p>WGS 84 (pos)</p> <p>FILTER HIGH SOG 23.2 Kt</p> <table border="1"> <tr> <td>Plan Speed</td> <td>20.0 Kt</td> <td>To WP</td> <td>3</td> </tr> <tr> <td>Plan</td> <td>216.9°</td> <td>Dist WOP</td> <td>2.55 nm</td> </tr> <tr> <td>Route</td> <td>216.8°</td> <td>Time</td> <td>06:36</td> </tr> <tr> <td>Ch limit</td> <td>185 m</td> <td>Next WP</td> <td>4</td> </tr> <tr> <td>Off track</td> <td><32 m</td> <td>Next</td> <td>228.4°</td> </tr> <tr> <td></td> <td></td> <td>Turn rad</td> <td>1.0 nm</td> </tr> <tr> <td></td> <td></td> <td>Turn rate</td> <td>22°/min</td> </tr> </table> <p>ARCS Catalogue</p> <p>View Filters</p> <table border="1"> <tr> <td><input checked="" type="checkbox"/> Inset</td> <td>Scale:</td> </tr> <tr> <td><input checked="" type="checkbox"/> Name</td> <td><input checked="" type="checkbox"/> Planning</td> </tr> <tr> <td><input type="checkbox"/> Permit</td> <td><input checked="" type="checkbox"/> Ocean</td> </tr> <tr> <td></td> <td><input checked="" type="checkbox"/> Coastal</td> </tr> <tr> <td></td> <td><input checked="" type="checkbox"/> Approach</td> </tr> <tr> <td></td> <td><input checked="" type="checkbox"/> Harbour</td> </tr> </table> <p>Selected Chart</p> <p>Number: 2248 <input type="button" value="Check"/></p> <p>Orig. Scale: 200 000 <input type="button" value="Open"/></p> <p>Chart CD: RC3 <input type="button" value="Previous"/></p> <p><input checked="" type="checkbox"/> Permit <input checked="" type="checkbox"/> Loaded</p> <p>Group</p> <p>Edit dp <input type="button" value="Groups"/></p> <p><input type="button" value="Add Frame"/> <input type="button" value="Remove Frame"/> <input type="button" value="Done"/> <input type="button" value="Cancel"/></p> <p>Cursor</p> <p>From Own Ship: 46.75 nm 348.6°</p> <p>37°19.193N 025°58.734E</p>	Plan Speed	20.0 Kt	To WP	3	Plan	216.9°	Dist WOP	2.55 nm	Route	216.8°	Time	06:36	Ch limit	185 m	Next WP	4	Off track	<32 m	Next	228.4°			Turn rad	1.0 nm			Turn rate	22°/min	<input checked="" type="checkbox"/> Inset	Scale:	<input checked="" type="checkbox"/> Name	<input checked="" type="checkbox"/> Planning	<input type="checkbox"/> Permit	<input checked="" type="checkbox"/> Ocean		<input checked="" type="checkbox"/> Coastal		<input checked="" type="checkbox"/> Approach		<input checked="" type="checkbox"/> Harbour
Plan Speed	20.0 Kt	To WP	3																																						
Plan	216.9°	Dist WOP	2.55 nm																																						
Route	216.8°	Time	06:36																																						
Ch limit	185 m	Next WP	4																																						
Off track	<32 m	Next	228.4°																																						
		Turn rad	1.0 nm																																						
		Turn rate	22°/min																																						
<input checked="" type="checkbox"/> Inset	Scale:																																								
<input checked="" type="checkbox"/> Name	<input checked="" type="checkbox"/> Planning																																								
<input type="checkbox"/> Permit	<input checked="" type="checkbox"/> Ocean																																								
	<input checked="" type="checkbox"/> Coastal																																								
	<input checked="" type="checkbox"/> Approach																																								
	<input checked="" type="checkbox"/> Harbour																																								

17.05.2001 13:15 UTC	17.05.2001 16:15 FLE Standard Time	SINGLE	1:202 000	az.03
----------------------	------------------------------------	--------	-----------	-------

View filters:

User can filter ARCS chart limits displayed in ARCS Catalog window selecting desired options in View filters -field.

There are different categories for the ARCS charts depending on scale of them. The categories are:

1. Planning
2. Ocean
3. Coastal
4. Approach
5. Harbour

Selection of **Inset** displays insets included in charts, selection of **Name** displays ID number of charts and selection of **Permit** displays limits only for charts which the system has permit to use.

Selection of **All Charts** displays limits for all the ARCS charts available and selection of **Group Charts** displays limits for user defined group charts.

The ARCS catalogue displays chart limits with different colours. Each ARCS weekly update CD contains information for every charts available in UKHO with up-to-date information at the point of issue date. When loading Updates using **by Permits** or **by Active group**, this information is loaded into ECDIS. This information is used to display limits of charts on ARCS Catalogue. The chart limit boxes are colour coded as follows:

- Green** The chart is available for use and it is also up-to-date.
- Orange** The chart has valid permit and it is loaded on hard disk, but not up-to-date. Update chart using the same weekly updates as displaying ARCS Catalogue information.
- Red** Neither permit nor chart has been loaded onto hard disk. Load permit, chart and updates.
- Blue** The chart cannot be seen on ECDIS. Possible reasons are:
1. Chart permit is for different edition of the chart. Typical situation when occur; new edition of chart has been issued, but either only new permit or only new chart has been loaded onto hard disk.
 2. Chart permit has expired. Contact your chart agent to renew permit for the chart.
 3. Content of the chart is corrupted. Load the chart and updates.
- Magenta** A permit of chart has been loaded, but the chart is not loaded on hard disk. Chart cannot be seen on ECDIS before loading the chart.

You can select chart by clicking the limit of chart in ARCS catalogue window. The information of selected chart is displayed on field of **Selected Chart**.

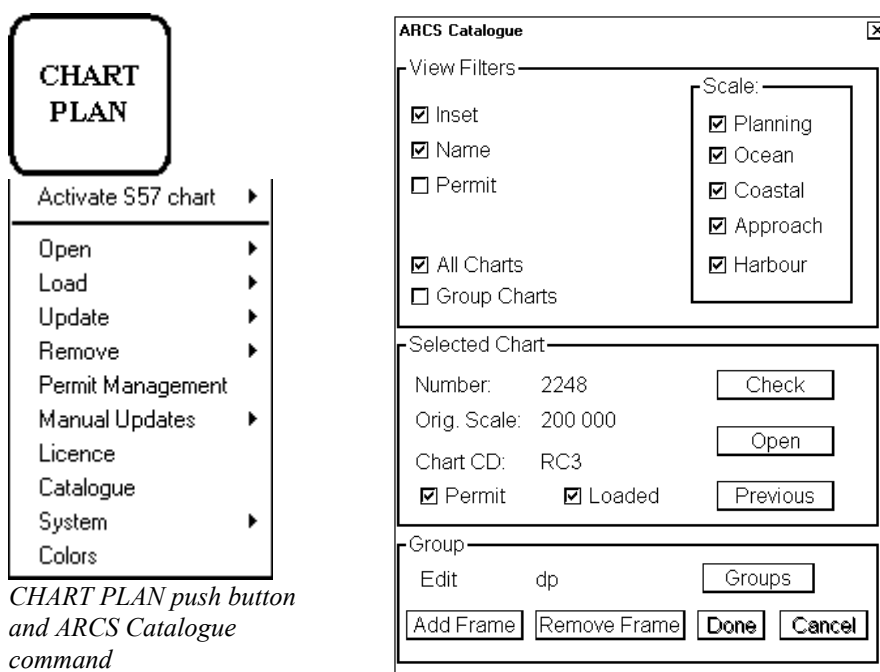

CHART PLAN push button and ARCS Catalogue command

After you have clicked the limit of chart you get information of chart in **Selected Chart** field as follows:

- **Number**; Chart number as stated on the face of the paper chart.
- **Orig. Scale**; Scale of original paper chart.
- **Chart CD**; The number of area CD in which selected chart is stored.
- **Permit**; if selected there is permit in ECDIS.
- **Loaded**; if selected chart is loaded into ECDIS.

There are also a few buttons in this dialog. **Check** button is used to check selected chart if edition and updates of chart are valid.

Open button opens selected chart, if it has been loaded and the system has permit for selected chart.

Previous open previous view of Catalogue window.

With **Group** button user can define a group of charts, see “Group of ARCS charts” on page 170.

Group of ARCS charts

How to create a group

To create user defined group, proceed as follows:

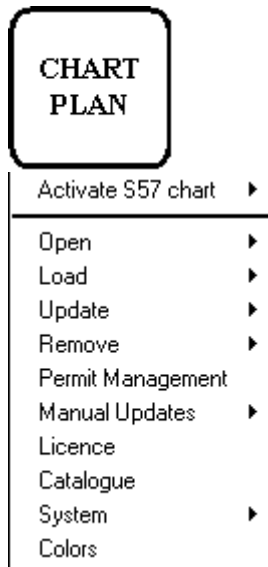

1. Press CHART PLAN push button.
2. Select **Catalogue** from the menu. ARCS Catalog dialog box appears.
3. Press **Groups** button in group -field. A Chart Group dialog box appears.
4. Press **New** button, define a name for new chart group using "type writer", press **OK** button when ready.

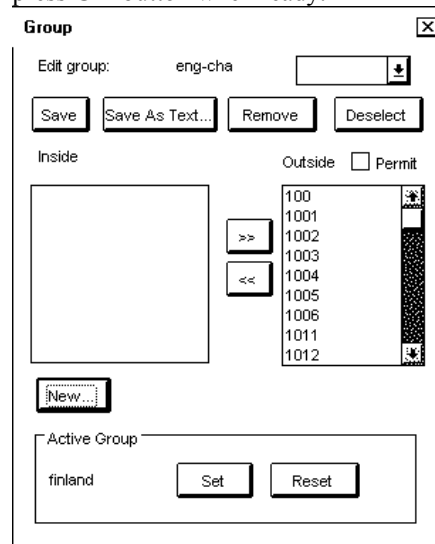

Entered group name appears to **Edit group** -field (eng-cha). Now you can define chart cells which are included this group.

How to add ARCS charts into a group

After you have entered name for group, press **Add frame** button in ARCS Catalog dialog box, you can make a frame in ARCS Catalog window moving cursor desired location and pressing **SELECT** push button.

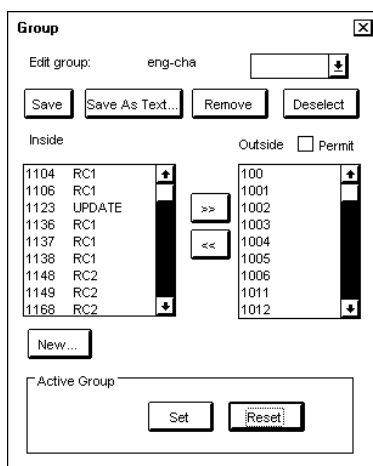
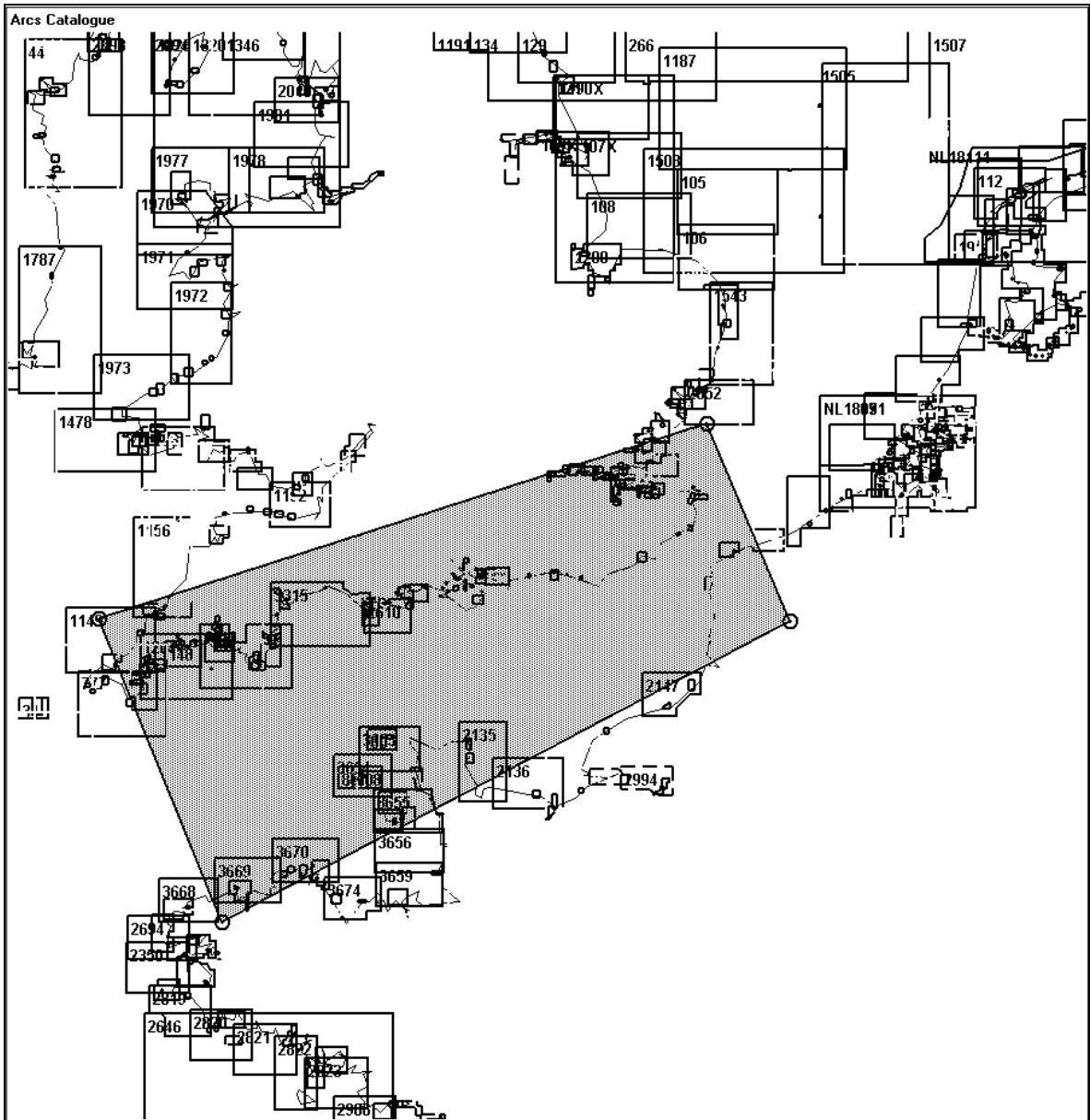

Charts that are inside a frame or intersect a frame limit are added into the group. When your frame is ready press **Done** button in ARCS Catalog dialog box. Chart cells which are selected into defined group are displayed in **Inside** list box in Chart group dialog box.

You can also add charts to your group by using << (add) button. To add a chart, select (highlight) chart ID in **Outside** list box and then press << button.

Note! If you select **Permit** check box, the system will display only chart cells you have permits.

When you are satisfied with selection you have done, press **Save** button to save defined group.

You can save your chart cells also into text file, if you like to have a list of chart cells in text format. To do this press **Save As Text...** button. A "Save As" dialog box appears.

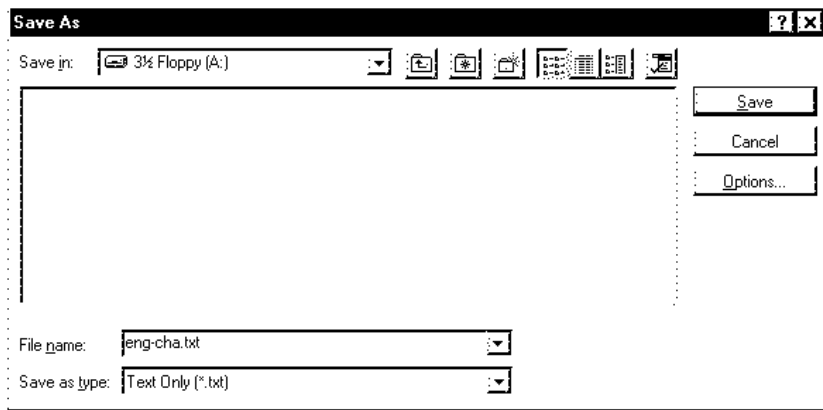

Select directory and drive to where you want save your group. You can use Windows NotePad application to view and to make hard copy from the list of group.

How to remove ARCS charts from a group

You can remove charts from a defined group. To remove proceed as followed:

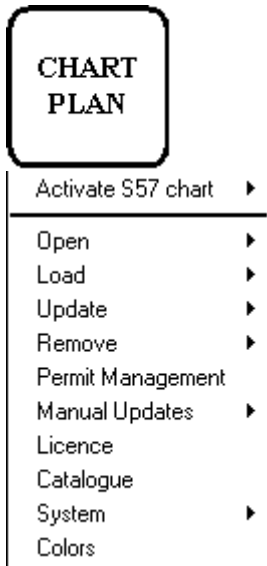

1. Press CHART PLAN push button. Select **Catalogue** from the menu.
2. Press **Groups** button in ARCS Catalog dialog box. A Chart group dialog box appears.
3. Select desired group from **Edit group** list box.
4. Select desired chart(s) from Inside list box.
5. Press >> button. Selected chart is removed to Outside list box and it is not member of defined group anymore.

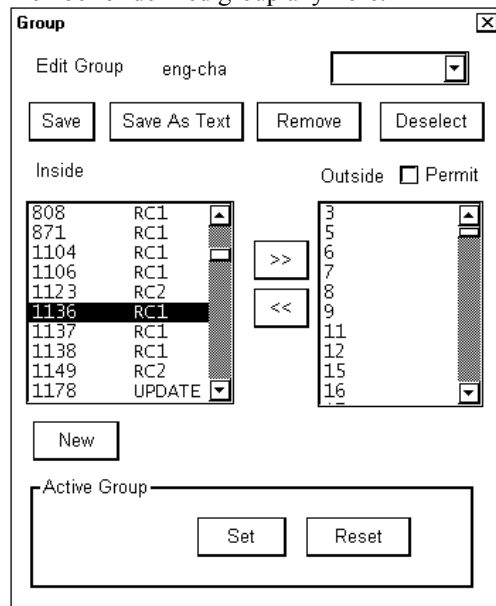

How to select active group

You can select a group as an active group. To select, proceed as followed:

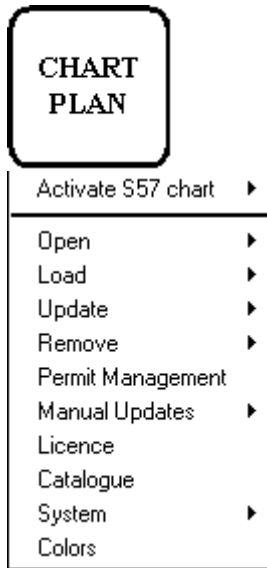

1. Press CHART PLAN push button. Select **Catalogue** from the menu.
2. Press **Groups...** button in an ARCS Catalog dialog box. A Chart group dialog box appears.
3. Select desired group from **Edit group** list box.
4. In **Active Group** -field press **Set** button. The name of active group appears to **Active Group** -field.

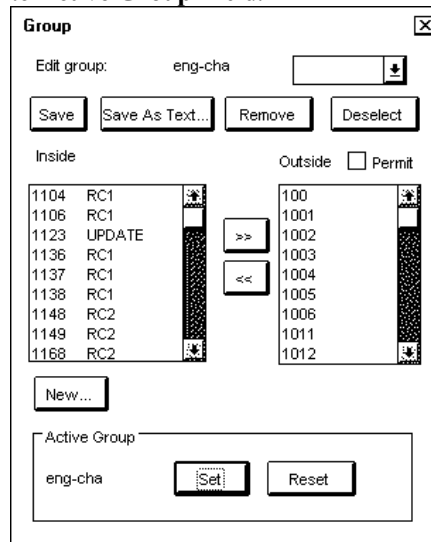

How to delete a group

You can remove a defined group from a hard disk. To remove proceed as followed:

1. Press CHART PLAN push button. Select **Catalogue** from the menu.
2. Press **Groups** button in an ARCS Catalog dialog box. A Chart group dialog box appears.
3. Select desired group from **Edit group** list box.
4. Press **Remove** button. Confirm deleting a group, press **OK**.

How to remove ARCS chart from the system

You can remove ARCS charts from the system either **Manual** or **by Active group**.

Manual remove of charts

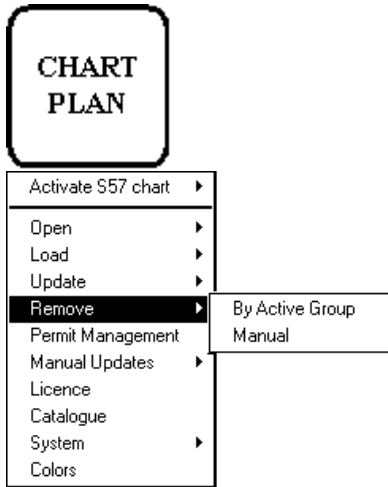

1. From the Control panel press CHART PLAN pushbutton.
2. From menu check that there is a following text in first line: **Activate S57 chart**. If it is, then go to step 4.
3. If there is text **Activate ARCS chart** choose this command.
4. Select **Remove** from the menu and **manual** from the sub menu. There will appear a chart list dialog.

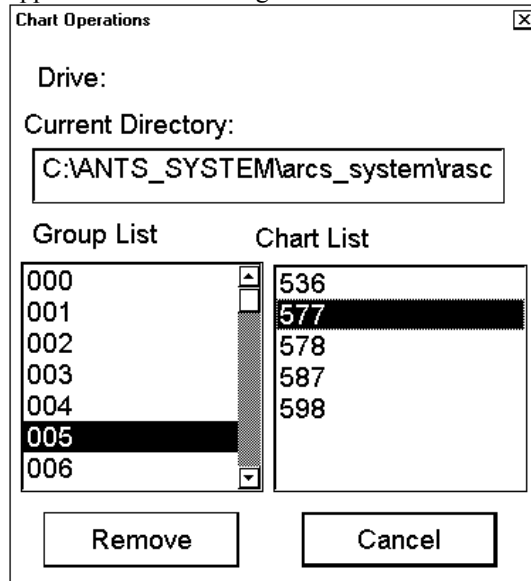

5. Select desired charts to remove them from the system.
6. Press **OK** button. System will remove charts from the hard disk.

Remove charts using Active group

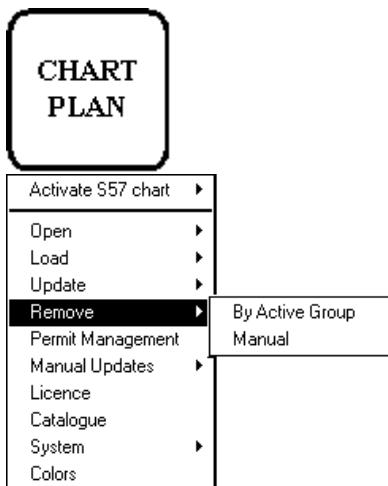

1. From the Control panel press CHART PLAN pushbutton.
2. From menu check that there is a following text in first line: **Activate S57 chart**. If it is, then go to step 4.
3. If there is text **Activate ARCS chart** choose this command.
4. Select **Remove** from the menu and **by Active Group** from the sub menu. There will appear an ARCS Remove dialog box.

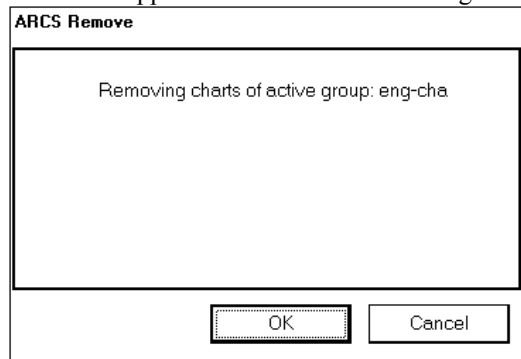

Press **OK** button, the system will remove ARCS charts from hard disk which are involved in Active group.

ARCS chart display

How to select ARCS chart material on display

To select ARCS format raster chart material onto the display proceed as follows:

1. From Control Panel press **Chart Plan** pushbutton.
2. From menu check that there is a following text in first line: **Activate S57 chart**. If it is, then go to step 4.
3. If there is text **Activate ARCS chart** choose this command and select **Ignore** or **Sync Scale** from the sub menu.
4. You have now selected ARCS charts on display.

How to select used Datum

Datum is used to select between different models of the earth. It is essential that you use Datum in a consistent way.

If you use paper charts together with electronic chart material, it is recommended that you use the same Datum as your current paper chart to avoid misalignment between your electronic system and points taken or plotted on your current paper chart.

Once you have selected a datum, all numerical latitude-longitude position values are presented in your selected datum.

Note: If you use ARCS raster chart material the rasterized charts contain some rasterized position information. These positions like scales in the edges of ARCS charts are true only if you have selected native datum of that ARCS chart. Normally this is the natural situation, because you use ARCS together with equal official paper chart and because you have selected as datum the datum of your equal official paper chart.

To find out native datum of ARCS chart, proceed as follows:

ARCS chart

Chart Number :	2224
Country Of Origin:	United Kingdom
Latest NM:	1743/2001
Edition Date:	1998 12 10
Publication Date:	2001 5 3
WGS shift status:	Defined
Depth:	Metres
Height:	Metres
<input type="button" value="T&P Notices.."/> <input type="button" value="Details..."/>	
<input type="button" value="Warnings..."/>	

1. Press **Details...** button in Chart legend dialog box.

2. ARCS details dialog box appears. In **Hor Datum** field is indicated native datum of displayed ARCS chart. See Figure below.

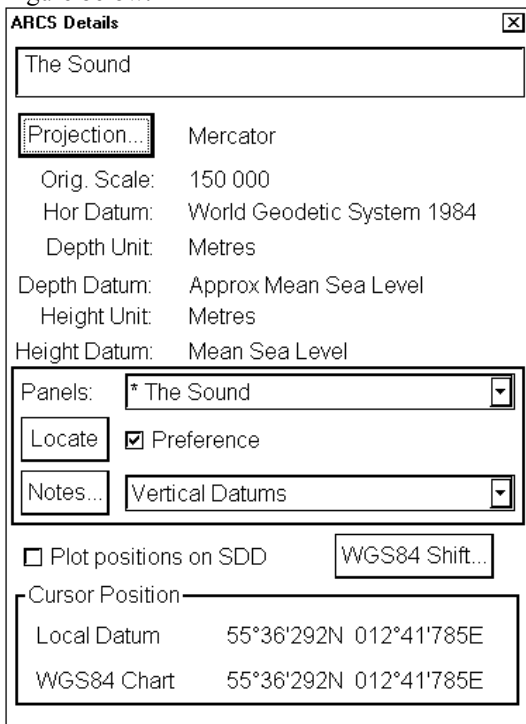

To select datum which is used by the system, proceed as follows:

1. Press **Initial setting** push button.
2. Select desired datum from a list box of **Datum**.
3. Selected datum is shown on the Upper information area.

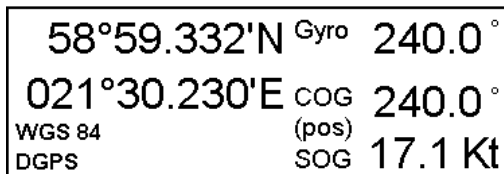

Selected datum is shown on Upper information area (in this case WGS 84).

How to view different charts

Select a chart from catalogue

To select ARCS format raster chart onto the display by using **ARCS catalogue**, proceed as follows:

1. From Control Panel press Chart Plan pushbutton.
2. Select **Catalogue** command from the menu.
3. From the catalogue window activate desired chart to open. For more information, see "ARCS Catalog" on page 168.
4. Press button **Open**.

Indication of availability of alternative charts such as S57 (ENC) or other suitable ARCS chart

The system has several indications for availability of charts. The indication is based on information available from position of own ship, if automatic TM reset is active or from current position of cursor, if automatic TM Reset is OFF:

- If larger scale ARCS is available, indication is: **Larger RNC**
- If same scale ARCS is available, indication is: **Eq RNC**
- If larger compilation scale ENC is available, indication is: **Larger ENC**
- If same compilation scale ENC is available, indication is: **Eq ENC**
- If smaller compilation scale ENC is available, indication is: **Smaller ENC**

NOTE! When using ARCS the system also recognise, if ENCs are available over specified area and indicates it with texts shown above. This is important because under the current IMO rules only ENC chart could fully replace the traditional paper charts.

Browsing around your charts

Viewing ARCS charts from different places and using different scales is very easy. Basic tools to go around are push buttons **ZOOM IN**, **ZOOM OUT**, **SET CHART CENTER**, **SHIP OFF CENTER** and **TM/CU RESET**.

You can use **SET CHART CENTER** to look ahead any other place than your own ship position. Pressing it set automatic True Motion Reset OFF. When TM Reset is OFF you have on upper right hand part of the display either indication **Ship out of dsp** or **TM RESET OFF** depending of the view.

You can enter numerical values for center of chart to display. Press **DISPLAY MODE** push button and select **Set Center** from the menu, a Chart Center dialog box appears:

True Motion North Up True Motion Course Up Relative Motion North Up Relative Motion Course Up Relative Motion Head Up Relative Motion Route Up <hr/> Set Center	Chart Center Lat: <input type="text" value="60°13.686N"/> Lon: <input type="text" value="024°57.897E"/> -- - + ++ -- - + ++ Set Center
---	---

Enter desired values for center of chart to be displayed.

If you want immediately back to your own ship position, push **TM/CU RESET**.

ZOOM IN and **ZOOM OUT** are used to change scale of chart. If TM reset is active, **ZOOMI IN** and **ZOOM OUT** keep the relative position of the own ship respect to the display. If TM Reset is OFF, **ZOOM IN** and **ZOOM OUT** keep the relative position pointed by cursor respect to the display. ARCS system allows 2* overscaling and ½* underscaling. The system has a logical way to automatically select next larger or smaller scale chart automatically. If the system uses natural scale of an ARCS chart, the scale indication is in black color like **1:100000**. If the system

uses underscale or overscale image of an ARCS chart, the scale indication is in red colour like **1:20000**. The system has also indication **UNDERSCALE** or **OVERSCALE**.

The system has indication of **Equal RNC**, if you have a chart with the same scale and overlapping with displayed ARCS chart. When you are reaching to edge of chart and you have indication **Equal RNC**, you can switch an other chart with the same scale to the display by pressing **SELECT NEXT** push button from the Control Panel. An overlapping chart with same scale will be opened.

Look charts around your own ship

You can use either **TRUE MOTION** or **RELATIVE MOTION**. Refer to **DISPLAY MODE** chapter. In True motion your own ship moves until it reaches the true motion reset borderline. Then it will jump back to opposite position on screen based on its course. In relative motion your own ship stays in a fixed position while the chart under it moves on screen.

If you use true motion and you press **TM/CU RESET**, your ship will immediately jump to true motion reset position.

If you use true motion and you press **SHIP OFF CENTER**, your ship will go to that position on screen and continue true motion movement from that position. When it reaches true motion reset borderline it will automatically jump to true motion reset position.

If you use relative motion and you press **TM/CU RESET**, your ship will immediately jump to true motion reset position and use that position as fixed position to stay on screen.

If you use relative motion, you can select a new fixed position to your ship by pressing **SHIP OFF CENTER** push button.

Use **ZOOM IN** and **ZOOM OUT** push buttons to select desired scale of the chart.

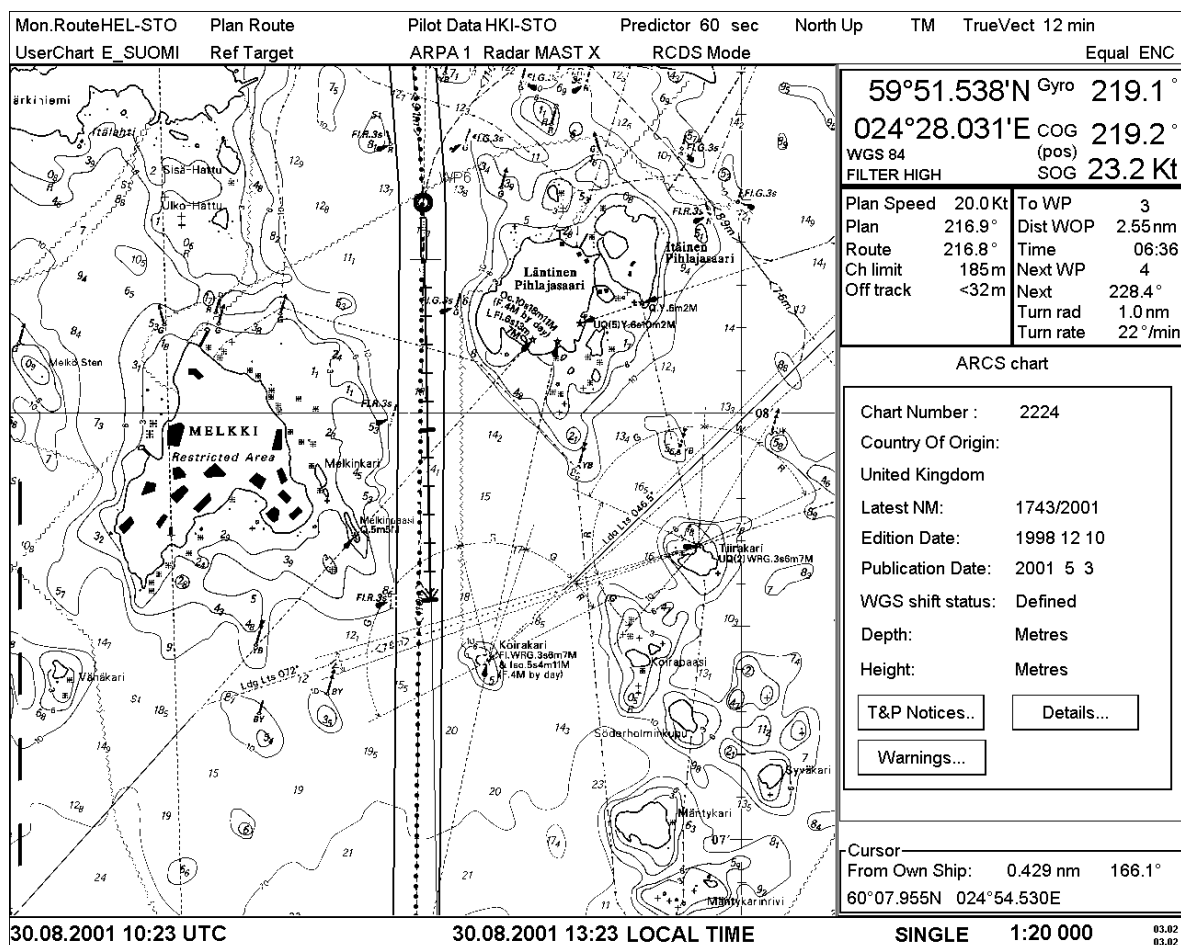

This is possible view of ECDIS screen, note also upper status bar indications and no **TM RESET OFF** and ECDIS indicates that **Equal ENC** available at own ship position.

How to select an ARCS chart by its number on display

Open ARCS chart manual

To select a specific ARCS format raster chart onto the display use **Open** menu command. Proceed as follows:

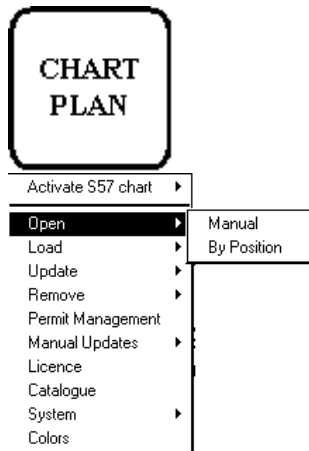

1. From Control Panel press CHART PLAN push button.
2. If there is text **Activate ARCS chart** choose this command otherwise continue.
3. Select **Open** from the menu and **manual** from sub menu

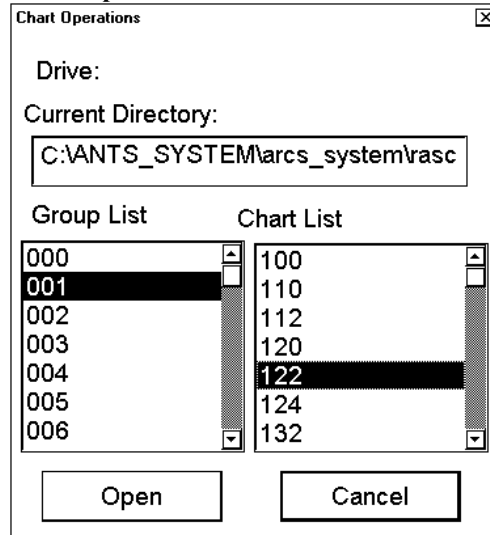

4. Choose desired chart from chart list dialog and press **Open**.
5. When you select a chart it will be displayed automatically in the Electronic chart area.

Open ARCS chart by position

To open an ARCS chart by position of own ship or by chart center, if your display is in TM RESET OFF status, use **Open by position** command. Then you get a list of charts which cover current position. To open chart by position, proceed as followed:

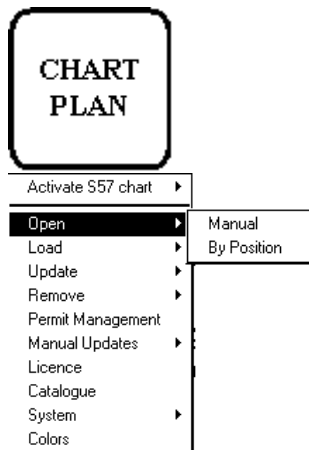

1. From Control Panel press CHART PLAN push button.
2. If there is text **Activate ARCS chart** choose this command otherwise continue.
3. Select **Open** from the menu and **By Position** from sub menu. There will appear ARCS Open dialog box

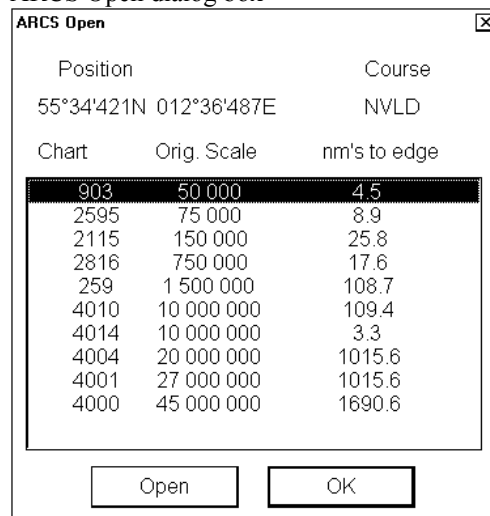

Select desired chart from a list box and press **Open**.

Control of visible chart features

When you press **CHART DISPLAY** pushbutton, you get Chart details window, which have several sheets to control visible chart features.

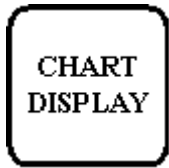

CHART DISPLAY push button. Dialog box which appears after pressing chart display push button.

Chart display - ALL-OFF *			
ARCS details	Tracking	Mariner	Route
Chart	Standard	Other	
Echo alarm	0	m	
Shallow contour	5	m	
Safety depth	8	m	
Safety contour	10	m	
Deep contour	20	m	
Speed Vectors	12	min	TRUE
TM reset margin	80	%	
Scale	1:10000		
Palette	DAY BRIGHT		
Symbols	SIMPLIFIED		
Depths	TWO COLOUR		
Boundaries	PLAIN		
Light sectors	LIMITED		
Shallow pattern	NONE		
Update highlight	DETAILED		

Echo alarm depth:

User can set alarm limit for echosounder. If depth of water below transducer of the Echosounder is below the limit, an alarm will be generated.

Speed Vectors:

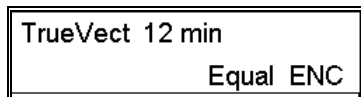

User can set vector time and presentation type for speed vectors displayed on ECDIS screen. Selected presentation type and length for speed vectors is indicated Upper right hand corner of ECDIS screen.

True Vectors = TrueVect
Relative Vectors = RelVect

TM reset margin:

In True motion your own ship moves until it reaches the true motion reset borderline. Then it will jump back to opposite position on screen based on its course. User can set the limit for TM reset.

Scale:

This function determines the displayed scale of the electronic chart.

Palette:

Enable user to choose appropriate palette for display depending on brightness of the bridge.

Note! ARCS charts are photocopies of original paper chart. One cannot change image of these photocopies. Selections of Shallow contour, Safety depth, Safety contour, Deep Contour, Symbols, Depths, Boundaries, Light sectors, Shallow pattern and Update highlight in Chart sheet control only visibility of add-on layer(s) on top of ARCS chart image (manual updates are such an add-on layer). For more information about manual updates, see chapter "Manual Updates".

Black and grey colour symbol:



This symbol is used to verify that you can distinguish black (frame of symbol) and grey (inner part of symbol) colours with current contrast and brilliance settings.

Shallow contour: (NOTE: control only add-on layer - manual update - on top of ARCS chart image)

User can set value of shallow water contour.

Safety depth: (NOTE: control only add-on layer - manual update - on top of ARCS chart image)

User can set the value of safety depth. Spot soundings below the Safety depth are displayed as highlighted.

Safety contour: (NOTE: control only add-on layer - manual update - on top of ARCS chart image)

User can set value of safety contour. Visible safety contour is equal to set value or if the contour of set value is not available then the visible safety contour is next deeper contour than safety contour.

Note, the system uses Safety contour also for Chart Alarms.

Deep contour: (NOTE: control only add-on layer - manual update - on top of ARCS chart image)

User can set deep water contour.

Symbols: (NOTE: control only add-on layer - manual update - on top of ARCS chart image)

Enable user to choose how to display symbols of the chart. The options are:

- **Simplified**, the shape of symbols is of modern design and the sea mark symbols use colour fill
- **Paper Chart**, the shape of symbols imitates traditional symbols used in paper charts

Depths: (NOTE: control only add-on layer - manual update - on top of ARCS chart image)

User can set how to display different depth zones on the chart display. If user selects multicolour, the chart display uses 4 different colours:

- deeper than user-selected deep contour
- between deep contour and user-selected safety contour
- between safety contour and user-selected shallow water contour
- between shallow water contour and coastline.

If user selects two colours, the chart display uses only two colours:

- deeper than safety contour
- shallower than safety contour

Boundaries: (NOTE: control only add-on layer - manual update - on top of ARCS chart image)

User can set how to display boundaries of some chart features. The options are:

- **Plain**, the used line styles are limited to plain solid and dashed lines.
- **Symbolized**, some of the used line styles use symbols to highlight the purpose of a line

Light sector: (NOTE: control only add-on layer - manual update - on top of ARCS chart image)

User can set how to display light sectors. The options are:

- **Limited**, the length of light sector is fixed at 25 mm independently of the displayed scale.
- **Full**, the length of light sector represent its nominal range as defined by the chart producer.

Shallow pattern: (NOTE: control only add-on layer - manual update - on top of ARCS chart image)

User can set how to display shallow water area. The options are:

- **None**
- **Diamond**, is provided to distinguish shallow water at night

Update Highlight: (NOTE: control only add-on layer - manual update - on top of ARCS chart image)

User can set how the updates are highlighted on the screen before they are approved by the user. The options are

- **Detailed**, system try to highlight updates so that only those objects, which has visible changes, are highlighted. Use this option to see the practical change of an update.
- **All effects**, system highlights updates so that all the objects, which has something to do with updates, are highlighted although some of them has not been changed from practical point of view.

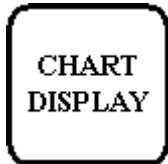

Press CHART DISPLAY button to open Chart details dialog box. Standard display includes chart features shown here. The system will show these chart features, when button STANDARD DISPLAY is pressed.

“STANDARD”-sheet

Sheet STANDARD contains chart features as defined by IMO to form so called Standard Display. You can recall at any time the Standard Display by single operator action (by pressing STANDARD DISPLAY button from Control Panel)

NOTE:
control only add-on layer - manual update - on top of ARCS chart image

Chart display - ALL-ON *

ARCS details	Tracking	Mariner	Route
Chart	Standard	Other	
<input checked="" type="checkbox"/> Unknown object or presentation			
<input checked="" type="checkbox"/> Chart data coverage			
<input checked="" type="checkbox"/> Land features			
<input checked="" type="checkbox"/> Water and seabed features			
<input checked="" type="checkbox"/> Traffic routes			
<input type="checkbox"/> Cautionary areas			
<input checked="" type="checkbox"/> Information areas			
<input checked="" type="checkbox"/> Buoys and beacons			
<input checked="" type="checkbox"/> Lights			
<input checked="" type="checkbox"/> Fog signals			
<input checked="" type="checkbox"/> Radar			
<input checked="" type="checkbox"/> Services			

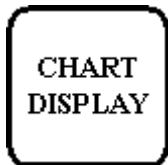

Other includes chart features shown here. The system will not show these features, when button STANDARD DISPLAY is pressed.

“Other”-sheet

Sheet OTHER contains chart features, for which you can control visibility and which are not part of IMO defined Standard Display.

NOTE:
control only add-on layer - manual update - on top of ARCS chart image

Chart display - ALL-OFF *

ARCS details	Tracking	Mariner	Route
Chart	Standard	Other	
<input type="checkbox"/> Information about chart data			
<input checked="" type="checkbox"/> Land features			
<input checked="" type="checkbox"/> Soundings			
<input type="checkbox"/> Depth contours, Currents, Magnetics			
<input type="checkbox"/> Seabed and Obstructions			
<input type="checkbox"/> Services and Small craft facilities			
<input type="checkbox"/> Special areas			
<input checked="" type="checkbox"/> Additional information available			
Important Text			
<input checked="" type="checkbox"/> Clearances, Bearings, Radio channels			
Other Text			
<input checked="" type="checkbox"/> Names for position reporting			
<input checked="" type="checkbox"/> Light descriptions			
<input type="checkbox"/> Nature of Seabed			
<input type="checkbox"/> Geographic names, etc.			
<input type="checkbox"/> Swept depths, Magnetics			
<input type="checkbox"/> Berth and Anchorage numbers			
<input type="checkbox"/> National language, Land elevation			

Note! If you want to use Info request by cursor pick for manual updates you have to select desired chart features to be displayed from this sheet.

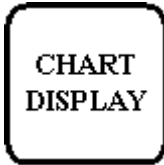

CHART DISPLAY
push button

"ARCS details"-sheet

ARCS details dialog box appear when user press CHART DISPLAY push button. If you have this dialog box already open, you can change sheet **Select Next** push button.

Chart display - ALL-ON *

Chart	Standard	Other	
ARCS details	Tracking	Mariner	Route

View original
 Mark updates

View original, if selected displayed chart is shown without updates.

Mark updates, if selected updated parts of chart are surrounded by red rectangular.

Figures below show how you can find places with updates on a chart.

The ARCS chart that is displayed as for normal use.

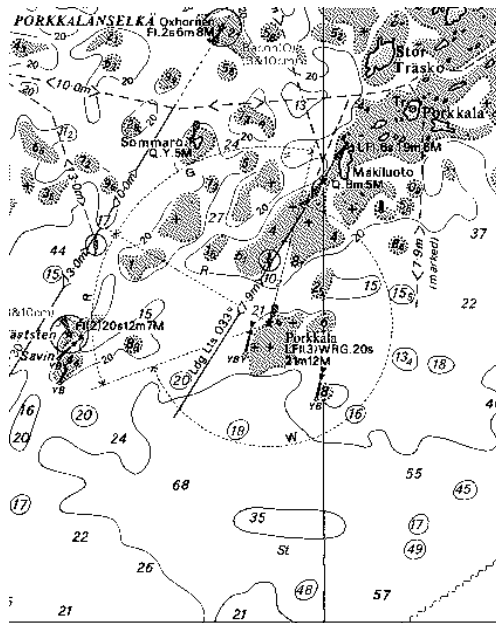

Chart display - ALL-ON *

Chart	Standard	Other	
ARCS details	Tracking	Mariner	Route

View original
 Mark updates

The ARCS chart that is displayed as original edition and places that cover updates are marked with red rectangular.

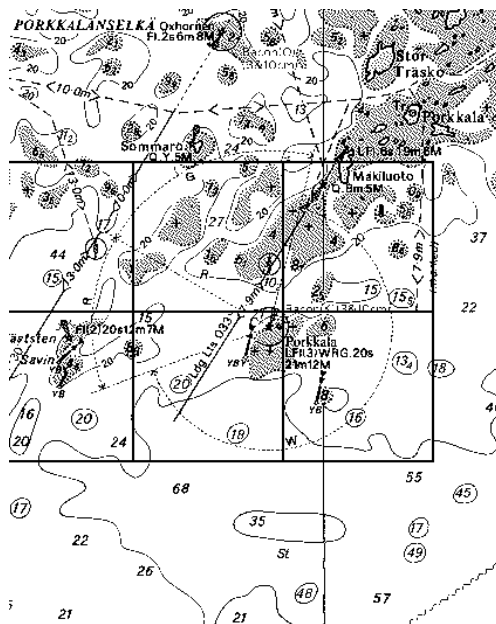

Chart display - ALL-ON *

Chart	Standard	Other	
ARCS details	Tracking	Mariner	Route

View original
 Mark updates

Control of visible navigation features

Visibility control of the navigation features is divided into three sheets. Sheet Route controls Planned and Monitored route. Sheet Tracking control past tracks and some other features. Sheet Mariner control Pilot data, User charts and Chart alarms. Press CHART DISPLAY button to open Chart details window. Use SELECT NEXT to open desired sheet in Chart details window.

User can define settings for chart details which are displayed over ARCS charts. This means that user can select different layers to be **Off**, **Std** or **Other**. Selection of **Off** is self explanatory. Selection of **Std** is set as visible, if the STANDARD DISPLAY button is pressed. Selection of **Other** is set as invisible, if the STANDARD DISPLAY button is pressed

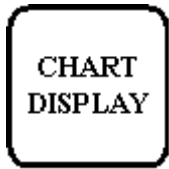

Monitored and planned routes are non-chart information. All the selected items are shown on top of chart data

"ROUTE" sheet

Sheet ROUTE contains selection of route related navigation features

Chart display - ALL-ON *			
Chart	Standard	Other	
ARCS details	Tracking	Mariner	Route
Monitored route			
Off	Std	Other	
<input type="radio"/>	<input checked="" type="radio"/>	<input type="radio"/>	Center line
<input type="radio"/>	<input type="radio"/>	<input checked="" type="radio"/>	Channel borders
<input type="radio"/>	<input type="radio"/>	<input checked="" type="radio"/>	WP - mark
<input type="radio"/>	<input type="radio"/>	<input checked="" type="radio"/>	Leg mark
<input type="radio"/>	<input type="radio"/>	<input checked="" type="radio"/>	Wheel over line
Planned route			
Off	Std	Other	
<input type="radio"/>	<input checked="" type="radio"/>	<input type="radio"/>	Center line
<input type="radio"/>	<input type="radio"/>	<input checked="" type="radio"/>	Channel borders
<input type="radio"/>	<input type="radio"/>	<input checked="" type="radio"/>	WP - mark
<input type="radio"/>	<input type="radio"/>	<input checked="" type="radio"/>	Leg mark

Monitored route, user can select which part of monitored route is displayed.

Planned route, user can select which part of planned route is displayed.

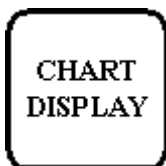

*Past tracks,
Predictor ship,
Events & Positions,
ARPA targets,
Reference targets
and Radaroverlay
are non-chart
information. All the
selected items are
shown on top of
chart data.*

“Tracking” sheet

Chart display - ALL-ON	
Chart	Standard Other
ARCS details	Tracking Mariner Route
Past tracks	
Off Std Other	
<input type="radio"/>	<input type="radio"/> Ship System
<input checked="" type="radio"/>	<input type="radio"/> Ship Primary
<input type="radio"/>	<input type="radio"/> Ship Secondary
Length	<input type="text" value="20"/> min Labels <input type="text" value="5"/> min
<input type="radio"/> <input type="radio"/> ARPA targets	
Length	<input type="text" value="20"/> min Labels <input type="text" value="5"/> min
Off Std Other	
<input type="radio"/>	<input type="radio"/> Predictor ship <input type="text" value="180"/> sec
<input type="radio"/>	<input type="radio"/> User Events
<input type="radio"/>	<input type="radio"/> Automatic Events
<input type="radio"/>	<input type="radio"/> Positions
Show	<input type="text" value="Not older than 3 months"/>
<input type="radio"/>	<input checked="" type="radio"/> Radar Overlay
<input type="radio"/>	<input type="radio"/> ARPA targets
<input type="radio"/>	<input type="radio"/> AIS targets
<input type="radio"/>	<input type="radio"/> AIS target names
Max. count	<input type="text" value="200"/> Max. range <input type="text" value="48"/> nm
Ship true symbol scale	<input type="text" value="1:50000"/>

Past Tracks

- **Ship System**, if selected as **Std** or **Other**, own ship track is displayed based on the position used by the system
- **Ship Primary**, if selected as **Std** or **Other**, own ship track is displayed based on the primary position sensor
- **Ship Secondary**, if selected as **Std** or **Other**, own ship track is displayed based on the secondary position sensor.
- **ARPA targets**, if selected as **Std** or **Other**, ARPA target past tracks are displayed.

Predictor ship, if selected as **Std** or **Other**, predicted own ship position is displayed with 5 own ship symbols. Predictor time can be selected from 30 seconds to 180 seconds.

Note: The Predictor is visible only, if the own ship true scale symbol is also displayed.

Events marks (These marks are based on Voyage log records, for more information, see chapter "Voyage log".

- **User Events**, if selected as **Std** or **Other**, event symbol is displayed on ECDIS where system has recorded an event based on conditions you have set (Type: User and Auto).
- **Automatic Events**, if selected as **Std** or **Other**, event symbol is displayed on ECDIS where system has recorded an event based on conditions you have set. (Type: Ship and Alarm)
- **Positions**, if selected as **Std** or **Other**, Positions are displayed. (Type: Posdev.)
Note MOB event is always visible.

You can select period of time to be displayed in a list box of **Show**.

Radaroverlay, if selected as **Std** or **Other**, Radar Echo Overlay is displayed.

Note! Radar overlay has its own mode control. Radar echo overlay can be visible only if the selected mode something else than ECDIS ONLY. For more information about radar echo overlay, see chapter "Radar Echo Overlay".

ARPA targets, if selected as **Std** or **Other**, ARPA targets are displayed.

Control of AIS targets

- **AIS targets**, if selected as **Std** or **Other**, Symbol of AIS targets are displayed.
- **AIS targets names**, if selected as **Std** or **Other**, name for AIS targets are displayed.
- **Max count**, setting for maximum count of AIS targets to be displayed on ECDIS.
- **Max. range**, setting for maximum range of AIS targets from own ship to be displayed on ECDIS.

Ship true symbol scale limit, own ship is displayed as true scale symbol, if the displayed chart scale is larger than selected limit scale here and if the size of the true scale symbol is longer than 6 mm on the chart display.

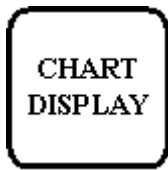

Pilot data, User chart and Chart alarms are non-chart information. All the selected items are shown on top of chart data

“Mariner” sheet

Chart display - ALL-ON		
Chart	Standard	Other
ARCS details	Tracking	Mariner
Route		
Pilot data		
Off	Std	Other
<input type="radio"/>	<input type="radio"/>	<input checked="" type="radio"/>
		Position
<input type="radio"/>	<input type="radio"/>	<input checked="" type="radio"/>
		Range
<input type="radio"/>	<input type="radio"/>	<input checked="" type="radio"/>
		Text
User chart		
Off	Std	Other
<input type="radio"/>	<input checked="" type="radio"/>	<input type="radio"/>
		Points
<input type="radio"/>	<input checked="" type="radio"/>	<input type="radio"/>
		Lines
<input type="radio"/>	<input type="radio"/>	<input checked="" type="radio"/>
		Symbols and Tiduals
<input type="radio"/>	<input type="radio"/>	<input checked="" type="radio"/>
		Areas
		50% Transparent
<input type="radio"/>	<input checked="" type="radio"/>	<input type="radio"/>
		Display only radar part of Lines, Symbols and Areas
Chart Alarm warning area		
Off	Std	Other
<input type="radio"/>	<input checked="" type="radio"/>	<input type="radio"/>
		Highlight
Reference target		
Off	Std	Other
<input type="radio"/>	<input checked="" type="radio"/>	<input type="radio"/>
		Position
Manual Updates		
Off	Std	Other
<input type="radio"/>	<input checked="" type="radio"/>	<input type="radio"/>
		Standard Orange

Pilot data:

- **Position**, if selected as **Std** or **Other**, positions of Pilot Data records are displayed as a symbol on the chart.
- **Range**, if selected as **Std** or **Other**, range circles around Pilot Data records are displayed. Size of circle depends on value set in Pilot Data.
- **Text**, if selected as **Std** or **Other**, text of Pilot Data records are displayed on the chart.

User chart

- **Points**, if selected as **Std** or **Other**, Points are displayed.
- **Lines**, if selected as **Std** or **Other**, Lines are displayed
- **Symbols and Tiduals**, if selected as **Std** or **Other**, Symbols and Tiduals are displayed.
- **Area**, if selected as **Std** or **Other**, Areas are displayed. Colour fill of the areas can be selected as transparent from 25 to 75% and as No colour fill. If No colour fill is selected, only the boundaries of the areas are visible.
- **Display only radar part of Lines, Symbols and Areas**, if selected as **Std** or **Other**, only those Lines, Symbols and Areas are displayed, which has user selection "on radar" activated for them in the User Chart. This selector is used to view only that part of the User Chart, which will be sent to the ARPA radar connected to the system.

Chart Alarm warnings Area, if selected as **Std** or **Other**, Chart Alarm warnings areas are displayed in red highlight colour.

Reference target, if selected as **Std** or **Other**, reference targets are displayed.

Manual Updates, if selected as **Std** or **Other**, Manual Updates made as Orange symbol are displayed. NOTE, Visibility of Manual Updates made as True symbols are controlled through Standard and Other pages of Chart Display.

Store and recall of Chart Display Settings for visible chart and navigational features

You can define Chart Display Settings for chart details, which are displayed over S57 charts cells. You can save these Chart Display Settings into the hard disk and later recall them on demand.



Press twice *CHART DISPLAY* button.

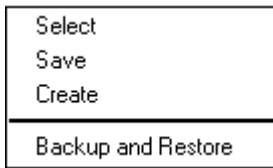

If you press twice *CHART DISPLAY* pushbutton a menu will appear.

Select:

You select from the saved Chart Display Settings one for recall.

Save:

You save Chart Display Settings.

Create:

You create a new Chart Display Settings.

Backup and Restore:

You can make backups of your Chart Display Settings into a floppy disk. Or you can restore backups of your Chart Display Settings from your floppy disk.

How to create a new Chart Display Settings

1. Press *CHART DISPLAY* button twice.
2. Select **Create** from the menu.
3. Enter desired name for Chart Display Settings and press **OK** in dialog box.

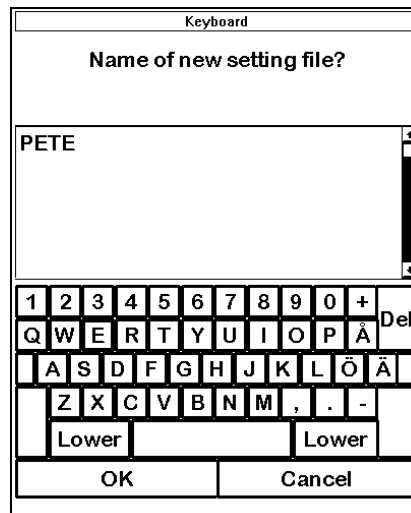

How to select Chart Display Settings

1. Press *CHART DISPLAY* button twice.
2. Choose **Select** from the menu.
3. Select desired Chart Display Settings from list box.

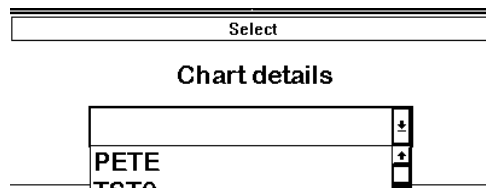

How to save changes to Chart Display Settings

1. Press *CHART DISPLAY* button twice.
2. Choose **Save** from the menu.
3. Current Chart Display Settings are saved automatically.

This page is intentionally left blank

Manual Updates

Introduction





It is defined in SOLAS that mariner shall keep his charts up-to-date for intended voyage. Mariner receives chart corrections and other essential information for the area of his intended voyage for example as

- Notices to Mariners (by post, by email, by fax, etc.)
- Navtex warnings

Mariner shall keep his electronic chart in his ECDIS also up-to-date. Regardless of the chart material used mariner must know which of these chart corrections are applied into his ECDIS charts and which of them mariner needs to add as manual updates.

Manual update could be a deletion of an already existing object, modification of position or other characteristics of an already existing object or insertion of a new object. In this ECDIS manual updates are stored in a common database, which is used both with S57 and ARCS charts. For more information, see "How to check in details the creation and usage history of manual updates" on page 211.

Mariner cannot permanently remove from the chart display any of the official objects. If mariner needs to make obsolete any of the official objects he deletes them. Then in practice the deleted features are still visible, but they have special presentation for a deleted object.

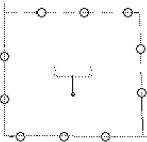
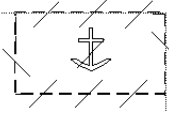
	Insertion	Deletion
Point		
Line		
Area		

However mariner can remove objects which he has inserted himself. He just says that a feature is deleted and it is removed from the display.

Note that the manual updates has no automatic connection to any automatic update received later for S57 or ARCS charts. If a manual update itself became obsolete, because the official chart has been updated to include the update defined as manual update, the mariner must himself deletes the obsolete manual update in question.

This ECDIS does record complete usage of manual updates. All deletions, modifications and insertions are recorded and time stamped. If mariner wish to see what kind of manual updates he had in past for example two weeks ago, he uses update history to specify the relevant date range. For more information to set Display and Approve date, see chapter "Date Dependent and Periodical Features of Vector Chart"

Which symbols to use with Manual Updates

Manual updates can be used at least for following purposes:

- To keep the charts up-to-date using similar symbols as the real chart uses. Later these symbols are called as "**True symbols**".
- To keep the charts up-to-date using easily detectable orange symbols reserved for this purpose. Later these symbols are called as "**Orange symbols**".
- To add additional mariner information using easily detectable orange symbols reserved for this purpose

Orange symbols are recommended because then you, your mates and pilots can easily detect these symbols. Another benefit of orange symbols is that as property less they are very easy to insert. However orange symbols do not offer all possibilities. Experienced users can use true symbols to create their own mariner cartography.

Display of Manual Updates

How to control visibility of Orange symbols from Manual Updates

Visibility of Orange symbols of Manual Updates is controlled on Mariner pages of Chart Display.

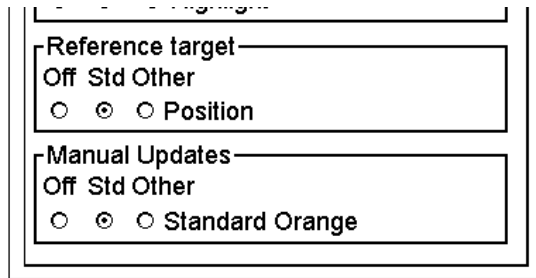

On Mariner page selection of Standard Orange is placed to Manual Update field.

For Chart Alarms calculation following Orange Symbol can be detected and highlighted during Route Planning and Route Monitoring. The associated alarm is "**5100 Safety contour**".

Category type:

- Symbol; **Mariner Danger Highlight**
- Symbol; **Mariner Foul Ground**
- Symbol; **Mariner Isolated Danger**
- Symbol; **Mariner Obstruction**
- Symbol; **Mariner Underwater Rock**
- Symbol; **Mariner Wreck**
- Line; **Mariner Danger Highlight Line**
- Area; **Mariner Danger Highlight Area**

How to control visibility of True symbols from Manual Updates

Chart features added by Manual Updates behave exactly as any other chart feature. Their visibility follows common rules. For more information, see chapter "Control of visible chart features".

Control of date dependency of Manual updates

How to set current date for viewing

Manual updates operate like any other S57 Chart which contains updates and other date dependent features.

When you Accept manual updates as permanent the system sets **Display until** of Manual Updates as current date of the System. To set **Approve until** as current date of the System you must open Date Dependent and perform Approve Until. For more information to set current date, see chapter "Date Dependent and Periodical Features of Vector Charts". Recommended settings in Date Dependent are:

- Sync Manual Update Dates as ON position
- All SENCs ON position

See example below where Updates Displayed and Approved until are set as the System current date.

Date Dependent									
Cell Status									
Cell ID	RENC edt/ upd	SENC edt/ upd	Updates Displayed until			Updates Approved until			
7C1W0001	-/-	1/ 0	2000	2 28	(0)	2000	2 18	(0)	
7C1W0002	-/-	1/ 0	2000	2 28	(0)	2000	2 18	(0)	
7C1W0003	-/-	1/ 0	2000	2 28	(0)	2000	2 18	(0)	
7C1W0004	-/-	1/ 0	2000	2 28	(0)	2000	2 18	(0)	
7C2W0101	-/-	1/ 0	2000	2 28	(0)	2000	2 18	(0)	
7C2W0102	-/-	1/ 0	2000	2 28	(0)	2000	2 18	(0)	
7C2W0103	-/-	1/ 0	2000	2 28	(0)	2000	2 18	(0)	
7C2W0104	-/-	1/ 0	2000	2 28	(0)	2000	2 18	(0)	
7C2W0200	-/-	1/ 0	2000	2 28	(0)	2000	2 18	(0)	
7C2W0300	-/-	1/ 0	2000	2 28	(0)	2000	2 18	(0)	
7C2W0400	-/-	1/ 0	2000	2 28	(0)	2000	2 18	(0)	
7C2W0500	-/-	1/ 0	2000	2 28	(0)	2000	2 18	(0)	
7C2W0600	-/-	1/ 0	2000	2 28	(0)	2000	2 18	(0)	
7C2W0700	-/-	1/ 0	2000	2 28	(0)	2000	2 18	(0)	
7C2W0800	-/-	1/ 0	2000	2 28	(0)	2000	2 18	(0)	
7C2W0901	-/-	1/ 0	2000	2 28	(0)	2000	2 18	(0)	
7C2W0902	-/-	1/ 0	2000	2 28	(0)	2000	2 18	(0)	
7C2W1001	-/-	1/ 0	2000	2 28	(0)	2000	2 18	(0)	
7C2W1002	-/-	1/ 0	2000	2 28	(0)	2000	2 18	(0)	
Latest RENC	Oldest date		2000	2 28		1999	4 19		
Product List	Newest date		2000	2 28		2000	2 18		
2000 1 9	Manual Updates		2000	2 28		2000	2 18		
<input checked="" type="checkbox"/> Sync Manual Update Dates <input type="text" value="Display until"/> <input type="text" value="Approve until"/>									
<input type="text" value="Manual Update Dates"/> <input checked="" type="checkbox"/> All SENCs									

Use of Manual Update editor with Orange symbols

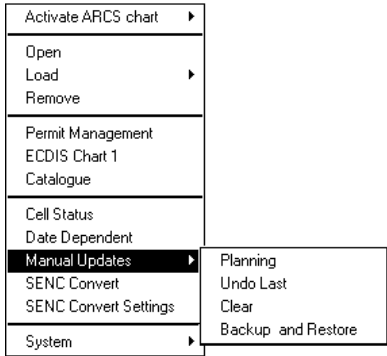

Manual update editor has following alternatives:

- **Planning** to operate with new manual updates.
- **Undo Last** to remove last accepted manual update planning session. By repeating Undo Last you can remove any amount of old manual update planning session.
- **Clear** to remove all manual update in a single operation
- **Backup and Restore** to make a backup or to recall already recorded backup
- with ARCS chart you have here also **Date Dependent** to set viewing date of manual updates. Note that with S57 charts Date Dependent is in main menu of Chart Plan.

Manual Update Planning

Manual update editor operates in sessions. You create a session when you activate Manual Update Planning dialog. You can freely delete, modify, copy or create chart objects until you feel finished with your session. Then you terminate your session by pressing **Accept Manual Updates as Permanent** and the ECDIS stores permanently your manual updates. If you need to leave your manual update session and discard all modification made during the current session press **Cancel**.

Note! You are able to use Manual Update editor when **North Up** or **Course Up** orientation is selected to be used.

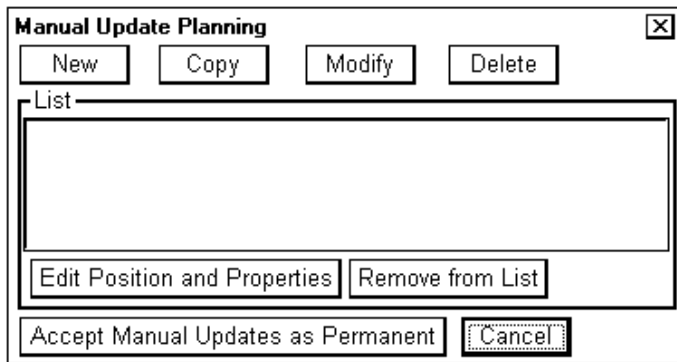

New, Copy, Modify, Delete: These buttons are used to collect chart objects into a list shown in a Manual Update Planning dialog for further editing during current session of Manual Update Planning. **New** creates an object from scratch. **Copy** creates an object using an existing objects as an example. **Modify** changes an existing object. **Delete** removes an existing object.

Remove from List: If you made a manual update by mistake, you can remove it if you haven't accepted it yet as permanent.. You can remove it by selecting (highlighting) chart object in the List and press button **Remove from List**.

Edit Position and Properties: You can edit position and/or properties of selected (highlighted) chart object by using button **Edit Position and Properties**.

How to insert a new Orange symbols

Mariner can insert a new object either using **New** or **Copy**. With **New** he creates a new feature from scratch. With **Copy** he uses an already existing object as an example for the new inserted feature.

Insert a new Orange symbols using New

When you want to create a new object from a scratch, you start creating by pressing **New** in Manual Update Dialog. A S57 Object window appears. Use the default Category Standard orange to insert a new Orange symbol.

1. Press **New** in Manual Update Planning dialog.

2. In the New Object dialog, select **Standard Orange** as the Category.

3. Select the **Mariner Danger Highlight** symbol.

4. Press **Accept New Object**.

5. The Manual Update Planning dialog shows the new object: **CREATE: Mariner Danger Highlight**.

6. In the Object: Mariner Danger Highlight dialog, press **Edit Position**.

7. Set the positions with cursor and press **SELECT**. Press then **Accept**.

8. In the Object: Mariner Danger Highlight dialog, press **Edit Properties list and values**.

9. In the Properties List and Values dialog, set the **Information** property to **Dangerous wreck. Avoid the place, passing distance 0.5 NM.**

10. Press **Accept List and Values**.

11. The Manual Update Planning dialog is updated with the new object.

1. Press **New** button in a Manual Update Planning.
2. Select desired Drawing type (Point, Line or Area) and Category as **Standard Orange**.
3. Select desired **Symbol** from a list box.
4. Press **Accept New Object** button.
5. Press **Edit Position and Properties** button.
6. Press **Edit Position** button. Now you have two alternatives: If you want to add a text to support your memory, then continue from step 7. Otherwise got to step 11.
7. Use cursor and **SELECT** button to define position of symbol and press **Accept** button.
8. If you like to include to textual information related to Orange symbol, press **Edit Properties list and values**.
9. Move "**Information**" text left hand side list box of **Properties list** and highlight it, then you can add textual information in **Property or Value** field. You can enter your text, when you move cursor in **Numeric or Textual** box and press **SELECT**. A "Type writer" appears, enter your text and press **OK**. Then press **Accept list and values** button.
10. Press **Accept** button.
11. Press **Accept manual Updates as Permanent** button.

Insert a new Orange symbols using Copy

You can make new Orange symbols by copying existing Orange symbols. Then you pick up an Orange symbols and make a copy of it. After copying you can modify position suitable for your purposes.

1. Move cursor over desired object and press **SELECT**

2. Move cursor over desired object and press **SELECT**

3. Select object in Object by Cell window. There could be more than one objects in the area.

4. Press **Accept** button in a Manual Update Planning

5. Press **Edit Position and Properties** button.

6. Press **Edit Position** button. Now you have two alternatives: If you want to add a text to support your memory, then continue from step 7. Otherwise got to step 11.

7. Set position with with cursor and press **SELECT**

8. Press **Accept manual Updates as Permanent** button.

1. Press **Copy** button in a Manual Update Planning
2. Move cursor over desired object and press **SELECT** push button in Control Panel.
3. Select object in Object by Cell window. There could be more than one objects in the area.

4. Press **Accept**
5. New Orange symbols is displayed in a List of Manual Update Planning window. Then press **Edit Position and Properties**.
6. Press **Edit Position**
7. Move cursor over desired location on ECDIS screen. And press **SELECT** pushbutton.
8. Press directly **Accept Manual Updates as Permanent**.

How to delete existing Orange symbol

Mariner cannot permanently remove from the chart display any of the official chart objects. If mariner needs to remove any of the official chart objects he is allowed to mark them as deleted. In practice the deleted chart object is still visible, but it has on top of it a special presentation for a deleted object. To delete chart object, proceed as follows:

1. Press **Delete** button in a Manual Update Planning dialog.

2. Move cursor over desired object and press **SELECT**

3. Select the object in Objects by Cell window. You can also view data of each object before making your selection.

4. Press **Accept**

5. Use **Accept Manual Updates as Permanent** to complete the deletion.

Note: If you deleted an official ENC chart object, a deletion mark is added over the original chart object which is still visible. If you delete Manual Update chart object, then it is removed from the chart display based on date of deletion. See more in chapter Control of date dependency of Manual updates

How to edit position of an Orange symbols

An object can be type of point, line or area.

- Point has only one point in its presentation.
- Line can consist of one or more chains. A chain consist of two or more points.
- Area consist of a line which is closed..

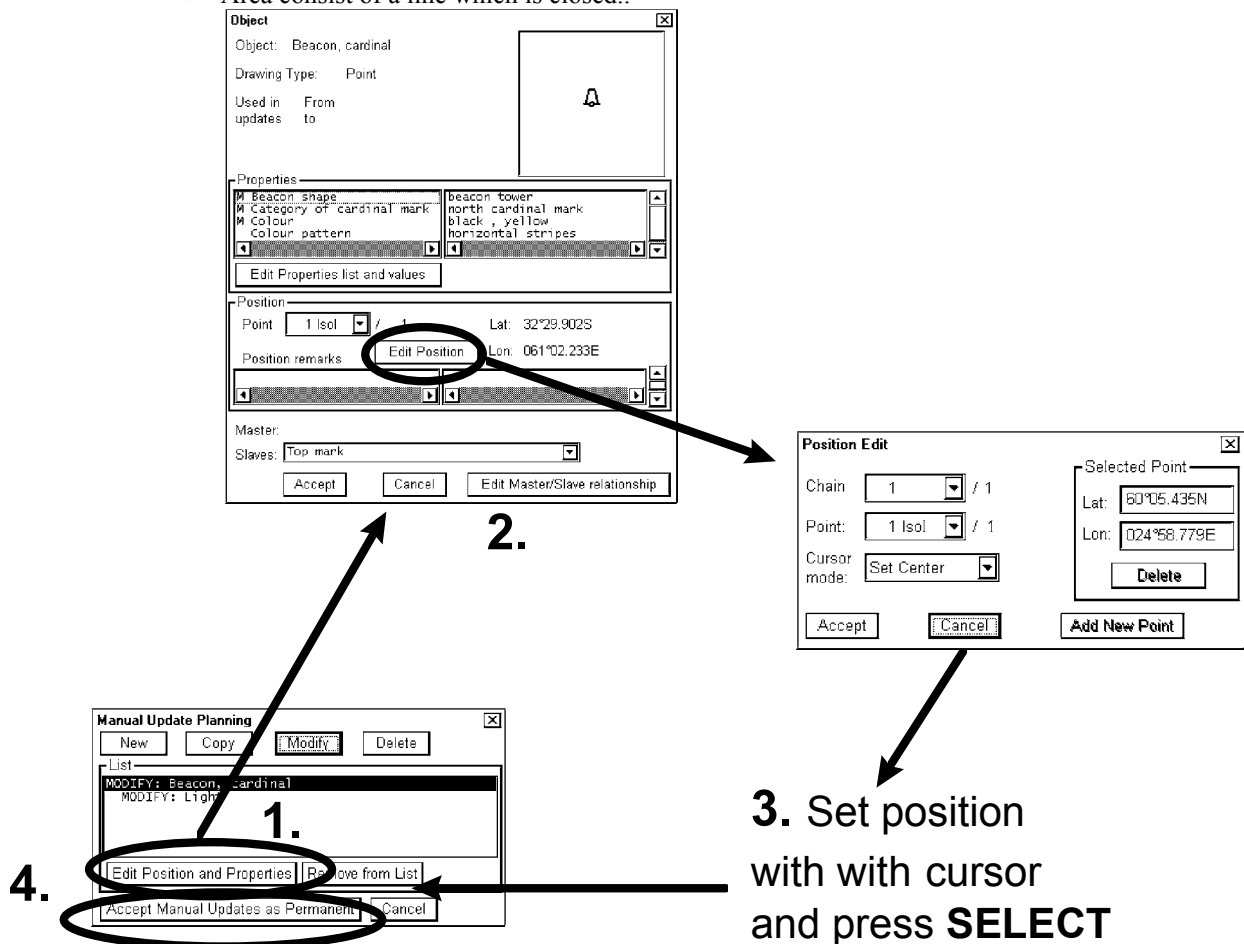

1. In Manual Update Planning window press **Edit Position and Properties** button.
2. An **Object** window appears. Press **Edit Position** button
3. An **Position edit** window. appears
4. When **Edit Position** window is open, you can edit the position of the selected chart feature, see flow charts below (How to modify an existing position of a Chart Feature, How to define position of a new Chart Feature and how to define a new center point for an existing Chart Feature).
5. Press directly **Accept Manual Updates as Permanent**

An example below how to modify an existing position of a Chart Feature.

1) Activate Position Edit

2) Move cursor over a point

Position Edit

Chain: 1 / 1
 Point: 5 / 5
 Cursor mode: Insert Point

Selected Point
 Lat: 60°05.770N
 Lon: 024°59.737E

Accept Cancel Add New Point Delete

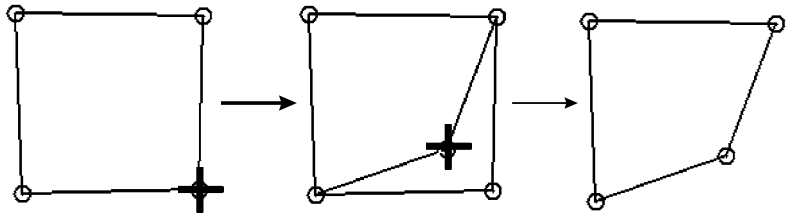

3) Use CHART ALIGN pushbutton pressed down to modify position of a point

An example below how to define position of a new Chart Feature. The method is also applicable to insert or append new points for existing Chart Features.

1) Activate Position Edit

Position Edit

Chain: / 0
 Point: / 0
 Cursor mode: Insert Point

Selected Point
 Lat:
 Lon:
 Delete

Accept Cancel Add New Point

2) Insert a point with SELECT pushbutton

Position Edit

Chain: 1 / 1
 Point: 1 Isol / 1
 Cursor mode: Insert Point

Selected Point
 Lat: 60°05.303N
 Lon: 024°58.523E

Accept Cancel Add New Point Delete

3) If required, you can change co-ordinates

Number board

Latitude

32°32.972S			
1	2	3	S
4	5	6	N
7	8	9	.

Number board

Longitude

060°54.791E			
1	2	3	E
4	5	6	W
7	8	9	.
0	Del		
OK	Cancel		

An example below how to define a new center point for an existing Chart Feature.

1) Activate Position Edit

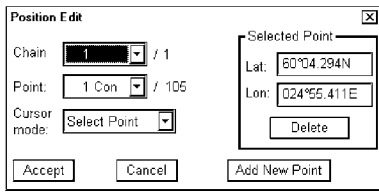

Position Edit

Chain: 1 / 1

Point: 1 Con / 105

Cursor mode: Select Point

Selected Point: Lat: 60°04.294N, Lon: 024°55.411E

Buttons: Accept, Cancel, Add New Point, Delete

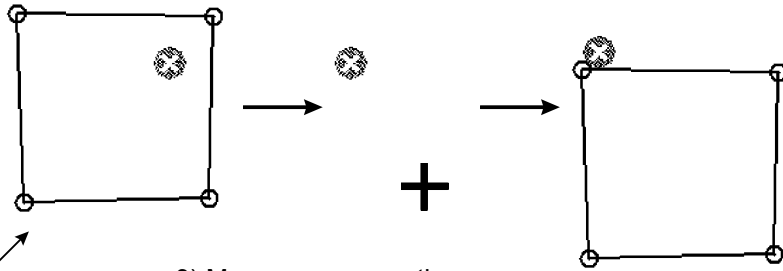

2) Select "Set Center"

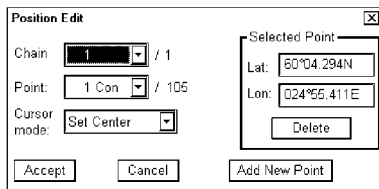

Position Edit

Chain: 1 / 1

Point: 1 Con / 105

Cursor mode: Set Center

Selected Point: Lat: 60°04.294N, Lon: 024°55.411E

Buttons: Accept, Cancel, Add New Point, Delete

3) Move cursor over the new required center point and press SELECT pushbutton

Use of Manual Update editor with True symbols

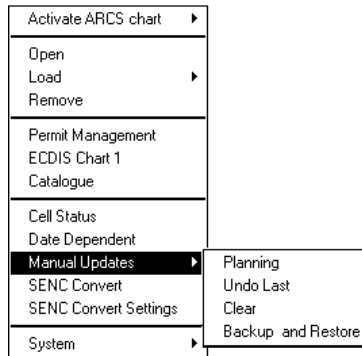

Manual update editor has following alternatives:

- **Planning** to operate with new manual updates.
- **Undo Last** to remove last accepted manual update planning session. By repeating Undo Last you can remove any amount of old manual update planning session.
- **Clear** to remove all manual update in a single operation
- **Backup and Restore** to make a backup or to recall already recorded backup
- with ARCS chart you have here also **Date Dependent** to set viewing date of manual updates. Note that with S57 charts Date Dependent is in main menu of Chart Plan.

Manual Update Planning

Manual update editor operates in sessions. You create a session when you activate Manual Update Planning dialog. You can freely delete, modify, copy or create chart objects until you feel finished with your session. Then you terminate your session by pressing **Accept Manual Updates as Permanent** and the ECDIS stores permanently your manual updates. If you need to leave your manual update session and discard all modification made during the current session press **Cancel**.

Note! You are able to use Manual Update editor when **North Up** or **Course Up** orientation is selected to be used.

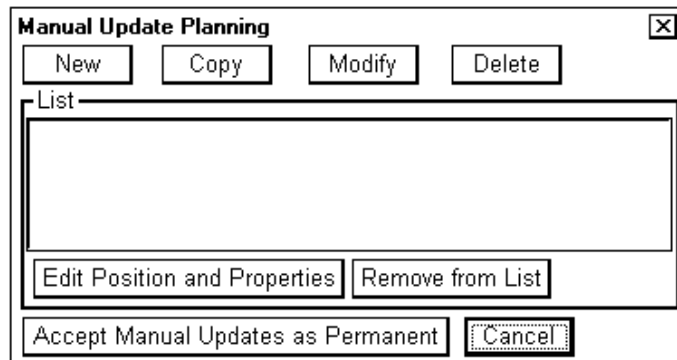

New, Copy, Modify, Delete: These buttons are used to collect chart objects into a list shown in a Manual Update Planning dialog for further editing during current session of Manual Update Planning. **New** creates an object from scratch. **Copy** creates an object using an existing objects as an example. **Modify** changes an existing object. **Delete** removes an existing object.

Remove from List: If you made a manual update by mistake, you can remove it if you haven't accepted it yet as permanent.. You can remove it by selecting (highlighting) chart object in the List and press button **Remove from List**.

Edit Position and Properties: You can edit position and/or properties of selected (highlighted) chart object by using button **Edit Position and Properties**.

How to delete existing chart object

Mariner cannot permanently remove from the chart display any of the official chart objects. If mariner needs to remove any of the official chart objects he is allowed to mark them as deleted. In practice the deleted chart object is still visible, but it has on top of it a special presentation for a deleted object. To delete chart object, proceed as follows:

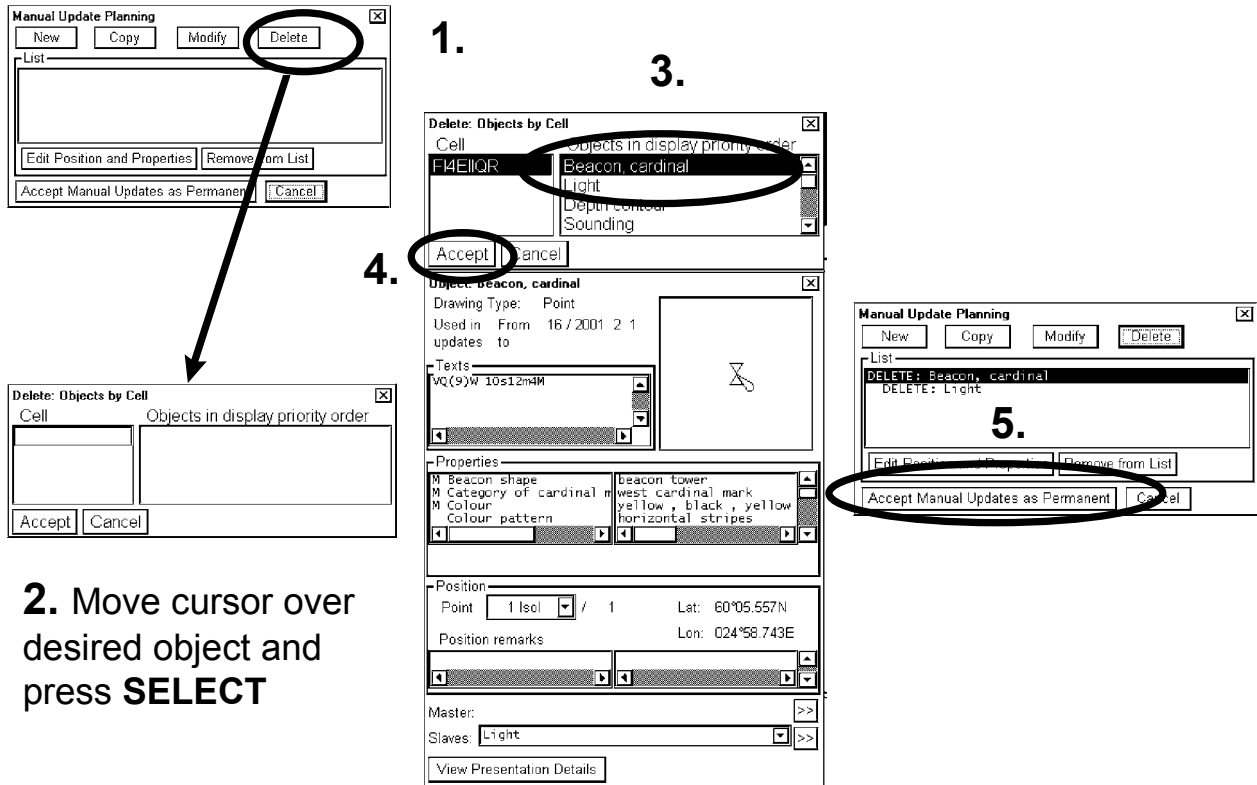

2. Move cursor over desired object and press SELECT

1. Press **Delete** button in a Manual Update Planning dialog.
2. Move cursor over desired chart object and press SELECT push button in Control Panel.
3. Select the object in Objects by Cell window. You can also view data of each object before making your selection.
4. Press **Accept**
5. Use **Accept Manual Updates as Permanent** to complete the deletion.

Note: If you deleted an official ENC chart object, a deletion mark is added over the original chart object which is still visible. If you delete Manual Update chart object, then it is removed from the chart display based on date of deletion. See more in chapter Control of date dependency of Manual updates

How to modify existing chart object

Mariner cannot permanently remove from the chart display any of the official chart objects, but he can modify position and/or properties of chart objects. When mariner modifies chart object the ECDIS will mark original chart object as deleted and a copy of original chart object as inserted.

1. Press **Modify** button in a Manual Update Planning.
2. Move cursor over desired object and press SELECT push button.
3. Select the object in Objects by Cell window. You can also view data of each object before making your selection.
4. Press **Accept**
5. Press **Edit Position and Properties**
6. If you want to modify the position of the object press **Edit Position**. Otherwise continue from point 10.
7. Move cursor over desired location on ECDIS screen. And press SELECT pushbutton.
8. Now you can use fast lane and press directly **Accept Manual Updates as Permanent**. If you want to modify also properties continue from point 9.
9. If you want to modify also properties press **Accept**.
10. If you want to modify the properties of the object press **Edit Properties list and values**. Otherwise continue from point 8.
11. Pick from the list properties you want to modify and give them new values. You can also add new properties or remove old.
12. Press **Accept List and values** to continue from point 6 or 10 again. Otherwise continue from point 8.

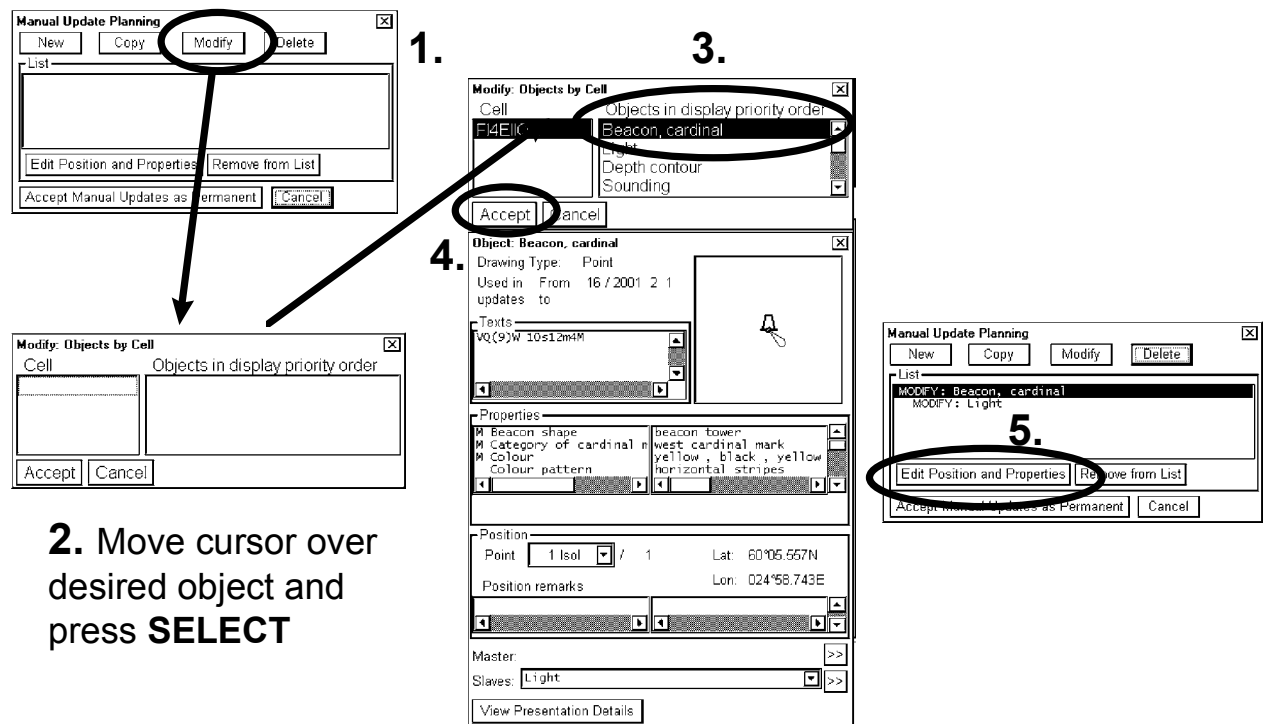

2. Move cursor over desired object and press SELECT

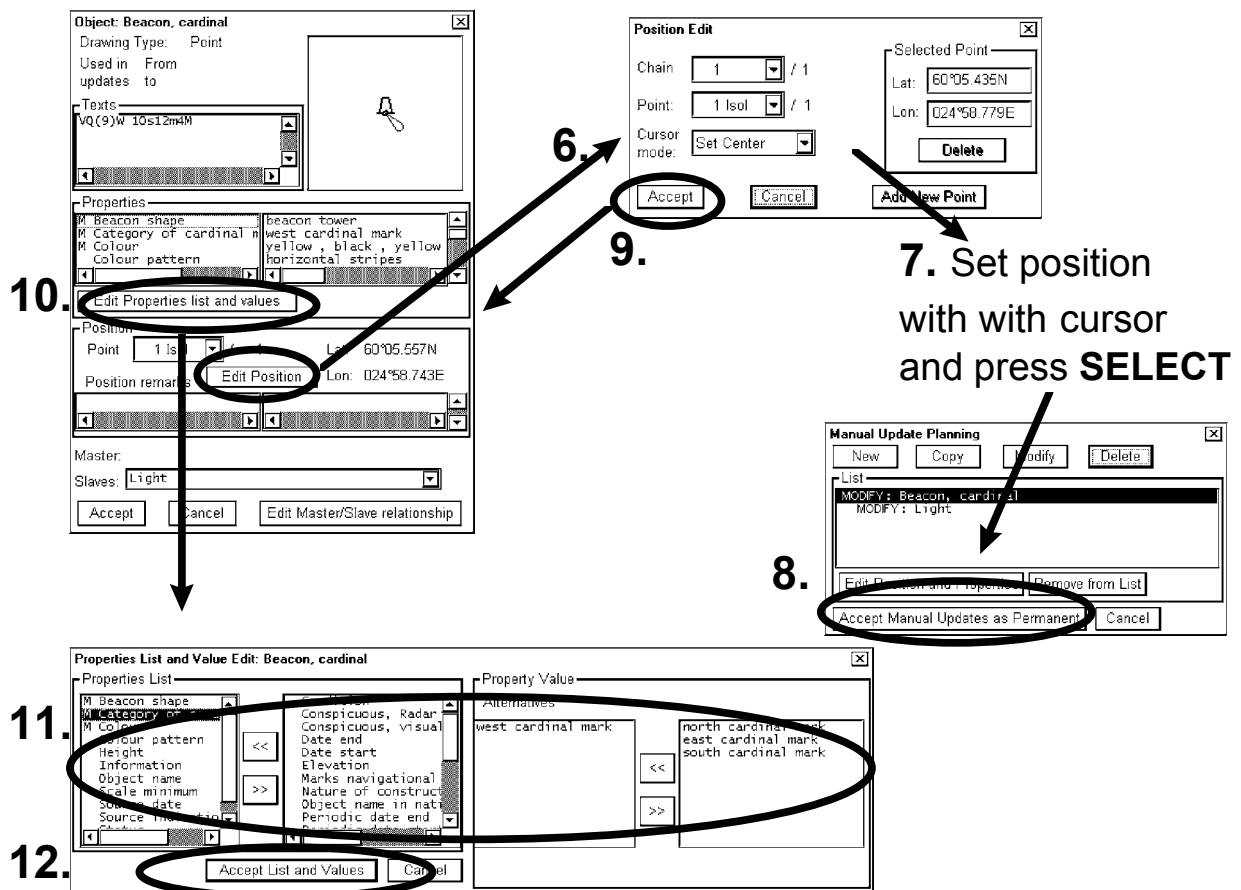

How to insert a new chart object

Mariner can insert a new object either using **New** or **Copy**. With **New** he creates a new feature from scratch. With **Copy** he uses an already existing object as an example for the new inserted feature.

Insert a new chart object using New

When you want to create a new object from a scratch, you start creating by pressing **New** in Manual Update Dialog. A S57 Object window appears. In this window you can select Geometric type of object (Point, Line or Area) and type of object:

- **Standard orange.** This category is reserved for easy and simple Orange symbols. See separate chapter about the use of Orange symbols.
- **Single.** All self understandable chart objects which can be created based on a single selected chart object. Examples are different kind of restricted and warning areas, light vessels, anchorage symbols etc.
- **Nav Aid.** Nav Aid is guided method to create navigational aids such as lights and buoys, because they consist of several objects put together with master and slave relationships
- **Easy Lateral Sea Mark.** Guided method to create Nav Aid easily for any lateral sea marks.
- **Easy Cardinal Sea Mark.** Guided method to create Nav Aid easily for any Cardinal sea marks.
- **Easy Other Sea Mark.** Guided method to create Nav Aid easily for any Other sea marks.
- **Easy Light.** Guided method to create Nav Aid easily for any simple lights.
- **Easy Obstruction.** Guided method to create Obstructions.

An example of Restricted area

1. Press **New** button in Manual Update Planning window.
2. Select desired Drawing Type as **Area**
3. Select by cursor desired icon in list of available chart objects.
4. Press **Accept New Object**.
5. New object is displayed in a List of Manual Update Planning window. Then press Edit Position and Properties.
6. Press Edit Position
7. Move cursor over desired locations on ECDIS screen. And press **SELECT** pushbutton. Repeat this until you have defined all corner points.
8. Press directly **Accept Manual Updates as Permanent**

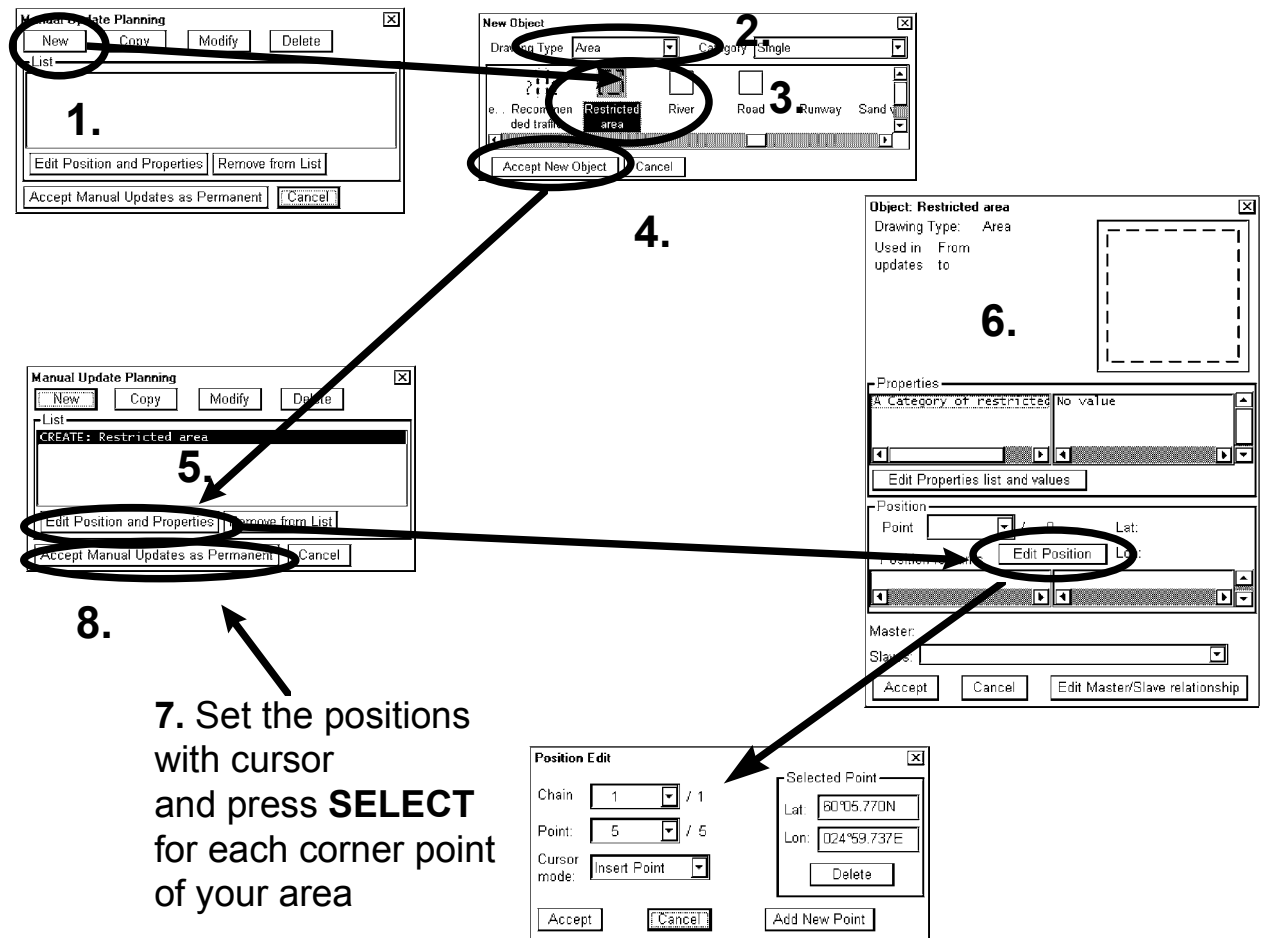

7. Set the positions with cursor and press **SELECT** for each corner point of your area

An example of Easy Lateral sea Mark

The method is similar also for Easy Cardinal sea marks, Easy Other sea marks, Easy Lights and Easy Obstructions.

1. Press **New** button in Manual Update Planning window.
2. Select **Easy Lateral Sea Mark** in **Category** in list box of New Object window.
3. Then make selections.
4. Press **Accept New Object**.
5. New object is displayed in a List of Manual Update Planning window. Then press **Edit Position and Properties**.
6. Press **Edit Position**
7. Move cursor over desired location on ECDIS screen. And press **SELECT** pushbutton.
8. Press directly **Accept Manual Updates as Permanent**

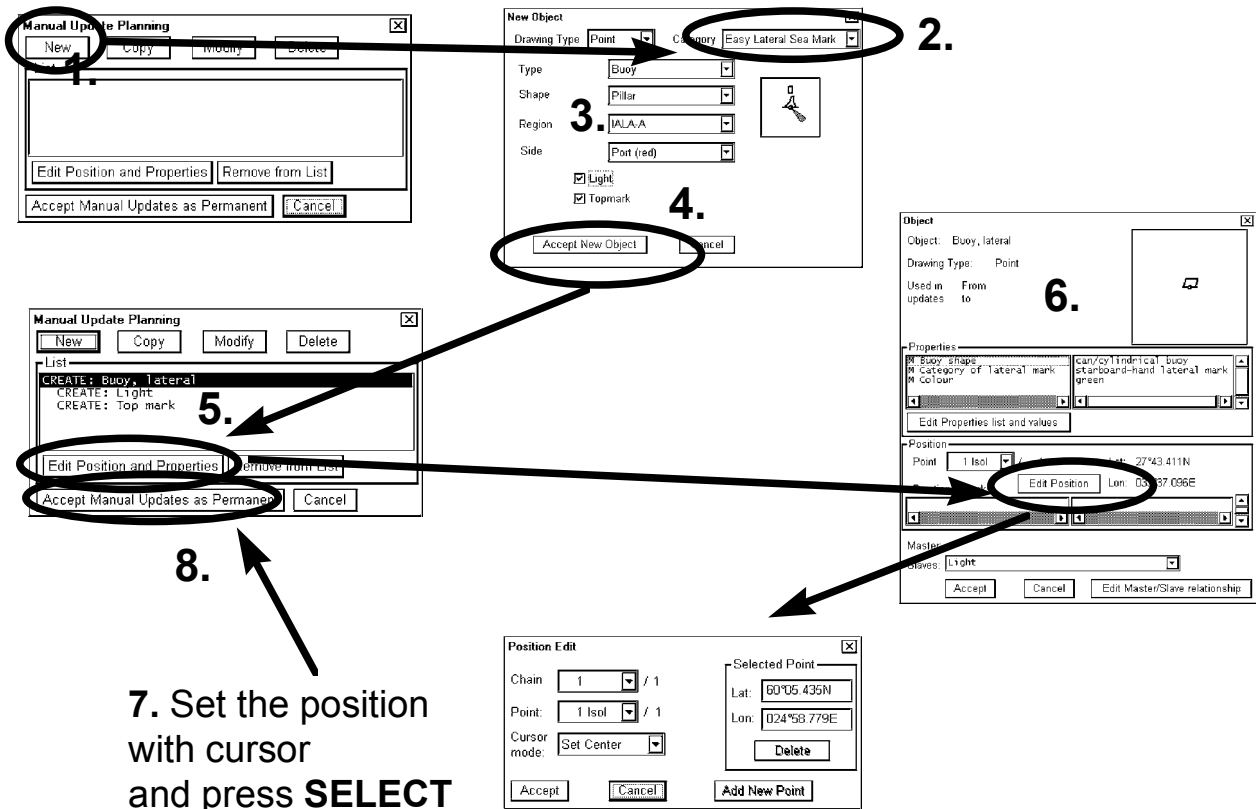

An example of Nav Aid

A light is only a light - it requires also a support which could be a pile or buoy etc. Body and top mark of a buoy are separated to enable a vast number of possible combinations.

1. Press **New** button in Manual Update Planning window.
2. Select **Point** as Drawing Type; Select **Nav Aid** as Category. Then select by cursor desired icon of the master object.
3. Press **Set as Master**.
4. When you have set Master object , you can define Nav Aid slaves for it. Select by cursor desired icon of a slave object.
5. Press **Set as Nav Aid Slave**. If you need more than one slave object continue from step 4. Otherwise continue from step 6.
6. When you are ready with Master and it's slave objects, press **Accept New Object** button.
7. New object with slaves (two lights) are displayed in a List of Manual Update Planning window. Then you set the position of your master and slave object. Press **Edit Position and Properties**
8. Press **Edit Position**
9. Move cursor over desired location on ECDIS screen. And press SELECT pushbutton.
10. Now you can use fast lane and press directly **Accept Manual Updates as Permanent** (10b. in the example) or you can use slower path by pressing **Accept**, which gives other possibilities not handled in details here (10a.)in the example)
11. If you used slower path then press **Accept**.
12. If you used slower path then press **Accept Manual Updates as Permanent**.

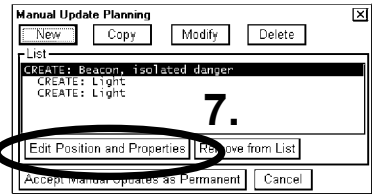
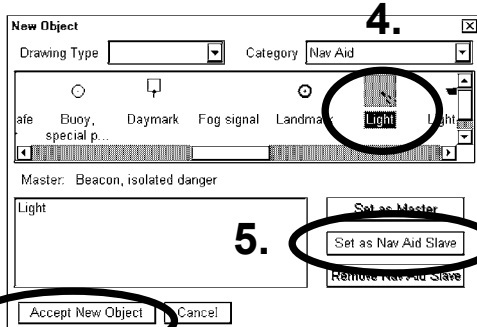
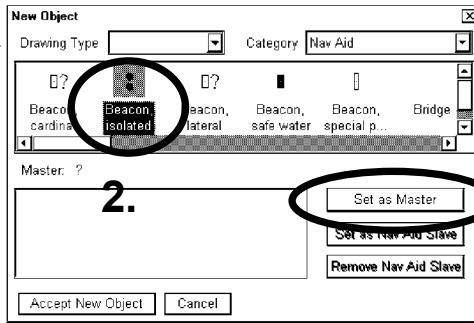
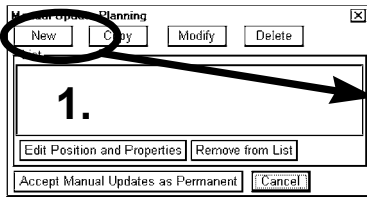

6.

9. Set the position with cursor and press **SELECT**

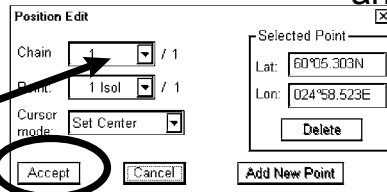
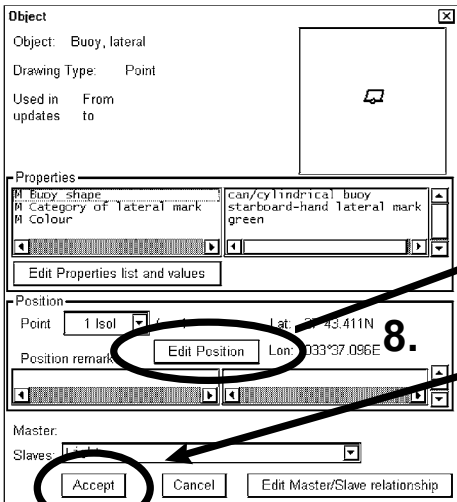

10b. Alternative way is to press **Accept Manual Updates as Permanent** after the position is set

11a.

12a.

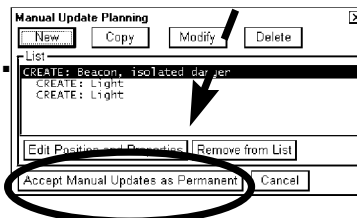

Insert a new chart object using Copy

You can make new object by copying existing one. Then you pick up a object and make a copy of it with all related properties. After copying you can modify position and properties of copied object suitable for your purposes.

1. Press **Copy** button in a Manual Update Planning

2. Move cursor over desired object and press **SELECT**

3. Select object in Object by Cell window. There could be more than one objects in the area.

4. Press **Accept**

5. New object is displayed in a List of Manual Update Planning window. Then press **Edit Position and Properties**.

6. Press **Edit Position**

7. Move cursor over desired location on ECDIS screen. And press **SELECT** pushbutton.

8. Press directly **Accept Manual Updates as Permanent**.

1. Press **Copy** button in a Manual Update Planning
2. Move cursor over desired object and press **SELECT** push button in Control Panel.
3. Select object in Object by Cell window. There could be more than one objects in the area.
4. Press **Accept**
5. New object is displayed in a List of Manual Update Planning window. Then press **Edit Position and Properties**.
6. Press **Edit Position**
7. Move cursor over desired location on ECDIS screen. And press **SELECT** pushbutton.
8. Press directly **Accept Manual Updates as Permanent**.

How to edit properties of a manual update chart object

How to edit Properties of an chart object

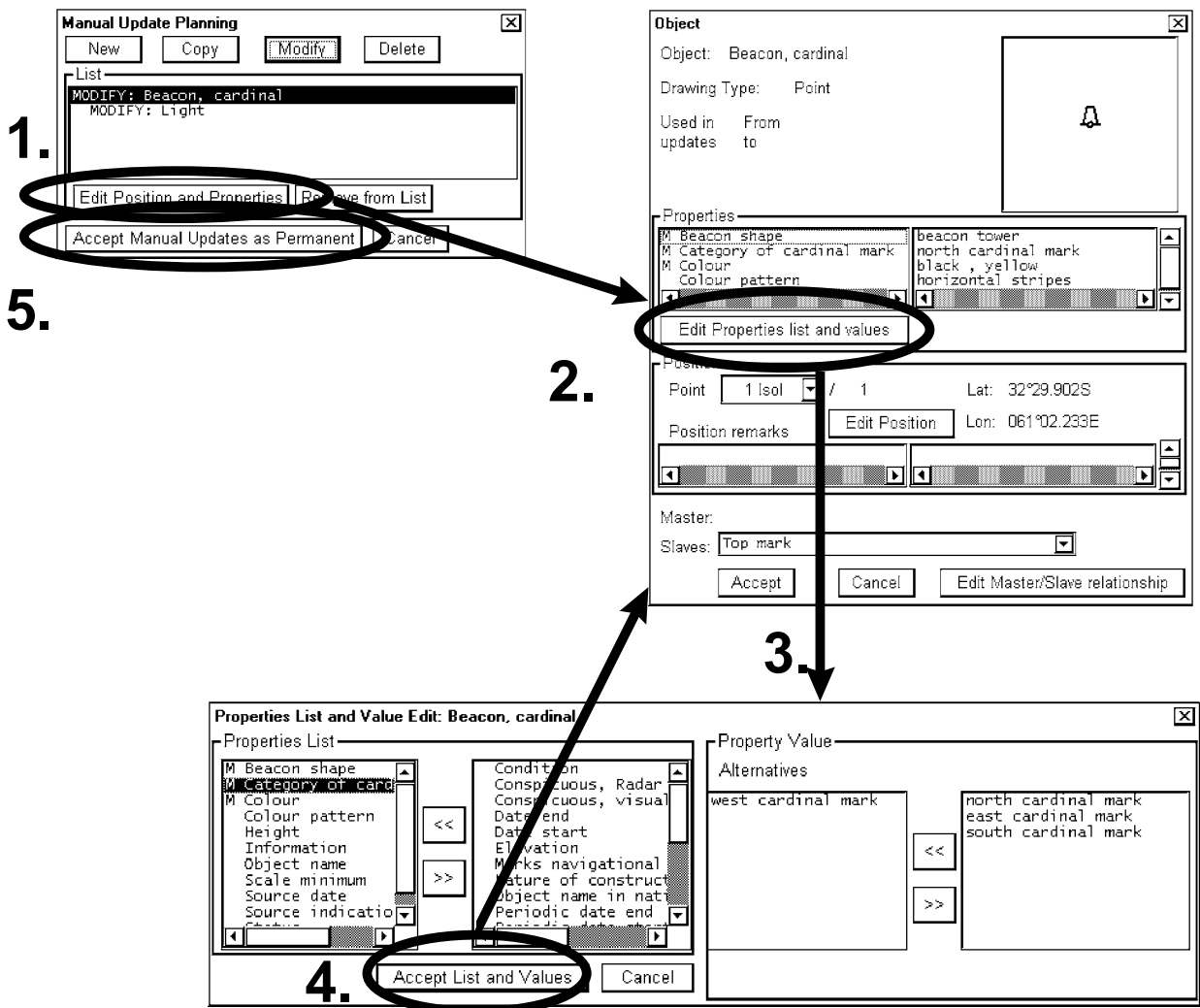

1. In Manual Update Planning window press **Edit Position and Properties** button.
2. An **Object** window appears. Press **Edit Properties List and Values** button.
3. An **Properties List and Values edit** window appears. Add or remove features in Properties List using >> and << buttons. To edit property value highlight desired value in **Properties List**, then you can edit in Property Value field using Alternatives field or enter Numeric or Textual value. If the Object has linked object you can also edit those values. Press **Edit Master/Slaves relationship** button to edit them. Make desired modifications in **Properties List and Values edit** window. After you have edit all the values of the linked objects press **Accept** button.
4. After you have edit all the values of the object you press **Accept List and Values**, if you want continue from point 2 with the object. Otherwise continue from point 5.
5. Press directly **Accept Manual Updates as Permanent**

How to edit position of a chart object

An object can be type of point, line or area.

- Point has only one point in its presentation.
- Line can consist of one or more chains. A chain consist of two or more points.
- Area consist of a line which is closed..

The diagram illustrates the process of editing a chart object's position through three main windows:

- Manual Update Planning:** The 'Edit Position and Properties' button is circled and labeled '1.'. An arrow points from this button to the 'Object' window.
- Object:** The 'Edit Position' button is circled and labeled '2.'. An arrow points from this button to the 'Position Edit' window.
- Position Edit:** This window allows for setting the 'Chain' and 'Point' (both '1 Isol / 1'), and the 'Cursor mode' is set to 'Set Center'. The 'Selected Point' section shows coordinates: Lat: 60°05.435N and Lon: 024°58.779E. An arrow points from this window back to the 'Manual Update Planning' window.
- Manual Update Planning:** The 'Accept Manual Updates as Permanent' button is circled and labeled '4.'. An arrow points from this button back to the 'Manual Update Planning' window.

1. In Manual Update Planning window press **Edit Position and Properties** button.
2. An **Object** window appears. Press **Edit Position** button
3. An **Position edit** window. appears
4. When **Edit Position** window is open, you can edit the position of the selected chart feature, see flow charts below (How to modify an existing position of a Chart Feature, How to define position of a new Chart Feature and how to define a new center point for an existing Chart Feature).
5. Press directly **Accept Manual Updates as Permanent**

An example below how to modify an existing position of a Chart Feature.

1) Activate Position Edit

2) Move cursor over a point

Position Edit

Chain: 1 / 1

Point: 5 / 5

Cursor mode: Insert Point

Accept Cancel Add New Point

Selected Point

Lat: 60°05.770N

Lon: 024°59.737E

Delete

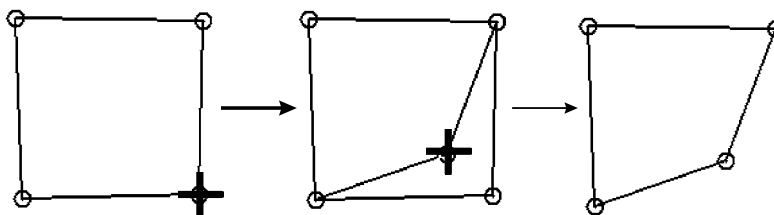

3) Use CHART ALIGN pushbutton pressed down to modify position of a point

An example below how to define position of a new Chart Feature. The method is also applicable to insert or append new points for existing Chart Features.

1) Activate Position Edit

Position Edit

Chain: / 0

Point: / 0

Cursor mode: Insert Point

Accept Cancel Add New Point

Selected Point

Lat:

Lon:

Delete

2) Insert a point with SELECT pushbutton



Position Edit

Chain: 1 / 1

Point: 1 Isol / 1

Cursor mode: Insert Point

Accept Cancel Add New Point

Selected Point

Lat: 60°05.303N

Lon: 024°58.523E

Delete

3) If required, you can change co-ordinates

Number board

Latitude

32°32.972S

1	2	3	S
4	5	6	N
7	8	9	.

Number board

Longitude

060°54.791E

1	2	3	E
4	5	6	W
7	8	9	.
0	Del		
OK	Cancel		

An example below how to define a new center point for an existing Chart Feature.

1) Activate Position Edit

Position Edit

Chain: 1 / 1

Point: 1 Con / 105

Cursor mode: Select Point

Selected Point: Lat: 60°04.294N, Lon: 024°55.411E

Buttons: Accept, Cancel, Add New Point, Delete

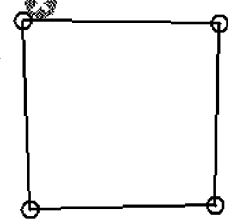
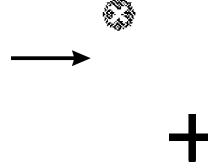
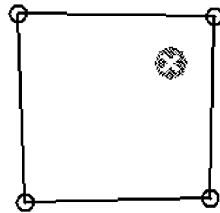

2) Select "Set Center"

Position Edit

Chain: 1 / 1

Point: 1 Con / 105

Cursor mode: Set Center

Selected Point: Lat: 60°04.294N, Lon: 024°55.411E

Buttons: Accept, Cancel, Add New Point, Delete

3) Move cursor over the new required center point and press SELECT pushbutton

Seldom used features of Manual updates

How to check in details the creation and usage history of manual updates

You may need to check when an manual update has been added into your ECDIS. Also you may need to check what was shown in your chart display 3 weeks ago. There are also many other rare cases when you need to know what was known by your ECDIS.

To check any situation in the past you can use either Display Until and Approve Until to specify exact date of interest. Alternatively you can specify directly the number of Manual Update Planning Session. See below.

Manual Update Date Control

Update	Upd
0 1999 5 20	
1 1999 5 20	
2 1999 5 21	

Display Until: 1999 5 21

Approve Until: 1999 5 20

Upd: 2

Upd: 0

This page is intentionally left blank

Chart Alarms

General

The ECDIS is defined to increase safety with capability of detecting areas where depth is less than Safety contour or where specified conditions exist. If you plan a route or if prediction of own ship movement goes across safety contour or an area where selected specified condition exist, the system will give an indication or alarm for danger area. In this operation the ECDIS utilises chart database (S57 charts) stored on hard disk in SENC format. Note that ECDIS calculates dangerous areas using the largest scale chart available which may not be the visualised chart.

You can select objects which are included for calculation of danger area (For example restricted areas). There is a list of various areas which can cause indication of danger.

You can also define your own safe area by creating a User Chart Area. The system can utilise these areas when calculating chart alarms. This is very useful with raster chart material such as ARCS.

The ECDIS can check for you

- predicted movement area of the own ship
- planned route with an easy to use locator function to find dangerous areas

The ECDIS will highlight for you on the chart area

- dangerous areas inside predicted movement area of the own ship
- dangerous areas inside your monitored route
- dangerous areas inside your planned route

Chart alarms

Official S57 chart material consists depth contours which can be used calculation of chart alarms. A chart database also includes different types of objects which user can include in chart alarms. Proceed following steps:

1. Select suitable **safety contour** for your own ship. See chapter "How to select safety contour" on page 214.
2. Check that "Chart Alarms" is set to be displayed. See chapter "How to highlight Chart Alarm" on page 217.
3. If you want include Chart alarms some other objects or areas, select them for indication or alarm. See chapter "How to select objects used in Chart Alarm" on page 215.
4. In route planning mode define a new route or select existing one. Make an Chart Alarm calculation of route if there are indications of danger areas. For more information, see chapter "Route planning" on page 221. Modify your route if necessary and make the Chart Alarm calculation again.
5. Select route as monitored route.
6. Set watch sector for your own ship. See chapter "How to activate own ship check" on page 219.

The system is ready for Chart Alarm calculation of monitored route and estimated own ship position.

How to select safety contour

User has to select safety depth suitable for the own ship. To select proceed as follows:

1. Press CHART DISPLAY button. Select **Chart** sheet open.
2. Enter desired depth into **Safety contour** -field.
Note, if the chart does not consist selected depth contour, the system will automatically select next deeper contour.

Chart display - ALL-ON		
Tracking	Mariner	Route
Chart	Standard	Other
Echo alarm	<input type="text" value="2"/> m	
Shallow contour	<input type="text" value="2"/> m	
Safety depth	<input type="text" value="15"/> m	
Safety contour	<input type="text" value="10"/> m	
Deep contour	<input type="text" value="20"/> m	
Speed Vectors	<input type="text" value="12"/> min	<input type="text" value="TRUE"/>
TM reset margin	<input type="text" value="80"/> %	
Scale	<input type="text" value="1:20000"/>	
Palette	<input type="text" value="DAY BRIGHT"/>	
Symbols	<input type="text" value="SIMPLIFIED"/>	
Depths	<input type="text" value="TWO COLOUR"/>	
Boundaries	<input type="text" value="SYMBOLIZED"/>	
Light sectors	<input type="text" value="LIMITED"/>	
Shallow pattern	<input type="text" value="NONE"/>	
Update highlight	<input type="text" value="ALL EFFECTS"/>	

Here in this example safe water depth is set as 10 m. Use **Safety Contour** -field to set depth limit for Chart Alarms.

How to select objects used in Chart Alarms

You can include for calculation also areas which have to be noted when sailing (for example restricted areas). To include these areas for chart alarms, proceed as followed:



Set time
Parameter Backup Digitizer Backup and Restore
Installation parameters Navigation parameters ▶ Chart Alarm parameters Optimization parameters ▶
Print Navigation parameters ▶
Print Optimization parameters ▶
Selftest Standby
Presentation library
Access Server and Diagnostic ▶

1. Press INITIAL SETTING button, select **Chart Alarm parameters** from the menu.
2. Following dialog box appears. Open **Chart Alarms** sheet. Highlight desired object in **Ignore** list box to be included safe water calculation. After highlighting press either **Indication** or **Alarm** whether you want only indication or also alarm when crossing danger area.



In this example the system gives indication when crossing **Areas To Be Avoided** and alarm when crossing **Safety contour** and **Restricted Area**.

List of areas

There are the areas which ECDIS detects and provides an alarm or indication if estimated own ship position or planned or monitored route across the area. You can select following areas in Chart Alarms sheet.

Fairway	Cargo Transshipment Area
Restricted Area	User Chart Danger
Caution Area	Traffic Separation Zone
Offshore Production Area	TRS Crossing/Roundabout
Military Practise Area	TRS Precautionary Area
Seaplane Landing Area	Two Way Traffic Route
Submare Transit Lane	Deep Water Route
Fishing Ground	Recommended Traffic Line
Pipeline Area	Inshore Traffic Zone
Cable Area	Ice Area
Anchorage Area	Channel
Anchorage Prohibited	Fishing Prohibited
Dumping Ground	Spoil Ground
Incineration Area	Dredged Area

Note! Areas To Be Avoided and Specially Protected Areas are collections of certain type of areas. If you select either of them, a group of areas will cause alarm or indication. A table below shows which areas are selected if Areas To Be Avoided or Special Protected Areas is selected.

Areas To Be Avoided	Specially Protected Areas
Fairway	Fishing Ground
Restricted Area	Pipeline Area
Caution Area	Cable Area
Offshore Production Area	Anchorage Area
Military Practise Area	Anchorage Prohibited
Seaplane Landing Area	Dumping Ground
Submare Transit Lane	Incineration Area
	Cargo Transshipment Area

How to highlight Chart Alarm

User has possibility to select level of transparency of Chart Alarm highlight. To select, proceed as follows:

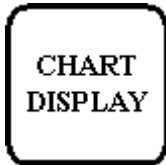

1. Press CHART DISPLAY button, select **Mariner** sheet open.
2. Select in **Chart Alarm Warning area** field Highlight as **Std** or **Other** position.

Chart display - ALL-OFF *

Chart	Standard	Other
Tracking	Mariner	Route

Pilot data

Off Std Other

Position

Range

Text

User chart

Off Std Other

Points

Lines

Symbols and Tidal

Areas

Display only radar part of Lines, Symbols and Areas

Chart Alarm warning area

Off Std Other

Highlight

Reference target

Off Std Other

Position

How to include User Chart Symbols, Lines and Areas in Chart Alarm

Symbols

For User Chart Symbols use option **Danger Symbol** in Symbol sheet. Without this selection Symbol of User Chart is not used for Chart Alarm. The dangerous symbol is drawn red instead of dark yellow.

*In Symbol sheet of User Chart you can select which Symbols are included Chart Alarm by selecting **Danger Symbol** check box.*

USER CHART - URAGA-TO / 03.09.1999 09:43

Point	Line	Area	Symbol	Tidal
-------	------	------	--------	-------

Current Total 87

Name

Position

Lat

Lor

Symbol

Dsp on radar

Danger Symbol

Lines

For User Chart Line use option **Danger Line** in Line sheet. Without this selection Line of User Chart is not used for Chart Alarm. The dangerous line is drawn red instead of dark yellow.

In Line sheet of User Chart you can select which lines are included Chart Alarm by selecting Danger Line check box.

USER CHART - URAGA-TO / 03.09.1999 09:43

Point Line Area Symbol Tidal

Current 12 Total 14

Name: URAGA

Element type: Navigation lin

Danger Line

On Radar

Start position: End position:

Areas

For User Chart Areas use option **Danger Area** in Area sheet. Without this selection Area of User Chart is not used for Chart Alarm. The boundary of dangerous area is drawn red instead of dark yellow.

In Area sheet of User Chart you can select which areas are included Chart Alarm by selecting Danger Area check box.

USER CHART - URAGA-TO / 17.08.1999 14:54

Point Line Area Symbol Tidal

Area Object

Current 1 Total 4

Name: wreck

On Radar Danger Area

First << >> Last

Add Import... Delete

See figure below for behaviour of dangerous Symbol, Line and Area in Chart Alarm check.

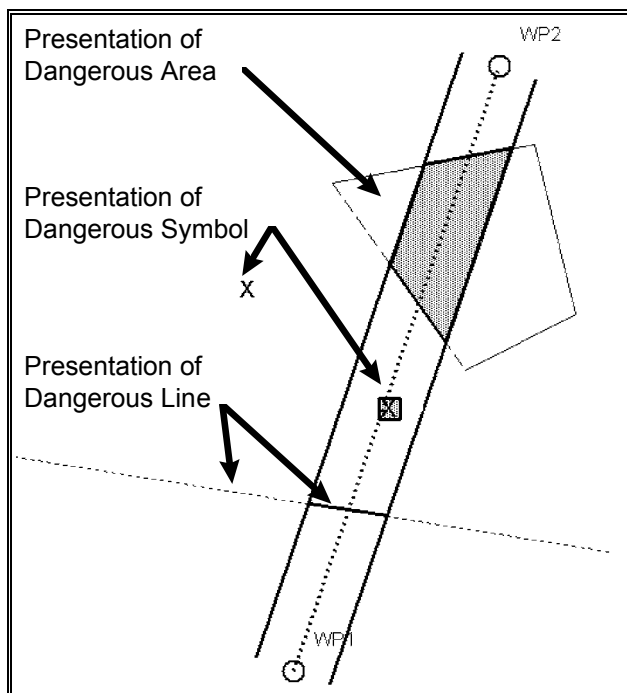

How to activate own ship check

Calculation of own ship predicted movement area is done using watch sector from own ship position. Sector size is defined by time and angle. To set them proceed as follows:

INITIAL SETTING

Set time
Parameter Backup
Digitizer
Backup and Restore
Installation parameters
Navigation parameters ▶
Chart Alarm parameters
Optimization parameters ▶
Print Navigation parameters ▶
Print Optimization parameters ▶
Selftest
Standby
Presentation library
Access Server and Diagnostic ▶

1. Press INITIAL SETTING button, select **Chart Alarm parameters** from the menu.
2. Following dialog box appears. Open **Parameters** sheet. Enter desired values to define size of sector.

Chart Alarms

Parameters Chart Alarms

Chart Alarms Sector

Time Min

Angle °

Time for sector is set to be 6 minutes and angle is 10 degrees.

Figures below show how watch sector is displayed on ECDIS screen.

Mon.RouteHEL-STO	Plan Route	Pilot Data HKI-STO	Predictor 60 sec	North Up	TM	TrueVect 12 min
UserChart E_SUOMI	Ref Target	ARPA 1 Radar MAST X				Larger scale data exist

59°51.538'N Gyro 219.1 °

024°28.031'E COG 219.2 °

WGS 84 (pos)

FILTER HIGH SOG 23.2 Kt

Plan Speed	20.0 Kt	To WP	3
Plan	216.9 °	Dist WOP	2.55 nm
Route	216.8 °	Time	06:36
Ch limit	185 m	Next WP	4
Off track	<32 m	Next	228.4 °
		Turn rad	1.0 nm
		Turn rate	22 °/min

S57 chart legend

Cell name	FI4EIIQR
Navigational purpose	Approach
Issue date	20010201
Edition number	1
Last displayed update	019
Update issue date	20010724
Last update appl. date	20010201
Projection	Mercator
Horizontal datum	WGS 84
Vertical datum	
Sounding datum	Approximate mean sea level
	Mean lower low water springs
Quality of data	Zone of confidence A1
Magnetic var.	
Depth	metres
Height	metres

Cursor

From Own Ship: 1.229 nm 170.9 °

60°07.145N 024°54.714E

30.08.2001 10:23 UTC	30.08.2001 13:23 LOCAL TIME	SINGLE 1:20 00	04.00 04.00
----------------------	-----------------------------	----------------	----------------

View of Chart Alarm indication. Note Navigational Purpose of chart. See also figure below.

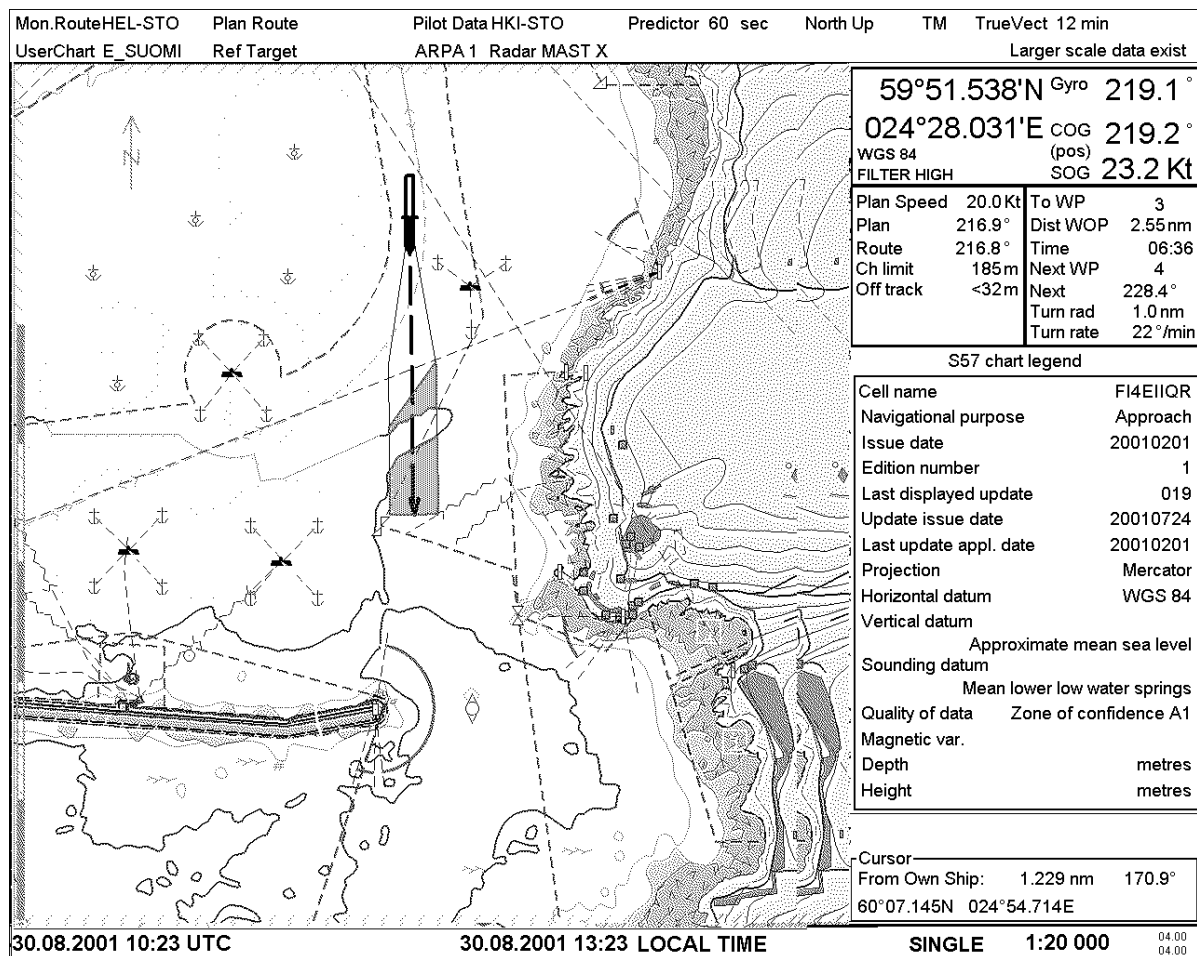

View of Chart Alarms. Note Navigational Purpose of chart. Chart Alarm uses always largest scale chart available no matter which chart is selected to be displayed.

Route planning

The system will calculate Chart Alarms using user defined channel limit for route. Dangerous areas are shown highlighted if safety contour or user selected Chart Alarm areas are crossed by the planned route. For more information of route planning, see chapter "Route planning".

Note! If your voyage is going to take a long time or you are planning it much earlier than it is taking place, use display and approve dates corresponding dates you are going to sail. For more information, see chapter "Time dependent and periodical features of S57 chart"

You can generate a list of Chart Alarms which are across by the planned route. Proceed as follows:

1. Enter **Safety Contour** you want to use.
2. Plan a route, define waypoints and other necessary information.
3. Select dangerous objects to be used during Route monitoring in Chart Alarm calculation.

4. After that open **Check** sheet, to generate a list of alarms press **Start** button. The system will check a route leg by leg and when finish you will see number of **Legs** and **Alarms** in an upper part of dialog box.

Figures above show before and after Chart Alarm calculation in Route Planning mode.

If there are alarms included to planned route, you have two alternatives to check them.

1. Check alarms leg by leg
2. Check alarms by using category of alarm

How to find Chart Alarms leg by leg

After you have done Chart Alarm calculation, the system is able to show you legs where dangerous areas are located. All the alarms for each leg where alarms occur are shown in a list box of **Alarms**. The list of alarms is based on selections in Chart Alarm parameters. To find Chart Alarms for route, proceed as follow:

1. In ChartAlarms sheet select in list box a leg.

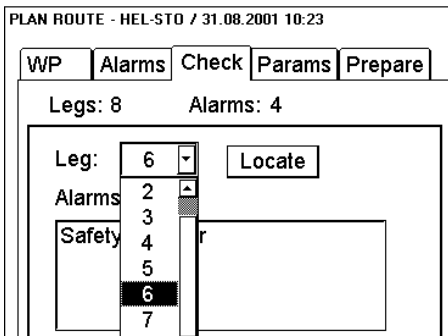

2. In an Alarm list box there are displayed all the alarms in this leg.

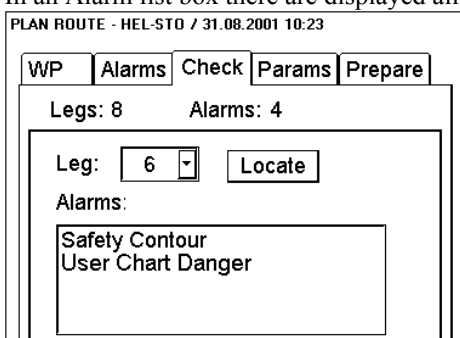

Press **Locate** button, the system will display selected leg on Electronic Chart Area.

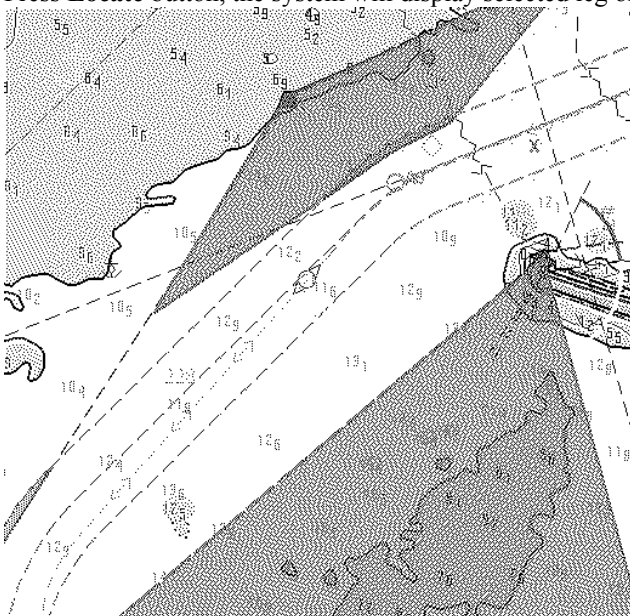

How to find Chart Alarms by their category

After you have done Chart Alarm calculation, the system is able to show you legs where the Chart Alarms are locating. The system can show alarms by their category. In order to do it, proceed as follow:

1. In ChartAlarms sheet select first desired alarm in **Alarm** list box and after that you can select leg in **Legs** list box.

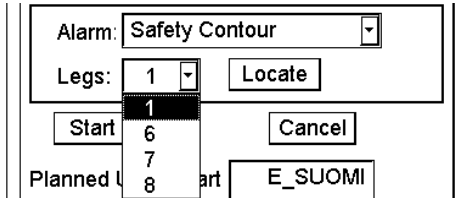

The screenshot shows a software interface for selecting chart alarms. It features a dropdown menu for 'Alarm' set to 'Safety Contour'. Below it, a 'Legs' dropdown menu is open, showing options 1, 6, 7, and 8. A 'Locate' button is positioned to the right of the 'Legs' dropdown. Below the 'Legs' dropdown, there are 'Start' and 'Cancel' buttons. At the bottom, there is a 'Planned U' dropdown menu set to 'E_SUOMI'.

2. Press **Locate** button, the system will display selected leg on Electronic Chart Area.

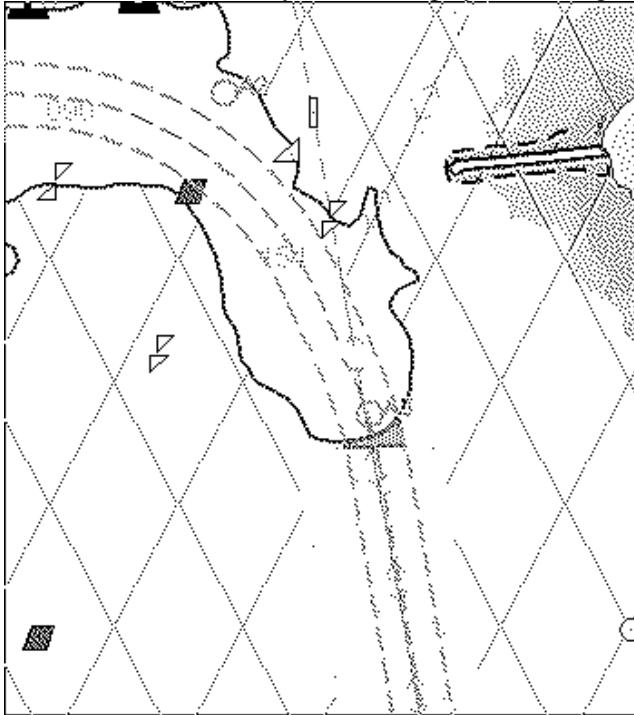

Route monitoring

Route monitoring can be divided to two separate parts; own ship estimated position and monitored route. See also chapter "Route Monitoring".

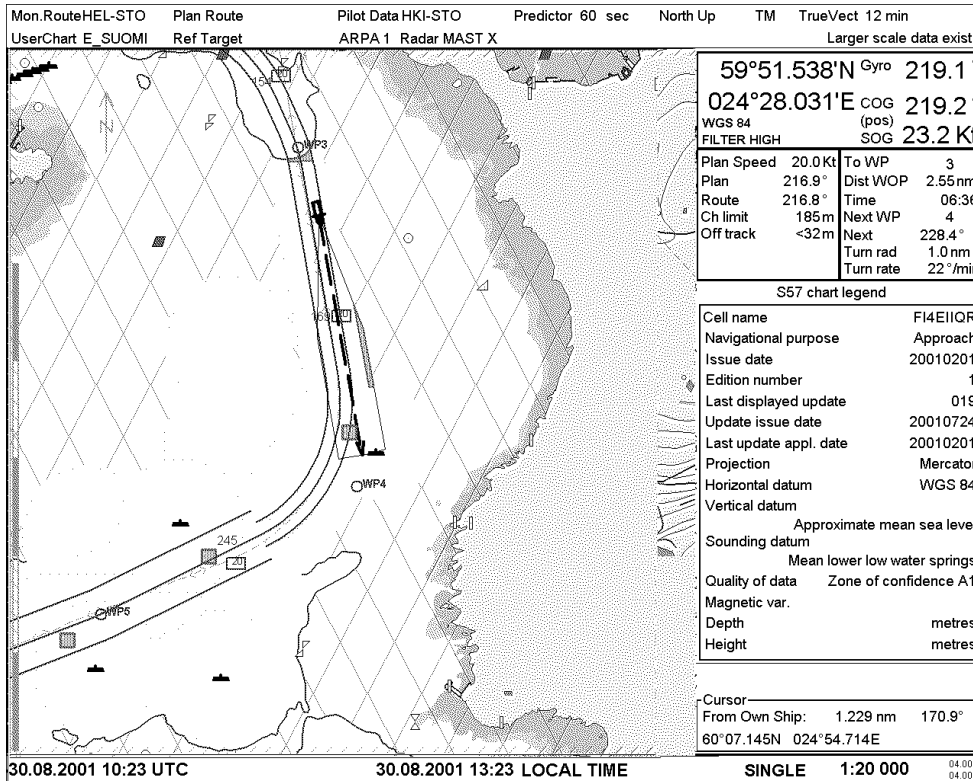

Figure above shows how in route monitoring mode the system highlights Chart Alarms inside channel limits of monitored route and inside predicted movement area of own ship.

Note, the system has a build in Route assistant, which ease the safe use of Routes. During the Route Plan you can check your Route Plan for safe water and you can attach a User Chart and a Pilot Data which you intended to be used together with a Route Plan.

MONITOR ROUTE - TOKYO BAY / 03.02.2003 14:48

Monitoring	Alarms	Selections	Waypoints
To	WP 5	Max speed	
KISARAZU			
ETA	WP 8	Time 03 Feb 03 15:28	
URAGA	Distance	15.6 nm	
Final	WP 9	Time 03 Feb 03 15:36	
PILOT	Distance	18.0 nm	
min			
Suggested speed		Kt	
Trial speed	5.3	Kt	
Speed profile	Plan		
Center line	Off	for ARPA	
Channel borders	Off	radar	
Checked conditions are different			

If you have a text "Checked conditions are different", use **Alarms** page to verify difference between actual and planned situation.

Chart Alarm using ARCS charts

In case of using ARCS charts, you can yourself define dangerous areas by using User Chart. The system can utilise User Chart symbols, lines and areas and calculate Chart Alarm from this material. See also chapter "User Chart Control".

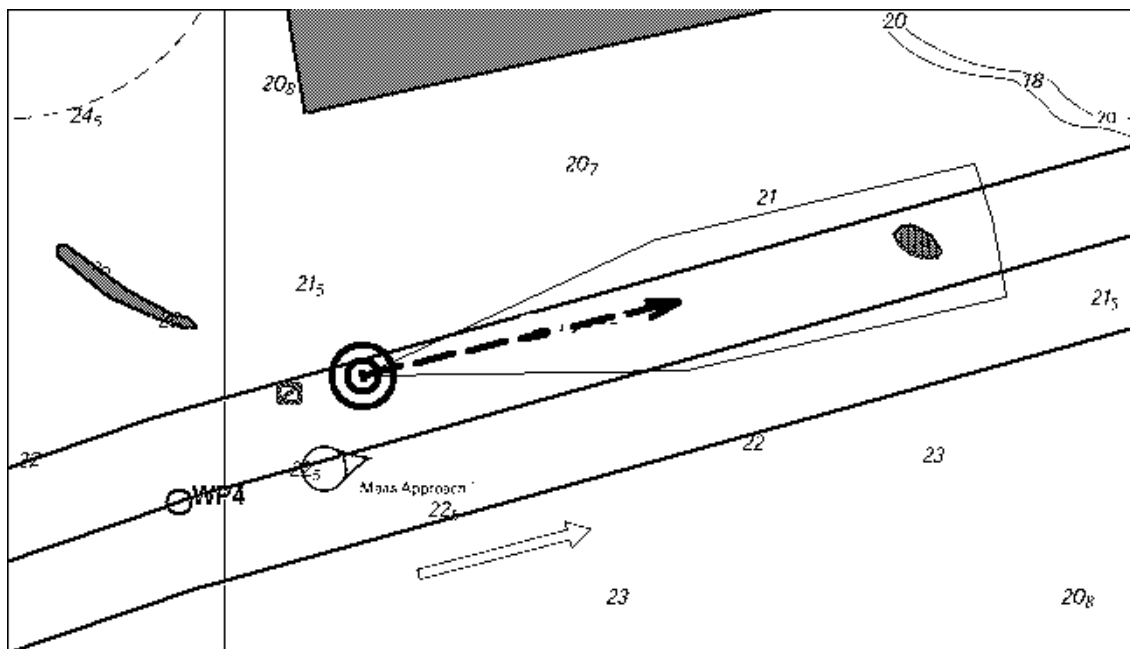

Chart Alarm used with ARCS chart. The calculation is done with route and predicted movement area of own ship.

Proceed following steps, when you start planning of next voyage:

1. Create a new User Chart or select existing one which has been defined symbols, lines and/or areas for Chart Alarms. See "How to include User Chart Symbols, Lines and Areas in Chart Alarm" on page 217.
2. Check that "Chart Alarm Warning Area" is set to be displayed. See chapter "How to highlight Chart Alarm" on page 217.
3. Select User Chart danger area indication or alarm position. See "How to select objects used in Chart Alarm" on page 215.
4. In route planning mode define a new route or select existing one. Make Chart Alarm of route if there are indications of danger areas. Modify your route if necessary. See chapter "Route planning".
5. Select route as monitored route.
6. Set watch sector for your own ship. See chapter "How to activate own ship check" on page 219.

The system is ready for Chart Alarms based on User Chart for monitored route, planned route and own ship.

This page is intentionally left blank

Navigation tools

Display mode and Orientation of Chart

DISPLAY MODE push button is used to select between true motion and relative motion display modes. In true motion mode ECDIS shows own ship's position, and other movable data such as radar targets, moving on the earth-fixed chart background. In relative motion mode ECDIS shows the chart information, and radar targets, moving relative to own ship position fixed on the screen.

Indication of Display mode is shown on Upper Status bar of ECDIS.

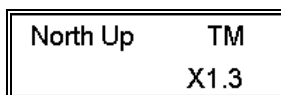

An example where True Motion with North Up orientation is selected.

See list below which orientations of chart can be used with True Motion and with Relative Motion.

True Motion:

- True Motion North Up
- True Motion Course Up

In **True Motion** display mode, the orientation of chart is set again when automatic TM RESET happens, when you press TM/CU RESET button or when you press SHIP OFF CENTER button.

Relative Motion:

- Relative Motion North Up
- Relative Motion Course Up
- Relative Motion Head Up
- Relative Motion Route Up

In **Relative Motion** display mode, the orientation of chart is set again when you press TM/CU RESET button or when you press SHIP OFF CENTER button.

Notes:

- If you use Head Up or Route Up together with Relative motion, then the orientation is set again whenever the source of it has been changed.
- **Route Up** orientation of chart will be redrawn when new To WP is set.

How to select desired Display Mode and orientation of Chart

Desired display mode and orientation of Chart can be selected by pressing DISPLAY MODE button and selecting desired mode from the menu:

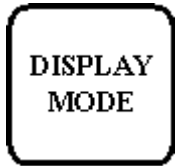

DISPLAY MODE button

True Motion North Up
True Motion Course Up
Relative Motion North Up
Relative Motion Course Up
Relative Motion Head Up
Relative Motion Route Up
Set Center

menu:

Display mode and Orientation:

Following Display modes and orientations of chart can be used:

- True Motion North Up
- True Motion Course Up
- Relative Motion North Up
- Relative Motion Course Up
- Relative Motion Head Up
- Relative Motion Route Up

Center:

User can set center of the chart screen.

Navigation marks

Navigation marks consist of two independent sets of tools. Both tools have REFERENCE POINT, EBL, VRM, PARALLEL INDEX and RANGE RINGS which are displayed in the Electronic Chart Area.



NAV MARKS pushbutton

NAVIGATION MARKS

Tool set 1

Centered reference point

Move Display

Reference point

VRM

EBL

Parallel index

Range rings 1 nm

Info

Data

EBL	<input type="text" value="224.7"/>	°	VRM	<input type="text" value="2.175"/>	nm
	34°56.507N			129°10.415E	
Ref.	34°58.053N			129°12.273E	

sheet: "TOOL SET 1"

Centered reference point:

Use this to select tool set to centre of own ship.

Reset:

By pressing this button you can reset Reference point to center of chart display, VRM and EBL are set to value of zero.

Display Reference point:

Use this option to display reference point on the electronic chart.

Display VRM:

Use this option to select VRM (Variable Range Marker) to be displayed around the reference point.

Display EBL:

Use this option to select EBL (Electronic Bearing Line) to be displayed from the reference point.

Display parallel index:

Use this option to select parallel lines with EBL to be displayed. The range of parallel index is controlled by changing VRM's size.

Display range rings:

Use this option to select range rings to be displayed around the reference point. The range of those rings is depending on scale of displayed chart.

Display Info:

Use this option to select information about VRM, EBL and Reference point to be displayed on Electronic chart area in numeric mode.

Move Reference point:

Use this option to set preference of move to Reference point.

Move VRM:

Use this option to set preference of move to VRM and EBL.

Move EBL/parallel index:

Use this option to move EBL/parallel index. To change direction of EBL use CHART ALIGN push button. Move cursor to end of EBL, drag and drop it to desired location by using CHART ALIGN push button.

sheet: "TOOL SET 2"

There is a possibility to set another tool. It is used same way as **TOOL SET 1**.

How to move EBL

You have two methods available: you can directly enter a new numeric value of EBL or you can locate cursor over the EBL line and use CHART ALIGN to move it. If you locate cursor over crossing of VRM and EBL then you can use CHART ALIGN to move both. If reference point and EBL coexist in a same location then you can set preference to move EBL with "Move VRM" option.

How to move VRM

You have two methods available: you can directly enter a new numeric value of VRM or you can locate cursor over the VRM ring and use CHART ALIGN to move it. If you locate cursor over crossing of VRM and EBL then you can use CHART ALIGN to move both. If reference point and VRM coexist in a same location then you can set preference to move VRM with "Move VRM" option.

How to move Reference point

To move reference point, move cursor above reference point and use CHART ALIGN push button to drag and drop reference point desired location. If reference point, EBL and VRM coexist in a same location then you can set preference to move Reference point with "Move Reference point" option

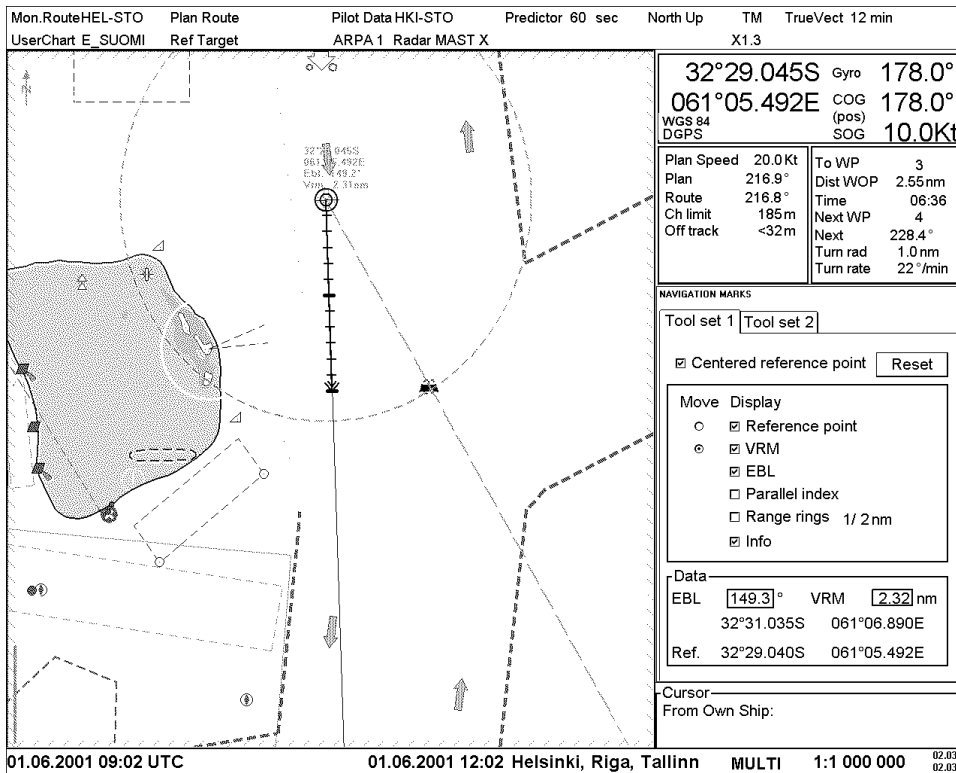

Centered reference point with Variable Range Mark (VRM), Electronic Bearing Line (EBL) and numeric info on chart display.

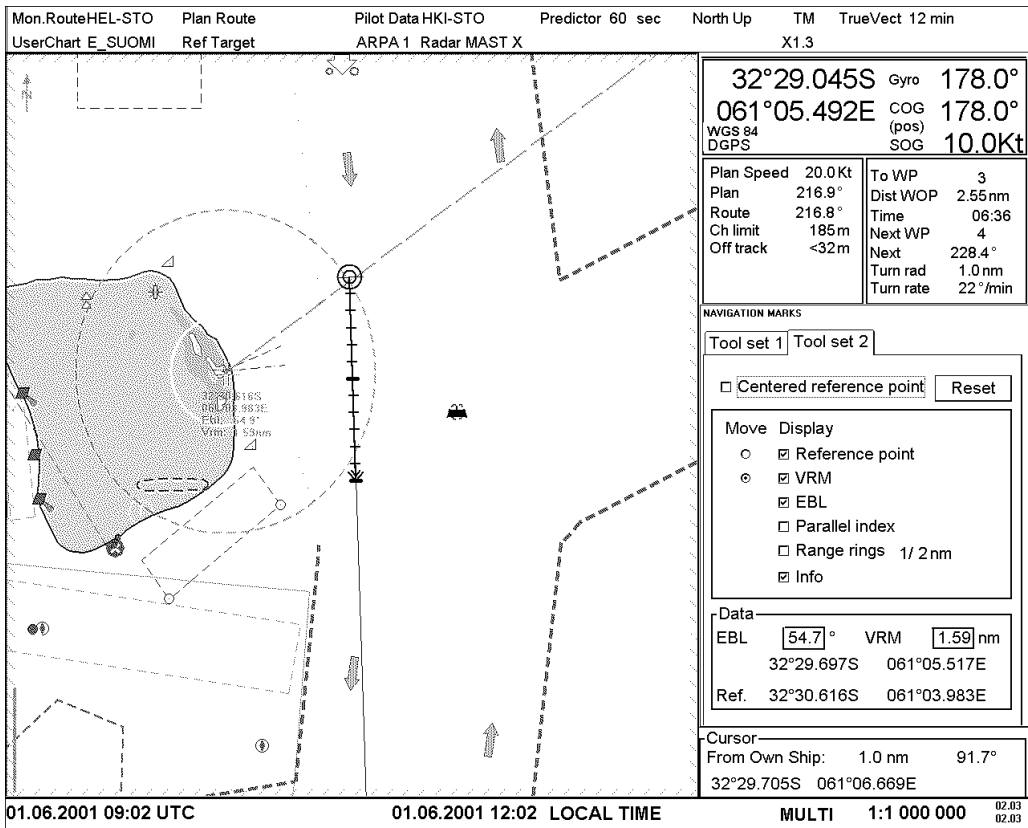

Reference point not centered own ship position with Variable Range Mark (VRM) and Electronic Bearing Line (EBL).

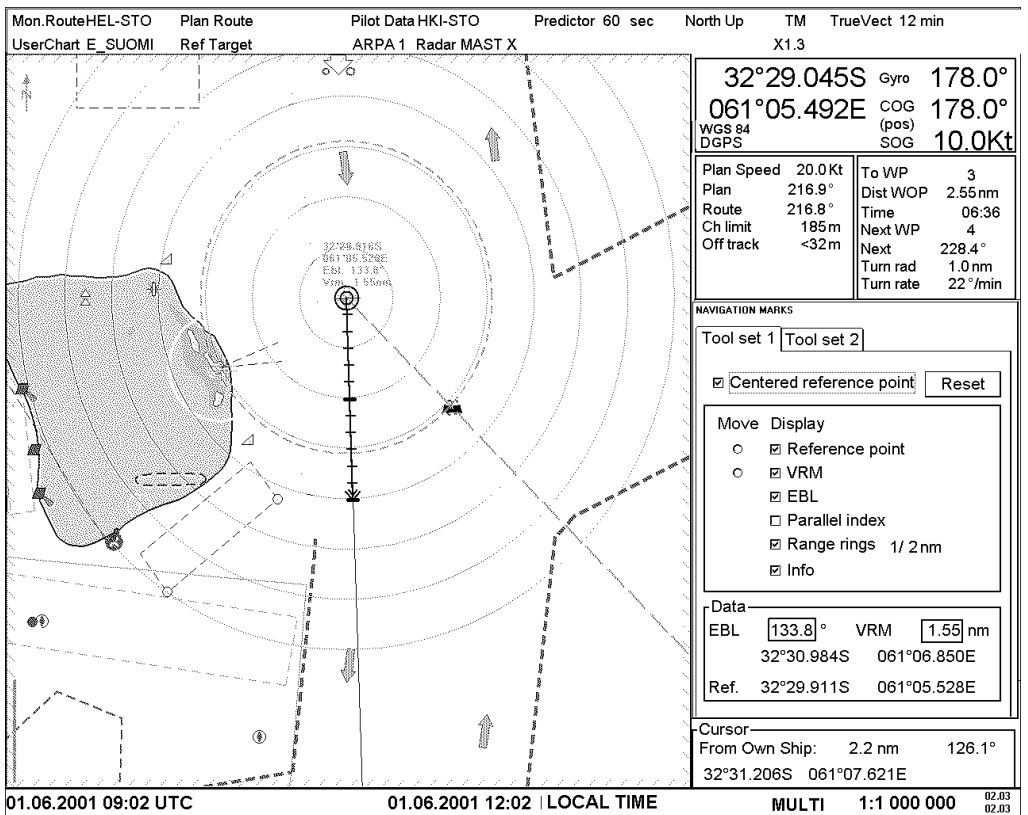

Centered reference point with Range rings.

This page is intentionally left blank

Route planning

Introduction

A route plan is complete navigation plan from starting point to the final destination. The plan includes:

- Route name
- Name, Lat and Lon of each waypoint
- Radius of turn circle at each waypoint
- Safe channel limits
- Chart Alarm calculation based on channel limits against chart database and User Chart danger
- Deadband width
- Minimum and maximum speed for each leg
- The navigation method (rhumb line, great circle)
- Fuel saving
- ETD for the first waypoint
- ETA for the last waypoint
- Ship and environmental condition affecting the ship speed calculation
- Name of the User Chart planned to be used during Route Monitoring together with this Planned Route
- Name of the Pilot Data planned to be used during Route Monitoring together with this Planned Route

The system calculates using this data; speed, course and length for each leg, ETAs for each waypoint, fuel consumption and WOP for the trackpilot and also calculates safe water areas based on user defined channel limits. The calculated data is displayed in a tabular form which can be printed as a documented route plan and also stored in a file for later use. The route files thus formed contains the trackpilot commands for each waypoint.

Main functions of this Route Planning are:

- Define waypoints
- Define turnings for each waypoint
- Define channel limits for each leg (leg is the line connecting two waypoints together). The channel limits are used to detect Chart Alarms when you are planning or monitoring your route. See also chapter "Chart Alarm calculation"
- Define the speed for each leg
- Enable a calculation for ETD and ETA
- Enable a calculation for most economical sailing

Route planning main menu

Main parameters for the Route Planning are:

- Latitude and longitude of the waypoint
- Channel limits to the waypoint
- Turning radius of the waypoint
- Maximum and minimum speed limits for a leg

There are two push buttons to control a route (ROUTE PLAN and ROUTE MONITOR). ROUTE PLAN push button is used for planning the route and ROUTE MONITOR is used to select and control a route for monitoring.

To complete Route planning, proceed as follow:

1. Create a new route or select existing one for route planning. See chapter "How to create a new route" on page 236.
2. Modify your route if necessary. See chapter "How to modify already existing route" on page 242.
3. Make Chart Alarm (Safe water) calculation. See "Introduction of Check sheet" on page 239.
4. Optimize your route. See "Optimization" on page 247.

Operation of Route planning push button is following:

1. When you press ROUTE PLAN push button, ROUTE PLANNING dialog box will appear to Dialog box area.
2. Press ROUTE PLAN push button again, you will get Route planning menu on display.



ROUTE PLAN button

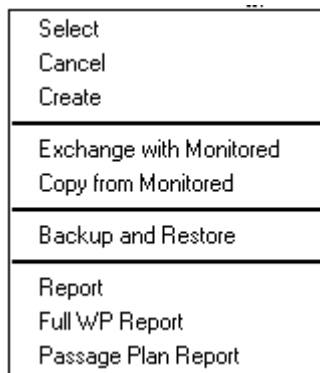

menu:

Select:

You can select already existing route to be edited. Choose **Select** from the menu, there will appear a list box in Dialog box area. Choose appropriate route in list box of routes.

Cancel:

You can remove route from use.

Create:

Choose Create from menu, if you want to make a new route, there will appear typewriter in the Dialog box area. Give name to route max. 8 letters. See also "How to create a new route" on page 236.

Exchange:

This function is used to exchange planned and monitored routes. Planned route is used both as alternative route and as editable route.

Copy from monitored:

This makes copy from monitored route for plan route.

Backup and Restore:

You can make a backup to floppy disk or restore a route from floppy disk. See also "Backup Operations" on page 313.

Report:

Use this to generate report of planned route.

Full WP Report:

Use this to generate detailed report of planned route.

Passage plan Report:

Use this to generate a combined report from active Planned Route and active Pilot Data.

Note

To get planned route to be displayed, make sure that desired options of the planned route (Center Line, Channel Borders, Wp-marks and Leg marks) are selected either **Std** or **Other** on the ROUTE -sheet.

If all of Planned Route options are set as **Std** or **Other**, text "Displayed" is shown on Route Plan window.

If any of Planned Route options are set as **OFF**, text "Partly Displayed" is shown on Route Plan window.

If all of Planned Route options are set as **OFF**, text "Not Displayed" is shown on Route Plan window.

Position		Speed	
Lat	35°00.699N	Min	0 Kt
Lon	139°31.478E	Max	4 Kt
First	<<	>>	Last
Insert	Next WP	Delete	
Import		Reverse	
<input checked="" type="checkbox"/> Enable changes		Partly Displayed	

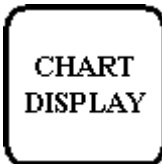

Chart details dialog box appear when user press CHART DISPLAY push button. To select between different sheets to be opened either press button



or go by cursor above desired sheet's text and press SELECT

Chart details - ALL-ON		
Chart	Standard	Other
Tracking	Mariner	Route
Monitored route		
Off Std Other		
<input type="radio"/>	<input checked="" type="radio"/>	<input type="radio"/> Center line
<input type="radio"/>	<input type="radio"/>	<input checked="" type="radio"/> Channel borders
<input type="radio"/>	<input checked="" type="radio"/>	<input type="radio"/> WP - mark
<input type="radio"/>	<input type="radio"/>	<input checked="" type="radio"/> Leg mark
<input type="radio"/>	<input type="radio"/>	<input checked="" type="radio"/> Wheel over line
Planned route		
Off Std Other		
<input type="radio"/>	<input checked="" type="radio"/>	<input type="radio"/> Center line
<input type="radio"/>	<input type="radio"/>	<input checked="" type="radio"/> Channel borders
<input type="radio"/>	<input checked="" type="radio"/>	<input type="radio"/> WP - mark
<input type="radio"/>	<input type="radio"/>	<input checked="" type="radio"/> Leg mark

Wp-marks enables display of WP's number on the Electronic chart area.

Leg marks enable display of planned speed and Course to Steer, which were defined during route planning, on the Electronic chart area.

Select datum

Selection of datum is very important, if you manually enter latitude-longitude positions from the control panel or keyboard or if you use digitizer. If you only operate with cursor to add and to modify waypoint locations, then you could use any datum, although it is recommended to use native datum of the chart. For more information to select datum, see chapter "Datum".

How to create a new route

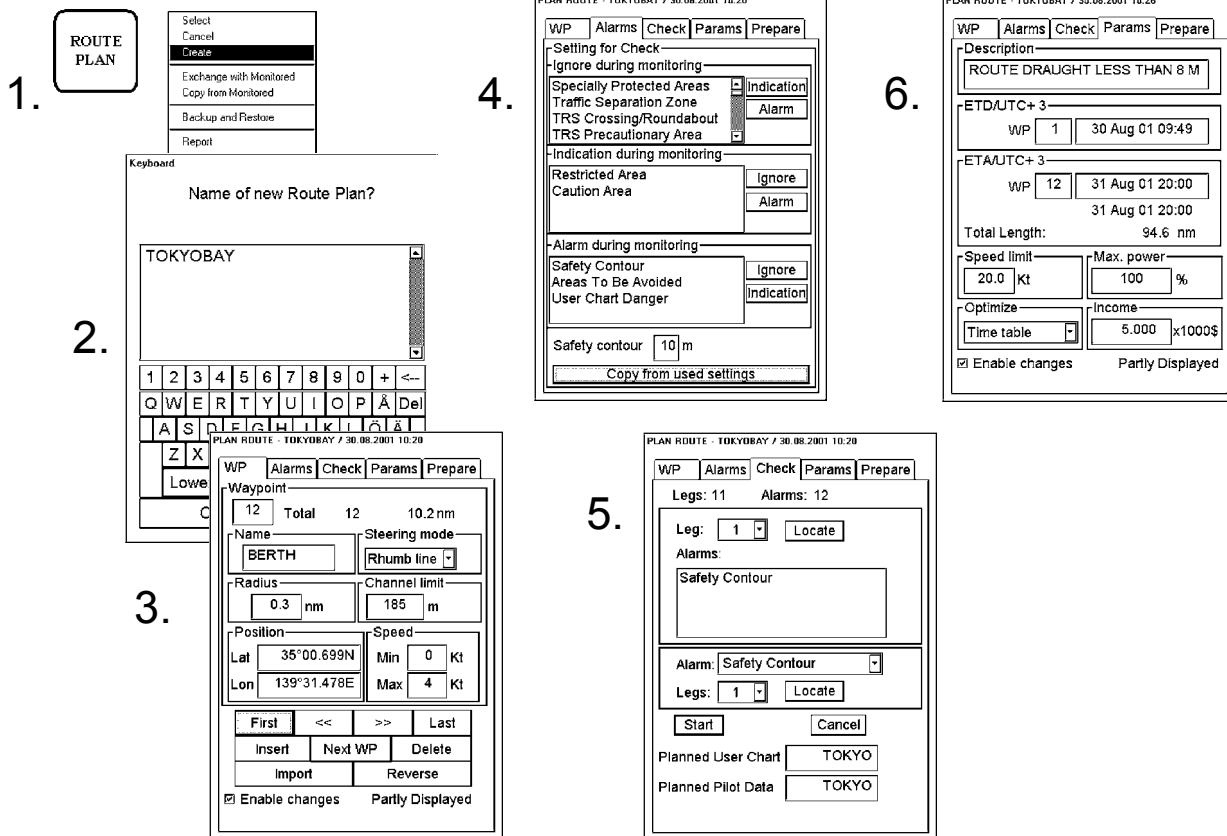

To make a complete route for a voyage, proceed as follows:

1. Press twice ROUTE PLAN button. Select **Create** from the menu.
2. Enter a name for route using Keypad dialog box.
3. Select **Enable changes**. Define position of waypoint by moving cursor to desired position and then press SELECT button of Control Panel. After that complete following in WP page of Route Planning dialog box; **Name, Steering mode, Radius, Channel limit** and **Speed (Min, Max)**. Do this for all waypoints of your route.
4. Use **Alarms** page to define Safety Contour and other specified conditions for the Check of the route.
5. Use **Check** page to detect areas where depth is less than Safety contour or where specified conditions exists. The ECDIS can examine chart database against planned route to make a list of alarms where route across Safety contour or specified areas used in Chart Alarms, press **Start** button to do it.
6. Use **Params** page to enter Estimated Time of Departure (ETD) and Estimated Time of Arrival (ETA, if you are using Time table optimizing). Select desired Optimizing mode from list box of **Optimize**.

To print Waypoint report press ROUTE PLAN button and select **Report** from the menu. Select **Print** from File menu in Report page.

Introduction of Waypoint sheet

To select between Params, ChartAlarms, Prepare and WPs sheets to be opened either press button



or go by cursor above WP, Params, ChartAlarms or Parameters text and press SELECT

PLAN ROUTE - TOKYOBAY / 30.08.2001 10:20					
WP	Alarms	Check	Params	Prepare	
Waypoint					
12	Total	12	10.2 nm		
Name		Steering mode			
BERTH		Rhumb line ▾			
Radius		Channel limit			
0.3 nm		185 m			
Position			Speed		
Lat	35°00.699N		Min	0 Kt	
Lon	139°31.478E		Max	4 Kt	
First	<<	>>	Last		
Insert	Next WP		Delete		
Import		Reverse			
<input checked="" type="checkbox"/> Enable changes		Partly Displayed			

Enable changes:

You have to select this in order to enable editing.

Note! You are able to modify Route when **North Up** or **Course Up** orientation is selected to be used.

Waypoint:

Each waypoint has a number. This shows the current waypoint number. Total indicates first the total number of waypoints in the current route and then length of the planned leg from previous waypoint to the current waypoint.

Name:

You can give name to each waypoints.

Steering mode:

You can define steering mode each leg whether it is rhumb line or great circle.

Radius:

You can define turning radius for each waypoints.

Channel limit:

You can define channel limit for each leg.

Position:

In these fields you can enter LAT/LON position of waypoint.

Speed:

You can set speed limit for minimum and maximum speed.

First:

Pushing this control user gets to first waypoint of the file.

Last:

Pushing this control user gets to last waypoint of the file.

>>:

This changes current waypoint to the next waypoint.

<<:

This changes current waypoint to the previous waypoint.

Insert:

This insert a new waypoint before the current waypoint.

Next WP:

This function adds a new waypoint after current waypoint. You can define direction and distance for next waypoint.

Delete:

This function deletes current waypoint.

Import:

You can import new waypoints from already existing routes into your current route.

Reverse:

Use this function to reverse sailing order of the whole route.

Introduction of Alarms sheet

In this sheet you can define desired conditions for the route. You can select Safety contour and Chart Alarms used for check of this route. This allows you to make check with different conditions that selected for the System use. This is useful when making a route for different loading or sailing conditions.



Press *SELECT NEXT* button to open *AntiGround* sheet

PLAN ROUTE - TOKYO BAY / 20.12.2001 09:52

WP Alarms Check Params Prepare

Setting for Check

Ignore during monitoring

Traffic Separation Zone Indication
 TRS Crossing/Roundabout Alarm
 TRS Precautionary Area

Indication during monitoring

Specially Protected Areas Ignore
 Restricted Area Alarm
 Caution Area

Alarm during monitoring

Safety Contour Ignore
 User Chart Danger Indication

Safety contour 10 m

Copy from used settings

Enable changes Displayed

Enable changes:

You have to select this in order to enable editing.

Note! You are able to modify Route when **North Up** or **Course Up** orientation is selected to be used.

Ignore during monitoring

Chart objects in this list box are not used for Chart Alarm calculation

Indication during monitoring

Chart objects in this list box are used for Chart Alarm calculation. Only indication of selected Chart objects are generated by the System.

Alarm during monitoring

Chart objects in this list box are used for Chart Alarm calculation. Both indication and audible alarms of selected Chart objects are generated by the system.

Safety Contour

Selected Deep Contour for Chart Alarm calculation

Copy from used settings

Used to copy settings defined above from the settings currently used by the System.

Introduction of Check sheet

In this sheet you can make Safe water calculation for your route. For more information see chapter "Chart Alarm calculation".

In this sheet you also store the names of the User Chart and Pilot Data planned to be used during Route Monitoring together with this Planned Route. The storage happens when you activate the Safe Water calculation from Start pushbutton. The stored names are the name of the Planned User Chart and Planned Pilot Data.



Press *SELECT NEXT* button to open *Check sheet*

PLAN ROUTE - TOKYOBBAY / 30.08.2001 10:20

WP Alarms Check Params Prepare

Legs: 11 Alarms: 12

Leg: 1 Locate

Alarms:

Safety Contour

Alarm: Safety Contour

Legs: 1 Locate

Start Cancel

Planned User Chart TOKYO

Planned Pilot Data TOKYO

NOTE! In order to display charts with correct updated situation, use **always** current date during your voyage. If your voyage lasts more than one week set current date at least once per week during your voyage.

NOTE! In order to display charts with correct updated situation during route planning, use **always** planned date of each waypoint to check your plan.

Introduction of Parameter sheet



Press *SELECT NEXT* button to open parameters sheet.

PLAN ROUTE - TOKYO BAY / 30.08.2001 10:26

WP Alarms Check Params Prepare

Description
ROUTE DRAUGHT LESS THAN 8 M

ETD/JTC+ 3
WP 1 30 Aug 01 09:49

ETA/JTC+ 3
WP 12 31 Aug 01 20:00
31 Aug 01 20:00
Total Length: 94.6 nm

Speed limit 20.0 Kt Max. power 100 %

Optimize Time table Income 5.000 x1000\$

Enable changes Partly Displayed

Enable changes:

You have to select this in order to enable editing.

Note! You are able to modify Route when **North Up** or **Course Up** orientation is selected to be used.

Description:

You can enter a note for the route.

ETD wp:

Planned estimated time of departure from a defined waypoint. (0 is automatic first waypoint)

ETA wp:

First part is planned estimated time of arrival to last waypoint. (0 is automatic last waypoint). ETA can be calculated between two defined waypoints.

Second part is calculated ETA which may differ from planned ETA, if it is impossible to meet using selected optimisation. Also total length of the route is displayed.

Speed limit:

You can set speed limit for a route.

Max. power:

You can set maximum power of engines which is used for VOS optimization. VOS is an optional software used in optimization of route.

Income:

This indicates the budget given for this voyage. (Income * 1000\$)

Optimize type:

Optimize types are Max speed, Timetable, Max Profit and Min cost.

Optimize your route

After all waypoints are inserted and you have made safe water calculation, you can optimize your route. If not selected then optimisation will be done automatically with Max. Speed. If you want do optimization with specific strategy for more information, see "Available Optimization strategies" on page 247.

Introduction of Prepare sheet

In this sheet you can prepare planned route for exchange to be the monitored route. Use this sheet if you are going to use **Exchange** function to select planned route as monitored route. You can select To WP and Final WP for steering already in planning mode.



Press SELECT NEXT button to open Prepare sheet.

PLAN ROUTE - TOKYO BAY / 30.08.2001 10:26

WP	Alarms	Check	Params	Prepare
----	--------	-------	--------	---------

Prepare for exchange with Monitored

To WP	<input type="text" value="2"/>	Timetable
ETA	<input type="text"/>	
Final WP	<input type="text" value="12"/>	31 Aug 01 20:00

How to modify already existing route

Mon.Route Plan Route TOKYO BAY Pilot Data TOKYO Predictor 30 sec North Up TM TrueVect 12 min
 UserChart Ref Target ARPA 1 Radar Ship off screen

59°51.538'N Gyro 219.1°
 024°28.031'E COG 219.2°
 WGS 84 (pos) SOG 23.2 Kt
 FILTER HIGH

Plan Speed 20.0 Kt To WP 3
 Plan 216.9° Dist WOP 2.55 nm
 Route 216.8° Time 06:36
 Ch limit 185 m Next WP 4
 Off track <32 m Next 228.4°
 Turn rad 1.0 nm
 Turn rate 22°/min

PLAN ROUTE - TOKYO BAY / 04.09.2001 11:57

WP Alarms Check Params Prepare

Waypoint
 4 Total 10 9.2 nm
 Name Steering mode
 Rhumb line

Radius Channel limit
 1.0 nm 750 m

Position Speed
 Lat 34°38.145N Min 0 Kt
 Lon 139°08.337E Max 20 Kt

First << >> Last
 Insert Next WP Delete
 Import Reverse
 Enable changes Partly Displayed

Cursor
 From Own Ship:

04.09.2001 08:59 UTC 04.09.2001 11:59 LOCAL TIME SINGLE 1:200 000 02.03 02.03

Modifying of a new route.

Parameters

Main parameters for the Route Planning are:

- Latitude and longitude of the waypoint
- Channel limits to the waypoint
- Turning radius of the waypoint
- Maximum and minimum speed limits for a leg

How to select waypoint to be modified

To select route to be modified open waypoint sheet. In a Record field waypoint's number indicates waypoint which is currently to be modified. You have three alternatives to select desired waypoint of route:

- Enter desired number of waypoint in Record field to Waypoint edit box. To modify Waypoint's number take cursor to Waypoint edit box and press **Select** button. Enter desired number and press **OK**.

PLAN ROUTE - TOKYO BAY / 30.08.2001 10:20

WP Alarms Check Params Prepare

Waypoint
 12 Total 12 10.2 nm

- Use **First**, **<<**, **>>**, **Last** buttons to find appropriate waypoint.

First << >> Last

- Use **CHART ALIGN** push button to select waypoint. Take cursor into the Electronic chart area above desired waypoint and press **CHART ALIGN** push button.

Change waypoint position

To change position of waypoint you have following alternatives to do it:

- Enter latitude and longitude to Position field.
- Enter distance and direction for next waypoint.
- Drag and drop waypoint with CHART ALIGN push button.

Enter latitude and longitude to Position field:

1. Select Waypoints sheet open.
2. Select desired Waypoint.
3. Enter co-ordinates of latitude and longitude to Position field. To modify co-ordinate of Latitude take cursor to **Lat** edit box and press **Select** button. Enter co-ordinate and press **OK**. To the same way to modify co-ordinate of longitude.

Position	
Lat	35°08.321N
Lon	139°44.794E

Enter distance and direction for next waypoint

Position of waypoint can be defined using distance and direction between two waypoints.

1. Select Waypoints sheet open.
2. Select as current WP a Waypoint from where you want to define next waypoint using direction and distance.
3. Press **Next WP** button, a following window appears

Next Wp Dist / Dir	
Current Wp	
Name	
Lat	35°09.875N
Lon	140°04.854E
Next Wp	
Direction	95.13 °
Distance	1.00 nm
<input type="button" value="OK"/>	

In this window, enter **Direction** and **Distance** in Next WP field and press OK.

Drag and drop waypoint to new position:



CHART ALIGN pushbutton

1. Select Waypoints sheet open.
2. Take cursor into the Electronic chart area above desired waypoint.
3. Press CHART ALIGN push button and move cursor to desired position. Keep CHART ALIGN button pressed down while you move cursor and release it when cursor is in right position.

Mon.Route	Plan Route TOKYOYBAY	Pilot Data TOKYO	Predictor 30 sec	North Up	TM	TrueVect 12 min
UserChart	Ref Target	ARPA 1 Radar	Non ENC Data	Ship off screen		

59°51.538'N Gyro 219.1 °	
024°28.031'E COG 219.2 °	
WGS 84 (pos)	
FILTER HIGH	SOG 23.2 Kt
Plan Speed 20.0 Kt	To WP 3
Plan 216.9 °	Dist WOP 2.55 nm
Route 216.8 °	Time 06:36
Ch limit 185m	Next WP 4
Off track <32m	Next 228.4 °
	Turn rad 1.0 nm
	Turn rate 22 °/min

PLAN ROUTE - TOKYOYBAY / 04.09.2001 12:04

WP	Alarms	Check	Params	Prepare
----	--------	-------	--------	---------

Waypoint		
5	Total 10	4.2 nm
Name	Steering mode	
	Rhumb line	
Radius	Channel limit	
1.0 nm	500 m	
Position		Speed
Lat 34°42.251N	Min 0 Kt	
Lon 139°09.489E	Max 20 Kt	
First <<	>> Last	
Insert	Next WP	Delete
Import	Reverse	
<input checked="" type="checkbox"/> Enable changes Partly Displayed		

Cursor		
From Own Ship: 2095.5 nm 6.4°		
34°44.136N 139°07.684E		

04.09.2001 08:59 UTC 04.09.2001 11:59 LOCAL TIME SINGLE 1:200 000 02.03 02.03

Drag and drop waypoint to new position. In this case it is waypoint number 5 to take to new position.

Change other waypoint data

To change other data of waypoint, such as name, steering mode, turning radius, min/max speed, proceed as follows:

1. Select desired waypoint. For more information to select waypoint, see "How to select waypoint to be modified" on page 242.
2. Take cursor to desired edit box and press **Select** button. Modify field's value and press **OK**.

Add a new waypoint in the end of a route

To add a new waypoint in the end of a route you have following alternatives:

- Use cursor and **Select** button define position of waypoint.
- Use **Next WP** button in Waypoints sheet.

To add a new waypoint by **Select** button, proceed as follows:

1. Open Waypoints sheet.
2. Take cursor to the Electronic chart area to desired position and press **Select** button. New waypoint appears to the end of route.
3. Modify data of added waypoint. For more information to modify WPs data, see "Change other waypoint data" on page 244.

To add a new waypoint by **Next WP** button, proceed as follows:

1. Open Waypoints sheet. Select last waypoint as current WP.
2. Press **Next WP** button in Waypoints sheet. Enter Direction and Distance for waypoint.

Next Wp Dist / Dir

Current Wp	
Name	
Lat	35°09.875N
Lon	140°04.854E
Next Wp	
Direction	95.13 °
Distance	1.00 nm
OK	

Insert a waypoint

If you want insert waypoint between two waypoints use **Insert** button. This inserts waypoint next to current waypoint. For example, you want insert a new waypoint between waypoints 6 and 7. Select WP 7 so that it is shown in Record field and after that push **Insert** button. The whole procedure to insert waypoint is as followed:

1. Open Waypoints sheet.
2. Select waypoint so that next waypoint of the route will be inserted one. For more information to select WP to modified, see "How to select waypoint to be modified" on page 242.
3. Press **Insert** button in Waypoints sheet.
4. Modify position of waypoint. For more information to modify WP's position, see "Change waypoint position" on page 243.
5. Modify other data of waypoint. For more information to modify WP's other data, see "Change other waypoint data" on page 244.

Delete a waypoint

To delete a waypoint, proceed as follows:

1. Open Waypoints sheet.
2. Select desired waypoint to delete. For more information to select WP to modified, see "How to select waypoint to be modified" on page 242.
3. Press **Delete** button in Waypoints sheet.

Import waypoint from other routes

You are able to select waypoints from other route to import them to current route. To import waypoints proceed as follows:

1. Open Waypoints sheet.
2. Press **Import** button. The following dialog box appears

WP IMPORT

Copy from

Route TOKBAY Wp total 4

First wp to copy 1

Number of wp's 4

Copy to

Route TOKYO Wp total 19

Copy after wp 16

Copy before wp 17

Copying order Direct

Copy

3. WP import dialog box.
4. Select the route from where waypoints will be copied.
5. Enter first waypoint to copy.
6. Enter number of copied waypoints to **Number of WP's** edit box.
7. Enter to **Copy before wp** field WP's number before which imported WPs will be added.
8. Select copying order. The copying order can be direct or reverse.
9. Press **Copy** button.
10. Selected waypoints are imported to the current route.

Reverse sailing order of a route

It is possible to reverse the whole route using button **Reverse** in Waypoint sheet.

Geometry check of route

When you added a new waypoint or modify position of it or change other data of waypoint, a message shown below may appear. It indicates that the geometry of route is impossible to sail for a vessel. Typically it is enough if you:

1. decrease the radius of turn of the waypoint or its neighbours
2. change lat/lon position of the waypoint or its neighbours

ROUTE OPTIMIZING

Impossible turn at WP 2

Ok

Optimization

Available Optimization strategies

After all waypoints are inserted the optimization is done in Parameters sheet. Optimization calculates all parameters for route steering (like: course and distance between two waypoints, manoeuvring start point, WOP etc.). There are four possibilities for optimization:

Max Speed:

Calculation uses the maximum speed defined in the ship parameters and multiplied by all reduction factors (weather, ICE, fouling etc.) together with speed limits given for each waypoint and gives a result of ETA.

Time Table:

Calculates the speed required in order to arrive in destination at required ETA. Maximum speed is never exceeded.

Max. Profit:

This calculation takes in account the fuel cost and the fixed cost of the ship and calculates the most profitable speed (highest profit per time unit).

Min. Cost:

This calculation takes in account the fuel cost and the fixed cost of the ship and calculates the speed which gives the minimum total cost.

How to optimize

In a Parameters sheet you can define Estimated Time of Departure (ETD) and desired number of waypoint for ETA. This ETA time is depending on optimization strategies.

1. Open parameters sheet.
2. Select desired optimization strategies from combo box in the **Optimize** field.

How to plan a speed profile

A speed profile is defined by general max. speed and optimize types. These values are given while planning a route. You can give Speed limit and optimize type in Parameters sheet and in waypoint sheet you can give min. and max. speed for each leg. The picture shown below demonstrates what influences have different optimize types and speed limits for a speed profile.

max speed (general)						17
wp	min speed	cost	profit	time table	max _speed	max speed
1	4	4,8	10,0	10,0	10	10
2	4	4,8	12,9	15,0	15	15
3	4	4,8	12,9	16,2	17	20
4	4	4,8	12,9	16,2	17	20
4	4	4,8	12,9	16,2	17	20
5	6	6,0	12,9	15,0	15	15
6	6	6,0	12,9	16,2	17	20
7	4	4,8	12,9	16,2	17	20
8	4	4,8	12,9	16,2	17 <td 20	
9	6	6,0	12,9	16,2	17	17
10	4	4,8	8,0	8,0	8	8

An Example of speed profile

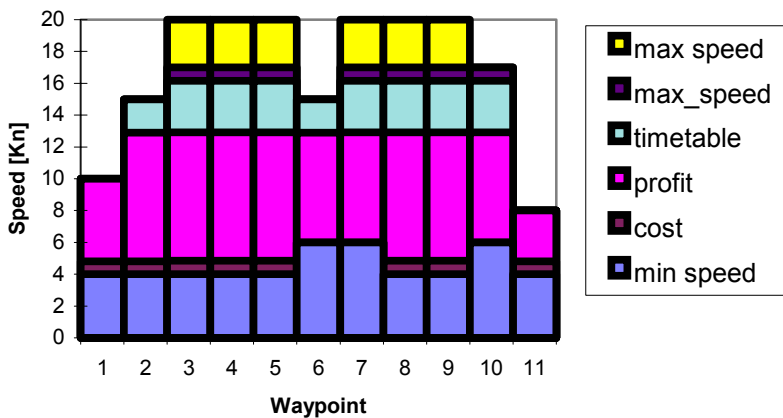

Backup to floppy

This procedure can be used to make backups of routes or to carry routes to other planning or navigation station. For more information, see "Backup to floppy" on page 315.

Restore from floppy

This procedure can be used to read backup copies of any route if some data is lost during Route Planning operations. The other usage is to read routes originating from other planning or navigation station. For more information, see "Restore from floppy" on page 315.

Move to planning or navigation station

For more information, see "Move to planning or navigation station" on page 315.

Read from planning or navigation station

For more information, see "Read from planning or navigation station" on page 316.

WP table report

This report is generated when you select **Report** from the menu and system opens Text View application automatically to view generated report. It is possible to print the report as follow:

1. From File menu select Print.
2. Report will automatically to be printed to default printer.

To close Notepad select Exit from File menu.

WP report consists information of:

- position of waypoints
- planned speeds
- planned courses
- distances between waypoints. Distance is not directly calculated from LAT and LON values of WP's location, but the distance is shorter distance compensated for planned radius for each waypoint.
- estimated times of arrival (ETA)
- planned fuel consumption
- total distance of route. Distance is not directly calculated from LAT and LON values of WP's location, but the distance is shorter distance compensated for planned radius for each waypoint.

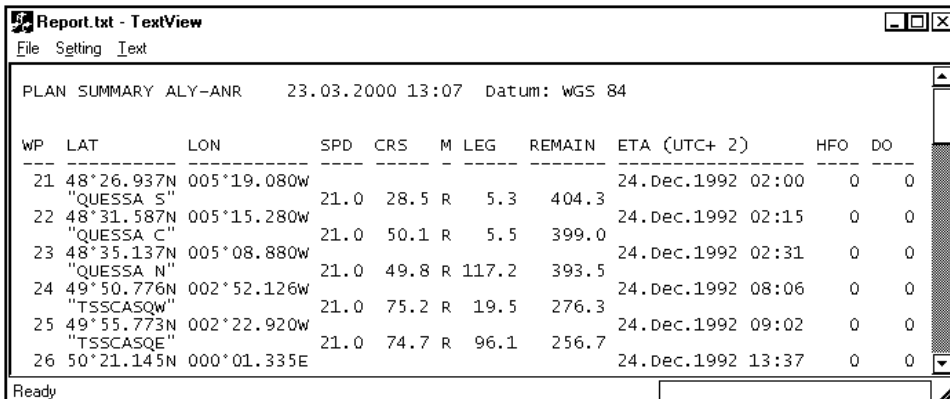

Report.txt - TextView
File Setting Text

PLAN SUMMARY ALY-ANR 23.03.2000 13:07 Datum: WGS 84

WP	LAT	LON	SPD	CRS	M	LEG	REMAIN	ETA (UTC+ 2)	HFO	DO
21	48°26.937N	005°19.080W	21.0	28.5	R	5.3	404.3	24.Dec.1992 02:00	0	0
	"QUESSA S"									
22	48°31.587N	005°15.280W	21.0	50.1	R	5.5	399.0	24.Dec.1992 02:15	0	0
	"QUESSA C"									
23	48°35.137N	005°08.880W	21.0	49.8	R	117.2	393.5	24.Dec.1992 02:31	0	0
	"QUESSA N"									
24	49°50.776N	002°52.126W	21.0	75.2	R	19.5	276.3	24.Dec.1992 08:06	0	0
	"TSSCASQW"									
25	49°55.773N	002°22.920W	21.0	74.7	R	96.1	256.7	24.Dec.1992 09:02	0	0
	"TSSCASQE"									
26	50°21.145N	000°01.335E						24.Dec.1992 13:37	0	0

Ready

How to change font of report

If printed area is too wide for page layout, you can change size and/or type of font:

1. Select **Font** from **Setting** menu .
2. Font dialog appears. Select desired options and press **OK**. (Recommended font is Fixedsys and size of font is 9).

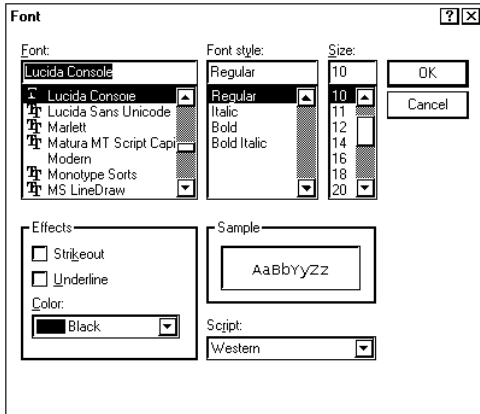

Full WP report

This report is generated to view with Windows Notepad application. For more information to print, to change size of font and to close Full WP report, see "WP table report" on page 249. This report consists following information (This sample is only part of report):

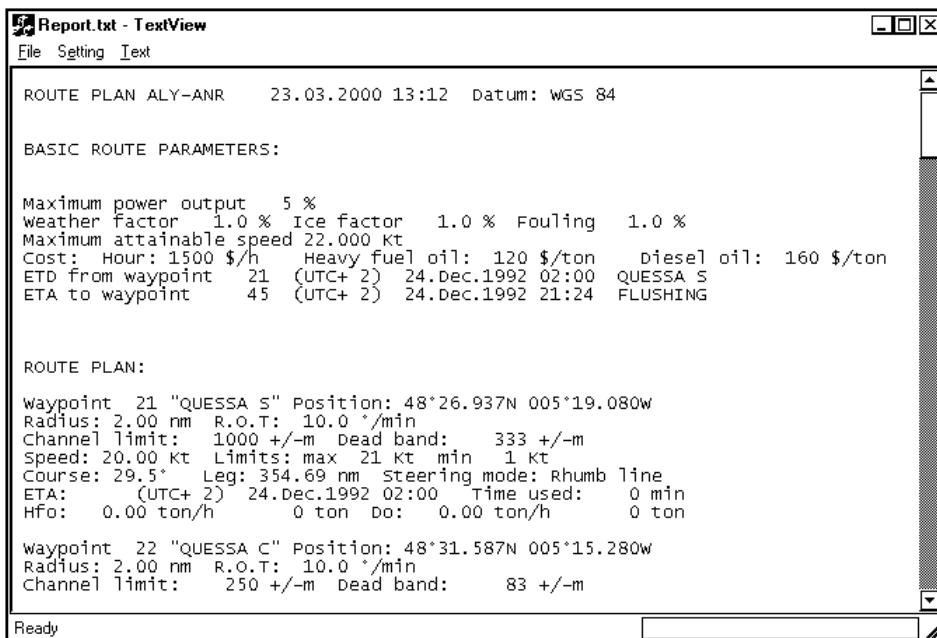

Passage Plan report

Passage Plan report is used to generate WP report with attached Pilot Data report. The system attaches automatically Pilot Data in Plan mode to Route Plan when you select the Passage Plan report. See below example where Passage Plan has been generated using a Route Plan "RTM-BRH" and a Pilot Data "RTM-BRH" in Plan modes.

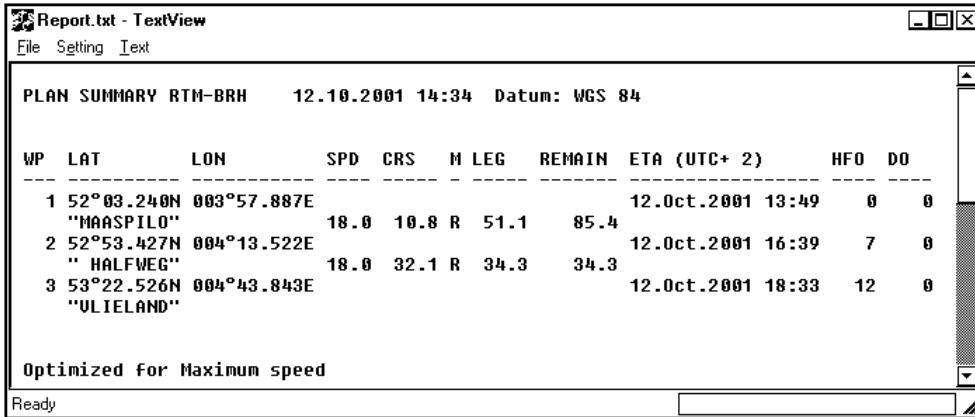

An example of WP Report

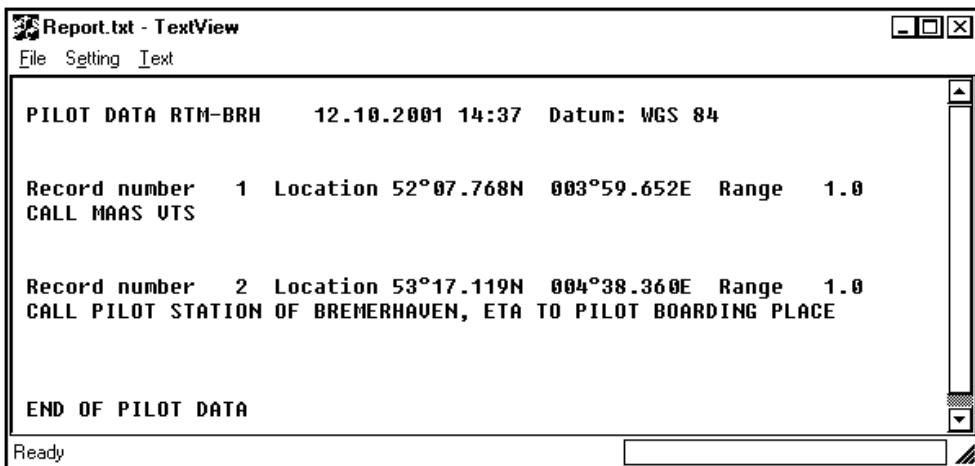

An example of Pilot Data Report

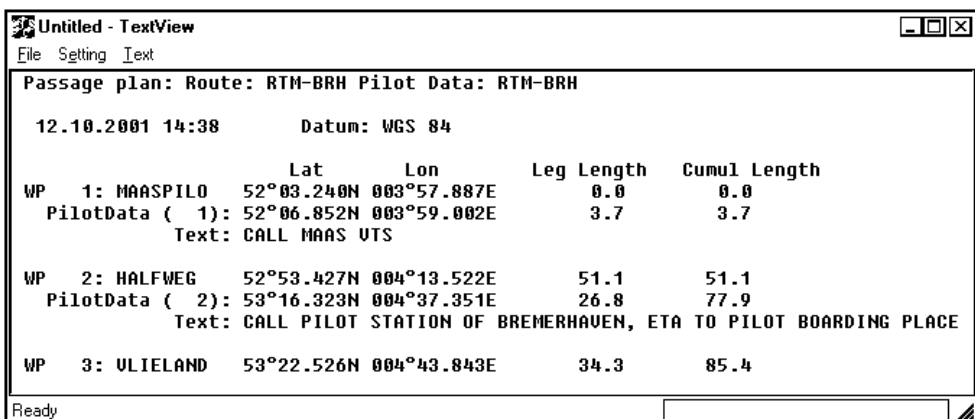

An example of Passage Plan Report. Pilot Data text notes are placed between waypoints based on their position (in which leg defined Pilot Data will be activated).

This page is intentionally left blank

Route monitoring

Introduction

The ROUTE MONITOR push button provides access to the functions for monitoring routes. Use of the ROUTE MONITOR is a means for permanent monitoring of the vessel's behaviour relative to the monitored route. The Information area displays the data on the vessel's position relative to the monitored route. The monitored route consists of following information in the electronic chart area:

- The route is displayed as red dots
- The limits of channels of each leg are displayed as red lines. These limits are used to detect Chart Alarms when you are monitoring the route. See also chapter "Chart Alarm calculation".
- Each leg has information about planned speed shown in rectangular
- Each leg has information about planned course to steer

NOTE! In order to display charts with correctly updated situation, use **always** current date as Approve Until and Display Until during your voyage. If your voyage lasts more than one week set current date at least once per week during your voyage.

For more information, see chapter "Date dependent and periodical features of S57 chart".

Operation of Route monitor push button is following:

1. When you press ROUTE MONITOR push button, **ROUTE MONITORING** dialog box will appear to Dialog box area.
2. If you already have **ROUTE MONITORING** dialog box on display and you press ROUTE MONITOR push button, you will get Route monitor menu on display.



Select:

You can select already existing route to be monitoring.

Cancel:

You can remove route from system use, which was selected to be monitored route.

Report:

You can generate a report of route in monitoring mode.

MONITOR ROUTE - TOKYO BAY / 03.02.2003 15:18

Monitoring Alarms Selections Waypoints

To WP 5 Max speed KISARAZU

ETA WP 8 ETA 04 Feb 03 12:05 URAGA Distance 15.6 nm

Final WP 9 ETA 04 Feb 03 12:12 PILOT Distance 18.0 nm

Suggested speed min Kt

Trial speed 0.0 Kt

Speed profile Plan

Center line Off for ARPA

Channel borders Off radar

Route Monitor window when connected ARPA radar is Selesmar. Note, that control for visibility of monitored route is in this window.

MONITOR ROUTE - TOKYO BAY / 03.02.2003 15:18

Monitoring Alarms Selections Waypoints

To WP 5 Max speed KISARAZU

ETA WP 8 ETA 04 Feb 03 12:05 URAGA Distance 15.6 nm

Final WP 9 ETA 04 Feb 03 12:12 PILOT Distance 18.0 nm

Suggested speed min Kt

Trial speed 0.0 Kt

Speed profile Plan

Route Monitor window when connected ARPA radar is Furuno of ARPA radar or ARPA radar which communicate using IEC 61162-1 standard. Note, that there is no control for visibility of monitored route in this window.

How to select route to be monitored

To select route to be monitored, proceed as follows:

1. Press **Route monitor** push button and choose **Select** command from the menu. Select Route monitoring dialog box appears.

Select

ROUTE MONITORING

HEL-STO

HESA-TST

TOKYO

2. In Route selection list box, highlight desired route and press **Select** to make selection.

Mon.Route TOKYO Plan Route

UserChart Ref Target

Route field looks as this when route TOKYO has been selected as monitored route.

NOTE, when you select a Route for monitoring, a message shown below may appear. It indicates that the geometry of route is impossible to sail for a vessel. Select the Route for planning and make modifications needed for it, for more information, see chapter "Geometry check of route" on page 246.

Select Route Monit

Route has an impossible turn

Ok

How to select To waypoint

When you have selected a route to be monitored the system selects next waypoint automatically. Check that To waypoint is desired one. The ECDIS will automatically advance to Next waypoint when you pass the To waypoint.

The ECDIS automatically set last waypoint of your monitored route as Final waypoint.

To select To waypoint, proceed as follows:

1. Press **Route monitor** push button to get Route monitor window.
2. Move cursor over the To WP box and press **Select** push button. Now you get a numeric keypad to enter the number of the To waypoint.
3. Define a suitable waypoint and press OK.

How to select Final waypoint

Normally you use as Final waypoint the last waypoint of your monitored route and the ECDIS automatically did this selection when you selected the monitored route. However sometime you may prefer to use as Final waypoint some other waypoint than the last waypoint of the monitored route.

To select final waypoint, proceed as follows:

1. Press **Route monitor** push button to get Route monitor window.
2. Move cursor over the Final WP box and press **Select** push button. Now you get a numeric keypad to enter the number of the Final waypoint.
3. Define a suitable waypoint and press OK.

How to view waypoint information

If you open Waypoints page on Route Monitor window, you can view listed waypoint information. This information is printed from route planning information made for this voyage.

"TO WP" and "NEXT WP" are indicated on this list.

MONITOR ROUTE - TOKYO BAY / 03.02.2003 15:18						
Monitoring		Alarms		Selections		Waypoints
WP	LAT	LON	SPD	CRS	M	
	NAME	Planned	ETA	(UTC+ 2)		
1	35°35.591'N	140°05.672'E				
	"PIER"		03 Mar 2003 02:15			
2	35°34.850'N	140°02.809'E	20.0	252.4	R	
	"CHIBA KO"		03 Mar 2003 02:22			
3	35°31.773'N	139°56.554'E	20.0	239.0	R	
	"PILOT"		03 Mar 2003 02:40			
4	35°29.950'N	139°51.450'E	20.0	246.4	R	
	"TOK WAN"		03 Mar 2003 02:54			
***** TO *****						
5	35°24.606'N	139°45.613'E	20.0	221.8	R	
	"KISARAZU"		03 Mar 2003 03:15			
***** NEXT *****						
6	35°19.743'N	139°42.461'E	20.0	208.0	R	
	"NA, NO A"		03 Mar 2003 03:31			

7	35°15.141'N	139°46.305'E	20.0	145.6	R	
	"UR SUI"		03 Mar 2003 03:48			
8	35°12.806'N	139°46.306'E	20.0	180.0	R	
	"URAGA"		03 Mar 2003 03:55			
9	35°10.471'N	139°46.784'E	20.0	170.5	R	
	"PILOT"		03 Mar 2003 04:02			

Display of the route on the electronic chart screen

To get monitored route to be displayed, make sure that desired options of the monitored route (Center Line, Channel Borders, Wp-marks, Leg marks and Wheel over line) are selected on the ROUTE -sheet.

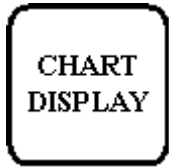

Press CHART DISPLAY push button. To select ROUTE sheet to be opened either press button



or go by cursor above ROUTE text and press SELECT.

Chart details - ALL-ON		
Chart	Standard	Other
Tracking	Mariner	Route
Monitored route		
Off	Std	Other
<input type="radio"/>	<input checked="" type="radio"/>	<input type="radio"/>
		Center line
<input type="radio"/>	<input type="radio"/>	<input checked="" type="radio"/>
		Channel borders
<input type="radio"/>	<input checked="" type="radio"/>	<input type="radio"/>
		WP - mark
<input type="radio"/>	<input type="radio"/>	<input checked="" type="radio"/>
		Leg mark
<input type="radio"/>	<input type="radio"/>	<input checked="" type="radio"/>
		Wheel over line

WP-marks enables display of waypoint's number in a route.

Leg marks enable display of planned speed and planned Course to Steer in a route.

Wheel over line enables display of line, which turn start line for a waypoint. This line appears when "WP approach" has given and disappears when turning has started.

Display of the route on the ARPA radar screen

ECDIS can control visibility of the monitored route on the ARPA radar screen in some selected ARPA radars such as Selesmar.

Some ARPA radars such as Furuno have this kind of controls in the ARPA radar operators panel.

Note that generic ARPA radars of IEC 61162-1 type of interface cannot display monitored route on their screen. Then these controls are not available on the ECDIS screen.

Center Line:

You can switch on/off center line to be displayed on the radar screens.

Channel Borders:

You can switch on/off channel borders to be displayed on the radar screens.

MONITOR ROUTE - TOKYOYAY / 03.02.2003 15:18			
Monitoring	Alarms	Selections	Waypoints
To	WP 5	Max speed	
KISARAZU			
ETA	WP 8	ETA	04 Feb 03 12:05
URAGA	Distance		15.6 nm
Final	WP 9	ETA	04 Feb 03 12:12
PILOT	Distance		18.0 nm
Suggested speed		min	Kt
Trial speed	0.0		Kt
Speed profile	Plan		
Center line	Off	for ARPA	
Channel borders	Off	radar	

Route assistant

The system has a build in Route assistant, which ease the safe use of Routes. During the Route Plan you can check your Route Plan for safe water and you can attach a User Chart and a Pilot Data which you intended to be used together with a Route Plan.

The assistant reminds you if

- you use a Route, which you have not Checked after the last change to your Route Plan
- you use a combination of a Route Plan, User Chart and Pilot Data, which you did not plan to be used together.

On Upper Status bar text Mon.Route turns red if conditions defined during Route Plan do not met conditions during Route Monitoring.

Following indications on **Monitoring** page may appear

"**This route has not been checked**" reminds you if no Route Planning Check has been done after the latest modification of Route.

Make Route Planning Check for the Route.

"**Checked conditions are different**" indicates that current conditions differ from set conditions of Route Plan.

You can use Alarms and Selections pages to set them as they were when route was planned.

On **Alarms** page text "*** = Current selection is different**" indicates which conditions are currently set differently as planned.

Press **Use** button to set conditions as planned to be monitored.

MONITOR ROUTE - TOKYOBYAY / 03.02.2003 14:48

Monitoring		Alarms		Selections		Waypoints	
To	WP 5						Max speed
KISARAZU							
ETA	WP 8	ETA	04 Feb 03 12:05				
	URAGA	Distance	15.6 nm				
Final	WP 9	ETA	04 Feb 03 12:12				
	PILOT	Distance	18.0 nm				
Suggested speed		min Kt					
Trial speed		5.3 Kt					
Speed profile		Plan					
Center line		Off for ARPA					
Channel borders		Off radar					
This route has not been checked							

MONITOR ROUTE - TOKYOBYAY / 03.02.2003 15:18

Monitoring		Alarms		Selections		Waypoints	
To	WP 5						Max speed
KISARAZU							
ETA	WP 8	ETA	04 Feb 03 12:05				
	URAGA	Distance	15.6 nm				
Final	WP 9	ETA	04 Feb 03 12:12				
	PILOT	Distance	18.0 nm				
Suggested speed		min Kt					
Trial speed		0.0 Kt					
Speed profile		Plan					
Center line		Off for ARPA					
Channel borders		Off radar					
Checked conditions are different							

MONITOR ROUTE - TOKYOBYAY / 03.02.2003 15:18

Monitoring		Alarms		Selections		Waypoints	
Planned as							
Ignore during monitoring							
Areas To Be Avoided							
Specially Protected Areas							
Traffic Separation Zone							
Indication during monitoring							
* User Chart Danger							
Alarm during monitoring							
Safety Contour							
* Caution Area							
Safety contour		* 8 m					
* = Current selection is different							

On **Selection** page text "**Current selection is different**" indicates if name of User Chart and/or Pilot Data in Monitor mode is not the same as Route Planning Check.

Press **Use** button to select User Chart and/or Pilot Data in Monitor mode.

Text "**This has been changed after Route Planning Check**" indicates if User Chart and/or Pilot Data has been modified after the latest Route Planning Check.

Make Route Planning Check for the Route with attached User Chart and/or Pilot Data.

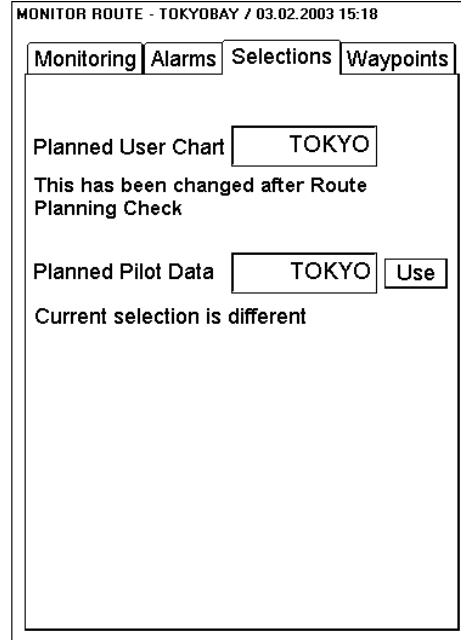
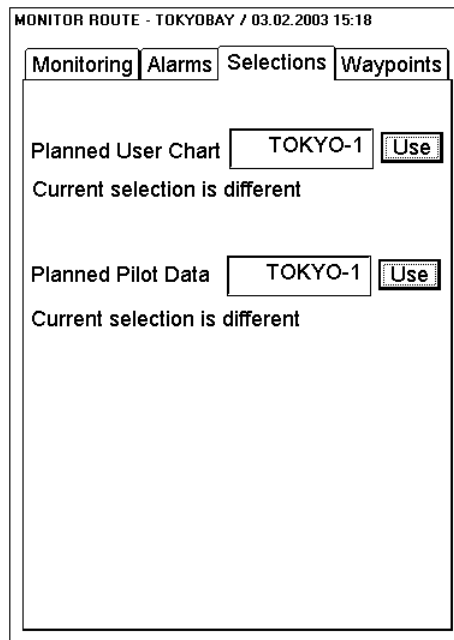

How to monitor route

You can monitor the route from the ECDIS screen. There are two boxes in the upper information area.

Plan Speed	20.0 Kt
Plan	216.9°
Route	216.8°
Ch limit	185 m
Off track	<32 m

Left window

- **Plan Speed**; planned speed to approach "To WP".
- **Plan**; planned course between previous and "To WP". NOTE; if gyro value is compensated and **Gyro error correction** and **Gyro error compensation** have been enabled in Navigation Parameters then text (**corr**) in red colour with **Plan** is displayed.
- **Route**; calculated set course to follow the Monitored route including off track, drift and gyro error compensation.
- **Ch limit**; planned width of channel to approach "To WP".
- **Off track**; perpendicular distance of the ship from the track.

Below an example with additional textual information

Plan Speed	20.0 Kt
Plan	248.0°
Route	256.7°
Ch limit	185 m
Off track	<247 m
Goto WP	
Out of Gate	

Additional textual information is available if any of following steering mode is in use:

- "Goto WP", "GotoWP Great circle", "Ass. Turn enabled" and "Assisted turn" in Goto Waypoint mode
- "Goto Track", "Track Great circle", "Track Turn" in Go Track mode

Permanent alarms are available regardless of the used steering mode:

- "Outside channel" is indicated by red colour of the "Off track" value and by orange text
- "Out of gate" is indicated by orange text. Out of gate indicates that, if the vessel continues using the current course, then the vessel will be outside of the channel at wheel over point.

To WP	3
Dist WOP	2.55 nm
Time	06:36
Next WP	4
Next	228.4°
Turn rad	1.0 nm
Turn rate	22°/min

Right window

- **To WP**; the waypoint which the ship is approaching.
- **Dist WOP**; distance to the point where rudder order for course change at "To WP" will be given.
- **Time**; time left to WOP (dd:hh:mm:ss).
- **Next WP**; the wp following the "To WP".
- **Next**, planned course to steer after "To WP". NOTE; if gyro value is compensated and **Gyro error correction** and **Gyro error compensation** have been enabled in Navigation Parameters then text (**corr**) in red colour with **Next** is displayed.
- **Turn rad**; planned turning radius at "To WP".
- **Turn rate**; calculated rate of turn which bases on current speed and planned turning radius.

How to ask ETA

Estimated time of arriving to a waypoint is calculated by the ECDIS. In Route Monitor dialog box user can select waypoint number and speed profile for calculation.

ETA WP:

Indicates number of special ETA waypoint and estimated time and distance to it.

Final WP:

Indicates number of Final waypoint and estimated time and distance to it.

Monitored route is optimized to Max Speed.

MONITOR ROUTE - TOKYO BAY / 04.09.2001 08:08

Monitoring Alarms Selections Waypoints

To
WP 5 Max speed
KISARAZU

ETA
WP 8 ETA 04 Feb 03 12:05
URAGA Distance 15.6 nm

Final
WP 9 ETA 04 Feb 03 12:12
PILOT Distance 18.0 nm

Suggested speed min Kt

Trial speed 12.0 Kt

Speed profile Plan

Center line Off for ARPA

Channel borders Off radar

Speed profile:

There are 3 calculation strategies:

- **Plan;** the system calculates with optimization made in Route Planning mode.
- **Trial;** you can enter speed to test ETAs with different speeds.
- **Current;** system calculates ETAs using average speed of last five minutes. **Note**, if Speed Profile is selected as Current, own ship average speed (i.e. speed for calculation) is displayed in Trial speed box.

Trial speed:

You can enter desired speed for calculation of ETA to waypoint.

Speed profile is changed to Trial speed. You can enter Trial speed and system will calculate ETAs.

MONITOR ROUTE - TOKYO BAY / 04.09.2001 08:08

Monitoring Alarms Selections Waypoints

To
WP 5 Max speed
KISARAZU

ETA
WP 8 ETA 04 Feb 03 15:03
URAGA Distance 19.8 nm

Final
WP 9 ETA 04 Feb 03 15:15
PILOT Distance 22.2 nm

Suggested speed min Kt

Trial speed 15.0 Kt

Speed profile Trial

Center line Off for ARPA

Channel borders Off radar

Time table optimization displayed in Route monitoring.

MONITOR ROUTE - TOKYO BAY / 04.02.2003 13:08

Monitoring | Alarms | Selections | Waypoints

To WP 5 Timetable
KISARAZU

ETA WP 8 ETA 04 Feb 03 14:45
URAGA Distance 19.8 nm

Final WP 9 ETA 04 Feb 03 14:59
PILOT Distance 22.2 nm

Plan 04 Feb 03 15:50
Off plan 50 min
Suggested speed 9.2 Kt
Trial speed 0.0 Kt
Speed profile Plan
Center line On for ARPA
Channel borders Off radar

Plan final:

It is displayed ETA final WP. This value has been given in route planning mode in Parameters sheet.

Off Plan:

Indicates time difference between planned ETA and calculated ETA to final WP.

Suggested speed:

The system calculates suggested speed so that ETA final WP would be same as planned ETA if type of optimization was Time table.

Table below shows how the system calculates ETAs:

Type of selected speed profile / optimization on Route Monitor Window	Used speed from current point to the To wp	Used speed from the To WP to the final wp
Speed profile: Plan MAX SPEED	current average speed	planned leg speed
Speed profile: Plan TIMETABLE	current average speed	planned leg speed
Speed profile: Plan ECO: COST	current average speed	planned leg speed
Speed profile: Plan ECO: PROFIT	current average speed	planned leg speed
Speed profile: Trial	current trial speed	current trial speed
Speed profile: Current	current average speed	current average speed

Route monitoring related alarms

Following alarms are related to route monitoring:

2052 Route: Illegal ETA WP, which will appear when the system cannot use the selected ETA waypoint. The reason might be corrupted or missing route file.

2053 Route: Illegal To WP, which will appear when the system cannot use the selected "To WP". The reason might be corrupted or missing route file.

2054 Route: Illegal final WP, which will appear when the system cannot use the selected final waypoint. The reason might be corrupted or missing route file.

2060 Route: WP change disabled, which will appear when the you try to change next or final waypoint while the system is in automatic Route Steering. Leave automatic Route Steering and change then the waypoint.

2063 Route: Select disabled, which will appear when the you try to select a new route for Route Monitoring while the system is in automatic Route Steering. Leave automatic Route Steering and select then a new route.

2064 Route: Cancel disabled, which will appear when the you try to cancel current Monitored Route while the system is in automatic Route Steering. Leave automatic Route Steering and cancel then the current route.

2454 Route: End reached, which will appear when the own ship passes the last waypoint. The system cancel current Route Monitoring. Normally this alarm appears only, if alarm 2458 is left unacknowledged.

2457 Route: Outside chl limits alarm, which will appear if the own ship is outside the monitored channel.

Following alarms are related to route monitoring when automatic Route Steering is not used:

2451 Route: WP approach alarm, which will appear when the own ship arrives within selectable time to wheel over point of the next waypoint

2458 Route: Last WP approach alarm, which will appear when the own ship arrives within selectable time to the final waypoint. Acknowledgement of this alarm cancels current Route Monitoring.

User chart control

Introduction

User charts are simple overlay charts which the user has made for his own purposes. They can be displayed on both radar screen and electronic chart on ECDIS display. These charts are intended for highlighting safety related things like position of important navigation marks, safe area for the ship etc. User Charts areas can be used to activate alarms and indications based on user defined danger symbols, lines and areas. When route or own ship estimated position is going to across User Chart symbol, line or area which is defined as a dangerous one, an alarm or indication is generated by the system. See chapter "Chart Alarm calculation".

A user chart consists of points, lines and letter/number symbols etc. A user chart contains max. 4000 lines and 2000 symbols (letters and numbers). The user chart is displayed on the radar display and its position and shape is based on the vessels actual position. When own ship is moving in the area covered by the user chart the elements of the user chart are superimposed on the radar picture with max 80 nearest elements displayed. The user charts can also be shown on ECDIS display. In this way the radar display can be kept as "clean" as possible for radar target detection.

Objects of User Chart

Different symbols and segments used in an User Chart:

- **Line:** You can define four different type of lines. Lines can be use to Chart Alarm calculation and/or display on radar:
 - **Navigation lines:** Displayed on both displays (radar + ECDIS). Navigation lines are reference lines for coast line.
 - **Coast line:** Displayed on ECDIS screen only. Coastal line is usually well defined (by chart digitizer) multisegment line showing the coast line. User is able to create this type of line in case of there is no suitable chart available over desired area in ARCS format or in S57 format.
 - **Depth contour:** Displayed on ECDIS screen only. Depth line shows the selected depth levels. User is able to create this type of line in case of there is no suitable chart available over desired area in ARCS format or in S57 format.
 - **Route line:** Displayed on both displays (radar + ECDIS). Route lines are zones for anchoring and traffic separation lines etc.
- **Area:** User can define closed areas, which the system can use to detect safe water areas. If route or estimated ship position is going to across the area, system is able to give warning to user. These areas can be used to specify safe areas as defined by the master or by the policy of the shipowner. They are always available regardless of the S57 or ARCS chart material used.
- **Symbols:** User selectable, symbols can be displayed on both displays or on ECDIS display only. Symbols are used to indicate buoys, light houses, fixed targets, wrecks etc. Symbols can be use to Chart Alarm calculation.
- **Tidals:** Displayed on ECDIS screen only. Tidals can be used to make own notes about tide at user defined points.
- **Points:** It doesn't itself have any symbol on radar screen, but it is a very important element of a User chart. See chapter "What is a User Chart Point and for which purpose it is used ?" on page 266.

Modes of User Chart

An User Chart can be selected for Monitor mode, which means that User Chart is displayed on connected ARPA radar display and it can be used for Chart Alarm calculation. Another mode is for modifying the User Chart Plan mode. In the Plan mode the User Chart is only displayed on ECDIS screen without displaying it on connected ARPA radar or without using it for Chart Alarm calculation. It is possible to have both the Monitored and Planned User Chart at the same time. Eventually the Monitored and Planned User Charts copy the operation of Monitored and Planned Routes. Below is an example how to know which User Chart is used Monitor mode and which one is in Plan mode.

Monitor mode

A)

Mon.Route	Plan
UserChart URAGA-TO	Ref

B)

MONITOR USER CHART - URAGA-TO / 18.04.2001 13:49				
Point	Line	Area	Symbol	Tidal
Current	1	Total	6	
Name	Position			
NO 1	Lat	46°28.083N		
	Lon	045°10.992E		
First	<<	>>	Last	
<input type="checkbox"/> Enable changes	Displayed			

Plan mode

A)

Mon.Route	Plan
UserChart URAGA-TO	Ref

B)

PLAN USER CHART - SOU-BRH / 12.09.2000 11:14				
Point	Line	Area	Symbol	Tidal
Current	1	Total	3	
Name	Position			
	Lat	50°52.804N		
	Lon	001°23.365W		
First	<<	>>	Last	
Add	Import	Delete		
<input type="checkbox"/> Enable changes	Displayed			

On Upper Status bar the UserChart field show always the name of the User Chart selected for Monitor mode. If the displayed User Chart on the ECDIS screen is the Monitored User Chart, then the text "UserChart" on Upper Status bar is in black (See example "Monitor mode A"). If the displayed User Chart on the ECDIS screen is the Planned User Chart, then the text "UserChart" on Upper Status bar is in red (See example "Plan mode A"). The name of the Planned User Chart is only available in the window for Plan mode of User Chart (See example "Plan mode B").

Operation of User Chart push button is following:

1. When you press USER CHART push button, **USER CHART** dialog box will appear to Dialog box area.
2. When you press USER CHART push button again, you will get User chart menu on display.

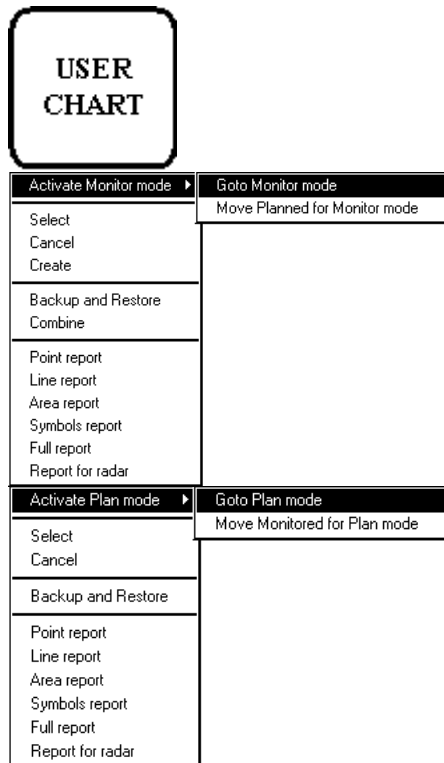

Activate Monitor/Plan mode:

User can switch User Chart mode between Plan and Monitor modes. Using **Activate Monitor mode>Goto Monitor mode**, User Chart used in Planning mode can be switched directly to Monitor mode and using **Activate Plan mode>Goto Plan Mode**, User Chart used in Monitoring mode can be switched directly to Plan mode.

Select:

User can select User Chart to be used either Monitor or Plan mode.

Cancel:

Cancel is used to remove User Chart from active use.

Create:

User can create a new User chart.

Backup and Restore:

User can make backup copy of User chart or restore User Chart from backup device.

Combine:

User can join two or more User Charts together.

Point report:

This function generates report from Points of User chart.

Line report:

This function generates report from lines of User chart.

Area Objects report:

This function generates report from area objects of User chart.

Symbols report:

This function generates report from symbols of User chart.

Full report:

This function generates report from all the objects of User chart.

Report for radar:

This function generates report from all the objects of User chart, which are displayed on radar screen.

What is a User Chart Point and for which purpose it is used ?

Point is a center point for sub chart inside a User Chart. Sub charts are small enough to be sent for radar display (max 80 elements). Subcharts are made with post processing, which is performed automatically, when you leave editing (i.e. you remove Enable Changes tick box), you close User Chart window with Cancel pushbutton or you select a User Chart from menu.

The system doesn't require any Point if the amount of lines intended for ARPA radar display is less than 60 and if the amount of symbols intended for ARPA radar display is less than 20. Note than lines are counted both from line and area objects.

If the User Chart has more than 60 lines or 20 symbols and if the User Chart does not consist any Points, the system will generate following alarm when you select the User Chart in use **"2101 UserChart: Need Points"**. It reminds you that only a part of your lines will be visible in the connected ARPA radar, if you don't define Points.

The symbol used for points is box with "I" inside: 

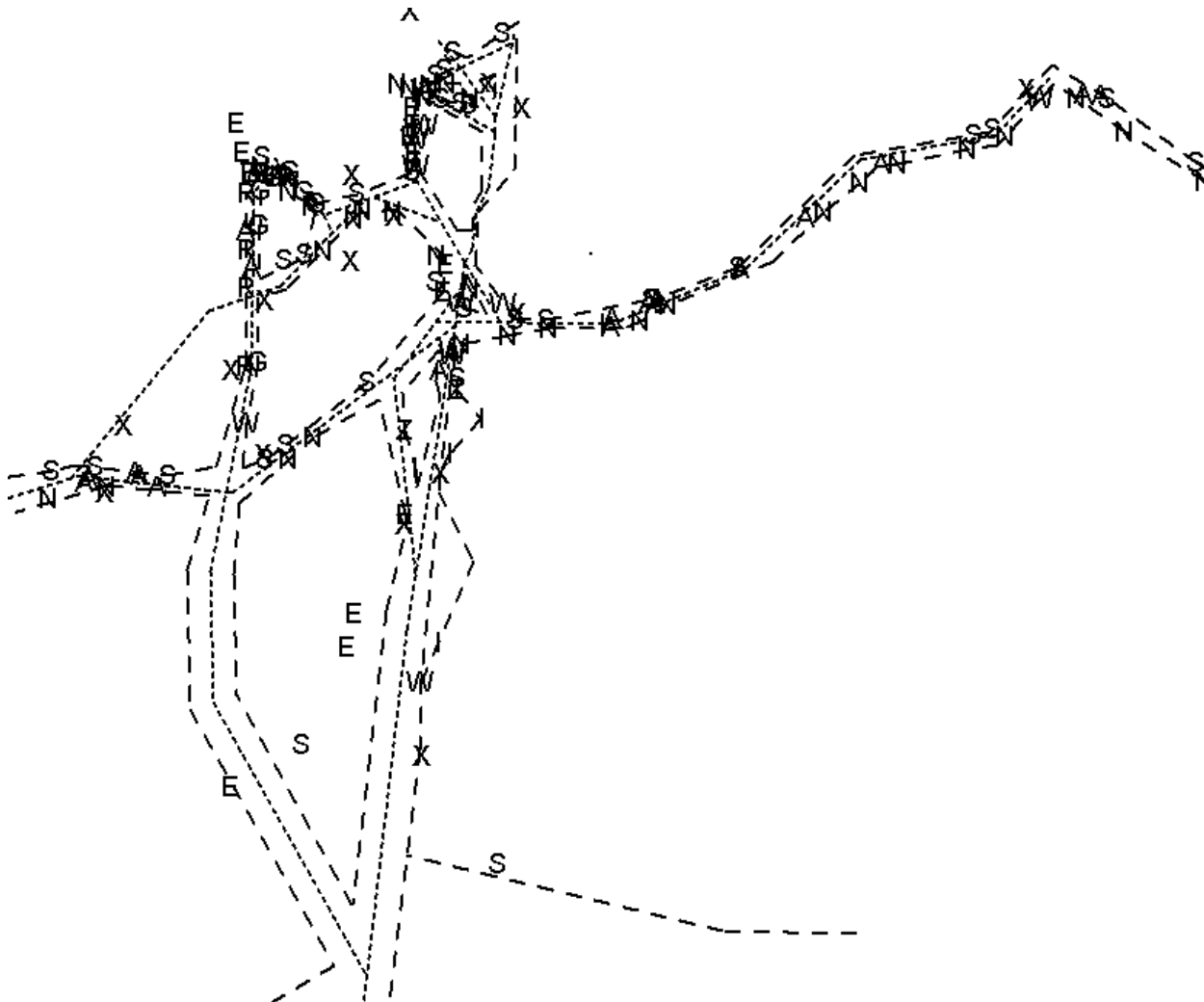

Above is an example of a complex User Chart with several hundreds of lines and symbols. The ARPA radar can display at same time 60 lines and 20 symbols from the complete User Chart. Points are used to create sub-charts for ARPA radar use. Each point can collect 60 nearest lines and 20 nearest symbols in a sub-chart.

Below are some examples of sub-charts from the above example. Note the position used for points to collect the sub-charts.

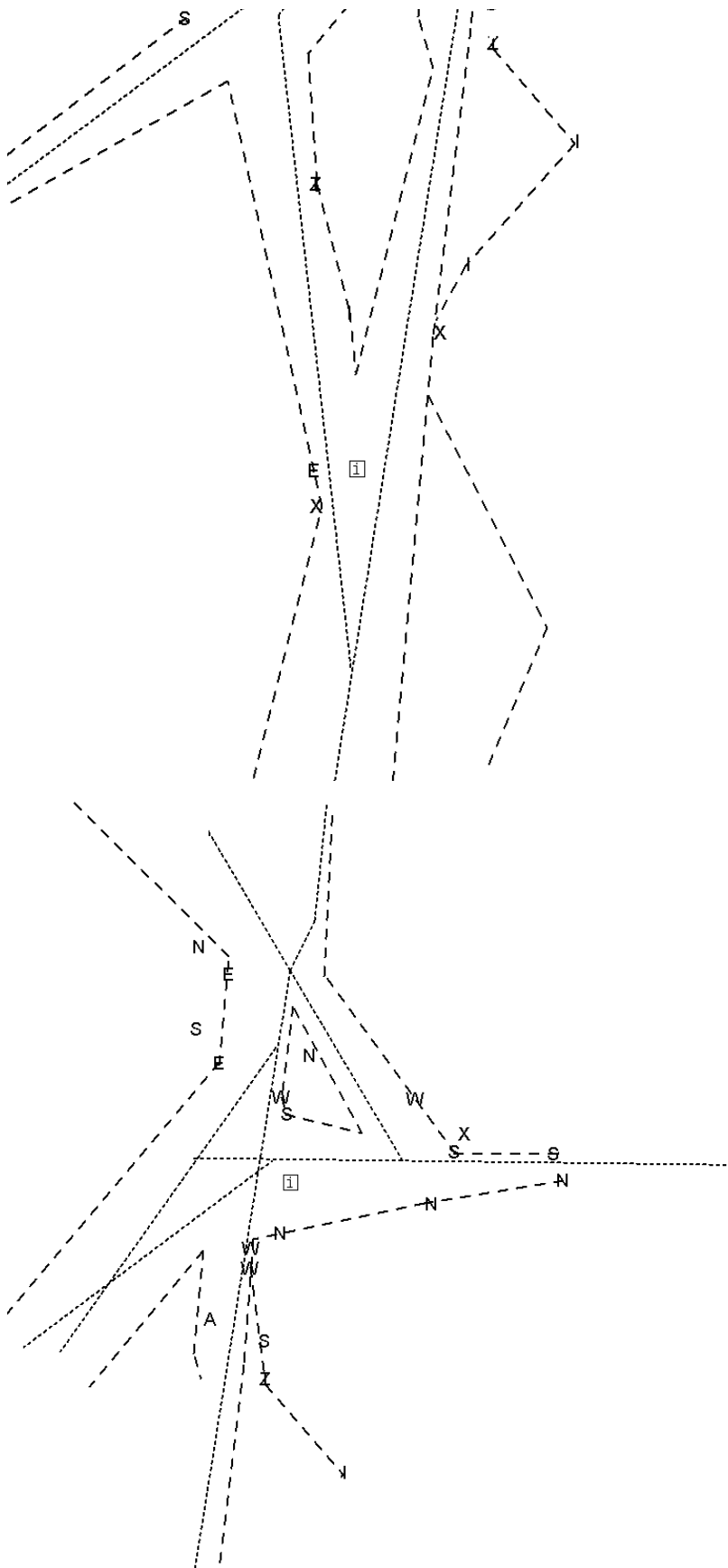

Select datum

Selection of datum is very important, if you manually enter latitude-longitude positions from the control panel or keyboard or if you use digitizer. If you only operate with cursor to add and to modify waypoint locations, then you could use any datum, although it is recommended to use native datum of the chart. For more information to select datum, see chapter "Datum".

How to select User Chart for Monitor mode

User Chart which is selected for Monitor mode is displayed on Upper status bar in field of User Chart. If text of User Chart on Upper right hand corner is red it is an indication that the Workstation is currently Displaying the User Chart for Plan mode. To activate Monitor mode and select User Chart for Monitor mode, proceed as follows:

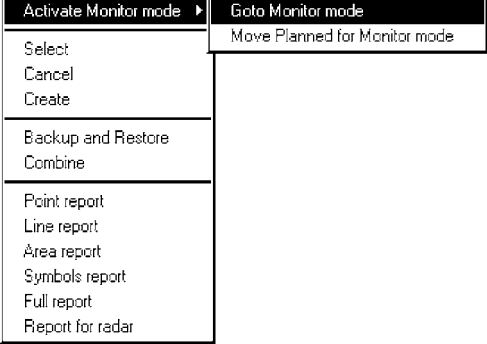
1. 

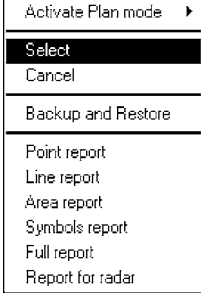
2. 

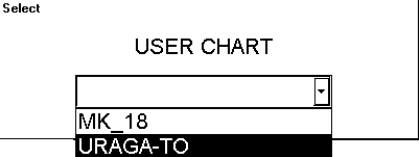
3. 

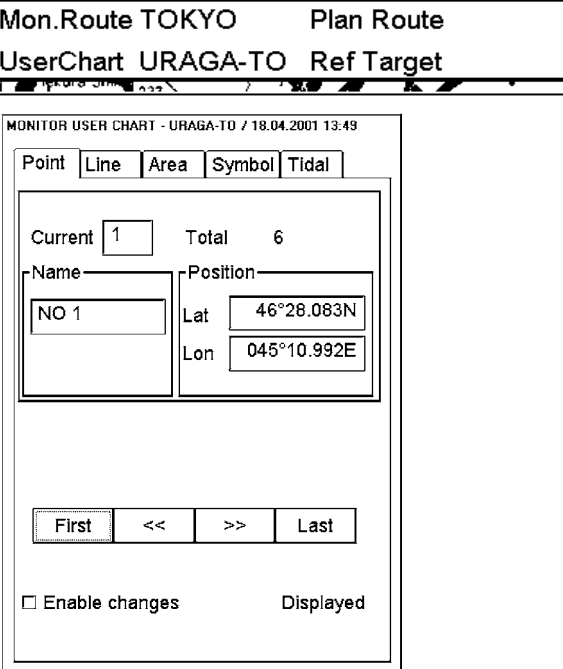
4. 

1. Press **USER CHART** button and select **Activate Monitor mode> Goto Monitor mode**. (If you already have desired User Chart in Plan mode, you can use **Activate Monitor mode> Move Planned for Monitor mode** to select it for Monitor mode and you can continue from step 4).
2. Press **User Chart** push button and select from menu **Select**.
3. User Chart list box appears to the dialog box area. Highlight desired User chart to select it.
4. User Chart will be loaded to System use and it is displayed on the Electronic chart area. For more information about control User chart display, see Chapter "Details of chart display".

How to select User Chart for Plan mode

If text of User Chart on Upper right hand corner is black it is indication that the Workstation is in Monitor mode for User Chart. To activate Plan mode and select User Chart for Plan mode, proceed as follows:

1. **Activate Plan mode** > **Goto Plan mode**
 Select
 Cancel
 Backup and Restore
 Point report
 Line report
 Area report
 Symbols report
 Full report
 Report for radar

2. **Activate Monitor mode** >
Select
 Cancel
 Create
 Backup and Restore
 Combine
 Point report
 Line report
 Area report
 Symbols report
 Full report
 Report for radar

3. **Select**
USER CHART
 [List Box]
SOU-BRH
URAGA-TO

4. **Mon.Route TOKYO** **Plan Route**
UserChart URAGA-TO **Ref Target**

PLAN USER CHART - SOU-BRH / 12.09.2000 11:14
 Point Line Area Symbol Tidal
 Current 1 Total 3
 Name [] Position
 Lat 50°52.804N
 Lon 001°23.365W
 First << >> Last
 Add Import Delete
 Enable changes Displayed

1. Press **USER CHART** button and select **Activate Plan mode**> **Goto Plan mode**. (If you already have desired User Chart in Monitor mode, you can use **Activate Plan mode**> **Move Monitored for Plan mode** to select it for Workstation use and you can continue from step 4. NOTE, when using this command User Chart is removed from Monitor mode).
2. Press **User Chart** push button and select from menu **Select**.
3. User Chart list box appears to the dialog box area. Highlight desired User chart to select it.
4. User Chart will be loaded to Plan mode and it is displayed on the Electronic chart area. For more information about control User chart display, see Chapter "Details of chart display".

How to create User Chart

You can create and modify an User Chart when you have select Plan mode of User Chart.

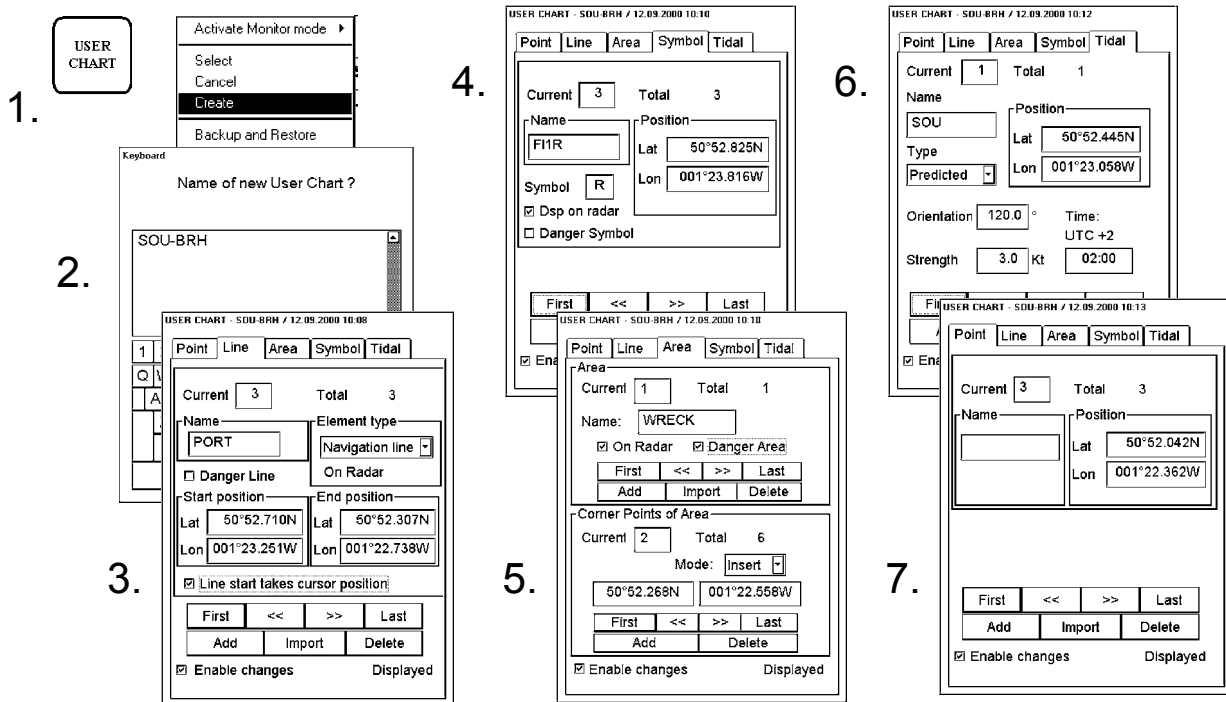

Note:

If you want User chart to be displayed on the electronic chart make sure, that **Points, Symbols & Tidals, Lines and Areas of User chart** are selected in **Mariner** sheet.

To make a complete User Chart, proceed as follows:

1. Press twice USER CHART button. Select **Create** from the menu.
2. Enter a name for User Chart using Keypad dialog box and press OK.
3. Open **Line** page of User Chart. Use Cursor and SELECT button to define location of start point of line. Define **Name** and **Element type** for line. Use cursor and SELECT button to design shape of lines. To start new line from new position select **Line start takes cursor position**. Option "Danger Line" enables it to be used in ChartAlarm calculation.
4. Open **Symbol** page of User Chart. Use Cursor and SELECT button to define location of Symbol. Define **Name** and used **Symbol**. Option "Dsp on radar" is automatically selected. Option "Danger Symbol" enables it to be used in ChartAlarm calculation.
5. Open **Area** page of User Chart. To make a new area, press Add button in Area -field. Define **Name** for area, define also if it is displayed on Radar display (**On Radar**) and used in Chart Alarms calculation (**Danger Area**). Use Cursor and SELECT button to define location Corner Points of Area.
6. Open **Tidal** page of User Chart. Use Cursor and SELECT button to define location of Tidal symbol. Define **Name, Type, Orientation, Strength** and **Time** for Tidal. The Tidal symbol is displayed only on ECDIS display.
7. Open **Point** page of User Chart. Use Cursor and SELECT button to define location of Points.

Introduction of Point sheet

To select between Point, Symbol, Line,, Area and Tidal sheets to be opened either press



or go by cursor above Point, Symbol, Line, Area or Tidal text and press SELECT button

USER CHART - URAGA-TO / 03.09.1999 09:40

Point Line Area Symbol Tidal

Current 3 Total 6

Name Position

NO 1 Lat 35°29.566N

Lon 139°52.481E

First << >> Last

Add Import. . . Delete

Enable changes Displayed

Enable changes:

User has to select this in order to modify User Chart.

Note! You are able to modify User Chart when **Head Up** or **Route Up** orientation is selected to be used.

Current:

It is indicated number of current Point in this field.

Total:

Total indicates total number of Points.

Name:

User can give name to current point.

Lat:

User is able to enter to edit box latitude of Point.

Lon:

User is able to enter to edit box longitude of Point.

Add:

This function adds new record next to current record with the same information.

Delete:

This function deletes current record of Point.

Import:

User is able to select from the list a User Chart to import into current Point list.

First, Last:

Pushing this control user gets first or last point of the file.

>>, <<:

Pushing this control user gets next or previous point of the file.

Introduction of Symbol sheet

To select between Point, Symbol, Line, Area and Tidal sheets to be opened either press button



or go by cursor above Point, Symbol, Line, Area or Tidal text and press SELECT

USER CHART - URAGA-TO / 03.09.1999 09:43

Point	Line	Area	Symbol	Tidal
-------	------	------	--------	-------

Current	1	Total	87
Name	DAISAN-K		
Position	Lat 35°17.087N Lor 139°44.459E		
Symbol	X		
<input checked="" type="checkbox"/> Dsp on radar			
<input checked="" type="checkbox"/> Danger Symbol			

First	<<	>>	Last
Add	Import	Delete	

Enable changes Displayed

Enable changes:

User has to select this in order to modify User Chart.

Note! You are able to modify User Chart when **North Up** or **Course Up** orientation is selected to be used.

Current:

It is indicated number of current Symbol in this field.

Total:

Total indicates total number of symbols.

Name:

User can give name to current symbol.

Lat:

User is able to enter to edit box latitude of symbol.

Lon:

User is able to enter to edit box longitude of symbol.

Symbol:

User can choose desired symbol. If you left this field blank, in chart area is displayed text entered Name field.

Dsp on radar:

If selected, symbols are displayed also on radar screen.

Danger Symbol:

User can select if the symbol is part of Chart Alarm calculation.

Add:

This function adds new record to end of Symbol list

Delete:

This function deletes current record of symbol.

Import:

User is able to select from the list of User Chart to import to current symbol file.

First, Last:

Pushing this control user gets first or last symbol of the file.

>>, <<:

Pushing this control user gets next or previous symbol of the file.

Introduction of Line sheet

To select between Point, Symbol, Line, Area and Tidal sheets to be opened either press button



or go by cursor above Point, Symbol, Line, Area or Tidal text and press SELECT

USER CHART - URAGA-TD / 03.09.1999 09:43

Point Line Area Symbol Tidal

Current 12 Total 14

Name URAGA Element type Navigation lin
On Radar

Danger Line

Start position End position

Lat 35°29.866N Lat 35°28.319N

Lon 139°51.406E Lon 139°49.857E

Line start takes cursor position

First << >> Last

Add Import Delete

Enable changes Displayed

Enable changes:

User has to select this in order to modify User Chart.

Note! You are able to modify User Chart when **North Up** or **Course Up** orientation is selected to be used.

Current:

It is indicated number of current line in this field.

Total:

Total indicates total number of lines.

Name:

User can give name to current line.

Element type:

User can choose appropriate line type from combo box. Available types are:

- Navigation line
- Route line
- Depth contour
- Coast line

Navigation and Route lines are part of lines displayable also on ARPA radar screen. Depth contours and Coast lines are visible only on ECDIS screen.

Danger Line:

User can select if the line is part of Chart Alarm calculation.

Start lat:

User is able to enter to edit box latitude of line's starting point.

Start lon:

User is able to enter to edit box longitude of line's starting point.

End lat:

User is able to enter to edit box latitude of line's ending point.

End lon:

User is able to enter to edit box longitude of line's ending point.

Line start takes cursor position:

If selected, user can draw a new line so that he can select position of line's starting point freely. If it is not selected line will be connected to previous line.

Add:

This function adds new record next to current record. User can either edit position by entering new co-ordinates or by showing new location with the trackball and select pushbutton.

Import:

User is able to select from the list of User Chart to import to current line file.

Delete:

This function deletes current record of line.

First, Last:

Pushing this control user gets first or last line of the file.

>>, <<:

Pushing this control user gets next or previous line of the file.

Introduction of Tidal sheet

To select between Point, Symbol, Line, Area or Tidal sheets to be opened either press button



or go by cursor above Point, Symbol, Line, Area or Tidal text and press SELECT

USER CHART - URAGA-TO / 03.09.1999 09:40				
Point	Line	Area	Symbol	Tidal
Current	<input type="text" value="1"/>	Total	<input type="text" value="1"/>	
Name	<input type="text" value="TOKYO"/>	Position		
		Lat	<input type="text" value="35°22.479N"/>	
Type	<input type="text" value="Predicted"/>	Lon	<input type="text" value="139°44.707E"/>	
Orientation	<input type="text" value="165.0"/>	Time:	UTC +3	
Strength	<input type="text" value="3.0"/>	Kt	<input type="text" value="09:00"/>	
First	<<	>>	Last	
Add	Import. . .	Delete		
<input checked="" type="checkbox"/> Enable changes			Displayed	

Enable changes:

User has to select this in order to modify User Chart.

Note! You are able to modify User Chart when **North Up** or **Course Up** orientation is selected to be used.

Current:

It is indicated number of current Tidal in this field.

Total:

Total indicates total number of Tidal in User Chart.

Name:

User can give name to current Tidal.

Lat:

User is able to enter to edit box latitude of tidal.

Lon:

User is able to enter to edit box longitude of tidal.

Type:

User can select type of tidal

Orientation, Strength and Time:

User can enter speed, course and time for tidal. Note that time of the tidal is always in local time.

Add:

This function adds new record next to current record.

Delete:

This function deletes current record of tidal.

Import:

User is able to select from the list of User Chart to import to current tidal file.

First, Last:

Pushing this control user gets first or last tidal of the file.

>>, <<:

Pushing this control user gets next or previous tidal of the file.

Introduction of Area Sheet

To select between Point, Symbol, Line, Area or Tidal sheets to be opened either press button



or go by cursor above Point, Symbol, Line, Area or Tidal text and press SELECT

USER CHART - htest / 06.09.1999 15:41

Point	Line	Area	Symbol	Tidal
-------	------	------	--------	-------

Area

Current Total

Name:

On Radar Danger Area

First	<<	>>	Last
-------	----	----	------

Add	Import	Delete
-----	--------	--------

Corner Points of Area

Current Total

Mode:

60°10.658N	025°02.059E
------------	-------------

First	<<	>>	Last
-------	----	----	------

Add	Delete
-----	--------

Enable changes Not Displayed

Enable changes:

User has to select this in order to modify User Chart.

Note! You are able to modify User Chart when **North Up** or **Course Up** orientation is selected to be used.

Area Object:

When user define an area for User Chart first he adds an area object and then gives a name and selects if it is displayed on radar and/or if it is used for safe water calculation (Danger Area).

Current:

It is indicated number of current area in this field. User can select area by editing desired number in edit box or create new one.

Total:

Total indicates total number of areas.

Name:

User can give name to current area.

On Radar:

User can select if the boundary line of the area is also displayed on ARPA radar display.

Danger Area:

User can select if the area is part of Chart Alarm checks.

Corner Points of Area:

After you have defined an Area Object, you can define corner points of the Area object.. Default mode for a new area without any corner points is Insert, which allow immediate entry of corner points. Other available modes are:

- **Select**, you can pick up existing corner point for viewing information of it.
- **Insert**, you can add a new corner point to most close edge of area. See figure below.
- **Append**, you can add a new corner point to latest edge of area. The latest edge is shown as dashed line. See figure below.

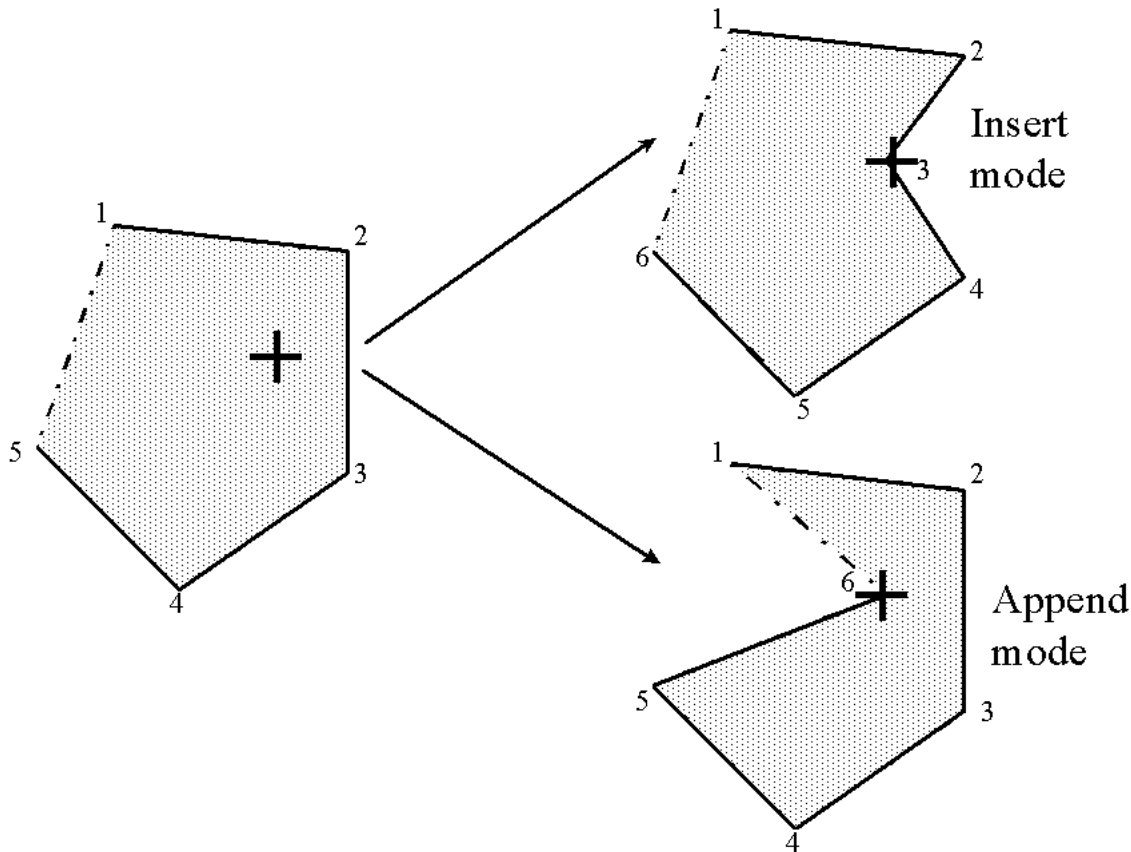

Difference between Insert and Append modes. There is an original area in left side and upper area is after adding a corner point using Insert mode and lower area is after adding a corner point using Append mode.

The **Insert mode** adds a corner point to the closest edge of area. The **Append mode** adds a corner point after last corner point.

How to add a new Area of User Chart

An Area of User Chart can be used for example to define safe water area displaying on the ARPA radar. To add a new User Chart Area proceed as follows:

1. Open Area sheet. Select tick box **Enable changes**.
2. Press **Add** button in **Area object** field.
3. Give a name for area and select tick boxes if it used to Danger Area calculation and/or displaying on radar.
4. In **Corner points** field select desired mode for adding corner points. (Insert or Append mode).
5. Define corner points on the electronic chart area using cursor and **SELECT** button.
6. To define more areas continue from step 2.

How to select an Area of User Chart to be modified

In **Area object** field **Current** indicates which Area of User Chart is selected to be modified. If you want another area to be modified, you have three alternatives to do it:

- Enter desired Area number of User chart object in Record field to **Current** edit box. To modify number take cursor to **Current** edit box and press **Select** button. Enter desired number and press **OK**.
- Use **First**, **<<**, **>>**, **Last** buttons to find appropriate Area of User chart.



- Use **INFO/HELP** push button to select Area of User chart. Take cursor into the Electronic chart area above desired Area one of its corner point and press **INFO/HELP** push button.

How to change position of corner point

The easiest way to move corner point is drag and drop it to desired position. To do it, proceed as follow:

1. Select display of electronic chart area so you can see desired Area of User Chart on display.
2. Take cursor above a corner point you want to move to new position.
3. Press **CHART ALING** push button and move cursor to desired position. Keep **CHART ALIGN** button pressed down while you move cursor and release it when cursor is in right position.

How to delete an Area of User Chart

To delete complete Area of User Chart, select desired Area object to be displayed in Area Object field and press **Delete** button.

How to import Areas of User Chart

You can copy Areas of User Chart from another User Chart file to active User Chart file.

1. Create or open existing User chart file. Open Areas sheet.
2. Press **Import** button in Area Object field.
3. An User Chart Import dialog box appears

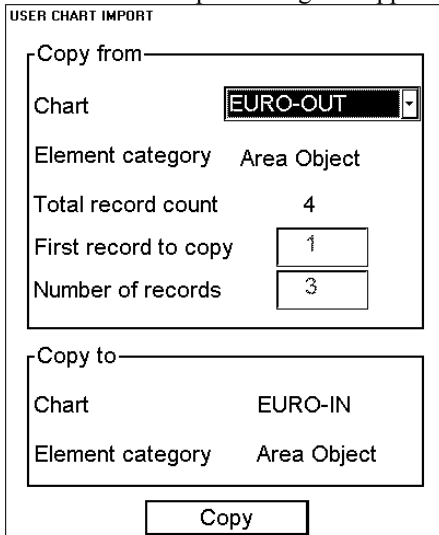

Select **Chart** from which you want to copy Areas

4. **Total record count** shows number of areas stored in selected User Chart. Enter into **First record to copy** field Area number from which you want to start copying.
5. Enter **Number of records** field how many areas you want copy into active User Chart file.
6. Press **Copy** button to copy selected areas. If you do not want copy exit this dialog box by pressing **CANCEL** in Control Panel.

Add a new Point, Symbol, Line or Tidal to User chart

Here in this text the User chart object is a common name for **Point, Symbol, Line** and **Tidal**. The idea to modify **Point, Symbol, Line** and **Tidal** are the same all User chart objects. To select User chart to be modified open User chart object sheet. In a Record field Current number indicates User chart object which is currently to be modified. **NOTE**, you have to be corresponding sheet open in the Dialog box area. (i.e. If you are editing symbols you have to have symbols sheet opened).

To modify User Chart Areas, see chapter "Introduction of Area Sheet" on page 275.

You have three alternatives to select desired User chart object:

To add a new User chart object you have following alternatives to do it:

- Press **Select** button.
- Press **Add** button in desired sheet.

To add a new User chart object by **Select** button, proceed as follows:

1. Open desired User chart object sheet.
2. Take cursor to the Electronic chart area to desired position and press **Select** button. New User chart object appears.
3. Modify data of added User chart object. For more information to modify Point, Symbol, Line and Tidal data, see "Change other data of Point, Symbol, Line" on page 279.

To add a new User chart object by **Add** button, proceed as follows:

1. Open desired User chart object sheet.
2. Press **Add** button in desired User chart object sheet. This adds a new User chart object to the end of file, which is copy of current User chart object.
3. Modify position of User chart record. For more information to modify position, see "Change position of Point, Symbol, Line or Tidal" on page 278.
4. Modify other data of User chart object. For more information to modify other data, see "Change other data of Point, Symbol, Line" on page 279.

How to select Point, Symbol, Line or Tidal to be modified

Here the User chart object is a common name for **points, symbols, line** and **tidal**. The idea to modify **points, symbols, line** and **tidal** are the same all User chart objects. To select User chart to be modified open User chart object sheet. In a Record field Current number indicates User chart object which is currently to be modified.

- Enter desired number of User chart object in Record field to **Current** edit box. To modify number take cursor to **Current** edit box and press **Select** button. Enter desired number and press **OK**.
- Use **First**, **<<**, **>>**, **Last** buttons to find appropriate User chart object.



- Use INFO/HELP push button to select User chart object. Take cursor into the Electronic chart area above desired User chart object and press **INFO/HELP** push button.

Change position of Point, Symbol, Line or Tidal

To change position of User chart object you have two alternatives to do it:

- Enter latitude and longitude to Position field.
- Drag and drop User chart object with CHART ALIGN push button.

Enter latitude and longitude to Position field:

1. Select desired User chart object sheet open.
2. Select desired User chart object.
3. Enter co-ordinates of latitude and longitude to Position field. To modify co-ordinate of Latitude take cursor to **Lat** edit box and press **Select** button. Enter co-ordinate and press **OK**. To the same way to modify co-ordinate of longitude. **Note:** Lines have start and end point position fields.

Position	
Lat	35°08.321N
Lon	139°44.794E

Drag and drop User chart object to new position:



CHART ALIGN pushbutton

1. Select desired User chart object sheet open.
2. Take cursor into the Electronic chart area above desired User chart object.
3. Press CHART ALING push button and move cursor to desired position. Keep CHART ALIGN button pressed down while you move cursor and release it when cursor is in right position.

Change other data of Point, Symbol, Line or Tidal

To change other data of **User chart object**, such as name, symbol, element type, proceed as follows:

1. Select desired **User chart object**. For more information to select User chart object, see "How to select Point, Symbol, Line or Tidal to be modified" on page 278.
2. Take cursor to desired edit box and press **Select** button. Modify field's value and press **OK**.

Delete a Point, Symbol, Line or Tidal

To delete a User chart object, proceed as follows:

1. Open desired User chart object sheet.
2. Select desired User chart object to delete. For more information to select User chart object to modified, see "How to select Point, Symbol, Line or Tidal to be modified" on page 278.
3. Press **Delete** button in desired User chart object sheet.

Import Points, Symbols, Lines or Tidals from other User chart

User is able to select User chart objects from other user chart to import them to current User chart. To import User chart object proceed as follows:

1. Open desired User chart object sheet.
2. Press **Import** button. The following window appears.

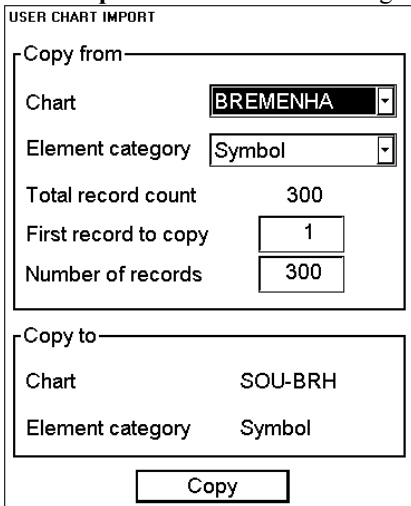

The screenshot shows a dialog box titled "USER CHART IMPORT". It is divided into two main sections: "Copy from" and "Copy to".

Copy from section:

- Chart: BREMENHA (dropdown menu)
- Element category: Symbol (dropdown menu)
- Total record count: 300
- First record to copy: 1 (input box)
- Number of records: 300 (input box)

Copy to section:

- Chart: SOU-BRH
- Element category: Symbol

At the bottom of the dialog box is a "Copy" button.

3. Select the chart from where User chart objects are copied.
4. Element category shows category from which User chart object's category elements are copied.
5. Enter first record to copy edit box.
6. Enter number of records to edit box.
7. Press **Copy** button.

How to join two or more User Charts together

The ECDIS allows you to combine two or more User Charts into one User Chart in an easy way. To join two or more User Charts together, proceed as follows:

1. Create a new User Chart or select existing one.
2. Press USER CHART button and select **Combine** from the menu.
3. Select desired User Chart from list box of Chart

USER CHART COMBINE

Copy from

Chart

Points: 40

Symbols: 300

Tidals: 0

Lines: 928

Areas: 0

Copy to

Chart: SOU-BRH

Points: 3

Symbols: 3

Tidals: 1

Lines: 3

Areas: 1

Press **Copy** button. Repeat step 3 for all the User Charts you like to combine together.

Display on ECDIS screen

User Charts can be displayed on the ECDIS screen. They have many options available to select visible objects at any time. Their visibility is controlled from the Mariner sheet of Chart Display.

User chart

Off	Std	Other	
<input checked="" type="radio"/>	<input type="radio"/>	<input type="radio"/>	Points
<input type="radio"/>	<input checked="" type="radio"/>	<input type="radio"/>	Lines
<input type="radio"/>	<input checked="" type="radio"/>	<input type="radio"/>	Symbols and Tidals
<input type="radio"/>	<input checked="" type="radio"/>	<input type="radio"/>	Areas <input type="text" value="50% Transparent"/>
<input checked="" type="radio"/>	<input type="radio"/>	<input type="radio"/>	Display only radar part of Lines, Symbols and Areas

Below are some examples from the same User Chart with different selections.

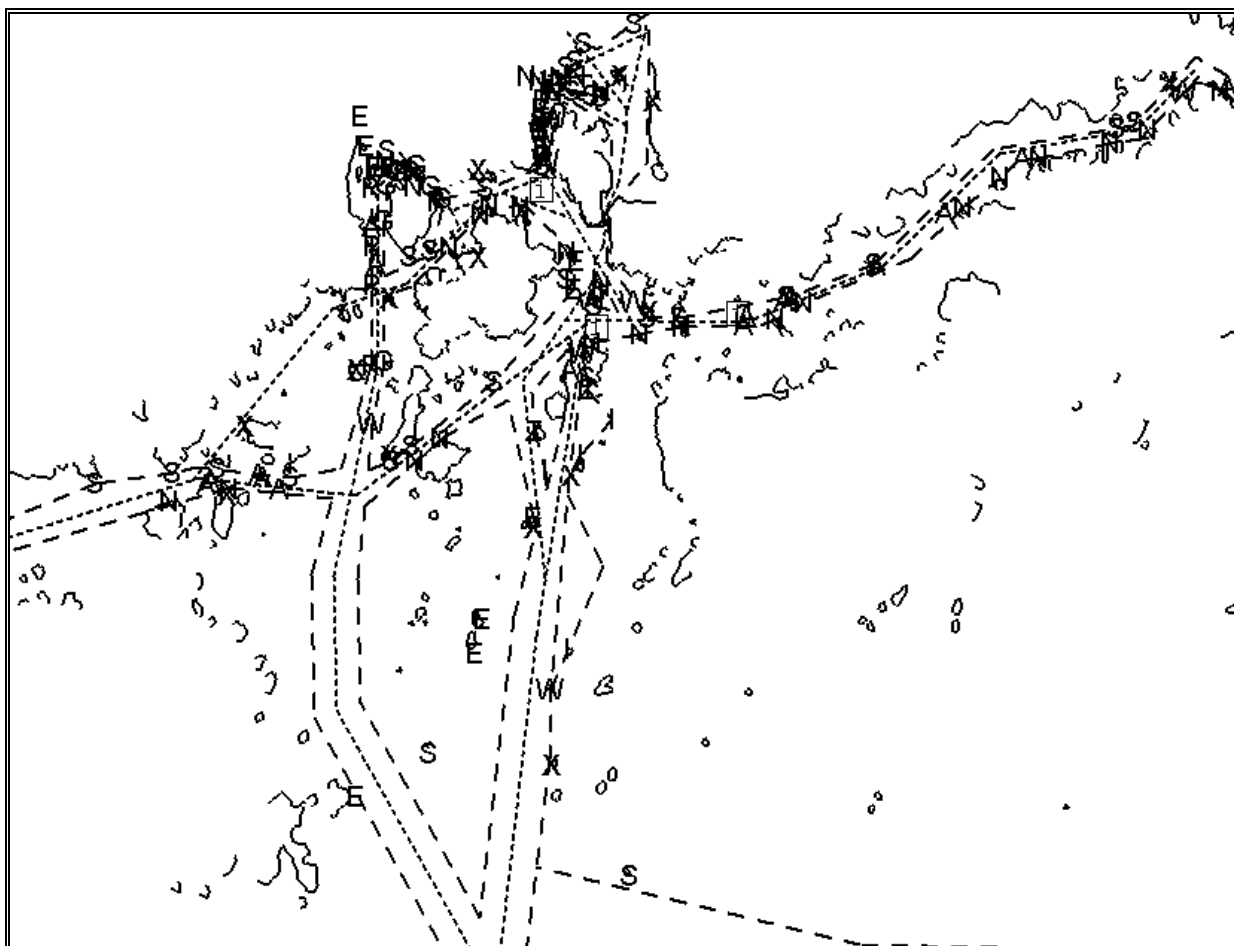

An example with all User Chart objects visible.

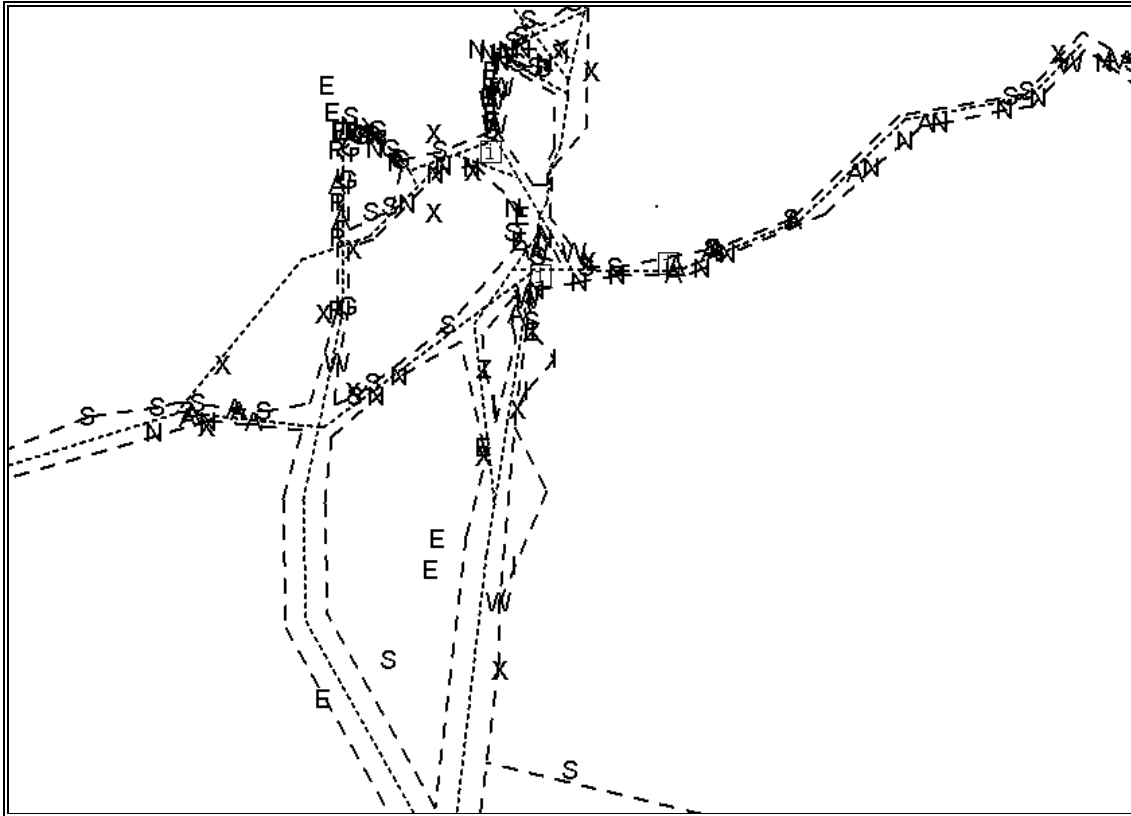

An example with only radar part of Lines, Symbols and Areas displayed.

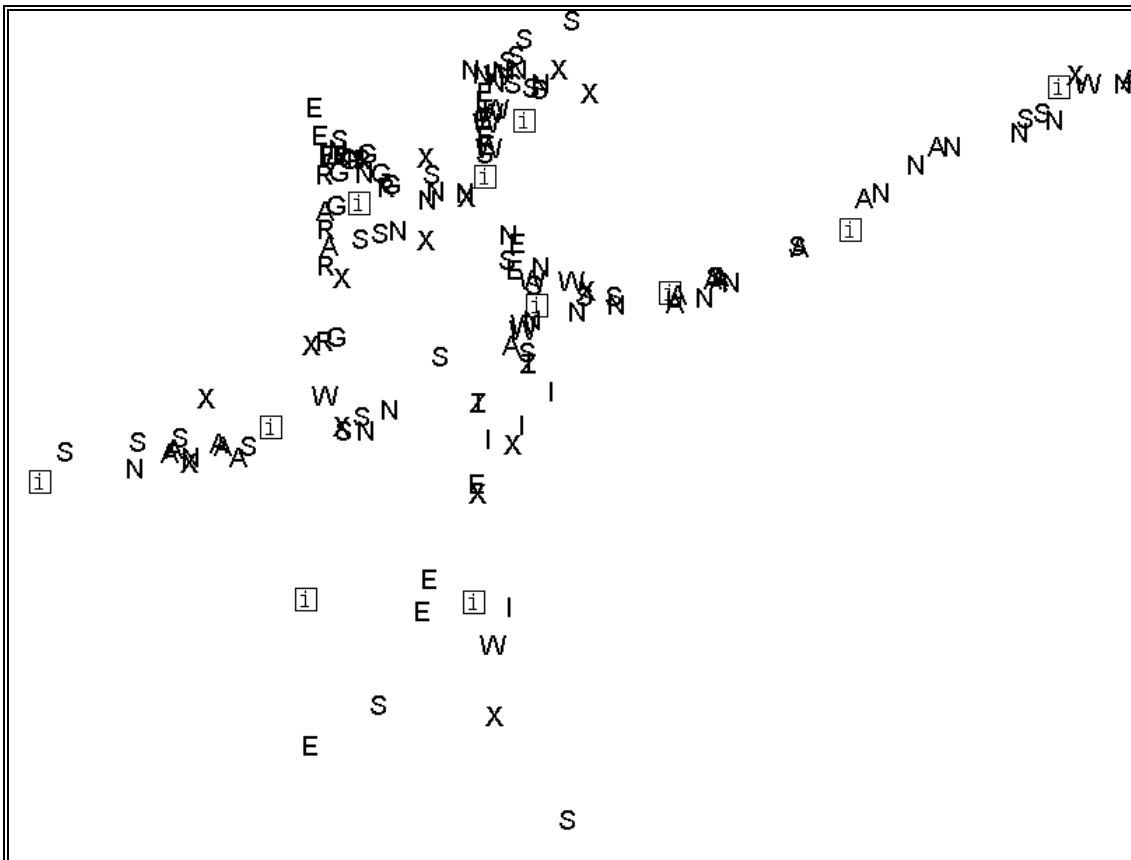

An example with only Symbols and Points displayed. **NOTE!** Above is also a very good example how many and where the Points should be defined.



An example with no Symbols displayed.

Backup to floppy

This procedure can be used to make backups of User charts or to carry User charts to other planning or navigation station. For more information, see "Backup to floppy" on page 315.

Restore from floppy

This procedure can be used to read backup copies of any User Chart file if some data is lost during Pilot data modifying. The other usage is to read User Chart files originating from other planning or navigation station. For more information, see "Restore from floppy" on page 315.

Move to planning or navigation station

For more information, see "Move to planning or navigation station" on page 315.

Read from planning or navigation station

For more information, see "Read from planning or navigation station" on page 316.

How to load User Chart in the old Vector system format

For more information, see "How to load chart and route files in the old Vector system format" on page 316.

How to save User Chart in the old Vector system format

For more information, see "How to save chart and route files in the old Vector system format" on page 316.

Point report

Points are shown as symbol and they are very important element of a User Chart. Point is a center point for subchart inside an User Chart. Subcharts are small enough to be sent for radar screen.

User Chart's Point report is generated by the system. This report appears on display, when user press **User Chart** pushbutton and select **Point report** command from the menu.

In order to print this report do follow:

1. From File menu select Print.
2. Report is now print automatically to default printer.

If printed area is too wide for page layout, you can change size and/or type of font:

1. From **Setting** menu select **Font**
2. Font dialog appears. Select desired options and press **OK**. (Recommended font is Fixedsys and size of font is 9).

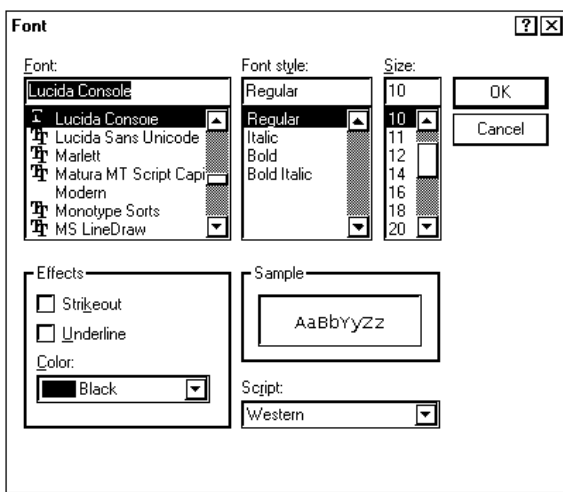

To close this report select from File menu Exit.

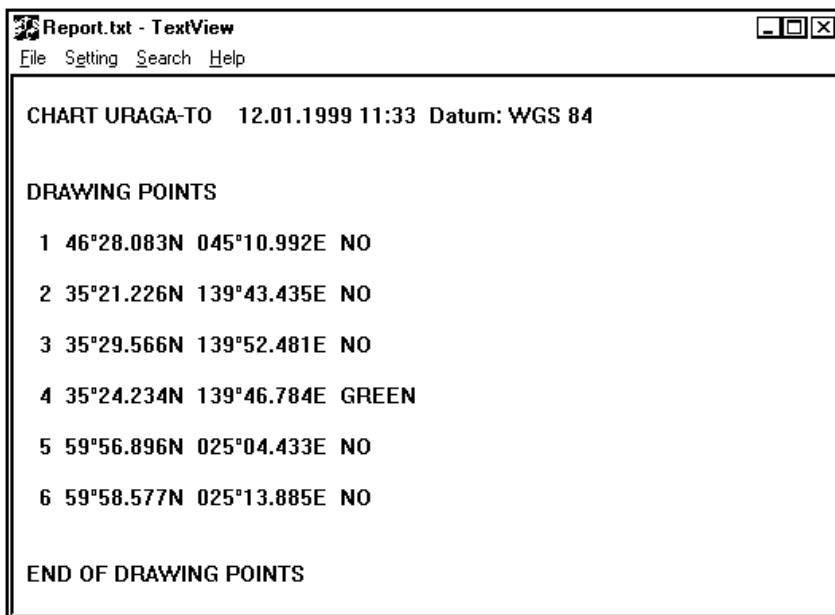

Line report

User Chart's Line report is generated by the system. This report appears on display, when user press **User Chart** pushbutton and select **Line report** command from the menu.

To print, to change size of font and to exit this report, "Point report" on page 286.

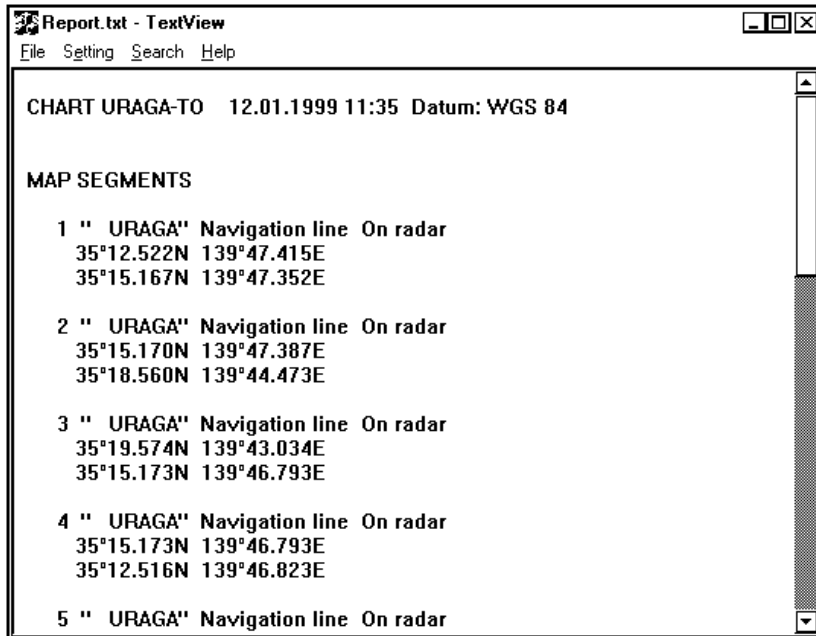

Area Object report

User Chart's Area object report is generated by the system. This report appears on display, when user presses **User Chart** pushbutton and selects **Area Object report** command from the menu.

To print, to change size of font and to exit this report, see "Point report" on page 286.

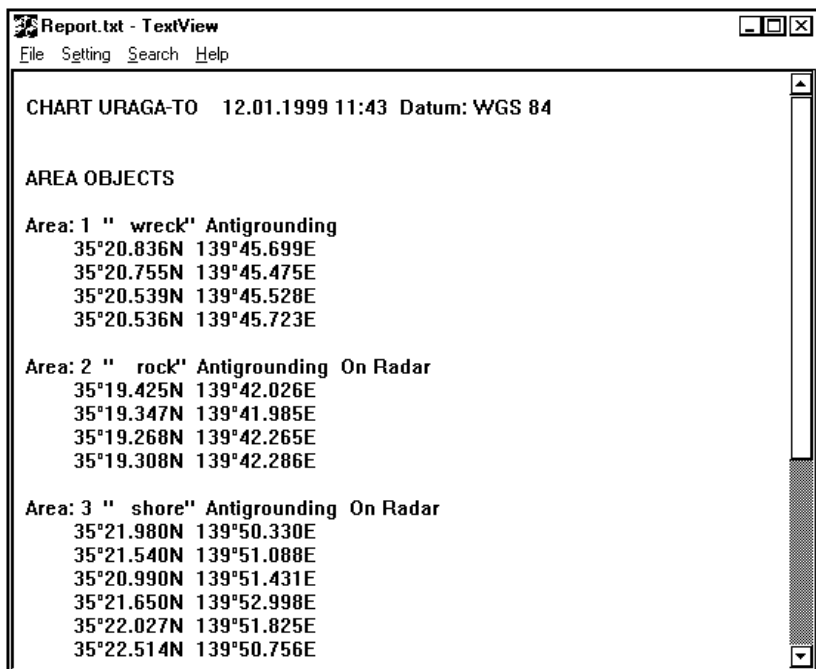

Symbols report

User Chart's Symbols report is generated by the system. This report appears on display, when user presses **User Chart** pushbutton and selects **Symbols report** command from the menu.

To print, to change size of font and to exit this report, see "Point report" on page 286.

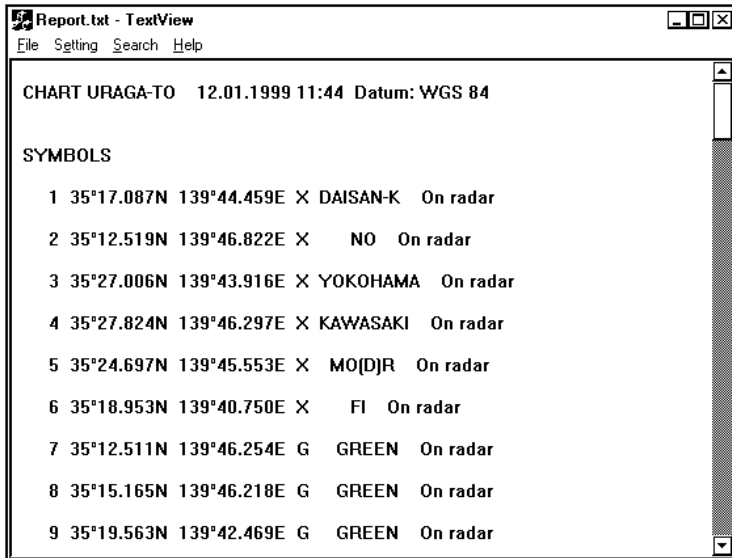

```
Report.txt - TextView
File Setting Search Help

CHART URAGA-TO 12.01.1999 11:44 Datum: WGS 84

SYMBOLS

 1 35°17.087N 139°44.459E X DAISAN-K On radar
 2 35°12.519N 139°46.822E X NO On radar
 3 35°27.006N 139°43.916E X YOKOHAMA On radar
 4 35°27.824N 139°46.297E X KAWASAKI On radar
 5 35°24.697N 139°45.553E X MO(D)R On radar
 6 35°18.953N 139°40.750E X FI On radar
 7 35°12.511N 139°46.254E G GREEN On radar
 8 35°15.165N 139°46.218E G GREEN On radar
 9 35°19.563N 139°42.469E G GREEN On radar
```

Full report

This report includes information about Points, Symbols, Lines and Areas.

User chart's Full report is generated by the system. This report appears on display, when user presses **User Chart** pushbutton and selects **Full report** command from the menu.

To print, to change size of font and to exit this report, see "Point report" on page 286.

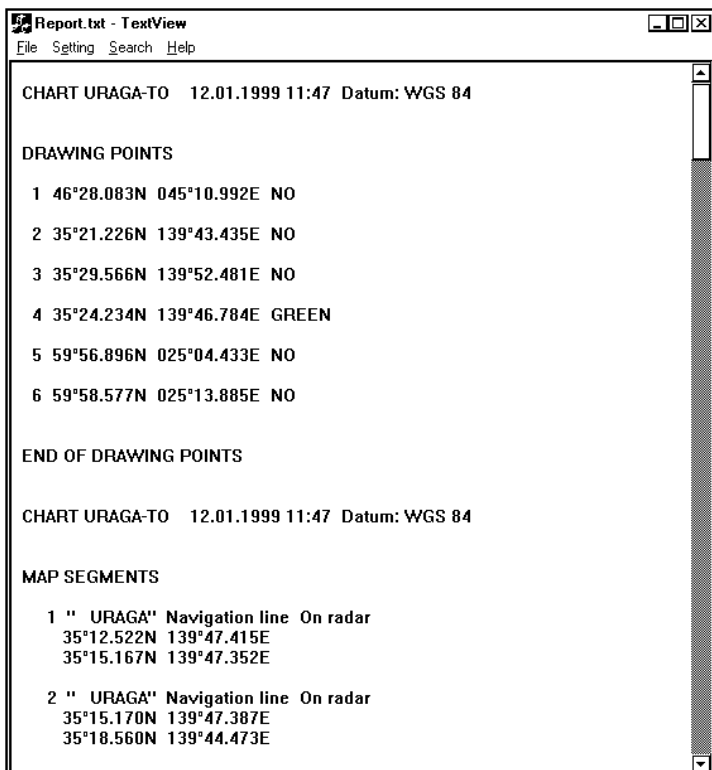

```
Report.txt - TextView
File Setting Search Help

CHART URAGA-TO 12.01.1999 11:47 Datum: WGS 84

DRAWING POINTS

 1 46°28.083N 045°10.992E NO
 2 35°21.226N 139°43.435E NO
 3 35°29.566N 139°52.481E NO
 4 35°24.234N 139°46.784E GREEN
 5 59°56.896N 025°04.433E NO
 6 59°58.577N 025°13.885E NO

END OF DRAWING POINTS

CHART URAGA-TO 12.01.1999 11:47 Datum: WGS 84

MAP SEGMENTS

 1 " URAGA" Navigation line On radar
 35°12.522N 139°47.415E
 35°15.167N 139°47.352E

 2 " URAGA" Navigation line On radar
 35°15.170N 139°47.387E
 35°18.560N 139°44.473E
```

Report for Radar

User Chart's Report for radar report is generated by the system. This report appears on display, when user presses **User Chart** pushbutton and selects **Report for radar** command from the menu.

To print, to change size of font and to exit this report, see "Point report" on page 286.

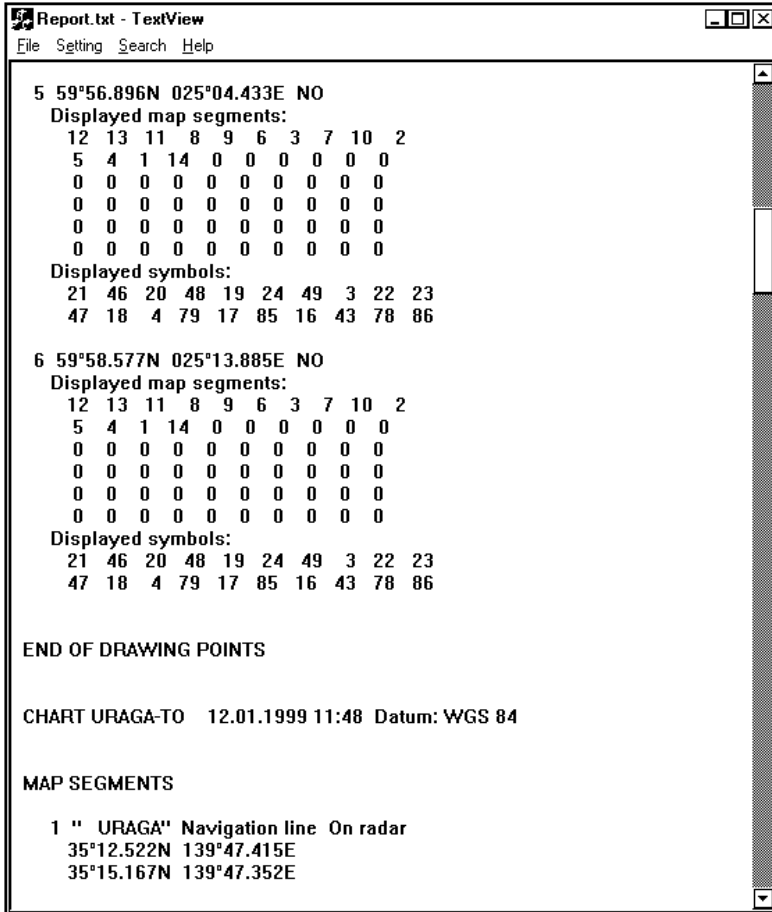

This page is intentionally left blank

Reference Targets

Introduction

The system has a built in position calculating device that is based on tracking radar targets.

In the narrow water navigation, the radar is one of the best position sensors. The Reference Target is specially developed to use the radar as a position sensor. It is required that co-ordinates of all Reference targets which can be used for above, are included in the reference target.

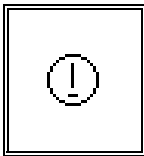

Reference target symbol when it is displayed on chart display.

The chart containing Reference targets must have at least 8 Reference targets inserted. The radar must acquire simultaneously at least 2 fixed targets before the position is taken into the calculation. For more information, how to use reference target for position calculation, see chapter "Using ARPA targets for position calculation"

Reference targets are also used in Gyro error compensation.

For more information to use Reference targets in Gyro error compensation, see chapter "Gyro error correction" on page 349

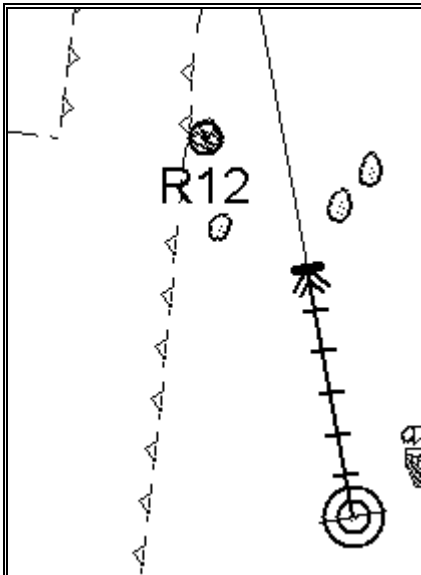

Reference target presentation on chart display when Reference target function is activated and ECDIS receives target information from the radar (target number with letter R).

Modes of Reference Target

A Reference Target can be selected for Monitor mode, which means that Reference Target can be used for Gyro correction and positioning of own ship. An other mode is for modifying Reference Target in Plan mode. In Plan mode Reference Target is only displayed on ECDIS screen without using it for gyro correction or positioning of own ship. Eventually the Monitored and Planned User Charts copy the operation of Monitored and Planned Routes. Below is an example how to know which Reference Target is used Monitor mode and which one is in Plan mode.

Monitor mode

A) Plan Route HEL-STO
Ref Target BALTIC

B) MONITOR REF. TARGET - BALTIC / 28.03.2001 15:33

Target

Current 1 Total 19

Name UUSIMATA Element type Normal

Position Lat 60°05.556N Lon 024°58.743E

Seek Min 0.0 nm Max 24.0 nm

First << >> Last

Enable changes Displayed

Plan mode

A) Plan Route HEL-STO
Ref Target BALTIC

B) PLAN REF. TARGET - NORTHSEA / 15.05.2001 09:34

Target

Current 1 Total 84

Name LB HORNS Element type Normal

Position Lat 55°34.536N Lon 007°26.079E

Seek Min 0.0 nm Max 24.0 nm

First << >> Last

Add Import Delete

Enable changes Displayed

On Upper Status bar the Ref Target field shows always the name of the Reference Target selected for Monitor mode. If the displayed Reference Target on the ECDIS screen is the Monitored Reference Target, then the text "Ref Target" on Upper Status bar is in black (See example "Monitor mode A"). If the displayed Reference Target on the ECDIS screen is the Planned Reference Target, then the text "Ref Target" on Upper Status bar is in red (See example "Plan mode A"). The name of the Planned Reference Target is only available in the window for Plan mode of User Chart (See example "Plan mode B").

Operation of Reference Target push button is following:

1. When you press REFERENCE TARGET push button, Reference Target dialog box will appear to Dialog box area.
2. When you press REFERENCE TARGET push button again, you will get Reference target menu on display.

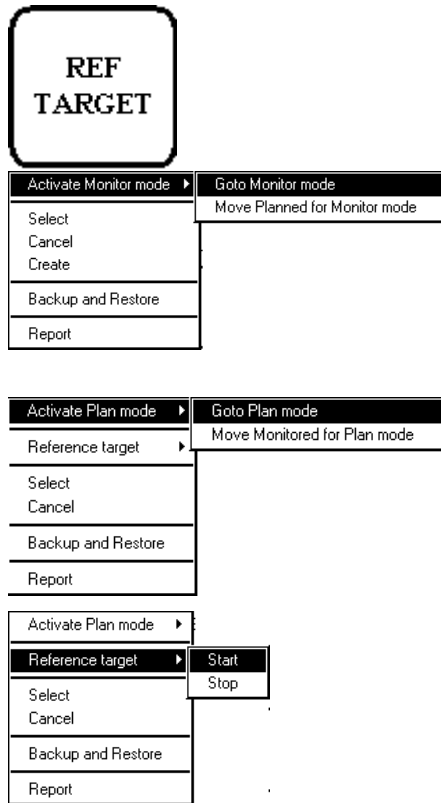

Activate Monitor/Plan mode:

User can switch Reference Target mode between Plan and Monitor. Using **Activate Monitor mode>Goto Monitor mode**, Reference Target used in Planning mode can be switched directly to Monitor mode and using **Activate Plan mode>Goto Plan Mode**, Reference Target used in Monitoring mode can be switched directly to Plan mode.

Reference target:

It is possible to start or stop Reference Targets monitoring.

Select:

User can select from list box Reference Target used either in Plan of Monitor mode.

Cancel:

Cancels selected Reference Target from use of either Plan or Monitor mode.

Create:

User can give name for Reference Target.

Backup and Restore:

User can make backup copy from Reference Target or restore from backup media.

Report:

User can take tabulated Reference Target report.

How to select Reference target for Monitor mode

Reference Target which is for Monitor mode is displayed on Upper status bar in field of Reference Target. If text of Reference Target on Upper right hand corner is red it is indication that the Workstation is in Plan mode for Reference Target. To activate Monitor mode and select Reference Target for monitor mode, proceed as follows:

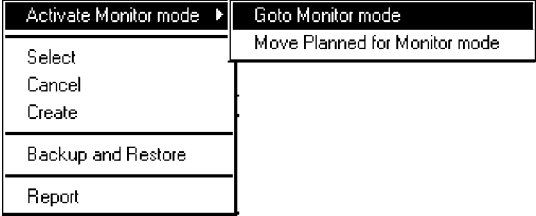
1. 

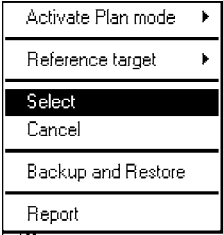
2. 

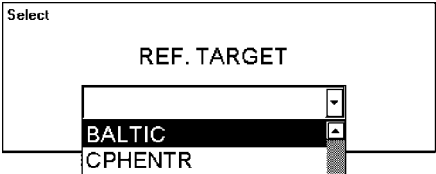
3. 

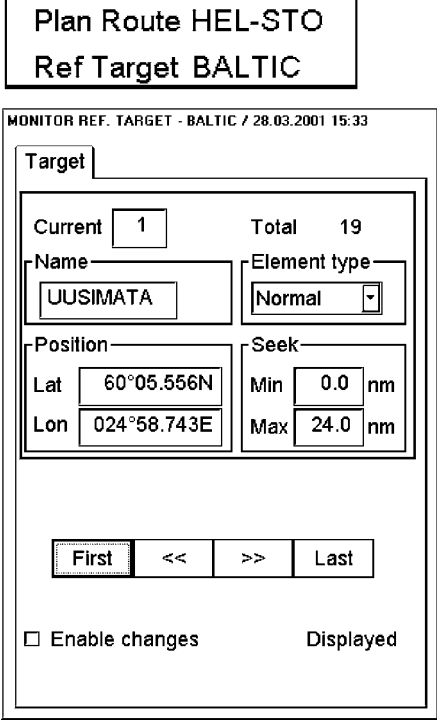
4. 

1. Press REFERENCE TARGET button and select **Activate Monitor mode> Goto Monitor mode**. (If you already have desired Reference Target in Plan mode, you can use **Activate Monitor mode> Move Planned for Monitor mode** to select it for Monitor mode and you can continue from step 4).
2. Press REFERENCE TARGET push button and select from menu **Select**.
3. Reference Target list box appears to the dialog box area. Highlight desired Reference Target to select it.
4. Reference Target will be loaded to Monitor mode and it is displayed on the Electronic chart area. For more information about control Reference Target display, see Chapter "Details of chart display".

How to select Reference Target for Plan mode

If text of **Reference Target** on Upper right hand corner is black it is indication that the Workstation is in monitoring mode for **Reference Target**. To activate Plan mode and select **Reference Target** for Plan mode, proceed as follows:

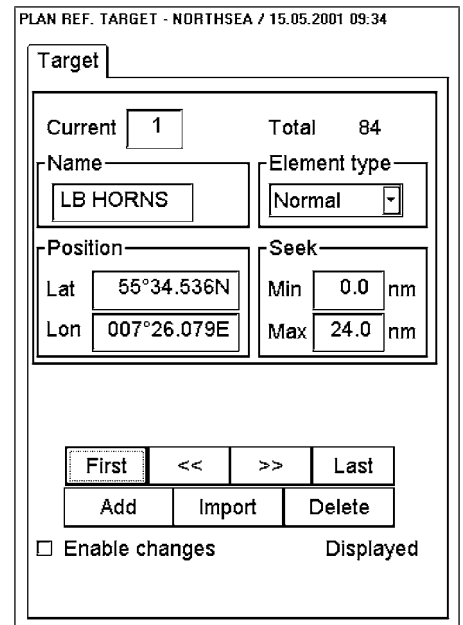
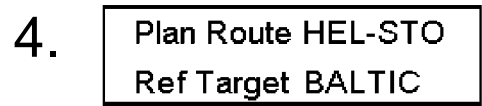
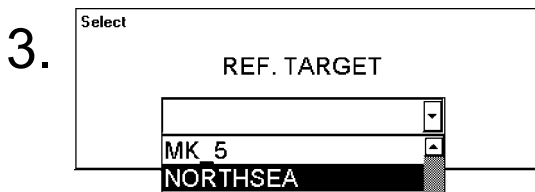
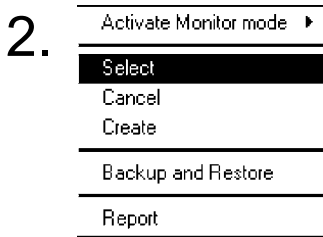
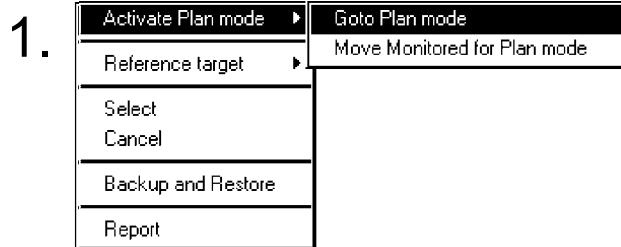

1. Press REFERENCE TARGET button and select **Activate Plan mode> Goto Plan mode**. (If you already have desired Reference Target in Monitoring mode, you can use **Activate Plan mode> Move Monitored for Plan mode** to select it for Plan mode and you can continue from step 4. NOTE, when using this command Reference Target is removed from Monitor mode.).
2. Press REFERENCE TARGET push button and select from menu **Select**.
3. Reference Target list box appears to the dialog box area. Highlight desired Reference Target to select it.
4. Reference Target will be loaded to Plan mode and it is displayed on the Electronic chart area. For more information about control Reference Target display, see Chapter "Details of chart display".

How to create Reference Target

You can create and modify an Reference Target when you have select Plan mode of Reference Target.

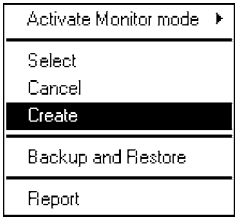
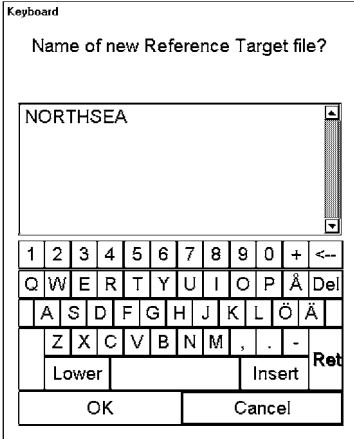
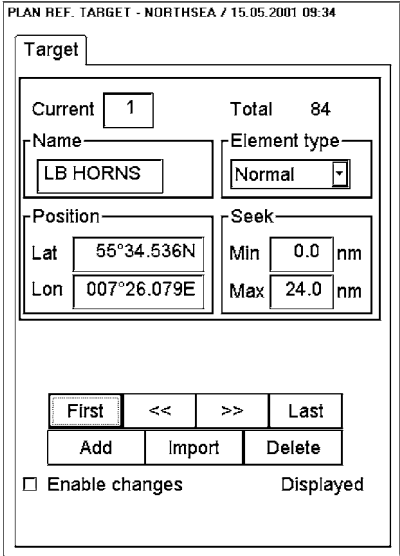
-  
- 
- 

To make a complete Reference Target, proceed as follows:

1. Press twice REFERENCE TARGET button. Select **Create** from the menu.
2. Enter a name for Reference Target using Keypad dialog box and press OK.
3. Select "**Enable changes**". Use Cursor and SELECT button to define location of Reference Target. Define **Name** and used **Element type**. Use Seek field to define range where to seek it.

Introduction of Target sheet

Sheet: "TARGET"

REFERENCE TARGET - MK_18 / 21.06.1999 11:36

Target

Current <input type="text" value="4"/>	Total <input type="text" value="19"/>
Name <input type="text" value="LINTUPAA"/>	Element type <input type="text" value="Normal"/>
Position	Seek
Lat <input type="text" value="60°06.680N"/>	Min <input type="text" value="0.0"/> nm
Lon <input type="text" value="024°53.840E"/>	Max <input type="text" value="24.0"/> nm

First	<<	>>	Last
Add	Import	Delete	

Enable changes Displayed

Enable changes:

User has to select this in order to do modifying.

Note! You are able to modify Reference Target when **North Up** or **Course Up** orientation is selected to be used..

Current:

Indicates number of current reference target. User can change target by editing desired number to edit box or create new one.

Total:

Indicates total number of reference targets.

Name:

User can give name to current ref. target.

Element type:

User can choose appropriate type from combo box.

Lat:

User is able to enter to edit box latitude of target data record.

Lon:

User is able to enter to edit box longitude of target data record.

Min. and Max.

User can define range for current ref. target within system seeks it.

Add:

This function adds new target next to current target. User can edit position by entering new co-ordinates or by showing new location with the trackball and select pushbutton.

Delete:

This function deletes record of current target.

Import:

User is able to select from the file list a Reference Target files to import to current file.

First, Last:

Pushing this control user gets first or last target of the file.

>>, <<:

Pushing this control user gets next or previous target of the file.

Note:

If you want reference targets to be displayed on the charts make sure, that **Reference target** is selected in **Mariner** sheet.

Add a new Reference target record

To add a new Reference Target record you have following alternatives to do it:

- Press **Select** button.
- Press **Add** button in Current record sheet.

To add a new Reference target record by **Select** button, proceed as follows:

1. Open Current target sheet.
2. Take cursor to the Electronic chart area to desired position and press **Select** button. New Reference Target appears at the cursor's position.
3. Modify data of added Reference Target. For more information to modify Reference target data, see "Change other data of Reference target" on page 299.

To add a new Reference target by **Add** button, proceed as follows:

1. Open Current target sheet.
2. Press **Add** button in Current target sheet. This adds a new Reference target record to the end of Reference target. This is copy of previous Reference target record.
3. Select last record of Reference target to be modified. For more information to select Reference target to be modified, see "How to select Reference target to be modified" on page 299.
4. Modify position of Reference target record. For more information to modify position of Reference target record, see "Change Reference target position" on page 299.
5. Modify other data of Reference target record. For more information to modify other data of Reference target record, see "Change other data of Reference target" on page 299.

How to select Reference target to be modified

In a Record field number of current indicates reference target record which is currently to be modified. You have three alternatives to select desired reference target record:

- Enter desired number of Reference target record in Record field to Waypoint edit box. To modify Waypoint's number take cursor to Waypoint edit box and press **Select** button. Enter desired number and press **OK**.

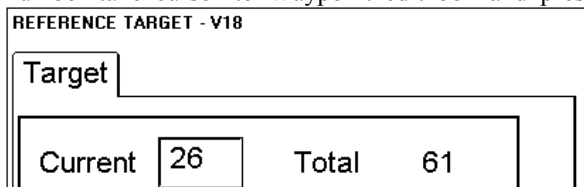

REFERENCE TARGET - V18

Target

Current 26 Total 61

- Use **First**, <<, >>, **Last** buttons to find desired Reference target record.



- Use **INFO/HELP** push button to select Reference target record. Take cursor into the Electronic chart area above desired symbol of Reference target and press **INFO/HELP** push button.

Change Reference target position

To change position of Reference target you have two alternatives to do it:

- Enter latitude and longitude to Position field.
- Drag and drop symbol of reference point with **CHART ALIGN** push button.

Enter latitude and longitude to Position field:

1. Select desired Reference target record.
2. Enter co-ordinates of latitude and longitude to Position field. To modify co-ordinate of Latitude take cursor to **Lat** edit box and press **Select** button. Enter co-ordinate and press **OK**. To the same way to modify co-ordinate of longitude.

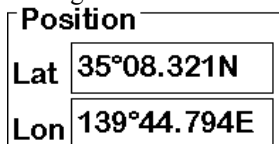

Position

Lat 35°08.321N

Lon 139°44.794E

Drag and drop symbol of Reference target to new position:



CHART ALIGN pushbutton

1. Take cursor into the Electronic chart area above desired symbol of Reference target.
2. Press **CHART ALING** push button and move cursor to desired position. Keep **CHART ALIGN** button pressed down while you move cursor and release it when cursor is in right position.

Change other data of Reference target

To change other data of Reference target, such as name, element type and seeking range, proceed as follows:

1. Select desired Reference target record. For more information to select Reference target record, "How to select Reference target to be modified" on page 299.
2. Take cursor to desired edit box and press **Select** button. Modify field's value and press **OK**.

Delete a Reference target record

To delete a Reference target record, proceed as follows:

1. Select desired record to delete. For more information to select record to be modified, see "How to select Reference target to be modified" on page 299.
2. Press **Delete** button in Current target sheet.

Import record of Reference target from other chart

User is able to select records of Reference target from other Reference Target to import them to current one. To import records proceed as follows:

1. Press **Import** button. The following dialog box appears.

Reference Target import

Copy from

Chart BREMENHA

Element category Reference

Total record count 100

First record to copy 1

Number of records 100

Copy to

Chart SOU-BRH

Element category Reference

Copy

2. Select the chart from where Reference targets are copied.
3. Enter first record to copy.
4. Enter count of copied records to **Number of records** edit box.
5. Press **Copy** button.

Associated alarms

Reference Targets have following associated alarms:

"1102 RefTgt: Less than 8 Targ", if you try to start Reference targets with a file with less than 8 targets.

"1101 RefTgt: No file selected", if you try to start Reference targets without any selected file

"2351 RefTgt: Forced to cancel", if you select a new Reference target file without cancel the current file. The system cancel then automatically the current file.

"2352 RefTgt: Lost positions", you have selected Reference targets as positions source and the Reference target system is unable to solve own ship positions.

"2352 RefTgt: Lost gyro corr", you have selected Reference targets as gyro correction source and the Reference target system is unable to solve gyro correction.

"2352 RefTgt: Tracking full", if you try to select Reference targets in use and there are less than 8 tracking channels available.

Backup to floppy

This procedure can be used to make backups of Reference Targets file or to carry Reference Targets file to other planning or navigation station. For more information, see "Backup to floppy" on page 315.

Restore from floppy

This procedure can be used to read backup copies of any Reference Target file if some data is lost during Reference Target modifying. The other usage is to read Pilot data files originating from other planning or navigation station. For more information, see "Restore from floppy" on page 315.

Move to planning or navigation station

For more information, see "Move to planning or navigation station" on page 315.

Read from planning or navigation station

For more information, see "Read from planning or navigation station" on page 316.

How to load Reference Targets in the old Vector system format

For more information, see "How to load chart and route files in the old Vector system format" on page 316.

How to save Reference Targets in the old Vector system format

For more information, see "How to save chart and route files in the old Vector system format" on page 316.

Reference target report

Reference targets are used to enable Reference target positioning using a radar. The radar is used to find these targets and ECDIS calculates the ship position based on the radar data acquired from the Reference targets.

To print, to change size of font and to exit this report, see "Point report" on page 286.

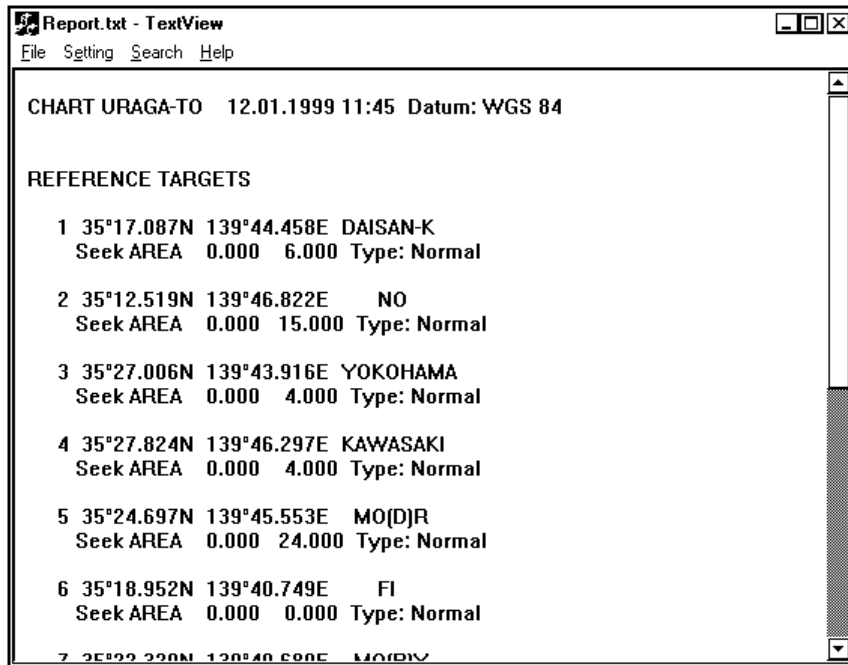

```
Report.txt - TextView
File Setting Search Help

CHART URAGA-TO 12.01.1999 11:45 Datum: WGS 84

REFERENCE TARGETS

1 35°17.087N 139°44.458E DAISAN-K
  Seek AREA 0.000 6.000 Type: Normal

2 35°12.519N 139°46.822E NO
  Seek AREA 0.000 15.000 Type: Normal

3 35°27.006N 139°43.916E YOKOHAMA
  Seek AREA 0.000 4.000 Type: Normal

4 35°27.824N 139°46.297E KAWASAKI
  Seek AREA 0.000 4.000 Type: Normal

5 35°24.697N 139°45.553E MO(D)R
  Seek AREA 0.000 24.000 Type: Normal

6 35°18.952N 139°40.749E FI
  Seek AREA 0.000 0.000 Type: Normal

7 35°22.220N 139°40.690E MO(D)R
```

Pilot Data

Introduction

Navigation related Notebook is called PILOT DATA. Notebook pages are displayed also on radar screen. Pilot Data is a notebook data file which gives messages for operator relative to a specific ship position. This will happen so that user defines Range for each Pilot Data record and ECDIS will make a comparison against own ship position and when it is required the Pilot Data will appear on the screen. (See figure below.)

There is also a possibility to associate to each waypoint a clear brief message that shall appear on the radar display together with the notice of the proximity of the relevant point.

While the ship sails, notebook pages (= records) in the selected pilot data file are compared with own ship position once per each minute to select displayed page. Also when the ship has passed a waypoint the system will make a comparison against own ship position. If the system finds that you have arrived within a new Pilot Data notebook page, it generates alarm **"5001 Pilot Data: New Record"**.

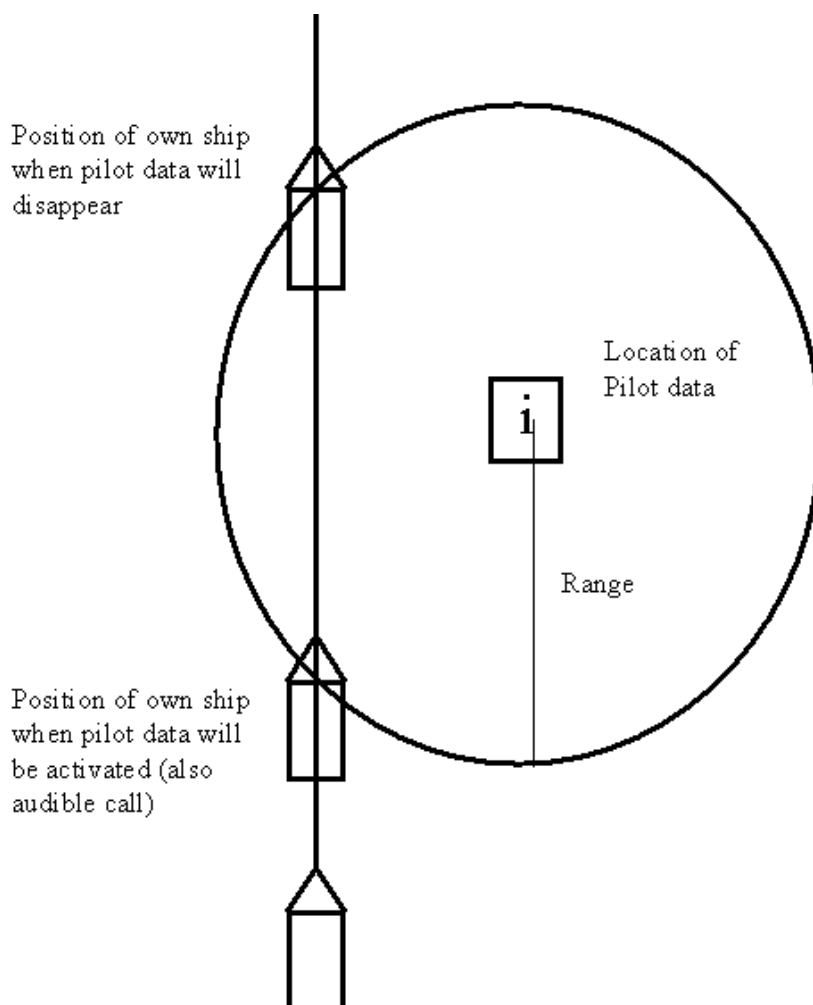

Modes of Pilot Data

A Pilot Data can be selected for Monitor mode, which means that Pilot Data gives user predefined messages for operator relative to a specific ship position. An other mode is for modifying Pilot Data in Plan mode. In Plan mode pilot Data is used to define predefined messages relative to own ship position. Eventually the Monitored and Planned Pilot Data copy the operation of Monitored and Planned Routes. Below is an example how to know which Pilot Data is used Monitor mode and which one is in Plan mode.

Monitor mode

A) Pilot Data HKI-TAL
ARPA 1 Radar

B) MONITOR PILOT DATA - HKI-TAL / 03.05.2001 13:33

View

Record

Current Total 3

Position

Lat Range nm

Lon

LEAVE PILOT SPEED 5 KT

First << >> Last

Enable changes Displayed

Keep current page on

Plan mode

A) Pilot Data HKI-TAL
ARPA 1 Radar

B) PLAN PILOT DATA - SOU-BRH / 12.09.2000 11:30

Edit

Record

Current Total 2

Position

Lat Range nm

Lon

CALL TO VTS USE CH 71

First << >> Last

Add Import Delete

Enable changes Displayed

On Upper Status bar the Pilot Data field shows always the name of the Pilot Data selected for Monitor mode. If the displayed Pilot Data on the ECDIS screen is the Monitored Pilot Data, then the text "Pilot Data" on Upper Status bar is in black (See example "Monitor mode A"). If the displayed Pilot Data on the ECDIS screen is the Planned Pilot Data, then the text "Pilot Data" on Upper Status bar is in red (See example "Plan mode A"). The name of the Planned Pilot Data is only available in the window for Plan mode of Pilot Data (See example "Plan mode B").

How to use normally

Operation of Pilot data push button is following:

1. When you press PILOT DATA push button, **PILOT DATA** dialog box will appear to Dialog box area.
2. If you already have **PILOT DATA** dialog box on display and you press PILOT DATA push button, you will get Pilot data menu on display.

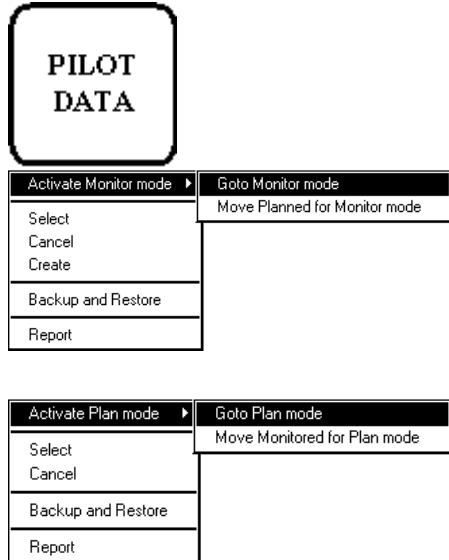

Activate Monitor/Plan:

User can switch Pilot Data mode between Plan and Monitor. Using **Activate Monitor mode** > **Goto Monitor mode** Pilot Data used in Planning mode can be switched directly to Monitor mode and using **Activate Plan mode** > **Goto Plan mode** Pilot Data used in Monitoring mode can be switched directly to Plan mode.

Select:

Selects Pilot Data to be used either Monitor or Plan mode.

Cancel:

Cancel is used to remove Pilot Data from active use.

Create:

Creates new Pilot Data. User can give name max. 8 characters.

Backup and Restore:

User can make backup copy from Pilot Data or restore from backup media

Pilot report:

Generates tabulated report from selected Pilot Data.

Note:

If you want pilot data to be displayed on the electronic chart make sure, that **Pilot Data** is selected in **Mariner** sheet.

1.



2.

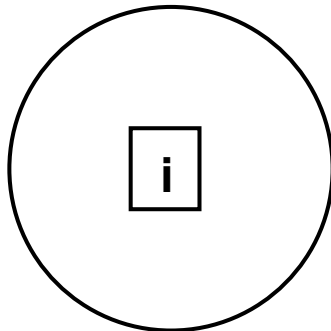

3.

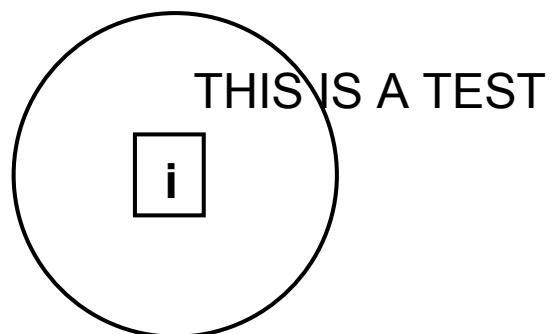

Three different variation as examples to present how pilot Data is displayed over chart area:

1. Only Position mark is displayed
2. Position and Range marks are displayed
3. Also Pilot Data text is displayed over chart.

How to select Pilot Data for Monitor mode

Pilot Data which is for System use is displayed on Upper status bar in field of Pilot Data. If text of Pilot Data is red it is indication that the Workstation is in plan mode for Pilot Data. To activate Monitor mode and select Pilot Data for Monitor mode, proceed as follows:

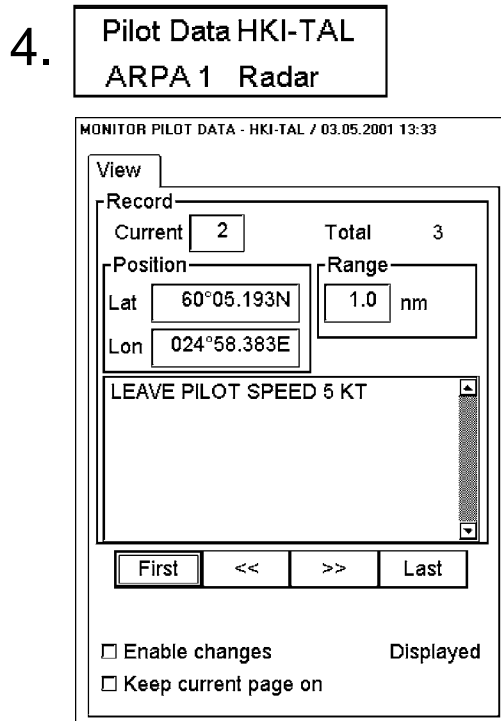
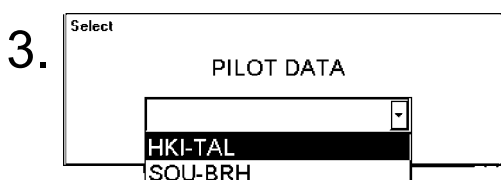
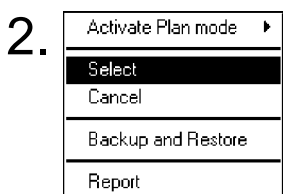
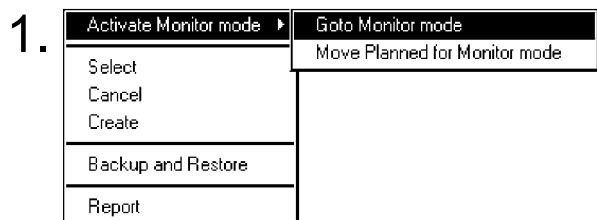

1. Press **PILOT DATA** button and select **Activate Monitor mode > Goto Monitor mode**. (If you already have desired Pilot Data in Plan mode, you can use **Activate Monitor mode > Move Planned for Monitor mode** to select it for Monitor mode and you can continue from step 4).
2. Press **Pilot Data** push button and select from menu **Select**.
3. **Pilot Data** list box appears to the dialog box area. Highlight desired **Pilot Data** to select it.
4. **Pilot Data** will be loaded to Monitor mode and it is displayed on the Electronic chart area. For more information about control **Pilot Data** display, see Chapter "Details of chart display".

Introduction of View sheet

Sheet: "VIEW"

If "Keep current page on" is not selected:

- Opens **View** page
- You can view any Pilot Data record using arrows.

Selection "Enable changes" always changes the Monitor Pilot Data to Plan Pilot Data mode

Current:

This indicates current number of record which is activated.

Total:

This indicates amount of records in current file.

Position:

This indicates position of current record (LAT, LON).

Range:

Control range for the system to activate current record of Pilot Data.

Introduction of Current sheet

Sheet: "CURRENT"

If "Keep current page on" is selected:

- Opens **Current** page
- When the ship is within the set range, the information of Current Record appears in this table.

Selection "Enable changes" always changes the Monitor Pilot Data to Plan Pilot Data mode

How to select Pilot Data for Plan mode

If text of **Pilot Data** on Upper right hand corner is black it is indication that the Workstation is in Monitoring mode for **Pilot Data**. To activate Plan mode and select **Pilot Data** for Plan mode, proceed as follows:

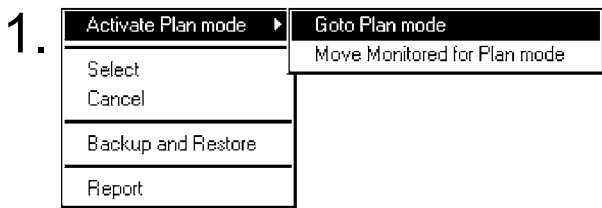

4.

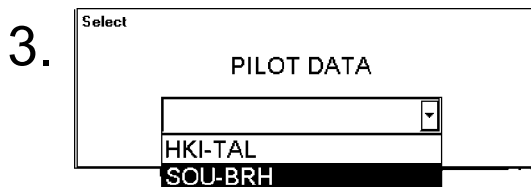
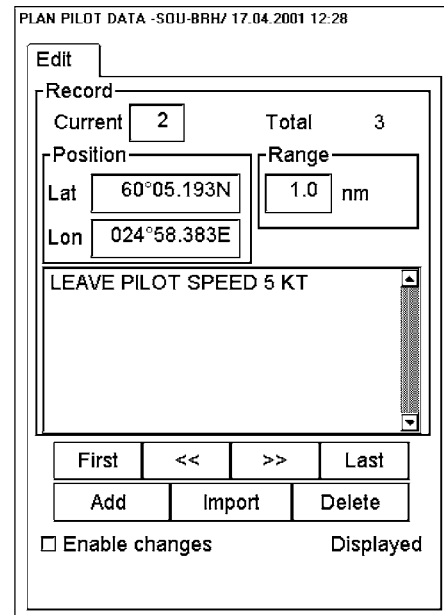
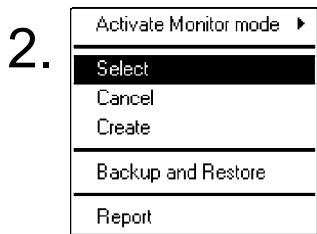
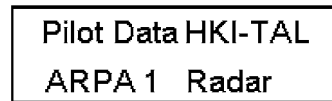

1. Press **PILOT DATA** button and select **Activate Plan mode > Goto Plan mode**. (If you already have desired Pilot Data in Monitoring mode, you can use **Activate Plan mode > Move Monitored for Plan mode** to select it for Plan mode and you can continue from step 4. NOTE, when using this command Pilot Data is removed from Monitor mode.)
2. Press **Pilot Data** push button and select from menu **Select**.
3. Pilot Data list box appears to the dialog box area. Highlight desired Pilot Data to select it.
4. Pilot Data will be loaded to Plan mode and it is displayed on the Electronic chart area. For more information about control Pilot Data display, see Chapter "Details of chart display".

Introduction of Edit sheet

Sheet: "EDIT"

PLAN PILOT DATA - 50U-BRH/ 17.04.2001 12:28

Edit

Record

Current 2 Total 3

Position

Lat 60°05.193N

Lon 024°58.383E

Range

1.0 nm

LEAVE PILOT SPEED 5 KT

First << >> Last

Add Import Delete

Enable changes Displayed

Enable changes:

User has to select this in order to do modifying.

Note! You are able to modify Pilot Data when **North Up** or **Course Up** orientation is selected to be used.

Current:

This indicates current number of record which is activated.

Total:

This indicates amount of records in current file.

Position:

This indicates position of current record (LAT, LON).

Range:

Control range for the system to activate current record of Pilot Data.

TEXT:

User is able to edit message of Pilot data record, which appears to the screen, when the ship has passed the calculated point. To edit the text move cursor inside the text edit box and push Select from Control Panel. The typewriter will appear to Dialog box area

First, Last:

Pushing this control user gets first or last record of the file.

>>, <<:

Pushing this control user gets next or previous record of the file.

Add:

This function adds new record next to current record. User can edit position by entering new co-ordinates or by showing new location with the trackball and select pushbutton.

Import:

User is able to select from the list box an existing file to import the whole file or part of file to current Pilot Data file.

Delete:

This function deletes current record of Pilot Data.

How to create a new Pilot data

You can create and modify Pilot Data when you have select Plan mode of Pilot Data.

NOTE:

It is recommended to use TRUE MOTION display mode while editing.

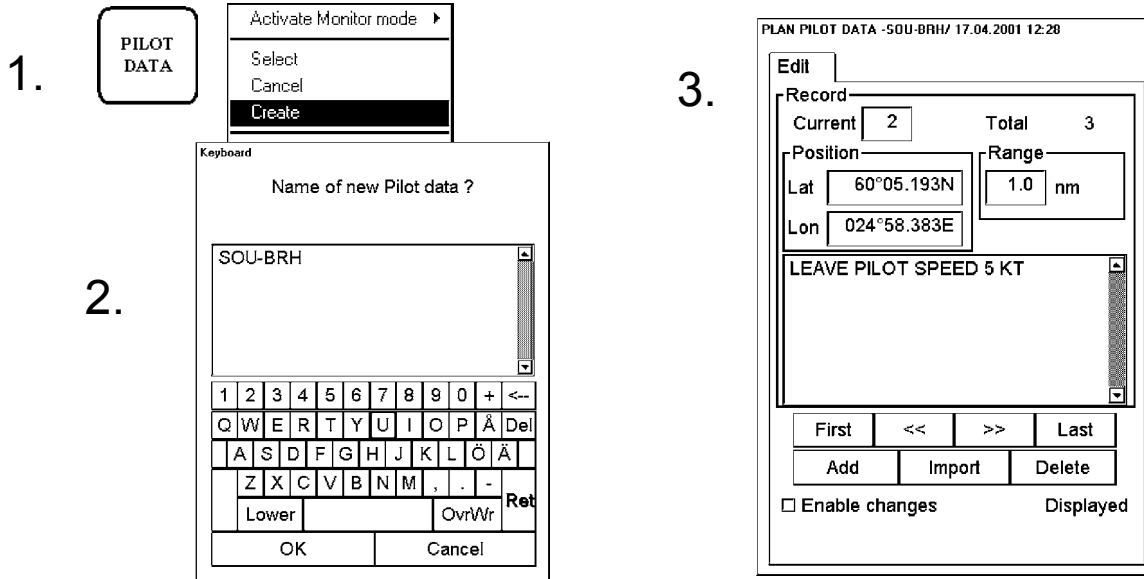

To make a complete Pilot Data, proceed as follows:

1. Press twice **PILOT DATA** button. Select **Create** from the menu.
2. Enter a name for Pilot Data using Keypad dialog box and press **OK**.
3. Open **Edit** page of Pilot Data. Use Cursor and **SELECT** button to define location of Pilot Data. Define **Range** and **Text** for Pilot Data.

Add new Pilot Data record

To add a new **Pilot data** record following alternatives to do it:

- Press **Select** button.
- Press **Add** button in Edit record sheet.

To add a new Pilot Data record by **Select** button, proceed as follows:

1. Open Edit sheet.
2. Take cursor to the Electronic chart area to desired position and press **Select** button. New Pilot Data record appears to the end of file.
3. Modify data of added Pilot Data record. For more information to modify Pilot Data record, see "Change other data of Pilot Data record" on page 311.

To add a new Pilot Data record by **Add** button, proceed as follows:

1. Open Edit sheet.
2. Press **Add** button in Edit sheet. This adds a new Pilot Data record to the end of route, which is copy of current Pilot Data record.
3. Modify position of Pilot Data record. For more information to modify Pilot Data record position, see "Change Pilot data record position" on page 311.
4. Modify other data of Pilot Data record. For more information to modify Pilot Data record other data, see "Change other data of Pilot Data record" on page 311.

How to select Pilot Data record to be modified

To select Pilot Data to be modified open Edit sheet. In a Record field Current indicates Pilot Data which is currently to be modified. You have three alternatives to select desired Pilot Data:

- Enter desired number of Pilot Data in Record field to Current edit box. To modify Current's number take cursor to edit box and press **Select** button. Enter desired number and press **OK**.
- Use **First**, **<<**, **>>**, **Last** buttons to find desired Pilot Data.



- Use **INFO/HELP** push button to select Pilot Data. Take cursor into the Electronic chart area above desired Pilot Data and press **INFO/HELP** push button.

Change Pilot data record position

To change position of Pilot Data you have two alternatives to do it:

- Enter latitude and longitude to Position field.
- Drag and drop Pilot Data with **CHART ALIGN** push button.

Enter latitude and longitude to Position field:

1. Select Edit sheet open.
2. Select desired Pilot Data.
3. Enter co-ordinates of latitude and longitude to Position field. To modify co-ordinate of Latitude take cursor to **Lat** edit box and press **Select** button. Enter co-ordinate and press **OK**. To the same way to modify co-ordinate of longitude.

Drag and drop Pilot Data to new position:



CHART ALIGN pushbutton

1. Select Edit sheet open.
2. Take cursor into the Electronic chart area above desired **Pilot Data**.
3. Press **CHART ALING** push button and move cursor to desired position. Keep **CHART ALIGN** button pressed down while you move cursor and release it when cursor is in right position.

Change other data of Pilot Data record

To change other data of Pilot Data, such as range and text, proceed as follows:

1. Select desired **Pilot Data** record. For more information to select Pilot Data, see "How to select Pilot Data record to be modified" on page 311.
2. Take cursor to desired edit box and press **Select** button. Modify field's value and press **OK**.

Delete a Pilot Data record

To delete a Pilot Data record, proceed as follows:

1. Open Edit sheet.
2. Select desired Pilot Data record to delete. For more information to select Pilot Data record to modified, see "How to select Pilot Data record to be modified" on page 311.
3. Press **Delete** button in Edit record sheet.

Import Pilot data from other routes

User is able to select Pilot Data records from other Pilot Data to import them to current Pilot Data. To import Pilot Data records proceed as follows:

1. In Edit sheet, press **Import** button. The following dialog box appears.

PILOT DATA IMPORT

Copy from

Pilot data **PRODPILO**

Total page count 3

First page to copy 1

Number of pages to copy 3

Copy to

Pilot data **ASD**

First page copied as page 6

Copy

2. Select the Pilot Data from where they are copied.
3. Enter first Pilot Data record to copy and enter number of copied Pilot Data records to **Number of pages to copy** edit box.
4. **Copy to Pilot data** indicates file to be copied. **First page is copied as page** indicates record's to where first record is imported.
5. Press **Copy selected pages** button.

Backup to floppy

This is used to make backups of Pilot Data file. For more information, see "Backup to floppy" on page 315.

Restore from floppy

This is used to read backup copies of Pilot Data file. For more information, see "Restore from floppy" on page 315.

Move to planning or navigation station

For more information, see "Move to planning or navigation station" on page 315.

Read from planning or navigation station

For more information, see "Read from planning or navigation station" on page 316.

Pilot Data report

Use **Report** function in the PILOT DATA menu.

To print, to change size of font and to exit this report, see "Point report" on page 286.

Backup Operations

Introduction

There are several push buttons and menus, which call maintenance function. Via this function user can make operation on hard disk such as **backup, copy, rename** or **delete**. User can make backup copy to backup device or restore from backup device to hard disk. There are listed below push buttons and menu commands, which are used to maintenance system's database:

	Menu commands:
USER CHART	Backup and Restore
REF TARGET	Backup and Restore
ROUTE PLAN	Backup and Restore
PILOT DATA	Backup and Restore
INITIAL SETTING	Backup and Restore Parameter backup...

Note, Use only IBM PC formatted floppy disks.

When user selects one of pushbutton and menu command listed above File Maintenance dialog box appears in the dialog box area.

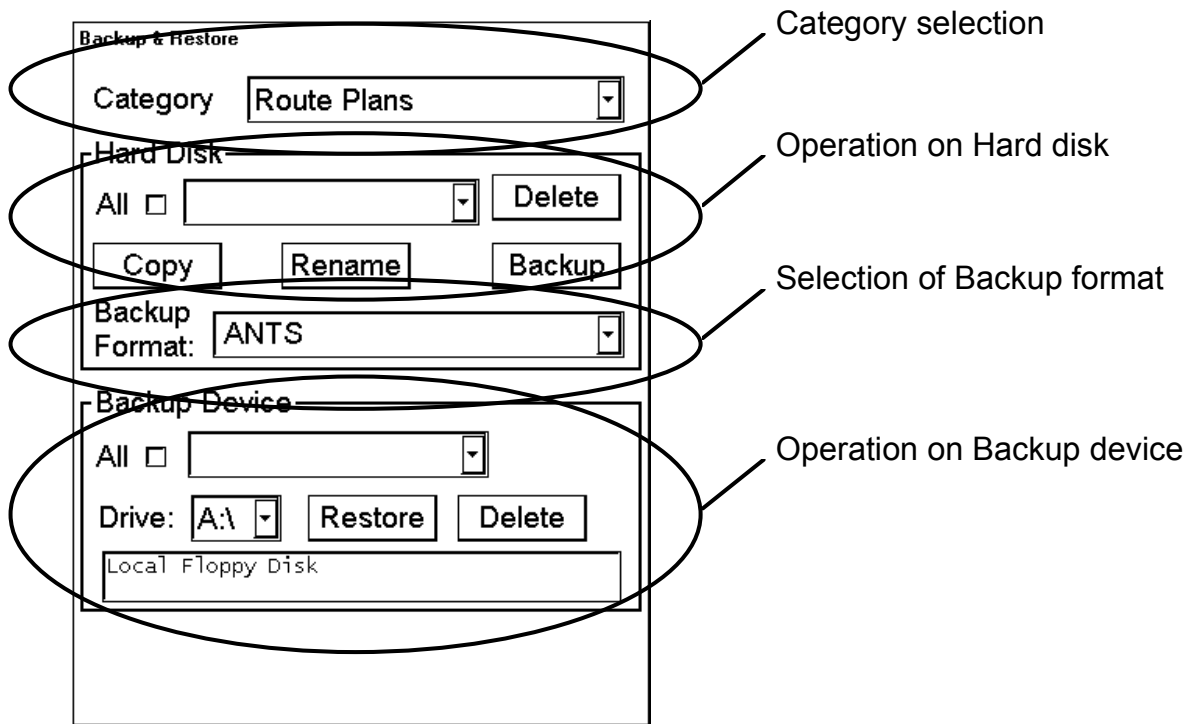

How to find out right file category

System automatically selects corresponding file depending on your selection. (E.g. Route Plan pushbutton selects Route Plans as default.) The categories consist of following files:

- **Route Plans**
- **User Charts**
- **Pilot datas**
- **Installation Parameters**
- **Chart Display Settings**
- **Paper Chart Setup**
- **Presentation Libraries**
- **Logs**
- **Manual Updates**
- **All Charts and Updates**

When you have Backup & Restore dialog box open, you can select desired category from **File category** combo box. When category is selected the system shows all the possible functions you are allowed to do with selected category.

How to make a copy of file

You can make a copy from original file using **Copy** function in Backup & Restore. To make a copy of file, proceed as follows:

1. Select desired file category.
2. Select desired file in Hard Disk -field.
3. Press **Copy** button.
4. Enter new name for selected file and press **OK**.

How to copy a file to an other name

You can change name of file using **Rename** function in Backup & Restore. To copy a file to another name, proceed as follows:

1. Select desired file category.
2. Select desired file in Hard Disk -field.
3. Press **Rename** button.
4. Enter new name for selected file and press **OK**.

Backup to floppy

You can make a backup from original file to floppy disk in Backup & Restore. To make a backup of file to floppy disk, proceed as follows:

1. Select desired file category.
2. Select desired file in Hard Disk -field.
3. Select desired **Drive** in Backup Device -field.
4. Press **Backup** button in Hard Disk -field.

Restore from floppy

You can restore file from floppy disk in Backup & Restore. To restore file from floppy disk, proceed as follows:

1. Select desired file category.
2. Select desired **Drive** in Backup Device -field.
3. Select desired file in Backup Device -field.
4. Press **Restore** button in Backup Device -field.

How to delete file

You can delete file using **Delete** function in Backup & Restore. To delete a file, proceed as follows:

1. Select desired file category.
2. Select desired file in Hard Disk -field.
3. Press **Delete** button.

Move to planning or navigation station

If there is separate planning station connected to system, it is possible to move files from planning station to navigation station and vice versa.

1. From Control Panel select desired pushbutton.
2. From menu select **Backup and Restore** command.
3. In the Hard disk -field select desired file.
4. Select backup drive in **Backup device** -field. Press **Backup** button in Hard Disk -field.

Read from planning or navigation station

If there is separate planning station connected to system, it is possible to read files from planning station to navigation station and vice versa.

1. From Control Panel select desired pushbutton.
2. From menu select **Backup and Restore** command.
3. Select backup drive in **Backup device** -field.
4. In the Backup Device -field select desired file.
5. Press **Restore** button in Backup Device -field.

How to load chart and route files in the old Vector system format

The Route and User Chart files can read in Vector System format (Inc). When loading files in Inc format the ECDIS converts file to format used with the ECDIS. To do it, proceed as follows

1. From Control Panel select desired pushbutton.
2. From menu select **Backup and Restore** command.
3. Select backup drive in **Backup device** -field.
4. In the Backup Device -field select desired file.
5. Press **Restore** button in Backup Device -field.

How to save chart and route files in the old Vector system format

When route or User Chart is stored to be used in ECDIS, **Backup Format** is selected as **ANTS**. Route and User Chart can be saved in Vector System format (INC). When moving files from the ECDIS to Backup Device the ECDIS converts file to Inc format. To do it, proceed as follows

1. From Control Panel select desired pushbutton.
2. From menu select **Backup and Restore** command. There will appear Backup & Restore dialog box in the Dialog box area.
3. In the Hard disk -field select desired file and select **Backup file format** as Inc.
4. Select backup drive in **Backup device** -field. Press **Backup** button in Hard Disk -field.

How to save route as ASCII text file

Sometimes it is useful to save some information of Route as ASCII text file to be used with some other application, or if you like to restore some ASCII text produced by some other application to ECDIS. For more details see chapter "Appendix 5" in this manual.

Following formats for Route Backup & Restore are available:

- ASCII PROPRIETARY,
- ASCII POSITION, list of Latitude/Longitude values
- ASCII WPNAME POSITION, list of WP names and Latitude/Longitude
- ASCII POSITION WPNAME list of Latitude/Longitude and WP names
- ASCII FULL, all route related information

To make backup from a route in ASCII format, proceed as follows:

1. From Control Panel select desired pushbutton.
2. From menu select **Backup and Restore** command. There will appear Backup & Restore dialog box in the Dialog box area.
3. In the Hard disk -field select desired file and select desired **Backup Format**.
4. Select backup drive in **Backup device** -field. Press **Backup** button in Hard Disk -field.

How to restore route from ASCII text file

Sometimes it is useful to restore to ECDIS some information of Route as ASCII text file produced by some other application. For more details see chapter "Appendix 5" in this manual.

Following formats for Route Backup & Restore are available:

- ASCII PROPRIETARY,
- ASCII POSITION, list of Latitude/Longitude values
- ASCII WPNAME POSITION, list of WP names and Latitude/Longitude
- ASCII POSITION WPNAME list of Latitude/Longitude and WP names
- ASCII FULL, all route related information

To restore route, proceed as follows:

1. From Control Panel select desired pushbutton.
2. From menu select **Backup and Restore** command. There will appear Backup & Restore dialog box in the Dialog box area.
3. Select desired **Backup Format**.
4. Select backup drive in **Backup device** and select desired file.
5. Press **Restore** button in Backup Device -field.

Backup of chart material

The ECDIS provides a possibility to keep chart data base identical both in the hard disk of the ECDIS and the hard disk of the backup ECDIS. If you want make a backup of chart material to backup ECDIS, open Backup & Restore dialog box and proceed as follows:

1. Select File category.
2. Select **Drive** of backup ECDIS.
3. Press **Backup** button.

The screenshot shows the 'Backup & Restore' dialog box. It is divided into two main sections: 'Hard Disk' and 'Backup Device'. In the 'Hard Disk' section, the 'Category' dropdown menu is set to 'All Charts and Updates' and is circled with a black oval, with the number '1' to its right. In the 'Backup Device' section, the 'Drive' dropdown menu is set to 'G:\' and is also circled with a black oval, with the number '2' to its right. A 'Restore' button is visible next to the drive selection. Below the drive selection, there is a text field containing the path '\\EC1000_002\ANTIS_SYSTEM'. At the bottom of the dialog, there are two checked checkboxes: 'ARCS' and 'S57'. In the 'Hard Disk' section, a 'Backup' button is circled with a black oval, with the number '3' to its right.

NOTE!

After the backup has been completed the hard disk content of the backup ECDIS is identical. However the backup ECDIS doesn't automatically start to use possible new material. Press CHART PLAN and select **System>Refresh Charts after backup** from the menu.

Restore of chart material

The ECDIS provides a possibility to keep chart data base identical both in the hard disk of the ECDIS and the hard disk of backup the ECDIS. If you want restore a backup of chart material from the backup ECDIS, open Backup & Restore dialog box and proceed as follows:

1. Select File category.
2. Select **Drive** of backup ECDIS. Then press **Restore** button.

Backup & Restore

Category: All Charts and Updates

Hard Disk

Backup

Backup Device

Drive: G:\

Restore

\\EC1000_002\ANTS_SYSTEM

ARCS S57

NOTE!

After the restore has been completed the hard disk content of the ECDIS is identical with backup ECDIS. However your ECDIS doesn't automatically start to use possible new material. Press CHART PLAN and select **System>Refresh Charts after backup** from the menu.

This page is intentionally left blank

Common Reference System

Introduction

A system can be combined using one or more Workstation(s). Alternatives for system are:

- Single Workstation
- Multi Workstation (For example Navigation Workstation(s) and Planning Station(s))
- Multi Workstation (For example Navigation Workstations)

An Access Server takes care of information shared inside the System to keep Workstations consistent within the Common Reference System concept. Access Server also takes care if Workstation has privilege to make desired actions (for example if Workstation has Usage rights to change Monitored Route for System).

Common Reference System concept includes following features:

- Shared navigation Sensors
- Shared Alarm management
- Shared Chart databases for S57 (ENC) and ARCS
- Shared databases for Routes, User Charts, Manual Updates, Reference Targets and Pilot Data
- Some user selections are shared (for example Safety contour), while some other user selections are defined separately for each Workstation.
- User selections used for Route planning are individual for each Workstation

The Installation Parameters of System define, if the System consists of more than one workstation and in which Workstation the Access Server, who control the shared use, is running. For more information see Technical Manual of the System.

Control of common reference system

If more than one workstation have been configured to be in the system, the following window is available when pressing INITIAL SETTING button.

INITIAL SETTINGS

Set values

Datum

Set Gyro

Position discrepancy limit nm

Workstation

Usage rights

Sensor source

Mode

1.

2.

3.

1. **Usage rights**, following option are available to request Usage right:
 - **Master**, only this Workstation can be used to make selections for the Monitor mode (for example Route Monitor, User Chart Monitor mode etc.) and System use (for example Navigation sensors, ARPA target source etc.).
 - **Plan**, this Workstation can be used only for Plan mode (i.e. another Workstation(s) is used for selections for the Monitor mode and System use).
 - **Multi**, you have requested this Workstation to share Usage right to make selections for the Monitor mode and System use with other Workstation(s) set as **Multi**. Note that this is only a request for shared operation. If any other Workstation has been selected as **Master**, then you do not get **Multi** Usage Rights, but **Slave** Usage rights. The difference between **Slave** and **Plan** Usage rights is that **Plan** will stay but **Slave** will be changed to **Multi**, if the current Workstation holding **Master** Usage rights is changed from **Master** to any other alternative.
2. **Sensor source**, indicates the Workstation into which all the Navigation sensors are connected. If you have fully redundant System where all the sensors are connected to all Workstations, you can select which Workstation is used as a Sensor source.
3. **Mode**, normally in a multi Workstation environment this selection should always be "Multi Workstation". The alternative selection is "Single workstation" and it is used for two purposes:
 - If you do not have power on in more than one Workstation, then this Workstation shall be selected for "Single workstation" mode.
 - If you for some reason want to use this Workstation of your System temporarily as totally independent separate Workstation, then you can select "Single workstation" mode. NOTE, During the "Single workstation" mode the System do not use Common Reference System concept, everything what you do is not shared by other Workstations.

Shared Alarm management

Common reference system concept include that all alarms are indicated in all workstations and a single acknowledge of alarm in a Workstation is enough to acknowledge the alarm from all Workstations.

Harmonised databases on Workstations

When Multi workstation mode is used, information between Workstations is shared via Access Server. Access Server takes care of harmonising data on all Workstations if any data listed below has been changed in one of the workstations.

- Chart data
 - ARCS
 - S57
 - Manual updates
 - Permits

IMPORTANT: If you have **Multi Workstation** mode in use, it is recommended that Load or Update of ARCS and S57 charts is made when the ship is NOT sailing on restricted waters, because harmonising of databases may cause delay for System operations. If it is necessary to load or update charts, change mode as **Single Workstation**. For more information how to change mode, see chapter "Mode of Workstations" on page 328.

You can set Access Server display options **ON**, if you like to monitor on Access Server windows in what state the system is on the subject of harmonization, whenever harmonization is completed by the system.



To set Access Server Display ON/OFF, proceed as follows:

1. Press INITIAL SETTING button.
2. Select **Access Server and Diagnostic** from the menu and **Access Server Display** from the submenu.
3. When Access Server windows are displayed, Initial Setting menu is as follows:

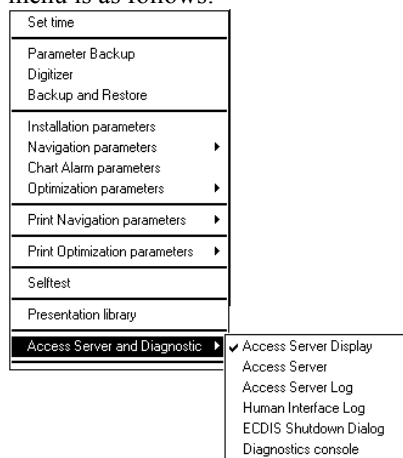
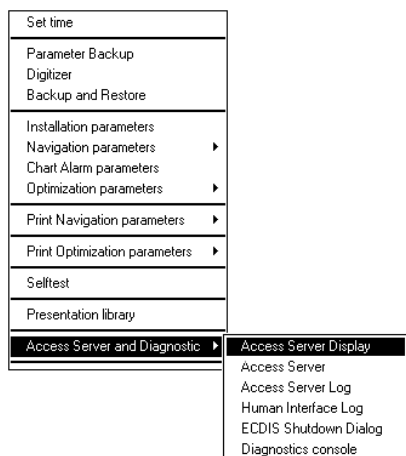

If the System recognise that any data mentioned above has been changed in one Workstation, Access Server indicates the need for pending harmonisation using the window beside.

Harmonization in Access Server is currently pending.

When the Access Server recognises that the editing, loading, updating etc. session has been completed in one Workstation, the Access Server starts harmonising databases in order to get databases identical on all Workstations. **Access Server is currently harmonizing** window appears to indicating this action. If you press **Details...** button, A **Progress of harmonization** window appears to give detailed information about harmonization. This window can be closed by pressing **Details off** button in **Access Server is currently harmonizing** window.

Access Server is currently harmonizing.

Details...

Access Server is currently harmonizing.

Details off

Access Server: Progress of harmonization

Arcs NMS

02_01089.TXT 54 of 1589

Stop

NOTE: The **Stop** button in **Progress of harmonization** window is intended to stop the harmonization in case of system malfunction (for example the harmonization newer end etc.).

When Route, User Chart, Reference Target or Pilot Data is selected for Planning mode, the Access Server locks it and rejects further selection of it in another Workstations until "Enable changes" selection is removed or Planning window is closed.

Harmonising starts when "Enable Changes" selection is removed or corresponding window(s) are closed. After harmonisation has been done, the Route, User Chart, Reference Target or Pilot Data can be selected in another Workstation for Planning mode.

Shared User selections

Common reference system concept include that some selections and settings made by User in one Workstation are transferred to other Workstation(s). These things are listed below:

- Route, User Chart, Reference Target and Pilot Data in Monitor mode
- Selected sensors in Spd/Course and Position pages of Sensor (including position alignment of own ship and gyro correction)
- Settings for Chart Alarms and Watch Sector
- Settings of conditions for Voyage and Dangerous Targets recordings
- Ship parameters (table of Forwarding distance, Optimization parameters and Navigation Parameters)
- Setting for Position discrepancy limit

Usage rights

Workstation can have different Usage rights. **Master** and **Multi (Slave)** rights allow control of both Planning & Monitor modes and Navigation Sensors. **Slave (Multi)** and **Plan** usage rights allow only control Planning mode. Workstations can be set so that

- One has **Master** Usage right. The rest has **Slave (Multi)** or **Plan** Usage rights.
- One or two has **Multi (Slave)** Usage right. The rest has **Plan** Usage rights.

How to set Usage rights as MASTER

One single Workstation can be selected to control Monitor modes and Navigation Sensors. This means that this particular Workstation is used to select Route, User Chart, Reference Target and Pilot Data for Monitor modes.

To select configuration of System in which one selected Workstation has Usage rights set as Master, proceed as follows:

1. Operate at Workstation for which you like to give Master Usage rights. Press INITIAL SETTING button, in Workstation field select tick box **Usage rights** and select **Master** from the list box.

INITIAL SETTINGS

Set values

Datum WGS 84

Set Gyro 57.4°

Position discrepancy limit 0.00 nm

Workstation

Usage rights Master

Sensor source EC1000

Mode Multi workstation

2. Indication **MASTER** is shown in lower right hand corner of display on selected workstation.

MASTER	1:20 000	02.03 02.03
---------------	----------	----------------

3. Indication **SLAVE** is shown in lower right hand corner of display on other workstations. Note indication **SLAVE** is used, if the requested Usage right is **MULTI**, but another Workstation has been selected as **MASTER**.

SLAVE	1:20 000	02.03 02.03
--------------	----------	----------------

How to set Usage rights as MULTI or SLAVE

Multiple Workstations can be selected to control Monitor modes and Navigation Sensors. This means that these particular Workstations are used to select Route, User Chart, Reference Target and Pilot Data for Monitor modes. However the multiple control requires that none of the other Workstations is set for **MASTER** Usage rights. If any other Workstation is set for Master Usage right then this workstation can be set only as **SLAVE** or **PLAN**. The transition from **SLAVE** to **MULTI** Usage right is automatic. If later the Usage right selections in other Workstations are changed, then the Usage right in this Workstation is automatically set as **MULTI** or **SLAVE** based on non-existence or existence of a Master Usage right Workstation.

To select configuration of System in which multiple Workstations have Usage rights set as **MULTI**, proceed as follows:

1. Operate at Workstation for which you like to give **MULTI** or **SLAVE** Usage rights. Press INITIAL SETTING button, in Workstation field select tick box **Usage rights** and select either **Multi (Slave)** or **Slave (Multi)** from the list box. First alternative indicates the selection and second alternative in parenthesis indicates the

provisional selection. Provisional selection may be used by the system if new Usage right selections are made in other Workstations

<p>INITIAL SETTINGS</p> <p>Set values</p> <p>Datum <input type="text" value="WGS 84"/></p> <p>Set Gyro <input type="text" value="57.4°"/></p> <p>Position discrepancy limit <input type="text" value="0.00"/> nm</p> <p>Workstation</p> <p><input type="checkbox"/> Usage rights <input type="text" value="Multi (Slave)"/></p> <p><input type="checkbox"/> Sensor source <input type="text" value="EC1000"/></p> <p><input type="checkbox"/> Mode <input type="text" value="Multi workstation"/></p>	<p>INITIAL SETTINGS</p> <p>Set values</p> <p>Datum <input type="text" value="WGS 84"/></p> <p>Set Gyro <input type="text" value="57.4°"/></p> <p>Position discrepancy limit <input type="text" value="0.00"/> nm</p> <p>Workstation</p> <p><input type="checkbox"/> Usage rights <input type="text" value="Slave (Multi)"/></p> <p><input type="checkbox"/> Sensor source <input type="text" value="EC1000"/></p> <p><input type="checkbox"/> Mode <input type="text" value="Multi workstation"/></p>
--	--

- If based on your request, you got shared **MULTI** Usage rights, then Indication **MULTI** is shown in lower right hand corner of display. If one of the Workstations was already selected as **MASTER**, then the system cannot give you **MULTI** Usage rights. Indication **SLAVE** is shown in lower right hand corner of display.

<p>MULTI 1:20 000 02.03 02.03</p>	or	<p>SLAVE 1:20 000 02.03 02.03</p>
---	----	---

How to set Usage rights as PLAN

Workstation(s) can be selected to control only Planning mode. This means that these particular Workstation(s) are used to edit Route, User Chart, Reference Target and Pilot Data in Plan mode. Selection of **PLAN** Usage right is done in Installation Parameters of ECDIS by Service personnel and user is not able to set any other Usage rights.

Note that Workstation selected in **PLAN** Usage right has still full viewing access to Navigation Sensors and to Monitored Routes, User Charts etc. This is important because it allows that parallel operator(s) can monitor navigation situation.

To verify configuration of System in which selected Workstation(s) has Usage rights set as **PLAN**, proceed as follows:

- Press INITIAL SETTING button, in **Usage rights** field there is indication **Plan**

<p>INITIAL SETTINGS</p> <p>Set values</p> <p>Datum <input type="text" value="WGS 84"/></p> <p>Set Gyro <input type="text" value="180.3°"/></p> <p>Position discrepancy limit <input type="text" value="0.00"/> nm</p> <p>Workstation</p> <p><input type="checkbox"/> Usage rights <input type="text" value="Plan"/></p> <p><input type="checkbox"/> Sensor source <input type="text" value="EC1000"/></p> <p><input type="checkbox"/> Mode <input type="text" value="Multi workstation"/></p>
--

- Indication **PLAN** is shown also in lower right hand corner of display.

<p>PLAN 1:20 000 02.03 02.03</p>
--

Sensor source for the System

Normally sensor source of System is a single Workstation to which all the sensors are connected. All Workstations share the navigation Sensor. The Workstation selected as a **Sensor source** has all the connection to the sensors. In a list box of Sensor source there is listed Workstations which can be used as a Sensor source.

Typically following kind of installations for connecting sensors to the System are used:

- one Workstation to which all the sensors are connected and the others to which only have one DGPS connected (minimum system configuration which fulfil IMO back-up arrangement for ECDIS).
- Multi Workstations to which all the sensors are connected (fully redundant Workstations)

Consult the company who did the installation of the System to know how installation has been made.

NOTE! If you have fully redundant System where all the sensors are connected to all Workstations, it is possible to have the same information available no matter which Workstation is selected as a Sensor source. If there is any difference in Installation Parameters due to different combination of sensors connected, the result of information available may vary when changing Sensor source. It is most recommended that you change Sensor source only when it is required (for example when you have some failure in communications or when hardware fails etc.) and also to change Sensor source only when it is safe for navigation to do it (Change of Sensor source will take some time during which the system is not fully operational).

To change Sensor source, proceed as follows:

1. Operate at Workstation to which you like to set Sensor source. Press INITIAL SETTING button, in Workstation field select tick box **Sensor source** and select desired workstation from the list box.

INITIAL SETTINGS

Set values

Datum: WGS 84

Set Gyro: 57.4°

Position discrepancy limit: 0.00 nm

Workstation

Usage rights: Master

Sensor source: STBD ECDIS

Mode: Multi workstation

2. Communication program is started at Workstation defined as Sensor source to take care of receiving and transmitting data from/to sensors. Workstation of Sensor source is also indicated on SENSOR page.

SELECT SENSORS - Source: STBD ECDIS

Speed/Course	Pos	Other	Record
<input type="checkbox"/> Manual speed			Kt
<input checked="" type="checkbox"/> Log			10.0 Kt
<input checked="" type="checkbox"/> Dual log	<		0.2 Kt
(bottom)	^		10.0 Kt
<input type="checkbox"/> ARPA	(posit.)		10.0 Kt
	(posit.)		242.2 °

Mode of Workstations

The system is defined so that information and operations can be shared within Workstations. Sharing requires that Access Server is running in the defined Workstation (this definition is an installation parameters, see the Technical Manual). Access Server requires that the defined Workstation for it is selected as **Multi workstation**.

If something fails in Workstation(s) or in the LAN connecting the Workstations, which prevents Multi Workstation operations, it is possible to switch the mode as Single workstation. If mode of the Workstation, which is defined in Installation Parameters for Access Server, is set a Single workstation, the Access Server is stopped and the Workstation(s) continues as if they would be separate individual ECDIS systems.

NOTE! When mode is Single workstation, no data harmonised nor information of user selection are shared between Workstations.

How to change Mode to Single or Multi workstation

To change Sensor source, proceed as follows:

1. Operate at Workstation to which you like to set Mode. Press INITIAL SETTING button, in Workstation field select tick box **Mode** and select **Single or Multi workstation** from the list box.

The screenshot shows the 'INITIAL SETTINGS' dialog box. Under the 'Set values' section, 'Datum' is set to 'WGS 84', 'Set Gyro' is '57.4°', and 'Position discrepancy limit' is '0.00 nm'. Under the 'Workstation' section, there are three checkboxes: 'Usage rights' (unchecked), 'Sensor source' (unchecked), and 'Mode' (checked). The 'Mode' dropdown menu is open, showing 'Multi workstation' selected.

2. In this example mode was changed from Multi to Single.

The screenshot shows the 'INITIAL SETTINGS' dialog box. Under the 'Set values' section, 'Datum' is set to 'WGS 84', 'Set Gyro' is '240.0°', and 'Position discrepancy limit' is '0.00 nm'. Under the 'Workstation' section, there are three checkboxes: 'Usage rights' (unchecked), 'Sensor source' (unchecked), and 'Mode' (checked). The 'Mode' dropdown menu is open, showing 'Single workstation' selected.

Selection **Single workstation** disables selections of Usage Rights and Sensor source and stops Access Server operations on Workstation. For indication of this lower left corner of display is text **SINGLE** with red text.

The display status bar shows 'SINGLE' in red text, '1:20 000' in the center, and '02.03' in the bottom right corner.

Troubleshooting

If something fails when the Access Server harmonises Workstations, following window(s) appears to indicating that harmonising has been failed for some reason.

<p>File Access Server - Communication failure</p> <p>Either Workstation(s) are set in Single workstation Mode or there is a failure to communicate with them: PORT ECDIS</p> <p>How to continue in case of communication failure:</p> <p>a) Change from Multi Workstation mode to Single Workstation mode. Perform Initial Setting->Mode->Single Workstation</p> <p>b) OR Try to solve the problem. Check if LAN network operates properly</p>

What to do if pending Access Server window remains on screen

The window below indicates that operation of the Access Server is pending.

<p>Harmonization in Access Server is currently pending.</p>
--

There are two alternatives for pending state

1. Either you have not closed all related windows. To solve this use Cancel pushbutton until you do not have any open windows on ECDIS screen.
2. Or for some other reason the Access Server remains in pending state. To solve this try manual activation of harmonization of workstations as follows:

Set time	
Parameter Backup Digitizer Backup and Restore	
Installation parameters Navigation parameters ▶ Chart Alarm parameters Optimization parameters ▶	
Print Navigation parameters ▶	
Print Optimization parameters ▶	
Selftest	
Presentation library	
Access Server and Diagnostic ▶	✓ Access Server Display Access Server Access Server Log Human Interface Log ECDIS Shutdown Dialog Diagnostics console

1. Press INITIAL SETTINGS button.
2. Select **Access Server and Diagnostic** from the menu and select **Access Server** from sub menu.
3. Harmonization will be completed.

Access Server log

Access Server log is used to analyse and to make diagnose of Access Server operation. Service personnel can use this log to check operation of Access Server. To activate Access Server log:

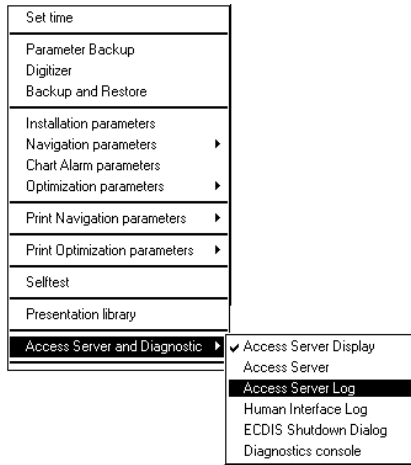

1. Press INITIAL SETTINGS button.
2. Select **Access Server and Diagnostic** from the menu and select **Access Server log** from the sub menu.

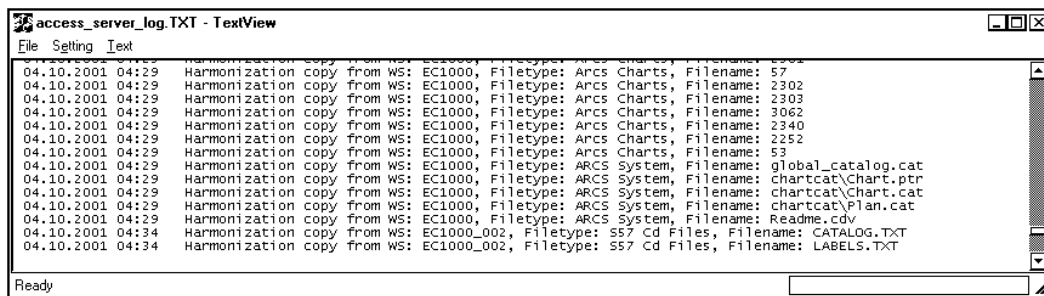

Human Interface log

Human Interface log is used to analyse and to make diagnose of System operation. Service personnel can use this log to check operation of the System. To activate Human Interface log:

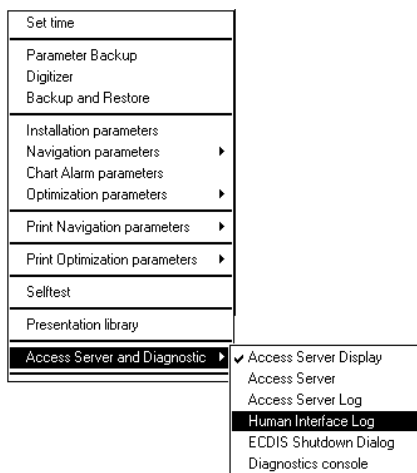

1. Press INITIAL SETTINGS button.
2. Select **Access Server and Diagnostic** from the menu and select **Human Interface log** from the sub menu.

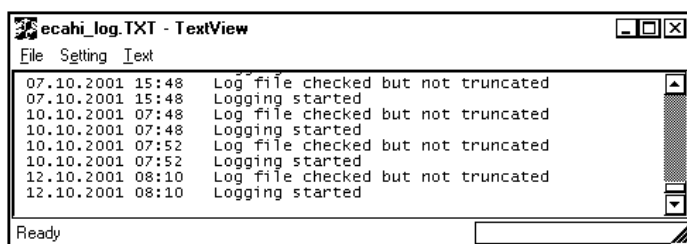

Navigation Sensors

How to select Navigation sensors

User can select navigation sensors used in navigation and view their current values.

Checkbox status shows whether to use the sensor for integrated navigation or not. If there is no value with sensor it indicates that sensor is not valid. Note, that content of these sheets is depending on sensors which are in use on the ship.

Sheet: "SPEED/COURSE"

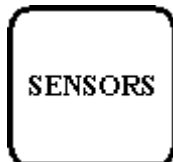

SENSORS pushbutton
To select between
Speed/Course, Position or
Other sheets to be opened
either press button



or go by cursor above
Speed/Course, Position or
Other text and press SELECT

SELECT SENSORS - Source: STBDECDIS			
Speed/Course	Pos	Other	Record
<input type="checkbox"/> Manual speed			[] Kt
<input checked="" type="checkbox"/> Log			16.9 Kt
<input checked="" type="checkbox"/> Dual log (bottom)	> ^		0.0 Kt 16.9 Kt
<input type="checkbox"/> ARPA			16.9 Kt 257.5 °
<input type="checkbox"/> Manual heading			[] °
<input checked="" type="checkbox"/> Gyro 1			257.3 °
<input checked="" type="checkbox"/> Gyro 2			257.3 °
<input checked="" type="checkbox"/> Rate gyro	(calc.)		-2.0 °/min

Source:

In a multiple Workstation environment verify that Sensor source indicated Initial Setting is the intended one.

Manual speed:

If selected, user can enter value (Kt) for Speed.

Note: This is used only if there are no other Speed or SOG sensors selected.

Log:

If selected, sensor is used as water speed source. **(no pulse)** is used to indicate that a log device with closed contact relay interface using 200 pulses/nm does not give any pulses and thus the speed might be wrong. If Log is selected and "no pulse" condition is detected, then system generates alarm "2005 Log data unreliable".

Note: If you have a dual axis Doppler log, which can measure both water and bottom track, then installation parameters could be set to receive water track as log device.

Dual log (water):

If selected, sensor is used as speed and course source. **(water)** is used to indicate that this information is from water track of dual log.

Dual log (bottom):

If selected, sensor is used as speed and course source. **(bottom)** is used to indicate that this information is from bottom track of dual log.

ARPA:

If selected, sensor is used as speed and course source. Radar might tell its source of speed and course. Following alternatives are available: **(bottom)** if source is a log operating in bottom track, **(water)** if source is a log operating in water track, **(posit.)** if source is a position receiver such as GPS, **(manual)** if source is a manual entry, **(reflgt)** if source is a tracked target.

Manual heading:

If selected, user can enter Heading.

Note: This is used only if there are no other Course sensors selected.

Gyro1:

If selected, sensor is used as heading source. **(mag)** is used to indicate value from a magnetic heading source. True heading source has no indication. If the source of Gyro1 is a gyro with synchro or stepper interface, then indication **(require set)** is used highlight that you need to set a new initial value for the gyro.

Gyro2:

If selected, sensor is used as heading source. **(mag)** is used to indicate value from a magnetic heading source. True heading source has no indication.

If you have both gyro1 and gyro2 selected and if they value differs more than 5° then system generates alarm "2004 Gyro data unreliable".

Rate gyro:

Sensor is used as Rate of Turn source. **(calc.)** is used to indicated Rate of Turn calculated from Gyro movement.

Note: This release of program always selects Rate gyro.

How to set initial value of a Gyro1

Gyro1 could be interfaced based on serial data and thus you don't need to set the initial gyro value. However it is very common that your Gyro1 is interfaced based on synchro or stepper interface. Then you need to set the initial value of the Gyro1. If your Gyro1 requires initial value, then there is an indication **(require set)**; see below.

<input checked="" type="checkbox"/> Gyro 1 (require set) °
--

To set initial value use Initial Settings; see below.

INITIAL SETTINGS	
Datum	WGS 84
Gyro	348.6°
Position discrepancy limit	0.00 nm

Sheet "POSITION"

To select between
Speed/Course, Position or
Other sheets to be opened
either press button



or go by cursor above
Speed/Course, Position or
Other text and press SELECT

SELECT SENSORS - Source: STBD ECDIS

Speed/Course	Pos	Other	Record
<input type="checkbox"/> Alignment	Start		
<input type="checkbox"/> Enable chart align			
Range	0.0 nm	Bearing	0.0°
<input type="checkbox"/> Dead reckoning			
Lat	60°04.726N	Lon	024°48.089E
Kalman filter	Off		
10.0Kt	243.2°		
Lat	60°04.693N	Lon	024°47.970E
GPS1	Primary	Diff	
10.0Kt	243.2°	Datum	
Lat	60°04.729N	Lon	024°48.099E
GPS2	Secondary		
10.0Kt	243.2°		
Lat	60°04.680N	Lon	024°47.924E

The field of a position sensor contains a label (here GPS1 and GPS2) which indicates the name of the sensor; a status (primary/secondary/off) which indicates, if the sensor is included or not; position in conning position and local datum; speed and course which has (mag) if the course is referenced to magnetic north. A DGPS position sensor has additional text Diff, if differential signal is in use. There are three different reason to display Lat/Lon values of Position sensor in red colour and with additional text.

- Kalman filter has excluded the sensor from its estimated position. Additional text is "Excluded"
- Received position from position sensor is in another Datum as set to be received in ECDIS. Additional text is "Datum"
- If position sensors have position discrepancy active. Additional text is "Discrepancy".

Position sensors have priority, which is indicated using sensors as primary and as secondary positioning source. Only one sensor can be primary while the others can be secondary or off. After **off**-state a position sensor is changed to **secondary**-state. After **secondary**-state a position sensor is changed to **primary**-state and if there was already a position sensor with **primary**-state it will be changed automatically to **secondary**-state. When the position source is changed based on priorities and signal validity to another position source, then you get alarm "**2009 Position source change**". Note that alarm 2009 is active only without Kalman Filter because the filter has his own process to calculate estimated position and in that process priority given by primary and secondary is not used.

If a DGPS selected as **primary** or **secondary**, changes its status from "no Diff" to "Diff" or from "Diff" to "no Diff" the system generates alarm "**4027 DGPS pos. Source change**" (alarm numbers are from 4027..4032 depending of position receiver).

Pri no alarm and **Sec no alarm** can be used with DGPS if you want disable alarm "**4027 DGPS pos. source change**". These selection are intended for area where the differential coverage is fading. One example is if you sail along coastline but so far away that the differential signal changes its status very often.

The system generates an alarm "**4038 Datum mismatch**" (alarm numbers are from 4038..4043 depending of position receiver), if output Datum of a selected Position sensor (status any other than Off) is changed from WGS84 to another Datum or if selected Position sensor does not send Datum message. Additional text "Datum" in red appears. Lat/Lon values of Position sensor turns red. If the position sensor is used for system position also Kalman filter and own ship position (Lat/Lon values and used Datum) are indicated in red colour. If output Datum of a selected Position sensor is changed from no Datum message or another Datum to WGS84 and, if the user has used

selection **Primary** or **Secondary**, then the system generates alarm "**4044 Datum change**" (alarm numbers are from 4044..4049 depending of position receiver).

NOTE, The ability to check datum of position is a relatively new feature for position receivers. It was introduced in standard IEC 61162-1 Ed2 Published in July 2000. Only EPFS (for example GPS or DGPS) ,which has "IEC 61162-1 Ed 2 (2000-7)" indicated in their type approval certificate can support the ECDIS to detect Datum mismatch.

The system generates an alarm "**2007 Position discrepancy**" if there is discrepancy in position. Together with this alarm system shows in **Pos** page of Sensor text "Discrepancy" in red for Position sensor which has position discrepancy active.

Enable chart align:

If selected, user is able to do a chart alignment by using CHART ALIGN button.

Alignment:

Alignment is selected automatically if user has defined position offset by CHART ALIGN push button. The offset values are given in Nautical Miles and degrees. If position alignment is used then user is reminded of it every 30 minutes by Alarm "**2011 ChartAlign: over 30 min**".

Dead reckoning:

The system select automatically Dead reckoning, if there are no valid and selected position sources and if there are valid and selected speed and course sources. If system has selected Dead reckoning, then the user can enter a new position for the ship in the LAT. and LON fields.

Kalman filter:

If selected, Kalman filter calculates the estimate of position using simultaneously all valid and selected position, speed and course sensors. To read more information about Kalman Filter, see "Filter Operation" on page 343

Sheet "Other"

To select between Speed/Course, Position, Other or Record sheets to be opened either press button



or go by cursor above Speed/Course, Position, Other or Record text and press SELECT

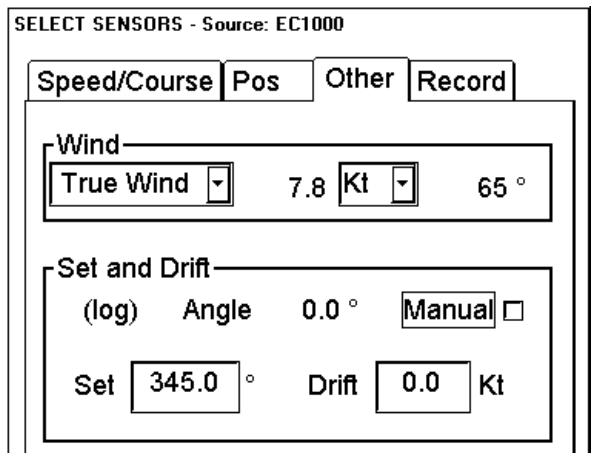

True wind:

In this field Wind (True or North) speed (Kt or m/s) and course are displayed. Note: true wind is wind relative to own ship heading. For more information, see chapter "Wind sensor" on page 353.

Set and Drift:

If user selects Manual tick box, this enables user to set manually speed and course of drift. Note: You can select manual drift only if there are no automatic sources of SOG and COG. (i.e. You neither have a dual axis log nor any position receiver available.)

Angle = difference between heading and COG

Spd = speed component of the drift vector

Crs = course component of the drift vector

Vector defined by (SOG and COG) is equal to vector sum of vectors defined by (SPD and HDG) and (set and drift).

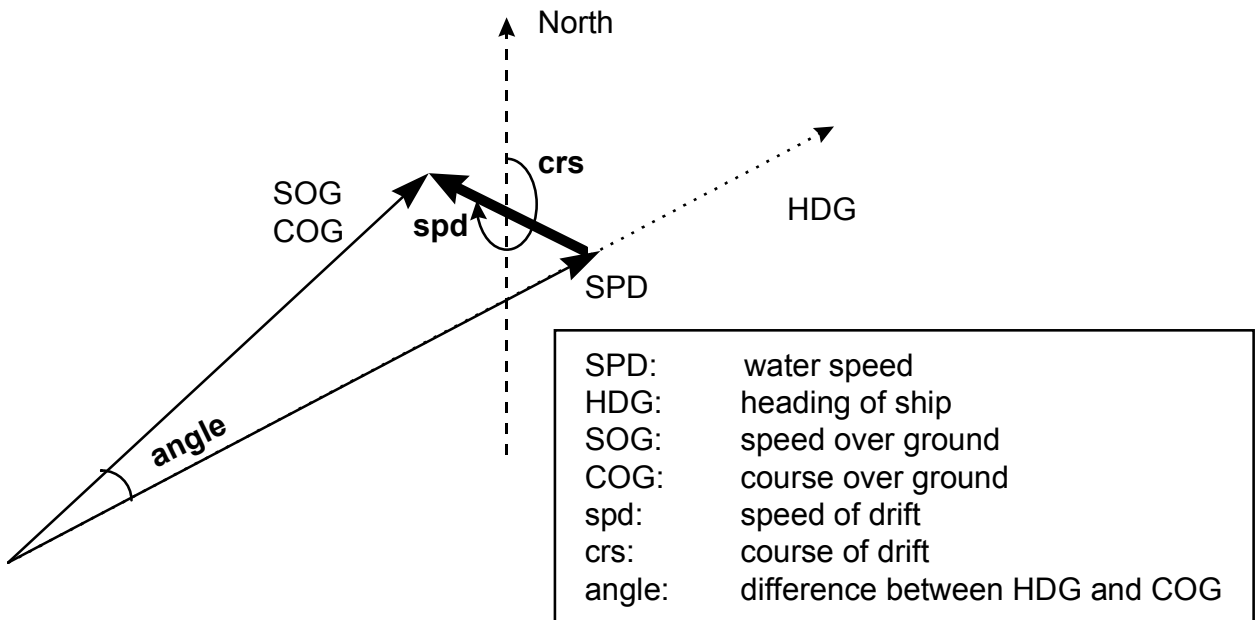

Source of position

Use Figure below to find source of position. Kalman filter uses all position sensors, which have either **primary** or **secondary**, as input for its calculation. GPS in differential operation mode and SYLEDIS position sensors (high precision position sensors) are considered better than other position sensors.

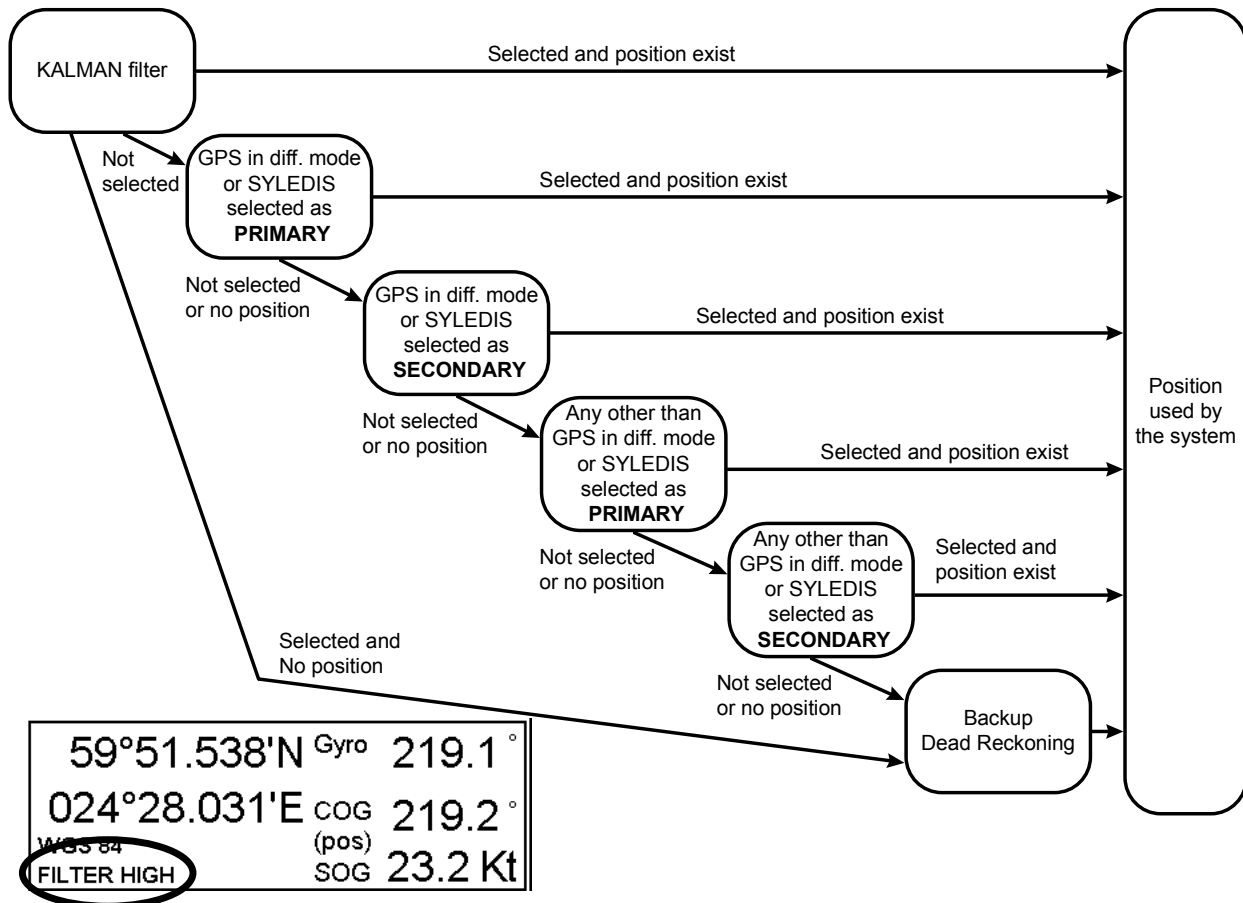

Position used by the System is shown in right hand upper corner of ECDIS display (the example above shows DGPS). Following alternatives are available:

- **NO POSIT**, in red colour, if even no dead reckoning sensors are selected and valid.
- **DEAD REC**, in red colour, if position source is dead reckoning
- **DGPS, GPS, LORAN, DECCA** or **SYLEDIS** if position source is a receiver operating in indicated mode
- **LOST DGPS**, in red colour, if the user selection includes a DGPS device, which doesn't operate in differential mode.
- **FIL LOST DGPS**, in red colour, if the Kalman filter is in use and it includes a DGPS device, which doesn't operate in differential mode.
- **REFTARG**, if position source is tracked ARPA targets controlled by the system
- **FILTER HIGH**, if position source is the Kalman filter with high precision position sensor.
- **FILTER**, if position source is the Kalman filter without high precision position sensors
- **BAD FILTER**, in red colour, if position source is the Kalman filter and the filter has excluded at least one of the selected sensors because of bad behaviour

If the system changes the source of position based on lost sensor data or change of differential mode of a DGPS sensor, then the system generates immediately alarm "**2009 Position source change**". If the Kalman filter is used then the system generates after a time out period of 90 sec alarm "**2010 Filter: Pos source change**".

If a selected DGPS sensor changes its operation mode and if user has used selection **Primary** or **Secondary**, then the system generates alarm "**4027 DGPS pos. source change**" (4027 for first sensor, 4028 for second etc.). These alarms are suppressed if user has used selection **Pri no alarm** or **Sec no alarm**

If source of position include a position sensor which is in **Datum mismatch** condition, then Latitude, Longitude and selected Datum are indicated in red colour.

Primary and Secondary position of own ship

The system has three different positions for own ship: System position, Primary position and Secondary position:

- System position, which is used for navigation and steering. See chapter "Source of position" on page 336.
- Primary position, is the position of sensor which is selected as a primary position source.
- Secondary position, is the position of sensor which is selected as a secondary position source.

The source of Primary position of the own ship is position sensor, which has been selected either as **Primary** or as **Pri no alarm**.

The source of Secondary position of the own ship are position sensors, which have been selected either as **Secondary** or as **Sec no alarm** (see figure below). Secondary position of the own ship is not available as latitude/longitude value for the user.

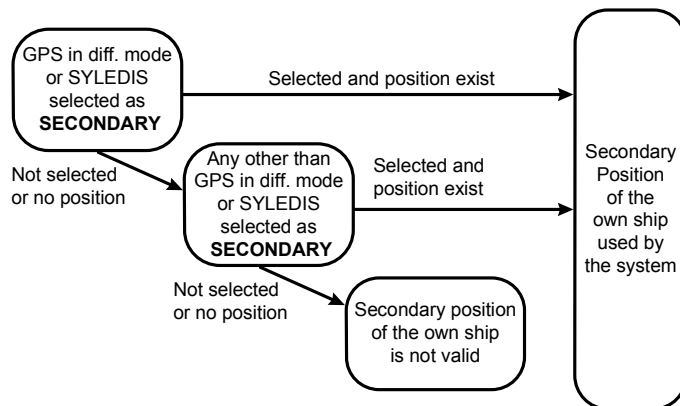

System, Primary and Secondary position of the own ship are available as past tracks on ECDIS screen. You can control their visibility from Tracking sheet of Chart Details (see example below where "Ship System" has been selected to be displayed).

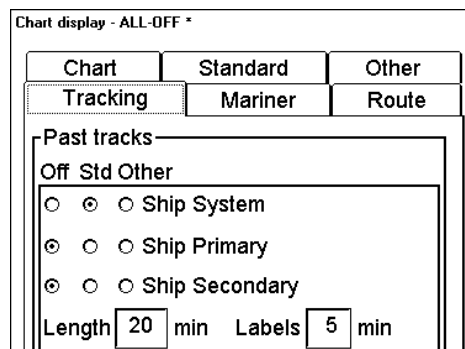

Position discrepancy alarm

You can activate alarm "**2007 Position discrepancy**". The alarm is active between Primary position and any Secondary positions. Also the alarm is active between the own ship position and any positions. To deactivate alarm set limit as 0.00. You can set the limit for alarm from Initial Settings.

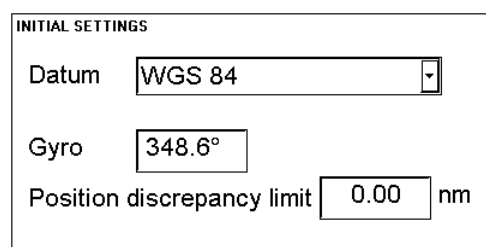

Source of SOG, COG, speed, heading, rot, drift and docking speed components

Use figures below to find source of various navigation data. "SOG, COG" is speed and course over ground. "Speed" is speed over water, "Drift" is difference between speed over water and ground. Docking speed components are: bow speed (transversal), stern speed (transversal) and center speed (longitudinal).

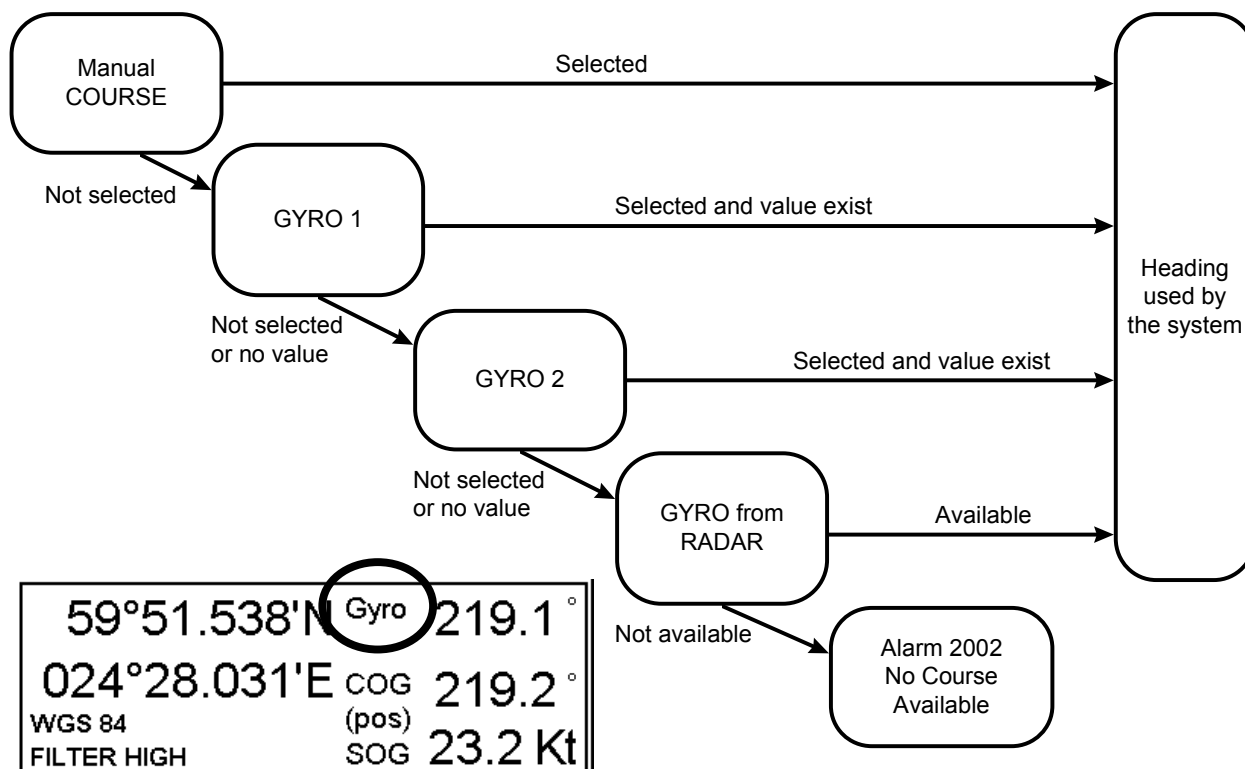

59°51.538'N	Gyro	219.1 °
024°28.031'E	COG	219.2 °
WGS 84	(pos)	
FILTER HIGH	SOG	23.2 Kt

Heading used by the System is shown in right hand upper corner of ECDIS display. In this case heading is received from Gyro and it is shown without specific indication (see the example above). Following alternatives are available: **without specific indication**, if value is referenced to true north; **(mag)** if value is referenced to magnetic north, **(man)** if value is based on manual entry; **(corr)** if value includes gyro correction. Note that **(corr)** is displayed in red colour. Exception for above is settings for "DNV NAUT-AW" where dual gyro interface is required. For information of dual Gyro installation, see chapter "Double Gyro interface for DNV NAUT-AW" on page 341.

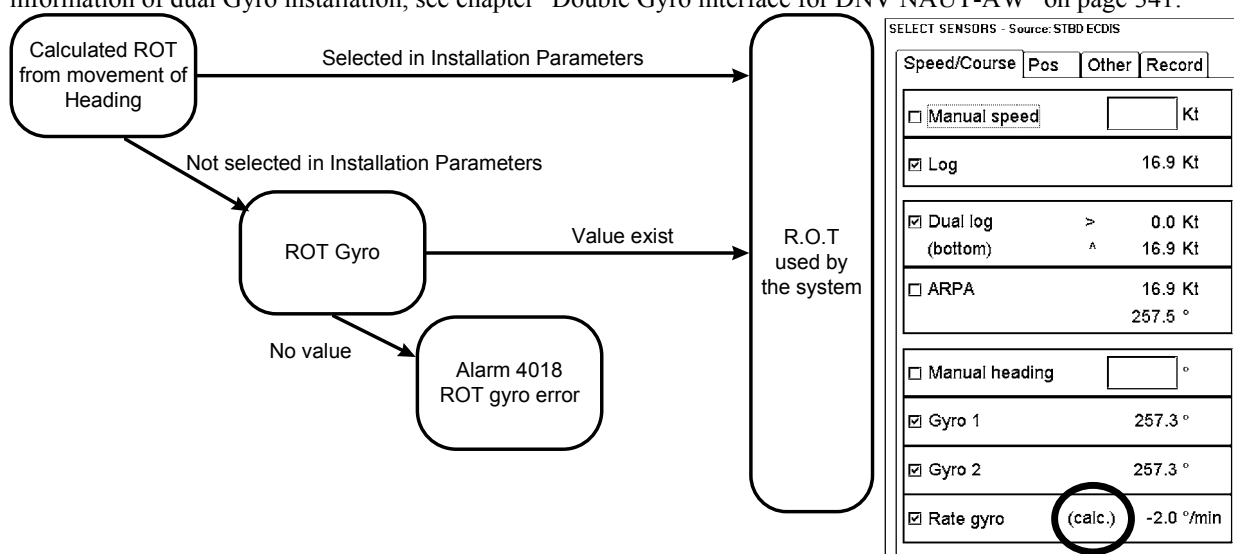

SELECT SENSORS - Source: STBD ECDIS			
Speed/Course	Pos	Other	Record
<input type="checkbox"/> Manual speed			Kt
<input checked="" type="checkbox"/> Log			16.9 Kt
<input checked="" type="checkbox"/> Dual log (bottom)	>	0.0 Kt	
	^	16.9 Kt	
<input type="checkbox"/> ARPA			16.9 Kt
			257.5 °
<input type="checkbox"/> Manual heading			°
<input checked="" type="checkbox"/> Gyro 1			257.3 °
<input checked="" type="checkbox"/> Gyro 2			257.3 °
<input checked="" type="checkbox"/> Rate gyro	(calc.)		-2.0 °/min

ROT used by the System is shown in SENSOR Speed/Course sheet. In Rate Gyro field, if there is a text **(calc)** the system calculates ROT from movement of heading and, if there is no text value is received from ROT gyro.

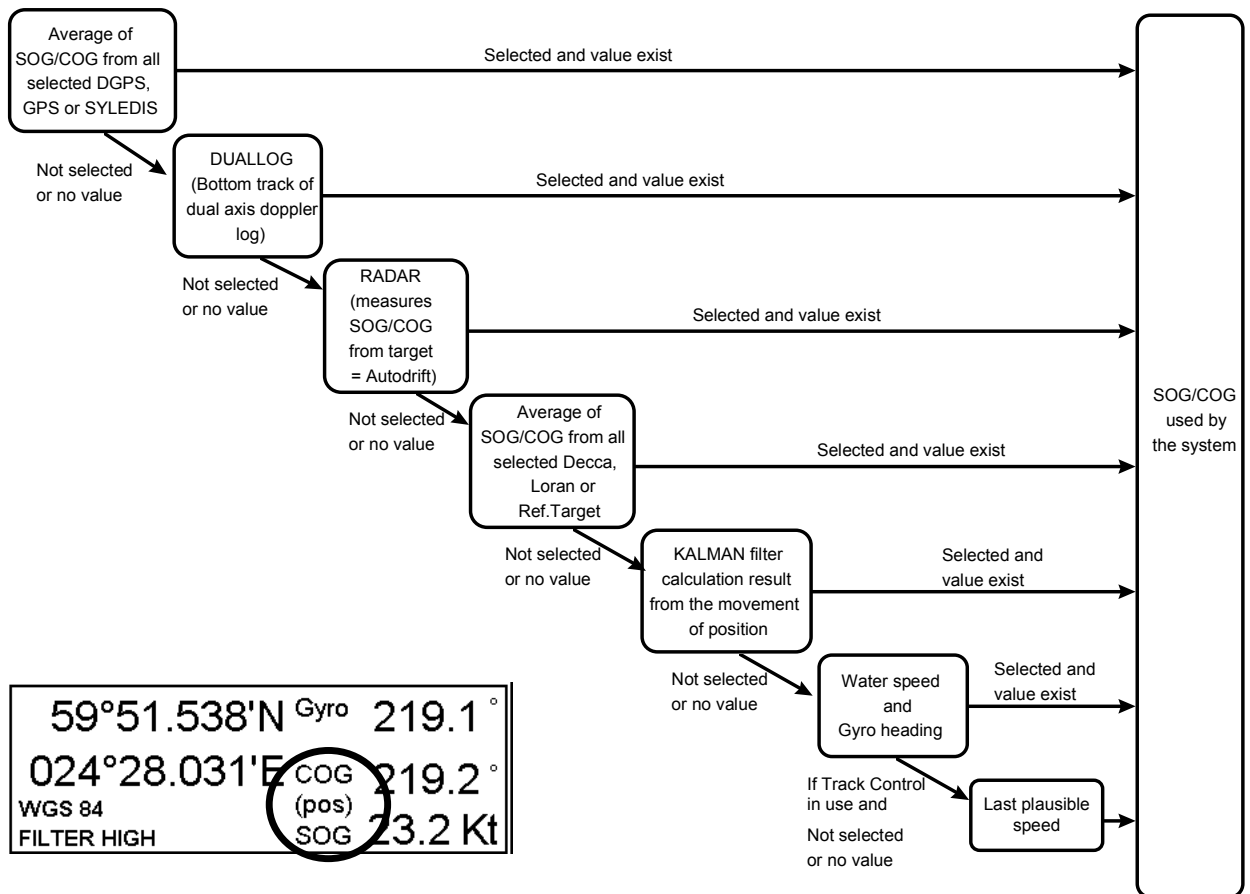

59°51.538'N Gyro 219.1 °
 024°28.031'E COG 219.2 °
 WGS 84 (pos)
 FILTER HIGH SOG 23.2 Kt

SOG/COG used by the System is shown in right hand upper corner of ECDIS display. In this case COG and SOG are from selected position sensors and it is shown as **(pos)**. Following alternatives are available: **(bot)** if value is based on bottom tracking dual axis log; **(wat)** if the value is based on water tracking log, **(rtgt)** if the value is based on target tracking in the connected ARPA radar, **(arpa)** if the value is based on mixed sources of COG and SOG in the connected ARPA radar, **(pos)** if value is based on average of selected position sensors; **(filter)** if value based on Kalman Filter; **(man)** if value is based on manual entry, **(LAST)** if value is based on last plausible speed. Note that (pos), (bot), (wat) and (man) could come from direct interfaces of the system or from the connected ARPA radar.

(LAST) is a special case which is used if all speed sources were lost in middle of track control mode. Track control modes include Goto Wp, Goto Track and Program Track. If last plausible speed is used then the value of own ship position, sog and cog are in red colour.

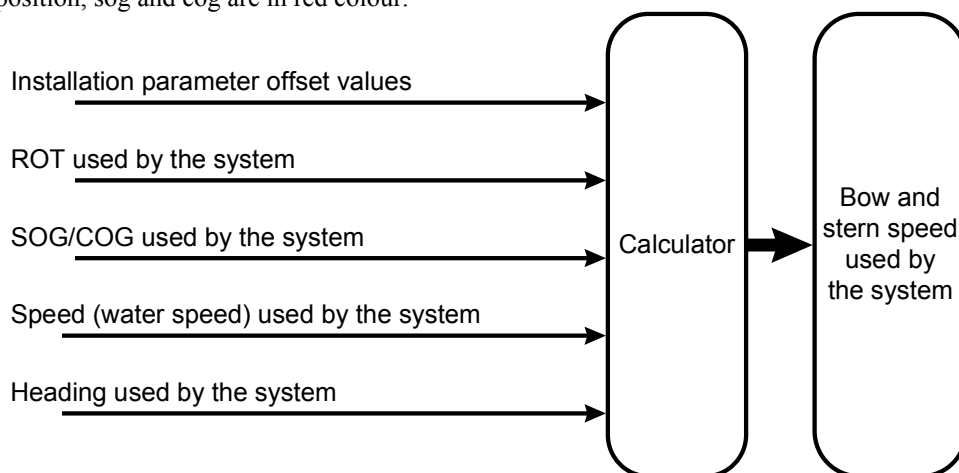

The figure above show the source of docking speed components used for predictor.

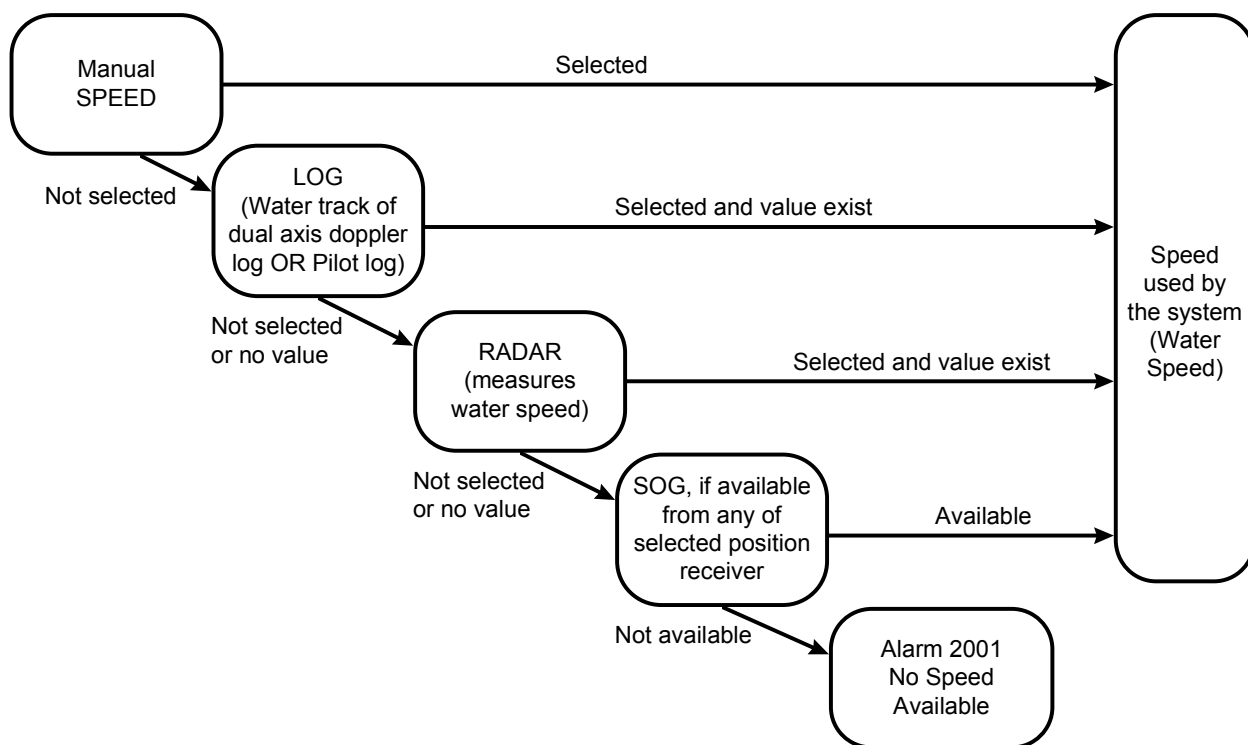

The figure above shows the source of water speed used for drift calculation.

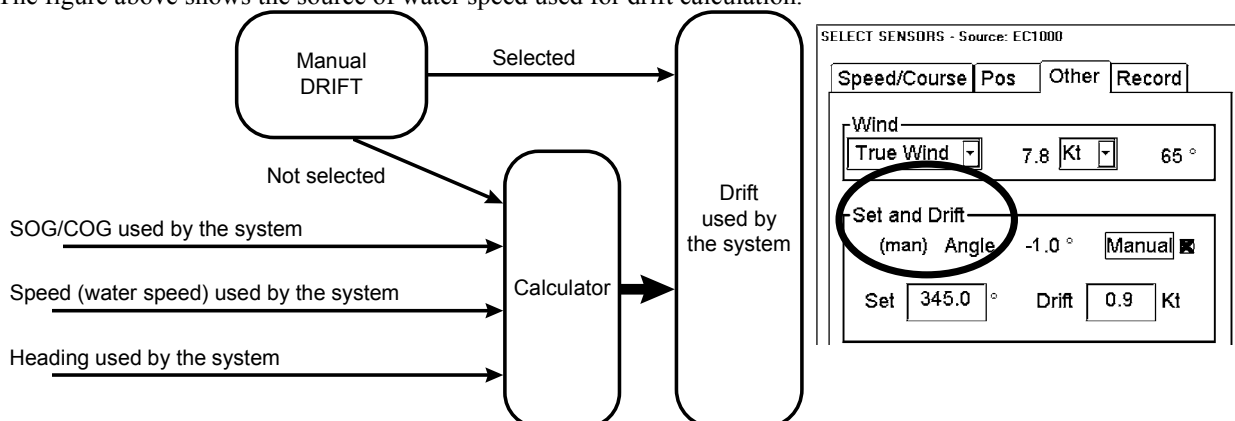

Drift used by the System is shown SENSOR Other Sheet. In this case it is from manual drift. Following alternatives are available: **(log)** if value is based on log or dual axis log; **(posit)** if value is based on position sensor; **(filter)** if value based on Kalman Filter; **(man)** if value is based on manual entry.

Alarm related to SOG, COG, speed, heading, rot, drift and docking speed components

It is possible that user has not selected any speed or heading sensors, or that the selected sensors doesn't have any valid values. This kind of a situation is critical for the system, because it cannot perform even dead reckoning. When no speed source is available the system generates alarm "**2001 No speed available**". When no heading source is available the system generates alarm "**2002 No heading available**".

It is possible that system finds out that SOG and/or COG from the sensors are scattered, then an alarm "**2013 SOG&COG unreliable**" is generated. Note that source of SOG and COG is not only Speed and Course sensors, but the source can also be position equipment. For more information about priority of source of SOG/COG, see chapter "Source of SOG, COG, speed, heading, rot, drift and docking speed components" on page 338.

Verify and select valid sensors in **Speed/Course** and **Pos** pages of Sensor window for SOG&COG used by the system.

Double Gyro interface for DNV NAUT-AW

DNV NAUT-AW requires double gyro interface for Track Control System, which consists of ECDIS and trackpilot. The benefit of this arrangement is that loss of a single gyro do not interrupt track control. The Track Control System can smoothly continue with backup gyro.

Double gyro interface is build by connecting two Gyros (Gyro 1 and Gyro 2) directly to trackpilot. There is a selection switch (First priority Gyro selector), which is used to select Heading source for Trackpilot, ECDIS and common gyro distribution unit. In ECDIS there is on Sensor page text indication (active or backup) after Gyro 1 or Gyro 2 to indicate state of "First priority Gyro Selector" switch.

System perform smooth transition (i.e. without unexpected large rudder movements) from one gyro source to another gyro source. This smoothing is used both for user requested changes (i.e. user change position of "First priority Gyro Selector") and for automatic changes (i.e. automatic continuation with backup source).

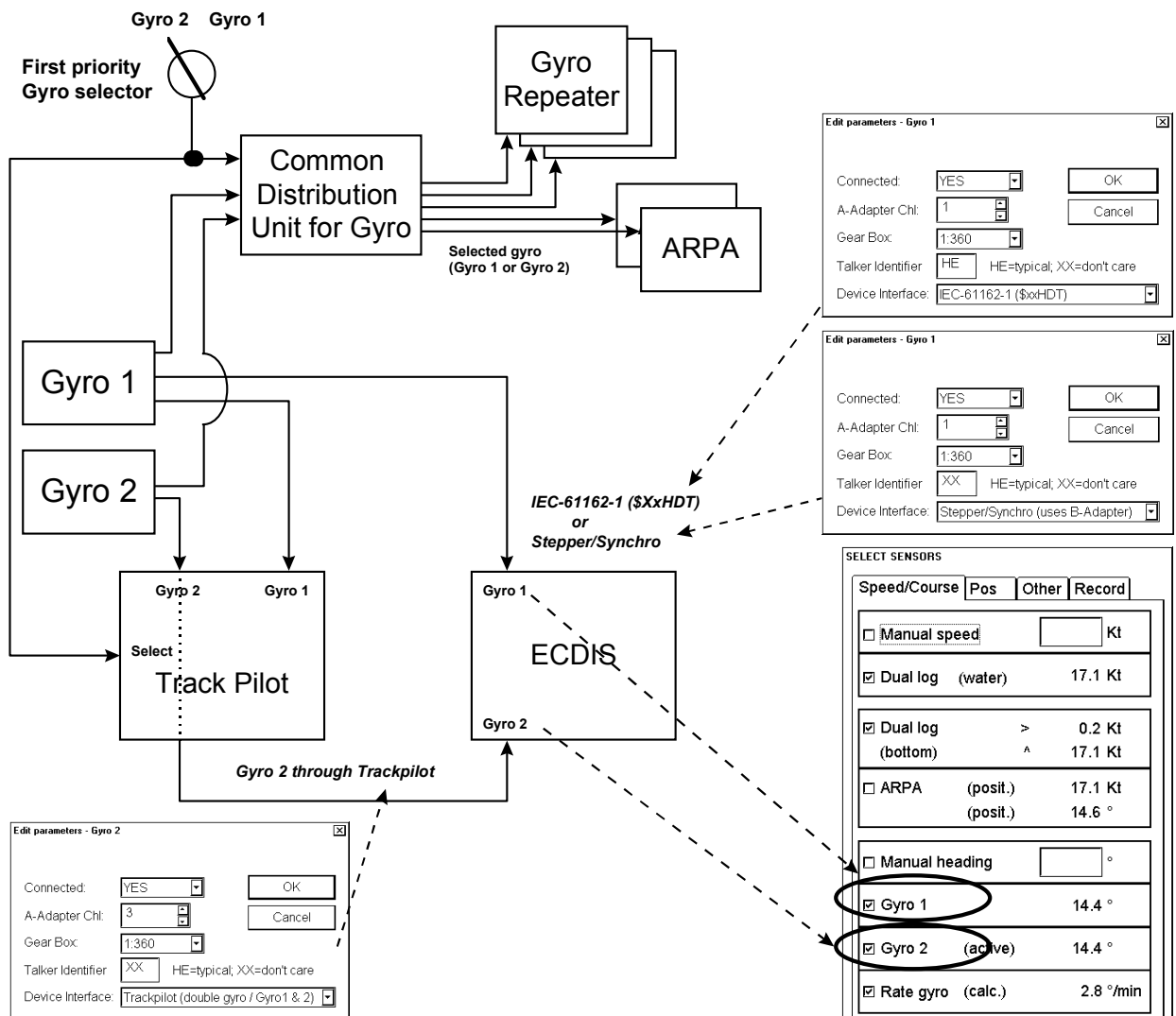

Gyro data distribution for Track Control System.

Indication of gyro source

On Information area

Possible indications on Upper right corner of ECDIS

- (1), indicates that heading used by ECDIS is from Gyro 1.
- (2), indicates that heading used by ECDIS is from Gyro 2.

- (cor1), indicates that heading used by ECDIS is from Gyro 1 and that gyro correction has been used
- (cor2), indicates that heading used by ECDIS is from Gyro 1 and that gyro correction has been used
- (mg1), indicates that heading used by ECDIS is from Gyro 1 which is a magnetic compass
- (mg2), indicates that heading used by ECDIS is from Gyro 1 which is a magnetic compass

58°59.332'N	Gyro (2)	240.0 °
021°30.230'E	COG (pos)	240.0 °
WGS 84	SOG	17.1 Kt
DGPS		

Above is an example where "First priority Gyro selection" switch is in state Gyro 2.

On Select Sensor window

Possible indications on Speed/Course page of Select Sensors:

- (active), indicates that system uses value from this Gyro which is selected by "First priority Gyro Selector"
- (backup), indicates that system uses value from this Gyro which is NOT selected by "First priority Gyro Selector"

For more information of gyro selections, see examples below

In left hand side example, heading information from Gyro 2 is used by Trackpilot and ECDIS. Indication (active) in Gyro 2 field on Speed/Course page of Select Sensors window indicates that system used gyro from user selected source of heading (State of "First priority gyro selector" switch). In this case the indication on upper right corner of ECDIS is shown as (2).

In right hand side example, heading value from Gyro 1 is lost. System selects automatically Gyro 2 to be used as a source of heading. Indication (backup) in Gyro 2 field indicates that backup gyro is used.

SELECT SENSORS			
Speed/Course	Pos	Other	Record
<input type="checkbox"/> Manual speed			Kt
<input checked="" type="checkbox"/> Dual log	(water)		17.1 Kt
<input checked="" type="checkbox"/> Dual log	>	0.2 Kt	
(bottom)	^	17.1 Kt	
<input type="checkbox"/> ARPA	(posit.)	17.1 Kt	
	(posit.)	14.6 °	
<input type="checkbox"/> Manual heading			°
<input checked="" type="checkbox"/> Gyro 1			14.4 °
<input checked="" type="checkbox"/> Gyro 2	(active)		14.4 °
<input checked="" type="checkbox"/> Rate gyro	(calc.)		2.8 °/min

SELECT SENSORS			
Speed/Course	Pos	Other	Record
<input type="checkbox"/> Manual speed			Kt
<input checked="" type="checkbox"/> Dual log	(water)		16.9 Kt
<input checked="" type="checkbox"/> Dual log	<	0.2 Kt	
(bottom)	^	16.9 Kt	
<input type="checkbox"/> ARPA	(posit.)	16.9 Kt	
	(posit.)	27.1 °	
<input type="checkbox"/> Manual heading			°
<input checked="" type="checkbox"/> Gyro 1			
<input checked="" type="checkbox"/> Gyro 2	(backup)		26.2 °
<input checked="" type="checkbox"/> Rate gyro	(calc.)		8.5 °/min

Associated alarms

When no gyro value is received from gyro selected by **First priority gyro selection**, alarm **AL 10** (Missing working gyro) is generated on Trackpilot.

When no gyro value is received from gyro not selected by **First priority gyro selection**, alarm **AL 11** (Reference gyro missing or Compass comparison alarm) is generated on Trackpilot. Note that alarm **AL 11** is activated also if deviation between Gyro 1 and Gyro 2 is too big (default is 12°).

ECDIS generate **alarm 4005** for missing Gyro 1 and **alarm 4006** for missing Gyro 2. If deviation between gyro 1 and gyro 2 is over 5°, then ECDIS generate **alarm 2004 Gyro data unreliable**.

Filter Operation

The ECDIS includes an automatic multisensor Kalman filter for position. The filter can calculate the estimate of position using simultaneously all operative position sensors.

Position sensors are shown by pressing SENSORS pushbutton.

Operator can manually include or exclude different sensors. Remaining sensors (= sensors with any other selection than OFF) are included in the filter processing. The purpose of this filter is to continuously monitor the position given by each individual sensor and define if the sensor is reliable or not. Also selected Gyro and Log sensors are included into this analysis. The filter knows the different behaviour between different type of sensor. (Loran, Decca, GPS, DGPS etc.). The result of the filter is a smooth position which is used to as final position of the ship. Filter eliminates all jumps in the final position even if there is a position jumps in a sensor. (Decca line change, loss of differential signal with DGPS etc.)

The filter can be selected or deselected by switching ON or OFF the state of the filter. Change from ON to OFF set new start position of the filter as average value of the enabled sensors (sensors with any other selection than OFF). Change from OFF to ON set the filter to continue from the current position.

When filter is selected, it operates from the alarm system point of view like a position source - alarms are generated if the system do not have a valid position available. No alarms are generated for jumps of the position sensors selected to be used with filter as long as the filter is able to estimate a reliable position based on selected position sensors. If there is a change in the availability of the sensor selected with Kalman Filter and if the filter cannot continue the same level of position accuracy, then the system generates alarm **"2010 Filter: Pos source change"**. This change of available sensor may or may not affect the operation of the Filter.

Filter requires at least one position sensor and one course sensor (i.e. gyro) selected and valid in order to operate. The filter has one main alarm **"2000 Filter: Pos unreliable"**. This means that the filter is not able to calculate the position from the connected sensors. This can happen, if there is only one position sensor connected and the position of that one becomes unreliable or if there are more position sensors but they are deviating too much among them. Alarm can appear also if the speed/ course sensor is found to be not reliable (Log or Gyro). Note that filter indicate unreliable position sensors by changing the colour of their position into red.

If the filter is used without automatic Route Steering, then in case of alarm 2000 only filter itself is set in OFF state. After the alarm 2000 the system will use its normal method to select position source from available sensor. Normally this cause a jump in the position of the system. After the alarm 2000, the user should evaluate which sensor caused the problem. Disable the bad sensor and then you can select the filter ON again.

Kalman filter is build to support automatic Route Steering and thus its model of the ship including navigational sensors require that you have some speed. If the speed is less than set value of installation parameter (for example 4 kn), the system generates alarm **"2008 Filter: Speed below 4 kn"**. If you don't use automatic Route Steering the system also selects the filter as OFF after the alarm 2008. With automatic Route Steering the system keeps the filter selected, but repeats alarm 2008.

System can check that each selected position sensor is within position discrepancy limit set by the user (see more chapter "Position discrepancy alarm" on page 337). If a position sensor has position discrepancy active, it is automatically excluded from Kalman Filter. This feature enables user to control how much discrepancy there can be between Kalman Filter position and any position sensor.

Filter and automatic Route Steering

The filter can operate based on only one position sensor and one gyro. However this minimum selection is not suitable for automatic Route Steering or Program Track, which both require an independent speed source. With automatic Route Steering the minimum selection is for GOTO WAYPOINT:

- one position sensors, gyro and log or
- two position sensors and gyro

And for GOTO TRACK:

- one high precision position sensors, gyro and log or
- one high precision position sensor, second position sensors and gyro

Source of position indicates what kind of sensors the Filter is using for position calculation. The permanent indication is available in upper right hand corner:

- FILTER, there is no high precision position sensor selected and available for Filter.
- FILTER HIGH, there is high precision position sensor selected and available for Filter. It is possible to use track steering modes which requires accurate position (Goto Track, Program Track).

If you try to enable automatic Route Steering without Kalman filter positioning, the system generates alarm "**2470 Disabled: Needs filter on**". If you try to enable automatic Route Steering while ship is located outside channel limits of Monitored route, the system generates alarm "**2477 Disabled. Out of channel**". If you try to enable automatic Route Steering without independent speed source, the system generates alarm "**2490 Disabled: Needs log sensor**". If you try to enable automatic Route Steering for GOTO TRACK mode without high precision position sensor available, the system generates alarm "**2491 Disabled: Needs diff pos.**".

If you loose during automatic Route Steering the Kalman Filter position, the system generates alarm "**2475 Route: Needs Filter ON**". If you loose during automatic Route Steering a log device and your remaining selection doesn't meet the minimum, the system generates alarm "**2476 Route: Needs log sensor**". If you loose during automatic Route Steering GOTO TRACK mode a high precision position sensor and your remaining selection doesn't meet the minimum, the system generates alarm "**2492 Route: Needs diff pos.**".

If you loose during Program Track the Kalman Filter position, the system generates alarm "**2493 ProgTrack: Needs Filter ON**". If you loose during Program Track a log device and your remaining selection doesn't meet the minimum, the system generates alarm "**2495 ProgTrack: Needs log sensor**". If you loose during Program Track a high precision position sensor and your remaining selection doesn't meet the minimum, the system generates alarm "**2494 ProgTrack: Needs diff pos.**".

If the filter is used with automatic Route Steering, then in case of alarm "**2000 Filter: Pos unreliable**" all position sensors and filter itself are changed to OFF state and the system continues with backup dead reckoning based on selected speed / course sensors. It is recommended that you leave then automatic Route Steering and continue using more traditional steering mode during the period you solve the reason for alarm 2000. If you don't leave automatic Route Steering, then the system will repeat alarm "**2475 Route: Needs filter ON**" every 15 seconds. Also after alarm 2000 the system generates alarm "**2006 Route: CRS jump possible**" to remind you that if you now continue automatic Route Steering and just select one of the position sensors, then most probably your ship will perform a turn as a consequence of new position. As summary after the alarm 2000, the user should leave automatic Route Steering and evaluate which sensor caused the problem. If the ship position from the a position sensor is acceptable, switch it on. Don't select any sensor which causes jumping. Then you can select the filter ON again and continue automatic Route Steering.

How to use position alignment

The position alignment function is in order to final adjust the ship position by using Radar echo overlay, Reference target, radar echo target and ECDIS chart material.

If position alignment is in use, the ECDIS will generate following alarm every 30 minutes to remain user for alignment: **"2352 ChartAlign: over 30 min"**.

Position alignment by means of the ECDIS

If the radar echo targets and the Reference target's symbols are not exactly overlapping there is either position error or gyro error or some combination of these errors.

It is possible to do position alignment on the ECDIS display by moving own ship position or by moving ARPA radar target position. Moving is done by dragging and dropping own ship symbol or ARPA radar target to desired location. Before you are able to drag and drop, you have to select **Enable chart align** in Sensor/Position sheet. Drag and drop means that you take cursor above desired object and press **Chart align** button. Keep button down and move own ship symbol or ARPA radar target to the desired position by track ball.

Note, if Radar Echo Overlay is on the ECDIS display when position alignment is done, then

- Mode of Radar Echo Overlay is temporarily changed to "Radar over Chart"
- ECDIS uses temporarily Radar Echo Overlay color also for own ship and ARPA targets symbols

To make position alignment, proceed as follow:

1. Select desired chart material (ARCS or S57).
2. Select suitable radar target manually for tracking or use suitable Reference target file for automatic tracking. To start monitoring of Reference target use:

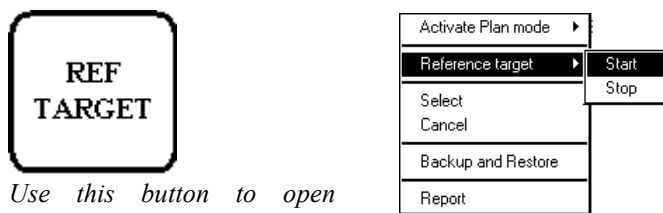

Use this button to open Reference target menu

3. Select **Enable chart align** in Sensor/Position sheet.

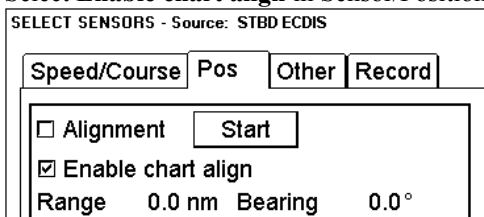

4. Use the track ball of Control Panel to **drag and drop** principle to overlap a reference target and a symbol or suitable chart detail. (Drag and drop own ship position to get reference target and chart object to overlap). See figures below.

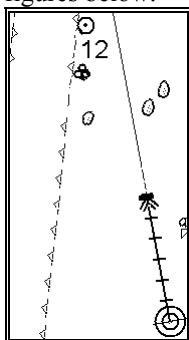

Before position alignment

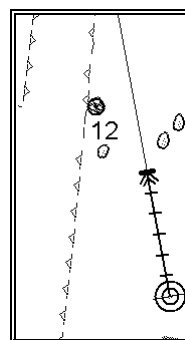

After position alignment

5. If the position source is Dead Reckoning, then chart align was used to set a new start position to the Dead Reckoning. In this case there is no offset and no indication test OFFSET. If the position source is something else than Dead Reckoning, then the indication of **OFFSET** is displayed on Upper information area. Also the Range and Bearing of the **OFFSET** are shown in Sensor position sheet. See figures below.

You can see Range and Bearing of OFFSET in Position sheet.

SELECT SENSORS - Source: STBD ECDIS

Speed/Course	Pos	Other	Record
<input checked="" type="checkbox"/> Alignment Start			
<input checked="" type="checkbox"/> Enable chart align			
Range	0.2 nm	Bearing	47.9°

Indication of OFFSET is displayed on the ECDIS screen.

60°01.538'N	Gyro	89.9°
025°01.031'E	COG	89.9°
WGS 84	(pos)	
DGPS	OFFSET	SOG 17.2 Kt

How to reset position alignment

To reset position alignment, proceed as followed:

1. Press **Sensors** button and select Position sheet open.
2. Remove selection from **Alignment** tick box.

SELECT SENSORS - Source: STBD ECDIS

Speed/Course	Pos	Other	Record
<input type="checkbox"/> Alignment Start			
<input type="checkbox"/> Enable chart align			
Range	0.0 nm	Bearing	0.0°

Alignment field after Alignment selection has removed.

3. Check that indication of **OFFSET** disappears on the Upper information area.

60°01.538'N	Gyro	89.9°
025°01.031'E	COG	89.9°
WGS 84	(pos)	
DGPS		SOG 17.2 Kt

The Upper information area after Alignment selection has removed. There is no **OFFSET** indication.

Position alignment by means of the ARPA radar

User chart, showing coast line, buoys, etc., can be used as a position reference once the ARPA radar is able to see these objects. If the ARPA radar targets and the User Chart are not exactly overlapping there is either position error or gyro error or some combination of these errors. Some selected ARPA radar modes which can display User Charts can perform position alignment.

ARPA radar without CHART ALIGN push-button

1. User chart must be available on the ARPA radar. (ARPA radar must be connected to the ECDIS and STORED VIDEO MAP pushbutton of the ARPA radar must be pressed). Press **Sensors** button and select Position sheet open.

Press **Start** button to alignment with radar.

SELECT SENSORS - Source: STBD ECDIS

Speed/Course Pos Other Record

Alignment **Start**

Enable chart align

Range 0.0 nm Bearing 0.0°

2. On the ARPA radar screen, locate a clear reference radar echoes and suitable User Chart lines or symbols.
3. Press **Start** button in Position sheet. If there was no User Chart lines on the ARPA radar display, then system is unable to continue and generate alarm "**2072 ChartAlign: No line avail**". If there was User Chart lines on the ARPA radar the system can continue and as a reminder of the ongoing process it generate and maintain alarm "**2061 Chart Align: Executing**" during the whole process.
4. Use the track ball of the ARPA radar and move the User Chart so that it overlaps radar echoes.

Press **Stop** button when you have defined alignment.

SELECT SENSORS - Source: STBD ECDIS

Speed/Course Pos Other Record

Alignment **Stop** Cancel

Enable chart align

Range 0.2 nm Bearing 47.9°

5. Press **Stop** button in Position sheet. The alarm "**2061 Chart Align: Executing**" disappears automatically and the amount of alignment is transferred to the ECDIS and range and bearing of it is display in this field. If you want to cancel the alignment process then press **Cancel** button and the process is terminated without any new alignment.
6. If the position source is Dead Reckoning, then the system sets a new start position to the Dead Reckoning. In this case there is no offset and no indication text OFFSET. If the position source is something else than Dead Reckoning, then the indication of **OFFSET** is displayed on Upper information area. See Figure below.

60°01.538'N ^{Gyro}	89.9°
025°01.031'E ^{COG}	89.9°
WGS 84 (pos)	
DGPS OFFSET	SOG 17.2 Kt

Upper information area on ECDIS screen.

ARPA Radar with CHART ALIGN push-button

1. User chart must be available on the radar.
2. Press CHART ALIGN push-button on the ARPA radar display once. Then use ARPA radar display track ball and move the User Chart so that it overlaps correct radar echoes. Press CHART ALIGN push button again once. Then the amount of alignment is transferred to the ECDIS.
3. If the position source is Dead Reckoning, then CHART ALIGN set a new start position to the Dead Reckoning. In this case there is no offset and no indication text OFFSET. If the position source is something else than Dead Reckoning, then the indication of **OFFSET** is displayed on Upper information area. See Figure below.

60°01.538'N ^{Gyro}	89.9°
025°01.031'E ^{COG}	89.9°
WGS 84	(pos)
DGPS OFFSET	SOG 17.2 Kt

Upper information area on ECDIS screen.

Gyro error correction

Typical gyro error sources are: installation offset, speed/latitude error and dynamic settling error. Typically you detect gyro error on a User chart superimposed on the ARPA picture, on ARPA targets drawn on the ECDIS screen or on radar overlay drawn on the ECDIS screen.

Gyro error correction is used to remove the difference between the Chart North and the Gyro North.

Gyro error can be corrected totally or partially already in the gyro compass system itself. Many gyro compass systems have automatic speed/latitude corrector, which may use automatic or manual input for speed and latitude. Some gyro compass systems include also correction for dynamic settling error.

Automatic Gyro error compensation based on the Reference targets can be used with all kind of Gyro compass systems to remove any error left.

Automatic Gyro error correction based on tabled speed/latitude correction can be used, if the gyro compass itself does not make any corresponding correction.

Gyro error compensation can be used to:

- correct User chart on ARPA Radar screen.
- correct ARPA target positions on ECDIS screen
- correct radar overlay drawn on ECDIS screen
- compensate courses used in Route Monitoring and automatic Route Steering.

If you have enabled **Gyro error correction** and if this correction has modified the value of the own ship heading, then this condition is always visible in Information Area (upper). See example below. Red coloured (**corr**) indicates that the value of Gyro has been corrected.

60°01.538'N	Gyro (corr)	89.9 °
025°01.031'E	COG (pos)	89.9 °
WGS 84		
DGPS	SOG	17.2 Kt

If you have enabled both **Gyro error correction** from Ship Parameters and **Gyro error compensation** from Route Parameters then **Plan** and **Next** in Information Area (upper) display compensated values (see below). Also course to steer used by automatic Route Steering is compensated in this case.

Plan Speed	20.0 Kt	To WP	3
Plan (corr)	216.9 °	Dist WOP	2.55 nm
Route	216.8 °	Time	06:36
Ch limit	185 m	Next WP	4
Off track	<32 m	Next (corr)	228.4 °
		Turn rad	1.0 nm
		Turn rate	22 °/min

SENSORS

*SENSORS pushbutton
To select between
Speed/Course, Position or
Other sheets to be opened
either press button*

**SELECT
NEXT**

*or go by cursor above
Speed/Course, Position or
Other text and press SELECT*

SELECT SENSORS - Source: EC1000

Speed/Course Pos Other Record

Wind
True Wind 7.8 Kt 65 °

Set and Drift
(man) Angle -1.0 ° Manual
Set 345.0 ° Drift Kt

Pitch and Roll
Pitch ° Roll °

Depth below transducer m
Gyro correction 0.9 ° Table

The current value of Gyro correction and its method is displayed in Sensors, Other sheet. See example above. **Table** indicated speed/latitude table as source, **Manual** indicates manual entry and **RefTarg** indicates tracked reference targets as source.

How to enable Gyro error correction

To operate Gyro error correction effective for radar, ECDIS and route steering, proceed as follow:

1. From Control Panel press **Initial Settings**
2. From menu select **Navigation parameters**
3. From submenu select **Ship and Route parameters**.
4. Select **Auto** in Gyro error correction field to enable Automatic Gyro error correction.

INITIAL SETTING

Set time
Parameter Backup
Digitizer
Backup and Restore
Installation parameters
Navigation parameters ▶
Chart Alarm parameters ▶
Optimization parameters ▶
Print Navigation parameters ▶
Print Optimization parameters ▶
Selftest
Presentation library
Access Server and Diagnostic ▶

SHIP and ROUTE PARAMETERS	
Ship parameters	
Ship max. speed	23.0 Kt
Ship max. height	34.0 m
Ship draught	10.0 m
Gyro error correction	Auto ▾
Gyro spd/lat error	On ▾
Max gyro error correction	3.0 °
Manual gyro correction	0.2 ▴ ▾
Route parameters	
Max rate of turn	200 °/min
Turn end tolerance	2 °
WP approach alarm time	60 s
WP prewarn alarm time	120 s
Route start limit angle	20 °
Default line radius	0.3 nm
Drift compensation	On ▾
Gyro error compensation	Off ▾

Ship parameters field:

Gyro error correction:

- **Off:** This selection disables any gyro error correction.
- **Auto:** This selection enables the automatic Gyro error correction based on Reference targets. This selection is also a requirement to enable correction based on tabled speed/latitude.
- **Manual:** This selection enables the manual Gyro error correction in **Manual gyro correction** -field.

Gyro spd/lat error:

- This selects the automatic Gyro error compensation based on tabled speed/latitude correction. A requirement for this selection is that **Gyro error correction** has been selected **Auto**.

Max gyro error correction:

- This is the limit for the maximum correction allowed. Typical value is 3 degrees.

Manual gyro correction:

- This is used to adjust gyro error manually. Note, that to enable this function you have to switch **Gyro error correction** to **Manual** position.

Route parameters field:

Gyro error compensation:

- Used to select, if set courses in Route steering are corrected for gyro error.

Use Reference targets for automatic Gyro error correction

Gyro error correction can be calculated in real-time using Reference Target function of the system.

The file containing Reference Targets must have at least 8 Reference Targets inserted. The ARPA radar must find simultaneously at least 2 reliable tracked Reference Targets before the position and gyro error can be calculated.

When you start Reference target positioning, Reference target field appears to Sensors Position sheet.

1. Start Reference target positioning.

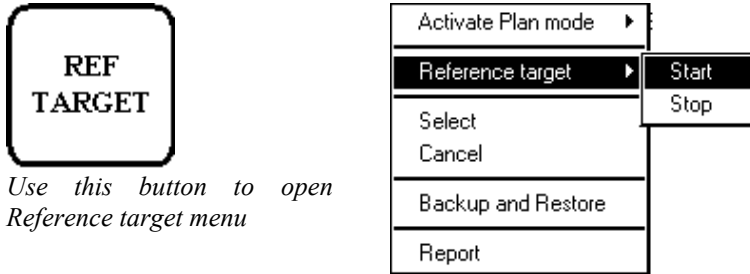

Use this button to open Reference target menu

2. Press **Sensors** button and open Position sheet.
3. Select Reference target as source of positioning. For more information, see "Source of position" on page 336.

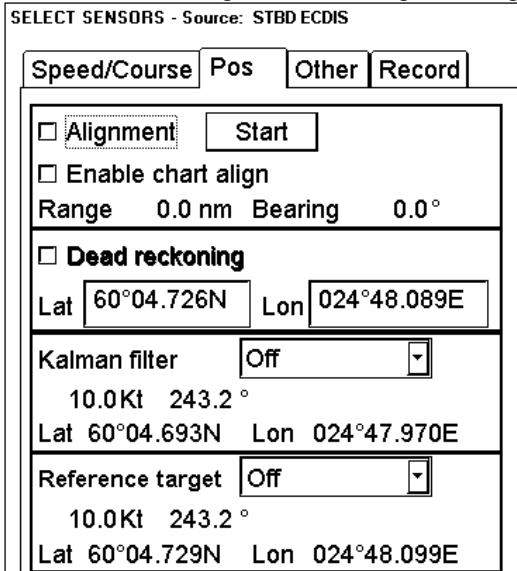

4. When you have in Position sheet **Reference target** field, which shows speed, position and course values, the system has been able to calculate also a value for Gyro error compensation.

NOTE! The system use gyro error from reference targets, if you have selected **Gyro error correction** in **Auto** position and **Gyro spd/lat error** in **Off** position. Reference Target based gyro error correction doesn't require that you also use Reference Targets as position finding method. This feature is very useful when you operate with high accuracy position sensors such as DGPS because both your position is still based on high accurate DGPS and the system can automatically correct the gyro error for you.

Gyro correction related alarms:

"2352 RefTgt: Lost gyro corr", you have selected Reference Targets as gyro correction source and the Reference target system is unable to solve gyro correction.

"2352 RefTgt: Tracking full", if you try to start reference targets and there are less than 8 tracking channels available.

Wind sensor

Connected Wind sensor is available in Sensors Other sheet.

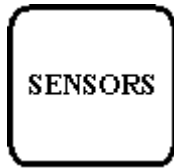

SENSORS pushbutton

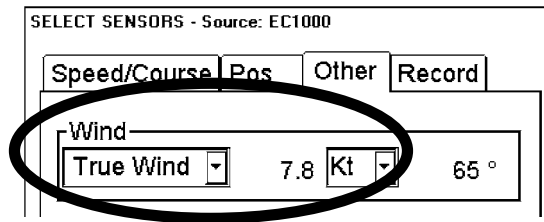

The system displays wind as **True Wind** or **Relative Wind** (see picture below).

Unit of wind can be selected either **m/s** or **Kt**.

The common understanding of wind modes is: The wind as measured by wind meter is known as apparent wind. If indicated wind includes speed compensation it is known as relative wind. If indicated wind includes both speed and heading compensation it is known as true wind,

Below is an example where wind speed and direction is shown both True and Relative Wind presentation.

Relative Wind -presentation

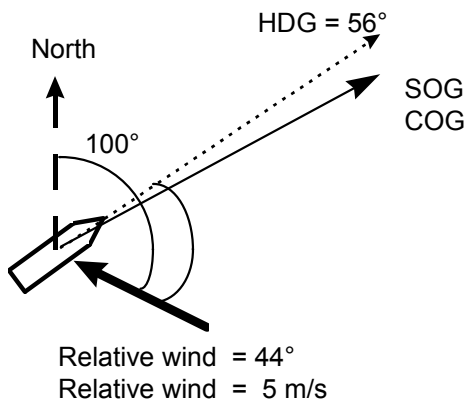

True Wind -presentation

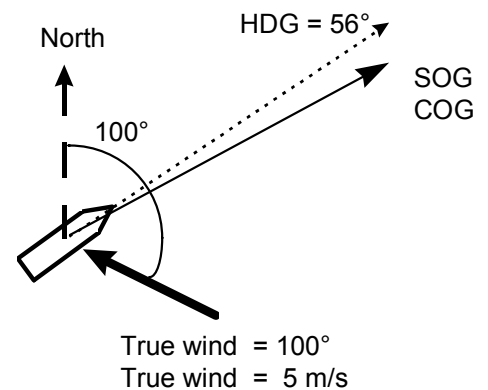

HDG	heading of ship
SOG	speed over ground
COG	course over ground

Depth sensor

Connected Depth sensor i.e. Echosounder is available in Sensors Other sheet.

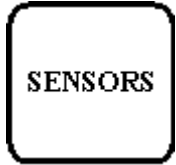

*SENSORS pushbutton
To select between
Speed/Course, Position or
Other sheets to be opened
either press button*



*or go by cursor above
Speed/Course, Position or
Other text and press SELECT*

SELECT SENSORS - Source: EC1000

Speed/Course | Pos | Other | Record

Wind
True Wind 7.8 Kt 65 °

Set and Drift
(log) Angle -3.2 ° Manual
Set 132.6 ° Drift 1.0 Kt

Pitch and Roll
Pitch ° Roll °

Depth below transducer 51.8 m

Gyro correction 0.0

The system displays depth value as depth below transducer. If you need you can activate an alarm based on the depth below transducer which is available "Echo alarm depth" on CHART DISPLAY Chart page.

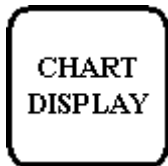

Chart display - ALL-ON

ARCS details | Tracking | Mariner | Route

Chart | Standard | Other

Echo alarm depth	5 m	
Shallow contour	10 m	
Safety depth	30 m	
Safety contour	30 m	
Deep contour	50 m	

If the measured depth goes from deeper value to a value which is less than the set Echo alarm depth, the system generates alarm "1200 Depth below limit".

Sensor related alarms

Following alarms, which are not described elsewhere, are related to different sensors:

"2055 ARPA Radar Comm. Error", if the system has lost connection to an connected ARPA radar 1. As a consequence the system loses tracked ARPA targets and speed/course available from ARPA.

"2056 ARPA Radar Comm. Error", if the system has lost connection to an connected ARPA radar 2. As a consequence the system loses tracked ARPA targets and speed/course available from ARPA.

"2057 ARPA Radar Comm. Error", if the system has lost connection to an connected ARPA radar 3. As a consequence the system loses tracked ARPA targets and speed/course available from ARPA.

"2058 ARPA Radar Comm. Error", if the system has lost connection to an connected ARPA radar 4. As a consequence the system loses tracked ARPA targets and speed/course available from ARPA.

"2071 Source ARPA Radar changed", The system has lost connection to the ARPA radar which used to be the source of tracked ARPA targets and speed/course information. Then if there are available other connected ARPA radars the system selects one of them as a new source of tracked ARPA targets and speed/course information and the system generates alarm 2071.

"4001 B-Adapter Error", if the system has lost connection to B-Adapter which is an interface to various navigation sensors. See more in separate Technical manual.

"4002 Engine Control Comm Error", if the system has lost connection to Engine Control which could be an interface to various navigation sensors. See more in separate Technical manual.

"4005 Gyro Error", if the system has lost connection to Gyro1 sensor.

"4006 Gyro Error", if the system has lost connection to Gyro2 sensor.

"4008 Log Error", if the system has lost connection to Log sensor.

"4009 Dual Axis Log Error", if the system has lost connection to Dual Axis Log sensor.

"4010 Echo Sounder Error", if the system has lost connection to Echo Sounder sensor.

"4011 Wind Sensor Error", if the system has lost connection to Wind sensor.

"4012 Position Eq Error", if the system has lost connection to Position sensor number 1

"4013 Position Eq Error", if the system has lost connection to Position sensor number 2

"4014 Position Eq Error", if the system has lost connection to Position sensor number 3

"4015 Position Eq Error", if the system has lost connection to Position sensor number 4

"4016 Position Eq Error", if the system has lost connection to Position sensor number 5

"4018 ROT gyro error", if the system has lost connection to ROT gyro sensor.

"4019 Pitch+Roll sensor error", if the system has lost connection to Pitch and Roll sensor.

"4021 ARPA Radar System Error", if ARPA radar number 1 reports about internal failure

"4022 ARPA Radar System Error", if ARPA radar number 2 reports about internal failure

"4023 ARPA Radar System Error", if ARPA radar number 3 reports about internal failure

"4024 ARPA Radar System Error", if ARPA radar number 4 reports about internal failure

"4201 Ext. navigation eq. error", if external navigation equipment number 1 reports about internal failure

"4202 Ext. navigation eq. error", if external navigation equipment number 2 reports about internal failure

"4203 Ext. navigation eq. error", if external navigation equipment number 3 reports about internal failure

"4204 Ext. navigation eq. error", if external navigation equipment number 4 reports about internal failure

"4205 Ext. navigation eq. error", if external navigation equipment number 5 reports about internal failure

"4206 Ext. navigation eq. error", if external navigation equipment number 6 reports about internal failure

"4207 Ext. navigation eq. error", if external navigation equipment number 7 reports about internal failure

"4208 Ext. navigation eq. error", if external navigation equipment number 8 reports about internal failure.

ARPA Target functions

Display of ARPA radar targets

Targets which are tracked by ARPA radar, can also be displayed on ECDIS screen. Select ARPA targets Std or Other position on **Tracking** sheet of Chart Display dialog box. There are two kind of targets displayed on electronic chart area:

Off	Std	Other	
<input type="radio"/>	<input checked="" type="radio"/>	<input type="radio"/>	
ARPA targets			
Length	<input type="text" value="20"/> min	Labels	<input type="text" value="5"/> min

- normal targets
- Reference targets

NOTE, AIS and ARPA targets viewing limitations

- AIS and ARPA targets are displayed on top of chart 1:1 000 001 for S57 charts.
- AIS and ARPA targets are displayed on top of chart 1:1 900 001 for ARCS charts. This allow display of AIS and ARPA targets on top of the largest scale Ocean charts (original scale 1 : 3 500 000) when they are zoomed to overscale

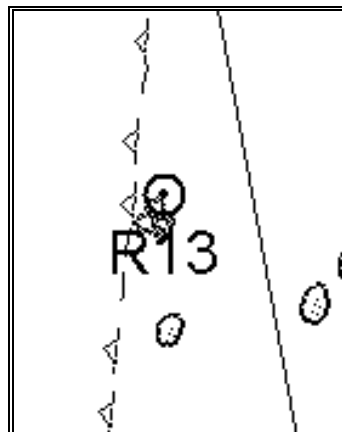
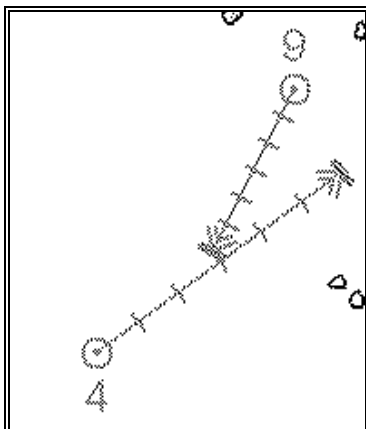

Targets from the radar can also be displayed on the Electronic chart area. NOTE that reference target has letter "R" in its label.

Display of dangerous ARPA radar targets

A dangerous ARPA radar target is displayed as a blinking target symbols between colours green and red. The ECDIS has its own definition for dangerous target limits. Thus ARPA radar may show a target as dangerous while

ECDIS shows it as safe and vice versa. You can set CPA and TCPA limits used by the ECDIS in Danger Targets sheet of Voyage Recording. For more information, see chapter "How to set conditions of viewing and logging Danger Targets" on page 387.

Display of lost ARPA radar targets

A Lost ARPA radar target is displayed as a blinking target symbols between colours green and dark yellow.

Display of True or Relative speed vectors

Targets vector can be displayed relative to own ship's heading (**RelVect**) or with reference to the North (**TrueVect**). Both presentation modes can be used with relative motion (**RM**) or true motion (**TM**) of own ship display mode.

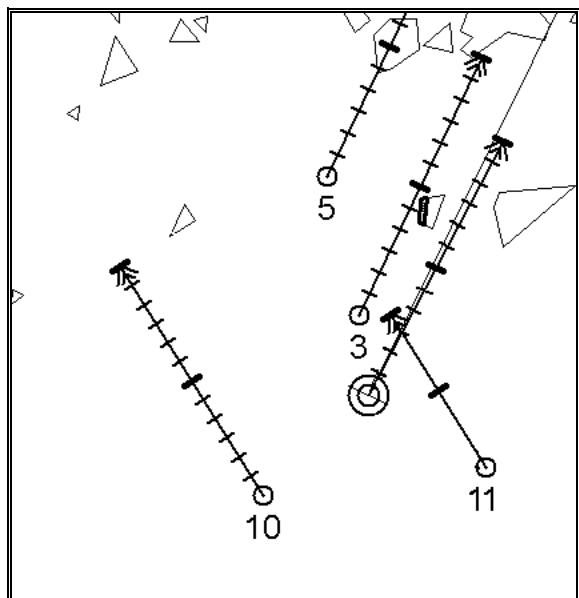

Presentation of True Vectors (TrueVect)

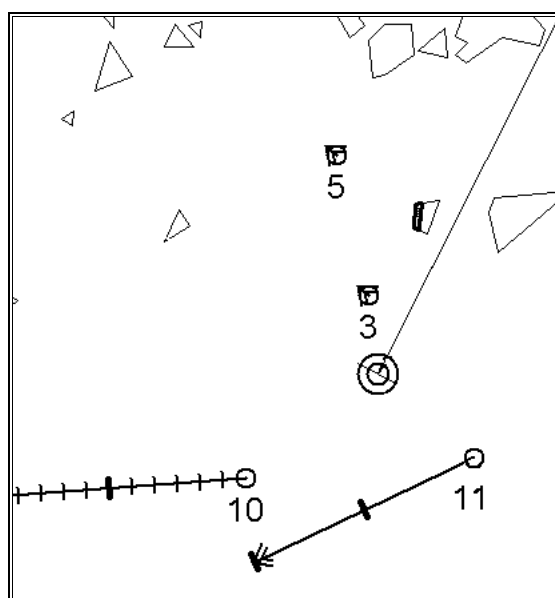

Presentation of Relative Vectors (RelVect)

Vector time (or the length of vectors) and presentation mode can be set in Chart page of Chart Display

1. Press Chart Display button, open Chart page.
2. Enter in Speed Vectors field desired time in unit of minute.
3. Select desired presentation mode for speed vectors (TRUE = True Vectors, RELATIVE = Relative Vectors)

Chart display - ALL-OFF *		
Tracking	Mariner	Route
Chart	Standard	Other
Echo alarm	<input type="text" value="0"/> m	
Shallow contour	<input type="text" value="5"/> m	
Safety depth	<input type="text" value="8"/> m	
Safety contour	<input type="text" value="10"/> m	
Deep contour	<input type="text" value="20"/> m	
Speed Vectors	<input type="text" value="12"/> min	<input type="text" value="TRUE"/>

Permanent indication of vectors' presentation mode is displayed upper right hand corner of ECDIS screen.

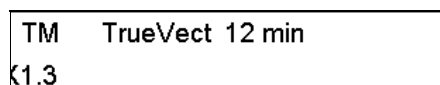

Note, that permanent indication changes it's colour between black and red depending on selected display mode of own ship:

If display mode of own ship is True motion (TM): Indication of TrueVect is displayed as black text, indication of RelVect is displayed as orange text.

If display mode of own ship is Relative motion (RM): Indication of TrueVect is displayed as orange text, indication of RelVect is displayed as black text.

Display of ARPA target data

How to view ARPA target tracking data of normal targets

On the ECDIS display move cursor above desired ARPA radar target and press **INFO/HELP** push button. Following Target display dialog box appears.

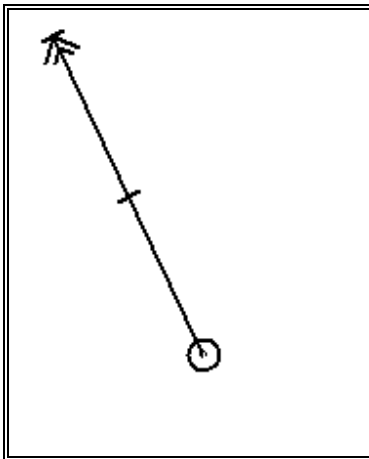

ARPA Radar target on ECDIS screen

Target display			
ARPA	1	Target 	Tracking
Lat	60°02.392N	Range	2.77 nm
Lon	025°05.067E	TrueBrg	62.8 °
CPA	0.9 nm	TrueSpd	15.1 Kt
TCPA	7.7 min	TrueCse	252.6 °
Dangerous			

ARPA Target display dialog box.

Target display dialog for ARPA radar target consists following information:

- Targets number and its status
 - Status can be **Query**, **Tracking** or **Lost**. State Query indicates a new target which do not yet have long enough tracking history to have target speed, course, CPA and TCPA available.
- Position
- CPA and TCPA
- Distance and true bearing from own ship
- True speed and true course of the target

User can set Closest Point of Arrival (CPA), and Time for CPA (TCPA) to define dangerous ARPA targets. CPA and TCPA limits are common for ECDIS display and Danger target log function of ARPA and AIS targets. On ECDIS display, a dangerous ARPA target is blinking between green and red colour.

VOYAGE RECORD

Details Log
Voyage Log
Danger Target Log
Alarms Log
Current Alarms
Chart Usage Log
Backup and Restore
Settings
Reset ▶

1. Press VOYAGE RECORD button.
2. Select **Settings** from the menu
3. Select **Danger Targets** sheet open.

VOYAGE RECORD

Danger Targets | Voyage

Danger Target Limits

CPA nm

TCPA min

Log interval min

Set desired limits for CPA and TCPA. Note, these limits are only for ECDIS. ARPA radar has its own setting for dangerous targets and thus a target which is dangerous at ARPA display can be safe on ECDIS or vice versa. If an ARPA target is inside CPA and TCPA, it is shown as dangerous ARPA target on ECDIS display. Log interval defines time period for logging.

Note! If TCPA has a negative value it means that you have already passed the closest point and the ARPA target is going away from your own ship. See example below:

Target display

ARPA 1 Target Tracking

Lat	60°03.830N	Range	2.66 nm
Lon	025°03.057E	TrueBrg	33.3 °
CPA	2.5 nm	TrueSpd	13.9 Kt
TCPA	-5.1 min	TrueCse	56.2 °

How to view ARPA target tracking data of reference targets

On the ECDIS display move cursor above desired ARPA radar target with letter "R" in its number and press **INFO/HELP** push button. Following Target display dialog box appears.

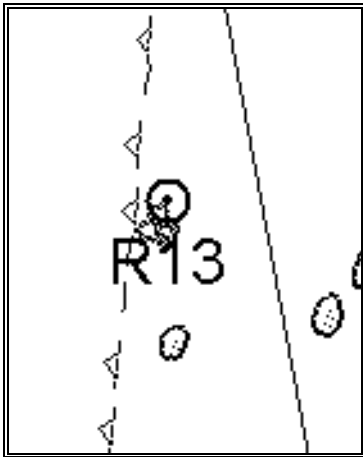

Target display			
ARPA	1 Target	<input type="checkbox"/>	Tracking
Lat	60°05.336N	Range	4.55 nm
Lon	024°58.277E	TrueBrg	348.2 °
CPA	0.7 nm	RefNum	1
TCPA	38.1 min	LifeTime	0.0 min

Target display dialog for Reference Target consists following information:

- Targets number and its status
 - Status can be **Query**, **Tracking** or **Lost**.
- Position
- CPA and TCPA
- Distance and true bearing from own ship
- RefNum, which is the number of reference target in the current Reference Target file
- LifeTime, which shows how long the target has been used as reference target without a break in tracking. A long life time indicates a good reference target.

Source of ARPA radar targets

Source of ARPA radar targets is permanently shown on upper bar (see example below).

Mon.RouteHEL-STO	Plan Route	Pilot Data HKI-STO	Predic
UserChart E_SUOMI	Ref Target	ARPA 1 Radar MAST X	

You can select another source of ARPA radar targets from Radar window. Press RADAR button and use **ARPA target source** selection.

RADAR OVERLAY SETTINGS

Radar Overlay source Sindel21

Gain 60 %

Sea clutter filter 0 %

Rain clutter filter 0 %

Echo trail time 0 min

Echo trails TRUE

Interference reject OFF

Echo stretch OFF

Noise display OFF

Mode ECDIS only

Transparency Opaque

ARPA target source 1

Source of ARPA radar targets related alarms

Alarm "2055 ARPA Radar comm error" reports about a failure to receive data from connected ARPA radars.

Alarm "2071 Source ARPA Radar changed" informs that the system has automatically changed the source of ARPA radar targets from current source to a new source. The reason for automatic change is that the communication with current source is in failure state.

Display ARPA target past positions

To display ARPA target past tracks, proceed as followed:

1. Press **Chart display** button.
2. Select **Tracking** sheet open. Select **ARPA targets** either **Std** or **Other** position.

Off	Std	Other	
<input type="radio"/>	<input checked="" type="radio"/>	<input type="radio"/>	
ARPA targets			
Length	<input type="text" value="20"/> min	Labels	<input type="text" value="5"/> min

3. ARPA Target past track will appear. The distance of track depends on selected value (i.e. in the Figure above the distance of displayed track is last 20 min labelled every five minutes).

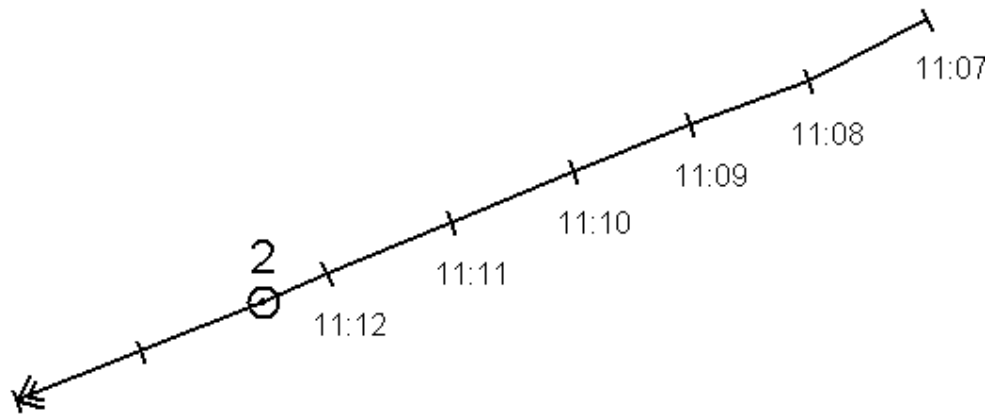

Display of ARPA target past track using 1 minute labels

ARPA Target recording functions

Target recording is used to record ARPA targets information to danger targets log. For more information recording of danger target, "Danger targets log" on page 386.

Using ARPA targets for chart align

Targets can be used to chart alignment. For more information, see chapter "How to use position alignment".

Using ARPA targets for position calculation

In the narrow water navigation, the radar is one of the best position sensors. The function Reference Target is specially developed to use the radar as a position sensor.

The file containing Reference Targets must have at least 8 Reference targets inserted. The ARPA radar must be able to track reliable simultaneously at least 2 Reference Targets before the position can be calculated.

When you start Reference Target positioning, Reference target field appears to Sensors Position sheet.

The image shows a software interface with a menu on the left and a dialog box on the right. The menu has the following items: 'Activate Plan mode', 'Reference target', 'Select', 'Cancel', 'Backup and Restore', and 'Report'. The 'Reference target' item is selected, and a sub-menu is open with 'Start' and 'Stop' options. The 'SELECT SENSORS' dialog box has tabs for 'Speed/Course', 'Pos', 'Other', and 'Record'. The 'Pos' tab is active. It contains several sections: 'Alignment' with a 'Start' button, 'Range' (0.0 nm) and 'Bearing' (0.0 °); 'Dead reckoning' with a checkbox; 'Kalman filter' with 'Off' and a dropdown; 'Reference target' with 'Off' and a dropdown. Each section also displays speed and bearing values, and latitude/longitude coordinates.

1. Start Reference target positioning.
2. Press **Sensors** button and open Position sheet.
3. Select Reference target as source of positioning

For position calculation select as primary or secondary source.

Using ARPA targets for gyro error correction

Reference Targets can be used for gyro error correction. For more information, see "Navigation parameters setting" on page 399.

NOTE! The system is able to use Gyro error compensation value even if you have in Position sheet of Sensors dialog box the Reference Targets in Off -position. The requirement for the Gyro error correction value is that you have started the reference targets and the system has been able to calculate position and speed based on tracked reference targets.

AIS target functions

Introduction

An AIS transponder can be connected to the ECDIS, in where AIS targets are displayed based on information received from the AIS transponder. The ECDIS can store simultaneous 1000 AIS targets in its storage buffer. Alarm 3501 inform about full storage buffer. The storage buffer contains automatic dead reckoning for all AIS targets which is based on reported Speed Over Ground (SOG), Course Over Ground (COG), Rate Of Turn (ROT) and heading. Also the storage buffer contain calculation of range, bearing, CPA, TCPA etc. The CPA and TCPA limits for dangerous targets are common inside ECDIS for ARPA and AIS targets.

From this storage buffer ECDIS can display AIS targets which are within user defined range. On ECDIS the maximum count of simultaneously displayed AIS targets are limited to 200 targets. Alarm 3500 indicates that there are more than user selected amount of AIS target within user selected range.

The frequency for update information of AIS transponder depends on speed and course change of tracked AIS target. The current reporting rate of each AIS target is available from INFO/HELP request. Below is a table which indicate IMO standardised reporting rates for AIS transponder. Based on table below, ECDIS defines which AIS targets are in tracking, lost or deleted.

Type of Ship	IMO nominal reporting interval	Lost target indication (reporting interval >)	Automatic deletion of target (reporting interval >)
Ship at anchor or moored and not moving faster than 3 knots	3 min	15 min	30 min
Ship at anchor or moored and moving faster than 3 knots	10 s	50 s	1 min 40 s
Ship with a speed of between 0 - 14 knots	10 s	50 s	1 min 40 s
Ship with a speed of between 0 - 14 knots and changing course	3 1/3 s	17 s	33 s
Ship with a speed of between 14 - 23 knots	6 s	30 s	1 min
Ship with a speed of between 14 - 23 knots and changing course	2 s	10 s	20 s
Ship with a speed of greater than 23 knots	2 s	10 s	20 s
Ship with a speed of greater than 23 and changing course	2 s	10 s	20 s

Onboard AIS transponder see all vessels fitted with AIS transponder. There can be several hundreds or several thousands of AIS targets. Only few of all AIS targets are significant for you. The ECDIS includes a concept called "active and sleeping AIS targets". Initially any new AIS target received by the onboard AIS transponder is not-active (= "sleeping"). Such non-active targets are visualised by a small a triangle. User can pick any AIS target and change it from non-active to active. Active AIS targets are visualised by big triangle, speed vector, headline, rot indicator, etc.. Also user can pick active AIS targets and change them as non-active.

AIS target functions of the ECDIS include also "Alarm 3502: Dangerous AIS target" and "Alarm 3503: Lost AIS target". Only active AIS targets create alarms. Also user can enable or disable AIS target alarms in general. The concept called "active and sleeping AIS targets" is very effective to concentrate the focus only to AIS targets which need supervision. The ECDIS further ease the task of the user by changing non-active targets automatically as active targets, if they meet the dangerous target limits set by CPA and TCA.

Display of AIS target

Targets which are tracked by AIS Transponder, can also be displayed on ECDIS screen. Select **AIS targets** Std or Other position on **Tracking** sheet of Chart Display dialog box. Also name of vessel can be displayed with the symbol if **AIS target names** is selected Std or Other.

<input type="radio"/>	<input checked="" type="radio"/>	<input type="radio"/>	AIS targets
<input type="radio"/>	<input checked="" type="radio"/>	<input type="radio"/>	AIS target names
Max. count	<input type="text" value="200"/>	Max. range	<input type="text" value="6"/> nm
Ship true symbol scale	<input type="text" value="1:50000"/>		

NOTE, AIS and ARPA targets viewing limitations

- AIS and ARPA targets are displayed on top of chart 1:1 000 001 for S57 charts.
- AIS and ARPA targets are displayed on top of chart 1:1 900 001 for ARCS charts. This allow display of AIS and ARPA targets on top of the largest scale Ocean charts (original scale 1 : 3 500 000) when they are zoomed to overscale

See examples below, where one example is a presentation of AIS targets with names and another without names.

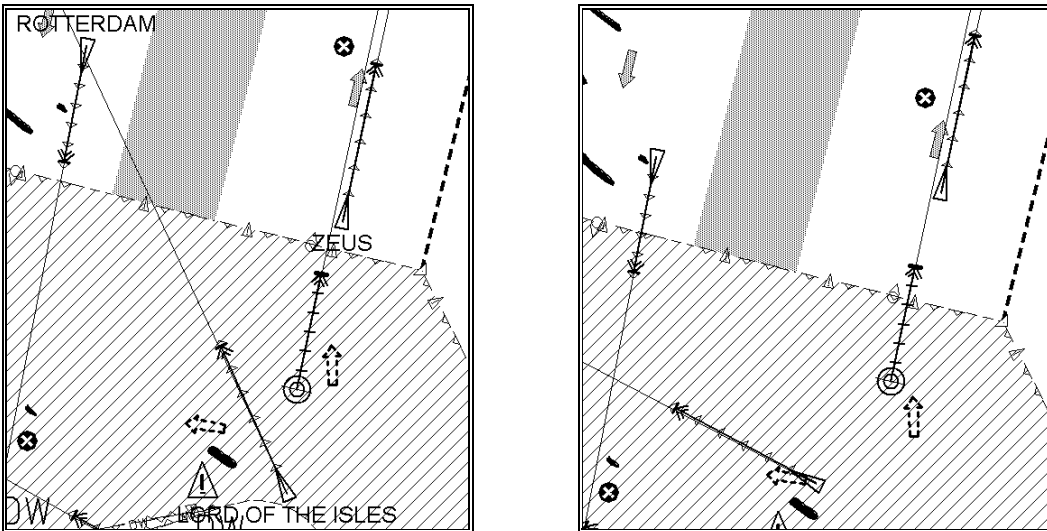

See examples below, where one example is a presentation of AIS targets with "true scale symbol" and another presentation with "point symbols". Note, own ship and AIS targets are displayed as true scale symbol, if the displayed chart scale is larger than set "Ship true symbol scale" limit on Tracking page of Chart Display and if the size of the true scale symbol is larger than 6 mm on the chart display.

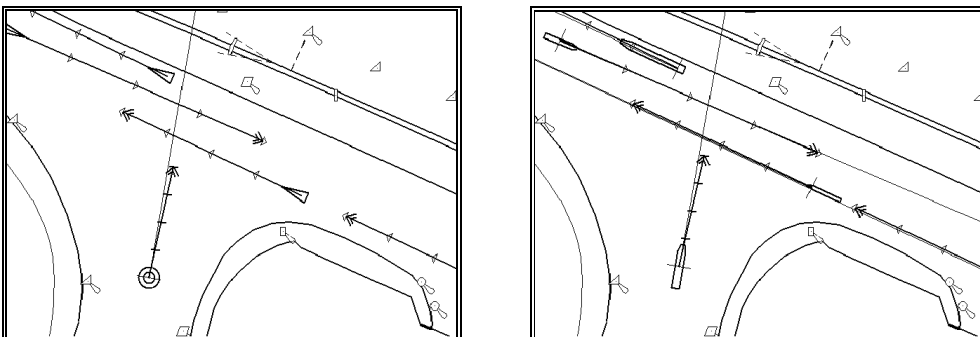

Display of dangerous AIS targets

A dangerous AIS target is displayed as a blinking target symbols between colours green and red. The ECDIS has its common definition for dangerous target limits. You can set CPA and TCPA limits used by the ECDIS in Danger Targets sheet of Voyage Recording. For more information, see chapter "How to set conditions of viewing and logging Danger Targets" on page 387.

Display of lost AIS targets

A Lost AIS target is displayed as a blinking target symbols between colours green and dark yellow.

Display of True or Relative speed vectors

AIS Targets vector can be displayed relative to own ship's heading (**RelVect**) or with reference to the North (**TrueVect**).

Vector time (or the length of vectors) and presentation mode can be set in Chart page of Chart Display

1. Press Chart Display button, open Chart page.
2. Enter in Speed Vectors field desired time in unit of minute.
3. Select desired presentation mode for speed vectors (TRUE = True Vectors, RELATIVE = Relative Vectors)

Chart display - ALL-OFF *		
Tracking	Mariner	Route
Chart	Standard	Other
Echo alarm	<input type="text" value="0"/>	m
Shallow contour	<input type="text" value="5"/>	m
Safety depth	<input type="text" value="8"/>	m
Safety contour	<input type="text" value="10"/>	m
Deep contour	<input type="text" value="20"/>	m
Speed Vectors	<input type="text" value="12"/>	min <input type="text" value="TRUE"/>

Permanent indication of vectors' presentation mode is displayed upper right hand corner of ECDIS screen.

TM TrueVect 12 min
1.3

Note, that permanent indication changes it's colour between black and red depending on selected display mode of own ship:

If display mode of own ship is True motion (TM): Indication of TrueVect is displayed as black text, indication of RelVect is displayed as orange text.

If display mode of own ship is Relative motion (RM): Indication of TrueVect is displayed as orange text, indication of RelVect is displayed as black text.

Maximum count and range for displaying AIS targets on ECDIS

You can select maximum count of AIS targets to be displayed on ECDIS. You can also define a range within AIS targets are displayed on ECDIS. Selection for those is available on **Tracking** sheet of Chart Display dialog box.

<input type="radio"/>	<input checked="" type="radio"/>	<input type="radio"/>	AIS targets
<input type="radio"/>	<input checked="" type="radio"/>	<input type="radio"/>	AIS target names
Max. count	<input type="text" value="200"/>	Max. range	<input type="text" value="6"/> nm
Ship true symbol scale	<input type="text" value="1:50000"/>		

In this example max 200 AIS targets can be displayed within range 6 NM.

Source of AIS targets related alarm

Alarm "**3500 AIS Target Overflow**" warns that Maximum count of AIS targets set to be displayed on ECDIS has been exceeded within defined Maximum range. It is possible that some of AIS targets are not displayed on ECDIS. To get all AIS targets to be displayed, increase Maximum count of AIS targets or decrease value of Maximum range. To set values, use AIS targets settings on Tracking page of Chart Display.

Alarm "**3501 AIS Target storage full**" warns that Maximum count of AIS targets which can be stored for displaying on ECDIS has been exceeded. It is possible that some of AIS targets are not displayed on ECDIS.

Alarm "**4037 AIS receive error**" warns that data from AIS transponder is not correctly received.

Display of AIS target data

On the ECDIS display move cursor above desired AIS target and press **INFO/HELP** push button. Following AIS Target display dialog box appears.

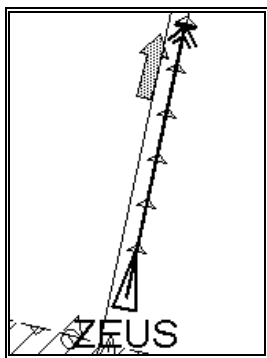

AIS target on ECDIS screen

AIS Target display			
Name	SUPERSEACAT FOUR		
Call Sign	ESSC	Show details	
<input type="checkbox"/> Active	Tracking		
Lat	59°30.580'N	Age	0.9s
Lon	024°42.576'E	Range	24.3 nm
		GPS True Brg	189.6°
CPA	22.1 nm	True Spd	15.0 Kt
TCPA	-22.2 min	True Cse	159.1°
ROT	0 °/min	Hdg	159.0°

AIS Target display dialog box.

AIS Target display dialog for AIS target consists following information:

AIS Target Name and **Call Sign**

Age, indicates how long time ago last message was received from tracked vessel.

User selection of **Active** or **Non-active**

Dangerous, Tracking, Query or **Lost** indication

Position and **source of position**

Range, distance from own ship

CPA and **TCPA**

TrueBrg, true bearing from own ship

ROT: Rate of turn of tracked vessel

True Spd, True speed of the target

Status of tracked vessel (**tracking, dangerous, lost**)

True Cse, true course of the target

NOTES

- Use Age to compare its value to the nominal IMO rate for each ship type. Note also that you can use Age as a tool to estimate usability of AIS target data for anti collision purposes.
- Availability of Name, Call Sign, ROT, Hdg, Spd, Cse, CPA, TCPA are subject to the content AIS transponder reports.

If more detail information is needed, you can press **Show Details** button on AIS Target display window. A following additional window appears.

Note:

- Availability of Details are subject to the content AIS transponder reports.

AIS Target display			
Name	SUPERSEACAT FOUR		
Call Sign	ESSC	Hide details	
<input type="checkbox"/> Active	Tracking		
Lat	59°30.801'N	Age	4.3 s
Lon	024°42.411'E	Range	24.1 nm
	GPS True Brg	190.6°	
CPA	22.2 nm	True Spd	15.0 Kt
TCPA	-20.9 min	True Cse	159.1°
ROT	0 °/min	Hdg	159.0°
Draught 5.3 m			
Under Way Using Engine			
Destination TALLINN-HELSINKI			
ETA (UTC+3) 12 Nov 15:30			
Length	63 m	Width	13 m
Ref from Bow	11 m	from port	4 m
IMO MMSI	8060404		
Passenger ship			

User can set Closest Point of Arrival (CPA), and Time for CPA (TCPA) to define dangerous AIS targets. CPA and TCPA limits are common for ECDIS display and Danger target log function of ARPA and AIS targets. On ECDIS display, a dangerous AIS target is blinking between green and red colour.



Details Log
Voyage Log
Danger Target Log
Alarms Log
Current Alarms
Chart Usage Log
Backup and Restore
Settings
Reset

1. Press VOYAGE RECORD button.
2. Select **Settings** from the menu
3. Select **Danger Targets** sheet open.

VOYAGE RECORD		
Danger Targets	Voyage	
Danger Target Limits		
CPA	<input type="text" value="1.5"/>	nm
TCPA	<input type="text" value="10"/>	min
Log interval	<input type="text" value="1"/>	min

Set desired limits for CPA and TCPA. If an AIS target is inside CPA and TCPA, it is shown as dangerous AIS target on ECDIS display. NOTE, that the same control is also used for ARPA targets.

Note! If TCPA has a negative value it means that you have already passed the closest point and the AIS target is going away form your own ship. See example below

AIS Target display			
Name	ZEUS		
Call Sign	ZYHT	Show details	
<input type="checkbox"/> Active	Tracking		
Lat	52°05.340N	Age	1.8 s
Lon	003°57.707E	Range	1.7 nm
	GPS True Brg	15.3°	
CPA	0.1 nm	True Spd	15.0 Kt
TCPA	-25.7 min	True Cse	12.0°
ROT	0 °/min	Hdg	12.0°

Display of AIS interface status

User can verify status of AIS interface on Other page of SENSORS. Lower part of this page is reserved for monitoring it as follows:

- **Received Data**, whether data from AIS transponder is correctly received or not (Status: **OK** or **Fail**).
- **Display**, whether Maximum count of AIS targets set to be displayed on ECDIS has been exceeded within defined Maximum range or not (Status: **OK** or **Overflow**).
- **Storage**, whether Maximum count of AIS targets which can be stored for displaying on ECDIS has been exceeded or not (Status: **OK** or **Overflow**).

SELECT SENSORS - Source: EC1000_002

Speed/Course | Pos | Other | Record

Wind

True Wind Kt °

Set and Drift

(log) Angle 0.0 ° Manual

Set ° Drift Kt

Pitch and Roll

Pitch ° Roll °

Depth below transducer m

Gyro correction °

Over Ground

Distance counter 910.9 nm

Trip counter 910.9 nm

Through Water

Distance counter 910.8 nm

Trip counter 910.8 nm

AIS Targets

Danger and Lost Target Alarms

Received data Ok

Display Ok

Storage Ok

Also on this page you can set ON/OFF "Alarm 3502: Dangerous AIS target" and "Alarm 3503: Lost AIS target". Select tick box "Danger and Lost Target Alarms" if you like to have alarms of Dangerous and Lost targets.

Radar Echo Overlay

Introduction

This ECDIS can have an optional Radar Echo Overlay. This means that the radar echo image can be transferred from the radar unit into the ECDIS chart display.

This ECDIS has many features to support exact match in scale and orientation of the chart and radar echo image. Exact match of the radar echo image and chart is an essential security feature. If the radar echo image and the chart display match, then the mariner can rely on what he sees and the mariner also gets a very good confirmation that his navigation sensors such as gyro and position receivers operate properly and accurately. However if the mariner is unable to achieve exact match then that is a very strong indication that something is wrong and he should not rely on what he sees.

This ECDIS can use radar echo image in several user selectable modes. "ECDIS only" mode operates without radar echo image. "ECDIS and radar" mode operates using rules for the type approved ECDIS to visualise radar echo image. "Radar over chart" mode draws radar echo image in top of the chart. This mode should be used temporarily because legally the equipment is not an ECDIS which can legally replace paper chart when operating with "Radar over chart". Fourth mode available is "Radar video only" which again should be used only temporarily to check pure radar echo presentation, because the equipment is not an ECDIS which can legally replace paper chart when operating with "Radar video only".

The radar echo image is transferred directly from radar transceiver so the range used in a connected ARPA radar display does not change scale in the ECDIS. This ECDIS is nearly independent of the ARPA radar display settings. The only ARPA radar display setting which has effect for the radar echo image of this ECDIS is the used pulse length of the radar transceiver. ARPA radar display controls the radar transmitted and thus selects the used pulse length. This ECDIS listens the radar receiver without any possibility to control radar transmitter. All other controls such as Gain, STC, FTC, interference reject, echo stretch, echo trails are independently controlled in this ECDIS.

Selected scale of displayed chart defines also scale of radar echo overlay. When you change scale of chart also scale of radar echo overlay is changed automatically. The maximum range of radar echo overlay is 24 nautical miles. Radar echo overlay can be displayed even if the own ship is not located in displayed chart area if the range is less than 24 NM.

The thumb rule for range of displayed area:

- Chart scale 1:10 000 is about equal to traditional radar range of 0.75 NM
- Chart scale 1:20 000 is about equal to traditional radar range of 1.50 NM

How to activate radar echo overlay on the ECDIS

Radar echo overlay can be transferred into the ECDIS display. Like the other details of vector charts radar echo overlay can add or remove from chart display. In a Tracking sheet of Chart Details there is a control for Radar overlay. You have to also select mode how to display radar echo overlay in chart display and adjust it's visual image. To activate radar echo overlay, proceed as follows:

1. Press CHART DISPLAY button, select **Tracking** sheet open, check that radar overlay is set to be displayed. (Selected as **Std** or **other**).
2. Press RADAR button, Radar overlay dialog box open.

Chart display - ALL-OFF *

Chart	Standard	Other
Tracking	Mariner	Route

Past tracks

Off Std Other

Ship System
 Ship Primary
 Ship Secondary
 Length min Labels min

Off Std Other

ARPA targets
 Length min Labels min

Off Std Other

Predictor ship (30 sec)
 Events and Positions
 ARPA targets
 Radar Overlay

Ship true symbol scale limit

RADAR OVERLAY SETTINGS

Radar Overlay source

Gain %

Sea clutter filter %

Rain clutter filter %

Echo trail time min

Echo trails

Interference reject

Echo stretch

Noise display

Mode

Transparency

ARPA target source

3. Select desired display mode for Radar echo overlay in Radaroverlay setting dialog box.
4. Adjust radar echo overlay visual image.

Source of radar echo overlay

Source of radar echo overlay is permanently shown on upper bar (see example below).

Mon.RouteHEL-STO	Plan Route	Pilot Data HEL-STO	Predic
UserChart E_SUOMI	Ref Target	ARPA	Radar MAST X

Display modes of radar echo overlay

You can select following presentation modes of Radar image:

ECDIS only:

Only chart is displayed in the ECDIS.

ECDIS and Radar:

With S57 Chart material radar echo image is mixed into chart so that some chart features are underlying radar image and some are above it. This presentation follows the drawing rules of the Standard S52ed3.1 of IHO. If you use the ARCS Chart material radar image is drawn on top of the Chart.

Radar over Chart:

Radar echo image is drawn on top of the Chart.

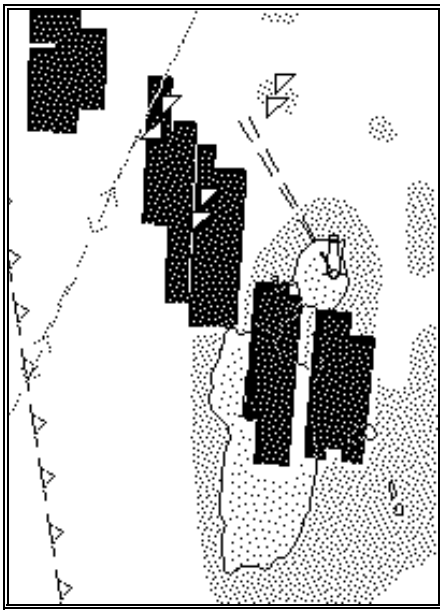

ECDIS and Radar presentation

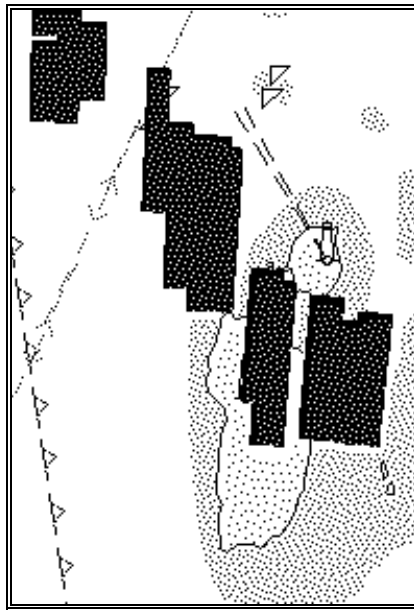

Radar over Chart presentation

Radar video only:

Only Radar echo image is drawn in the ECDIS display.

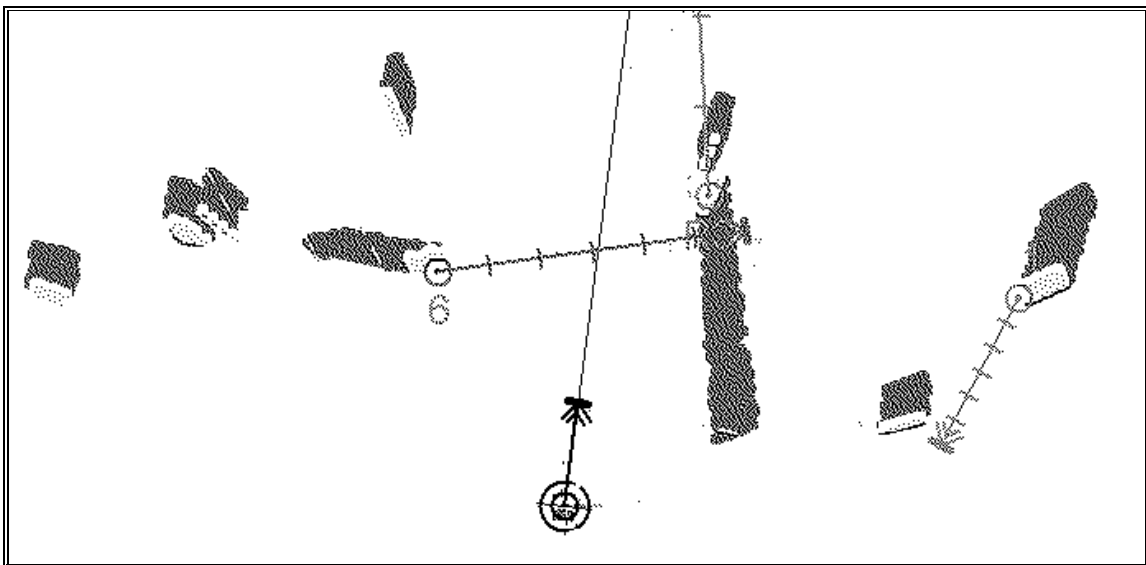

How to adjust radar echo overlay visual image

There are several switches in Radar Overlay Settings to adjust radar echo overlay visual image (Gain, Sea clutter, Rain clutter, Echo trail, Interference reject, Echo stretch, Noise display).

Note, The controls of Gain, Sea Clutter Filter and Rain Clutter Filter are independent from the controls at any radar display. Therefore their relative position for the best picture may differ a lot of set values in a radar display.

RADAR OVERLAY SETTINGS

Radar Overlay source FEC

Gain %

Sea clutter filter %

Rain clutter filter %

Echo trail time min

Echo trails TRUE

Interference reject HIGH

Echo stretch OFF

Noise display OFF

Mode ECDIS and Radar

Transparency Opaque

ARPA target source 2

RADAR OVERLAY SETTINGS

Radar Overlay source No headline

Gain %

Sea clutter filter %

Rain clutter filter %

Echo trail time min

Echo trails TRUE

Interference reject HIGH

Echo stretch OFF

Noise display OFF

Mode ECDIS and Radar

Transparency Opaque

ARPA target source 2

Note, if the ECDIS fails to receive headline, trigger or azimuth from the radar transceiver, it is indicated in Radaroverlay settings dialog. box (See example above, headline information is missing).

Radar overlay source

Indicates source of current radar echo overlay.

Gain

Gain control is used to set sensitivity of radar echo image.

Note, If you change the value of Gain you have to check and if necessary re-adjust the value of Sea clutter filter because these two controls effect each other.

When you adjust Gain, Noise Display -mode is automatically switch to ON to show also lower level radar echo image.

Sea clutter filter

Sea clutter filter control is used to control amount of sea clutter in radar echo image.

Note, If you change the value of Sea clutter filter you have to check and if necessary re-adjust the value of Gain because these two controls effect each other.

When you adjust Sea clutter filter, Noise Display -mode is automatically switch to ON to show also lower level radar echo image.

Rain clutter filter

Rain clutter filter control is used as countermeasure against rain in radar echo image.

When you adjust Rain clutter filter, Noise Display mode is automatically switch to ON to show also lower level radar echo image.

Echo trail time and trail presentation mode

Echo trails are artificial afterglow of radar echo image on the ECDIS display, created by maintaining the echo intensity once it has been seen, and then removing it after the set time has passed. Target Echoes represent their movements relative to own ship (Relative trails) or true movements with respect to land (True trails). Echo Trails are visible in dark green colour, if Noise Display has been selected OFF.

To select echo trail time and to select True or Relative echo trail presentation mode, proceed as follows:

1. Press RADAR button in Control Panel.
2. Select **TRUE** or **RELATIVE** presentation mode for trails in Echo trails list box.
3. Set desired time for echo trail time in Echo trail time field. If set time for trails is more than available in the ECDIS that moment, length of current trail is displayed in the field indicating that trail is shorter than requested. When current trail disappears from the field length of trails are as requested.

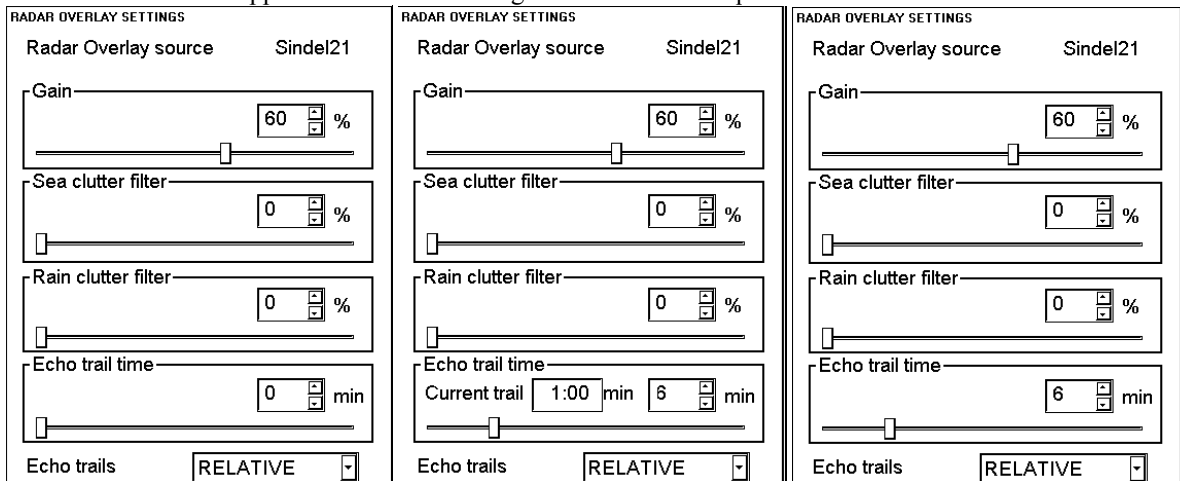

Permanent indication of selected presentation mode of trails is displayed upper right corner of the ECDIS screen.
True trail = TrueTrail

Relative trail = RelTrail

Mon.Route Osku1	Plan Route	Pilot Data	Depth metres	Height metres	North Up	TM	TrueVect	TrueTrail
UserChart	Ref Target	ARPA 1 Radar FEC1						

Note, that permanent indication changes it's colour between black and red depending on selected display mode of own ship:

If display mode of own ship is True motion (TM): Indication of TrueTrail is displayed as black text, indication of RelTrail is displayed as orange text.

If display mode of own ship is Relative motion (RM): Indication of TrueTrail is displayed as orange text, indication of RelTrail is displayed as black text.

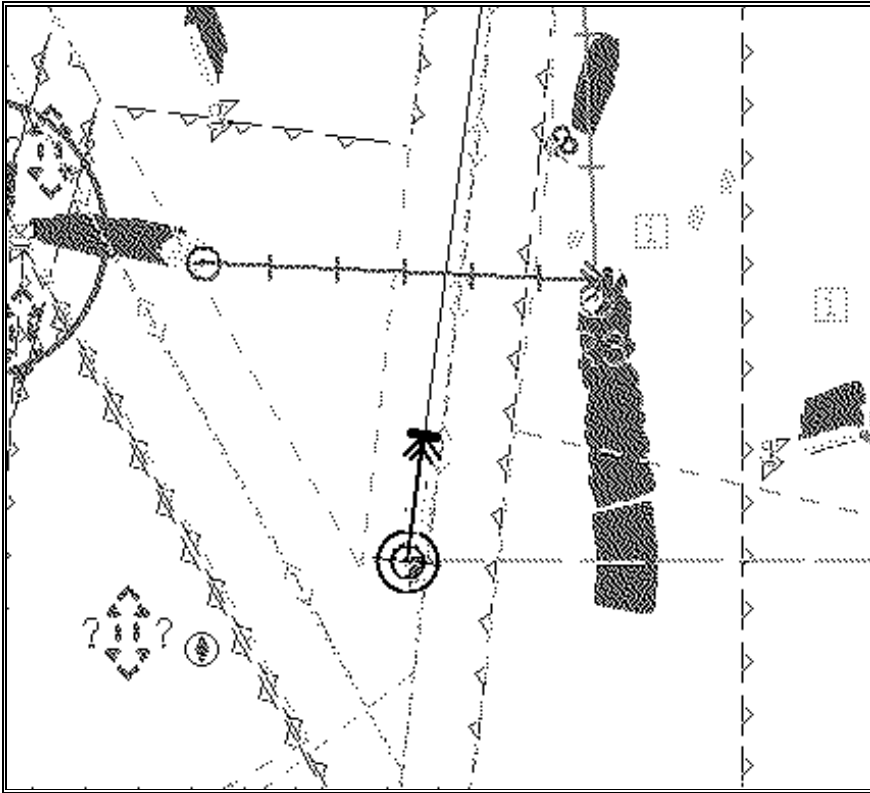

Relative trail presentation mode.

Interference reject

Interference reject has three alternatives: OFF, LOW and HIGH. Select suitable to reduce interference of other radar and to suppress also amount of noise. Recommended positions are HIGH and LOW.

Noise display

Radar echoes can be displayed with dark and bright green colour. If Noise display is selected ON, then dark green colour is used to display low echo level i.e. noise. If Noise display is selected OFF, then dark green colour is used to display Echo Trails.

Transparency

Transparency control "see through" behaviour of the radar echo overlay. Alternative OPAQUE overlaps chart objects: with ARCS totally and with S57 partly. Alternatives 25%, 50% and 75% allow you to see the chart details under the radar echoes.

Echo Stretch

Echo stretch is used to emphasise radar echo to increase detectability of targets. Position LOW emphasise both noise and target level echoes while position HIGH emphasise only target level echoes.

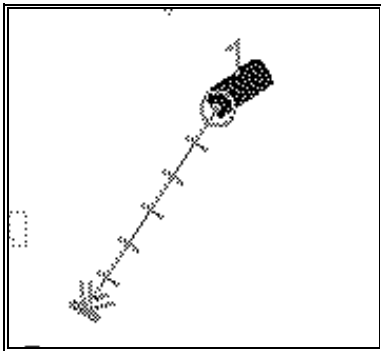

Echo stretch **HIGH**.

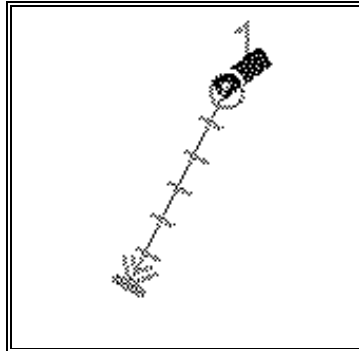

Echo stretch **OFF**.

Echo Overload situation

Mon.Route Osku1	Plan Route	Pilot Data	Depth metres	Height metres	North Up	TM	TrueVect	RelTrail
UserChart	Ref Target	ARPA 1 Radar Sindel21						
				60°07.070N Gyro 355.1°				
				024°59.123E COG 354.5°				
				WGS 84 (pos) SOG 5.0Kt				
				GPS				
RADAROVERLAY SETTINGS								
Radar overlay source				FURUNO				
Overload Gain				75 %				
Sea clutter filter				0 %				
Rain clutter filter				44 %				
Echo trail time				5 min				
Echo trails				RELATIVE				
Interference reject				OFF				
Echo stretch				OFF				
Noise display				OFF				
Mode				ECDIS and Radar				
Transparency				Opaque				
ARPA target source				1				
Cursor								
From Own Ship:				0.090 nm		147.4°		
				60°06.994N		024°59.220E		
07.09.1999 07:46 UTC			07.09.1999 10:46 FLE Standard			1:10 000		B117 B117

Improperly set radar **Gain**, **Sea clutter filter** or **Interference reject** could lead to an overload situation, in which you see visual distortion such as above in your screen. Then check, if you have red text **Overload**, and adjust gain or sea clutter filter and set Interference reject in High position.

How to adjust radar echo overlay to match positions of chart features

Error sources of radar echo image and chart display miss match

Mariner should be aware that there are several reasons why the radar echo image and chart display do not match exactly. One should also be aware that normally the miss match is a combination of several reasons and adjusting only one feature doesn't solve the miss match all around. There is a fundamental difference between radar echo image and corresponding chart feature. Radar echo is a reflection from the real life target and the actual position of the real life target is front edge of the radar echo. Thus radar echo should start from the chart feature and extent as far as the used radar pulse length goes.

Bearing error sources

1. Gyro
2. Inaccurate chart
3. Improper installation parameters (radar echo overlay bearing offset)

Position error sources

1. Inaccurate position
2. Position offset
3. Inaccurate chart
4. Wrong datum
5. Datum offset with ARCS material
6. Improper installation parameters (conning position offset, position receiver antenna offset, radar echo overlay range offset, datum selected for position receiver)

Error sources of radar echo image and display of ARPA target miss match

Mariner should be aware that there are several reasons why the radar echo image and display of ARPA target symbols do not match exactly.

1. different gyro value at ARPA radar display and at ECDIS
2. improper installation parameters (radar echo overlay bearing offset, radar echo overlay range offset, conning position offset)

See example below, how different gyro value set at ARPA radar display and at ECDIS effects the display of the ECDIS.

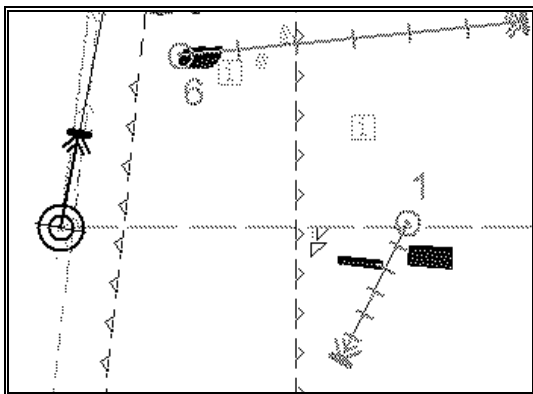

Different gyro value at ARPA and ECDIS

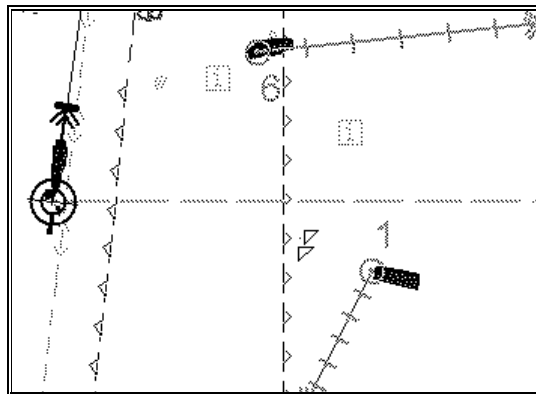

Equal gyro value at ARPA and ECDIS

How to adjust bearing error

To adjust bearing error which is caused by gyro, you have three different alternatives:

1. Manual
 - Adjust value of manual gyro correction.
2. Table based gyro speed/latitude correction (Note! The build in correction inside the ECDIS doesn't correct dynamic error: settling time after course change etc.)
 - Switch selection Gyro speed/latitude correction to ON position.
3. Use Reference targets to make gyro correction (automatic).

See example below, how to use manual gyro correction.

Mon.Route Osku1	Plan Route	Pilot Data	Depth metres	Height metres	North Up	TM	TrueVect	RelTrail		
UserChart	Ref Target	ARPA 1 Radar Sindel21								
			60°01.833N Gyro		8.3°					
			024°57.294E COG		8.3°					
			WGS 84		(pos)					
			GPS		OFFSET		SOG			5.0Kt
Plan Speed		20.0Kt		To WP		3				
Plan		216.9°		Dist WOP		2.55nm				
Route		216.8°		Time		06:36				
Ch limit		185m		Next WP		4				
Off track		<32m		Next		228.4°				
SHIP and ROUTE PARAMETERS										
-Ship parameters-										
Ship max. speed				23.0		Kt				
Ship max. height				34.0		m				
Ship draught				10.0		m				
Gyro error correction				Auto						
Gyro spd/lat error				On						
Max gyro error correction				3.0		°				
Manual gyro correction				0.2						
-Route parameters-										
Max rate of turn				200		°/min				
Turn end tolerance				2		°				
WP approach alarm time				60		s				
WP prewarn alarm time				120		s				
Route start limit angle				20		°				
Default line radius				0.3		nm				
Drift compensation				On						
Gyro error compensation				Off						
19.05.1999 14:18 UTC			19.05.1999 15:18 GMT Stand							

No manual gyro correction.

Note!

ARPA targets and radar echo overlay match perfectly.

Chart features and radar echo overlay have some miss match.

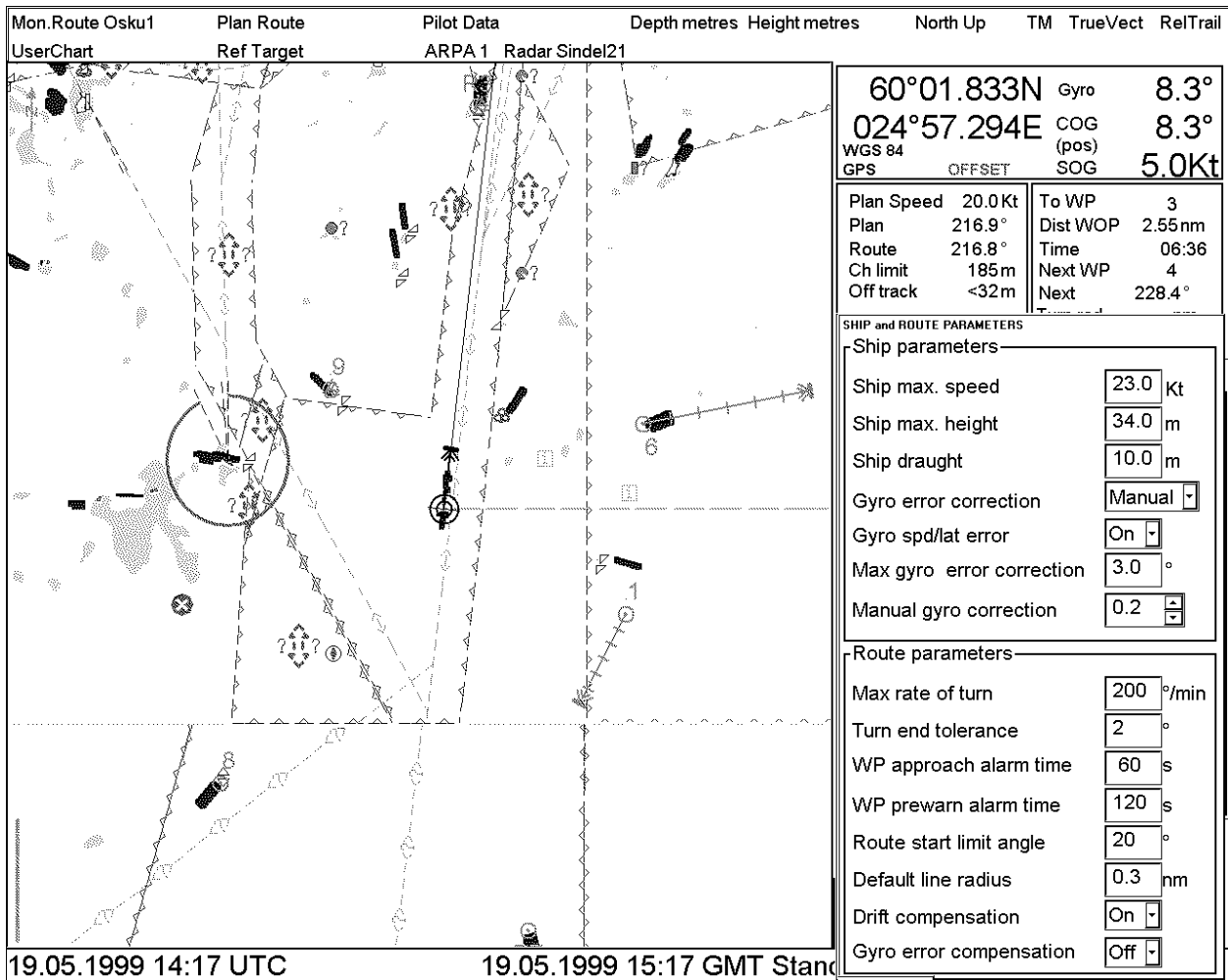

Manual gyro correction in use

Note!

ARPA targets and radar echo overlay match perfectly.

Chart features and radar echo overlay match perfectly.

How to adjust position error

How to verify position and align it if required

See chapter "Position alignment by means of ECDIS".

How to verify correct datum used in positioning

It is very important that output co-ordinates of position device is the same as the ECDIS expects to receive, otherwise there is a risk that you have incorrect position in the ECDIS. Verify in position device configurations that output of co-ordinates is WGS84 and also in installation parameters in the ECDIS is set to receive position in WGS84 datum.

Recording functions

Introduction

An ECDIS EC1000 has capability to record various voyage related things like movement and position of own ship and dangerous targets based on ARPA radar.

The Voyage log is used to record entire voyage i.e. a sailing of a route from first point to the last.

The Details log is used to record position, speed and course once every minute.

Danger Targets log is used to record ARPA targets information.

Chart Usage log is used to record information of used charts in display.

All recording related things are here. User can print a report that includes own ship data and ARPA radar targets.

Events and Man Over Board functions



MOB button

function LOGBOOK M.O.B

Records a predefined Man Over Board event to logbook. Position of this event is also displayed on chart as a red mark



EVENT button

function LOGBOOK EVENT

Records an event to logbook. You can also write a comment for this event.

Note, it is displayed only in the Electronic chart area if Events is selected to display in Chart display dialog box.

The ECDIS can display Events and MAN OVER BOARD. These events are also recorded into the Voyage log.



M.O.B

Voyage recording

Details log

Details log contains information of last 12 hours. Various information is recorded in Details log once per minute:

- Date and time
- Position of own ship which is based on selection of position sensors. For more information, see chapter "Source of position".
- Value of alignment (range, bearing), if it is used.
- Speed over ground and Course over ground. For more information, see chapter "Source of SOG, COG, speed, heading, rot, drift and docking speed components"
- Heading. For more information, see chapter "Source of SOG, GOC, speed, heading, rot, drift and docking speed components".
- Value of gyro correction, if it is used.

How to view Details log

To open Details log, proceed as followed:

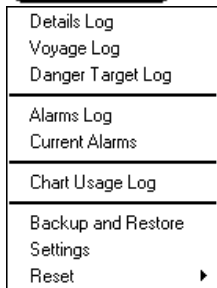

1. Press VOYAGE RECORD button.
2. Select **Details log** from the menu
3. The system will start viewing program of log.
4. User is able to make a backup copy, print or print desired part of details log for later use.

Date	Time	Type	Lat	Lon	Align (nm)	Align (°)	Sog [kt]	Cog (°)	Hdg (°)	Corr. (°)
04.12.2002	12:02:20	Auto	60°00.000'N	025°00.000'E	0.0	0.0	0.0	240.0	240.0	NVLD
04.12.2002	12:01:20	Auto	60°00.000'N	025°00.000'E	0.0	0.0	0.0	240.0	240.0	NVLD
04.12.2002	12:00:20	Auto	60°00.000'N	025°00.000'E	0.0	0.0	0.0	240.0	240.0	NVLD
04.12.2002	11:59:20	Auto	60°00.000'N	025°00.000'E	0.0	0.0	0.0	240.0	240.0	NVLD
04.12.2002	11:58:20	Auto	60°00.000'N	025°00.000'E	0.0	0.0	0.0	240.0	240.0	NVLD
04.12.2002	11:57:20	Auto	60°00.000'N	025°00.000'E	0.0	0.0	0.0	240.0	240.0	NVLD
04.12.2002	11:56:20	Auto	60°00.000'N	025°00.000'E	0.0	0.0	0.0	240.0	240.0	NVLD
04.12.2002	11:55:20	Auto	60°00.000'N	025°00.000'E	0.0	0.0	0.0	240.0	240.0	NVLD
04.12.2002	11:54:20	Auto	60°00.000'N	025°00.000'E	0.0	0.0	0.0	240.0	240.0	NVLD
04.12.2002	11:53:20	Auto	60°00.000'N	025°00.000'E	0.0	0.0	0.0	240.0	240.0	NVLD
04.12.2002	11:52:20	Auto	60°00.000'N	025°00.000'E	0.0	0.0	0.0	240.0	240.0	NVLD
04.12.2002	11:51:20	Auto	60°00.000'N	025°00.000'E	0.0	0.0	0.0	240.0	240.0	NVLD
04.12.2002	11:50:20	Auto	60°00.000'N	025°00.000'E	0.0	0.0	0.0	240.0	240.0	NVLD
04.12.2002	11:49:20	Auto	60°00.000'N	025°00.000'E	0.0	0.0	0.0	240.0	240.0	NVLD
04.12.2002	11:48:20	Auto	60°00.000'N	025°00.000'E	0.0	0.0	0.0	240.0	240.0	NVLD

Ready | Details log | Time: UTC | Datum: WGS 84

Voyage log

This log consists information from the entire voyage. Recorded events are:

- Changes of course and speed are recorded. User can define limits for course change and speed change of own ship to be recorded. (Type:Ship)
- User is able to define time period, how often there is a recording regardless of course or speed changes. (For example, once per 4 hours). (Type:Auto)
- Man Over Board event (Type:MOB)
- Standard event (Type:User)
- Alarms generated by the system. User is able to select alarms, which are recorded into Voyage log. (Type:Alarm)
- Positions (Type: Posdev)

Each record consists information of wind speed and direction, depth information and distance counter value.

How to view Voyage log

To open Voyage log, proceed as followed:



1. Press VOYAGE RECORD button.
2. Select **Voyage log** from the menu
3. The system will start viewing program of log.
4. User is able to make a backup copy, print a complete log or print desired part of Voyage log for later use.

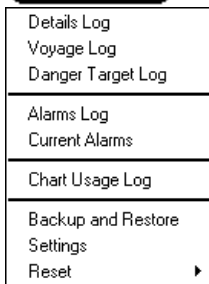

Find below an example of Voyage log.

Date	Time	Type	Lat	Lon	Sog [kt]	Cog [°]	Hdg [°]	Corr. [°]	Wind [kt]	Wind [°]	Dist Cntr [nm]	Depth [m]	Descriptio
29.11.2002	05:28:20	Ship	60°00.487'N	024°55.325'E	23.2	244.4	244.9	NVLD	7.7	127.1	9158.4	NVLD	
29.11.2002	05:25:20	Ship	60°01.062'N	024°57.330'E	22.0	241.6	239.5	NVLD	4.2	95.4	9157.3	NVLD	
29.11.2002	05:24:20	Ship	60°01.087'N	024°57.940'E	14.6	301.4	288.1	NVLD	9.9	89.9	9157.0	NVLD	
29.11.2002	05:23:20	Ship	60°00.960'N	024°58.000'E	0.0	0.0	0.0	NVLD	7.6	16.0	9156.8	NVLD	
29.11.2002	05:14:20	Auto	57°14.486'N	013°32.473'E	23.2	245.0	245.0	NVLD	7.6	131.0	9153.3	NVLD	
29.11.2002	01:14:20	Auto	57°53.801'N	016°09.599'E	23.2	245.0	245.0	NVLD	7.6	131.0	9060.5	NVLD	
28.11.2002	21:14:20	Auto	58°32.994'N	018°49.612'E	23.2	245.0	245.0	NVLD	7.6	131.0	8967.7	NVLD	
28.11.2002	17:14:20	Auto	59°12.439'N	021°32.583'E	23.2	245.1	245.0	NVLD	7.6	131.0	8874.9	NVLD	
28.11.2002	13:34:17	MOB	59°48.451'N	024°04.750'E	23.2	245.0	245.0	NVLD	7.6	131.0	8789.8	NVLD	
28.11.2002	13:14:20	Auto	59°51.741'N	024°18.691'E	23.2	245.1	245.0	NVLD	7.6	131.0	8782.1	NVLD	
28.11.2002	12:23:20	Ship	60°00.145'N	024°54.400'E	23.2	245.7	245.0	NVLD	7.2	139.8	8762.4	NVLD	
28.11.2002	12:22:20	Ship	60°00.272'N	024°55.131'E	23.2	256.2	254.9	NVLD	7.2	141.1	8762.0	NVLD	
28.11.2002	12:21:20	Ship	60°00.327'N	024°55.896'E	23.2	267.1	265.9	NVLD	7.2	141.1	8761.6	NVLD	
28.11.2002	12:20:20	Ship	60°00.309'N	024°56.667'E	23.2	277.8	276.6	NVLD	6.8	136.2	8761.2	NVLD	
28.11.2002	12:19:20	Ship	60°00.224'N	024°57.401'E	22.3	288.4	287.0	NVLD	4.8	84.7	8760.8	NVLD	
28.11.2002	12:18:20	Ship	60°00.069'N	024°57.977'E	13.9	317.6	307.5	NVLD	10.6	74.6	8760.5	NVLD	
28.11.2002	09:14:20	Auto	59°35.423'N	022°04.062'E	23.2	251.0	251.0	NVLD	7.6	131.0	8689.5	NVLD	

How to set conditions of logging

User can define limits for course change and speed change of own ship to be recorded and also time period for automatic logging. To set them, proceed as followed:

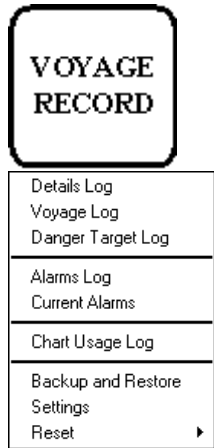

1. Press VOYAGE RECORD button.
2. Select **Settings** from the menu
3. Select **Voyage** sheet open.

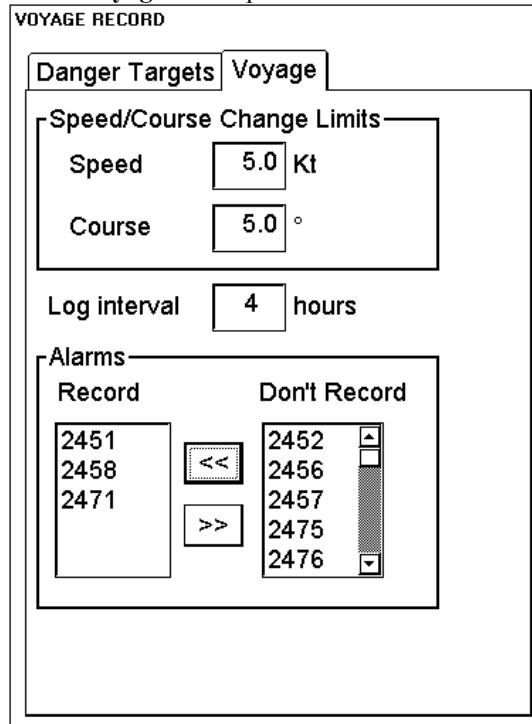

Set desired limits for speed and course and also logging interval.

4. Select desired alarms to **Record** list box, which are recorded when alarm is generated. Alarms are shown here as number. For more information, see Chapter "Alarms".
5. Close dialog box pressing CANCEL push button in Control Panel.

How to reset Voyage log for next voyage

When you think that there is suitable moment to make your voyage log empty, see "How to reset Voyage and Danger Targets logs" on page 390. You should do this at least twice a year. Note that you can make a backup of your voyage log before resetting it see chapter "How to make backup copy from Details, Voyage or Danger Targets log" on page 390.

How to save Positions

User can record various positions in the voyage log. They include:

- direct sensor position (in example below such are DGPS and GLL+ZDA)
- positions calculated by the system (in example below such are Kalman filter and Dead reckoning)
- user observations (in example below such are Visual, Astronomical and MFDF. MFDF is Medium Frequency Direction Finder)

SELECT SENSORS

Speed/Course Pos Other Record

Device: DGPS

Lat: GLL+ZDA

Kalman filter

Dead Reckoning

Visual

Astronomical

MFDF

An example of saving direct position or position calculated by the system

SELECT SENSORS

Speed/Course Pos Other Record

Device: DGPS

Lat: 60°25.353N

Lon: 025°00.462E

Record

An example of saving position based on user observation

First you should locate the position of your observation on the ECDIS chart. Use for example the two separate EBL and VRM available in Nav Tools.

Then open Record sheet of Sensors. Select appropriate method from device list box. Move the cursor over the desired location on the ECDIS screen and press SELECT pushbutton. The latitude/longitude position of the cursor is then copied to Lat and Lon fields. If you are satisfied then press Record to save the position observation into the Voyage Log. If you wish you can also enter manually the Lat and Lon values.

Danger targets log

Danger Target Log is used to store information of targets which are received from ARPA radar (ARPA targets) and/or targets which are received from AIS transponder (AIS targets).

If any of targets, either ARPA target or AIS target, is within CPA and TCPA, information of all tracked targets are recorded into Danger targets log. Data which is recorded contains following information:

- Date and Time, Index of target (number of tracked target on ARPA radar or IMO MMSI number from AIS transponder).
- CPA and TCPA of both AIS and ARPA target
- Position (Lat, Lon), speed (Spd) and course (Cse) of both AIS and ARPA target.
- Heading (Hdg) information of AIS target.

How to view Danger targets log

To open Danger targets log, proceed as follows:



Details Log
Voyage Log
Danger Target Log
Alarms Log
Current Alarms
Chart Usage Log
Backup and Restore
Settings
Reset

1. Press VOYAGE RECORD button.
2. Select **Danger targets log** from the menu
3. The system will start viewing program of log.
4. User is able to make a backup copy, print or print desired part of Danger targets log for later use.

Find below an example of Danger Target log

Date	Time	Type	Lat	Lon	Spd [kt]	Cse [°]	Hdg [°]	Cpa [nm]	Tcpa [min]	Index
27.02.2002	10:47:00	AIS	59°35.257N	024°42.184E	28.0	339.3	339.0	19.1	47.9	8065654
27.02.2002	10:47:00	ARPA	60°09.187N	025°45.466E	6.2	86.0	NVLD	13.8	-24.6	8
27.02.2002	10:47:00	ARPA	59°59.678N	025°14.199E	17.0	250.5	NVLD	NVLD	NVLD	7
27.02.2002	10:47:00	ARPA	60°01.600N	025°29.642E	13.6	247.6	NVLD	6.5	45.4	6
27.02.2002	10:47:00	ARPA	59°56.993N	026°01.462E	10.4	262.8	NVLD	NVLD	NVLD	4
27.02.2002	10:47:00	ARPA	59°56.697N	026°00.463E	0.4	54.7	NVLD	0.2	-52.0	3
27.02.2002	10:47:00	ARPA	59°55.259N	025°40.421E	17.0	254.4	NVLD	5.1	-19.2	2
27.02.2002	10:46:00	ARPA	60°09.185N	025°45.231E	5.1	81.8	NVLD	13.6	-25.5	8
27.02.2002	10:46:00	ARPA	59°59.769N	025°14.725E	17.3	249.2	NVLD	NVLD	NVLD	7
27.02.2002	10:46:00	ARPA	60°01.691N	025°30.063E	13.3	247.5	NVLD	6.6	42.6	6
27.02.2002	10:46:00	ARPA	59°57.016N	026°01.796E	11.1	261.0	NVLD	NVLD	NVLD	4
27.02.2002	10:46:00	ARPA	59°56.698N	026°00.461E	0.8	18.6	NVLD	0.7	-50.9	3
27.02.2002	10:46:00	ARPA	59°55.341N	025°40.954E	17.1	258.8	NVLD	NVLD	NVLD	2
27.02.2002	10:45:00	AIS	59°26.735N	024°46.209E	5.0	44.0	44.0	19.1	84.3	8060404
27.02.2002	10:45:00	AIS	60°06.089N	024°59.650E	18.0	9.6	9.0	19.7	5.0	8060952
27.02.2002	10:45:00	AIS	59°52.466N	025°45.327E	19.0	78.0	81.0	3.0	-10.9	8912510
27.02.2002	10:45:00	AIS	59°46.243N	024°22.637E	12.5	251.3	253.0	14.6	9999.0	7598434

How to set conditions of viewing and logging Danger Targets

User can set Closest Point of Arrival (CPA), Time for CPA (TCPA) and Log interval for viewing dangerous ARPA and AIS targets on ECDIS display, a dangerous ARPA and AIS target is blinking between green and red colour. User can also alternatively log only information of a single selected ARPA or AIS target

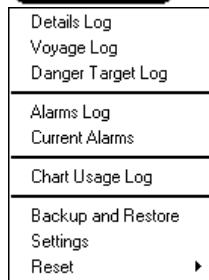

1. Press VOYAGE RECORD button.
2. Select **Settings** from the menu
3. Select **Danger Targets** sheet open.

A screenshot of the "VOYAGE RECORD" settings screen. At the top, there are two tabs: "Danger Targets" and "Voyage". Below the tabs is a section titled "Danger Target Limits" containing two rows: "CPA" with a value of "1.5" and unit "nm", and "TCPA" with a value of "10" and unit "min". Below this is a "Log interval" field with a value of "1" and unit "min". At the bottom is a section titled "Log Single Target" with two dropdown menus: "ARPA" and "AIS".

Set desired limits for CPA and TCPA. Note, these limits are only for ECDIS. ARPA radar has its own setting for dangerous targets and thus a target which is dangerous at ARPA display can be safe on ECDIS or vice versa. If an ARPA target is inside CPA and TCPA, it is shown as dangerous ARPA target on ECDIS display. Log interval defines time period for logging.

NOTE! User is able to select logging of the track of a single ARPA target, if he selects in a **Log Single Target** desired number from a list box of ARPA target or select desired name from a list box of AIS. If this option is selected only information of this target is recorded.

How to save past track of a selected ARPA or AIS target

To save past track of selected target, proceed as follows:

1. Check number of ARPA target or name of AIS targets. In order to get it move cursor above target and press INFO & HELP button.
2. Press Voyage Record button and select Settings from the menu. A Settings dialog box appears, select **Danger Target** sheet open.
3. Select in Single Target Log field ARPA target's number in a list box or name in a list box of AIS. See also "Danger targets log" on page 386.
4. You can make a user chart from Danger Target log, for more information, see chapter "How to make an User chart from the log (Past track)" on page 391.

Note! If you have selected Single Target Log only selected target's information is recorded. If you want record information of all danger targets, just remove selection of Active in a Single Target Log field.

Chart usage log

In Chart usage log is used to store information of charts which were displayed in the ECDIS chart display area or which were used for Chart Alarms. The following information is recorded by the system:

- Chart ID.
- Chart edition.
- The latest update included to chart.
- Displayed Updates Until
- Approved Updates Until
- Center position of display (Lat, Lon).
- Scale of chart display.
- Details of chart selected to be displayed.

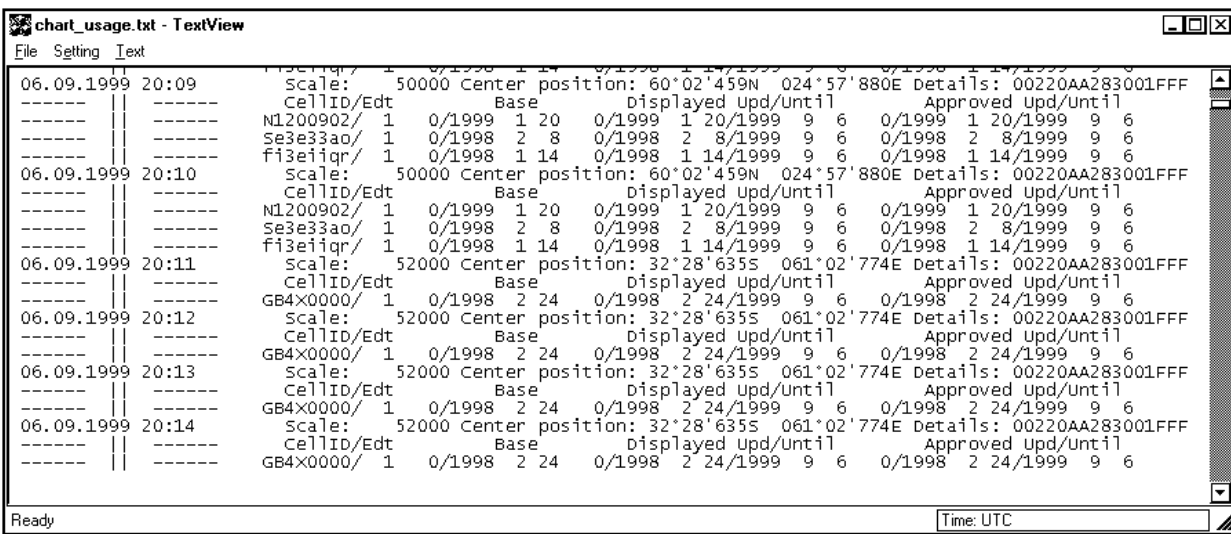

How to print Details, Voyage or Danger Targets log

This procedure is the same if you make User Chart from Details, Voyage or Danger Targets log.

1. Open desired log
2. Select **Print** in **File** menu.
3. A Print dialog box appears, press **OK**. The Entire log will be printed.

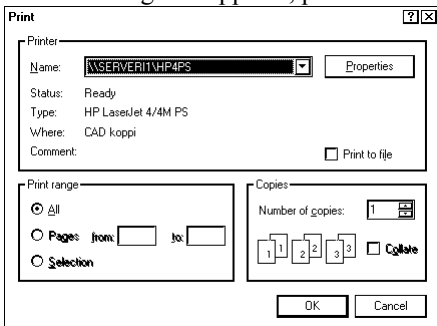

If you are interested in only part of log, it is possible to print selected part of log.

1. Open desired log
2. Choose **Selection** in the **File** menu and **Start** in submenu.
3. Move cursor to location in log where you want to start printing and press **SELECT** in Control Panel.

4. Move cursor to location where you want to stop printing and press SELECT button in Control Panel.
5. Select **Print** in **File** menu.
6. A Print dialog box appears, press **OK**.

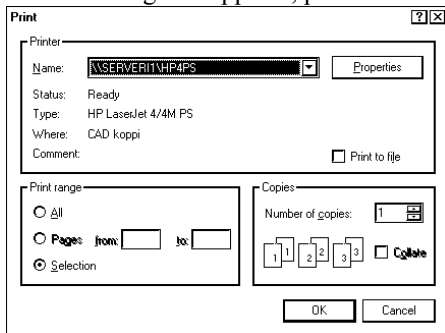

7. Selected rows are printed.

Date	Time	Type	Lat	Lon	Align [nm]	Align [°]	Spd [kn]	Crs [°]	Hdg [°]	Corr. [°]
05.07.2000	11:57:00	Auto	60°00.651N	025°07.493E	0.0	0.0	16.4	42.7	40.5	-1.6
05.07.2000	11:56:00	Auto	60°00.475N	025°07.083E	0.0	0.0	16.4	57.0	54.6	-1.2
05.07.2000	11:55:00	Auto	60°00.359N	025°06.596E	0.0	0.0	16.3	72.4	70.3	-0.7
05.07.2000	11:54:00	Auto	60°00.310N	025°06.053E	0.0	0.0	16.4	86.7	85.2	-0.2
05.07.2000	11:53:00	Auto	60°00.335N	025°05.514E	0.0	0.0	16.4	104.7	104.4	0.5
05.07.2000	11:52:00	Auto	60°00.413N	025°04.981E	0.0	0.0	16.3	106.5	107.1	0.6
05.07.2000	11:51:00	Auto	60°00.489N	025°04.476E	0.0	0.0	16.3	106.4	107.1	0.6
05.07.2000	11:50:00	Auto	60°00.566N	025°03.951E	0.0	0.0	16.4	106.4	107.0	0.6
05.07.2000	11:49:00	Auto	60°00.642N	025°03.432E	0.0	0.0	16.3	106.4	107.0	0.6
05.07.2000	11:48:00	Auto	60°00.720N	025°02.903E	0.0	0.0	16.5	106.5	107.1	0.6
05.07.2000	11:47:00	Auto	60°00.799N	025°02.367E	0.0	0.0	16.7	106.3	107.0	0.6
05.07.2000	11:46:00	Auto	60°00.876N	025°01.837E	0.0	0.0	16.4	106.3	106.9	0.6
05.07.2000	11:45:00	Auto	60°00.954N	025°01.307E	0.0	0.0	16.4	106.3	106.9	0.6
05.07.2000	11:44:00	Auto	60°01.029N	025°00.790E	0.0	0.0	16.4	106.3	106.9	0.6
05.07.2000	11:43:00	Auto	60°01.107N	025°00.265E	0.0	0.0	16.4	106.5	107.1	0.6
05.07.2000	11:42:00	Auto	60°01.184N	024°59.744E	0.0	0.0	16.3	106.8	107.4	0.6
05.07.2000	11:41:00	Auto	60°01.265N	024°59.219E	0.0	0.0	16.4	107.5	108.0	0.6

Selected part of log before print. Highlighted part of log will be printed by print command.

How to change font size for paper copy of logs

In each log (Details, Voyage or Danger Targets log) you can select font size for printed version. To change font size, proceed as follows:

1. Open desired log
2. In the **View** menu, select **Font size** and choose desired size in sub menu.

How to make backup copy from Details, Voyage or Danger Targets log

If necessary you can make a backup copy of ECDIS logs onto floppy disk as follows:

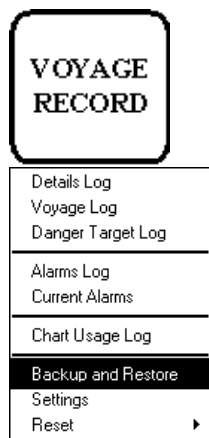

1. Press VOYAGE RECORD button.
2. Select **Backup and Restore** from the menu.
3. A Backup and Restore window appears,

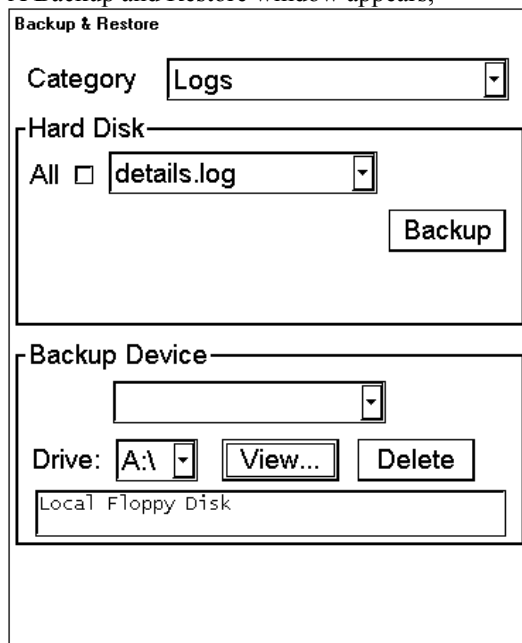

Select desired log and Drive for Backup copy. When selected, press **Backup** button.

How to reset Voyage and Danger Targets logs

It may be useful to reset Voyage and Danger Targets Logs when you are starting a new voyage. If necessary make a backup copy before resetting. To reset, proceed as follows:

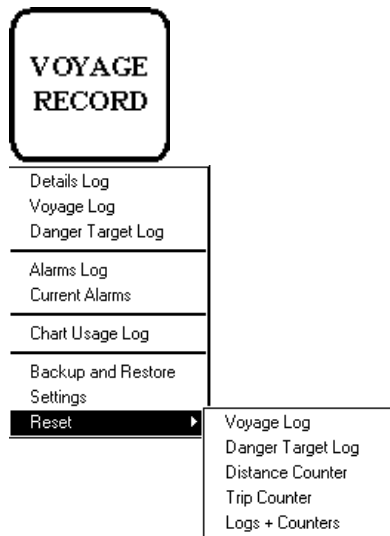

1. Press VOYAGE RECORD button.
2. Select **Reset** from the menu and desired log from the submenu.
3. The system will ask you if you are sure to reset log. Press **OK** and the system resets the log.

How to make an User chart from the log (Past track)

This procedure is the same if you make User Chart from Details, Voyage log or Danger Target log (past track of Danger Target log is useful when you make an User Chart from single target).

1. Press **Voyage Record** pushbutton.
2. Select **log** you want make an User Chart from the menu. It will take a few seconds until a log viewer appears.
3. Select from A Log viewer's File menu **Save as User Chart** command.

Date	Time	Lat	Lon
19.02.2002	13:09:40	59°50.142N	024°28.193E
19.02.2002	13:09:30	59°50.157N	024°28.284E
19.02.2002	13:09:20	59°50.169N	024°28.365E
19.02.2002	13:09:10	59°50.184N	024°28.466E
19.02.2002	13:09:00	59°50.198N	024°28.566E
19.02.2002	13:08:50	59°50.211N	024°28.647E
19.02.2002	13:08:40	59°50.226N	024°28.747E
19.02.2002	13:08:30	59°50.240N	024°28.828E
19.02.2002	13:08:20	59°50.253N	024°28.919E
19.02.2002	13:08:10	59°50.267N	024°29.010E
19.02.2002	13:08:00	59°50.280N	024°29.102E
19.02.2002	13:07:50	59°50.295N	024°29.192E
19.02.2002	13:07:40	59°50.307N	024°29.282E
19.02.2002	13:07:30	59°50.322N	024°29.373E
19.02.2002	13:07:20	59°50.337N	024°29.474E
19.02.2002	13:07:10	59°50.349N	024°29.555E
19.02.2002	13:07:00	59°50.361N	024°29.636E
19.02.2002	13:06:50	59°50.376N	024°29.736E
19.02.2002	13:06:40	59°50.391N	024°29.828E
19.02.2002	13:06:30	59°50.403N	024°29.918E
19.02.2002	13:06:20	59°50.417N	024°30.000E
19.02.2002	13:06:10	59°50.432N	024°30.101E
19.02.2002	13:06:00	59°50.445N	024°30.191E
19.02.2002	13:05:50	59°50.457N	024°30.272E
19.02.2002	13:05:40	59°50.472N	024°30.372E
19.02.2002	13:05:30	59°50.487N	024°30.464E
19.02.2002	13:05:20	59°50.501N	024°30.554E
19.02.2002	13:05:10	59°50.514N	024°30.644E
19.02.2002	13:05:00	59°50.529N	024°30.744E
19.02.2002	13:04:50	59°50.541N	024°30.827E
19.02.2002	13:04:40	59°50.555N	024°30.917E
19.02.2002	13:04:30	59°50.568N	024°31.007E

4. User chart conversion dialog box appears. In this dialog box there are following fields:
 - **User chart name**; in this field enter name for log which is saved as User chart.
 - **Elements will be displayed on radar**; if this is selected, chart will be displayed also on radar screen.
 - **Filter**; if selected, system filters log so that minimum distance between points in the User chart is 0,3 NM.
5. **Select log rows for user chart conversion**; in this window is shown the contents of log. User can select the entire log or part of it. For the selection of conversion points use **SELECT** pushbutton to select first point for the User chart, then roll TRACK BALL and hold down **SELECT** button until you have select last point for the User chart.
6. Function of the pushbuttons in the dialog box;
 - **OK**; converts selected points to User chart and closes dialog box.
 - **Cancel**; closes dialog box without doing anything.
 - **Select all**; selects all the points.
 - **Unselect all**; removes selection.
 - **Save in file**; saves selection to the file named in User chart name -field and keep this dialog box open for further selection to the same file. (It makes possible to save in the same file separate part of log.).

NOTE! If your selected range for conversion from log to User chart contains periods of not valid own ship position, then the User chart has a gap in the line for these periods.

Alarms log

An Alarm's log is used to collect and record alarms generated by the system. User is able to view list of generated alarms using alarm log viewing program.

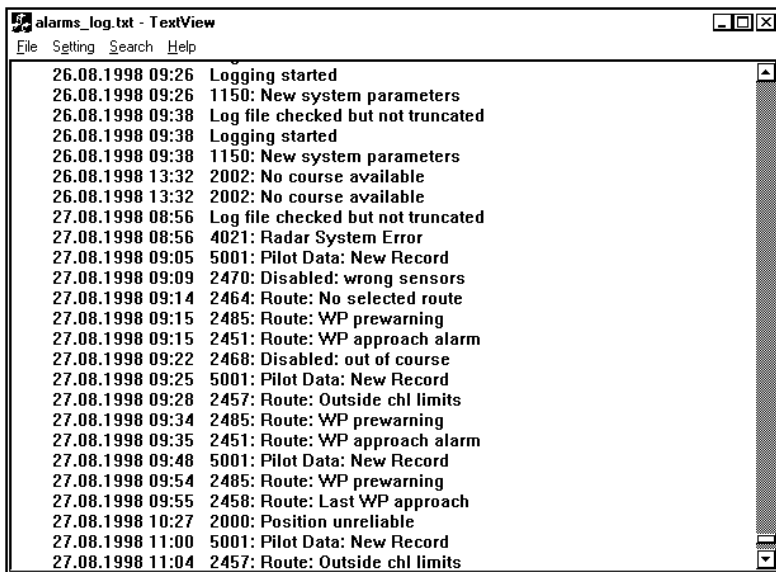

Possible view of latest alarm. A time and date, number of alarm and explanation are listed in Latest alarm log.

To open log, proceed as followed:



1. Press VOYAGE RECORD button.
2. Select **Alarms Log** from the menu
3. The system will start viewing program of log.
4. User is able to print log.

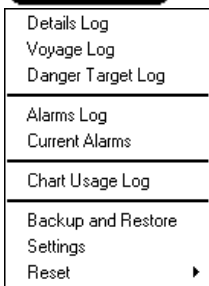

How to print Latest Alarm

1. Press VOYAGE RECORD button.
2. Select **Alarms Log** from the menu
3. The system will start viewing program of log.
4. Select **Print** From the File menu. A print dialog box appears, press **OK**.

Distance and Trip counters

Distance and Trip counters have separate fields both through water and over ground distances. This information is available on Other page of Select Sensors. To reset Distance and/or Trip counter, see chapter "How to reset distance counter and trip counter" on page 393.

SELECT SENSORS - Source: EC1000_002

Speed/Course | Pos | Other | Record

Wind

True Wind Kt °

Set and Drift

(log) Angle 0.0 ° Manual

Set ° Drift Kt

Pitch and Roll

Pitch ° Roll °

Depth below transducer m

Gyro correction °

Over Ground

Distance counter 910.9 nm

Trip counter 910.9 nm

Through Water

Distance counter 910.8 nm

Trip counter 910.8 nm

AIS Targets

Danger and Lost Target Alarms

Received data Ok

Display Ok

Storage Ok

How to reset distance counter and trip counter

It is useful to reset distance counter when you are starting a new voyage. To reset distance counter, proceed as follows:

1. Press VOYAGE RECORD button.
2. Select **Reset** from the menu and **Distance counter** from the submenu.

The system will ask you if you are sure to reset Distance Counter. Press **OK** and the system resets it

To reset trip counter, proceed as follows:

1. Press VOYAGE RECORD button.
2. Select **Reset** from the menu and **Trip counter** from the submenu.

The system will ask you if you are sure to reset Trip Counter. Press **OK** and the system resets it

This page is intentionally left blank

Datum

General

Datum is a mathematical model of the earth, based on which the sea chart has been made. Datum connects together the positioning and the sea chart. If the Datum of position sensor and the sea chart are different, a transformation has to be made somewhere in the system. Not doing so can result errors of several sea miles. Generally, it can be assumed that the error is at least of the magnitude of a cable (0.1 NM). The difference between two Datums is never constant, but depends on position. This means that the difference term of WGS 84 and local Datum, generally used in paper charts, is not generally valid with electronic sea charts.

Paper charts

Datums used in paper charts has been traditionally national Datums for historical reasons. Many paper charts do not have a marked Datum, compatibility with electronic charts may be complicated. In some paper charts, the correction terms instead of Datum are printed, for correction of the WGS 84 system satellite locations. The correction terms are usable but only with the paper chart in question.

Electronic sea charts

Until now, electronic sea charts have generally been based on rasterizing or vectorizing of paper charts, resulting in the respective transfer of the local Datum.

Exceptions:

- The ARCS (raster) material includes polynomials for each chart, making it possible for the ECS system to solve the difference between the WGS 84 Datum and the local Datum with an accuracy sufficient for authority responsibility. In some charts, the mentioned difference is not known with sufficient accuracy, resulting in displaying a permanent warning window when displayed in ARCS compatible systems.

Cursor		
From Own Ship:	2.180 nm	185.5°
59°49.370'N	024°27.615'E	

- ENC vector material, which according to S57 standard has to be produced by National Hydrographic Office in the WGS-84 Datum.

Positioning devices and Datum

In early days of the electronic positioning devices, no attention was generally paid to Datums because the commonly used systems utilised special charts (like Decca charts). Later on, a data output was added to these systems, but still no attention was paid to Datums and the errors were considered as inaccuracy of the system. The spread of the GPS has made Datum better known. There is no value of an accurate position, if co-ordinates are in a wrong Datum. GPS satellites in the scope utilise the WGS-84 Datum. However the WGS-84 Datum is not a general solution for all positioning systems, due to differences between electronic sea chart system and the chart material displayed.

ECDIS and Datum

The real ECDIS uses ENC material, produced to standards using WGS-84 Datum. Positioning devices connected to ECDIS must work in the WGS-84 Datum. The IMO resolution requires that the ECDIS must give an alarm, if the datum of positioning device is not the WGS-84. In practice this is impossible, because the standard used by positioning devices (IEC-1162, previously NMEA-183) does not include a Datum message. Consequently, the classification societies only approve positioning device in which Datum cannot be changed (i.e. is always WGS-84) to be interfaced to the ECDIS.

NOTE, The ability to check datum of position is a relatively new feature for position receivers. It was introduced in standard IEC 61162-1 Ed2 Published in July 2000. Only EPFS (for example GPS or DGPS) ,which has "IEC 61162-1 Ed 2 (2000-7)" indicated in their type approval certificate can support the ECDIS to detect Datum mismatch.

ECDIS and user selectable local Datum

The ECDIS provides for user a possibility to change viewed datum. See chapter "How to select Datum" on page 398. This selection of the datum does not change anything inside the ECDIS for navigation calculation processes or for electronic sea chart display processes. But it changes the numerical values of positions displayed on the ECDIS screen into the user selected Datum. This is very useful, if you like to plot positions from the ECDIS on traditional paper chart.

Parameters setup

Parameters

There are in the INITIAL SETTING menu **Installation parameters**, **Navigation parameters** and **Optimization parameters** commands, which define the configuration of ECDIS and operative parameters which are either used to control steering and navigation calculation or used during route planning.

Functionality of Initial setting push button is following:

1. When you press INITIAL SETTING push button, **INITIAL SETTING** dialog box will appear to Dialog box area.
2. Press INITIAL SETTING push button again, you will get Initial setting menu on display.



INITIAL SETTING button

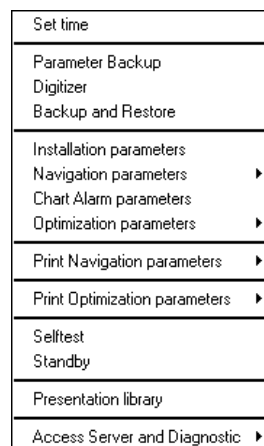

Set time:

User can set date, local time and time zone. Following windows appear, when Workstation is defined as Sensor source.

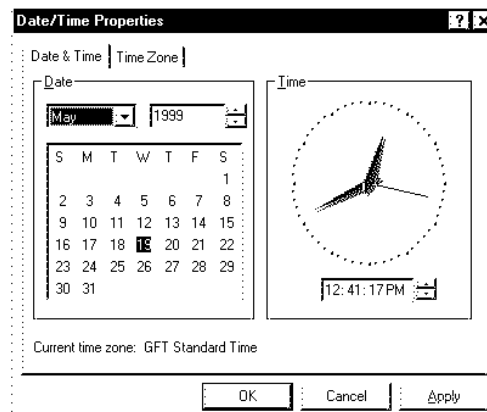
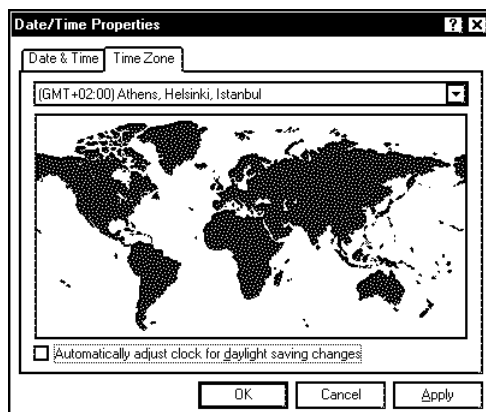

Following windows appear, when you try to set time any other Workstation:

Only Time zone can be set. Select desired time zone from the list box. If time is liked to be set, you have to set it a Workstation selected as Sensor source.

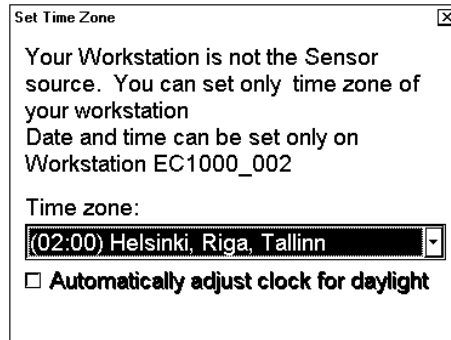

Parameter backup:

User can take backup copy from parameters. See chapter "Backup operation".

Installation parameters:

The ECDIS system parameters are set by installation parameters. **Note!** To access Installation parameters, you will need a key disc, which was delivered by the manufacturer. See Technical Manual for details.

Navigation parameters:

This function is used to define parameters for a ship and a route. For more information about setting Navigation parameters, see "Ship and route parameters" on page 399.

Optimization parameters:

This function is used to define parameters for speed and fuel consumption. For more information setting Optimization parameters, see "Optimization parameters setting" on page 402.

Print navigation parameters:

Prints navigation parameters to default printer.

Print optimization parameters:

Prints optimization parameters to default printer.

How to access to installation parameters

Installation parameters command is used to set installation parameters for the system. All these parameters have something to do with hardware configurations and setup. It is necessary to modify them **only** during installation and later changes of sensor configuration. While this function is not part of normal operation, it is fully described in the technical manual.

How to select Datum

Datum is used to select between different models of the earth. It is essential that you use Datum in a consistent way. See also chapter "ECDIS and Datum" on page 396.

If you use paper charts together with electronic chart material, it is recommended that you use the same Datum as your current paper chart to avoid misalignment between your electronic system and points taken or plotted on your current paper chart.

Once you have selected a datum, all numerical latitude-longitude position values are presented in your selected datum.

Note: If you use ARCS raster chart material the rasterized charts contain some rasterized position information. These positions like scales in the edges of ARCS charts are true only if you have selected native datum of that ARCS chart. Normally this is the natural situation, because you use ARCS together with equal official paper chart and because you have selected as datum the datum of your equal official paper chart.

To select datum proceed as follows:

1. Press **Initial setting** push button and select **Datum** from the list box.

2. Select desired datum from **Datum** the list box.

INITIAL SETTINGS

Datum WGS 84

Gyro WGS 84

Position **European 1950**

Adindan

Africa

3. Selected datum is shown on the Upper information area.

60°01.538'N Gyro (corr) 89.9°

025°01.031'E COG 89.9°

European 1950 (pos) SOG 17.2 Kt

DGPS

Selected datum is shown on Upper information area (in this case European 1950).

Navigation parameters setting

Ship and route parameters

The purpose of Navigation parameters is set the basic parameters for the ship. These parameters are relative to ship steering and they are very important for a correct function of the integrated navigation system. Parameters must be maintained carefully. Necessary modification must be carried out with a good knowledge of the parameters importance.

In order to get edit Ship and Route parameters, proceed as follows:

1. From Control Panel press INITIAL SETTING.
2. From menu select **Navigation parameters**.
3. From submenu select **Ship and Route parameters**.

SHIP and ROUTE PARAMETERS

Ship parameters

Ship max. speed 23.0 Kt

Ship max. height 34.0 m

Ship draught 10.0 m

Gyro error correction Manual

Gyro spd/lat error On

Max gyro error correction 3.0 °

Manual gyro correction 0.2

Route parameters

Max rate of turn 200 °/min

Turn end tolerance 2 °

WP approach alarm time 60 s

WP prewarn alarm time 120 s

Route start limit angle 20 °

Default line radius 0.3 nm

Drift compensation On

Gyro error compensation Off

Ship parameters:

Ship max. speed:

Maximum speed the ship can perform.

Ship max. height:

Max. height of ship for generating alarms for objects which are hanging above sea level.

Ship draught:

Max. draught of ship for generating alarms for objects which are below sea level.

Gyro error correction:

Used to select method of gyro error correction.

Gyro spd/lat error:

Used to select speeds/latitude correction method of gyro error correction.

Max gyro error correction:

This is the limit for the maximum correction allowed. Typical value 3 degrees.

Manual gyro correction:

Used to adjust gyro correction manually.

Route parameters:**Max Rate of Turn:**

Indicates the maximum rate of turn of the ship.

Turn end tolerance:

This defines the window for the detection of the end of turn. Typical values are between 2 to 4 degrees.

WP approach alarm time:

Used to set the alarm time before approaching the wheel over point.

WP prewarn alarm time:

Used to set the alarm time well before approaching the wheel over point.

Route start limit angle:

Used to set the maximum approach angle against planned course in order to accept start of automatic Route Steering.

Default line radius:

Used to define the default value of radius between waypoints during automatic Route Steering.

Drift compensation:

Enables/disables the drift compensation during automatic Route Steering.

Gyro error compensation:

Enables/disables the gyro error compensation of set course during automatic Route Steering.

Forwarding distance

The forwarding distance is the distance the ship travels straight after the steering command is given to the autopilot. This distance may vary with a different required radius of turn. The logic to verify the correct distance is to perform a manoeuvre of 90 degrees (Port and Starboard), with a SMALL RADIUS (0.3 NM), and verify from the radar, using curved EBL, if the turn goes "long" or is too "sharp". The parameter should also be verified with different radius. (Most important radius values are between 0.3 to 1.0 NM). You can define set of Forwarding Distances both for "Go To Track" and "Go To WP" steering modes.

In order to get edit Forwarding distances parameters, proceed as follows:

1. From Control Panel press INITIAL SETTING.
2. From menu select **Navigation parameters**.
3. From submenu select **Forwarding distances**.
4. Insert **Authorizing key disk** to floppy drive.
5. Select **Enable changes** to modify desired set of Forwarding Distances.

FORWARDING DISTANCES			
GO TO TRACK		GO TO WP	
Port			
Radius /nm	Speed		
	20%	50%	100%
0.3	0.150	0.110	0.190
0.7	0.140	0.091	0.175
1.5	0.140	0.076	0.170
Starboard			
Radius /nm	Speed		
	20%	50%	100%
0.3	0.150	0.111	0.092
0.7	0.140	0.093	0.170
1.5	0.140	0.075	0.170
<input type="checkbox"/> Enable changes			

Normally these parameters are entered during sea trial but can also be modified later on. See figures below:

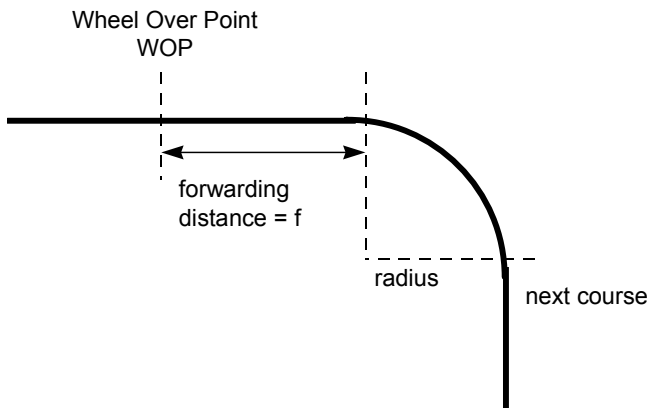

This Figure shows how Forwarding distance is defined.

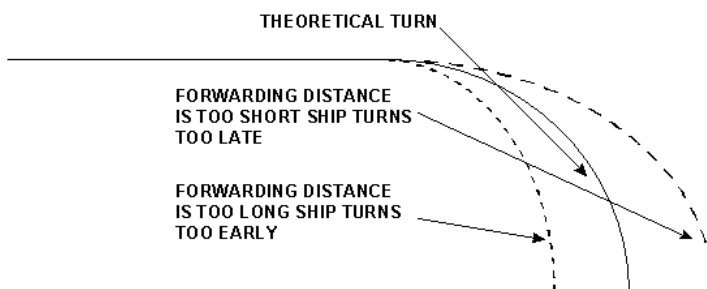

Influence of forwarding distance to ship's turn.

Optimization parameters setting

The optimization parameters are used in optimization calculation. Therefore it must be defined these parameters before calculation.

In order to get modify Optimization parameters, proceed as follows:

1. From Control Panel press INITIAL SETTING
2. From menu select **Optimization parameters**
3. Modify Optimization parameters by moving cursor to desired edit box and pressing select. This allows user to modify value.

PLANNING OPTIMIZATION PARAMETERS		
Cost		
Hour \$/h	HFO \$/ton	DO \$/ton
1200	150	200
Speed Kt	HFO ton/h	DO ton/h
0.0	0.000	0.000
2.0	0.200	0.100
4.0	0.400	0.100
6.0	0.800	0.100
8.0	1.400	0.100
10.0	1.600	0.100
12.0	1.800	0.100
14.0	2.200	0.100
16.0	2.700	0.100
18.0	3.300	0.100
20.0	4.000	0.100

Note: HFO: Heavy fuel oil

DO: Diesel oil

This is very important data table, which contains ship's fuel consumption with the different speeds. There are 11 different speeds used to indicate fuel consumption on that specific speed. Prior to entering data to the form prepare following graphic in order to find those 11 points.

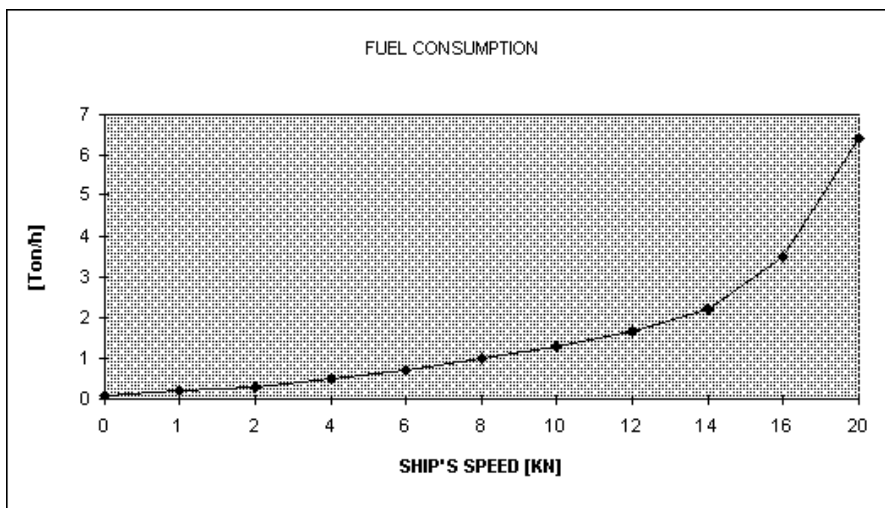

Set 11 points on the graphics as explained above. Transfer those 11 points to the table. Use more points where the curve bends more.

Example: 3,5 KN = 0,72 Ton / Hour HFO

Use the second graphic for Diesel Oil, if the Diesel Oil consumption is relative to the speed.

Colour Calibration

Settings of colour calibration

NOTE! Use of the brilliance control (with FEA-2105 monitor) and brightness and/or contrast control (with Conrac monitor) may adversely affect the visibility of information on the night display.

Brilliance, (FEA-2105 monitor) and Brightness and Contrast, (CONRAC monitor), are adjusted in initial factory calibration so that when the controls are in "CAL" position the ECDIS display fulfils the colour calibration for colour purity and colour differentiation. The calibrated positions are marked as below:

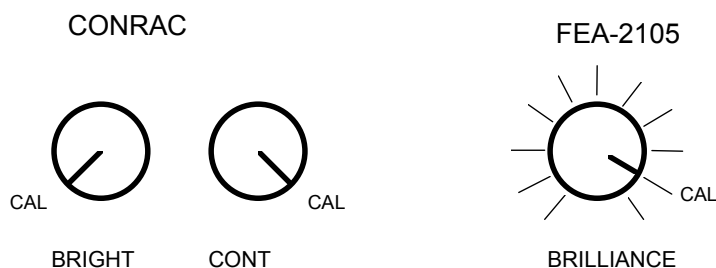

Colour test for ARCS charts

It is a known thing that the colours in a monitor change when the monitor ages. Also you may want to use other setting of the Brilliance, (FEA-2105 monitor) and Brightness and Contrast, (CONRAC monitor), than the "CAL" position. For both cases you have a tool to check that you can clearly see all details of the charts. For ARCS chart this tool is Colors.

Press CHART PLAN and select Color from the menu. In ARCS Colours window you can see if the individual colours can be distinguished when viewing. This is to enable you to be aware of how light levels may affect the visibility of the chart.

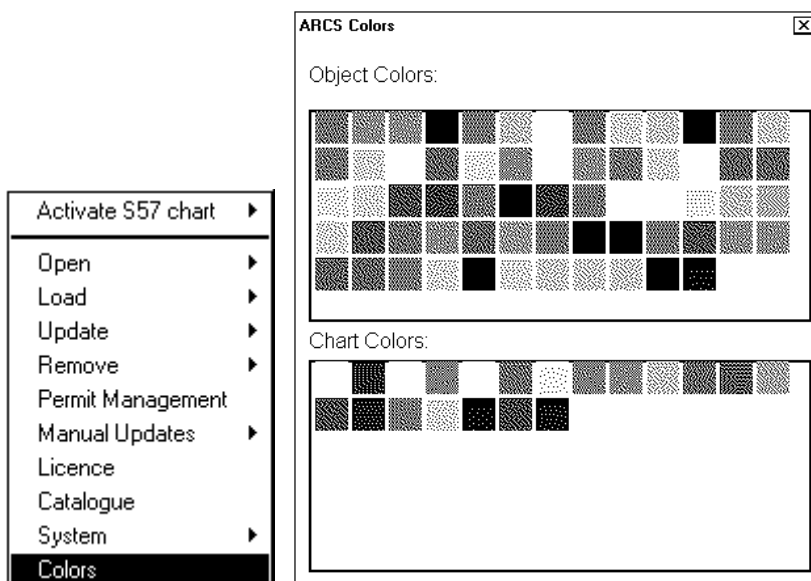

Colour Differentiation test for S57 charts

It is a known thing that the colours in a monitor change when the monitor ages. Also you may want to use other setting of the Brilliance, (FEA-2105 monitor) and Brightness and Contrast, (CONRAC monitor), than the "CAL" position. For both cases you have a tool to check that you can clearly see all details of the charts. For S57 charts this tool is Colour Differentiation Test diagram.

The Colour Differentiation Test Diagram is a part of ECDIS chart 1 and you can use it as follows:

CHART PLAN

1) Press CHART PLAN button

Activate ARCS chart
 Open
 Load
 Remove
 Permit Management
ECDIS Chart 1
 Catalogue
 Cell Status
 Date Dependent
 Manual Updates
 SENC Convert
 SENC Convert Settings
 RENC Purchase
 RENC Connection
 System

2) Select ECDIS Chart 1 from the menu

SET CHART CENTER

4) Press SET CHART CENTER button

ZOOM IN

5) Press ZOOM IN button twice

6) Check with all palettes that you can discriminate the lines from background colour of the boxes

404 • Colour Calibration

Download from www.Somanuals.com. All Manuals Search And Download.

Grey Scale test

Set **Brilliance** and **Contrast** to **calibrated positions**. Use **Grey Scale** to visually inspect neutral shades of grey.

Note, during Selftest the ECDIS is unable to do any navigation related things and as an indication the System Failure is activated in the Control Panel.

To activate grey scale test proceed as follows:

1. Press INITIAL SETTING button and select **Selftest** from the menu.
2. Confirm starting Selftest, press **OK**.

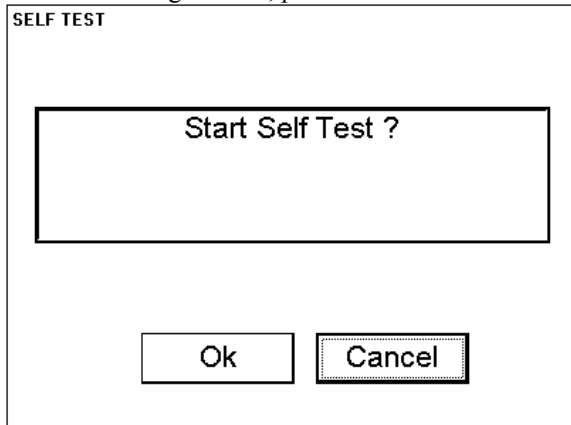

3. The system will end normal operating and start a Selftest module.

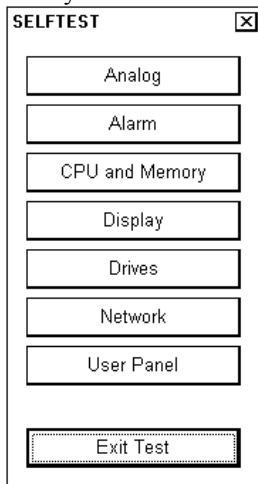

4. Execute **Display** of Selftest pressing soft key button.

5. Press **Grey Scale** button in upper right hand corner of display, **following display appears:**

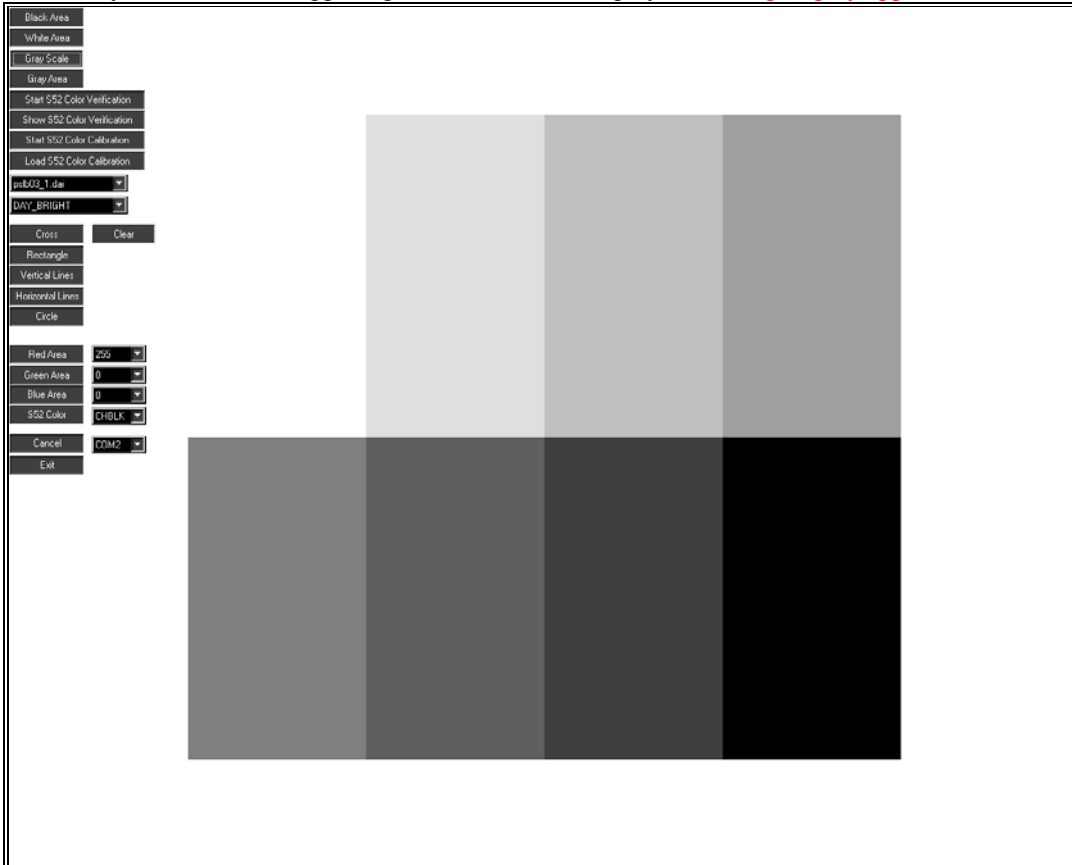

Make visual inspection neutral shades of grey.

6. Close Display test by pressing **Exit** button in the display.
7. Stop Selftest pressing **Exit Test**, The system will start now normal operation.

Conning Display

System Configuration

The ECDIS is able to receive information from various sensors. The ECDIS can adopt information either in analogic or in serial data format which is sent by the sensors, makes navigation calculation from received data and shows this information on Conning Display (Conning Display is an optional device).

The ECDIS can be connected to up to eight sensor which send analogic data and up to eight sensors which send serial data.

Information displayed on Conning display is depending on selections in ECDIS and setup in Installation Parameters of ECDIS where you can define layout of displayed information in Conning Display.

There are six predefined places to locate desired windows to conning display. The centre of display is fixed to show information defined by the manufacturer, but both sides of display you can select freely displayed windows. (For more information to select displayed windows, see Chapter "Installation Parameters" in Technical manual of ECDIS EC 1000.)

There is a figure below to show locations of user defined windows. The content of windows are defined in Installation Parameters of ECDIS.

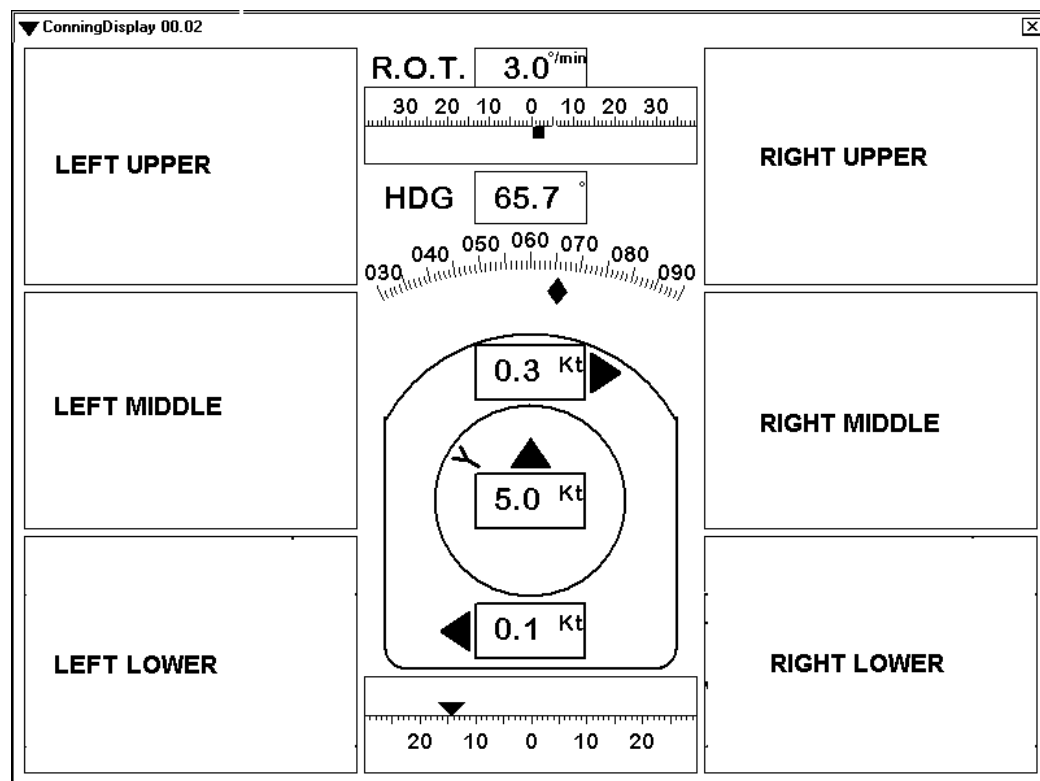

Display Interpretation

Conning display is used to display collected data from different sensors. In a Conning display you have following options to choose which information is shown on conning display. This depends on which sensors are installed and connected on board the vessel.

Typically information which is displayed on Conning Display are received from following sensors:

- position sensors
- wind sensor
- gyro
- rate of turn gyro
- log
- dual axis log
- rudder
- propellers
- thrusters

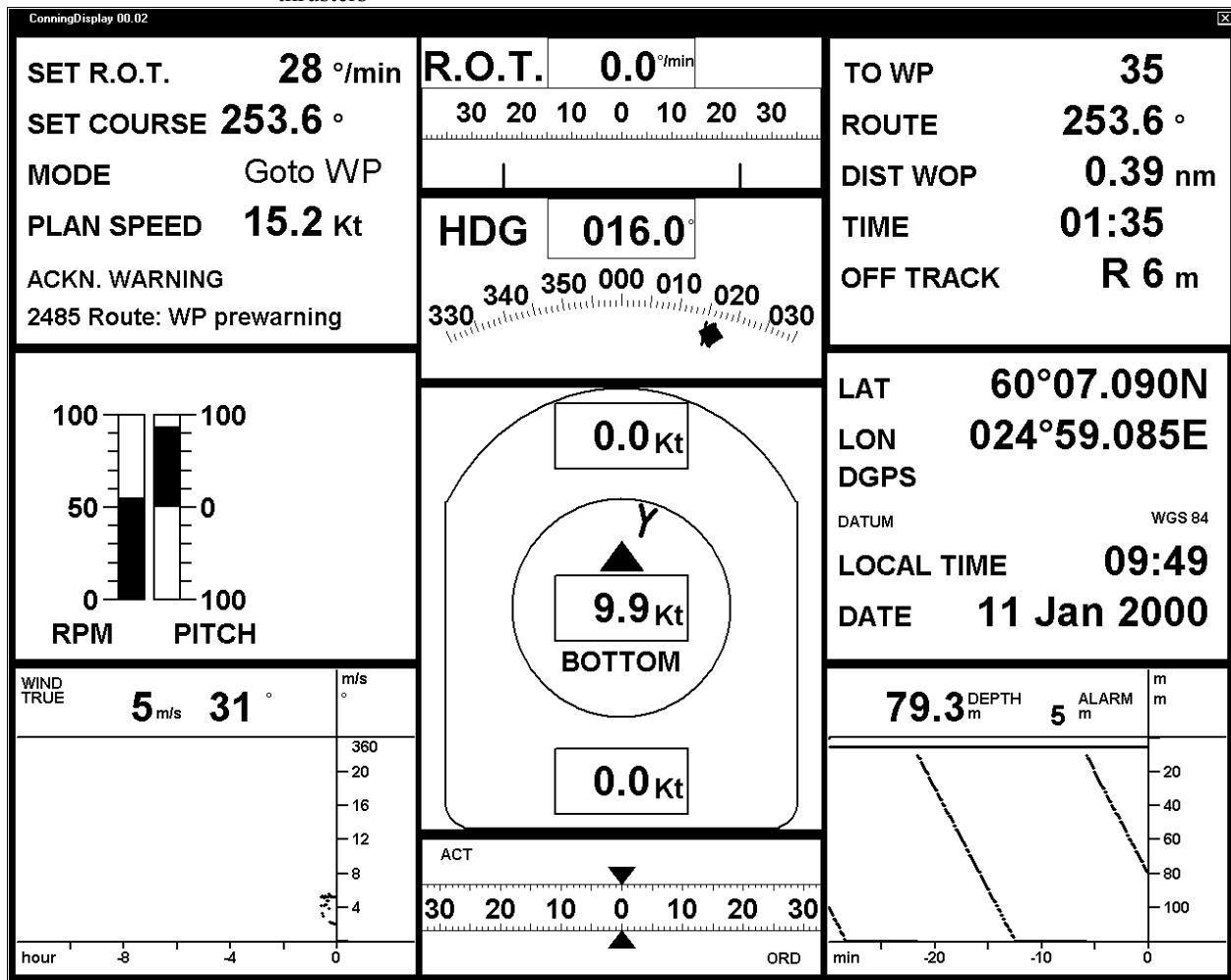

Typical layout of Conning Display in Navigate Mode.

Rate of Turn information

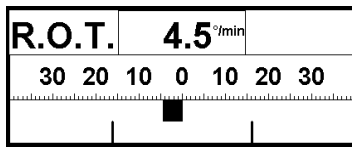

In this window user can monitor actual R.O.T, which is displayed as numerical information in an upper box and below this box same value is shown with direction by horizontal bar. Indication **CALC** is displayed if R.O.T. is calculated by the System. See also Chapter "Navigation Sensors".

Heading information

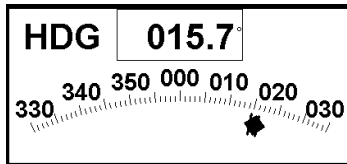

There is shown following information in this window

1. Gyro course, both in numerical and in graphical format Source of heading is indicated as text (**mag**) for magnetic compass, (**corr**) for corrected heading value in ECDIS, (**1**) for Gyro 1, (**2**) for Gyro 2.
2. Diamond figure shows heading in graphical format See also Chapter "Navigation Sensors".

Speed information

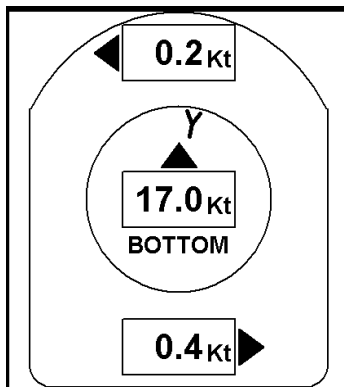

In this window there is shown following information

1. Bow speed
2. Longitudinal speed
3. Stern speed
4. Source of speed indicator (BOTTOM in example) . If source of speed is last plausible speed (LAST), then all speed values are in red colour.
5. Direction of true wind relative to own ship. NOTE, this indication is available, when RELATIVE WIND mode is selected to be displayed. See also Chapter "Navigation Sensors".

Rudder information

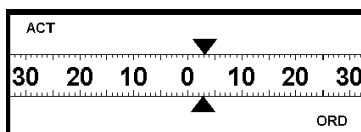

In a Rudder window there is shown following information

1. First rudder and source of the first rudder. In this example the source is actual rudder (ACT).
2. Second rudder and source of the second rudder. In this example the source is ordered rudder (ORD).

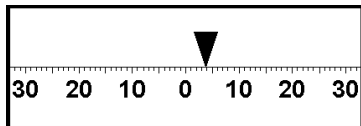

In this example only one rudder connected.

Position information

LAT	60°10.129N
LON	025°03.262E
DGPS	
DATUM	WGS84
LOCAL TIME	09:58
DATE	23 Dec 1999

This is called Position window. The following information is displayed:

- LAT and LON of own ship position
- Source of own ship position, see also Chapter "Navigation Sensors".
- Datum of own ship position. See Chapter "How to select Datum".
- Local Date and time. Current date and time used in the ECDIS.

Drift and radius information

SET RADIUS	1.0 nm
ACT RADIUS	0.96 nm
HDG	005.9 °
DRIFT	> 0.7 °
COG POS	006.6 °

This is called Drift and Radius window. Following information is displayed in this window:

- **SET RADIUS**; current set radius on Track Pilot.
- **ACT RADIUS**; current radius of turn.
- **HDG**; current heading
- **DRIFT**; direction and angle of drift.
- **COG**; Course Over Ground and source of it.

Track Pilot information

SET R.O.T.	28 °/min
SET COURSE	253.6 °
MODE	Goto WP
PLAN SPEED	15.2 Kt
ACKN. WARNING	
2485 Route: WP prewarning	

This is called Track Pilot window. Following information is displayed in this window:

- **SET R.O.T.**; current set rate of turn based on current speed and set turning radius.
- **SET COURSE**; current set course.
- **MODE**; indicates selected steering mode
- **PLAN SPEED**; planned speed in current leg of the monitored route.
- **ACKN WARNING**; steering related alarms displayed in lower Status bar of ECDIS are also displayed in Conning Display.

SET RADIUS	0.5 nm
PROG CRS	015.0 °
SET COURSE	006.9 °
SET HDG	006.9 °
MODE	Prg Track Turn
ACKN. WARNING	

This is called Track Pilot Extended window, where following additional information available:

- **SET RADIUS**; indicates selected radius for turn.
- **PROG CRS**; course after turn designed by Program Course Change or Program Track steering mode.
- **SET HDG**; calculated heading for vessel based on **SET COURSE** and **Drift**. This information available when **Program Track** steering mode is in use..

Route information

TO WP	35
ROUTE	253.6 °
DIST WOP	0.39 nm
TIME	01:35
OFF TRACK	R 6 m

This is called Route window. When you have select a Route to be monitored following information is displayed in this window.

- "To WP" is the waypoint ship is approaching
- Route is calculated set course to follow the Monitored route including off track, drift and gyro error compensation.
- Distance to Wheel Over Point (WOP)
- Time left to reach WOP
- Distance to center line of route

TO WP	2
ROUTE	006.2 °
DIST WOP	0.07 nm
TIME	00:23
OFF TRACK	R 2 m
NEXT	010.6 °
RADIUS	1.0 nm

An example of Route with next leg window, where following additional information available:

- **NEXT**, planned course to steer after "To WP".

NOTE; Text (**corr**) in red colour is displayed beside **NEXT** to indicate that the value of planned course to steer after "To WP" is compensated for gyro error correction. This condition exists if

- **Gyro error correction** has been enabled in Navigation Parameters **and**
- gyro value is compensated for gyro error correction **and**
- **Gyro error compensation** have been enabled in Navigation Parameters.
- **RADIUS**, planned turning radius of "To WP".

Weather information

NORTH WIND	13.5 m/s	27°	m/s ° mbar
			360 20 1020 16 1008 12 996 8 984 4 972
hour	-8	-4	0

This is called Weather window. Two alternatives are available: True Wind and North Wind. The following information is displayed:

1. Wind speed, see also Chapter "Wind Sensor"
2. Wind direction, True or North, see also Chapter "Wind Sensor"
3. Air pressure, which is optional

This window shows the weather condition of last 12 hours

TRUE WIND	13.5 m/s	9°	m/s ° mbar
			360 20 1020 16 1008 12 996 8 984 4 972
hour	-8	-4	0

Depth information

This is called Depth window. Three alternatives are available: 50m, 100m and 200m depth scale. There is displayed graphically last 30 minutes depth information from Echo Sounder and depth alarm limit. See also Chapter "Depth Sensor".

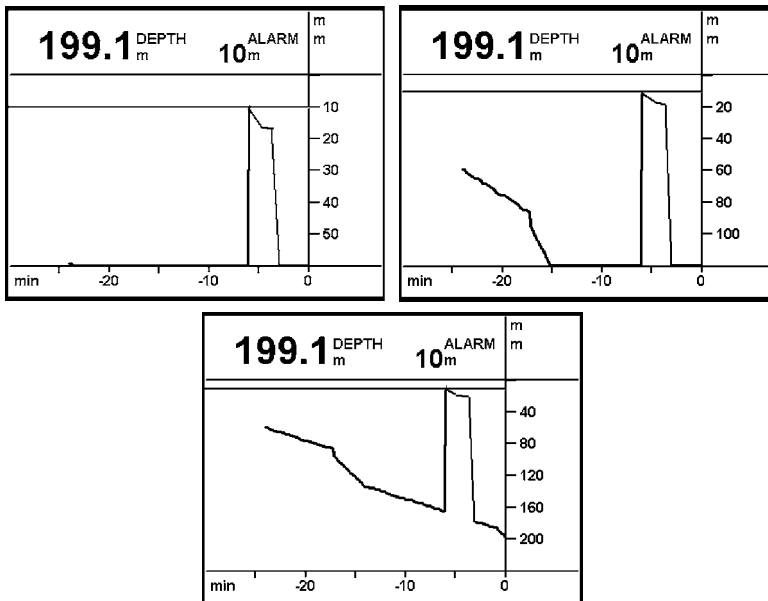

Fuel consumption information

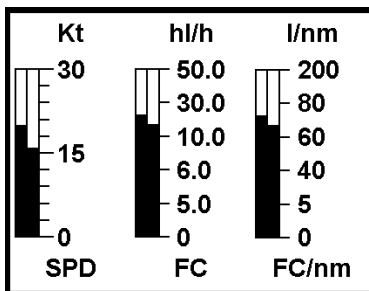

This is called Fuel consumption window. There are three vertical status bars and each bar has been divided into two sections where left side of bar is indicating fuel consumption as planned and right side is indication current situation. The bars are as follows:

- speed (Kt)
- fuel consumption (units per hour)
- fuel consumption (units per nautical mile)

Thrusters information

Two different examples of Thrusters window which can be displayed in Conning Display. The content of this window is defined in Thrusters1-4 of Installation parameters.

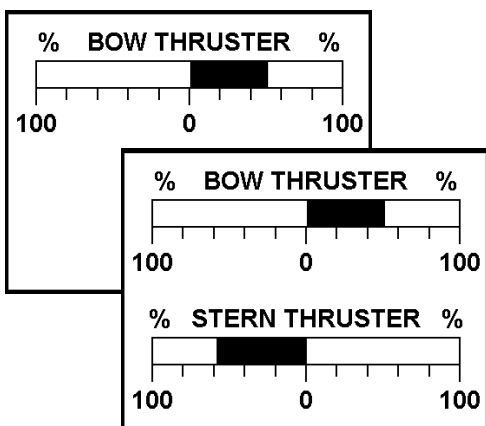

Propellers information

Three different examples of Propeller window which can be displayed in Conning Display. The content of this window is defined in Propellers1-4 of Installation parameters.

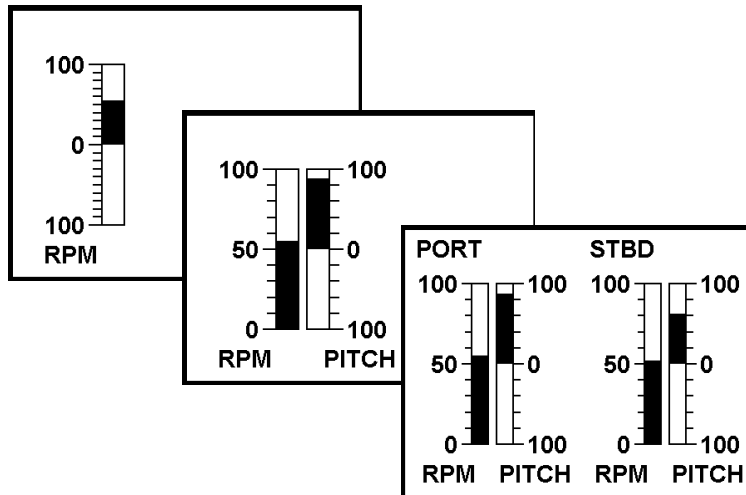

Azimuth propulsion

Two different examples of Azimuth propulsion window which can be displayed in Conning Display. The content of this window is defined in Propellers1-4 and Rudders of Installation parameters.

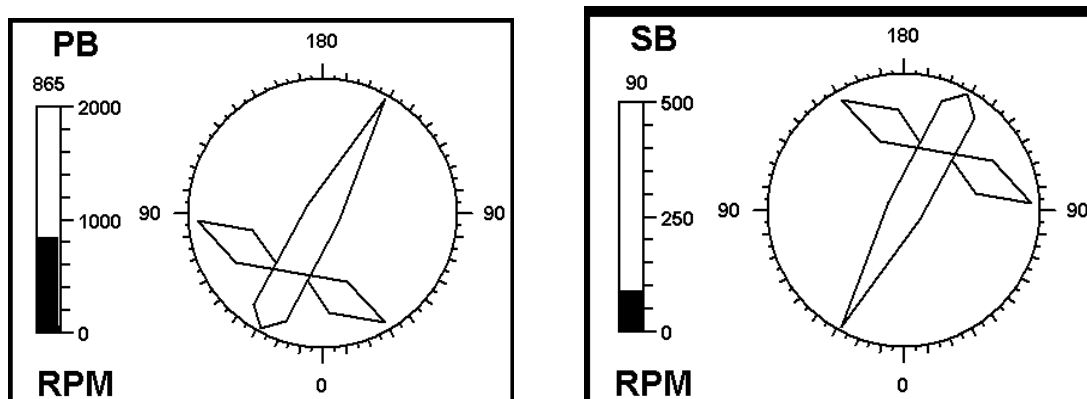

Speed Pilot Information

ROUTE		Timetable
PLAN LEG		10.0 Kt
SUGGESTED		10.5 Kt
SPEEDPILOT		PLAN
ACTUAL	POS	10.5 Kt
SET		Kt
PLAN	8.2	10.5 Kt

This is called Speed Pilot window. Following information is displayed in this window:

- **ROUTE**; Optimization type of Monitored route.
- **PLAN LEG**; planned speed for current leg (based on plan).
- **SUGGESTED**; If optimization type is timetable, then this indicates suggested speed to keep the timetable. For other optimization types this is empty.
- **SPEEDPILOT**; selected mode in Speed Pilot, alternatives are OFF, SET and PLAN.
- **ACTUAL**; speed and source of the speed used by Speed Pilot.
- **SET**; set position of handle and set speed of speedpilot during operation mode SET of the speedpilot. Empty during other operation modes
- **PLAN**; set position of handle and set speed of speedpilot during operation mode PLAN of the speedpilot. Empty during other operation modes.

ROUTE		Timetable
PLAN LEG		10.0 Kt
SUGGESTED		10.5 Kt
SPEEDPILOT		SET
ACTUAL	POS	10.5 Kt
SET	8.2	10.5 Kt
PLAN		Kt

ROUTE		Timetable
PLAN LEG		10.0 Kt
SUGGESTED		10.5 Kt
SPEEDPILOT		OFF
ACTUAL	POS	10.5 Kt
SET		Kt
PLAN		Kt

Last row is reserved for alarm indication. The speedpilot show in his own display alarms as ALnn, where nn is the number of alarm. Conning Display show the speedpilot alarm as self explanatory text.

Messages

14 RADAR SUPPLY FAILURE
16 WATER TIGHT DOORS
16 WATER TIGHT DOORS
18 STEERING GEAR ALARM
20 GMDSS ALARM
22 SPEED INFO MISSING

This is called Message window. If an optional Central Alarm unit is connected to the System it is possible to display current alarms of Central Alarm unit.

Main engine start air pressure information

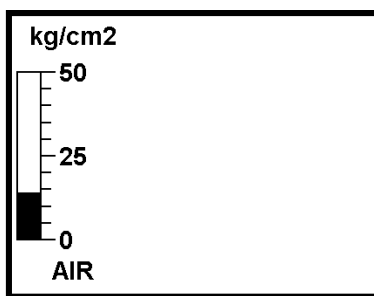

This is called Engine Start Air Pressure window.

Modes of Conning Display

Conning display is used to display collected data from different sensors and also data from ECDIS and Track Pilot processors. There are four different Conning display modes; Harbour 1 mode, Harbour 2 mode, Navigate 1 mode and Navigate 2 mode. These modes are predefined in Installation Parameters.

How to select mode of Conning Display

A mode selection of Conning Display is done using ECDIS Control Panel. There is a push button CONNING DISPLAY in Control Panel. Pressing this button open Conning Display window to the ECDIS display, where you can select desired mode to be displayed.

**CONNING
DISPLAY**

*CONNING DISPLAY push
button*

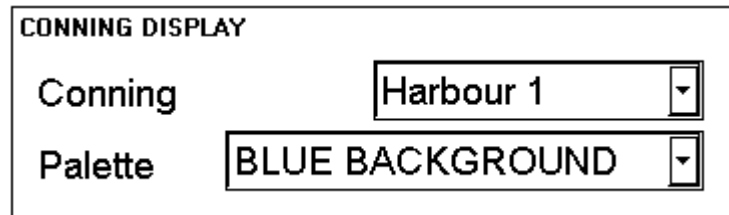

Select desired mode of Conning Display from the list box of Conning.

How to select background of Conning Display

A background selection of Conning Display is done using ECDIS Control Panel. There is a push button CONNING DISPLAY in Control Panel. Pressing this button open Conning Display window to the ECDIS display, where you can select desired background for Conning display. You can select between Blue and Black background.

**CONNING
DISPLAY**

*CONNING DISPLAY push
button*

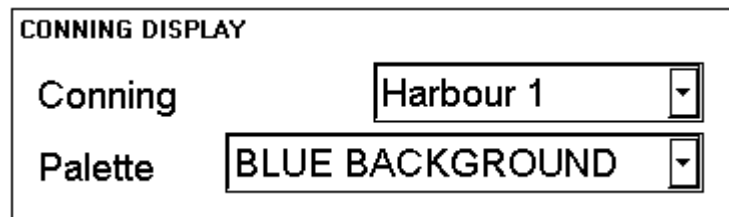

Select desired background of Conning Display from the list box of Palette.

How to change colour palette of Conning Display

The Conning Display is using the same colour palette as the ECDIS. When you change colour palette of the ECDIS you also change palette of Conning display.

1. Press CHART DISPLAY button.
2. Open **Chart** sheet in Chart Display window.
3. Select desired mode in a list box of Palette.

This page is intentionally left blank

Alarms

Overview

There are three kind of alarms generated by ECDIS or Track Pilot processors. To see list of alarms, see "List of alarms" on page 419.

Alarms generated by Navigation Calculation

Navigation Calculation generates following alarms:

- Error detected in any sensor
- Radar communication error
- Software alarms, etc.

The alarms are displayed on the ECDIS screen left corner of lower status bar. Press Alarm Ack pushbutton from the Control Panel to reset the alarm on the screen.

Lower status bar, when an alarm is generated by Navigation Calculation.

2009 Position Source Changed	30.08.2001 13:23 FLE Standard Time	SINGLE	1:20 000	02.03 02.03
------------------------------	------------------------------------	--------	----------	----------------

Alarms generated by Chart Calculation

Chart Calculation generates following alarms:

- new pilot data notebook page available
- Chart Alarms based on S57 charts
- Chart Alarms based on User Chart dangerous Symbols, Lines and Areas

The alarms are displayed on the ECDIS screen left corner of lower status bar. Press Alarm Ack pushbutton from the Control Panel to reset the alarm on the screen.

Lower status bar, when an alarm is generated by Chart Calculation.

5100 Safety Contour	30.08.2001 13:23 FLE Standard Time	SINGLE	1:20 000	02.03 02.03
---------------------	------------------------------------	--------	----------	----------------

Description of the alarm priority system

The permanently visible alarm in lower status bar is the top most i.e. latest most urgent alarm in any moment. Alarms has priority from 1 to 10 to control urgency. Priority 1 is highest. The list of alarms chapters show these priorities for each alarm with following syntax: "/1" in the end first row means priority = 1, "/1/8" in the end of first row means that priority is = 1, if unacknowledged and priority = 8, if acknowledged but the state of alarm still exist.

You have a possibility to view the alarms, which are in the queue. Move the cursor over the red alarm text in lower status bar and press INFO/HELP. This open Alarm queue window. See example below.

Mon.Route	Plan Route	Pilot Data	Depth metres	Height metres	TRUE MOTION
UserChart MK_18	Ref Target	ARPA 1 Radar	Non ENC Data	TM RESET OFF	X2.3
					59°51.538'N Gyro 219.1° 024°28.031'E COG 219.2° WGS 84 (pos) FILTER HIGH SOG 23.2 Kt
					Plan Speed 20.0Kt To WVP 3 Plan 216.9° Dist WOP 2.55 nm Route 216.8° Time 06:36 Ch limit 185m Next WVP 4 Off track <-32m Next 228.4° Turn rad 1.0 nm Turn rate 22°/min
					Alarm Queue 1 2001 No speed available 1 2009 Position source change 2 5100 Safety Contour 2 5103 User Chart Danger Area
					Projection Mercator Horizontal datum WGS 84 Vertical datum Sounding datum Approximate mean sea level Mean lower low water springs Quality of data Zone of confidence U Magnetic var.
					Cursor From Own Ship: 1.064 nm 200.8° 60°01.000N 024°59.098E
2001 No speed available		30.08.2001 13:23 FLE Standard Time		SINGLE	1:20 000 02.03 02.03

How to read alarm queue (first row as an example):

- first number "2" indicates alarm priority
- second number "5100" indicates alarm number
- text indicates reason of alarm "Safety contour"

First example show how alarm 2001 changes its priority from 1 to 8 after acknowledge. Then lower priority alarm 5100 is the most urgent out of the remaining alarms.

Second example show how alarm 5100 changes its priority to 10 after acknowledge. Then alarm 5103 is the most urgent out of the remaining alarms.

Alarm Queue
2 5100 Safety Contour
2 5103 User Chart Danger Area
8 2001 No speed available

Alarm Queue
2 5103 User Chart Danger Area
10 5100 Safety Contour

List of alarms

List of Navigation alarms

- Alarm number 1101: REFTGT: NO FILE SELECTED /7

USE 'REFERENCE TARGET' BUTTON TO
SELECT VALID REFEERENCE TARGET FILE
- Alarm number 1102: REFTGT: NEED 8 TARGETS /7

FILE MUST CONTAIN AT LEAST 8 TARGETS
IN ORDER TO UTILIZE REFERENCE
TARGETS USE 'REFERENCE TARGET'
BUTTON TO SELECT ANOTHER REF. TARGET
- Alarm number 1200: DEPTH BELOW LIMIT /5/13

ECHO SOUNDER INDICATES WATER DEPTH
BELOW TRANSDUCER TO EXCEED SPECIFIED
SAFE LIMIT.
- Alarm number 2000: FILTER: POSITION UNRELIABLE /1

ECDIS IS NOT ABLE TO ESTIMATE A
RELIABLE POSITION. VERIFY AND SELECT
SPEED AND POSITION SENSORS THROUGH
'SENSORS' FUNCTION .
- Alarm number 2001: NO SPEED AVAILABLE /1/8

NO VALID SPEED SENSOR HAS BEEN FOUND.
VERIFY AND SELECT SPEED SEN SORS IN
'SENSORS' BUTTON
- Alarm number 2002: NO HEADING AVAILABLE /1/8

NO VALID HEADING SENSOR HAS BEEN
FOUND. VERIFY AND SELECT HEADING
SENSORS IN 'SENSORS' FUNCTION.
- Alarm number 2004: GYRO DATA UNRELIABLE /1/8

IF YOU HAVE BOTH GYRO1 AND GYRO2
SELECTED AND IF THEY VALUE DIFFERS
MORE THAN 5 DEGREES ALARM IS
GENERATED. VERIFY AND SELECT HEADING
SENSORS IN 'SENSORS' FUNCTION.
- Alarm number 2005: LOG DATA UNRELIABLE /1/8

LOG GIVES 0 KN SPEED, WHICH DOES NOT
CORRESPOND WITH OTHER SPEED SENSORS.
VERIFY AND SELECT SPEED SENSORS IN
'SENSORS' FUNCTION.
- Alarm number 2006: ROUTE:COURSE JUMP POSSIBLE /1

SYSTEM HAS AUTOMATICALLY CHANGED TO
DEAD RECKONING. IF YOU NOW SELECT
"ON" A POSITION SENSOR YOU MAY GET A
JUMP FOR COURSE. CHANGE FROM ROUTE
STEERING TO MANUAL STEERING OR CHECK
POSITION VERY CAREFULLY BEFORE
SELECTING "ON".

Alarm number 2007: POSITION DISCREPANCY /2/9

SYSTEM HAS DETECTED MORE DIFFERENCE
THAN SET LIMIT BETWEEN OWN SHIP
PRIMARY AND SECONDARY POSITIONS OR
BETWEEN OWN SHIP AND ANY SENSOR
POSITION. CHECK POSITION SENSORS

Alarm number 2008: FILTER: SPEED BELOW xx KN /1/8

KALMAN FILTER REQUIRED THAT THE
SPEED OF THE OWN SHIP IS MORE THAN
SPEED LIMIT SET IN ECDIS
INSTALLATION PARAMETERS. IF ROUTE
STEERING WAS NOT USED, THEN KALMAN
FILTER HAS BEEN SET AUTOMATICALLY
OFF BY THE SYSTEM.

Alarm number 2009: POSITION SOURCE CHANGED /1

POSITION SOURCE OF OWN SHIP PRIMARY
POSITION HAS BEEN CHANGED
AUTOMATICALLY TO ANOTHER SOURCE THAN
BEFORE. VERIFY NEW SOURCE.

Alarm number 2010: FILTER:POS SOURCE CHANGE /2

DGPS POSITION SENSOR USED IN FILTER
POSITIONING HAS CHANGED ITS
OPERATION MODE FROM NORMAL TO
DIFFERENTIAL OR FROM DIFFERENTIAL TO
NORMAL

Alarm number 2011: CHARTALING:OVER 30 MINUTES /2

IF POSITION ALIGNMENT IS USED THEN
USER IS REMINDED OF IT EVERY 30 MIN.

Alarm number 2013: SOG&COG DATA UNRELIABLE /1/8
SOG AND/OR COG DATA FROM SENSORS IS
UNRELIABLE. VERIFY AND SELECT
SPEED/COURSE AND POS SENSORS IN
'SENSORS' FUNCTION. IF REASON IS
FAST MANOEUVRE, LIMIT CAN BE
INCREASED BY SETTING "MAX RATE OF
TURN" LIMIT OVER 150 DEG/MIN.

Alarm number 2052: ROUTE:ILLEGAL ETA WAYPOINT /7

ETA WAYPOINT DOESN'T EXIST IN ROUTE
FILE OR ETA WAYPOINT IS NOT BETWEEN
NEXT AND FINAL WAYPOINT.
VERIFY IN 'ROUTE MONITOR' THAT A
VALID ROUTE IS SELECTED.

Alarm number 2053: ROUTE:ILLEGAL NEXT WAYPOINT /7

NEXT WAYPOINT DOESN'T EXIST IN ROUTE
FILE. VERIFY IN 'ROUTE MONITOR'
THAT A VALID ROUTE IS SELECTED.

Alarm number 2054: ROUTE:ILLEGAL FINAL WAYPOINT /7

FINAL WAYPOINT DOES NOT EXIST IN
ROUTE FILE. VERIFY IN 'ROUTE MONI-
TOR' THAT A VALID ROUTE IS SELECTED.

Alarm number 2055: ARPA RADAR COMMUNICATION ERROR /3/10

ECDIS CANNOT COMMUNICATE WITH ARPA 1
VERIFY THAT
'AUTOTRACKING ON' AND 'INS ON' ARE
DEPRESSED ON THE ARPA RADARS.

Alarm number 2056: ARPA RADAR COMMUNICATION ERROR /3/10

ECDIS CANNOT COMMUNICATE WITH ARPA 2
VERIFY THAT
'AUTOTRACKING ON' AND 'INS ON' ARE
DEPRESSED ON THE ARPA RADARS.

Alarm number 2057: ARPA RADAR COMMUNICATION ERROR /3/10

ECDIS CANNOT COMMUNICATE WITH ARPA 3
VERIFY THAT
'AUTOTRACKING ON' AND 'INS ON' ARE
DEPRESSED ON THE ARPA RADARS.

Alarm number 2058: ARPA RADAR COMMUNICATION ERROR /3/10

ECDIS CANNOT COMMUNICATE WITH ARPA 4
VERIFY THAT
'AUTOTRACKING ON' AND 'INS ON' ARE
DEPRESSED ON THE ARPA RADARS.

Alarm number 2060: ROUTE: WP CHANGE DISABLED /7

NEXT WAYPOINT CANNOT BE CHANGED
DURING ROUTE STEERING. CHANGE FROM
ROUTE STEERING MODE BEFORE SELECTING
A NEW NEXT WAYPOINT.

Alarm number 2061: CHART ALIGN: EXECUTING /7

IF CHART ALIGNMENT IS DONE BY MEANS
OF SELESMAR ARPA RADAR, ALARM IS
DISPLAYED WHEN YOU DEFINE ALIGNMENT.

Alarm number 2063: ROUTE:SELECT DISABLED /7

A NEW ROUTE CANNOT BE SELECTED DURING
ROUTE STEERING. USE 'RADIUS CONTROL'
TO OVERRIDE ROUTE STEERING BEFORE
SELECTING A NEW ROUTE.

Alarm number 2064: ROUTE:CANCEL DISABLED /7

A ROUTE CANNOT BE CANCELED DURING
ROUTE STEERING. USE 'RADIUS CONTROL'
TO OVERRIDE ROUTE STEERING BEFORE
CANCELING THE ROUTE.

Alarm number 2067: MANUAL DRIFT DISABLED /7

MANUAL DRIFT VALUE CAN ONLY BE
INSERTED WHEN NO SENSORS PROVIDE
SPEED OVER GROUND DATA.
USE 'SENSORS' BUTTON TO VERIFY
AND SELECT SENSORS TO BE USED.

Alarm number 2071: SOURCE ARPA RADAR CHANGED /1

MASTER RADAR FOR ECDIS HAS BEEN
CHANGED. VERIFY NEW SOURCE OR
TRACKED ARPA TARGETS

Alarm number 2072: CHARTALIGN: NO LINE AVAIL /1

TO PERFORM CHART ALIGN WITH AN ARPA
RADAR THERE MUST BE TRANSFERRED USER
CHART'S LINES IN THE ARPA RADAR.
CHECK THAT YOUR CURRENT USER CHART
HAS LINES AND THAT THEY ARE VISIBLE
ON ARPA RADAR DISPLAY

Alarm number 2101: USER CHART: NEED POINTS /7

USER CHART HAS MORE THAN 60 LINES OR
20 SYMBOLS AND IT DOES NOT CONTAIN
ANY POINTS. USE 'USER CHART' MENU
TO SELECT A VALID USER CHART OR ADD
POINTS TO CURRENT USER CHART

Alarm number 2351: REFTGT: FORCED TO CANCEL /1

YOU HAVE SELECTED NEW REFERENCE
TARGETS WITHOUT FIRST CANCEL OF
CURRENT ONE. THE USE OF CURRENT
REFERENCE TARGETS HAS BEEN
AUTOMATICALLY CANCELLED

Alarm number 2352: REFTGT: LOST POSITION /1

YOU HAVE SELECTED REFERENCE TARGETS
AS A POSITION SOURCE AND THE SYSTEM
IS UNABLE TO SOLVE OWN SHIP POSITION
BASED ON REFERENCE TARGETS
CHECK YOUR REFERENCE TARGET
POSITIONS AND THEIR TRACKING

Alarm number 2353: REFTGT: LOST GYRO CORR. /2

LOST OF GYRO ERROR CORRECTION VALUE
WHICH IS BASED ON REFERENCE TARGETS
TRACKING

Alarm number 2354: REFTGT: TRACKING FULL /1

IF CONNECTED ARPA RADAR HAS LESS
THAN 8 FREE TRACKING CHANNELS AVAIL.

Alarm number 2454: ROUTE: END REACHED /1

YOU HAVE PASSED THE FINAL WAYPOINT
OF YOUR MONITORED ROUTE. CURRENT
MONITORED ROUTE HAS AUTOMATICALLY
CANCELLED

Alarm number 2457: ROUTE: OUTSIDE CHANNEL LIMITS /3/10

SHIP IS OUTSIDE CHANNEL LIMITS
SPECIFIED FOR CURRENT LEG OF ROUTE.
CHECK SHIP POSITION AND ROUTE

Alarm number 2459: STEERING PARAMETER ERROR /7

TRACKPILOT PARAMETER HAS AN ERROR IN
ITS CONTENTS. CHECK AGAIN
INSTALLATION PARAMETERS OF ECDIS.

Alarm number 3000: PARAM CHANGE DISABLED /3

INSTALLATION PARAMETERS CAN BE
CHANGED ONLY IF THE ROUTE STEERING
IS NOT ON AND THE KALMAN FILTER IS
NOT USED.
CHECK THE SITUATION AND TRY AGAIN.

Alarm number 3300: SENSOR DATAFLOW ERROR /1

ECDIS HAS INTERNAL SENSOR MANAGEMENT
ERROR ALL CONNECTION TO SENSOR DATA
IS LOST

Alarm number 3500: AIS TARGET OVERFLOW /2/9

WARNS THAT MAXIMUM COUNT OF AIS
TARGETS SET TO BE DISPLAYED ON ECDIS
HAS BEEN EXCEEDED WITHIN DEFINED
MAXIMUM RANGE. IT IS POSSIBLE THAT
SOME OF AIS TARGETS ARE NOT
DISPLAYED ON ECDIS. TO GET ALL AIS
TARGETS TO BE DISPLAYED, INCREASE
MAXIMUM COUNT OF AIS TARGETS OR
DECREASE VALUE OF MAXIMUM RANGE.

Alarm number 3501: AIS TARGET STORAGE FULL /2/9

WARNS THAT MAXIMUM COUNT OF AIS
TARGETS WHICH CAN BE STORED FOR
DISPLAYING ON ECDIS HAS BEEN
EXCEEDED. IT IS POSSIBLE THAT SOME
OF AIS TARGETS ARE NOT DISPLAYED ON
ECDIS.

Alarm number 3502: DANGEROUS AIS TARGET /3/10

WARNS THAT AIS TARGET HAS MET
DANGEROUS TARGET LIMIT SET BY CPA
AND TCA

Alarm number 3503: LOST AIS TARGET /3

NO UPDATE INFORMATION RECEIVED FROM
TRACKED AIS TARGET WITHIN DEFINED
REPORTING INTERVAL OF VESSEL TYPE

Alarm number 4000: NO SENSOR PARAMETERS /2

SENSOR PARAMETER FILES ARE MISSING.
LOAD INSTALLATION PARAMETERS OF
ECDIS. IF REQUIRED USE BACKUP COPY
OF PARAMETERS.

Alarm number 4001: B-ADAPTER ERROR /4/11

B-ADAPTER DOES NOT OPERATE DUE TO A
SYSTEM FAULT. SWITCH OFF MAIN
CIRCUIT BREAKER AND THEN ON AGAIN.
CALL SERVICE IF FAILURE STILL EXISTS

Alarm number 4002: ENGINE CONTROL COMM ERROR /6/13

CONNECTION TO ENGINE CONTROL HAS
BEEN LOST. CHECK THAT CONNECTION IS
OK.

Alarm number 4005: GYRO ERROR /3/10

 GYRO1 DATA IS NOT RECEIVED CORRECTLY
 USE 'INITIAL SETTINGS' MENU TO SET
 GYRO AGAIN. IF FAILURE STILL
 EXISTS, USE 'SENSORS' SPEED/POSITION
 PAGE TO SELECT VALID SENSORS.

Alarm number 4006: GYRO ERROR /3/10

 GYRO2 DATA IS NOT RECEIVED CORRECTLY
 USE 'SENSORS' SPEED/POSITION PAGE TO
 SELECT VALID SENSORS.

Alarm number 4008: LOG ERROR /3/10

 LOG DATA IS NOT RECEIVED CORRECTLY.
 USE 'SENSORS' SPEED/COURSE
 TO SELECT VALID SENSORS

Alarm number 4008: DUAL AXIS LOG (WT) ERROR /3/10

 DUAL AXIS LOG DATA IS NOT RECEIVED
 CORRECTLY. USE SPEED/COURSE PAGE
 TO SELECT VALID SPEED SENSORS.

Alarm number 4009: DUAL AXIS LOG (BT) ERROR /3/10

 DUAL AXIS LOG DATA IS NOT RECEIVED
 CORRECTLY. USE SPEED/COURSE PAGE
 TO SELECT VALID SPEED SENSORS.

Alarm number 4010: ECHO SOUNDER ERROR /3/10

 ECHO SOUNDER DATA IS NOT RECEIVED
 CORRECTLY.
 VERIFY ECHO SOUNDER OPERATION.

Alarm number 4011: WIND SENSOR ERROR /3/10

 WIND SENSOR DATA IS NOT RE CEIVED
 CORRECTLY.
 VERIFY WIND SENSOR OPERATION.

Alarm number 4012: POSITION EQUIPMENT ERROR /3/10

 POSITION EQUIPMENT 1 DATA IS NOT
 RECEIVED CORRECTLY. USE 'SENSORS'
 POSITION TO SELECT VALID POS SENSOR.

Alarm number 4013: POSITION EQUIPMENT ERROR /3/10

 POSITION EQUIPMENT 2 DATA IS NOT
 RECEIVED CORRECTLY. USE 'SENSORS'
 POSITION TO SELECT VALID POS SENSOR.

Alarm number 4014: POSITION EQUIPMENT ERROR /3/10

 POSITION EQUIPMENT 3 DATA IS NOT
 RECEIVED CORRECTLY. USE 'SENSORS'
 POSITION TO SELECT VALID POS SENSOR.

Alarm number 4015: POSITION EQUIPMENT ERROR /3/10

 POSITION EQUIPMENT 4 DATA IS NOT
 RECEIVED CORRECTLY. USE 'SENSORS'
 POSITION TO SELECT VALID POS SENSOR.

Alarm number 4016: POSITION EQUIPMENT ERROR /3/10

POSITION EQUIPMENT 5 DATA IS NOT RECEIVED CORRECTLY. USE 'SENSORS' POSITION TO SELECT VALID POS SENSOR.

Alarm number 4018: ROT GYRO ERROR /3/10

ROT GYRO DATA IS NOT RECEIVED CORRECTLY. VERIFY ROT GYRO DEVICE.

Alarm number 4019: PITCH&ROLL SENSOR ERROR 3/10

PITCH&ROLL DATA IS NOT RECEIVED CORRECTLY. VERIFY SENSOR FOR PITCH&ROLL DATA.

Alarm number 4021: ARPA RADAR SYSTEM ERROR /6/13

RADAR FROM CHANNEL 1 REPORT RADAR SYSTEM FAILURE OR ECDIS CANNOT COMMUNICATE WITH THE RADAR. VERIFY THAT 'AUTOTRACKING ON' AND 'INC ON' ARE DEPRESSED ON THE RADAR.

Alarm number 4022: ARPA RADAR SYSTEM ERROR /6/13

RADAR FROM CHANNEL 2 REPORT RADAR SYSTEM FAILURE OR ECDIS CANNOT COMMUNICATE WITH THE RADAR. VERIFY THAT 'AUTOTRACKING ON' AND 'INC ON' ARE DEPRESSED ON THE RADAR.

Alarm number 4023: ARPA RADAR SYSTEM ERROR /6/13

RADAR FROM CHANNEL 3 REPORT RADAR SYSTEM FAILURE OR ECDIS CANNOT COMMUNICATE WITH THE RADAR. VERIFY THAT 'AUTOTRACKING ON' AND 'INC ON' ARE DEPRESSED ON THE RADAR.

Alarm number 4024: ARPA RADAR SYSTEM ERROR /6/13

RADAR FROM CHANNEL 1 REPORT RADAR SYSTEM FAILURE OR ECDIS CANNOT COMMUNICATE WITH THE RADAR. VERIFY THAT 'AUTOTRACKING ON' AND 'INC ON' ARE DEPRESSED ON THE RADAR.

Alarm number 4027: DGPS POS. SOURCE CHANGE /3/10

DGPS POSITION SENSOR IN CHANNEL NUMBER 1 HAS CHANGED ITS OPERATION MODE FROM NORMAL TO DIFFERENTIAL OR FROM DIFFERENTIAL TO NORMAL. CHECK SENSORS AND IF REQUIRED SELECT MORE SUITABLE POSITION SENSOR.

Alarm number 4028: DGPS POS. SOURCE CHANGE /3/10

DGPS POSITION SENSOR IN CHANNEL NUMBER 2 HAS CHANGED ITS OPERATION MODE FROM NORMAL TO DIFFERENTIAL OR FROM DIFFERENTIAL TO NORMAL. CHECK SENSORS AND IF REQUIRED SELECT MORE SUITABLE POSITION SENSOR.

Alarm number 4029: DGPS POS. SOURCE CHANGE /3/10

DGPS POSITION SENSOR IN CHANNEL
NUMBER 3 HAS CHANGED ITS OPERATION
MODE FROM NORMAL TO DIFFERENTIAL OR
FROM DIFFERENTIAL TO NORMAL. CHECK
SENSORS AND IF REQUIRED SELECT MORE
SUITABLE POSITION SENSOR.

Alarm number 4030: DGPS POS. SOURCE CHANGE /3/10

DGPS POSITION SENSOR IN CHANNEL
NUMBER 4 HAS CHANGED ITS OPERATION
MODE FROM NORMAL TO DIFFERENTIAL OR
FROM DIFFERENTIAL TO NORMAL. CHECK
SENSORS AND IF REQUIRED SELECT MORE
SUITABLE POSITION SENSOR.

Alarm number 4031: DGPS POS. SOURCE CHANGE /3/10

DGPS POSITION SENSOR IN CHANNEL
NUMBER 5 HAS CHANGED ITS OPERATION
MODE FROM NORMAL TO DIFFERENTIAL OR
FROM DIFFERENTIAL TO NORMAL. CHECK
SENSORS AND IF REQUIRED SELECT MORE
SUITABLE POSITION SENSOR.

Alarm number 4033: ARPA RADAR SPD/CRS ERROR /3/10

ARPA RADAR SELECTED AS SPD AND CRS
SOURCE IS NOT RECEIVED CORRECTLY
USE 'SENSORS' SPEED/COURSE TO SELECT
VALID SPD/CRS SENSORS

Alarm number 4034: SPEEDPILOT RECEIVE ERROR /3/10

DATA FROM SPEEDPILOT IS NOT RECEIVED
CORRECTLY. CHECK CONNECTION OF
SPEEDPILOT.

Alarm number 4035: B-ADAPTER INTERFACE ERROR /1/8

B-ADAPTER DATA IS NOT RECEIVED
CORRECTLY DUE TO INTERNAL SOFTWARE
ERROR IN COMMUNICATION PROGRAM.
TO RESTART COMMUNICATION PROGRAM,
OPEN INSTALLATION PARAMETERS OF
ECDIS AND PRESS OK WITHOUT CHANGING
ANY PARAMETERS. OR RESTART ECDIS.

Alarm number 4036: AMWSS COMM ERROR /6/13

COMMUNICATION WITH AMWSS FAILS.
CHECK CONNECTION TO AMWSS

Alarm number 4037: AIS RECEIVE ERROR /6/13

DATA FROM AMWSS IS NOT RECEIVED
CORRECTLY. CHECK CONNECTION TO
AMWSS

Alarm number 4038: DATUM MISMATCH /3/10

POSITION SENSOR IN CHANNEL NUMBER 1
OUTPUTS POSITION ANOTHER DATUM AS
SET IN ECDIS INSTALLATION PARAMETERS
CHECK, THAT SENSOR OUTPUTS POSITION
IN WGS 84 DATUM.

Alarm number 4039: DATUM MISMATCH /3/10

POSITION SENSOR IN CHANNEL NUMBER 2
OUTPUTS POSITION ANOTHER DATUM AS
SET IN ECDIS INSTALLATION PARAMETERS
CHECK, THAT SENSOR OUTPUTS POSITION
IN WGS 84 DATUM.

Alarm number 4040: DATUM MISMATCH /3/10

POSITION SENSOR IN CHANNEL NUMBER 3
OUTPUTS POSITION ANOTHER DATUM AS
SET IN ECDIS INSTALLATION PARAMETERS
CHECK, THAT SENSOR OUTPUTS POSITION
IN WGS 84 DATUM.

Alarm number 4041: DATUM MISMATCH /3/10

POSITION SENSOR IN CHANNEL NUMBER 4
OUTPUTS POSITION ANOTHER DATUM AS
SET IN ECDIS INSTALLATION PARAMETERS
CHECK, THAT SENSOR OUTPUTS POSITION
IN WGS 84 DATUM.

Alarm number 4042: DATUM MISMATCH /3/10

POSITION SENSOR IN CHANNEL NUMBER 5
OUTPUTS POSITION ANOTHER DATUM AS
SET IN ECDIS INSTALLATION PARAMETERS
CHECK, THAT SENSOR OUTPUTS POSITION
IN WGS 84 DATUM.

Alarm number 4044: DATUM CHANGE /1

POSITION SENSOR IN CHANNEL NUMBER 1
HAS CHANGED OUTPUT POSITION FROM
ANOTHER DATUM TO WGS 84 DATUM.

Alarm number 4045: DATUM CHANGE /3

POSITION SENSOR IN CHANNEL NUMBER 2
HAS CHANGED OUTPUT POSITION FROM
ANOTHER DATUM TO WGS 84 DATUM.

Alarm number 4046: DATUM CHANGE /3

POSITION SENSOR IN CHANNEL NUMBER 3
HAS CHANGED OUTPUT POSITION FROM
ANOTHER DATUM TO WGS 84 DATUM.

Alarm number 4047: DATUM CHANGE /3

POSITION SENSOR IN CHANNEL NUMBER 4
HAS CHANGED OUTPUT POSITION FROM
ANOTHER DATUM TO WGS 84 DATUM.

Alarm number 4048: DATUM CHANGE /3

POSITION SENSOR IN CHANNEL NUMBER 5
HAS CHANGED OUTPUT POSITION FROM
ANOTHER DATUM TO WGS 84 DATUM.

Alarm number 4050: ARPA ANTENNA ID ERROR /6/13

ECDIS CANNOT RECEIVE ANTENNA ID
FROM RADAR IN CHANNEL 1

Alarm number 4051: ARPA ANTENNA ID ERROR /6/13

ECDIS CANNOT RECEIVE ANTENNA ID
FROM RADAR IN CHANNEL 2

Alarm number 4052: ARPA ANTENNA ID ERROR /6/13

ECDIS CANNOT RECEIVE ANTENNA ID
FROM RADAR IN CHANNEL 3

Alarm number 4053: ARPA ANTENNA ID ERROR /6/13

ECDIS CANNOT RECEIVE ANTENNA ID
FROM RADAR IN CHANNEL 4

Alarm number 4201: EXT. NAVIGATION EQ. ERROR /6

NAVIGATION EQUIPMENT CONNECTED IN
ALARM INPUT 1 HAS INTERNAL FAILURE

Alarm number 4202: EXT. NAVIGATION EQ. ERROR /6

NAVIGATION EQUIPMENT CONNECTED IN
ALARM INPUT 2 HAS INTERNAL FAILURE

Alarm number 4203: EXT. NAVIGATION EQ. ERROR /6

NAVIGATION EQUIPMENT CONNECTED IN
ALARM INPUT 3 HAS INTERNAL FAILURE

Alarm number 4204: EXT. NAVIGATION EQ. ERROR /6

NAVIGATION EQUIPMENT CONNECTED IN
ALARM INPUT 4 HAS INTERNAL FAILURE

Alarm number 4205: EXT. NAVIGATION EQ. ERROR /6

NAVIGATION EQUIPMENT CONNECTED IN
ALARM INPUT 5 HAS INTERNAL FAILURE

Alarm number 4206: EXT. NAVIGATION EQ. ERROR /6

NAVIGATION EQUIPMENT CONNECTED IN
ALARM INPUT 6 HAS INTERNAL FAILURE

Alarm number 4207: EXT. NAVIGATION EQ. ERROR /6

NAVIGATION EQUIPMENT CONNECTED IN
ALARM INPUT 7 HAS INTERNAL FAILURE

Alarm number 4208: EXT. NAVIGATION EQ. ERROR /6

NAVIGATION EQUIPMENT CONNECTED IN
ALARM INPUT 8 HAS INTERNAL FAILURE

List of Chart alarms

Alarm number	5001:	NEW PILOT DATA	/2/10
Alarm number	5100:	SAFETY CONTOUR	/2/10
Alarm number	5101:	AREAS TO BE AVOIDED	/2/10
Alarm number	5102:	SPECIALLY PROTECTED AREAS	/2/10
Alarm number	5103:	USER CHART DANGER AREA	/2/10
Alarm number	5104:	TRAFFIC SEPARATION ZONE	/2/10
Alarm number	5105:	TRS CROSSING/ROUNDBOUT	/2/10
Alarm number	5106:	TRS PRECAUTIONARY AREA	/2/10
Alarm number	5107:	TWO WAY TRAFFIC ROUTE	/2/10
Alarm number	5108:	DEEP WATER ROUTE	/2/10
Alarm number	5109:	RECOMMEND TRAFFIC LANE	/2/10
Alarm number	5110:	INSHORE TRAFFIC ZONE	/2/10
Alarm number	5111:	FAIRWAY	/2/10
Alarm number	5112:	RESTRICTED AREA	/2/10
Alarm number	5113:	CAUTION AREA	/2/10
Alarm number	5114:	OFFSHORE PRODUCTION AREA	/2/10
Alarm number	5115:	MILITARY PRACTICE AREA	/2/10
Alarm number	5116:	SEAPLANE LANDING AREA	/2/10
Alarm number	5117:	SUBMARINE TRANSIT LANE	/2/10
Alarm number	5118:	ICE AREA	/2/10
Alarm number	5119:	CHANNEL	/2/10
Alarm number	5120:	FISHING GROUND	/2/10
Alarm number	5121:	FISHING PROHIBITED	/2/10
Alarm number	5122:	PIPELINE AREA	/2/10
Alarm number	5123:	CABLE AREA	/2/10
Alarm number	5124:	ANCHORAGE AREA	/2/10
Alarm number	5125:	ANCHORAGE PROHIBITED	/2/10
Alarm number	5126:	DUMPING GROUND	/2/10
Alarm number	5127:	SPOIL GROUND	/2/10
Alarm number	5128:	DREDGED AREA	/2/10
Alarm number	5129:	CARGO TRANSSHIPMENT AREA	/2/10
Alarm number	5130:	INCINERATION AREA	/2/10

This page is intentionally left blank

Definition of Terms

List of terms

APPROACHING POINT (AP)

A user selected point where a turning alarm is initiated.

AUTOMATIC RADAR PLOTTING AID (ARPA)

A system wherein radar targets are automatically acquired, tracked and collision situations computer assessed and warning given.

CHANNEL LIMIT (CHL)

During route planning a channel limit is defined for each leg. This limit can also be the border line of the chart shown on the radar display. "For more information, see "Figure 1" on page 434.

COURSE

Course is the horizontal direction in which a craft is steered or intended to be steered, expressed as angular distance from north, usually from 000° at north, clockwise through 360°. Strictly, course applies to direction through the water, not the direction intended to be made good over the ground.

COURSE OVER GROUND (COG)

The direction of the path over ground actually followed by a craft. For more information, see "Figure 1" on page 434.

CLOSEST POINT OF APPROACH (CPA)

A user can set CPA limit.

DATUM

A set of parameters specifying the reference surface or the reference co-ordinate systems used for geodetic control in the calculation of co-ordinates of points on the earth. Commonly datum is defined as horizontal and vertical datum separately. For the practical use of the datum it is necessary to have one or more well monument points with co-ordinates given in that datum.

ELECTRONIC CHART DISPLAY AND INFORMATION SYSTEM (ECDIS)

The navigation information system which is considered equivalent to the nautical paper chart, displaying selected information from the chart data base (see ENC) integrated with data from positional and, optionally other sensors. By displaying chart contents and optionally other chart related and navigational information, ECDIS assists the mariner in route planning and, with on-line position indication, in route monitoring.

ELECTRONIC NAVIGATIONAL CHART (ENC)

The database held on the ship for use with ECDIS. The ENC is equivalent to new editions of paper charts, and may contain additional supplementary nautical information additional to that contained in the paper chart.

FORWARDING DISTANCE (F)

The distance which the vessel moves straight after a rudder command. "For more information, see "Figure 2" on page 434.

"FROM WP"

The last passed waypoint. For more information, see "Figure 1" on page 434.

HEADING (HDG)

The horizontal direction in which the longitudinal axis of a ship actually points or heads at any instant, expressed as angular units from a reference direction, usually from 000° at the reference direction, clockwise through 360° (true, magnetic or compass heading). For more information, see "Figure 1" on page 434.

GREAT CIRCLE

The intersection of the surface of a sphere and a plane through its center.

MAGNETIC VARIATION

The angle between the magnetic and geographic meridians at any place, expressed in degrees and minutes east or west to indicate the direction of magnetic north from true north.

MENU

A list of commands and/or options. The user selects the desired command by moving the cursor to the respective position on the menu.

"NEXT WP"

The waypoint after "TO WP"

OFF TRACK

Cross track error (XTE) distance from intended track. For more information, see "Figure 1" on page 434.

PLAN

The direction "From WP" to "To WP", a constant course on a rhumb line track and a varying course on a Great Circle track. For more information, see "Figure 1" on page 434.

POSITION

On the display is indicated which instruments are giving information for the position calculation.

RENC

Regional Electronic Nautical Chart center. RENC is defined by IMO and IHO as the source of SOLAS compliant Electronic Nautical Charts (ENC), which use S57ed3 coding. An example of such a RENC is the PRIMAR in Stavanger Norway.

RANGE RING

A range ring is a circle with a defined radius located with its centre at the position of the own ship.

RHUMB LINE

A line on the surface of the earth making the same oblique angle with all meridians. A rhumb line is a straight line on a rhumb (or Mercator) projection.

ROUTE

System has internal algorithm to calculate a course to eliminate Off track. For more information, see "Figure 1" on page 434.

SYSTEM ENC (SENC)

The manufacturer's own storage formats or data structure for the database.

SPEED OVER GROUND (SOG)

The speed of a craft along the actual path of travel over the ground. For more information, see "Figure 1" on page 434.

"TO WP"

The waypoint which the ship is approaching. For more information, see "Figure 1" on page 434.

VARIABLE RANGE MARKER (VRM)

The VRM is a range ring, the radius of which is continuously adjustable.

WAYPOINT (WP)

The crossing point between two legs.

WHEEL OVER POINT (WOP)

The point where the rudder command is given. "For more information, see "Figure 2" on page 434.

WORLD GEODETIC SYSTEM (WGS)

A consistent set of parameters describing the size and shape of the earth, the positions of a network of points with respect to the center of mass of the Earth, transformations from major geodetic datum's, and the potential of the Earth.

Figure 1

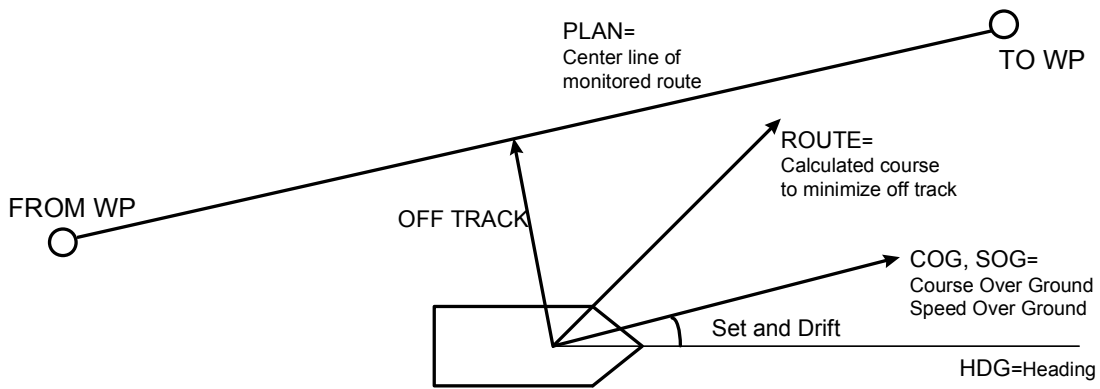

Figure 1

Figure 2

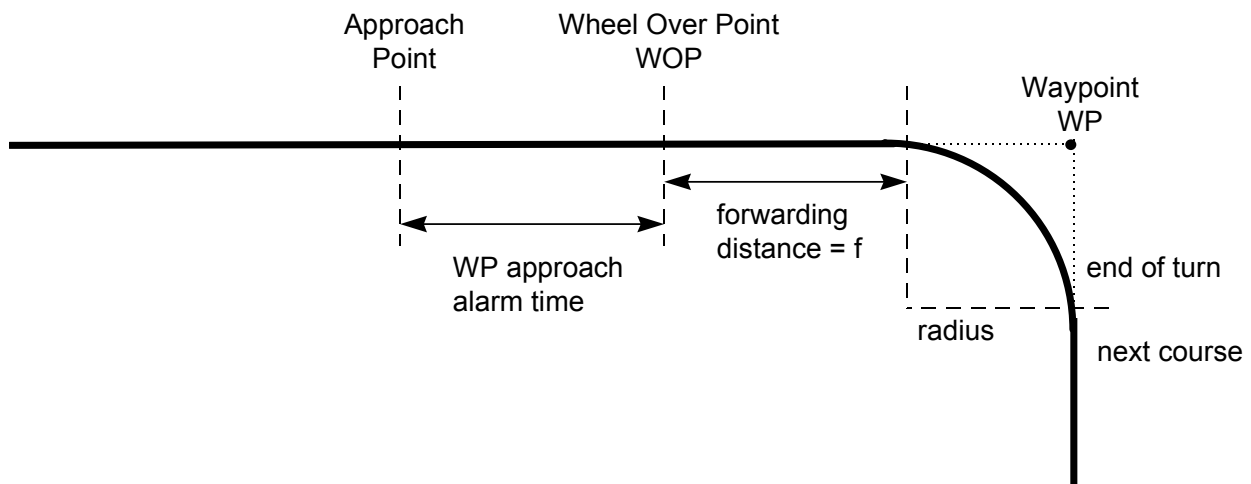

Figure 2

Appendix 1

IHO ECDIS chart 1

International Hydrographic Organization (IHO) has published a set of charts, where you can find examples of used symbology in S57. You can study them with "Info/Help" and by changing different layer ON and OFF in "Chart Display". Everything is visible if you select all layers from "Standard" and "Other" sheets ON.

To open IHO ECDIS Chart 1 on display, press CHART PLAN button and select **IHO ECDIS Chart 1**.

Note that chart AA5C1WOO is intended to help you to select suitable monitor brightness and contrast for current lightning condition.

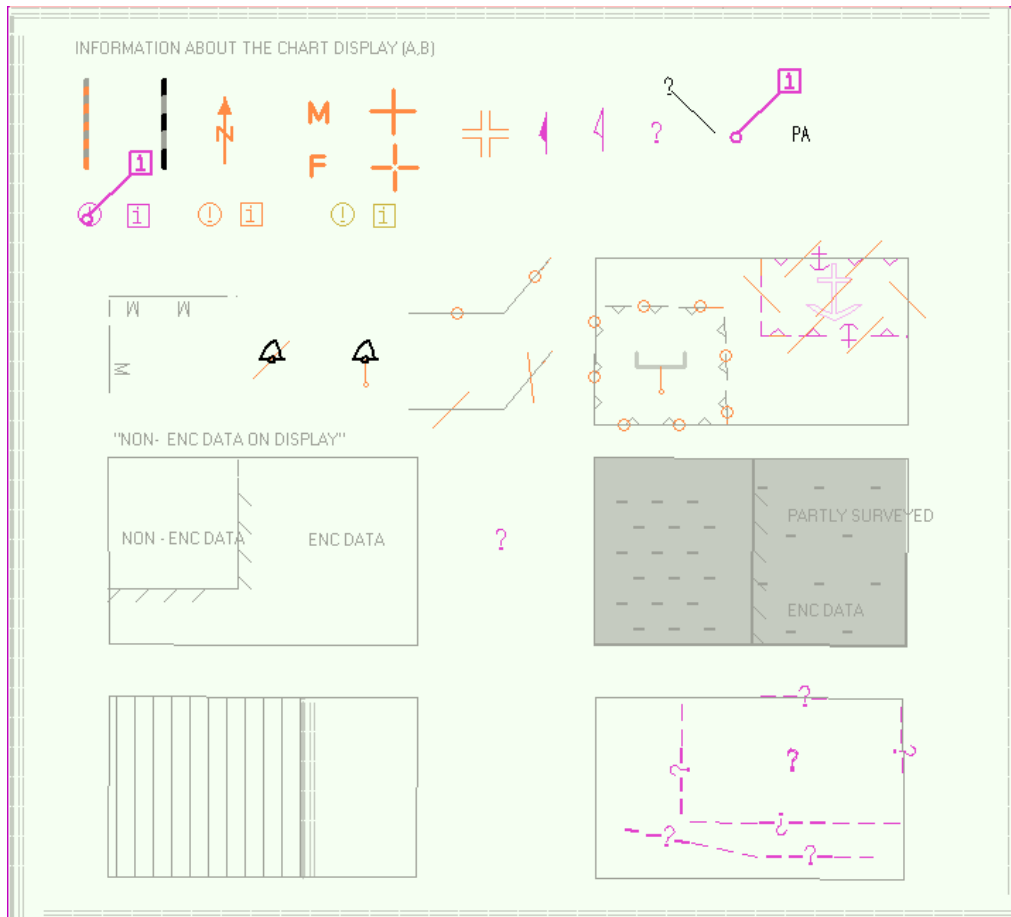

Chart AA5C1ABO

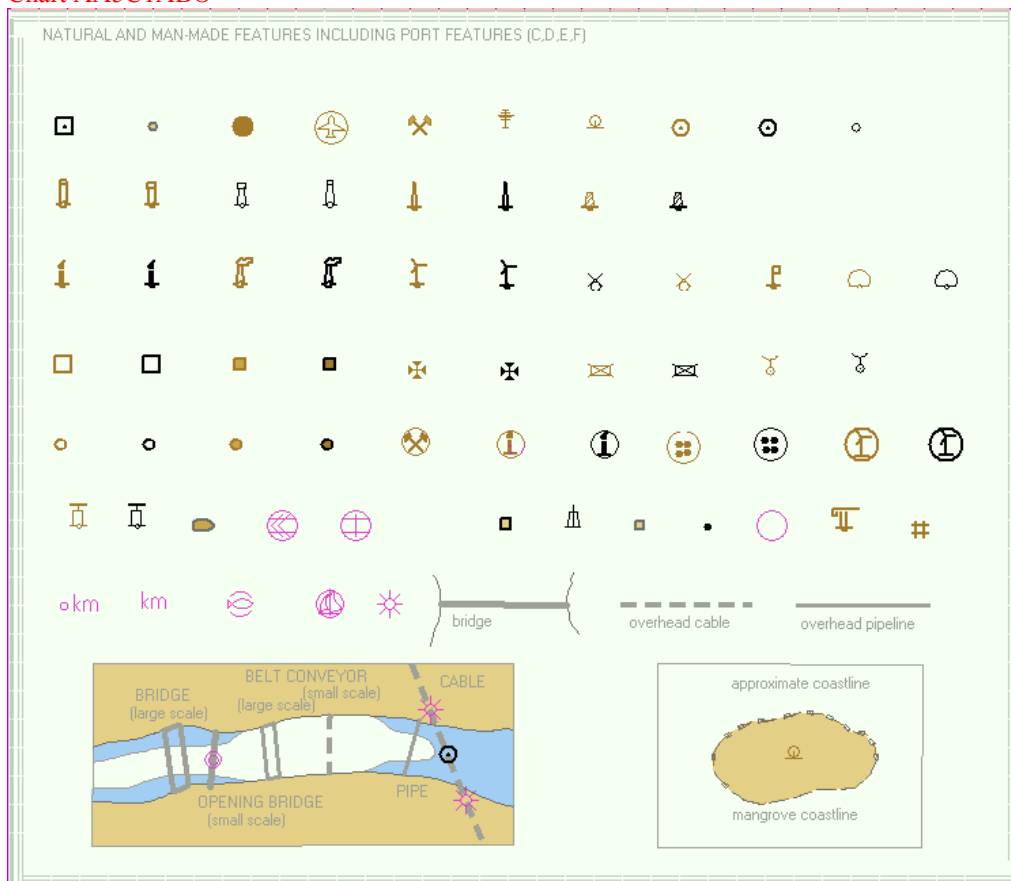

Chart AA5C1CDE

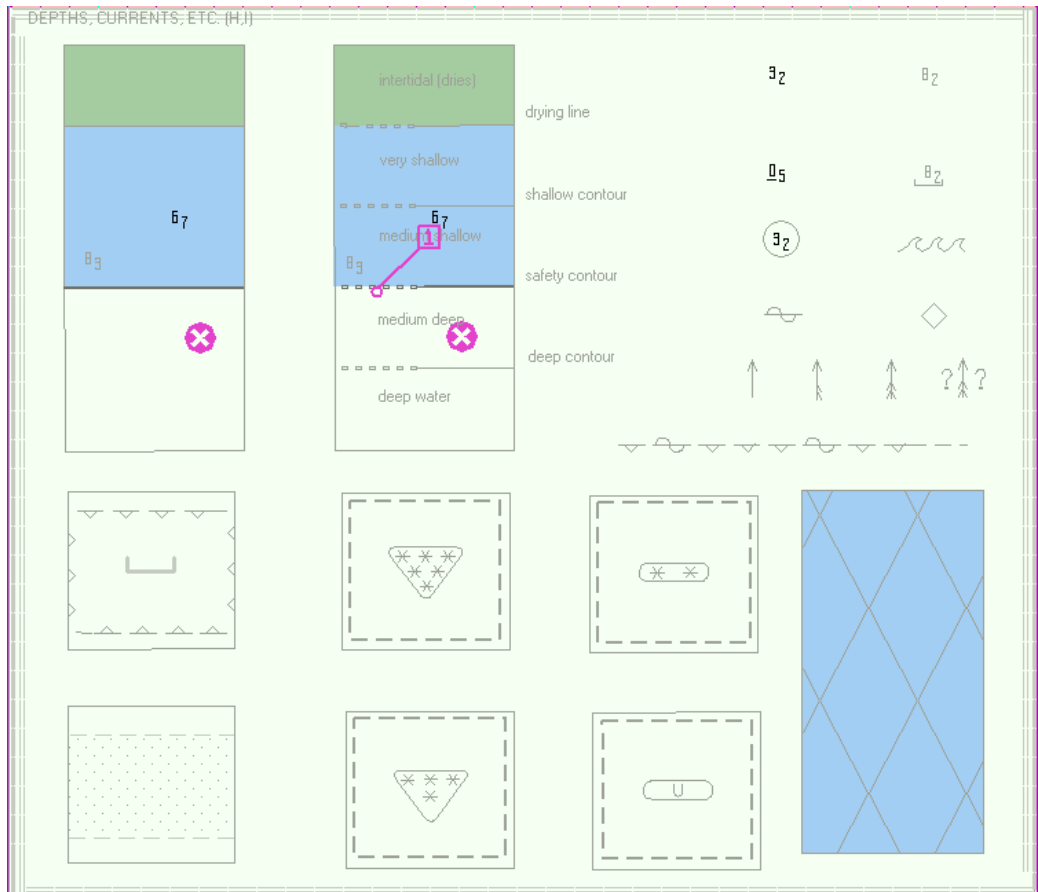

Chart AA5C1HIO

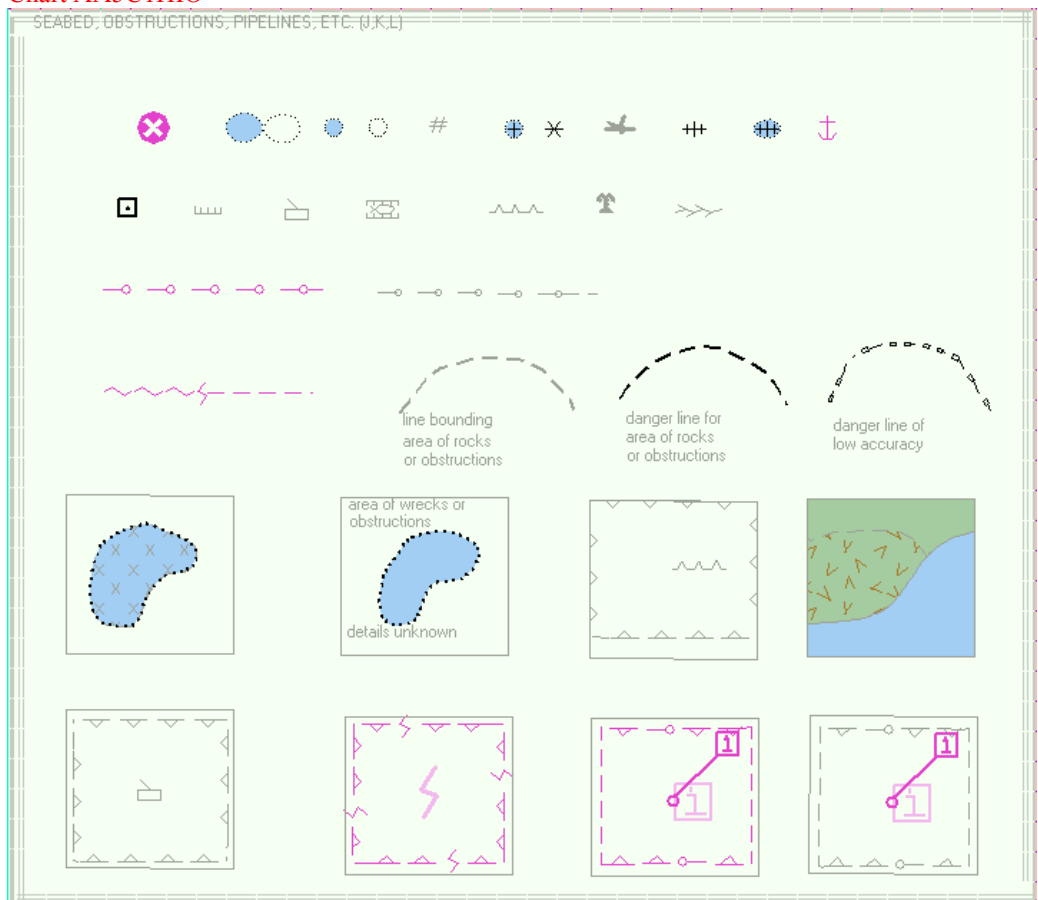

Chart AA5C1JKL

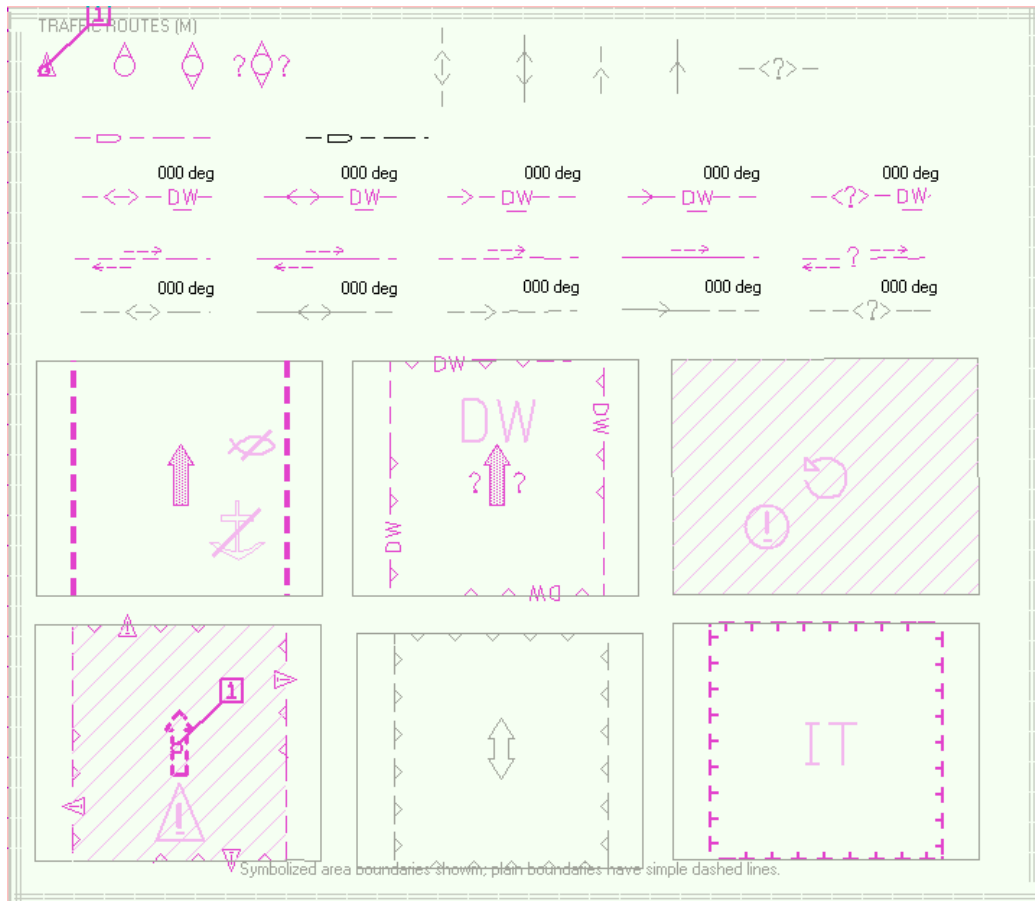

Chart AA5C1MOO

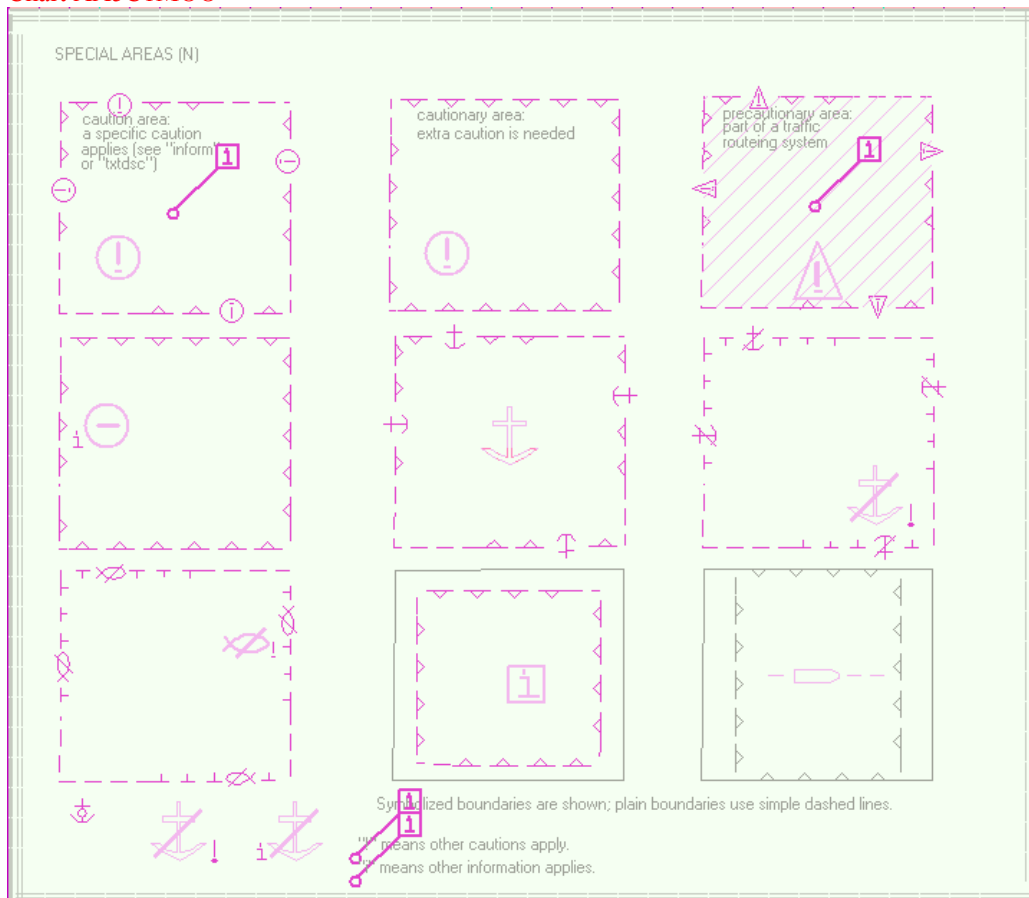

Chart AA5C1NOO



Chart AA5C1PQR

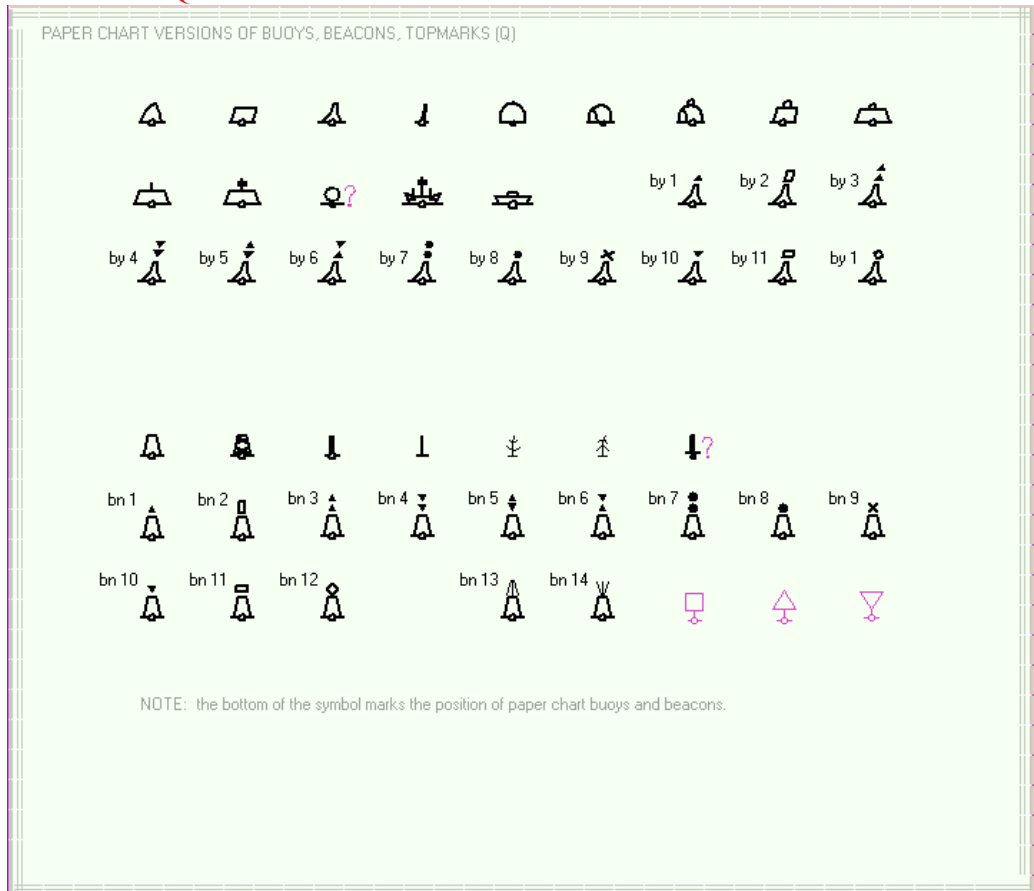

Chart AA5C1QOO

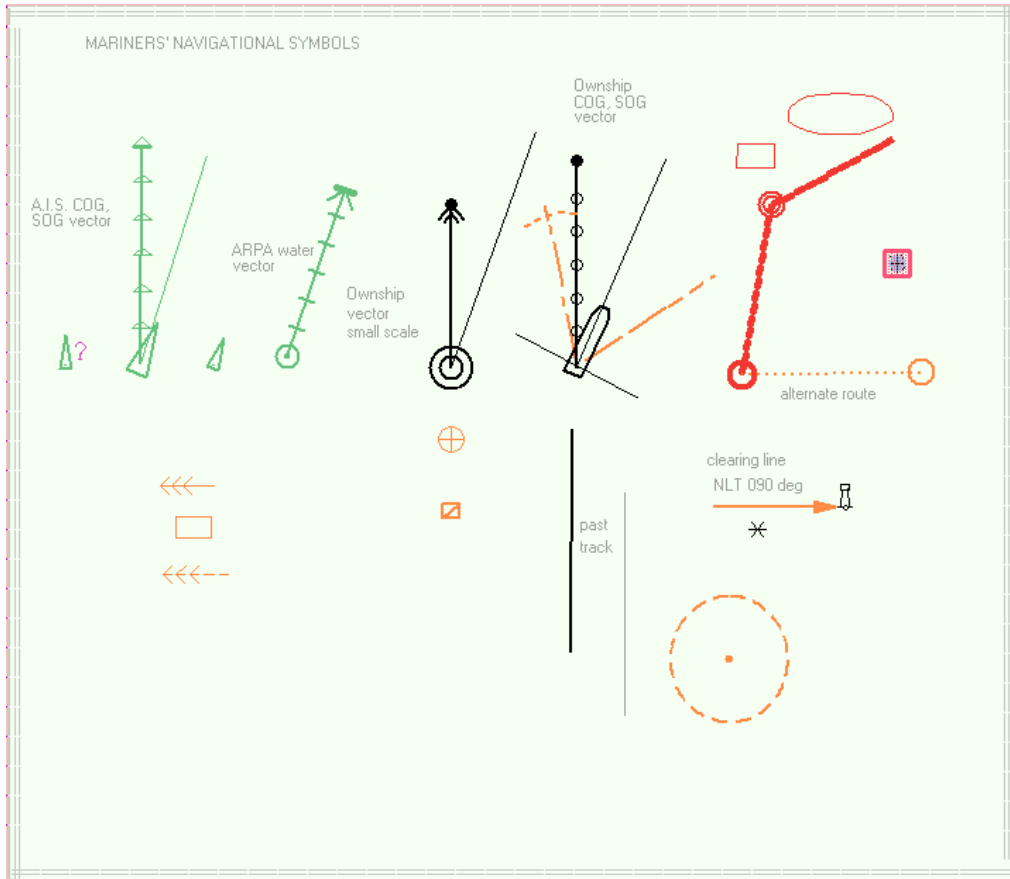

Chart AA5C1V00

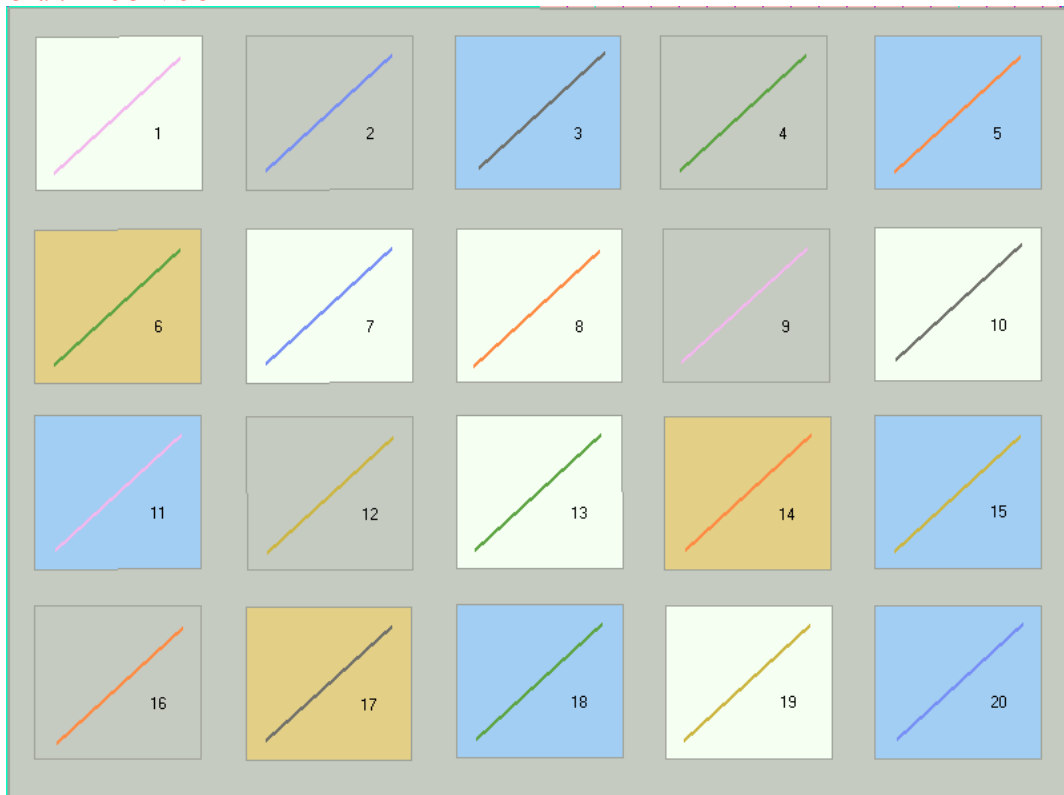

Chart AA5C1W00

Appendix 2

Short introduction to interpret display of S57 charts

Following examples gives you a short introduction to features of S57 charts which may not be obvious without some basic knowledge.

Paper Chart or Simplified Symbols

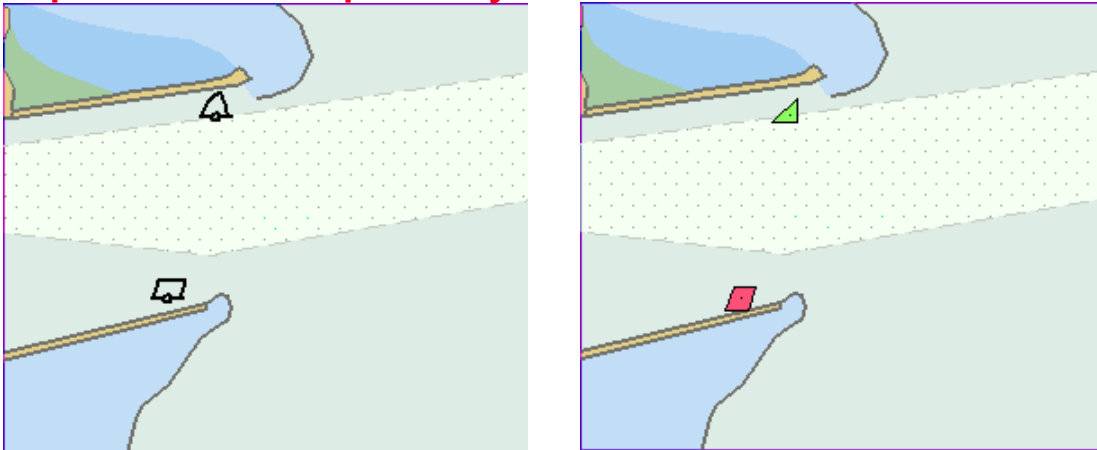

Two colour or Multi colour Depth

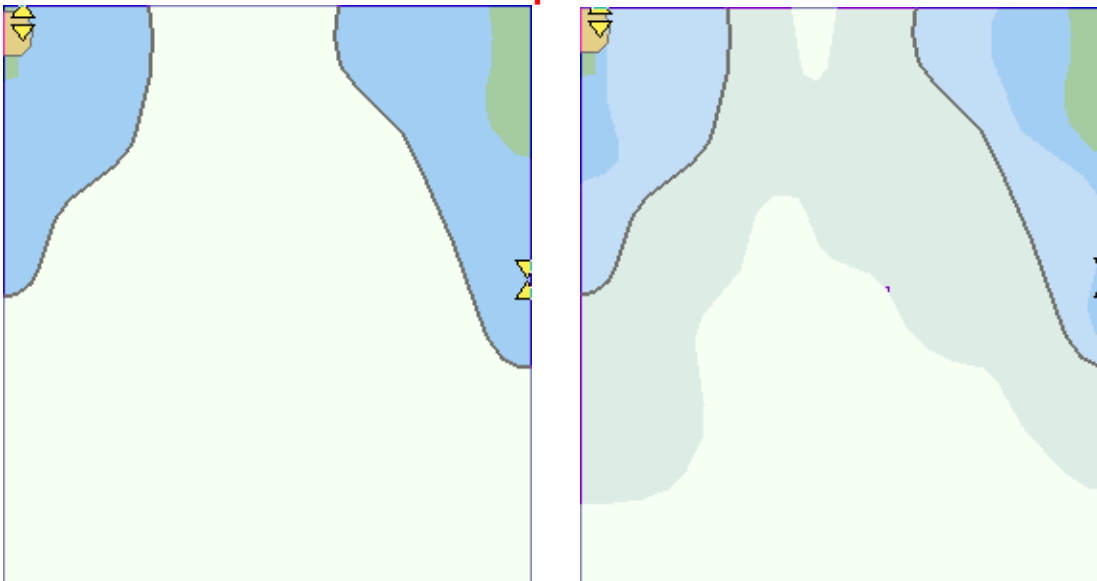

Plain or Symbolised Boundaries

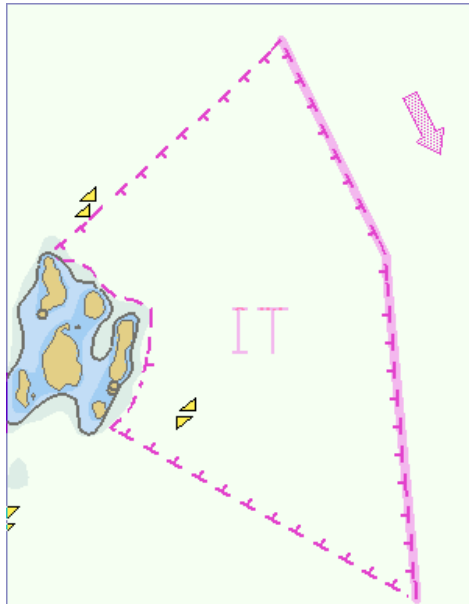
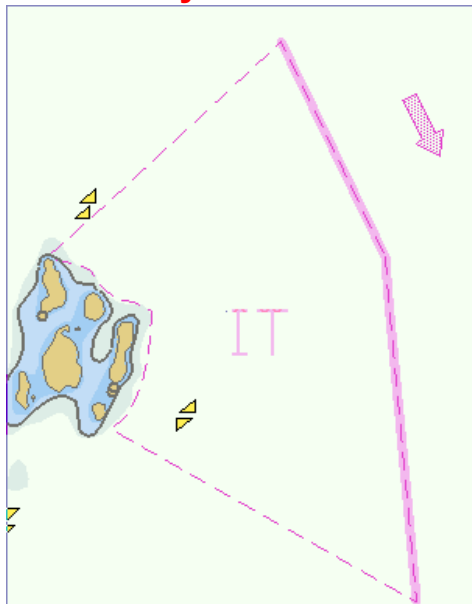

Limited or Full Light sectors

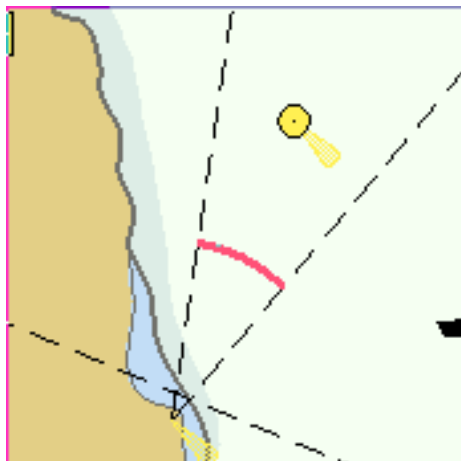
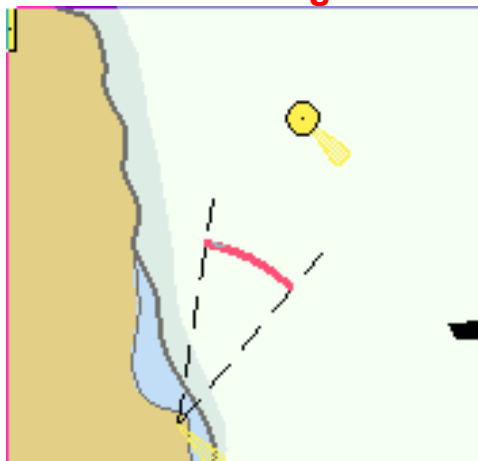

Shallow, Safety and Deep Contours

Shallow = 2m, Safety = 5m and Deep = 10m.

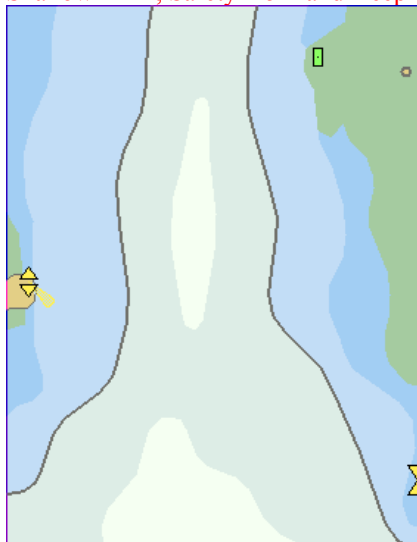

Shallow = 5m, Safety = 10m and Deep = 20m

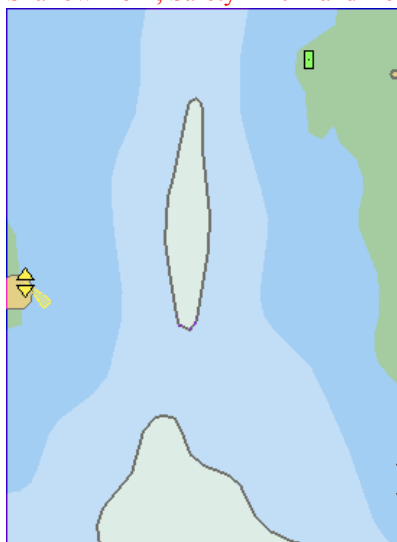

Safety depth = 6m.

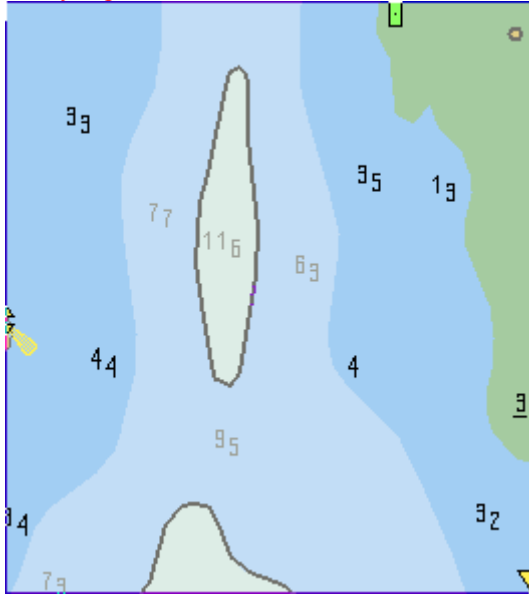

Safety depth = 10m.

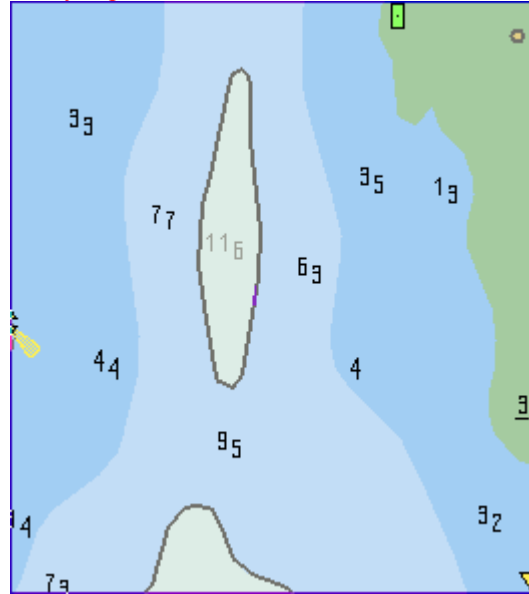

Shallow pattern

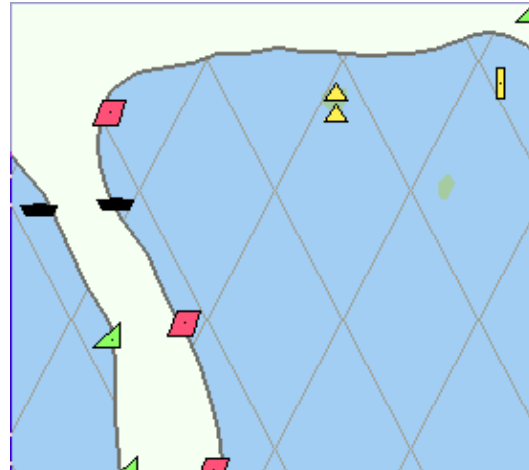

Sheet Standard: Unknown object or Presentation

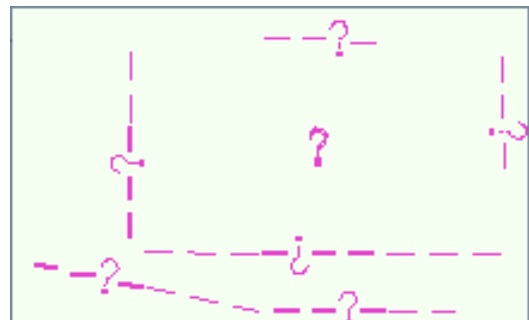

Sheet Standard: Chart data coverage

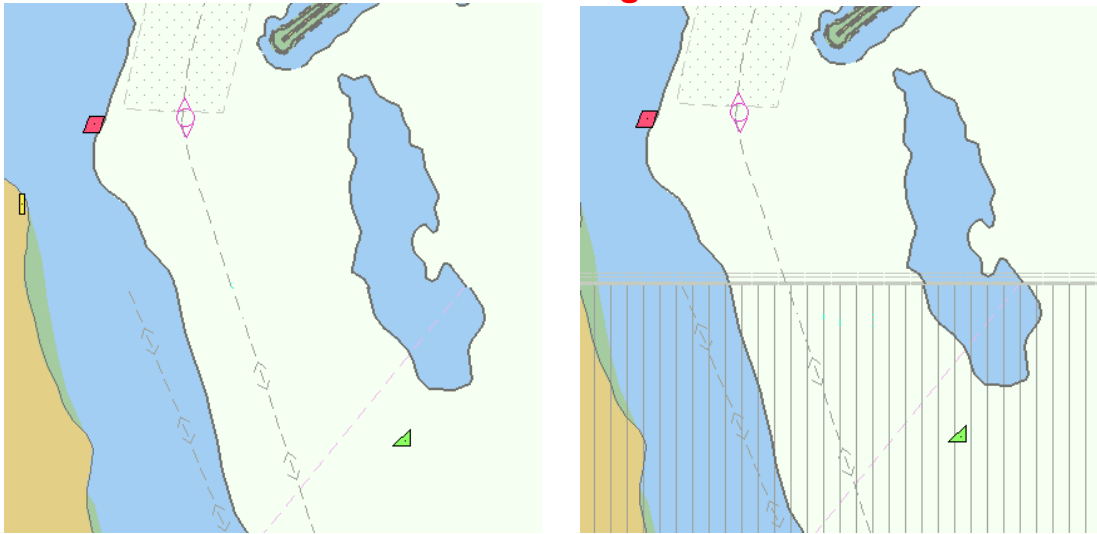

Sheet Standard: Land features

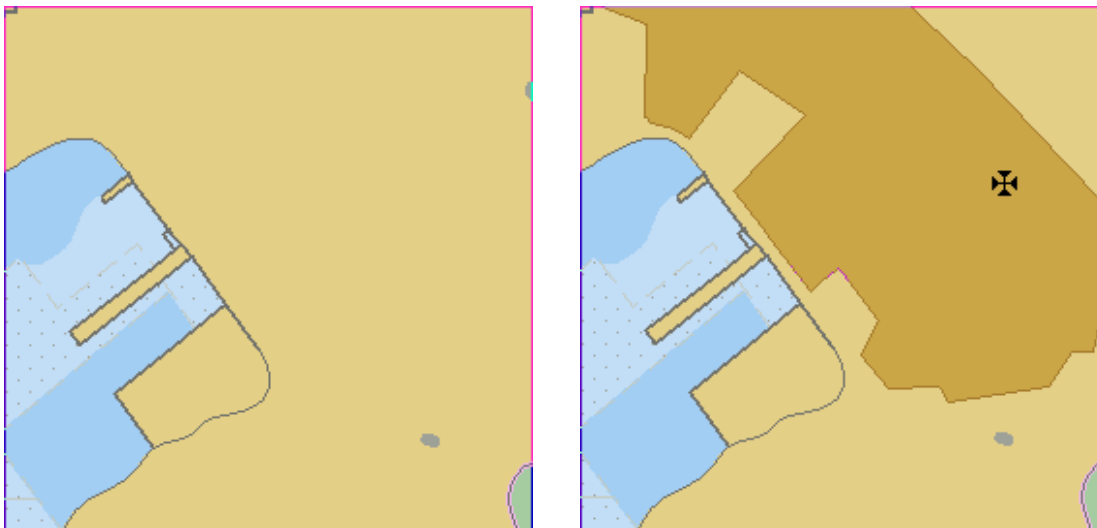

Sheet Standard: Water and seabed features

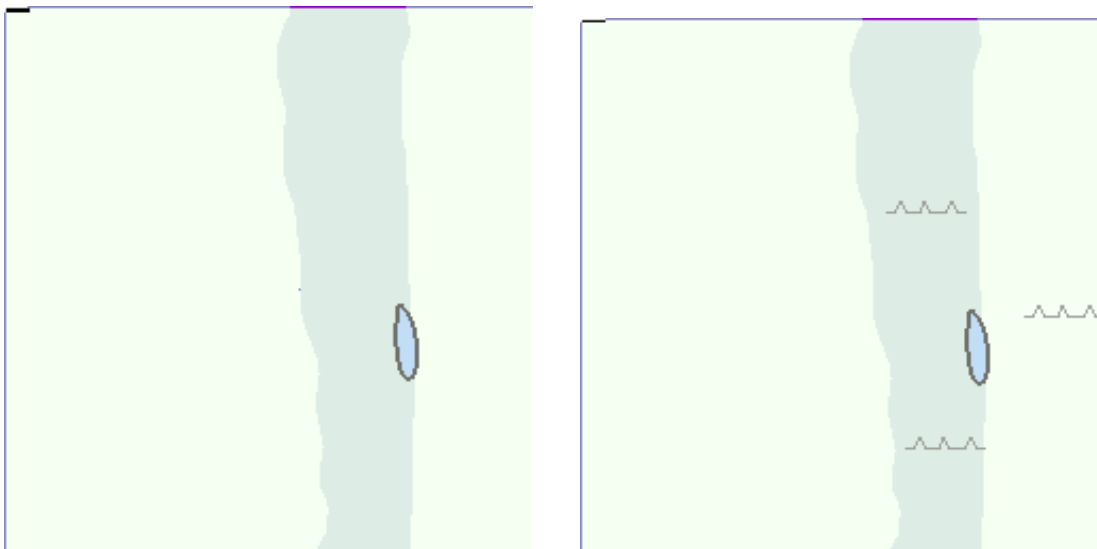

Sheet Standard: Traffic routes

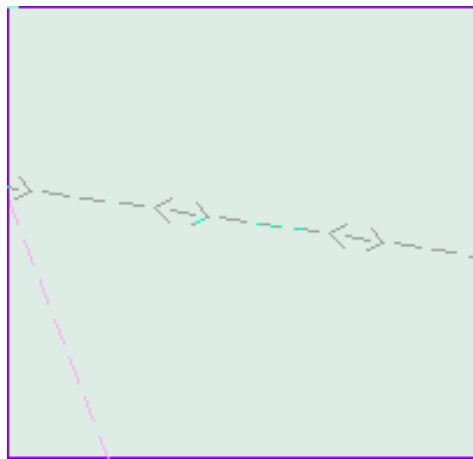
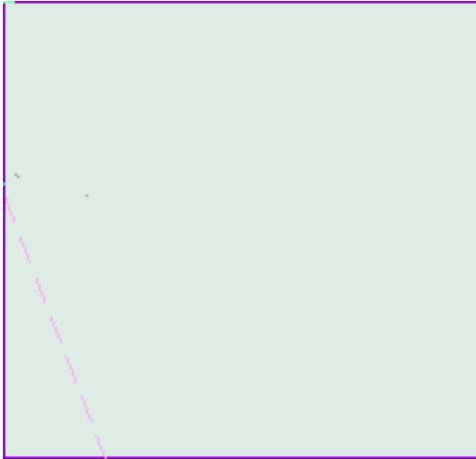

Sheet Standard: Cautionary areas

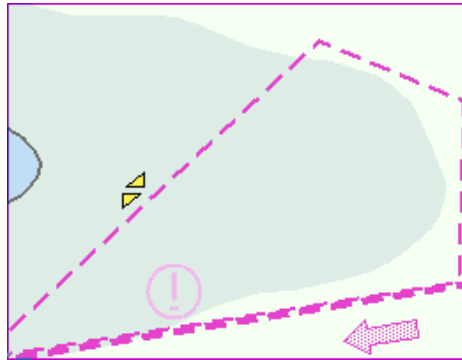
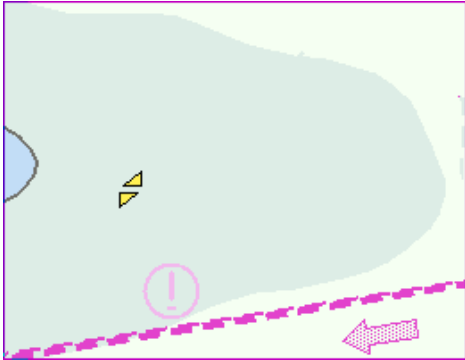

Sheet Standard: Information areas

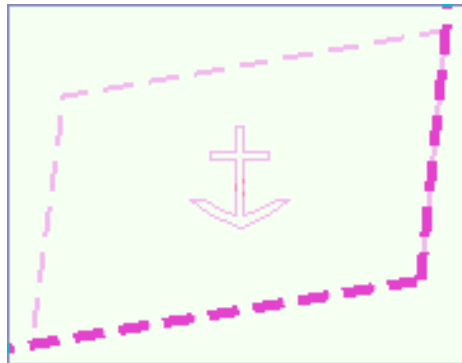
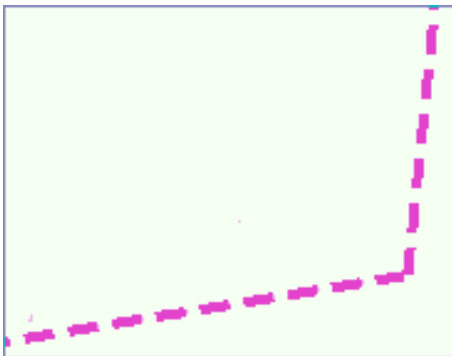

Sheet Standard: Buoys and beacons

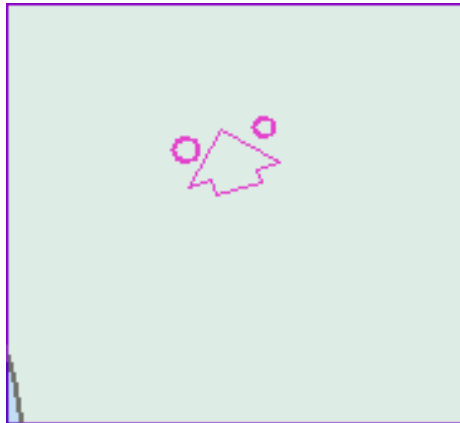

Sheet Standard: Lights

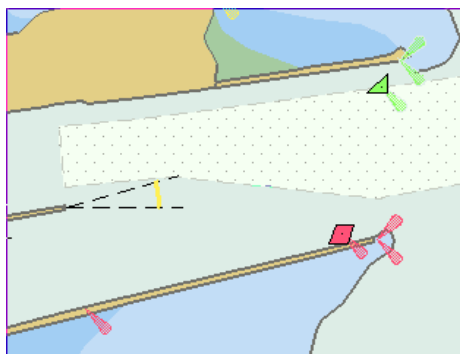
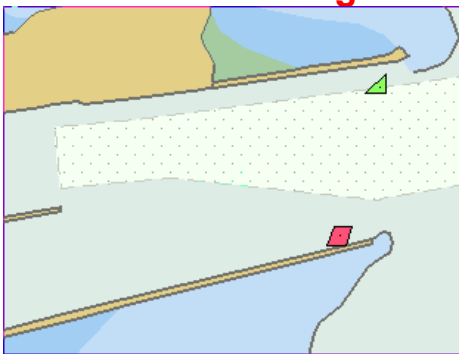

Sheet Standard: Fog signals

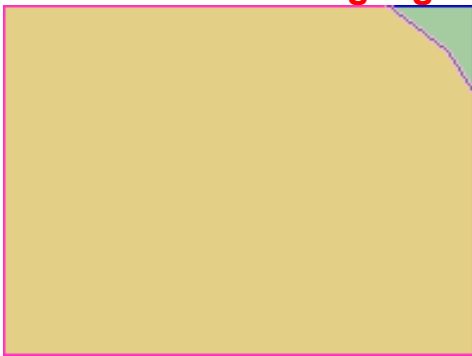

Sheet Standard: Radars

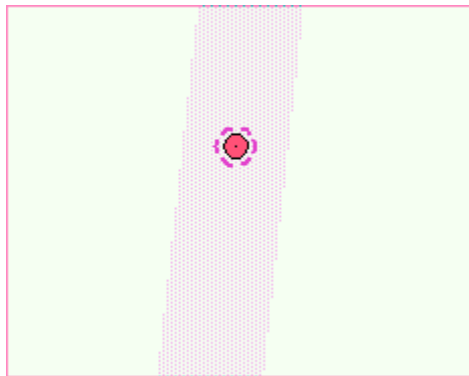
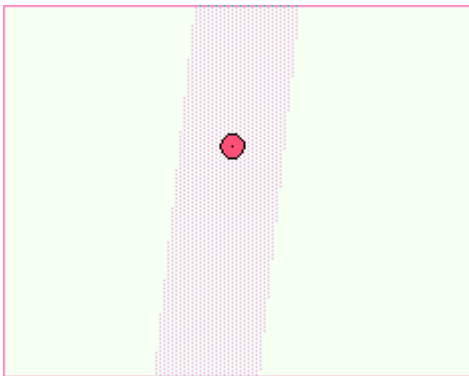

Sheet Standard: Services

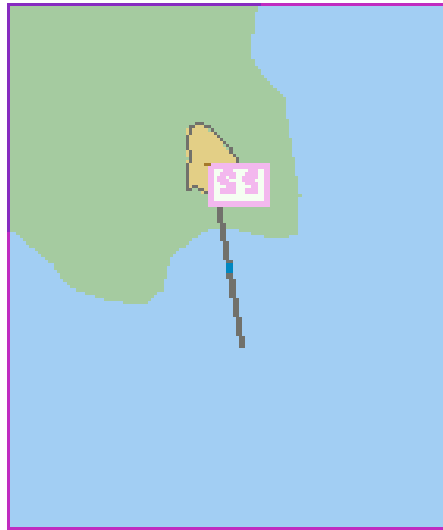
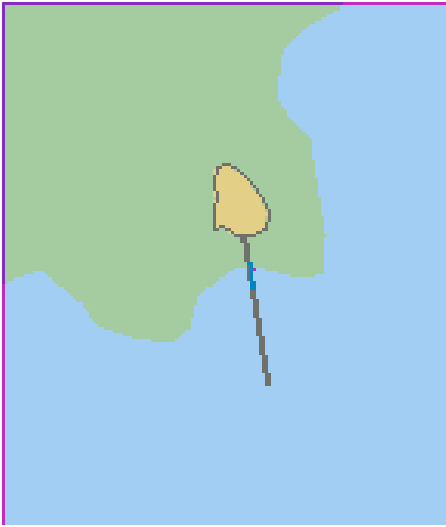

Sheet Other: Information about chart data

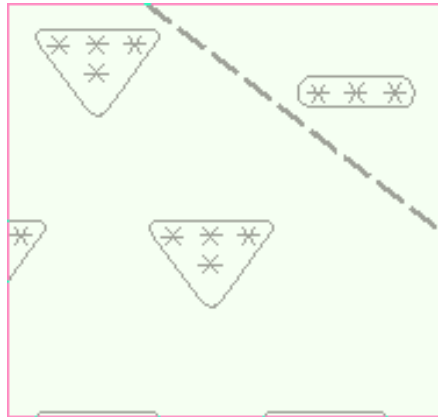
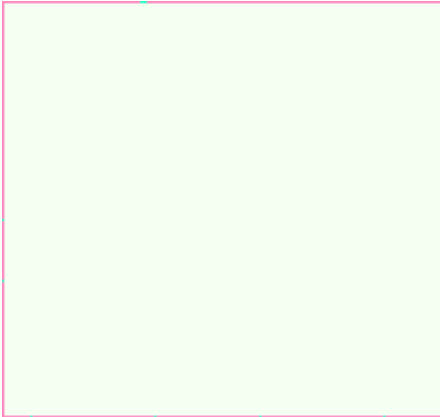

Sheet Other: Land features



Sheet Other: Soundings

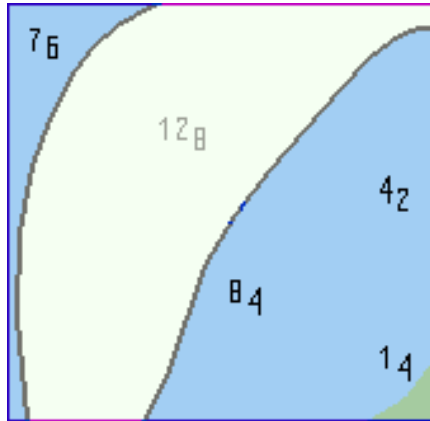
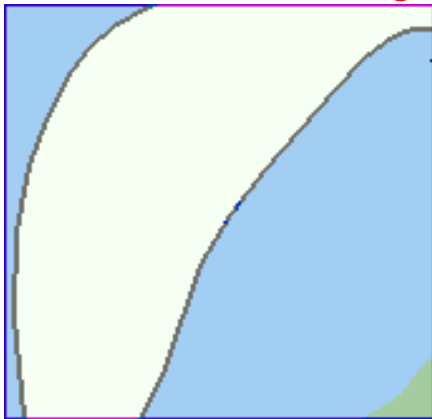

Sheet Other: Depth contours, current magnetic

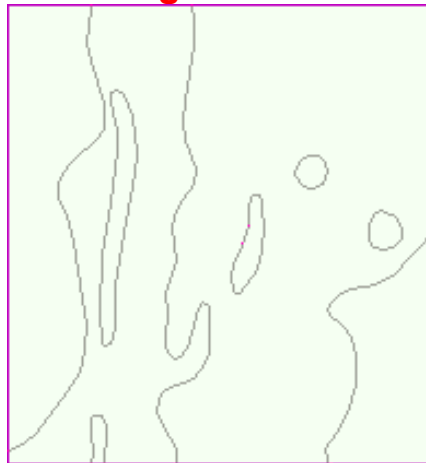

Sheet Other: Seabed and Obstructions

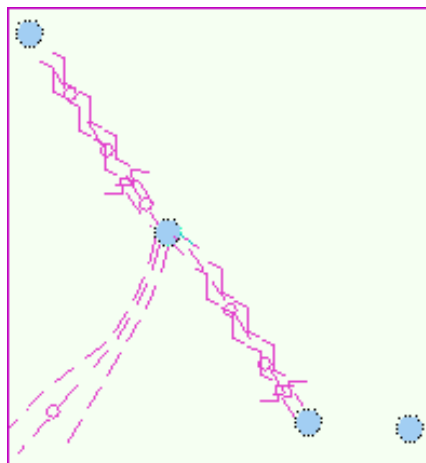

Sheet Other: Services and small craft facilities

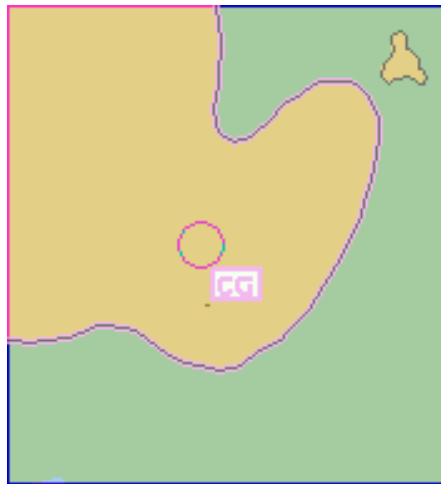
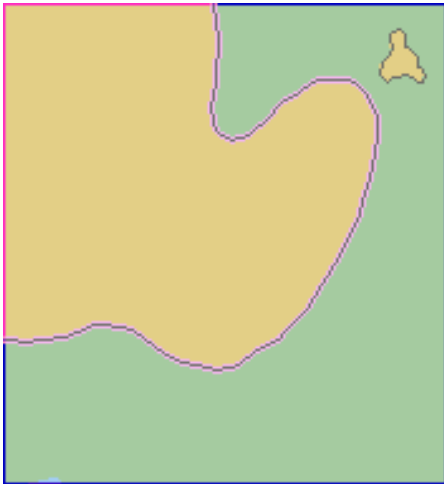

Sheet Other: Special areas

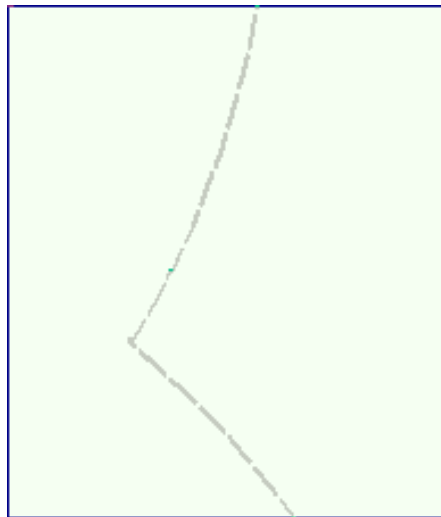
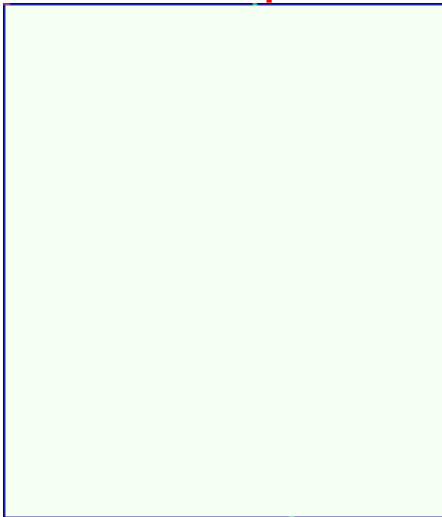

Sheet Other: Additional information available

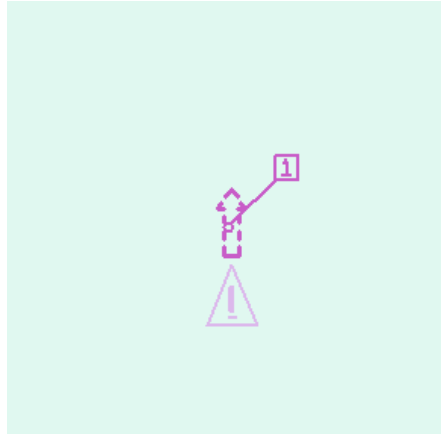
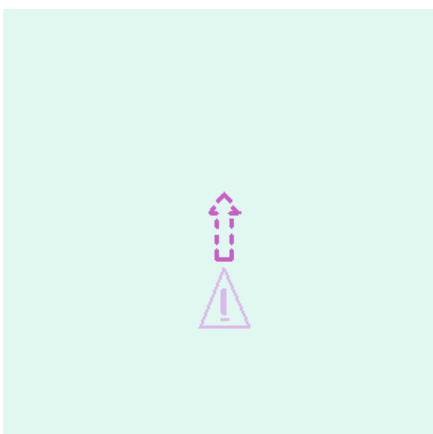

Sheet Other: Important text

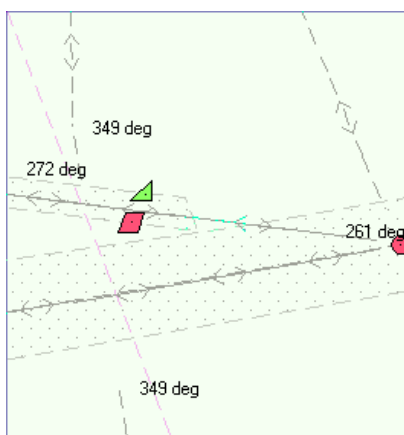
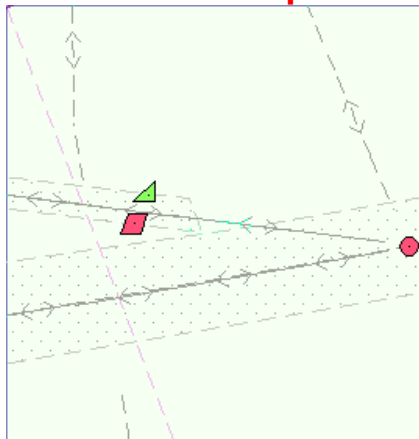

Sheet Other: Other text

Names for position reporting

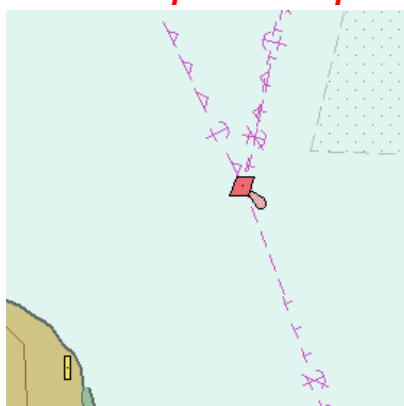

Light descriptions

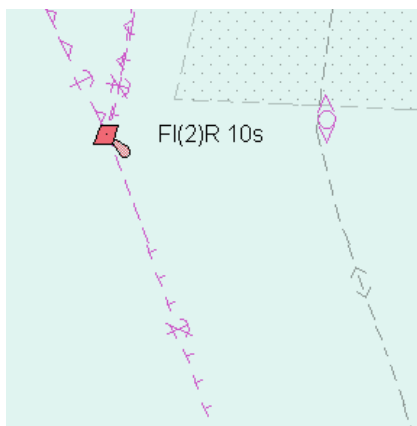
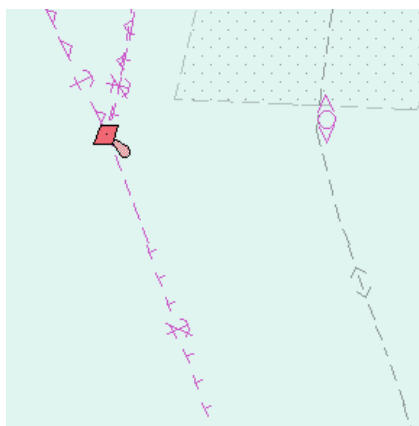

Nature of Seabed

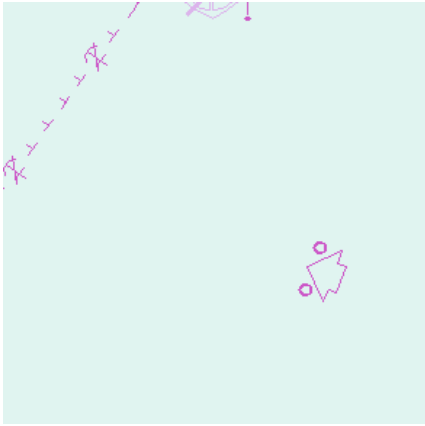

Geographic names, etc.

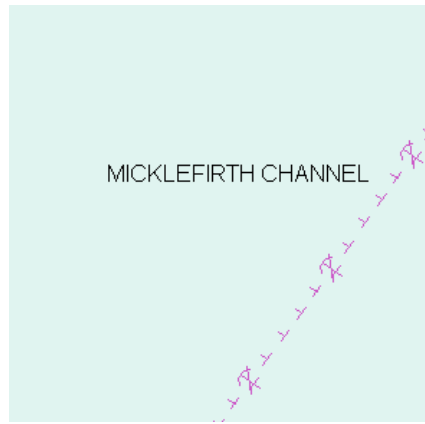
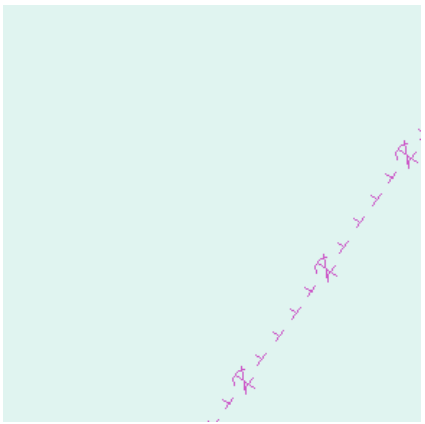

Swept depths, Magnetics

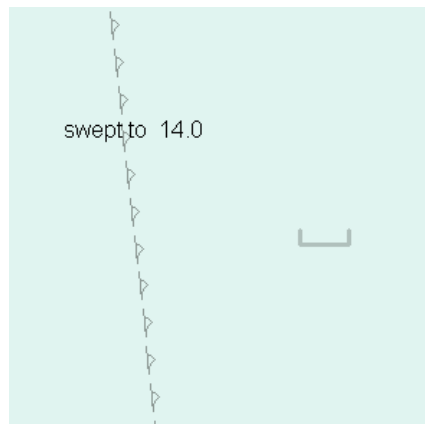
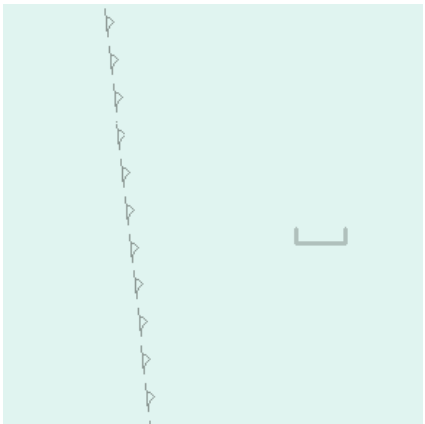

Bert and Anchorage numbers

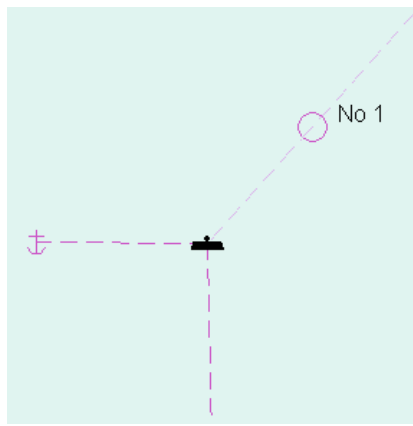
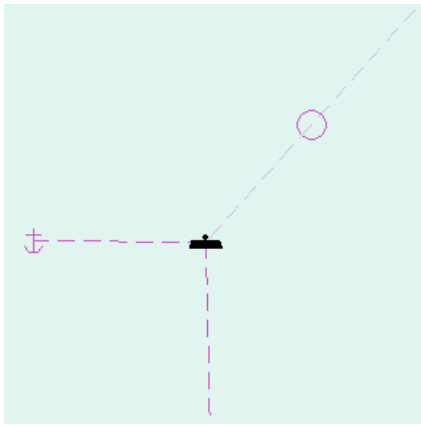

Appendix 3

C-MAP Charts

Introduction

This Electronic Chart System is also compatible with C-MAP private industry Vector Chart format CM-93 available from C-MAP Norway A/S. This material is used like Hydrographic Offices S57ed3 charts, but it doesn't have ENC status as defined by IMO, IHO and IEC and it cannot be used to replace paper charts.

CM-93 format is encrypted for preventing unauthorised use and then the user needs an Authorisation Code to view the CM-93. This Authorisation Code is entered manually from Control Panel.

Before any CM-93 charts can be used in the ECDIS, it is loaded into the hard disk and converted into the system's own internal format (SENC). CM-93 charts can be updated only by loading newer complete set of CM-93 charts. CM-93 chart material is stored into two CD-ROMs.

For any other detail of CM-93 charts use the Vector Chart Material Chapter of this manual.

S57 Chart Legend with C-MAP charts

S57 chart legend	
Cell name	04140023
Navigational purpose	Approach
Issue date	19990115
Edition number	1
Last displayed update	000
Update issue date	19990115
Last update appl. date	
Projection	Mercator
Horizontal datum	WGS 84
Vertical datum	
Sounding datum	
Quality of data	
Magnetic var.	
Depth	metres
Height	metres

An example of Chart Legend with C-MAP chart.

S57 chart managing with C-MAP charts

Licence system used by the C-MAP

The licence system with C-MAP is based on serial numbered CD-ROMs and Authorisation Codes received from C-MAP Norway A/S. You select either required C-MAP Areas or Zones and your Electronic Chart System generates an User Code based on your selection, the serial number of the serial numbered C-MAP CD-ROM and the Hardware Identifier of your Electronic Chart System. You send the User Code to C-MAP Norway A/S and they send to you an Authorisation Code. You enter the received authorisation code into the system and then you can load and convert the CM-93 charts into your system.

How to get started with C-MAP charts

1. Select automatic conversion into the SENC and setting of Display and Approve Update dates automatically. See "How to make conversion into SENC and set display date automatically with C-MAP charts" on page 469.
2. Define your subscription of C-MAP charts. See "How to define subscription of C-MAP charts" on page 454.
3. Load C-MAP charts by CD catalog. See "How to load C-MAP charts from a CD into the system" on page 459.

How to keep up to date your C-MAP charts

At regular intervals C-MAP will reissue its charts to keep them up-to-date. There are neither edition number nor update number in C-MAP charts, so the system recognises changed charts using issue date of the chart.

The procedure of loading the reissue is the same as loading of the C-MAP charts first time. If loaded chart is already in the hard disk with older issue date, the system loads selected newer chart automatically. Other possible messages when loading C-MAP charts are explained in the end of the chapter "How to load C-MAP charts from a CD into the system" on page 459.

If you get a new release of a C-MAP CD-ROM, proceed as follow:

1. Select automatic conversion into the SENC and setting of Display and Approve Update dates automatically. See "How to make conversion into SENC and set display date automatically with C-MAP charts" on page 469.
2. Load C-MAP charts by CD catalog. See "How to load C-MAP charts from a CD into the system" on page 459.

How to define subscription of C-MAP charts

Before you can be as authorized user of C-MAP charts you have to following things:

1. Purchase CD-ROM(s) of C-MAP from your Chart Agent.
2. Load Serial Number of C-MAP into the ECDIS
3. Select charts you like to use in the ECDIS by using Zones or Areas.
4. Generate User Code. This code is used to identify your chart folio for producer of C-MAP.
5. Send User Code to your Chart Agent.

Based on User Code information producer of C-MAP charts is able to generate permission for the charts your have selected. You will receive Authorization code from the producer of C-MAP charts.

After receiving Authorization Code, proceed as follows:

1. Enter Authorization Code into the ECDIS.
2. Use command **Load by CD-Catalogue** until you have to select which chart to load.
3. Build a group of required C-MAP charts.
4. Load C-MAP charts using command **View loaded CD-Catalog**.

How to load Serial Number of CD-ROM

Each CD-ROM has individual Serial Number which is used to identify user of C-MAP charts. In order to load Serial Number into the ECDIS, proceed as follows:

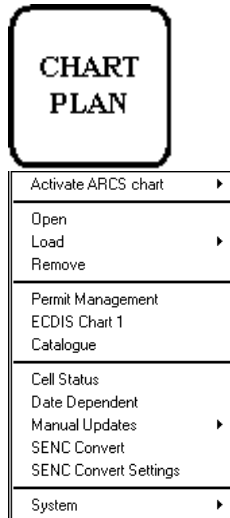

1. Press CHART PLAN push button
2. Select **Permit Management** from the menu.
3. Press Non-Ho button in Permits dialog box.

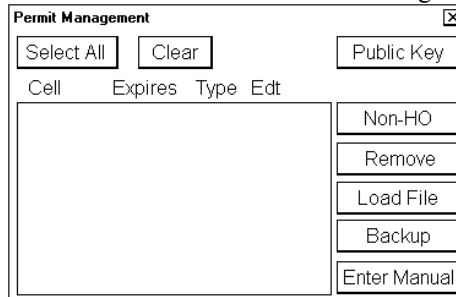

Following windows appear:

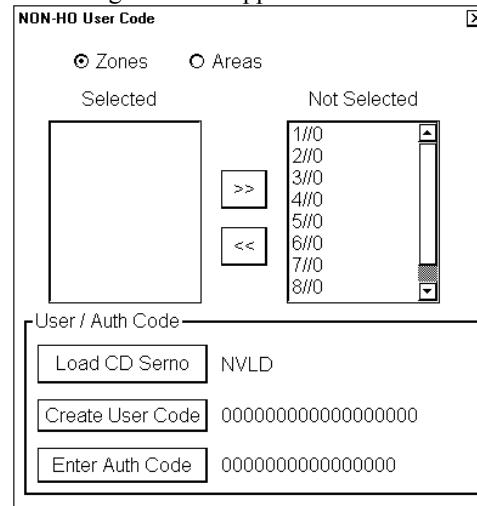

4. In NON-HO User Code dialog box, press **Load CD SerNo** button.
5. Insert your C-MAP CD-ROM to CD-drive and select desired drive.

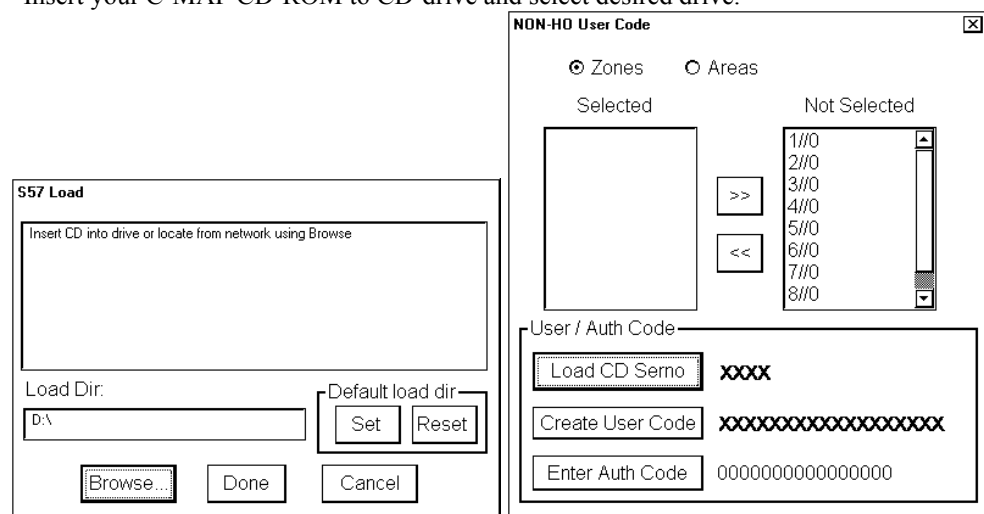

6. The CD serial Number is shown in SerNo field.

How to define subscription by zones

The content of CD-ROM is divided into nine zones (1/0 - 9/0) and each zone has been divided in various number of Areas (1/1 - 1/16...9/1 - 9/2). A various number of charts are included into each Area. You can define charts you like to have in your chart folio either by Zones or by Areas.

To define subscription by Zones, proceed as follows:

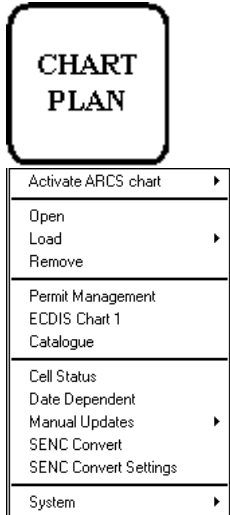

1. Press CHART PLAN push button
2. Select **Permit Management** from the menu.
3. Press Non-Ho button in Permits dialog box.

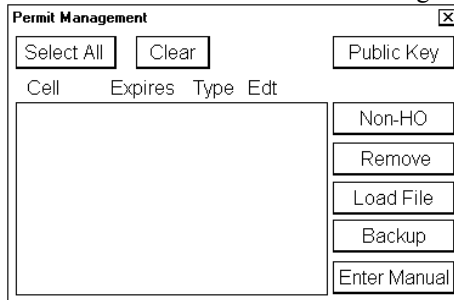

Following windows appear:

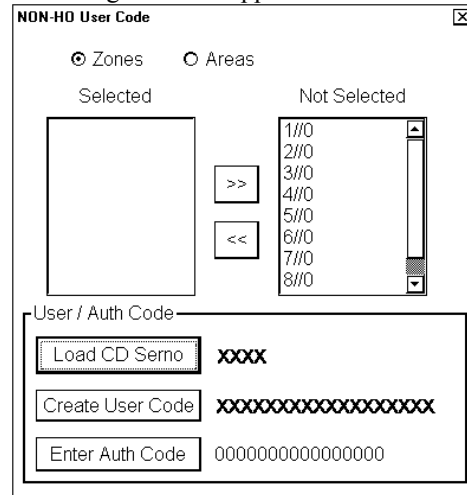

Select **Zones** tick box.

4. Highlight desired Zones in a **Not Selected** list box and press << button to move them into a **Selected** list box.
5. To create User Code for selected Zones, press **Create User Code** button. The ECDIS generates User Code which is sent to producer of C-MAP charts.

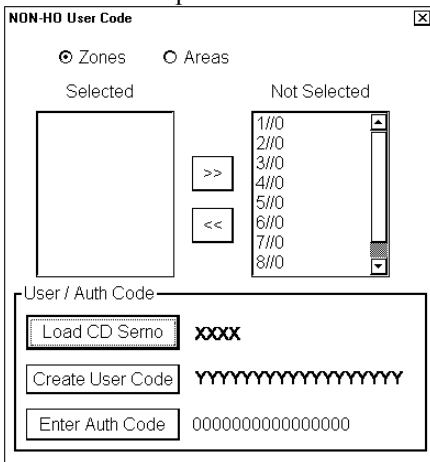

6. User Code is shown in Create User Code field.

How to define subscription by areas

The content of CD-ROM is divided into nine zones (1/0 - 9/0) and each zones has divided various number of Areas (1/1 - 1/16 ... 9/1 - 9/2). The various number of charts are included to Area. You can define chart you like to have in your chart folio either by Zones or by Areas.

To define subscription by Areas, proceed as follows:

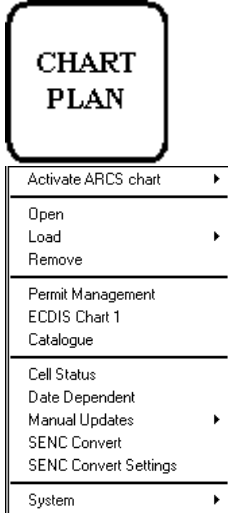

1. Press CHART PLAN push button
2. Select **Permit Management** from the menu.
3. Press Non-Ho button in Permits dialog box.

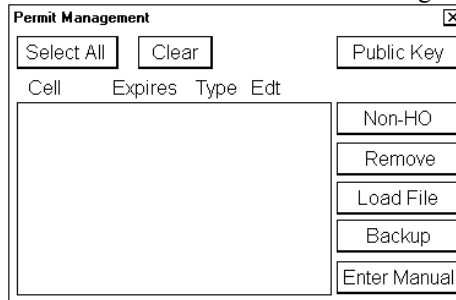

Following windows appear:

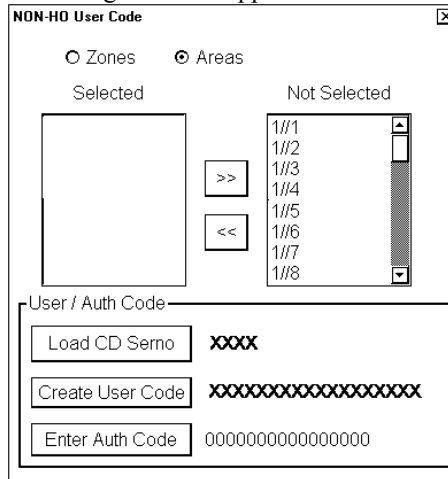

Select **Areas** tick box.

4. Highlight desired Areas in a **Not Selected** list box and press << button to move them into a **Selected** list box.
5. To create User Code for selected Areas, press **Create User Code** button. The ECDIS generates User Code which is sent to the C-MAP.

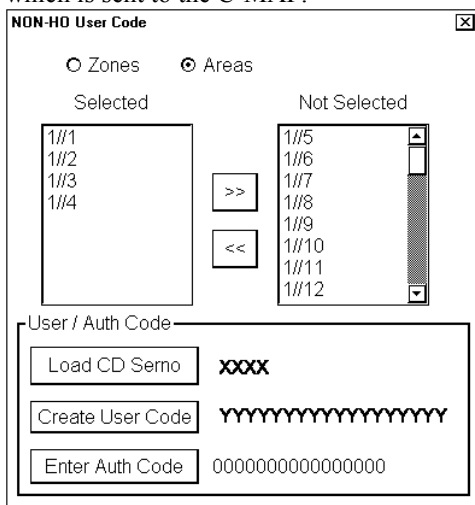

6. User Code is shown in Create User Code field.

How to enter Authorisation Code

An Authorisation Code allows you to define your subscription to C-MAP. Based on your User Code you receive Authorisation Code from the C-MAP. You have to enter this string into the ECDIS. In order to do it, proceed as follows:

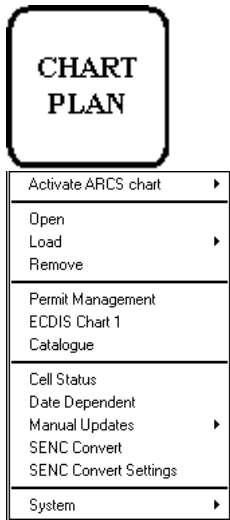

1. Press CHART PLAN push button
2. Select **Permit Management** from the menu.
3. Press Non-Ho button in Permits dialog box.

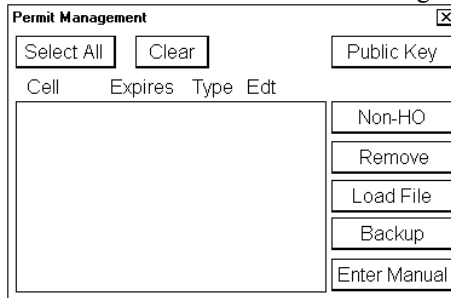

Following windows appear:

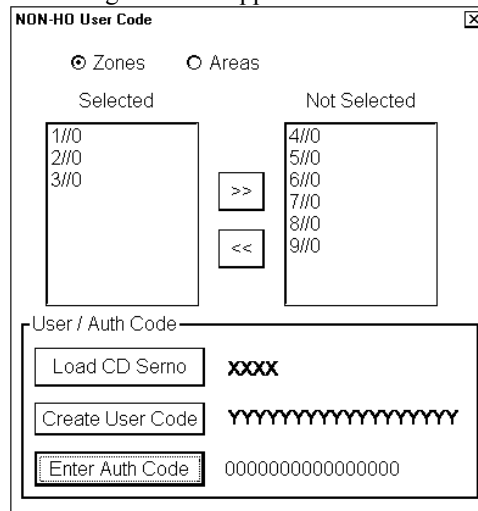

4. Press **Enter Auth Code** button.
5. Enter the string you received from C-MAP.

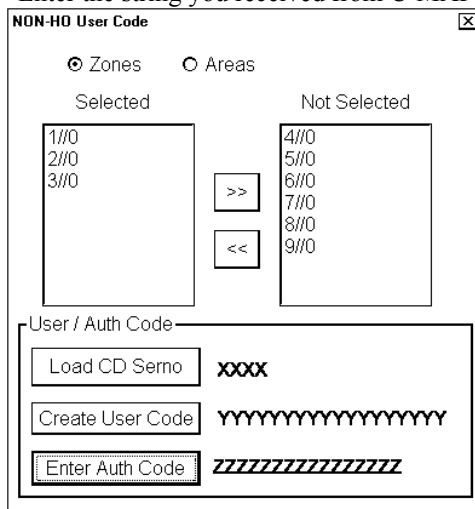

6. After entering Authorisation Code you are ready to load and view desired charts into the ECDIS.

How to load C-MAP charts from a CD into the system

When you load C-MAP charts by CD Catalogue, the system first load a CD catalog, which stores certain information into the hard disk such as cells ID, their position, edition number, from your LAN (Local Area Network) connection, floppy or CD-ROM. After that the system asks which charts will be loaded from the CD-ROM.

After building the CD catalogue you can view the contents of it using S57 catalogue command.

Note:

All CD-ROMs, floppies or LAN (Local Area Network) connections from one National Hydrographic Office have equal names although their contents could be totally different. You must give them unique names to identify them separately and correctly later.

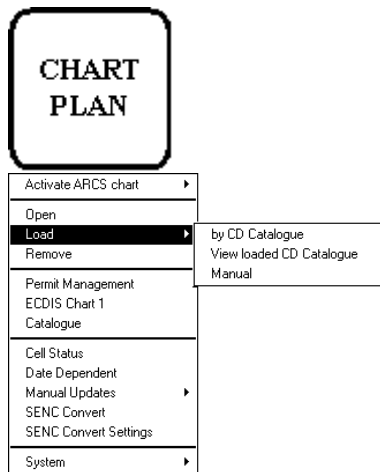
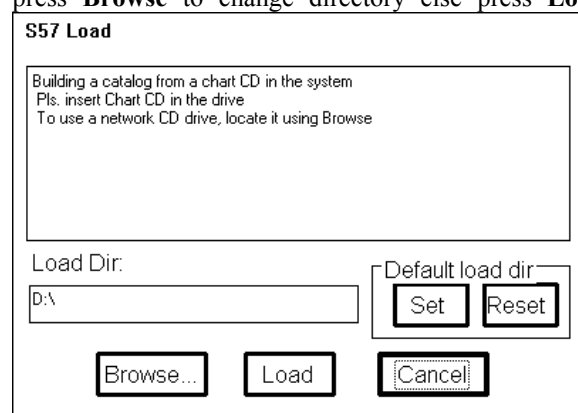
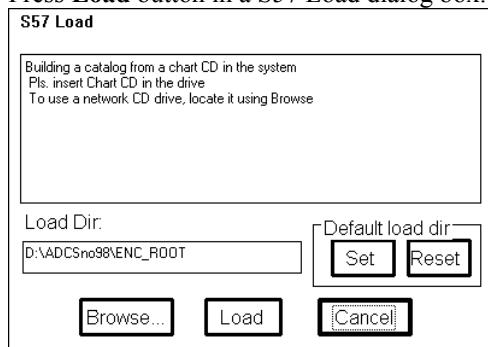

CHART PLAN push button

1. Press CHART PLAN push button
2. Insert desired CD-ROM to CD-ROM drive.
3. Select **Load** from the menu and **by CD Catalogue** from the sub menu. A S57 build CD catalogue dialog box appears. If you have incorrect Directory, press **Browse** to change directory else press **Load** in this dialog box.



4. Press **Load** button in a S57 Load dialog box.



5. A keyboard dialog box appears. Enter name for CD Catalog and press **OK**. The system will load catalogue information into the hard disk.

The dialog box is titled "Keyboard" and contains the text "Enter name for catalog". Below this is a text input field containing "CM93PROF2". At the bottom, there is a keyboard layout with buttons for "OK" and "Cancel".

6. A following dialog box appears. Select a named "CD" you want to use from CD -field. A list of charts appears into a list box. In a **Chart Selection** you can choose which charts are loaded from the CD-ROM. Use "Missing only" to select charts not already loaded into the ECDIS.

The dialog box is titled "Load or View CD Catalogue" and has a close button (X). It contains a "CD" dropdown menu with "CM93PROF2" selected and a "Remove" button. Below this, it shows "Source Week 11 Date 2000 3 18". There are two buttons: "View CD Publisher Notes" and "View CD content Summary". A list box shows a table of charts with columns "Chart" and "Edt/Upd". The list includes entries like "00300648.C", "00300660.A", "00300720.A", "00300720.Z", "00300780.A", "00300840.A", "00300840.Z", "00300888.C", "00300900.A", "00300900.C", "00300912.C", "00300924.C", "00300936.C", "00300948.C", "00300960.A", "00300960.C", and "00300960.Z". Below the list box is a "Chart Selection" section with radio buttons for "Group", "Permits", "All", and "Manual", and a checked checkbox for "Missing only". There is also a "Groups" button. At the bottom, there are buttons for "Source Dir", "Load", and "Cancel".

Press **Load** button to load charts.

7. A SENC Convert window appears:

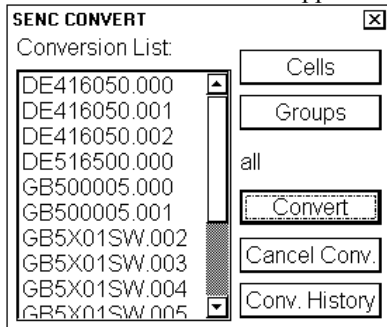

Example above shows a queue of unfinished SENC conversions.

8. Failed senc conversion window appears, when loading C-Map charts with state "Errors". Reason may only be "Illegal producing Agency" to indicate that chart cannot use paper chart equivalent.

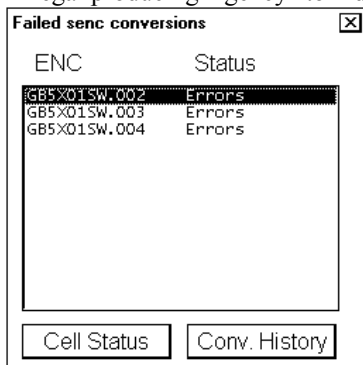

Press **Conv. History** button to view detailed reason for Error state.

9. Example above shows that all SENC conversions have been finished.

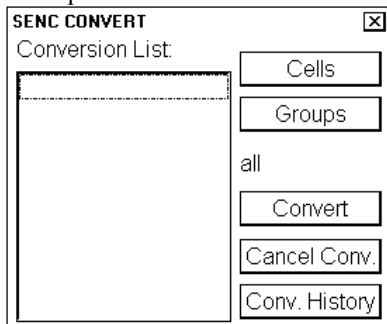

NOTE! If you want to make chart selection by group, press **Group** button and select desired group. If the selected group and charts available from CD have common members, they are highlighted in the list box. If you want to load your charts from another drive than your computer CD-ROM drive (for example from Local Area Network, LAN), press **Source Dir** button. Then you can define drive and path from where you load your charts.

The System can make conversion into the SENC and setting of Display Until date automatically. It takes some time to convert charts into SENC.

NOTE! You can get Summary information about charts you are going to load.

1. Press **View CD content Summary** button in the S57 Load dialog box.
2. A text processing program shows text information about selected named "CD Catalog". For C-Map chart you can view issue date. For C-MAP charts the edition is always 1.
3. If you want to make a hard copy of Catalogue Summary, select **Print** in the **File** menu.
4. To close this program, select in **Exit** in the **File** menu.

Untitled - TextView

File Setting Text

Summary of Catalog: NON_HO

CellID	Edition	Base	First Update	Last Update
00300000.A	1	0 / 1998	4 17	
00300000.Z	1	0 / 1996	3 9	
00300060.A	1	0 / 1998	4 17	
00300120.A	1	0 / 1998	4 17	

Ready

If you already have charts with the same issued date loaded into your hard disk, you get following message after pressing **Load** button:

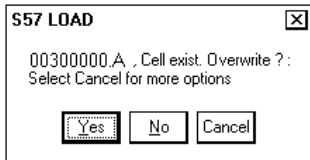

If you press **Cancel** button, you will get following dialog box:

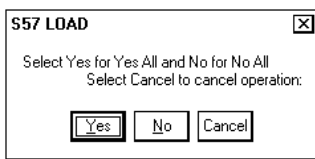

If you want to avoid very time consuming reload of C-MAP charts, you should select No (= "No for all" option in above window).

However if you want to reload C-MAP charts, then select Yes in above window.

If you try to load C-MAP charts, which have older issue date than you already have loaded into your hard disk, then you get following message:

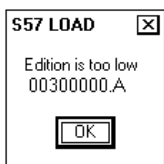

You can not replace a newer C-MAP chart with older C-MAP chart unless you first remove the newer C-MAP chart from your hard disk (See chapter "How to remove S57 chart cells from the system").

Use of CD Catalogue

For C-MAP charts the CD Catalogue contains Summary of the charts (note that CD Publisher Notes are not available for C-MAP). Sometimes it is necessary to reload charts from the CD-ROM. These things can be done as shown below.

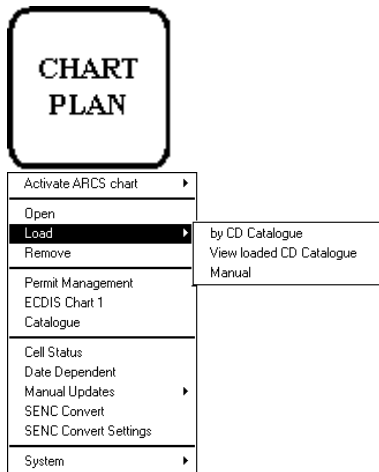
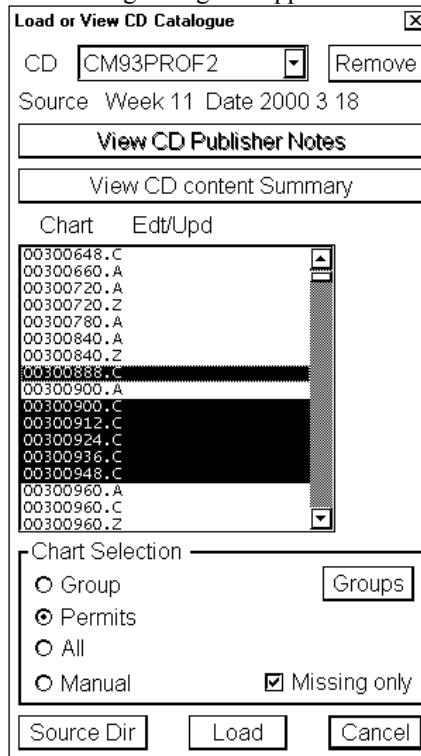

CHART PLAN push button

1. Press **CHART PLAN** push button, select **Load** from the menu and **View loaded CD Catalog...** from submenu.
2. A following dialog box appears



Select a named "CD" you want to use from CD -field. A list of charts appears into a list box.. If you want to load charts make selection here.

NOTE! You can get Summary information about charts you are going to load.

1. Press **View CD content Summary** button in the S57 Load dialog box.
2. A text processing program shows text information about selected named "CD Catalog" . You can get Edition number, issue date of base cells and updates in this window.
3. If you want to make a hard copy of Catalog Summary, select **Print** in the **File** menu.
4. To close this program, select in **Exit** in the **File** menu.

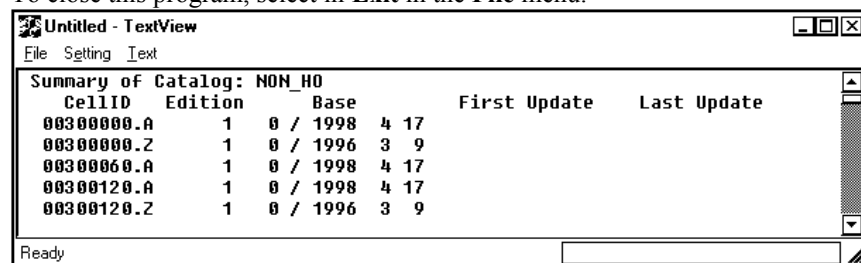

Catalogue of S57 cells with C-MAP charts

A S57 catalogue is used to view your cells stored into the hard disk or named "CD catalogues". You view limits of cells in S57 Catalog window. It is possible to pick any cell by going over its limit using the cursor and then see the information (cell ID, update's number) of it.

Mon.Route	Plan Route	Pilot Data	Predictor 60 sec	North Up	RM	TrueVect 12 min
UserChart	Ref Target	ARPA 2 Radar FEC_1	Non ENC Data	Ship off screen		

Catalogue		59°17.064'N Gyro 240.0°
		022°02.243'E COG 240.0°
WGS 84 (pos)		SOG 17.2 Kt
Plan Speed	Kt	To WP
Plan	°	Dist WOP nm
Route	°	Time
Ch limit	m	Next WP
Off track	m	Next
		Turn rad nm
		Turn rate °/min

View filters	
<input checked="" type="checkbox"/> Name	Navigation purpose
<input type="checkbox"/> Permit	<input type="checkbox"/> Overview
<input type="checkbox"/> RENC Canceled Charts	<input checked="" type="checkbox"/> General
<input type="checkbox"/> Group Charts	<input checked="" type="checkbox"/> Coastal
<input checked="" type="checkbox"/> Catalogue Charts	<input type="checkbox"/> Approach
<input type="radio"/> RENC <input type="radio"/> SENC	<input type="checkbox"/> Harbour
<input checked="" type="radio"/> CD CM93PROF1	<input type="checkbox"/> Berthing

Selected chart	
Cell ID:	
<input type="checkbox"/> Permit <input type="checkbox"/> SENC	
Cell Status Open	

Group	
Edit france	Groups
Add Frame Remove Frame Done Cancel	
Previous	

Cursor	
From Own Ship:	3469.2 nm 144.6°
12°09.002'N 065°46.102'E	

05.04.2004 10:15 UTC	05.04.2004 13:15 LOCAL TIME	MULTI	1:8 960 000	04.02 04.02
----------------------	-----------------------------	-------	-------------	----------------

View Filters -field

These fields are used to select displayed cells in S57 Catalog window. This is useful if the number of the cell has increased so much that you can not see the individual cells properly. Use filters to avoid confusion. Categories useful with C-MAP charts are follow:

- Name, if selected you see also cell names. Normally don't select with C-MAP charts.
- Permit, displays only cells for which you have permits
- Group Charts, displays only cells which are members of the active group.
- Catalog Charts, you have three option to select:
 - use CD, to view cells from a named "CD" (typically with name "NON-HO") which you have read from C-MAP CD-ROM.
- Navigation purpose, display only cells from selected navigation purposes. Categories are follow:
 - Overview
 - General
 - Coastal
 - Approach
 - Harbour
 - Berthing

Selected Chart -field

This field show information about selected cell.

- Cell ID, Cell name
- Permit, existence of a permit
- SENC, existence of SENC in your hard disk
- Ordered, if cell has been ordered but not yet received into the system.

Group -field

In S57 catalogue dialog box you have possibility to define groups of cells. This means that you can collect cells together - for example all cells, which cover a route from Liverpool to New York or all cells available from one National Hydrographic Office. This makes easier to perform many SENC maintenance functions such as loading cells and updates, setting Display and Approve dates etc.

Group of S57 cells with C-MAP charts

You can create groups of your own. This means that you define a group, which consists only those cells you are interested in. This makes easier to maintain cells, which are loaded into the system or which will be loaded into the system.

How to create a group

To create user defined group, proceed as follows:

1. Press CHART PLAN push button.
2. Select **Catalog** from the menu. S57 Catalog dialog box appears.
3. Press **Groups...** button in group -field. A Chart Group dialog box appears.
4. Press **New...** button, define a name for new chart group using “type writer”, press **OK** button when ready.

Entered group name appears to **Edit group** -field. Now you can define chart cells which are included to this group.

How to add new cells into a group

You can add new cells into your group by framing desired area.

The screenshot shows the S77 software interface. At the top, there is a menu bar with options: Mon.Route, Plan Route, Pilot Data, Predictor 60 sec, North Up, RM, TrueVect 12 min, UserChart, Ref Target, ARPA 2 Radar FEC_1, Non ENC Data, and Ship off screen. Below the menu bar is a large chart area displaying a grid of cells. A black rectangular frame is drawn around a portion of the grid. To the right of the chart is a control panel with the following information:

- 59°17.064'N Gyro 240.0°
- 022°02.243'E COG 240.0°
- WGS 84 (pos)
- FILTER HIGH SOG 17.2 Kt
- Plan Speed Kt
- Plan °
- Route °
- Ch limit m
- Off track m
- To WP
- Dist WOP nm
- Time
- Next WP
- Next °
- Turn rad nm
- Turn rate °/min

Below the chart area, there is a 'Catalogue' panel with the following options:

- View filters:
 - Name
 - Permit
 - RENC Canceled Charts
 - Group Charts
 - Catalogue Charts
 - RENC
 - SENC
 - CD
- Navigation purpose:
 - Overview
 - General
 - Coastal
 - Approach
 - Harbour
 - Berthing
- Selected chart:
 - Cell ID:
 - Permit
 - SENC
 - Cell Status
 - Open
- Group:
 - Edit: c-map
 - Groups
 - Add Frame
 - Remove Frame
 - Done
 - Cancel
 - Previous
- Cursor:
 - From Own Ship: 3469.2 nm 144.6°
 - 12°09.002'N 065°46.102'E

At the bottom of the interface, there is a status bar with the following information:

- 05.04.2004 10:15 UTC
- 05.04.2004 13:15 LOCAL TIME
- MULTI
- 1:8 960 000
- 04.02
- 04.02

After you have entered name for group, press **Add frame...** button in S77 catalog dialog box. After that you can make a frame in S77 window moving cursor desired location and pressing **SELECT** push button. Cells which are inside a frame or intersect a frame limit are added into the group. When your frame is ready press **Done** button in S77 dialog box. Chart cells which are selected into defined group are displayed in **Inside** list box in Chart group dialog box.

The screenshot shows the S57 Group dialog box. It has a title bar 'S57 Group' and a close button. The interface includes:

- Edit group: c-map
- Buttons: Save, Save As Text..., Remove, Deselect
- Inside list box:
 - 02700720.Z P
 - 02700840.Z P
 - 03300780.A P
 - 03300810.B P
 - 03300840.A P
 - 03300840.B P
 - 03600810.B P
 - 03600840.B P
 - 03600870.R P
- Outside list box:
 - 00300000.A
 - 00300000.Z
 - 00300060.A
 - 00300120.A
 - 00300120.Z
 - 00300180.A
 - 00300240.A
 - 00300240.Z
 - 00300300.A
- Buttons: >>, <<
- Permit checkbox
- New... button
- Active Group: non-ho
- Buttons: Set, Reset

You can also add chart cell to your group by using << (add) button. To add cell, select (highlight) cell ID in **Outside** list box and then press << button.

Note! If you select **Permit** check box, the system will display only chart cells for which you have permits.

When you are satisfied with selection you have done, press **Save** button to save defined group.

You can save your chart cells also into text file, if you like to have a list of chart cells in text format. To do this press **Save As Text...** button. A “Save As” dialog box appears.

Select directory and drive to where you want save your group. You can use Windows NotePad application to view and to make a hard copy from the list of group.

NOTE. It is strongly recommended that you do not use Overview and General scale charts from C-MAP unless you have good reason because the ECDIS includes an optimised world wide coverage of small scale charts for these navigation purposes. If you load all Overview and General scale charts from C-MAP then the ECDIS will use a lot of time for chart drawing and other things.

How to remove cells from a group

You can remove chart cells from a defined group. To remove proceed as follows:

1. Press CHART PLAN push button. Select **Catalog** from the menu.
2. Press **Groups...** button in S57 Catalog dialog box. A Chart group dialog box appears.
3. Select desired group from **Edit group** list box.
4. Select desired chart cell(s) from Inside list box.
5. Press >> button. Selected Chart cell is removed to Outside list box and it is no more member of defined group.

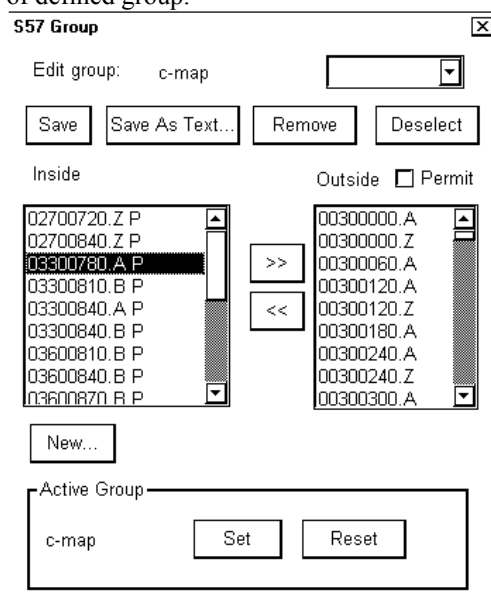

How to delete a group

You can delete a defined group. To remove proceed as follows:

1. Press CHART PLAN push button. Select **Catalog** from the menu.
2. Press **Groups...** button in S57 Catalog dialog box. A Chart group dialog box appears.
3. Select desired group from **Edit group** list box.
4. Press **Remove** button. Confirm deleting a group, press **OK**.

How to select active group for viewing with catalog

To select active group proceed as follows:

1. Press CHART PLAN push button. Select **Catalog** from the menu.
2. Press **Groups...** button in S57 Catalog dialog box. A Chart group dialog box appears.
3. Select desired group from **Edit group** list box.
4. In **Active Group** -field press **Set** button. The name of active group appears to **Active Group** -field.

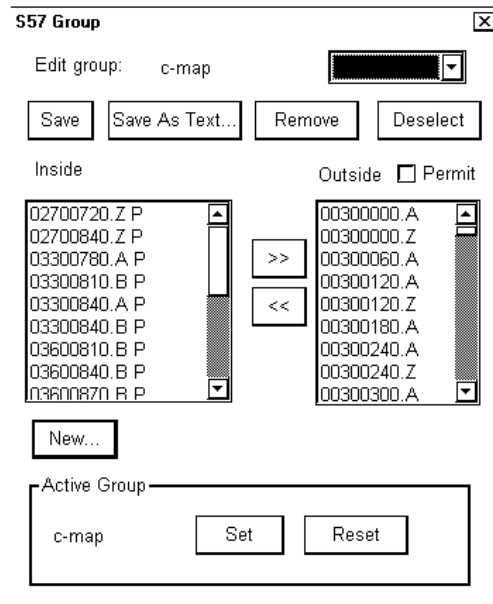

How to make conversion into SENC and set display date automatically with C-MAP charts

When you are loading new C-MAP charts into hard disk, it is possible make automatic conversion into the SENC format. It is also possible to set display date as system's current date automatically. Proceed as follows to set these options:

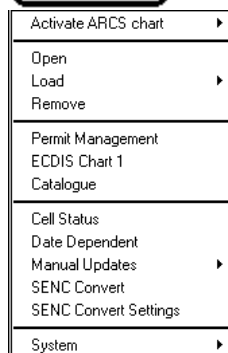

1. Press CHART PLAN button, select **SENC Convert Settings** from the menu.
2. A S57 Settings dialog box appears:

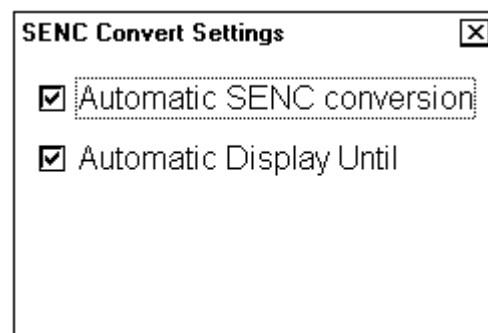

Select on **Automatic SENC Conversion** and **Automatic Display Until** options.

How to remove C-MAP charts from the system

To remove C-MAP charts from the system, proceed as follows:

1. From the Control panel press Chart Plan push button.

2. Select **Remove** command from the menu. There will appear a chart list dialog.
3. Select desired chart cells to remove them from the system. You can remove native data (A, B, C, D; E, F or Z) or SENC format (snc).

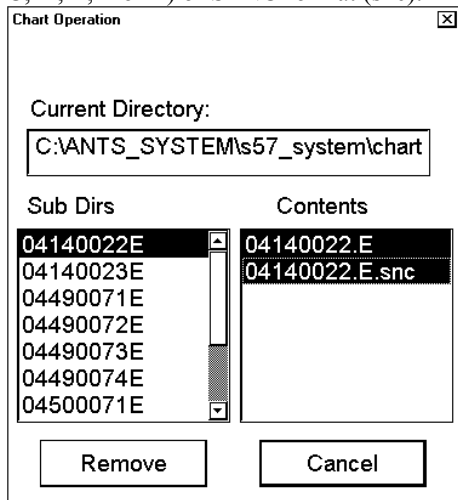

4. Press **Remove** button. System will remove files from the hard disk.

How to view status and history of C-MAP charts by a group

You can view status and history of C-MAP charts . To view status and history, proceed as followed:

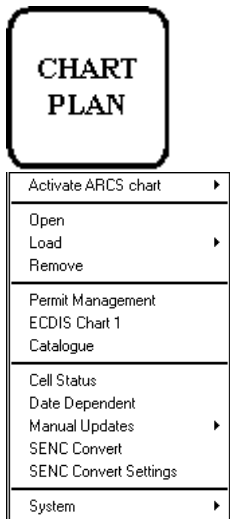

1. Press CHART PLAN push button and select **Date Dependent** from the menu.
2. A Date Dependent dialog box appears.

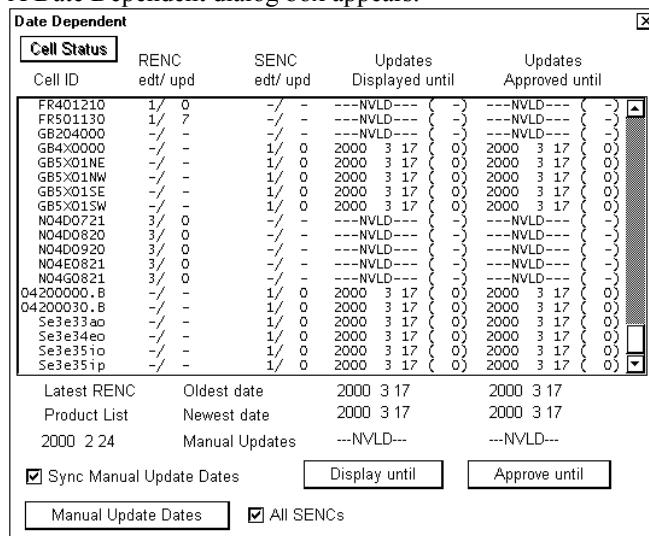

Latest RENC Product List: Not in use with C-MAP.

Updates displayed until: View the date until updates is displayed. You can enter desired date by using **Display until** button. The number after date shows the number of updates involved to displayed .

Updates approved until: View the date until updates is approved. You can enter desired date by using **Approve until** button.

Appendix 4

Route backup & restore in ASCII format

Sometimes it is useful to save some information of Route as ASCII text file to be used with some other application, or if you like to restore some ASCII text produced by some other application to ECDIS. ECDIS can generate a ASCII text file from a Route. ECDIS can also generate a Route from an ASCII text file. Following formats for Route Backup & Restore are available:

1. ASCII PROPRIETARY,
2. ASCII POSITION, list of Latitude/Longitude values
3. ASCII WPNAME POSITION, list of WP names and Latitude/Longitude
4. ASCII POSITION WPNAME list of Latitude/Longitude and WP names
5. ASCII FULL, all route related information

To make backup from a route in ASCII format, proceed as follows:

1. From Control Panel select ROUTE PLAN pushbutton.
2. From menu select **Backup and Restore** command. There will appear Backup & Restore dialog box in the Dialog box area.
3. In the Hard disk -field select desired file and select desired **Backup Format**.
4. Select backup drive in **Backup device** -field. Press **Backup** button in Hard Disk -field.

To restore route, proceed as follows:

1. From Control Panel select ROUTE PLAN pushbutton.
2. From menu select **Backup and Restore** command. There will appear Backup & Restore dialog box in the Dialog box area.
3. Select desired **Backup Format**.
4. Select backup drive in **Backup device** and select desired file.
5. Press **Restore** button in Backup Device -field.

An example to move ECDIS Route data into an Excel file

There is an example how to import Waypoints' name and Latitude/Longitude values to Microsoft Excel table.

```

PLAN SUMMARY HKI-OUT      31.03.2004 09:19 Datum: WGS 84

WP  LAT      LON      SPD  CRS  M  LEG  REMAIN  ETA (UTC+ 3)  HFO  DO
-----
1  60°10.060'N 024°59.013' E  8.0 141.1 R  0.8  10.2  31.Mar.2004 09:00  0  0
   "  FIRST"
2  60°09.392'N 025°00.092' E 10.0 192.3 R  3.0   9.4  31.Mar.2004 09:06  0  0
   "  NELJA"
3  60°06.408'N 024°58.784' E 15.0 188.1 R  6.4   6.4  31.Mar.2004 09:24  0  0
   "  ADOLF"
4  60°00.121'N 024°56.992' E           31.Mar.2004 09:49  0  0
   "  ADOLF 2"

Optimized for Maximum speed

plan      hour      nm
($)      ($/h)      ($/nm)
Income :      0.0      0.0      0.0
Cost :      0.8      1.0      0.1
Profit :     -0.8     -1.0     -0.1

Hfo :      (ton)      (ton/h)      (kg/nm)
Do :      0.0      0.0      0.0

ETD from waypoint 1 (UTC+ 3) 31.Mar.2004 09:00 FIRST
ETA to waypoint 4 (UTC+ 3) 31.Mar.2004 09:49 ADOLF 2

Length : 10.2 nm
Time : 0.8 h

END OF DATA
    
```

Above is shown a source of route as "WP Report" of Route Planning.

1. Press ROUTE PLAN button on Control Panel and select **Restore & Backup** from the menu.
2. In **Backup and Restore** window, in Hard disk -field select desired Route (HKI-OUT) and select desired **Backup Format** (ASCII WPNAME POSITION).
3. Select backup drive (A:) in **Backup device** -field and insert floppy disk into drive. Press **Backup** button in Hard Disk -field.
4. Move floppy to computer where you can run Notepad and MS Excel applications.
5. Activate Notepad and open a route

```

NAME  LAT      LON
FIRST 60 10.060 N 024 59.013 E
NELJA 60 09.392 N 025 00.092 E
ADOLF 60 06.408 N 024 58.784 E
ADOLF 2 60 00.120 N 024 56.991 E
    
```

Content of Notepad looks something like this.

6. You can copy text to clipboard (First Edit>Select All and then Edit>Copy)
7. Activate MS Excel and copy text from clipboard to MS Excel (Edit>Paste)

	A	B	C	D	E	F
1	NAME	LAT	LON			
2	FIRST	60 10.060 N	024 59.013 E			
3	NELJA	60 09.392 N	025 00.092 E			
4	ADOLF	60 06.408 N	024 58.784 E			
5	ADOLF 2	60 00.120 N	024 56.991 E			
6						
7						
8						

Content of MS Excel looks something like this.

An example to move Route data from Excel file into ECDIS

There is an example how to import Waypoints' name and Latitude/Longitude values from Microsoft Excel table into ECDIS.

1. In MS Excel you have information copy desired columns to clipboard from MS Excel (first highlight data in MS Excel and then select Edit>Copy)

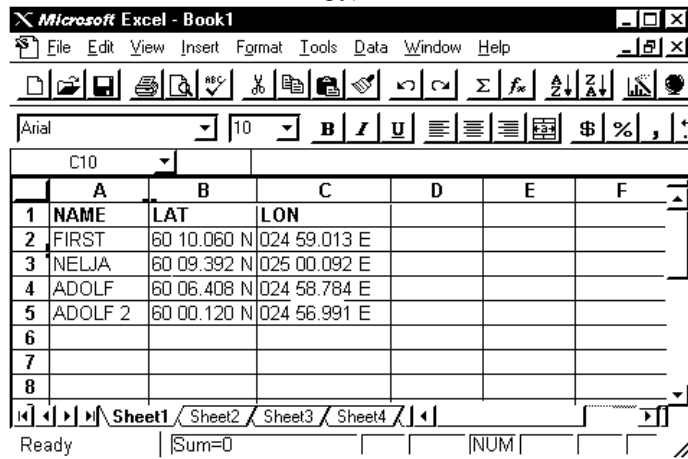

Content of MS Excel may look something like this.

2. You can paste text to Notepad (First activate Notepad then select Edit>Paste)

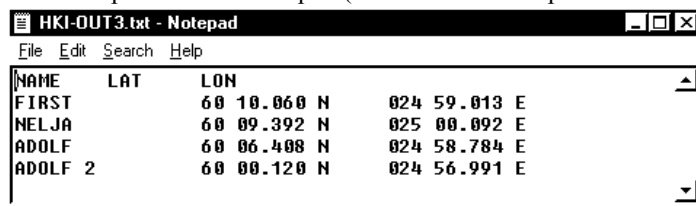

Content of Notepad looks something like this.

3. Press ROUTE PLAN button on Control Panel and select **Restore & Backup** from the menu.
4. In **Backup and Restore** window, in Hard disk -field select desired **Backup Format** (ASCII WPNAME POSITION).
5. Insert floppy disk into drive and select backup drive (A:\) in **Backup device** -field. Select desired route in list box of Backup device and then press **Restore** button .

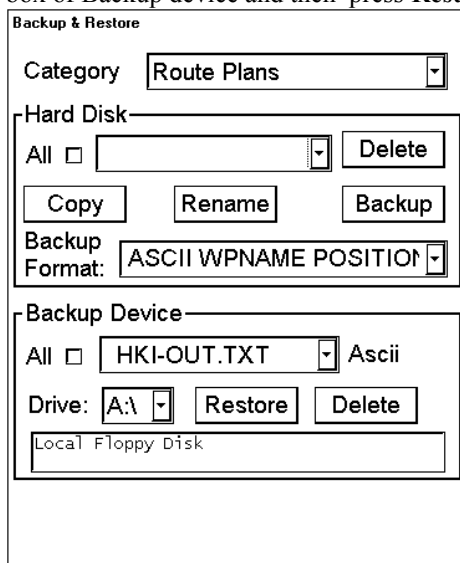

6. ECDIS generates new route which has same name as text file (HKI-OUT).

PLAN ROUTE - HKI-OUT / 08.04.2004 13:27

WP Alarms Check Params Prepare

Waypoint

1 Total 4 0.0 nm

Name: START Steering mode: Rhumb line

Radius: 1.0 nm Channel limit: 185 m

Position: Lat 05°01.005'N Lon 000°00.040'E

Speed: Min 0 Kt Max 18 Kt

First << >> Last

Insert Next WP Delete

Import Reverse

Enable changes Partly Displayed

From text file HKI-OUT.TXT

Steering mode: default = Rhumb line
 Channel limit: default = 185 m
 Speed Min: default = 0 Kt

SHIP and ROUTE PARAMETERS

Ship parameters

Ship max. speed	18.0	Kt
Ship max. height	34.0	m
Ship draught	10.0	m
Gyro error correction	Auto	
Gyro spd/lat error	On	
Max gyro error correction	3.0	°
Manual gyro correction	0.2	

Route parameters

Max rate of turn	200	°/min
Turn end tolerance	2	°
WP approach alarm time	60	s
WP prewarn alarm time	120	s
Route start limit angle	20	°
Default line radius	0.3	nm
Drift compensation	On	
Gyro error compensation	Off	

Above is example in where you can see which fields are from HKI-OUT.TXT file and which fields are using default values generated by the ECDIS.

Appendix 5

Declaration of conformity

Declaration of conformity (Pub NO. DOC-101) is attached in Appendix 5

EC type examination (module B) certificate

EC type examination (module B) certificate for ECDIS is attached in Appendix 5.

EC quality system (module D) certificate

EC quality system (module D) certificate for ECDIS is attached in Appendix 5.

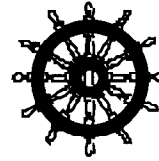
Declaration of conformity**0735**We **FURUNO FINLAND Oy**

(Manufacturer)

Olarinluoma 19, Espoo 02200, Finland

(Address)

hereby declare under our sole responsibility that the product

Electronic Chart Display and Information System (ECDIS) Product name EC-1000; Trade name EC 1000,
EC 1000B and FEA-2105 (for details, see Configuration matrix at page 2/2 of this Declaration)

(Model names, type numbers)

to which this declaration relates conforms to the following standard(s) or normative document(s)

IMO Resolution A.817(19) EN 61174: 2002 (IEC 61174 2nd edition: 2001-10)

IMO Resolution A.694(17) EN 60945: 1997 (IEC 60945 3rd edition: 1996-11)

IMO Resolution MSC.97(73) 13.17.1, 13.8 (2000 HSC Code)

SOLAS 74 Regulation V/18/1, Reg. V/19.2.1.4, Reg. V/19.2.1.5

EN 61162-1 (IEC 61162-1 2nd edition: 2000-07)

EN 61162-2 (IEC 61162-2 1st edition: 1998-09)

(title and/or number and date of issue of the standard(s) or other normative document(s))

For assessment, see:

- EC TYPE EXAMINATION (MODULE B) CERTIFICATE No. 6579/080297/2003 of 22 May 2003 issued by Federal Maritime and Hydrographic Agency, The Federal Republic of Germany
- EC QUALITY SYSTEM (MODULE D) CERTIFICATE BSH-044-06-2003-4.30/1 of 27 June 2003 issued by Federal Maritime and Hydrographic Agency, The Federal Republic of Germany
- Test reports BSH Nos. 6579/080 281/2002/S3330, 6542/080 168/00, 6542/080 143/99, 6542/080 208-0/01, 6542/080 286/2002/S3330, 6542/080 282/2002/S3330, 6542/080 263/2002/S3330, 6542/080278/2002/S3330, 6542/080 255/2002/S3330, 6542/080 277/2002/S3330, 6542/080 297-1/2002/S3330, 6542/080 297-2/2002/S3330 prepared by Federal Maritime and Hydrographic Agency, The Federal Republic of Germany
- Test reports Nos. FLI 12-02-033 of 30 August 2002, FLI 12-99-024 of 6 October 1999 and FLI 12-99-035 of 25 October 1999 prepared by Furuno Labotech International Co., Ltd.

This declaration is issued according to the provisions of European Council Directive 96/98/EC on marine equipment amended by the Commission Directive 2002/75/EC.

On behalf of Furuno Finland Oy

Espoo, Finland

May 7, 2004

Ari Loikkanen

General Manager

(Place and date of issue)

(name and signature or equivalent marking of authorized person)

Configuration matrix of EC 1000, EC 1000B, FEA-2105

(This is part of the Declaration of Conformity DOC-101)

Device	Type	Comments	Conditions
Main processing units			
ECDIS electronic unit	EC 1000	Software version: 4.xx to display and use digital chart in the following formats: <ul style="list-style-type: none"> • S-57 (IHO) • ARCS (UK-HO) • CM-93/2 (C-MAP) and the operation mode CONNING	Optionally one conning display may be connected to each ECDIS electronic unit in addition to the ECDIS display.
ECDIS electronic unit	EC 1000B		
Display units			
21" FURUNO CRT Colour monitor	FEA-2105	Console or desktop version	One colour display for each electronic unit
21" CONRAC CRT Colour monitor	9521		
21" CONRAC CRT Colour monitor	9821 E		
20" CONRAC TFT Colour monitor	5120 SCD		
21" Hatteland CRT Colour monitor	JH21C06		
19" Hatteland TFT Colour monitor	JH19T01 MMD-E		
20" Hatteland TFT Colour monitor	JH20T03 MMD-E		
20" Hatteland TFT Colour monitor	JH20T04 MMD-E		
23" Hatteland TFT Colour monitor	JH23T02 MMD-E		
19" ISIC TFT Colour monitor	MON1900M		
20" ISIC TFT Colour monitor	MON2000M		
23" ISIC TFT Colour monitor	MON2300M		
17.4" TFT Colour monitor	JH17T01 MMD	Console or desktop version	For use as display unit for the operation as CONNING and/or: as slave display unit without operating unit
15" TFT Colour monitor	JH15T03 MMD		
Operating units			
ECDIS control panel	301050	Console or desktop version	Each ECDIS electronic unit has to be equipped with one ECDIS operating and control panel (operating unit).
Additional devices			
Sensor interface connection box	A-ADAPTER		at least 1 (one) up to 2 (two) for each ECDIS electronic unit
Sensor interface connection box	B-ADAPTER		operational 1 (one) for each ECDIS electronic unit



Bundesrepublik Deutschland

Federal Republic of Germany

Bundesamt für Seeschifffahrt und Hydrographie

Federal Maritime and Hydrographic Agency



BUNDESAMT FÜR
SEESCHIFFFAHRT
UND
HYDROGRAPHIE

EC TYPE EXAMINATION (MODULE B) CERTIFICATE

This is to certify that:

Bundesamt für Seeschifffahrt und Hydrographie, specified as a "notified body" under the terms of „Schiffssicherheitsgesetz" of 9. September 1998 (BGBl. I, p. 2860) modified last 19. December 2002 (BGBl. I, p. 4690), did undertake the relevant type approval procedures for the equipment identified below which was found to be in compliance with the Navigation requirements of Marine Equipment Directive (MED) 96/98/EC as modified by Directive 2002/75/EC.

Applicant **FURUNO NAVINTRA Oy.**
 Address **Olarinluoma 19, P.O. Box 11, 02201 Espoo, FINLAND**

Manufacturer **FURUNO NAVINTRA Oy.**
 Address **Olarinluoma 19, P.O. Box 11, 02201 Espoo, FINLAND**

Annex A.1 Item **4.30, Electronic Chart Display and Information System (ECDIS)**
 (No & Item designation)

Product Name **EC 1000**

Trade Name(s) **EC 1000, EC 1000B, FEA-2105**

Specified Standard(s)

IMO Resolution A.817(19)	IEC 61174 (2001), ECDIS, Edition 2
IMO Resolution A.694 (17)	IEC 60945 (1996), Environmental conditions, Edition 3
IMO Resolution MSC.97 (73) 13.17.1, 13.8 (2000 HSC Code)	IEC 61162-1 (2000), Serial Interface, Edition 2
SOLAS Regulation V/18.1, V/19.2.1.4, V/19.2.1.5	IEC 61162-2 (1998), Serial Interface, Edition 1

This certificate remains valid unless cancelled, expired or revoked.

Date of issue: 22. May 2003

Issued by: **Bundesamt für Seeschifffahrt und Hydrographie
Bernhard-Nocht-Str. 78, 20359 Hamburg, Germany
Notified body 0735**

Expiry date: ---

Certificate No.: **6579 / 080297 / 2003**

This certificate consists of 2 pages.

by order



Dr. Mathias Jonas
Dr. Mathias Jonas



Components necessary for operation:

See Annex to EC type examination (Module B) certificate No.: 6579 / 080 297 / 2003

Approval Documentation:

BSH Testreport No. 6579 / 080281 / 2002 / S3330

- Operators Manual ECDIS EC 1000
Document No. 801012,
Issue date 15.05.2003, containing references to software version 04.00
- Operators Manual ECDIS EC 1000 with Conning Display and Steering interface
Document No. 801010
Issue dated from 15.05.2003 containing references to software version 04.00
- Technical Manual ECDIS EC 1000 / ECDIS EC 1000B
Document No. 802012
Issue dated from 15.05.2003 containing references to software version 04.00
- Technical Manual ECDIS EC 1000 / ECDIS EC 1000B
with Conning Display and Steering interface
Document No. 802009
Issue dated from 15.05.2003 containing references to software version 04.00

Reports for IEC 60945 tests, see Annex to EC type examination (Module B) certificate No.: 6579 / 080 297 / 2003

Limitations on the acceptance or use of the product:

See Annex to EC type examination (Module B) certificate No.: 6579 / 080 297 / 2003

Places of production:

FURUNO NAVINTRA Oy. (Ltd.)
Olarinluoma 19
02201 Espoo
FINLAND

FURUNO ELECTRIC Co.
Besho-cho Tomoe
Miki-city, 673-0443
JAPAN

Notes:

The manufacturer shall inform Bundesamt für Seeschifffahrt und Hydrographie, as the notified body, of any modifications to the type-tested product(s) that may affect compliance with the requirements or conditions laid down for use of the product(s).

In case the specified regulations or standards are amended during the validity of this certificate, the product(s) must be re-certified before being placed on board vessels to which such amended regulations or standards apply.

The Mark of Conformity (wheelmark) may only be affixed to the type approved equipment, and a Manufacturer's Declaration of Conformity may only be issued, if the product quality system fully complies with the Marine Equipment Directive and is certified by a notified body against ANNEX B module D, E, or F of the Directive.

Example for the Application of the "Mark of Conformity":

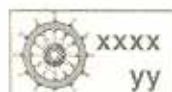

xxxx number of the Notified Body responsible for quality surveillance module
yy Last two digits of the year in which the mark is affixed.

Notice on legal remedies available:

Objection to this document may be filed within one month after notification. The objection must be filed in writing to, or put on record at, Federal Maritime and Hydrographic Agency, Bernhard-Noch Str. 78, 20359 Hamburg, Germany

ANNEX TO EC TYPE EXAMINATION (MODULE B) CERTIFICATE No.: 6579 / 080 297 / 2003

Components necessary for operation:

Device	Type	Comments	Conditions
main processing units (alternatively)			
ECDIS electronic unit	EC 1000	Software version: 4.xx to display and use digital chart data in the following formats: <ul style="list-style-type: none"> • S-57 (IHO), • ARCS (UK-HO) • CM-93/2 (C-MAP) and the operation mode CONNING	Optionally one Conning display may be connected to each ECDIS electronic unit in addition to the ECDIS display.
ECDIS electronic unit	EC 1000 B		
Display units (alternatively)			
21" FURUNO CRT Colour-Monitor	FEA-2105	Console- or desktop version	One colour display for each electronic unit
21" CONRAC CRT Colour-Monitor	9521		
21" CONRAC CRT Colour-Monitor	9821 E		
20" CONRAC TFT Colour-Monitor	5120 SCD		
21" Hatteland CRT Colour-Monitor	JH21C06		
19" Hatteland TFT Colour-Monitor	JH19T01 MMD-E		
20" Hatteland TFT Colour-Monitor	JH20T03 MMD-E		
20" Hatteland TFT Colour-Monitor	JH20T04 MMD-E		
23" Hatteland TFT Colour-Monitor	JH23T02 MMD-E		
19" ISIC TFT Colour-Monitor	MON1900M		

Device	Type	Comments	Conditions
Display units (alternatively)			
20" ISIC TFT Colour-Monitor	MON2000M	Console- or desktop version	For use as display unit for the operation as CONNING and / or: as slave display unit without operating unit
23" ISIC TFT Colour-Monitor	MON2300M	Console- or desktop version	
17.4" TFT Colour Monitor	JH17T01 MMD	Console- or desktop version	
15" TFT Colour Monitor	JH15T03 MMD	Console- or desktop version	
Operating units (alternatively)			
ECDIS control panel	301050	Console- or desktop version	Each ECDIS electronic unit has to be equipped with one ECDIS operating and control panel (operating unit).
Additional devices			
Sensor interface connection box	A-ADAPTER		at least 1 (one) up to 2 (two) for each ECDIS electronic unit
Sensor interface connection box	B-ADAPTER		optional 1 (one) for each ECDIS electronic unit

Approval documentation:

Testreport BSH No. 6579/080 281/2002/S3330	
Testreport Furuno Labotech International Co., Ltd., No. FLI 12-02-033, 30.08.2002	
Testreport Furuno Labotech International Co., Ltd., No. FLI 12-99-024, 06.10.1999	
Testreport Furuno Labotech International Co., Ltd., No. FLI 12-99-035, 25.10.1999	
Testreport BSH No. 6542/080 168/00,	Display unit (9821 E)
Testreport BSH No. 6542/080 143/99	Display unit (9521)
Testreport BSH No. 6542/080 208-0/01,	Display unit (JH21C06)
Testreport BSH No. 6542/080 286/2002/S3330,	Display unit (JH23 T02 MMD-E)
Testreport BSH No. 6542/080 282/2002/S3330,	Display unit (JH20 T04 MMD-E)
Testreport BSH No. 6542/080 263/2002/S3330,	Display unit (JH19 T01 MMD-E)
Testreport BSH No. 6542/080 278/2002/S3330,	Display unit (MON1900M)
Testreport BSH No. 6542/080 255/2002/S3330,	Display unit (MON2000M)
Testreport BSH No. 6542/080 277/2002/S3330,	Display unit (MON2300M)
Testreport BSH No. 6542/080 297-1/2002/S3330,	Display unit (JH17T01 MMD)
Testreport BSH No. 6542/080 297-2/2002/S3330,	Display unit (JH15T03 MMD)

Limitations on the acceptance or use of the product:**System interfaces:**

Data exchange with sensors, additional devices, external data receiver via:

Interface connection box type A-ADAPTER

as a minimum 3 (three) up to 8 (eight) serial interfaces for reception and transfer of data from connected sensors and radar devices according to IEC 61162-1 (Edition 2, 2000) and IEC 61162-2 (Edition 1, 1998)

and optional in addition via:

Interface connection box type B-ADAPTER

for reception and transfer of analogue data from connected sensors and radar devices according the relevant equipment standards in use.

1. for reception of sensor data at least delivered by the following sources:

1.1. for the reception of sensor data from one up to three

radio navigation receiver assessed as conform with requirements of Marine Equipment Directive (MED) 96/98/EC and marked as defined there which transmits the following information:

- geographic position,
- status of geographic position,
- speed and course over ground

1.2. for the reception of sensor data from a

gyro compass assessed as conform with requirements of Marine Equipment Directive (MED) 96/98/EC and marked as defined there which transmits the following information,

- gyro compass heading

1.3. for the reception of sensor data from a speed and distance measurement device assessed as conform with the requirements of Marine Equipment Directive (MED) 96/98/EC and marked as defined there which transmits the following information:

- speed over ground
- and /or
- speed through the water

2. and optional for the receiving of data from the following sensor devices:

2.1 to receive data from an echo sounder assessed as conform with the requirements of Marine Equipment Directive (MED) 96/98/EC and marked as defined there which transmits the following information:

- water depth

2.2 to receive environmental information from appropriate sensor devices transmitting data according IEC 61162-1 (Edition 2, 2000):

- wind speed and wind direction

2.3. to receive data from one up to three:

Radar/ARPA device assessed as conform with the requirements of Marine Equipment Directive (MED) 96/98/EC and marked as defined there which transmits the following information:

- track data of ARPA targets,
- own ship data,

2.4 to receive and display of Radar-video signals from one up to three of the following Radar devices:

RADAR/ARPA devices of company Furuno Electric Co. Ltd., Japan assessed as conform with the requirements of Marine Equipment Directive (MED) 96/98/EC and marked as defined:

- Furuno FAR 28x5
- Furuno FR 21x5

2.5 to receive and display data from one

AIS Transponder assessed as conform with requirements of Marine Equipment Directive (MED) 96/98/EC as modified by Directive 2002/75/EC and marked as defined there which transmits the following information:

- Information about other ships within the operating area received by AIS,
- information about aids to navigation within the operating area received by AIS,

Note: AIS information to be displayed according IMO guideline SN/Circ.217, 11. July 2001

2.6 for the data exchange with up to three additional Electronic chart display and information system (ECDIS) type: EC 1000
via local system area network connection (Ethernet):

- chart data,
- track data,
- system data.

3. and optional to send data for:

- geographic position,
- status of geographic position,
- own ship data,
- water depth,
- wind speed and wind direction.

Backup arrangements:

In order to continue ships navigation in the case of a primary system failure the following back up arrangements are allowed:

- Installation of a second system, of identical type EC 1000 providing at least one (1) up to eight (8) system interfaces, independently connected to a position sensor according 1.1 via one interface connection box type A-ADAPTER and connected to the primary system for transmission of route data.



Bundesrepublik Deutschland

Federal Republic of Germany

Bundesamt für Seeschifffahrt und Hydrographie

Federal Maritime and Hydrographic Agency



EC QUALITY SYSTEM (MODULE D) CERTIFICATE

Bundesamt für Seeschifffahrt und Hydrographie (Federal Maritime and Hydrographic Agency) as the notified body performing EC conformity assessment procedures in compliance with EC Council Directive 96/98/EC of 20 December 1996 on Marine Equipment, last amended by EC Council Directive 2002/75/EC of 2 September 2002, hereby certifies that the manufacturer

FURUNO NAVINTRA Oy.

Olarinluoma 19

02201 Espoo

Finland

maintains and applies a quality system in accordance with the requirements of the Maritime Equipment Directive annex B, module D.

Scope:

A.1/4.30 Electronic chart display and information system (ECDIS) with backup, and raster chart display system (RCDS)

References:

Module B Certificate no. 6579 / 080297 / 2003

Date of issue: 27 June 2003

Issued by: Bundesamt für Seeschifffahrt und Hydrographie

Expiry date: 30 May 2006

Identification number 0735

Registration no.: BSH-044-06-2003-4.30/1

This certificate consists of 2 pages



by order

Mühlhausen



Places of production (if different from client or where there are several)

Restrictions:

Notes:

This certificate authorises in conjunction with the EC Type Examination (Module B) Certificate of the equipment listed in the scope to affix the "Mark of Conformity" (wheelmark).

This certificate loses its validity if the manufacturer makes any changes or modifications to the approved quality system, which have not been notified to, and agreed with the notified body named on this certificate and/or after lapse of time, withdrawal or revocation of the EC Type Examination (Module B) Certificate.

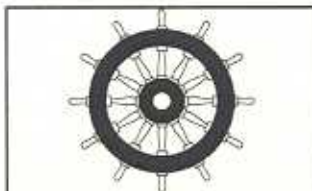
"Wheelmark" Format and application:**0735/yy**

example

yy Last two digits of the year in which mark is affixed.

0735 Notified Body number undertaking quality surveillance**Notice on legal remedies available:**

Objection to this document may be filed within one month after notification. The objection must be filed in writing to, or put on record at, Federal Maritime and Hydrographic Agency, Bernhard-Nocht-Str. 78, 20359 Hamburg, Germany

Free Manuals Download Website

<http://myh66.com>

<http://usermanuals.us>

<http://www.somanuals.com>

<http://www.4manuals.cc>

<http://www.manual-lib.com>

<http://www.404manual.com>

<http://www.luxmanual.com>

<http://aubethermostatmanual.com>

Golf course search by state

<http://golfingnear.com>

Email search by domain

<http://emailbydomain.com>

Auto manuals search

<http://auto.somanuals.com>

TV manuals search

<http://tv.somanuals.com>