

# PRIMERGY TX300 S6 Server

## Options Guide

## Comments... Suggestions... Corrections...

The User Documentation Department would like to know your opinion of this manual. Your feedback helps us optimize our documentation to suit your individual needs.

Feel free to send us your comments by e-mail to [email: manuals@ts.fujitsu.com](mailto:manuals@ts.fujitsu.com).

## Certified documentation according to DIN EN ISO 9001:2000

To ensure a consistently high quality standard and user-friendliness, this documentation was created to meet the regulations of a quality management system which complies with the requirements of the standard DIN EN ISO 9001:2000.

cognitas. Gesellschaft für Technik-Dokumentation mbH  
[www.cognitas.de](http://www.cognitas.de)

## Copyright and Trademarks

Copyright © 2010 Fujitsu Technology Solutions GmbH.

All rights reserved.

Delivery subject to availability; right of technical modifications reserved.

All hardware and software names used are trademarks of their respective manufacturers.

- The contents of this manual may be revised without prior notice.
- Fujitsu assumes no liability for damages to third party copyrights or other rights arising from the use of any information in this manual.
- No part of this manual may be reproduced in any form without the prior written permission of Fujitsu.

Microsoft, Windows, Windows Server, and Hyper V are trademarks or registered trademarks of Microsoft Corporation in the USA and other countries.

Intel and Xeon are trademarks or registered trademarks of Intel Corporation or its subsidiaries in the USA and other countries.

---

## **Before reading this manual**

### **For your safety**

This manual contains important information for safely and correctly using this product.

Carefully read the manual before using this product. Pay particular attention to the accompanying manual "Safety Notes and Regulations" and ensure these safety notes are understood before using the product. Keep this manual and the manual "Safety Notes and Regulations" in a safe place for easy reference while using this product.

### **Radio interference**

This product is a "Class A" ITE (Information Technology Equipment). In a domestic environment this product may cause radio interference, in which case the user may be required to take appropriate measures. VCCI-A

### **Aluminum electrolytic capacitors**

The aluminum electrolytic capacitors used in the product's printed circuit board assemblies and in the mouse and keyboard are limited-life components. Use of these components beyond their operating life may result in electrolyte leakage or depletion, potentially causing emission of foul odor or smoke.

As a guideline, in a normal office environment (25°C) operating life is not expected to be reached within the maintenance support period (5 years). However, operating life may be reached more quickly if, for example, the product is used in a hot environment. The customer shall bear the cost of replacing replaceable components which have exceeded their operating life. Note that these are only guidelines, and do not constitute a guarantee of trouble-free operation during the maintenance support period.

### **High safety use**

This product has been designed and manufactured for general uses such as general office use, personal use, domestic use and normal industrial use. It has not been designed or manufactured for uses which demand an extremely high level of safety and carry a direct and serious risk to life or body if such safety cannot be ensured.

---

These uses include control of nuclear reactions in nuclear power plants, automatic airplane flight control, air traffic control, traffic control in mass transport systems, medical devices for life support, and missile guidance control in weapons systems (hereafter, "high safety use"). Customers should not use this product for high safety use unless measures are in place for ensuring the level of safety demanded of such use. Please consult the sales staff of Fujitsu if intending to use this product for high safety use.

### **Measures against momentary voltage drop**

This product may be affected by a momentary voltage drop in the power supply caused by lightning. To prevent a momentary voltage drop, use of an AC uninterruptible power supply is recommended.

(This notice follows the guidelines of Voltage Dip Immunity of Personal Computer issued by JEITA, the Japan Electronics and Information Technology Industries Association.)

### **Technology controlled by the Foreign Exchange and Foreign Trade Control Law of Japan**

Documents produced by Fujitsu may contain technology controlled by the Foreign Exchange and Foreign Trade Control Law of Japan. Documents which contain such technology should not be exported from Japan or transferred to non-residents of Japan without first obtaining authorization in accordance with the above law.

### **Harmonic Current Standards**

This product conforms to harmonic current standard JIS C 61000-3-2.

### **Only for the Japanese market: About SATA hard disk drives**

The SATA version of this server supports hard disk drives with SATA / BC-SATA storage interfaces. Please note that the usage and operation conditions differ depending on the type of hard disk drive used.

Please refer to the following internet address for further information on the usage and operation conditions of each available type of hard disk drive:

<http://primeserver.fujitsu.com/primergy/harddisk/>

---

### **Only for the Japanese market:**



Although described in this manual, some sections do not apply to the Japanese market. These options and routines include:

- USB Flash Module (UFM)
- CSS (Customer Self Service)



---

# Contents

<b>1</b>	<b>Preface</b> . . . . .	<b>11</b>
<b>1.1</b>	<b>Concept and target groups</b> . . . . .	<b>12</b>
<b>1.2</b>	<b>Documentation overview</b> . . . . .	<b>12</b>
<b>1.3</b>	<b>Expansions and conversions</b> . . . . .	<b>14</b>
<b>1.4</b>	<b>Notational conventions</b> . . . . .	<b>16</b>
<b>2</b>	<b>Procedure</b> . . . . .	<b>17</b>
<b>3</b>	<b>Safety instructions</b> . . . . .	<b>19</b>
<b>4</b>	<b>Preparation</b> . . . . .	<b>27</b>
<b>4.1</b>	<b>Floorstand model</b> . . . . .	<b>28</b>
4.1.1	Opening the server . . . . .	28
4.1.2	Removing the front cover . . . . .	29
4.1.3	Removing the server feet . . . . .	31
<b>4.2</b>	<b>Rack model</b> . . . . .	<b>32</b>
4.2.1	Opening the server . . . . .	32
4.2.2	Removing the rack front cover . . . . .	34
<b>4.3</b>	<b>Removing the fan carrier</b> . . . . .	<b>35</b>
<b>5</b>	<b>Main memory</b> . . . . .	<b>37</b>
<b>5.1</b>	<b>Memory modules</b> . . . . .	<b>38</b>
<b>5.2</b>	<b>Expanding the main memory</b> . . . . .	<b>40</b>

## Contents

---

<b>6</b>	<b>Processors . . . . .</b>	<b>41</b>
<b>6.1</b>	<b>Installing a second processor . . . . .</b>	<b>42</b>
<b>6.2</b>	<b>Replacing the processor . . . . .</b>	<b>47</b>
<b>6.3</b>	<b>Replacing the heat sink . . . . .</b>	<b>52</b>
<b>7</b>	<b>Accessible drives and LSD/LSP . . . . .</b>	<b>53</b>
<b>7.1</b>	<b>Equipping of the bays . . . . .</b>	<b>54</b>
<b>7.2</b>	<b>Accessible 5.25-inch drive . . . . .</b>	<b>56</b>
7.2.1	Removing the dummy cover . . . . .	56
7.2.2	Installing an accessible 5.25-inch drive . . . . .	58
<b>7.3</b>	<b>Multibay 1 . . . . .</b>	<b>59</b>
7.3.1	Equipping Multibay 1 . . . . .	59
7.3.1.1	Installing LSP or LSD . . . . .	59
7.3.1.2	Installing a slimline DVD drive . . . . .	61
7.3.2	Installing Multibay 1 . . . . .	64
<b>7.4</b>	<b>HDD extension box . . . . .</b>	<b>68</b>
7.4.1	Multibay 2 . . . . .	69
7.4.1.1	Installing Multibay 2 . . . . .	70
7.4.2	2.5-inch HDD extension box . . . . .	72
7.4.2.1	Installing 2.5 inch HDD extension box . . . . .	73
<b>8</b>	<b>Expansion cards and BBU . . . . .</b>	<b>75</b>
<b>8.1</b>	<b>Installing expansion cards . . . . .</b>	<b>76</b>
<b>8.2</b>	<b>Installing a BBU . . . . .</b>	<b>79</b>
<b>9</b>	<b>Further options . . . . .</b>	<b>93</b>
<b>9.1</b>	<b>TPM . . . . .</b>	<b>93</b>
<b>9.2</b>	<b>USB Flash Module (UFM) . . . . .</b>	<b>96</b>
<b>10</b>	<b>Conversion from a floorstand model to a rack model . . . . .</b>	<b>99</b>

---



---

<b>11</b>	<b>Completion</b>	<b>105</b>
<hr/>		
<b>11.1</b>	<b>Installing the fan carrier</b>	<b>105</b>
<b>11.2</b>	<b>Floorstand model</b>	<b>107</b>
11.2.1	Mounting the server feet	107
11.2.2	Attaching the front cover	108
11.2.3	Closing the server	110
<b>11.3</b>	<b>Rack model</b>	<b>111</b>
11.3.1	Attaching the rack front cover	111
11.3.2	Closing the server	112
<b>12</b>	<b>Appendix</b>	<b>115</b>
<hr/>		
<b>12.1</b>	<b>Cabling</b>	<b>115</b>
<b>Index</b>		<b>121</b>

---

# Contents

---

---

# 1 Preface

With top dual processor performance, the PRIMERGY TX300 S6 tower server is an all-purpose server for medium sized companies and branches of large enterprises. The system is ideal for use as a versatile business server for business critical applications and dedicated tasks. Thanks to internal SAS/SATA hard disk capacity of up to 6 or 8 TB, the PRIMERGY TX300 S6 is also suitable for use as a platform for highly data intensive solutions. Furthermore, it is the ideal solution for smaller mySAP installations and directory or cache services in medium sized and large companies.

The PRIMERGY TX300 S6 offers a balanced architecture that incorporates next generation main memory (DDR3) and I/O technologies (PCIe Gen2). The HDD backplane is already provided for SAS 2.0 and 6 Gbit/s SAS and the chipset prepared for the next generation of 6-core processors. High performance, scalability, impressive reliability and excellent extension options are combined in a powerful design.

The Cool-safe™ cooling concept with improved air flow cooling technology (honeycomb design) ensures the highest possible performance of the processors at work; at the same time, the system is extremely reliable thanks to the reduced heat dissipation.

The new PRIMERGY TX300 S6 can also be converted quickly and easily into a space-saving rack system that only takes up 4 height units (HU).

## 1.1 Concept and target groups

This Options Guide shows you how to extend and upgrade your server.



### CAUTION!

The activities described in this manual may only be performed by technical specialists.



The installation and removal of the hot-plug components is described in the Operating Manual supplied with the server.

## 1.2 Documentation overview

More information on your PRIMERGY TX300 S6 can be found in the following documents:

- "Quick Start Hardware - PRIMERGY TX300 S6" leaflet  
"はじめにお読みください -PRIMERGY TX300 S6" for the Japanese market  
(only included as a printed copy)
- "Quick Start Software - Quick Installation Guide" DVD booklet  
(only included with the PRIMERGY ServerView Suite as a printed copy)  
except for the Japanese market
- "Safety notes and other important information" manual  
"安全上の注意およびその他の重要情報" for the Japanese market
- "Warranty" manual  
"保証書" for the Japanese market
- "PRIMERGY ServerView Suite Local Service Concept - LSC" manual
- "Returning used devices" manual and "Service Desk" leaflet  
"サポート&サービス" for the Japanese market
- "PRIMERGY TX300 S6 Server Operating Manual"
- "PRIMERGY TX300 S6 Server Options Guide"
- "System Board D2619-N for PRIMERGY RX/TX300 S6 Technical Manual"
- "D2619-N BIOS Setup Utility for PRIMERGY RX300 S6 and TX300 S6" manual



PRIMERGY manuals are available in PDF format on the ServerView Suite DVD 2. The ServerView Suite DVD 2 is part of the ServerView Suite supplied with every server.

If you no longer have the ServerView Suite DVDs, you can obtain the relevant current versions using the order number U15000-C289 (the order number for the Japanese market: please refer to the configurator of the server <http://primeserver.fujitsu.com/primergy/system.html>).

The PDF files of the manuals can also be downloaded free of charge from the Internet. The overview page showing the online documentation available on the Internet can be found using the URL (for EMEA market): <http://manuals.ts.fujitsu.com>. The PRIMERGY server documentation can be accessed using the *Industry standard servers* navigation option.

For the Japanese market please use the URL:  
<http://primeserver.fujitsu.com/primergy/manual.html>.

#### Further sources of information:

- PRIMERGY Abbreviations and Glossary on the ServerView Suite DVD 2
- Manual for the monitor
- Documentation for the boards and drives
- Operating system documentation
- Information files in your operating system

## 1.3 Expansions and conversions

### Main memory

The system board offers 18 slots for memory modules. 9 memory slots can be used in mono processor configurations.

ECC with memory scrubbing and the Single Device Data Correction (SDDC) function is standard.

There are three modes of operation for the main memory:

- Independent Channel Mode / Performance Mode (recommended)
- Mirrored Channel Mode
- Spare Channel Mode

Depending on the mode of operation there are different population requirements.

### Second processor

The system board can be upgraded with a second processor. Only processors of the same type may be used on the system board. That means the number of the internal processor cores as well as the primary clock and the FSB frequency have to be the same. For dual operation, use a suitable multiprocessor operating system.

### Accessible drives

Three 5.25-inch bays are available for accessible drives.

You can use these bays as follows:

- You can install DVD drives or magnetic tape drives.
- You can install a Multibay 1 in the bottom bay. The Multibay 1 offers bays for a slimline DVD drive and a ServerView Local Service Panel (LSP) or a ServerView Local Service Display (LSD).
- In the two lower bays, you can install a Multibay 2. The Multibay 2 offers bays for two additional 3.5-inch hard disk drives, a slimline DVD drive and a ServerView Local Service Panel (LSP) or a ServerView Local Service Display (LSD).
- You can install a Multibay 1 in the bottom bay (see above) and an HDD extension box for 2.5-inch SAS hard disk drives in the two upper bays.

## LSD/LSP

The system board supports the CSS (Customer Self Service) functionality (description see the Operating Manual). You can install a ServerView Local Service Display (LSD) or ServerView Local Service Panel (LSP) for an easier identification of the defective components.

## Additional expansion cards in the PCI Express slots

The system board offers seven PCI Express slots. Slots 1-5 are connected as x4 interfaces, whereby slot 3 and slot 5 are used as x8 interfaces if slot 2 and slot 4 are empty.



Slot 1 is the preferred slot for the SAS/SATA RAID controller (bootable).

Slot 5 and slot 7 allow the mechanical installation of x16 PCIe expansion cards. The bus width is restricted to 8 lanes.

## Battery Backup Unit

A Battery Backup Unit (BBU) backs up the memory contents of the SAS/SATA RAID controller in the event of a power failure. One BBU can be installed for each SAS/SATA RAID controller. A maximum of three BBUs can be installed for each system.

## Trusted Platform Module (TPM)

A Trusted Platform Module (TPM) for safer storage of keys can be implemented as an option. This module enables programs from third party manufacturers to store key information (e.g. drive encryption using Windows Bitlocker Drive Encryption).

The TPM is activated via the BIOS system (for more information, refer to the "D2619-N BIOS Setup Utility for PRIMERGY RX300 S6 and TX300 S6" manual).



### CAUTION!

- When using the TPM, note the program descriptions provided by the third party manufacturers.
- You must also create a backup of the TPM content. To do this, follow the third party manufacturer's instructions. Without this backup, if the TPM or the system board is faulty you will not be able to access your data.

- If a failure occurs, please inform your service about the TPM activation before it takes any action, and be prepared to provide them with your backup copies of the TPM content.

**USB Flash Module (UFM)**

The server can be equipped with a USB Flash Module (UFM).



This module can be used as optional memory for software (e.g. VMware) or as a software dongle.

**Conversion from a floorstand model to a rack model**

The floorstand model can be converted into a space-saving rack system that only takes up 4 height units (HU). The server can thus be installed in any typical rack systems.

**1.4 Notational conventions**

The following notational conventions are used in this manual:

<i>Text in italics</i>	indicates commands or menu items.
"Quotation marks"	indicate names of chapters and terms that are being emphasized.
▶	describes activities that must be performed in the order shown.
 <b>CAUTION!</b>	pay particular attention to texts marked with this symbol. Failure to observe this warning may endanger your life, destroy the system or lead to the loss of data.
	indicates additional information, notes and tips.





---

## 2 Procedure



### CAUTION!

- The actions described in this manual shall be performed by technical specialists. A technical specialist is a person who is trained to install the server including hardware and software.
  - Repairs to the device that do not relate to CSS failures shall be performed by service personnel. Please note that unauthorized interference with the system will void the warranty and exempt the manufacturer from all liability.
  - Any failure to observe the guidelines in this manual, and any improper repairs could expose the user to risks (electric shock, energy hazards, fire hazards) or damage the equipment.
- ▶ First of all, carefully read the safety instructions in the chapter "[Safety instructions](#)" on page 19.
  - ▶ Make sure that all necessary manuals (see the section "[Documentation overview](#)" on page 12) are available; print the PDF files if required. Most importantly, you will need the Operating Manual for the server and the Technical Manual for the system board.
  - ▶ Shut the server down correctly, switch it off, disconnect the power cords and open the server as described in the chapter [chapter "Preparation"](#) on page 27.
  - ▶ Carry out the expansion or upgrade of your server as described in the pertinent chapter.
-  Installation and removal of the hot-plug components are described in the Operating Manual.
- ▶ Close the server, connect it to the power outlet, and switch it on as described in the chapter [chapter "Completion"](#) on page 105.
  - ▶ Start the operating system and make the appropriate configuration if necessary (see the Operating Manual).
-  For the latest information on optional products provided for the TX300 S6 see the configurator of this server:  
<https://sp.ts.fujitsu.com/dmstp/docs/cnfgtx300s6.pdf>



---

## 3 Safety instructions



The following safety instructions are also provided in the manual "Safety Notes and Regulations".

This device meets the relevant safety regulations for IT equipment. If you have any questions about whether you can install the server in the intended environment, please contact your sales outlet or our customer service team.



### CAUTION!

- The actions described in this manual shall be performed by technical specialists. A technical specialist is a person who is trained to install the server including hardware and software.
- Repairs to the device that do not relate to CSS failures shall be performed by service personnel. Please note that unauthorized interference with the system will void the warranty and exempt the manufacturer from all liability.
- Any failure to observe the guidelines in this manual, and any improper repairs could expose the user to risks (electric shock, energy hazards, fire hazards) or damage the equipment.
- Before installing/removing internal options to/from the server, turn off the server, all peripheral devices, and any other connected devices. Also unplug all power cords from the power outlet. Failure to do so can cause electric shock.

## Before starting up



### CAUTION!

- During installation and before operating the device, observe the instructions on environmental conditions for your device.
- If the device is brought in from a cold environment, condensation may form both inside and on the outside of the device.

Wait until the device has acclimatized to room temperature and is absolutely dry before starting it up. Material damage may be caused to the device if this requirement is not observed.

- Transport the device only in the original packaging or in packaging that protects it from knocks and jolts.

## Installation and operation



### CAUTION!

- This unit should not be operated in ambient temperatures above 35 °C.
- If the unit is integrated into an installation that draws power from an industrial power supply network with an IEC309 connector, the power supply's fuse protection must comply with the requirements for non-industrial power supply networks for type A connectors.
- The unit automatically adjusts itself to a mains voltage in a range of 100 V - 240 V. Ensure that the local mains voltage lies within these limits.
- This device must only be connected to properly grounded power outlets or insulated sockets of the rack's internal power supply with tested and approved power cords.
- Ensure that the device is connected to a properly grounded power outlet close to the device.



**CAUTION!**

- Ensure that the power sockets on the device and the properly grounded power outlets are freely accessible.
- The On/Off button or the main power switch (if present) does not isolate the device from the mains power supply. To disconnect it completely from the mains power supply, unplug all network power plugs from the properly grounded power outlets.
- Always connect the server and the attached peripherals to the same power circuit. Otherwise you run the risk of losing data if, for example, the server is still running but a peripheral device (e.g. memory subsystem) fails during a power outage.
- Data cables must be adequately shielded.
- Ethernet cabling has to comply with EN 50173 and EN 50174-1/2 standards or ISO/IEC 11801 standard respectively. The minimum requirement is a Category 5 shielded cable for 10/100 Ethernet, or a Category 5e cable for Gigabit Ethernet.
- Route the cables in such a way that they do not create a potential hazard (make sure no-one can trip over them) and that they cannot be damaged. When connecting the server, refer to the relevant instructions in this manual.
- Never connect or disconnect data transmission lines during a storm (risk of lightning hazard).
- Make sure that no objects (e.g. jewelry, paperclips etc.) or liquids can get inside the server (risk of electric shock, short circuit).
- In emergencies (e.g. damaged casing, controls or cables, penetration of liquids or foreign bodies), switch off the server immediately, remove all power plugs and contact your sales outlet or customer service team.

**CAUTION!**

- Proper operation of the system (in accordance with IEC 60950-1/2 resp. EN 60950-1/2) is only ensured if the casing is completely assembled and the rear covers for the installation slots have been fitted (electric shock, cooling, fire protection, interference suppression).
- Only install system expansions that satisfy the requirements and rules governing safety and electromagnetic compatibility and those relating to telecommunication terminals. If you install other expansions, they may damage the system or violate the safety regulations. Information on which system expansions are approved for installation can be obtained from our customer service center or your sales outlet.
- The components marked with a warning notice (e.g. lightning symbol) may only be opened, removed or exchanged by authorized, qualified personnel. Exception: CSS components can be replaced.
- The warranty is void if the server is damaged during installation or replacement of system expansions.
- Only set screen resolutions and refresh rates that are specified in the operating manual for the monitor. Otherwise, you may damage your monitor. If you are in any doubt, contact your sales outlet or customer service center.
- Before installing/removing internal options to/from the server, turn off the server, all peripheral devices, and any other connected devices. Also unplug all power cords from the outlet. Failure to do so can cause electric shock.
- Do not damage or modify internal cables or devices. Doing so may cause a device failure, fire, or electric shock.
- Devices inside the server remain hot after shutdown. Wait for a while after shutdown before installing or removing internal options.
- The circuit boards and soldered parts of internal options are exposed and can be damaged by static electricity. Before handling them, first touch a metal part of the server to discharge static electricity from your body.
- Do not touch the circuitry on boards or soldered parts. Hold the metallic areas or the edges of the circuit boards.



**CAUTION!**

- Install the screw removed during installation/detaching Internal Options in former device/position. To use a screw of the different kind causes a breakdown of equipment.
- The installation indicated on this note is sometimes changed to the kind of possible options without notice.

**Batteries**



**CAUTION!**

- Incorrect replacement of batteries may result in a risk of explosion. The batteries may only be replaced with identical batteries or with a type recommended by the manufacturer (see the Technical Manual for the system board).
- Replace the lithium battery on the system board in accordance with the instructions in the Technical Manual for the system board.

**Working with CDs/DVDs/BDs and optical drives**

When working with devices with optical drives, these instructions must be followed.



**CAUTION!**

- Only use CDs/DVDs/BDs that are in perfect condition, in order to prevent data loss, equipment damage and injury.
- Check each CD/DVD/BD for damage, cracks, breakages etc. before inserting it in the drive.

Note that any additional labels applied may change the mechanical properties of a CD/DVD/BD and cause imbalance.

Damaged and imbalanced CDs/DVDs/BDs can break at high drive speeds (data loss).

Under certain circumstances, sharp CD/DVD/BD fragments can pierce the cover of the optical drive (equipment damage) and can fly out of the device (danger of injury, particularly to uncovered body parts such as the face or neck).

- High humidity and airborne dust levels are to be avoided. Electric shocks and/or server failures may be caused by liquids such as water, or metallic items, such as paper clips, entering a drive.

- Shocks and vibrations are also to be avoided.
- Do not insert any objects other than the specified CDs/DVDs/BDs.
- Do not pull on, press hard, or otherwise handle the CD/DVD/BD tray roughly.
- Do not disassemble the optical drive.
- Before use, clean the optical disk tray using a soft, dry cloth.
- As a precaution, remove disks from the optical drive when the drive is not to be used for a long time. Keep the optical disk tray closed to prevent foreign matter, such as dust, from entering the optical drive.
- Hold CDs/DVDs/BDs by their edges to avoid contact with the disk surface.
- Do not contaminate the CD/DVD/BD surface with fingerprints, oil, dust, etc. If dirty, clean with a soft, dry cloth, wiping from the center to the edge. Do not use benzene, thinners, water, record sprays, antistatic agents, or silicone-impregnated cloth.
- Be careful not to damage the CD/DVD/BD surface.
- Keep the CDs/DVDs/BDs away from heat sources.
- Do not bend or place heavy objects on CDs/DVDs/BDs.
- Do not write with ballpoint pen or pencil on the label (printed) side.
- Do not attach stickers or similar to the label side. Doing so may cause rotational eccentricity and abnormal vibrations.
- When a CD/DVD/BD is moved from a cold place to a warm place, moisture condensation on the CD/DVD/BD surface can cause data read errors. In this case, wipe the CD/DVD/BD with a soft, dry cloth then let it air dry. Do not dry the CD/DVD/BD using devices such as a hair dryer.
- To avoid dust, damage, and deformation, keep the CD/DVD/BD in its case whenever it is not in use.
- Do not store CDs/DVDs/BDs at high temperatures. Areas exposed to prolonged direct sunlight or near heating appliances are to be avoided.





You can prevent damage from the optical drive and the CDs/DVDs/BDs, as well as premature wear of the disks, by observing the following suggestions:

- Only insert disks in the drive when needed and remove them after use.
- Store the disks in suitable sleeves.
- Protect the disks from exposure to heat and direct sunlight.

### Laser information

The optical drive complies with IEC 60825-1 laser class 1.



#### **CAUTION!**

The optical drive contains a light-emitting diode (LED), which under certain circumstances produces a laser beam stronger than laser class 1. Looking directly at this beam is dangerous.

**Never remove parts of the optical drive casing!**

### Modules with Electrostatic-Sensitive Devices

Modules with electrostatic-sensitive devices are identified by the following sticker:

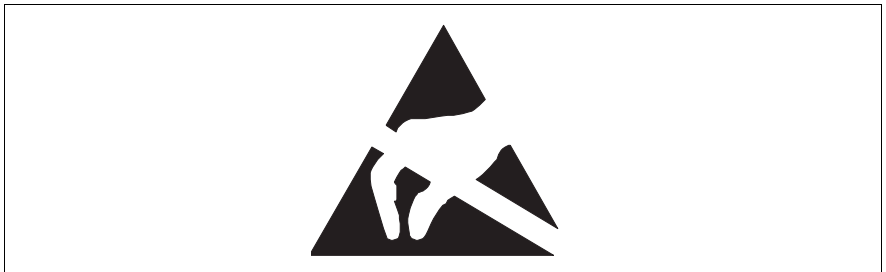

Figure 1: ESD label

When you handle components fitted with ESDs, you must always observe the following points:

- Switch off the system and remove the power plugs from the power outlets before installing or removing components with ESDs.
- You must always discharge static build-up (e.g. by touching a grounded object) before working with such components.
- Any devices or tools that are used must be free of electrostatic charge.

- Wear a suitable grounding cable that connects you to the external chassis of the system unit.
- Always hold components with ESDs at the edges or at the points marked green (touch points).
- Do not touch any connectors or conduction paths on an ESD.
- Place all the components on a pad which is free of electrostatic charge.



For a detailed description of how to handle ESD components, see the relevant European or international standards (EN 61340-5-1, ANSI/ESD S20.20).

---

## 4 Preparation



### CAUTION!

- Before removing or attaching covers, turn off the server, all peripheral devices, and any other connected devices. Also unplug all power cords from the power outlet. Failure to do so can cause electric shock.
- Only for rack model:  
Use the anti-tilt plate to prevent the rack from tipping when installing the rack. Pulling the server out of the rack without having installed the anti-tilt plate may cause the rack to tip over.
- Only for rack model:  
Be careful not to pinch fingers or clothes when sliding out the server or pushing it back. Failure to do so may cause injury.
- Before attaching the cover, make sure no unnecessary parts or tools are left inside the server.
- Before turning on the server, make sure the cover is closed.
- Follow the safety instructions in the [chapter "Safety instructions" on page 19](#).

## 4.1 Floorstand model



For some expansions and conversions, it is advisable to lay the server on its right-hand side and to remove the server feet.

### 4.1.1 Opening the server

- ▶ Terminate all applications and shut down the server correctly.
- ▶ If your operating system has not switched off the server, press the On/Off button.
- ▶ Pull all power cords out of the power outlet.
- ▶ If required, remove the lock on the side cover.
- ▶ If necessary, lay the server on its right-hand side.  
Get a second person to help you do this. The server can weigh around 25 - 40 kg (depending on the configuration).  
Make sure that the server feet protrude over the table edge.

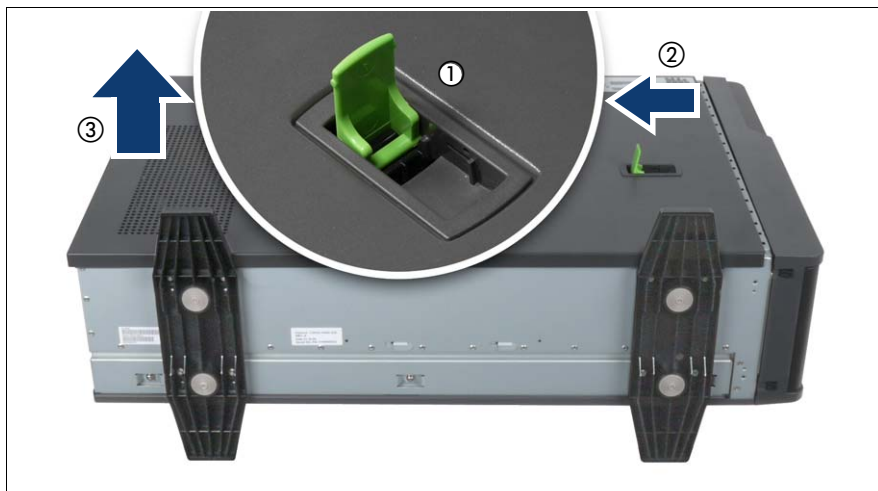

Figure 2: Removing the side cover

- ▶ Pull the locking lever as far as it will go (1). This pushes the side cover backward (2).
- ▶ Remove the side cover (3).

## 4.1.2 Removing the front cover

Remove the front cover when making the following routines:

- Installing/removing accessible drives
- Conversion from a floorstand model to a rack model



Figure 3: Removing the drive cover and the HDD cover

- ▶ Unlock the server and remove the key.
- ▶ Remove the drive cover (1).
- ▶ Remove the HDD cover (2).

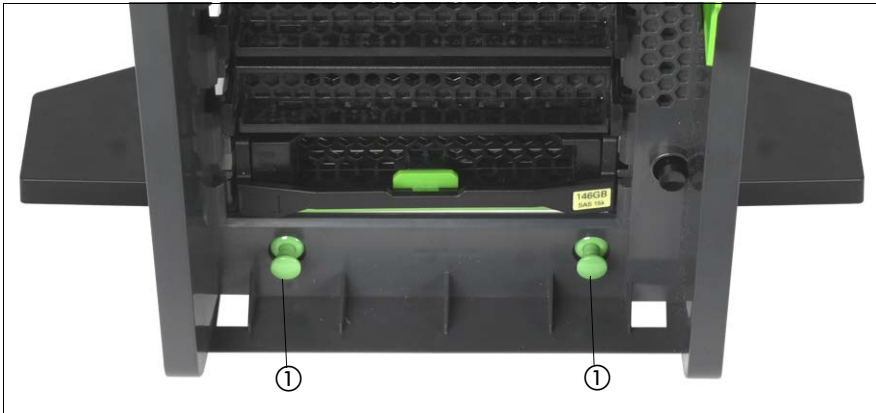

Figure 4: Pulling out the locking buttons

- ▶ Pull out the two green locking buttons (1).



Figure 5: Removing the front cover

- ▶ Pull the front cover forward slightly at the lower edge.
- ▶ Unhook the front cover at the top and remove it.

### 4.1.3 Removing the server feet



Figure 6: Removing the server feet

- ▶ If necessary, remove the server feet.

To do this, you need to loosen four screws on each of the feet (see circles).

## 4.2 Rack model

- ▶ Terminate all applications and shut down the server correctly.
- ▶ If your operating system has not switched off the server, press the On/Off button.
- ▶ Pull all power cords out of the power outlet.

### 4.2.1 Opening the server

#### Pulling the server out of the rack and opening the server

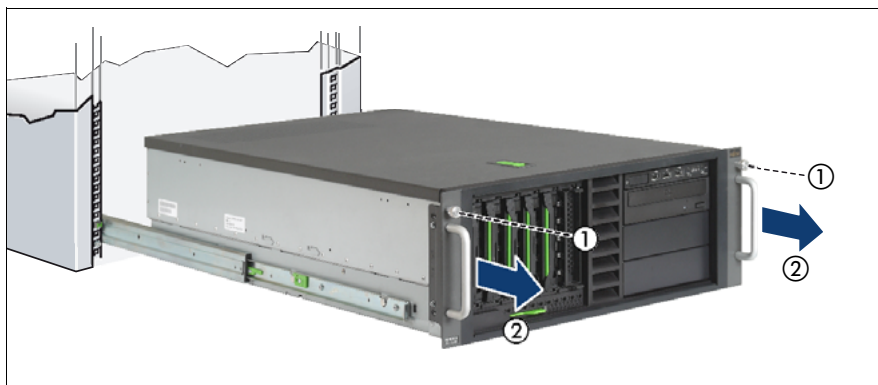

Figure 7: Pulling the server out of the rack

- ▶ Loosen the two knurled screws (1) and pull the server as far as possible out of the rack (2).
- ▶ Pull the locking lever as far as it will go (see also [figure 2 on page 28](#)). This pushes the top cover backward.



#### **CAUTION!**

Do not use the pulled-out server as a surface on which to put things or as a work surface, and strictly avoid leaning on or against it.

- ▶ Remove the top cover.



## Removing the server from the rack and opening the server

Depending on how accessible the server is in the rack cabinet, it can make sense to remove the server from the rack cabinet.

 Removing the server from the rack may be different. In this case you will find the description in the packaging of the rack mounting kit.

- ▶ Disconnect all cables on the rear side of the server.



### CAUTION!

At least two people are needed to lift the server out of the rack cabinet.

- ▶ Loosen the two knurled screws on the front (see [figure 4 on page 30](#)) and pull the server as far as it will go out of the rack.

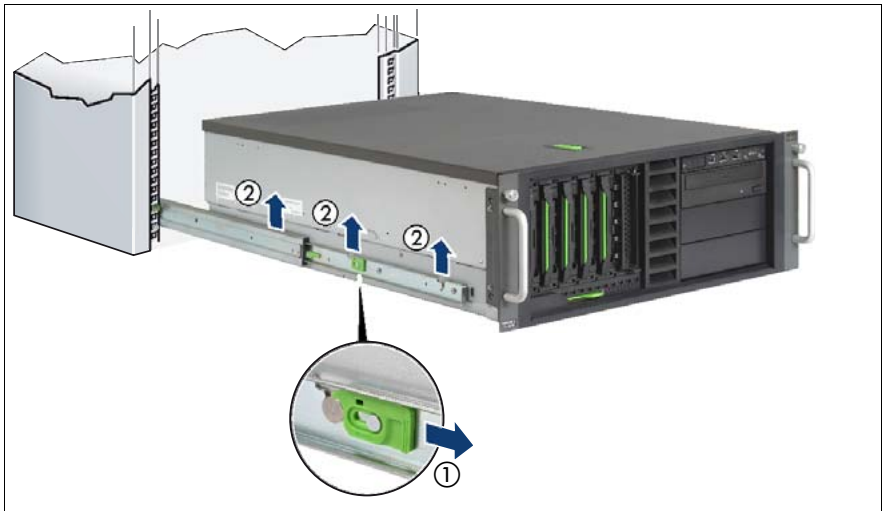

Figure 8: Unlocking the server and lifting it out of the rails

- ▶ Pull the locking bar forward on both sides (1).
- ▶ Lift the server out of the rails (2) and place it on a table, for example.
- ▶ Pull the locking lever as far as it will go (see also [figure 2 on page 28](#)). This pushes the top cover backward.
- ▶ Remove the top cover.

## 4.2.2 Removing the rack front cover

You remove the rack front cover when making the following routines:

- Installing/removing accessible drives

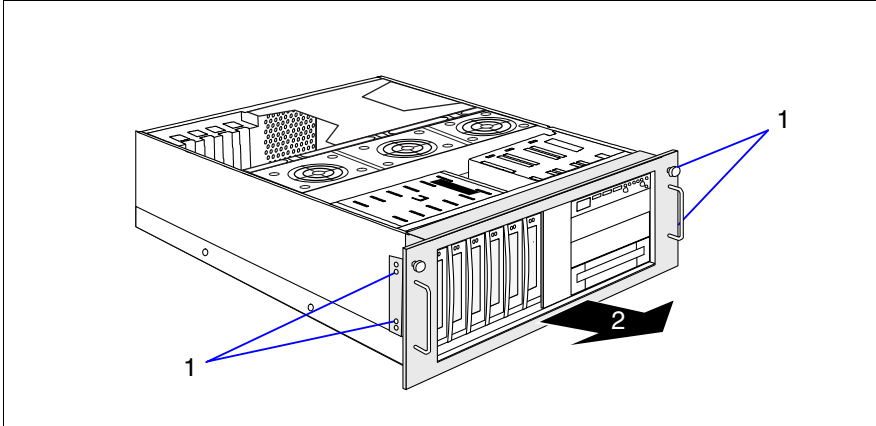

Figure 9: Removing the rack front cover

- ▶ Remove two knurled screws on either side (1).
- ▶ Remove the rack front cover to the front together with the plastic cover (2).

### 4.3 Removing the fan carrier

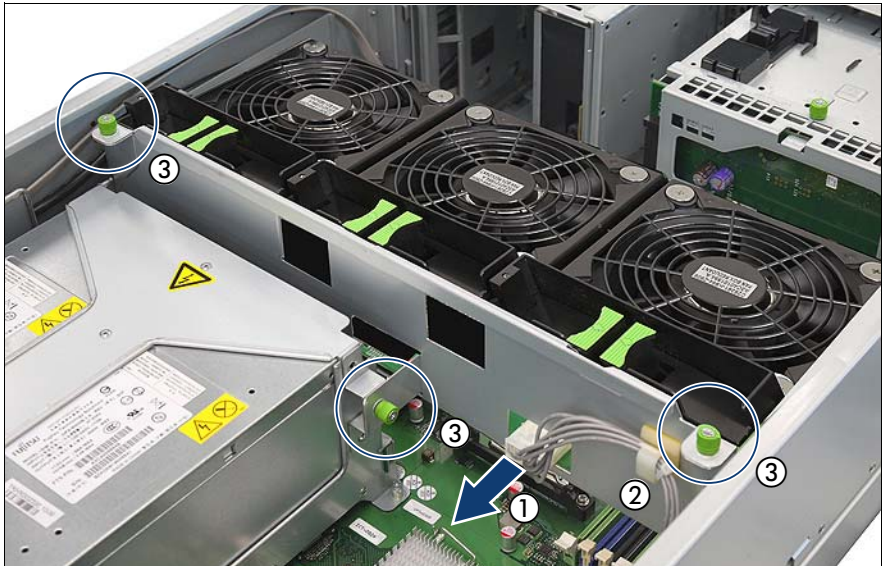

Figure 10: Disconnecting the power cable

- ▶ Disconnect the power cable from the fan backplane (1).
- ▶ Open the cable clamp and take out the power cable (2).
- ▶ Loosen the three knurled screws of the fan carrier (3).

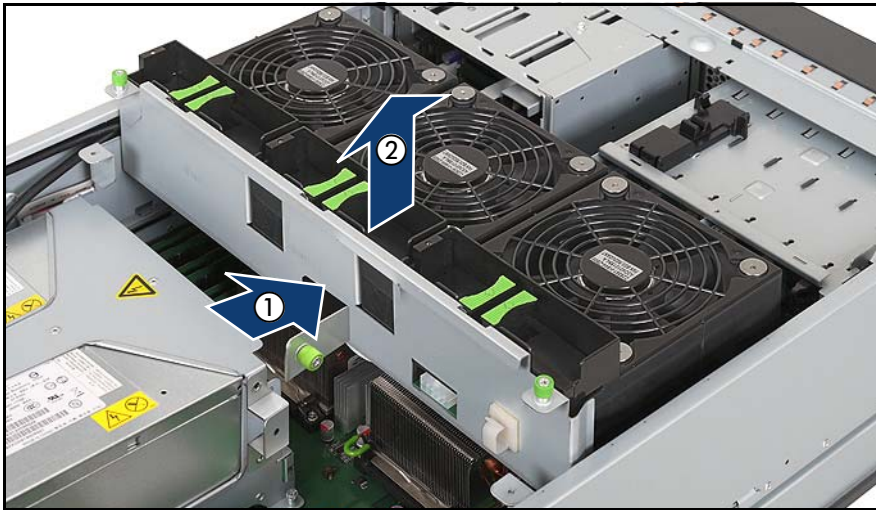

Figure 11: Removing the fan carrier

- ▶ Push the fan carrier in the direction of the front side (1).
- ▶ Take the fan carrier out of the server (2).



**CAUTION!**

Ensure that you do not damage the SAS cables when sliding the fan carrier in or lifting it out.

---

## 5 Main memory



### CAUTION!

- Before installing/removing memory to/from the server, turn off the server, all peripheral devices, and any other connected devices. Also unplug all power cords from the power outlet. Failure to do so can cause electric shock.
- A memory module consists of parts that are very vulnerable to damage by static electricity, and can easily be damaged by static electricity in the human body. Before handling memory modules, first touch a metal part of the server to discharge static electricity.
- Do not touch the circuitry on boards and soldered parts. Hold the metallic areas or the edge of the circuit boards.
- Do not install unauthorized third party memory modules. Doing so may cause electric shock, a fire, or failures.
- Wait for a sufficient period of time after server shutdown before installing or removing memory modules. Failure to do so may cause burns. When installing or removing memory modules, make sure to remove the screws at the specified points only. Failure to do so may cause injury. It may also cause failures.
- Touch only the specified part of the printed circuit board. Failure to do so may cause injury. It may also cause failures.
- Do not insert and remove memory modules repeatedly. Doing so may cause failures.
- If the memory module has not been correctly inserted, it may cause a fire. Insert the memory module with attention to its direction.
- If a memory module is installed and you pull the securing clips strongly outward, the memory module pops up. Doing so may cause a device failure.
- Follow the safety instructions in the [chapter "Safety instructions" on page 19](#).

## 5.1 Memory modules

The system board offers 18 slots for memory modules. 9 memory slots can be used in mono processor configurations.

ECC with memory scrubbing and with the Single Device Data Correction (SDDC) function is supported.

There are three modes of operation for the main memory:

- Independent Channel Mode / Performance Mode (recommended)
- Mirrored Channel Mode
- Spare Channel Mode

Depending on the mode of operation there are different population requirements.



The types of memory modules and the modes of operation are described in the Technical Manual or in the configurator of the server.

F	System configurator and order-information guide PRIMERGY TX300 S6      Status 2010-01-27
Section III	Memory
	<p>- There are 9 memory slots for max. 72GB (9x 8GB single / dual rank 1.5V RDIMM's) 96GB (6x 16GB quad rank 1.5V RDIMMs) 12GB (6x 2GB UDIMMs) =&gt; max. 192GB for two CPU's ( 96GB per CPU ) ( For explanation of following terms refer to section "Memory Configurations"</p> <p>- The memory area is divided into 3 channels per CPU with 3 slots per channel - Slot 1 of each channel belongs to memory bank 1, the slot 2 belongs to memory bank 2 and slot 3 belongs to memory bank 3 <b>Systems with 3DPC (9 DIMMs / CPU) do not support mix of dual rank and quad rank modules</b></p> <hr/> <p>Registered and unbuffered memory modules can be selected <b>No mix of registered and unbuffered modules allowed.</b> DDR3 1066 and 1333MHz modules can be mixed, but run always with the slower speed. With two DIMMs per channel, 1.5V DIMMs operate with 1333MHz, 1.35V with 1066MHz as max., dep. on CPU If 1.5V DIMMs and 1.35V (Low Voltage) DIMMs are mixed, DIMMs will run at 1.5V SDCC (Chipkill) is supported only for registered memory modules.</p> <hr/> <p>1.) In the "Independent Channel Mode" is following configuration possible - Each slot can optionally be equipped either with registered x4 organized DDR3 modules: 2GB single rank, 4GB and 8GB dual rank, 16GB quad rank or with unbuffered x8 organized DDR3 modules: 2GB dual rank</p> <hr/> <p>2.) In the "Spare Channel Mode" is following configuration possible - Each memory bank can optionally be equipped with 3x2GB single rank, 3x4GB and 3x8GB dual rank or 3x 16GB quad rank DDR3 modules. <b>Each slot of one bank has to be equipped with identical modules for spare channel mode</b> In channel A and B of CPU 1 or channel D and E of CPU 2 are always the active memory modules, in channel C of CPU 1 and channel F of CPU 2 is always the spare module  No special order codes with UDIMMs are offered for this mode</p> <hr/> <p>3.) In the "Mirrored Channel Mode" is following configuration possible - Each memory bank can optionally be equipped with 2x2GB single rank, 2x4GB and 2x8GB dual rank or 2x16GB quad rank DDR3 modules. <b>In each memory bank channel A and B of CPU 1 or channel D and E of CPU 2 have to be equipped with identical modules for mirrored channel mode. Channel C of CPU 1 and channel F of CPU 2 is not equipped</b> In channel B is always the mirrored memory of channel A of CPU 1 In channel E is always the mirrored memory of channel D of CPU 2  No special order codes with UDIMMs are offered for this mode</p> <hr/> <p>- For each CPU minimum 1 memory module has to be configured in Independent Channel Mode (=&gt; Additional memory extensions can still be configured up to eight times per CPU ) or <b>one bank has to be equipped with two modules (channel A+B for CPU 1 or D+E for CPU 2) in Mirrored Channel Mode</b> (=&gt; Additional memory extensions can still be configured up to two times per CPU ) or <b>one bank has to be equipped with three modules (channel A+B+C for CPU 1 or D+E+F for CPU 2) in Spare Channel Mode or Performance Mode</b> (=&gt; Additional memory extensions can still be configured up to two times per CPU )</p>

Figure 12: Extract from the configurator (EMEA market)



The current configurator can be found under:

[http://ts.fujitsu.com/products/standard\\_servers/tower/primergy\\_tx300s6.html](http://ts.fujitsu.com/products/standard_servers/tower/primergy_tx300s6.html)  
(for the EMEA market)

<http://primeserver.fujitsu.com/primergy/system.html> (for the Japanese market)

## 5.2 Expanding the main memory

- ▶ Open the server and remove the fan carrier as described in the [chapter "Preparation" on page 27](#).

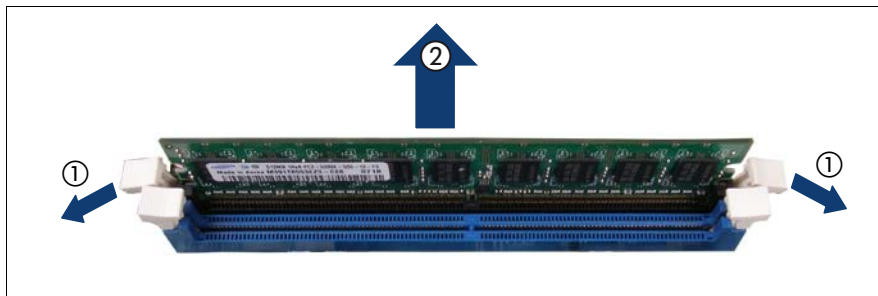

Figure 13: Removing a memory module

- ▶ Press the securing clips on both sides of the memory slot concerned outward (1).
- ▶ If the slot was equipped: pull the memory module out of the slot (2).

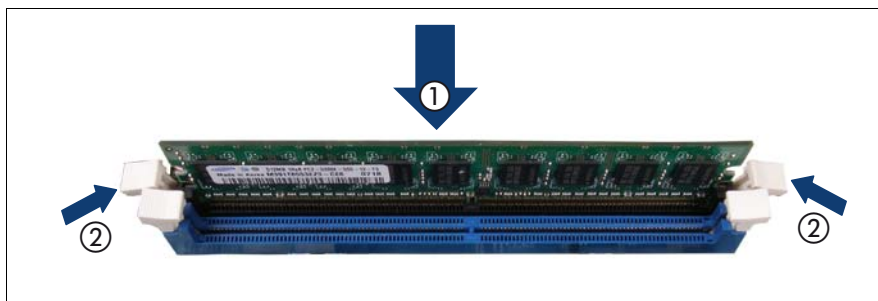

Figure 14: Installing a memory module

- ▶ Carefully press the memory module into the slot (1) until the securing clips on both sides of it engage (2).
- ▶ Reinstall the fan carrier as described in the [section "Installing the fan carrier" on page 105](#).
- ▶ Close the server, connect it to the power outlet, and switch it on as described in the [chapter "Completion" on page 105](#).



---

## 6 Processors



### CAUTION!

- Before installing/removing processors to/from the server, turn off the server, all peripheral devices, and any other connected devices. Also unplug all power cords from the power outlet. Failure to do so can cause electric shock.
- Do not touch the circuitry on boards and soldered parts. Hold the metallic areas or the edge of the circuit boards.
- When adding a processor, be sure to add memory into "DIMM 1D" additionally. Refer to [chapter "Main memory" on page 37](#) for the installation of the memory.
- When installing the processor, be careful not to bend the pins of the processor socket.
- Follow the safety instructions in the [chapter "Safety instructions" on page 19](#).



### CAUTION!

Processors are modules which can react extremely sensitively to electrostatic discharges and which must therefore always be handled with care. After a processor has been removed from its protective sleeve or from its socket, place it with its smooth side down on a non-conducting, antistatic surface. Never push a processor over a surface.

## 6.1 Installing a second processor

The system board can be upgraded with a second processor. The upgrade kit consists of a processor and a heat sink.



### CAUTION!

Only processors of the same type may be used on the system board. That means the number of the internal processor cores as well as the primary clock and the FSB frequency have to be the same. For dual operation, use a suitable multiprocessor operating system.

- ▶ Open the server and remove the fan carrier as described in the [chapter "Preparation" on page 27](#).

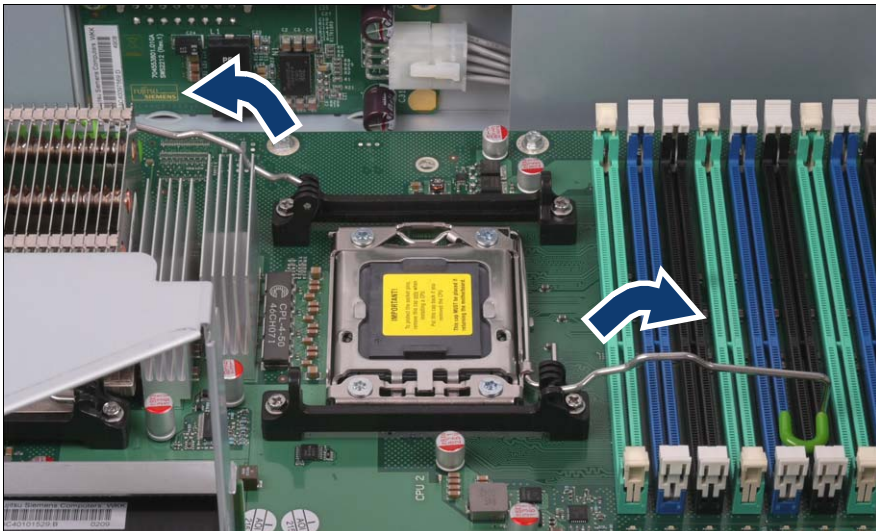

Figure 15: Opening the heat sink retaining clips

- ▶ Press the heat sink retaining clips downward and inward to release them.
- ▶ Fold the heat sink retaining clips back.

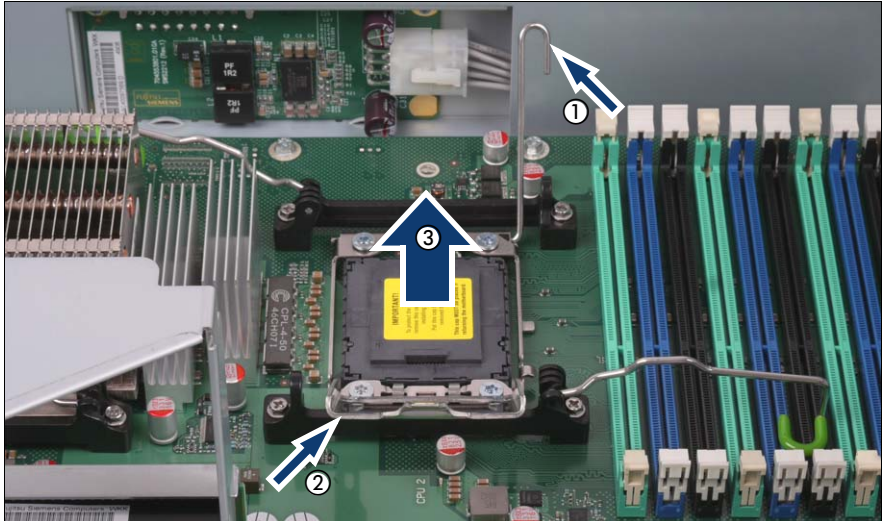

Figure 16: Opening the processor holder and removing the socket cover

- ▶ Press the spring clip downward and outward.
- ▶ Fold back the spring clip (1).
- ▶ Fold back the processor holder (2).
- ▶ Hold the socket cover by the two grips between your thumb and index finger and lift it vertically upward (3).

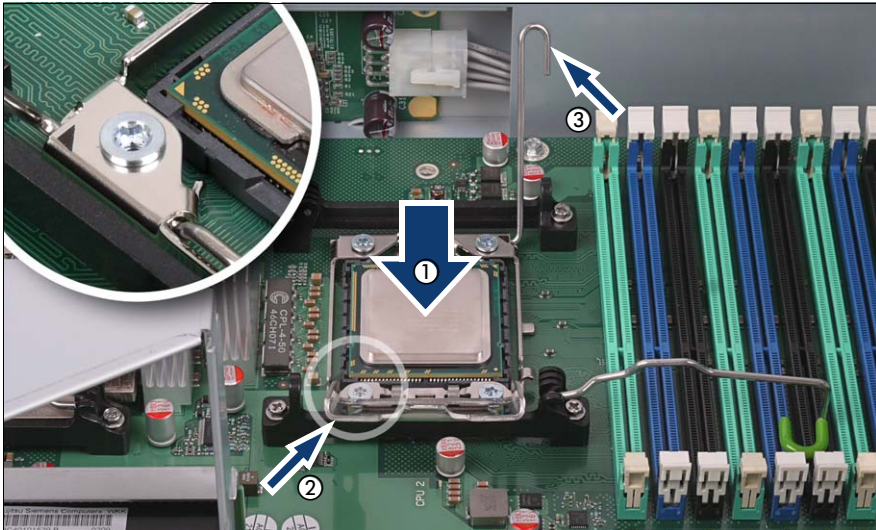

Figure 17: Inserting and locking the processor

- ▶ Hold the processor between your thumb and index finger and align it at the socket coding (see circle).



**CAUTION!**

The processor can only be installed in one particular direction.

- ▶ Place the processor in the socket with great care (1).



**CAUTION!**

Do not bend the spring contacts of the processor socket. Never touch the underside of the processor. Even light contaminants, such as oil from human skin, can destroy the processor or impair its functionality.

- ▶ Close the processor holder (2).
- ▶ Lock the processor in the socket by returning the spring clip to its original position (3).



Figure 18: Removing the protective cover

- ▶ Remove the protective cover on the underside of the heat sink.



**CAUTION!**

Do not touch the thermal paste on the underside of the heat sink.

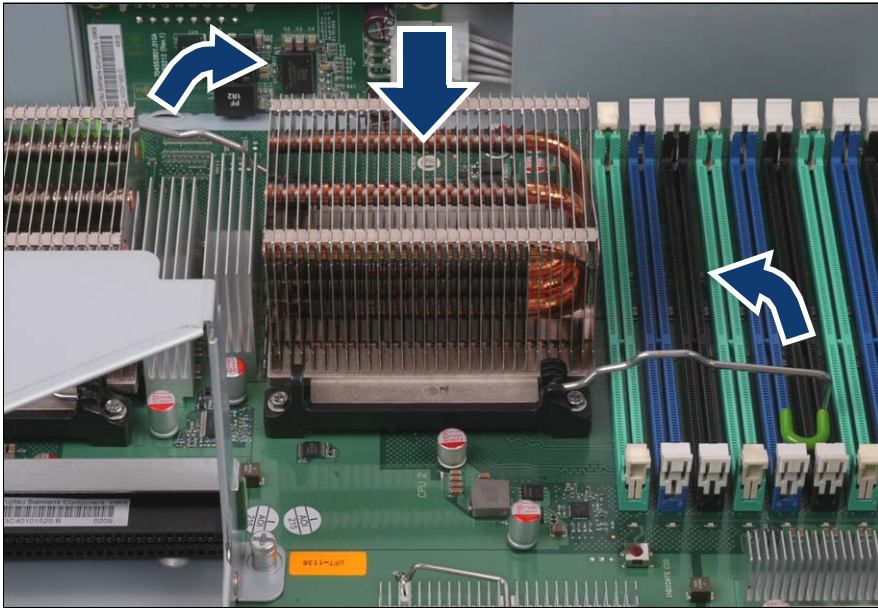

Figure 19: Mounting and locking the heat sink

- ▶ Align the heat sink on the processor socket so that the side with the visible copper heat pipes is pointing in the direction of the memory slots.
- ▶ Fold down the two heat sink retaining clips at the same time and lock the heat sink by returning the heat sink retaining clips to their original position.
- ▶ Reinstall the fan carrier as described in the [section "Installing the fan carrier" on page 105](#).
- ▶ Close the server, connect it to the power outlet, and switch it on as described in the [chapter "Completion" on page 105](#).

## 6.2 Replacing the processor



### CAUTION!

Only processors of the same type may be used on the system board. That means the number of the internal processor cores as well as the primary clock and the FSB frequency have to be the same. For dual operation, use a suitable multiprocessor operating system.

- ▶ Open the server and remove the fan carrier as described in the [chapter "Preparation" on page 27](#).

### Removing the heat sink

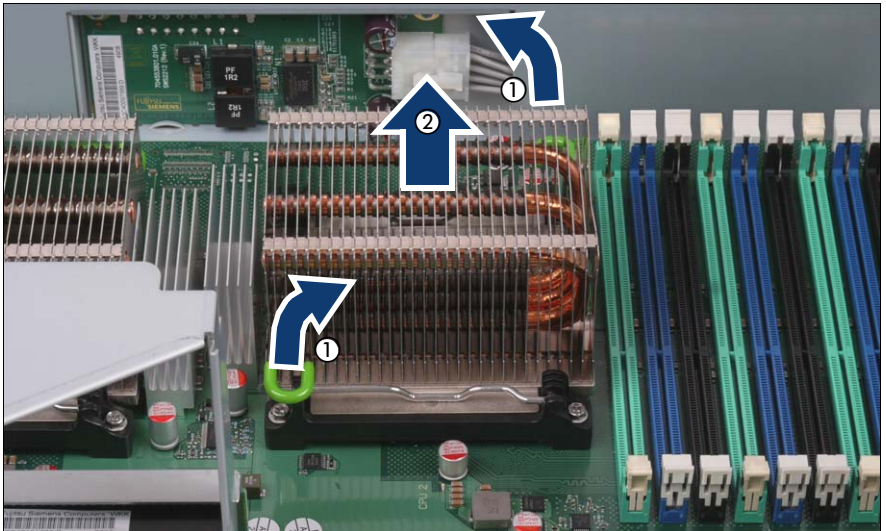

Figure 20: Removing the heat sink

- ▶ Press the heat sink retaining clips downward and inward.
- ▶ Fold back the heat sink retaining clips (1).
- ▶ Loosen the heat sink by turning it back and forth and then lift it out (2).
- ▶ Remove the residual thermal paste from the underside of the heat sink.
- ▶ Clean the underside of the heat sink using a lint-free cloth.

## Removing an old processor

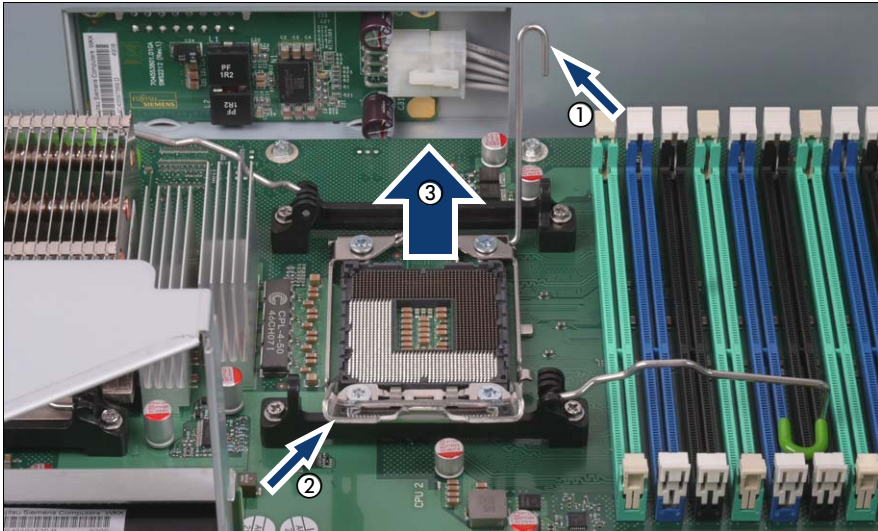

Figure 21: Removing an old processor

- ▶ Press the spring clip downward and outward.
- ▶ Fold back the spring clip (1).
- ▶ Fold back the processor holder (2).
- ▶ Lift the installed processor carefully out of the socket (3).

**CAUTION!**

Do not bend the spring contacts of the processor socket.



### Inserting and locking a new processor

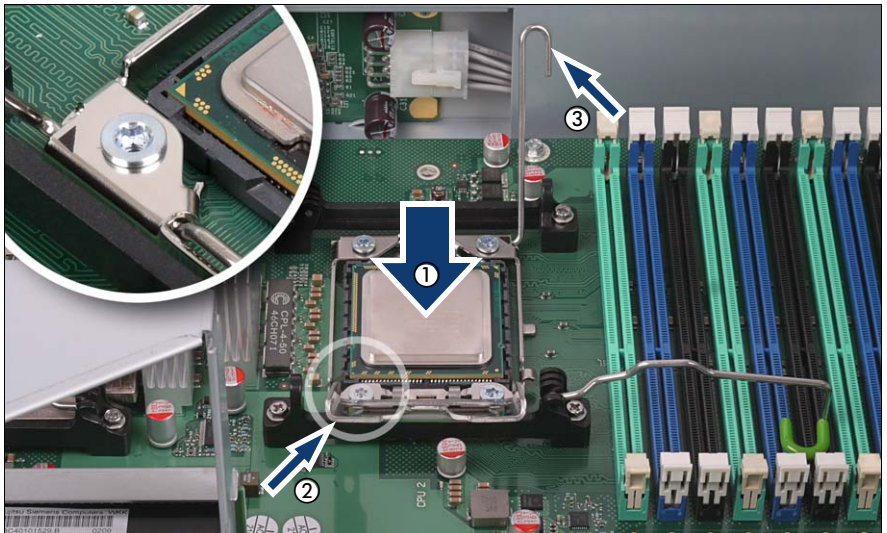

Figure 22: Inserting and locking a new processor

- ▶ Hold the processor between your thumb and index finger and align it at the socket coding (see circle).



#### CAUTION!

The processor can only be installed in one particular direction.

- ▶ Place the processor in the socket with great care (1).



#### CAUTION!

Do not bend the spring contacts of the processor socket. Never touch the underside of the processor. Even light contaminants, such as oil from human skin, can destroy the processor or impair its functionality.

- ▶ Close the processor holder (2).
- ▶ Lock the processor in the socket by returning the spring clip to its original position (3).

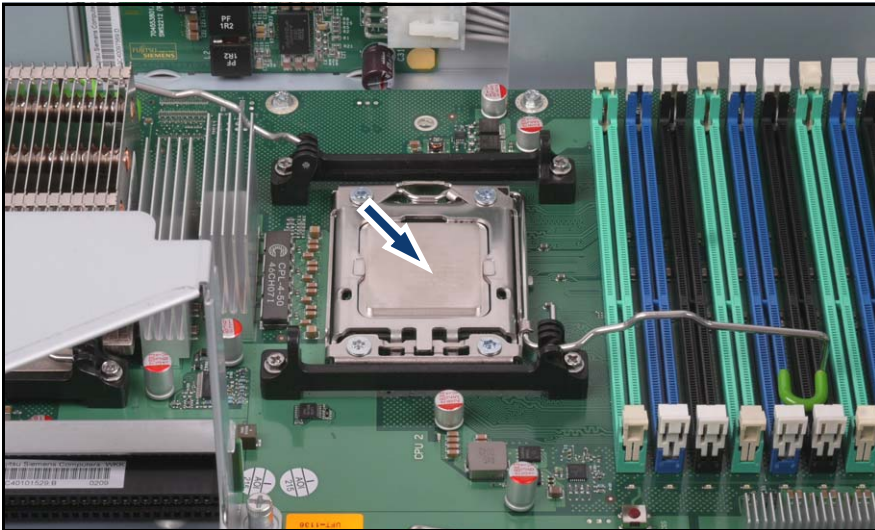

Figure 23: Applying and distributing thermal paste

- ▶ Apply a small amount of thermal paste to the upper side of the new processor.
- ▶ Ensure a thin and even distribution of the thermal paste.

### Mounting and locking the heat sink

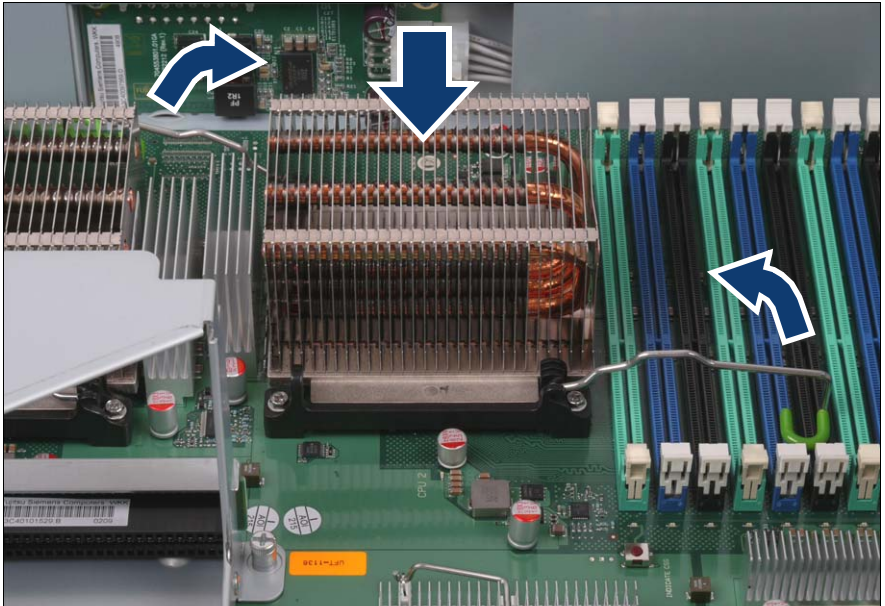

Figure 24: Mounting and locking the heat sink

- ▶ Align the heat sink on the processor socket so that the side with the visible copper heat pipes is pointing in the direction of the memory slots.
- ▶ Fold down the two heat sink retaining clips at the same time and lock the heat sink by returning the heat sink retaining clips to their original position.
- ▶ Reinstall the fan carrier as described in the [section "Installing the fan carrier" on page 105](#).
- ▶ Close the server, connect it to the power outlet, and switch it on as described in the [chapter "Completion" on page 105](#).

## 6.3 Replacing the heat sink

- ▶ Open the server and remove the fan carrier as described in the [chapter "Preparation" on page 27](#).
- ▶ Remove the heat sink as described in the [section "Replacing the processor" on page 47](#).
- ▶ Remove the protective cover from the new heat sink (see [figure 18 on page 45](#)).
- ▶ Install the new heat sink as described in the [section "Replacing the processor" on page 51](#).
- ▶ Reinstall the fan carrier as described in the [section "Installing the fan carrier" on page 105](#).
- ▶ Close the server, connect it to the power outlet, and switch it on as described in the [chapter "Completion" on page 105](#).

---

## 7 Accessible drives and LSD/LSP



### CAUTION!

- Before installing/removing an accessible drive to/from the server, turn off the server, all peripheral devices, and any other connected devices. Also unplug all power cords from the power outlet. Failure to do so can cause electric shock.
- When installing an accessible drive, hold it by the side. Applying force to the top may cause failures.
- Do not touch the circuitry on boards and soldered parts. Hold the metallic areas or the edge of the circuit boards.
- The circuit boards and soldered parts of internal options are exposed and can be damaged by static electricity. Before handling them, first touch a metal part on the server to discharge static electricity from your body.
- Before installing an internal accessible drive, see the manual for the accessible drive.
- When forcing an accessible drive into a server, be careful so as not to pinch the cable etc. connected to an accessible drive.
- Follow the safety instructions in the [chapter "Safety instructions" on page 19](#).

## 7.1 Equipping of the bays

Three 5.25-inch bays are available for accessible drives. You can install DVD drives, magnetic tape drives, a Multibay 1 (slimline DVD drive and ServerView LSP or LSD), or an HDD extension box in these bays.

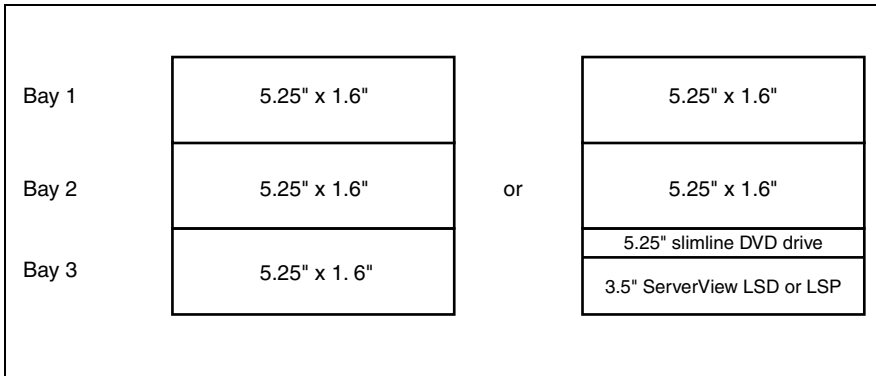

Figure 25: Bays for accessible drives

Recommended equipping of the bays:

Order	Installed accessible drive	Bay	Max. number	Bays occupied	Interface
1.	Multibay 1 with slimline DVD drive	3 top	1	1 x 0.5" x 5.25"	SAS
1.	Multibay 1 with LSD or LSP	3 bottom	1	1 x 0.5" x 5.25	I <sup>2</sup> C bus
1.	DVD drive	3 (if 2 occupied)	1	1 x 1.6" x 5.25	SATA
2.	LTO2 HH Ultrium	1	1	1 x 1.6" x 5.25	SAS
2.	LTO3 HH Ultrium	1 (if 2 occupied)	1	1 x 1.6" x 5.25	SAS
2.	LTO4 HH Ultrium	1 (if 2 occupied)	1	1 x 1.6" x 5.25	SAS
3.	DDS Gen 7 DDS Gen 6 DDS Gen 5	1 (if 2 occupied)	2	1 x 1.6" x 5.25	USB 2.0
4.	RDX drive	1 (if 2 occupied)	1	1 x 1.6" x 5.25	USB 2.0
5.	2.5" SAS HDD extension box	1 + 2 (if 2 + 3 occupied)	1	1 x 3.2" x 5.25	SAS
5.	3.5" SAS HDD extension box	2 + 3 (if 1 + 2 occupied)	1	1 x 3.2" x 5.25	SAS

## 7.2 Accessible 5.25-inch drive

- ▶ Open the server and remove the the front cover or the rack front cover as described in the [chapter "Preparation" on page 27](#).

**i** New 5.25-inch drives are supplied without EasyClick rails. Before installing a new 5.25-inch drive you must therefore remove the EasyClick rails from the dummy cover and mount the EasyClick rails on the new 5.25-inch drive.

### 7.2.1 Removing the dummy cover



Figure 26: Removing the dummy cover

- ▶ Press the metal tongues on the sides of the EasyClick rails inward (1) until the locking mechanism disengages.
- ▶ Pull the dummy cover out of the bay frontward (2).





Figure 27: Detaching the EasyClick rails from the dummy cover

- ▶ Detach the EasyClick rails from the dummy cover by removing the four screws on each side.



Note that there are two M3 x 4.5mm screws with M3 thread (yellow ellipse) and two 6-32 x 4.8mm screws with UNC thread (blue ellipse) on each side.



**CAUTION!**

Keep the dummy cover for future use. If you remove the accessible drive again and do not replace it with a new one, the dummy cover must be reinstalled to comply with EMC regulations and to satisfy cooling requirements and fire protection measures.

## 7.2.2 Installing an accessible 5.25-inch drive



Figure 28: Attaching the EasyClick rails - example: DVD drive

- ▶ Screw the EasyClick rails onto either side of the new 5.25-inch drive using two M3x4.5mm screws.

Use the first hole in each lower row of holes as shown in the figure.

**i** Keep the remaining screws for future use. The different drives are fastened using different screws.

Please use the screws which are provided with the packaging contents of the tape drive.

- ▶ Push the new drive about halfway into the bay.
- ▶ Connect the data cable to the accessible drive (see the cabling plans in the Appendix).
- ▶ Connect the power cable to the accessible drive (see the cabling plans in the Appendix).
- ▶ Push the drive fully into the bay until the EasyClick rails lock in place.
- ▶ Attach the front cover or the rack front cover as described in the [section "Attaching the front cover" on page 108](#) or in the [section "Attaching the rack front cover" on page 111](#).
- ▶ Close the server, connect it to the power outlet, and switch it on as described in the [chapter "Completion" on page 105](#).

## 7.3 Multibay 1

- ▶ Open the server and remove the the front cover or the rack front cover as described in the [chapter "Preparation" on page 27](#).
- ▶ Remove the dummy cover from the bay 3 (see [section "Equipping of the bays" on page 54](#) and [section "Removing the dummy cover" on page 56](#)).
- ▶ Detach the EasyClick rails from the dummy cover by removing the four screws on each side (see [figure 27 on page 57](#)).

**i** Note that there are two M3 x 4,5mm screws with M3 thread and two 6-32 x 4,8mm screws with UNC thread on each side.

### 7.3.1 Equipping Multibay 1

Multibay 1 can be equipped with a ServerView Local Service Panel (LSP) or a ServerView Local Service Display (LSD) and a DVD drive.

#### 7.3.1.1 Installing LSP or LSD



Figure 29: ServerView Local Service Display (LSD) and ServerView Local Service Panel (LSP)

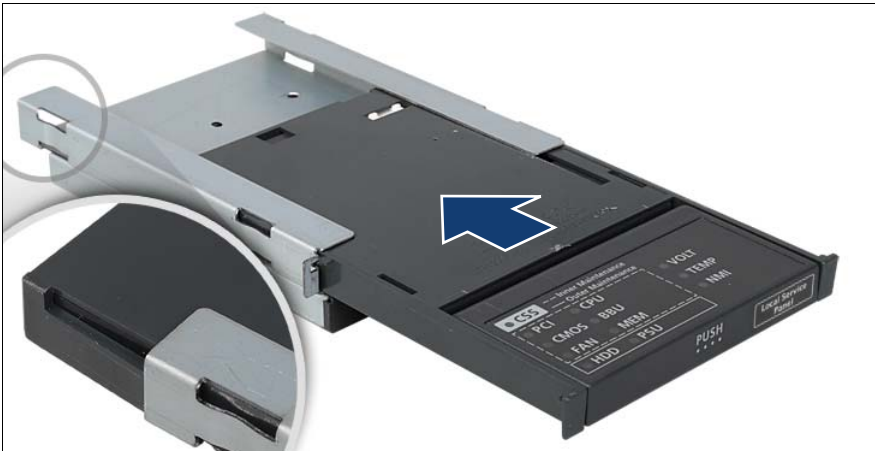

Figure 30: Sliding the LSP in the 3.5-inch frame

- ▶ Slide the LSD/LSP in the 3.5-inch frame from the front until it engages (see the snap-in hook in the circle).



Figure 31: Sliding the 3.5-inch frame with LSP in Multibay 1

- ▶ Slide the 3.5-inch frame with the LSP/LSD from the rear side in Multibay 1.

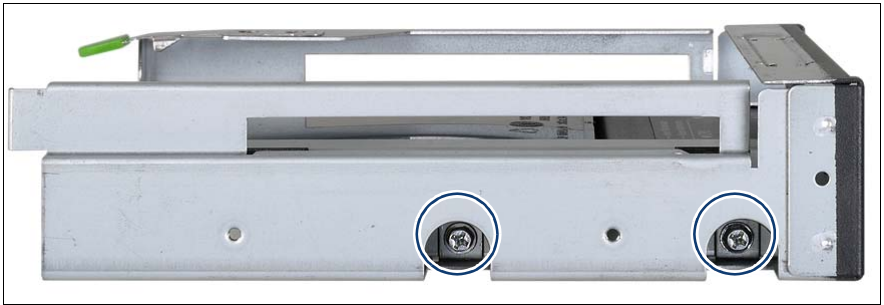

Figure 32: Fastening the 3.5-inch frame with LSP in Multibay 1

- ▶ Fasten the 3.5-inch frame using two M3 x 6 mm screws on either side.

### 7.3.1.2 Installing a slimline DVD drive



Figure 33: Inserting a slimline DVD drive in the frame

- ▶ Insert the slimline DVD drive in the frame.  
The four pins on the frame (see circles) engage with the screw holes on the drive and lock it in place.



Figure 34: Connecting the PS adapter cable to the DVD drive

- ▶ Connect the PS adapter cable to the DVD drive (see the cabling plans in the Appendix).

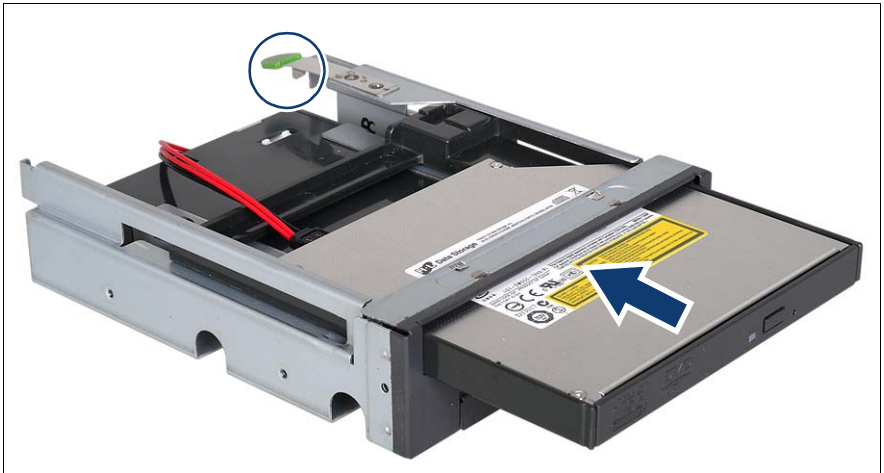

Figure 35: Inserting the DVD drive module in the Multibay 1

- ▶ From the front, insert the DVD drive module into Multibay 1 until it engages (see locking latch in circle).



Figure 36: Attaching EasyClick rails to Multibay 1

- ▶ Screw the EasyClick rails onto either side using two M3 x 4.5 mm screws. Use the first hole in each lower row of holes as shown in the figure.

### 7.3.2 Installing Multibay 1

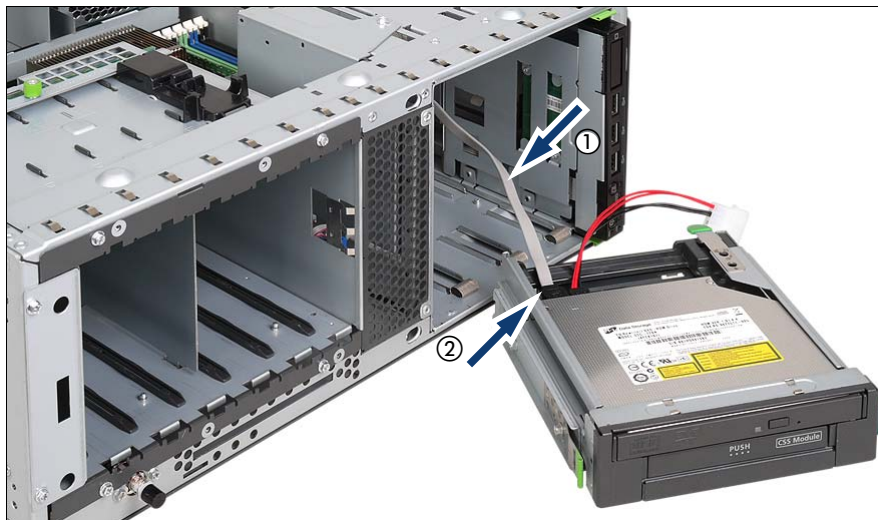

Figure 37: Connecting the SATA cable to the DVD drive

- ▶ Pull the SATA cable (1) out of the housing through the drive cage.
- ▶ Connect the SATA cable to the DVD drive (2) (see the cabling plans in the Appendix).





Figure 38: Installing Multibay 1

- ▶ Push Multibay 1 fully into bay 3 until the EasyClick rails lock in place. Ensure that no damage is caused to the cables.



Figure 39: Connecting the PS adapter cable to the power cable

- ▶ Connect the PS adapter cable to the CON.2 or CON.4 or CON.6 connector of the power cable (see the cabling plans in the Appendix).

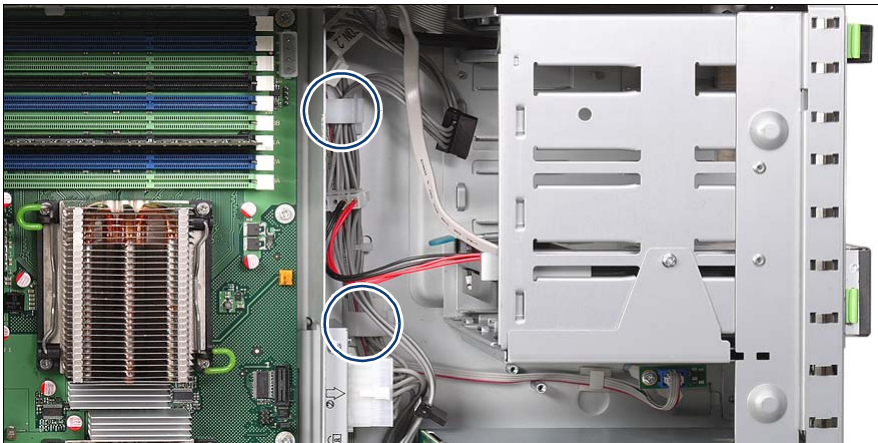

Figure 40: Routing the power cable

- ▶ Route the power cable using the cable clamps as shown.



Figure 41: Connecting the I<sup>2</sup>C cable to the LSP/LSD

- ▶ Remove the cable tie of the I<sup>2</sup>C cable near the CON.4 connector.
- ▶ Connect the I<sup>2</sup>C cable CON.4 connector to the LSP/LSD (see the cabling plans in the Appendix).
- ▶ Attach the front cover or the rack front cover as described in the [section "Attaching the front cover" on page 108](#) or in the [section "Attaching the rack front cover" on page 111](#).
- ▶ Close the server, connect it to the power outlet, and switch it on as described in the [chapter "Completion" on page 105](#).

## 7.4 HDD extension box

In the base units two 5.25-inch bays for accessible drives can be used to install an HDD extension box.

Two variants of the HDD extension box are available:

- HDD extension box for 3.5-inch HDD modules (Multibay 2):  
Multibay 2 contains one bay for a LSP or LSD, one bay for a DVD drive, and two bays for 3.5-inch HDD modules.
- HDD extension box for 2.5-inch HDD modules:  
This HDD extension box contains eight bays for 2.5-inch HDD modules.

The HDD extension box is supplied without EasyClick rails. You need 4 M3 screws. Before installing a new HDD extension box you must therefore remove the EasyClick rails from one dummy cover and mount two EasyClick rails on the HDD extension box.

- ▶ Open the server and remove the the front cover or the rack front cover as described in the [chapter "Preparation" on page 27](#).
- ▶ Remove the dummy covers from the required 5.25-inch bays (see [section "Equipping of the bays" on page 54](#) and [section "Removing the dummy cover" on page 56](#)).
- ▶ Detach the EasyClick rails from a dummy cover by removing the four screws on each side (see [figure 26 on page 56](#)).



Note that there are two M3 screws and two UNC screws on each side (see [figure 27 on page 57](#)).



### CAUTION!

Keep the dummy covers for future use. If you remove the HDD extension box again and do not replace it with a new one, the dummy covers must be reinstalled to comply with EMC regulations and to satisfy cooling requirements and fire protection measures.

## 7.4.1 Multibay 2

Multibay 2 contains one bay for a LSP or LSD, one bay for a DVD drive, and two bays for 3.5-inch HDD modules.

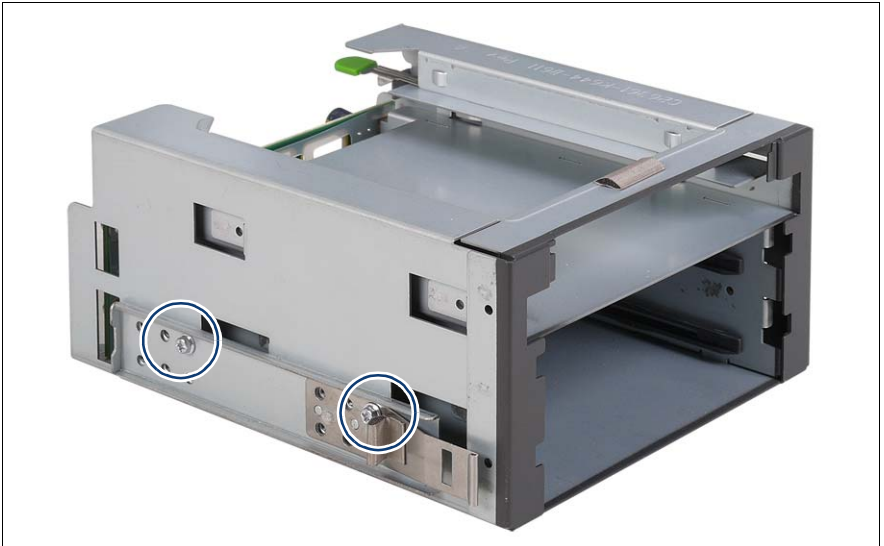

Figure 42: Attaching EasyClick rails to Multibay 2

- ▶ Screw the EasyClick rails onto either side using two M3 x 4.5 mm screws. Use the first hole in each upper row of holes as shown in the figure.

- ▶ Install a DVD drive, if required.

The procedure is similar to that of Multibay 1 (see [section "Installing a slimline DVD drive" on page 61](#)).

- ▶ Install a LSP or LSD, if required.

The procedure is similar to that of Multibay 1 (see [section "Installing LSP or LSD" on page 59](#)).



Note that in this case the LSP/LSD module is inserted in Multibay 2 from the front.

### 7.4.1.1 Installing Multibay 2

When installing Multibay 2, proceed in a similar way as for installing Multibay 1. See [section "Installing Multibay 1" on page 64](#) on how to connect the SATA cable to the DVD drive and connect the PSU adapter cable to the power cable.

- ▶ Push Multibay 2 fully into bays 2 and 3 until the EasyClick rails lock in place. Ensure that no damage is caused to the cables.
- ▶ Remove the fan carrier as described in the [chapter "Preparation" on page 27](#).
- ▶ Remove the cable cover as described on [page 85](#).

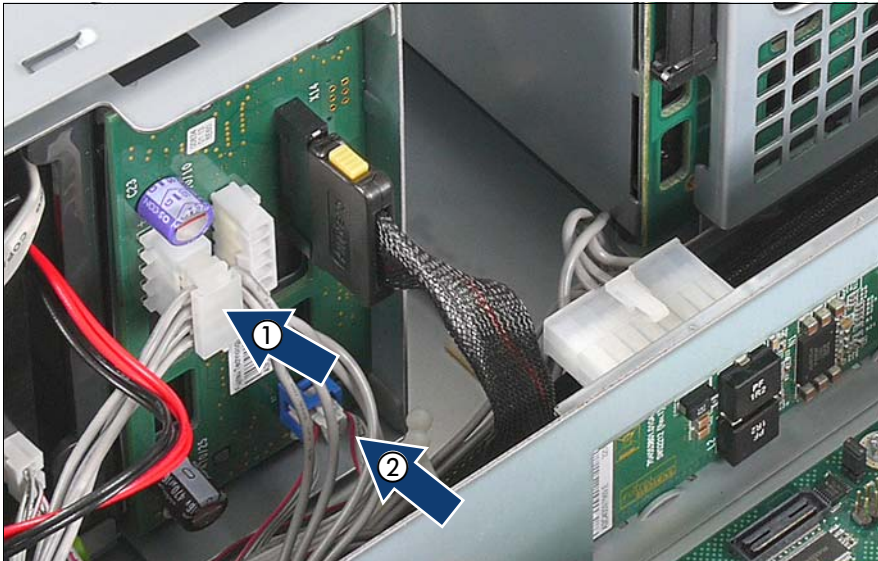

Figure 43: Connecting cables to HDD backplane of Multibay 2

- ▶ Connect the connector CON.6 of the power cable to the connector X5 of the HDD backplane (1).
- ▶ Remove the cable tie located near connector CON.4 from the I<sup>2</sup>C cable.
- ▶ Connect the I<sup>2</sup>C cable connector CON.4 to the LSD/LSP module (see the cabling plans in the Appendix)
- ▶ Connect the I<sup>2</sup>C cable to the connector X7 of the HDD backplane (2).

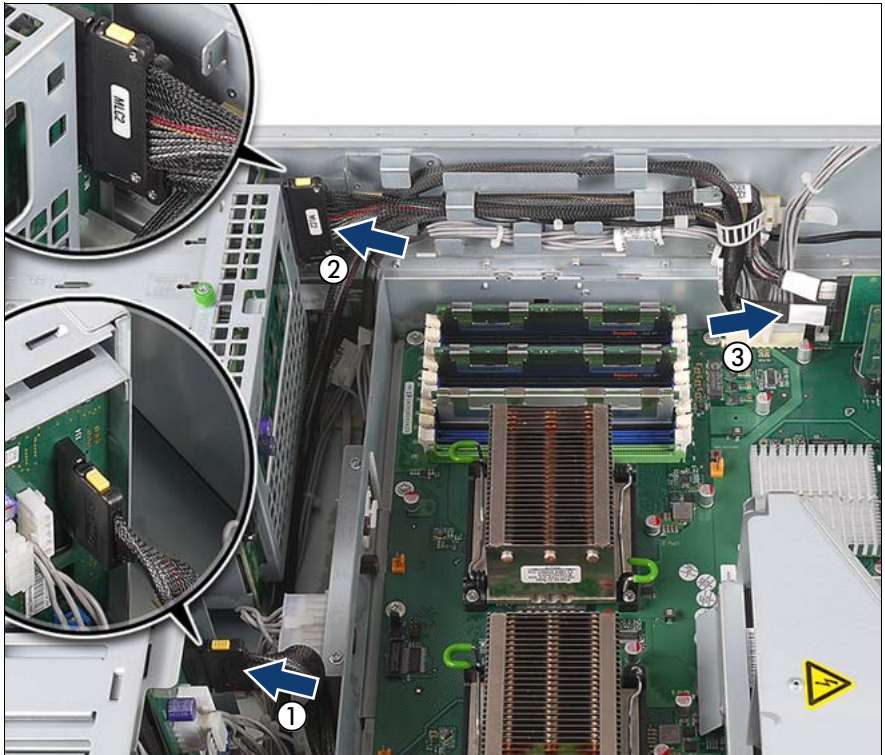

Figure 44: Cabling SAS cable

- ▶ Connect the SAS cable included to the connector X1 of the HDD backplane of the Multibay 2 (1).
- ▶ Connect the SAS cable included to the connector MLC2 of the 3.5-inch HDD backplane (2).
- ▶ Route the SAS cable through the cable guides as shown.
- ▶ Connect the SAS cable to the connector MLC2 of the RAID controller (3).
- ▶ Reinstall the cable cover as described on [page 91](#).
- ▶ Reinstall the fan carrier as described in the [section "Installing the fan carrier" on page 105](#).
- ▶ Attach the front cover or the rack front cover as described in the [section "Attaching the front cover" on page 108](#) or in the [section "Attaching the rack front cover" on page 111](#).

- ▶ Close the server, connect it to the power outlet, and switch it on as described in the [chapter "Completion" on page 105](#).

## 7.4.2 2.5-inch HDD extension box

The HDD extension box for 2.5-inch HDD modules contains eight bays for 2.5-inch HDD modules. It requires a redundant power supply (description see the Operating Manual) and an additional SAS/SATA RAID controller (see [chapter "Expansion cards and BBU" on page 75](#)).

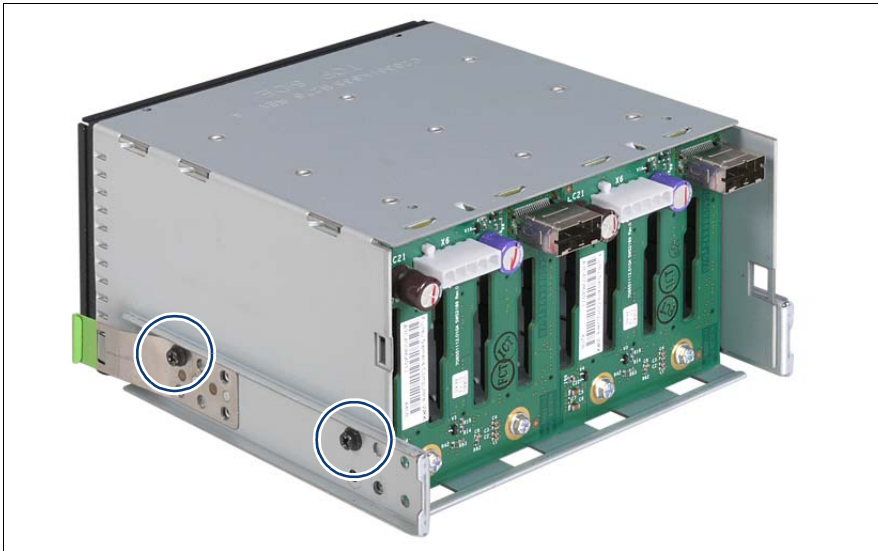

Figure 45: Attaching EasyClick rails to 2.5-inch HDD extension box

- ▶ Screw the EasyClick rails onto either side using two M3 x 3.5 mm screws. Use the first hole (seen from front side) in each upper row of holes as shown in the figure.



### CAUTION!

Longer M3 screws may damage the drive!

The M3 x 4.5 mm screws of a dummy cover are too long and must not be used.



### 7.4.2.1 Installing 2.5 inch HDD extension box



Figure 46: Connecting PS adapter cable to HDD backplanes

- ▶ Connect the PS adapter cables to the two HDD backplanes at the rear side of the HDD extension box (X6 connectors).
- ▶ Push the HDD extension box fully into bay 1 and bay 2 until the EasyClick rails lock in place.

Ensure that no damage is caused to the cables.

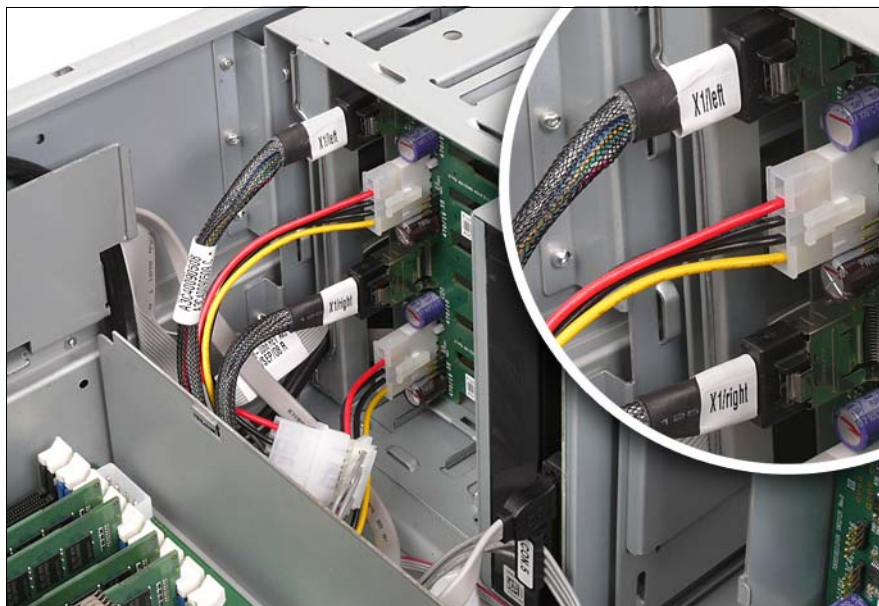

Figure 47: Cabling 2.5-inch HDD extension box

- ▶ Connect the PS adapter cables to the CON.2 and CON.4 connectors of the power cable.
- ▶ Connect the SAS cables included in the conversion kit to the SAS connectors on the HDD backplanes (see circle).  
Observe the labels on the connectors (X1 right or X1 left).
- ▶ Route the SAS cables in the cable clamps and connect them to the connectors of an additional SAS/SATA RAID controller (see the cabling plans in the Appendix).
- ▶ Attach the front cover or the rack front cover as described in the [section "Attaching the front cover" on page 108](#) or in the [section "Attaching the rack front cover" on page 111](#).
- ▶ Close the server, connect it to the power outlet, and switch it on as described in the [chapter "Completion" on page 105](#).

---

## 8 Expansion cards and BBU



### CAUTION!

- Before installing/removing expansion cards to/from the server, turn off the server, all peripheral devices, and any other connected devices. Also unplug all power cables from the power outlet. Failure to do so can cause electric shock.
- The circuit boards and soldered parts of internal options are exposed and can be damaged by static electricity. Before handling them, first touch a metal part on the server to discharge static electricity from your body.
- Do not touch the circuitry on boards and soldered parts. Hold the metallic areas or the edge of the circuit boards.
- Follow the safety instructions in the [chapter "Safety instructions" on page 19](#).

## 8.1 Installing expansion cards

The system board has seven PCI Express slots. Slots 1-5 are connected as x4 interfaces, whereby slot 3 and slot 5 are used as x8 interfaces if slot 2 and slot 4 are empty.



Slot 1 is the preferred slot for the SAS/SATA RAID controller (bootable).

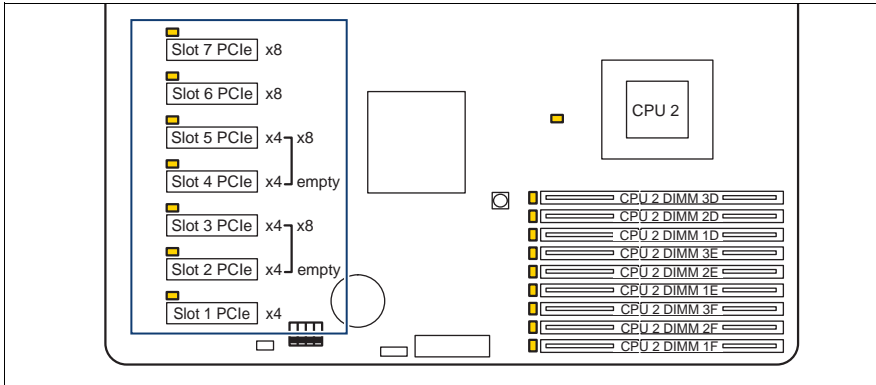

Figure 48: Arrangement of the PCIe slots

Slot	Description
1	PCIe x4 for SAS/SATA RAID controller
2	PCIe x4
3	PCIe x4 (PCIe x8, if slot 2 is empty)
4	PCIe x4
5	PCIe x4 (PCIe x8, if slot 4 is empty)
6	PCIe x8
7	PCIe x8



For more information see the Technical Manual of the system board D2619-N.

- ▶ Open the server as described in the [chapter "Preparation" on page 27](#).

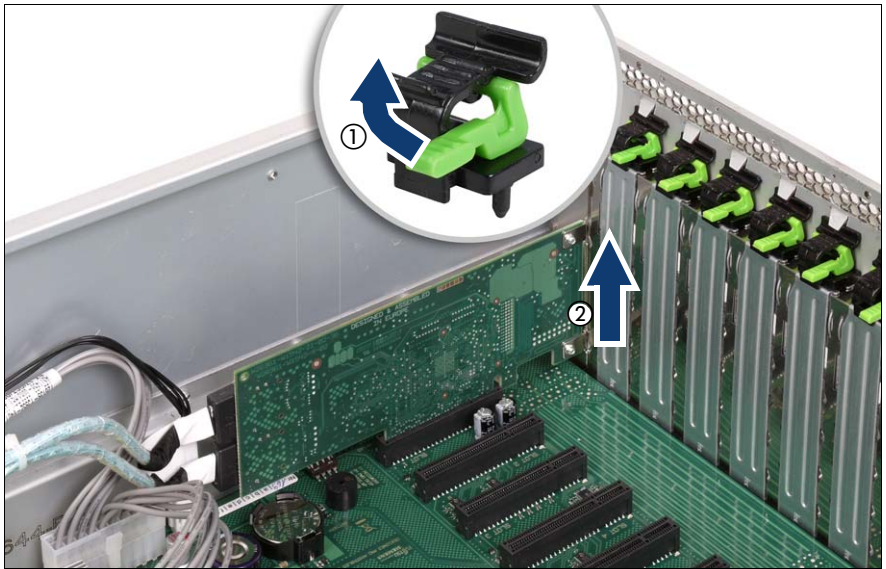

Figure 49: Removing the slot cover

- ▶ Open the slot locking bar in the direction of the arrow (1).
- ▶ Remove the slot locking bar.
- ▶ Remove the slot cover (2).



**CAUTION!**

Keep the slot cover for further use. If the expansion card is removed again and not replaced with a new one, the slot cover has to be reinstalled to comply with applicable EMC regulations and satisfy cooling requirements and fire protection measures.

- ▶ Unpack the new expansion card, and make the desired settings. You should read the accompanying documentation supplied with the expansion card beforehand.

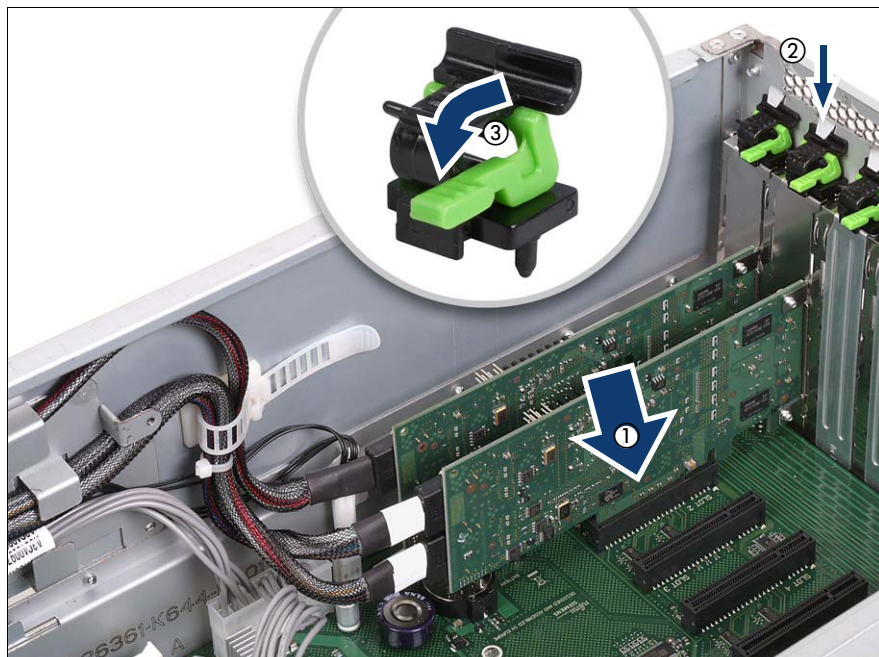

Figure 50: Installing an expansion card

- ▶ Carefully press the new expansion card into the relevant slot on the system board (1).
- ▶ Fit the clip onto the slot cover so that the pin fits into the hole.
- ▶ Push the clip under the metal nose (2) until it clicks into place.
- ▶ Swing the lever (3) downward into its locking position.
- ▶ If required, connect the cables to the expansion card and other components.
- ▶ Close the server, connect it to the power outlet, and switch it on as described in the [chapter "Completion" on page 105](#).

## 8.2 Installing a BBU



### CAUTION!

- Do not connect the cable using excessive force, the connector is weak.
- Follow the safety instructions in the [chapter "Safety instructions" on page 19](#).

The Battery Backup Unit (BBU) backs up the memory contents of the SAS/SATA RAID controller in the event of a power failure.

One BBU can be installed for each SAS/SATA RAID controller. A maximum of three BBUs can be installed for each system.

- ▶ Open the server and remove the fan carrier as described in the [chapter "Preparation" on page 27](#).

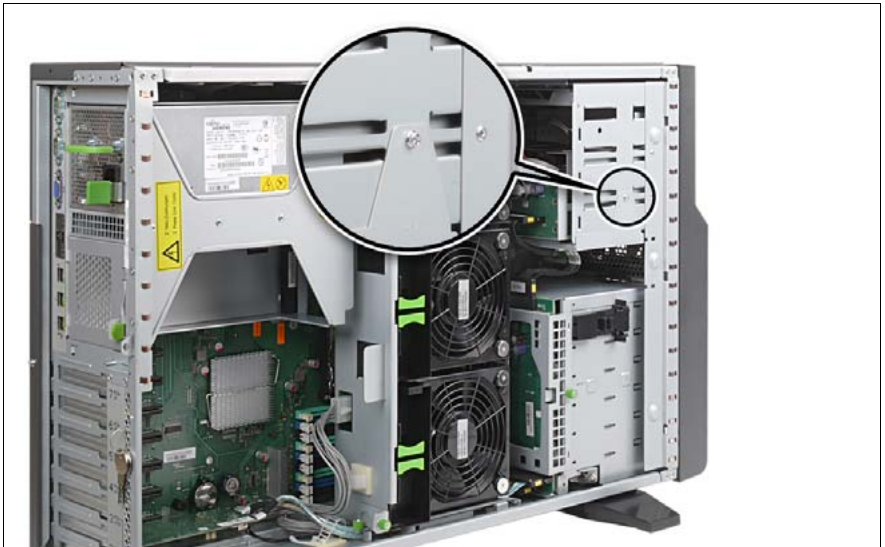

Figure 51: Removing the BBU carrier plate

- ▶ Loosen the screw and remove the BBU carrier plate from the housing.

The BBU carrier plate can accommodate up to three BBUs.

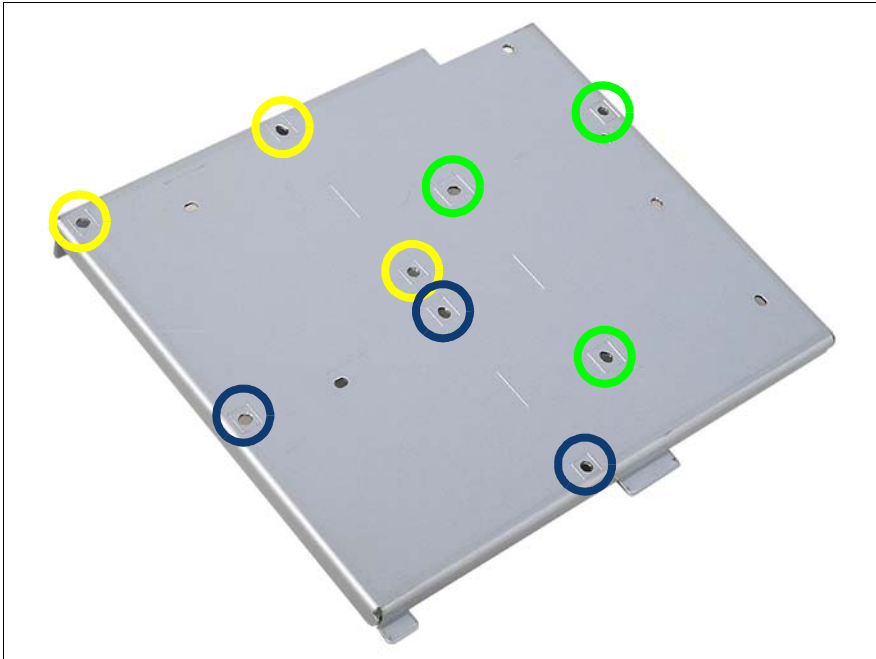

Figure 52: Position of used holes on the BBU carrier plate

First installed BBU: use the blue marked holes to install the BBU.

Second installed BBU: use the yellow marked holes to install the BBU.

Third installed BBU: use the green marked holes to install the BBU.



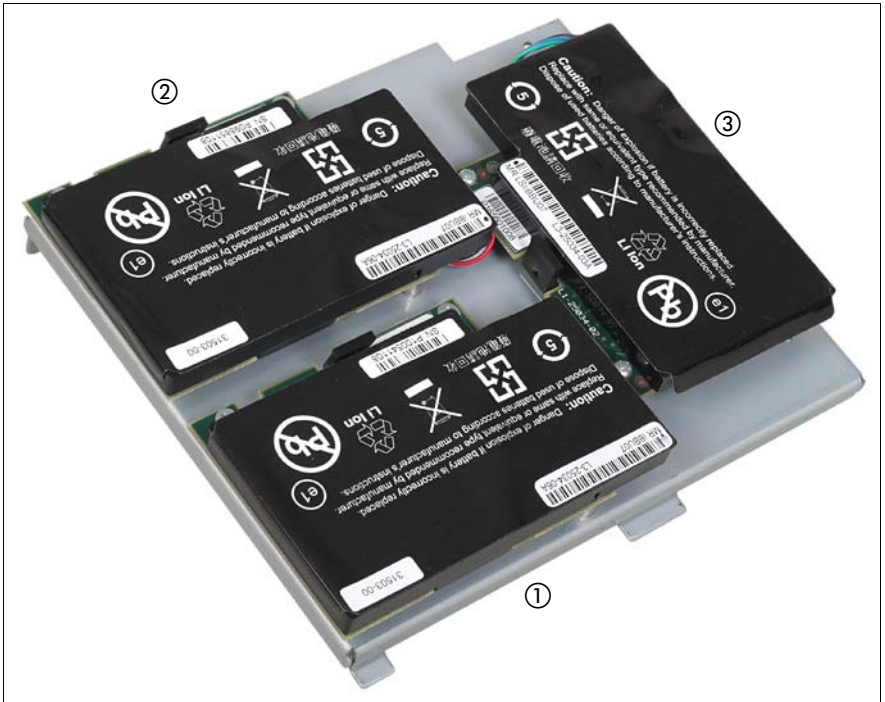

Figure 53: Fastening BBUs onto the BBU carrier plate

- ▶ Fasten each BBU onto the BBU carrier plate in the specified order using the three screws included in the BBU kit.

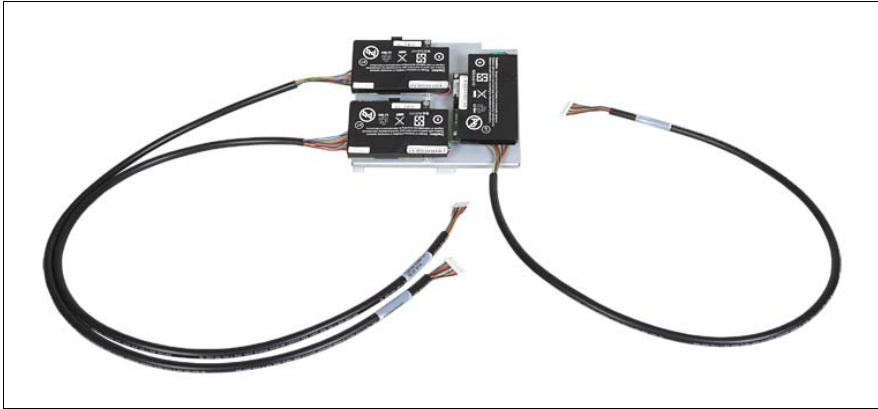
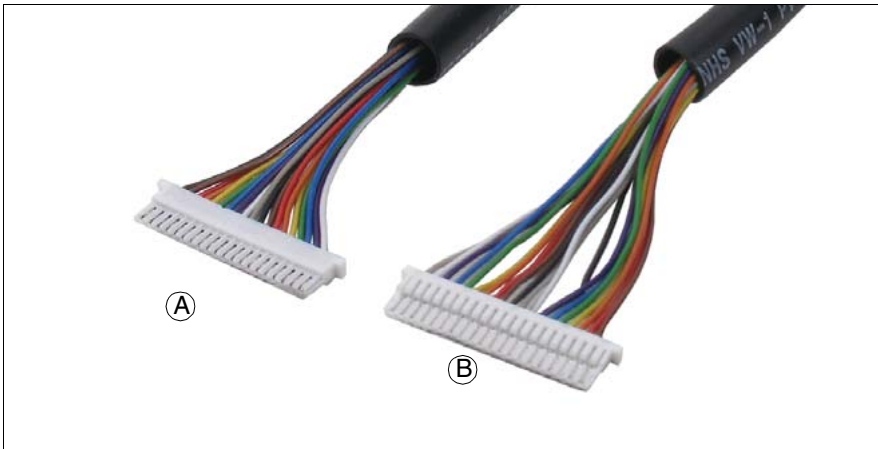

Figure 54: Connecting the cable to the BBU

- ▶ Connect the BBU cables to the BBUs.



**CAUTION!**

Make sure that connector side A (one pin row) is facing the BBU.

If connector side B (two pin rows) is facing the BBU, you risk short-circuits.

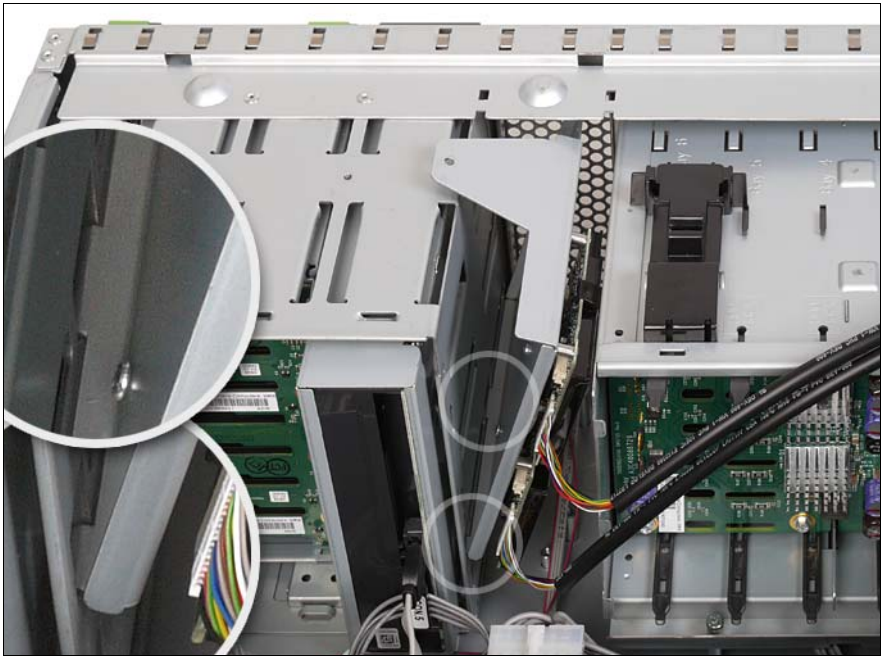

Figure 55: Inserting the BBU carrier plate

- ▶ Insert the BBU carrier plate in the recesses of the drive cage (see circles).

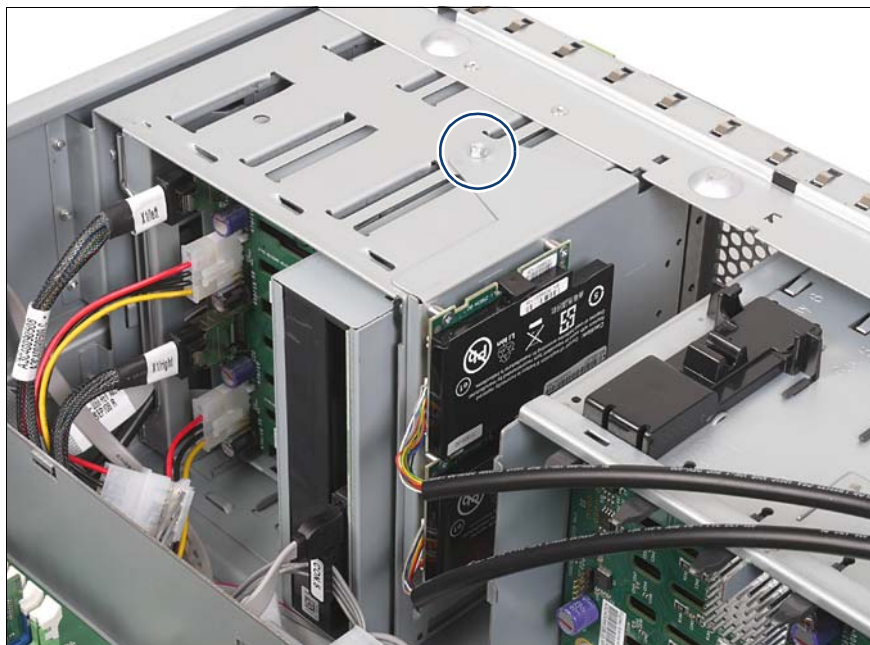

Figure 56: Fastening the BBU carrier plate

- ▶ Close the BBU carrier plate at the top onto the drive cage.
- ▶ Fasten the BBU carrier plate to the drive cage using the M3 x 6 mm screw (see circle).

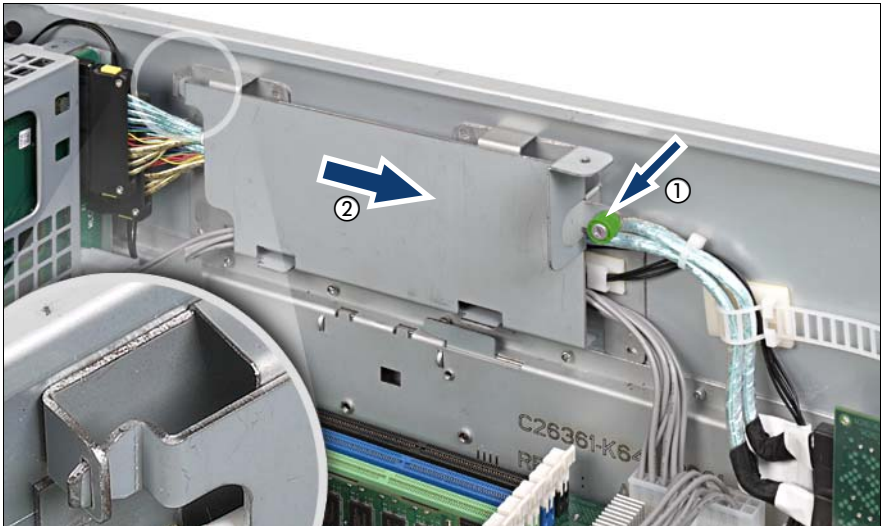

Figure 57: Opening the cable cover

- ▶ Loosen the knurled screw on the cable cover (1) and push the cable cover in direction of the arrow (2) until the guide releases (see circle).

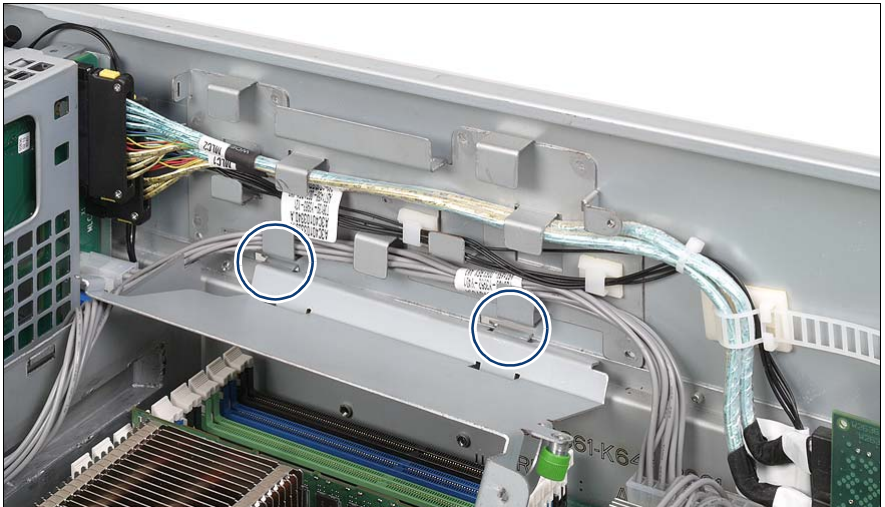

Figure 58: Removing the cable cover

- ▶ Open the cable cover and pull it out of the guide (see circles).

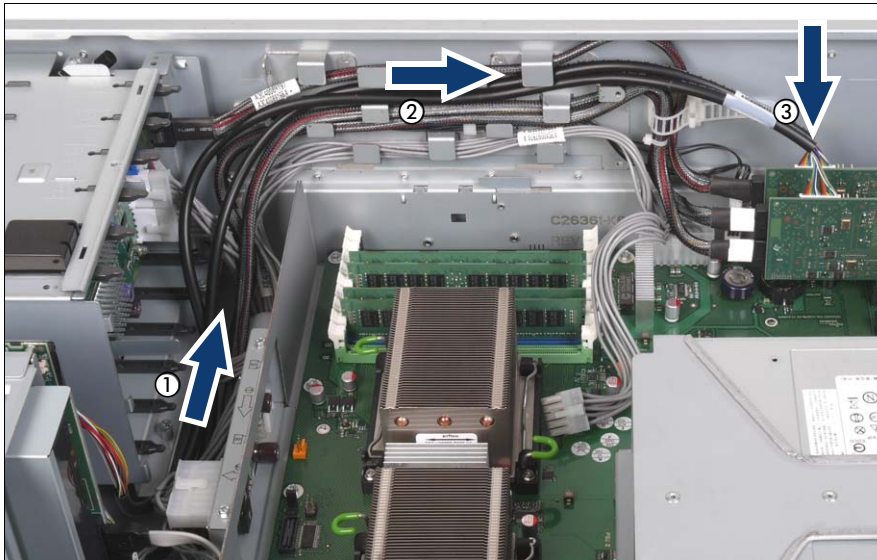

Figure 59: Routing the first and second BBU cable

- ▶ Route the first and the second BBU cable through the cable guides as shown (1 + 2).
- ▶ Connect the cables to the expansion cards (3).

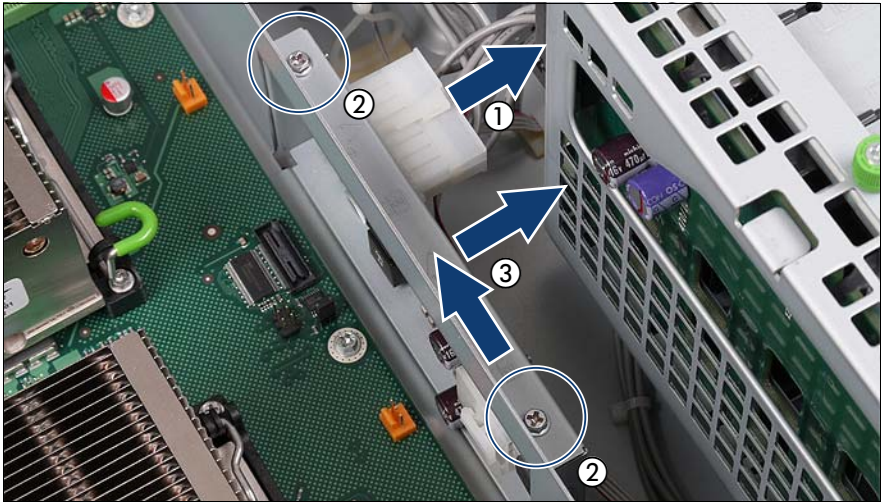

Figure 60: Removing the voltage converter holder

To route the third BBU cable, the voltage converter holder must be removed:

- ▶ Remove the power cable (1).
- ▶ Remove the two screws (2).
- ▶ Push the voltage converter holder in the direction of the arrow and remove it (3).

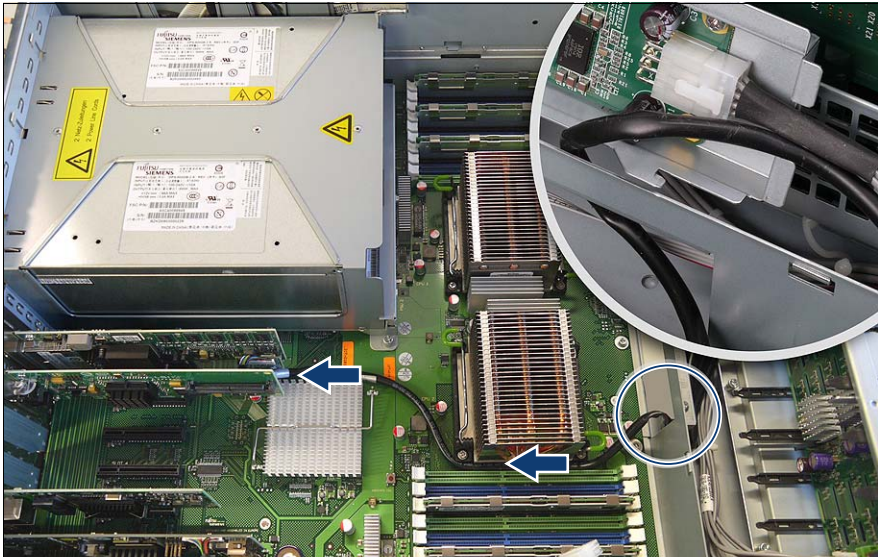

Figure 61: Threading the third BBU cable through the cable opening

- ▶ Thread the third BBU cable through the opening belonging to the voltage converter holder (see circle).
- ▶ Route the third BBU cable between the secondary processor socket and the memory slots.





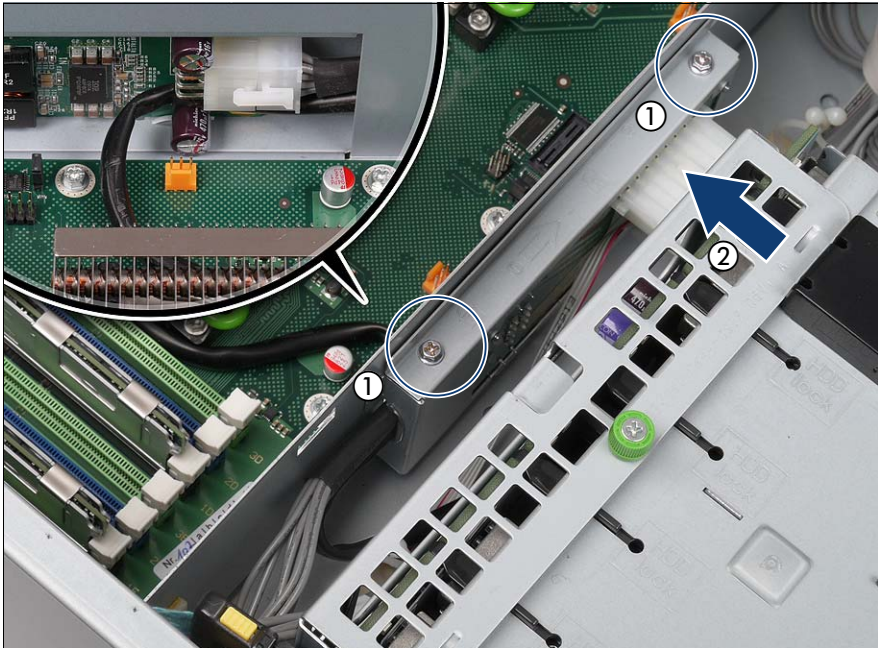

Figure 63: Securing the voltage converter holder

- ▶ Secure the voltage converter holder with the two screws (1).
- ▶ Reconnect the power cable (2).

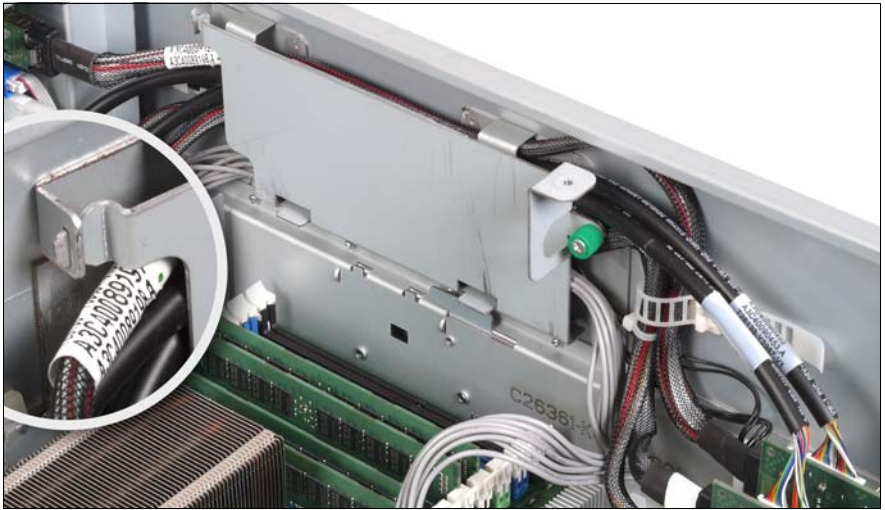

Figure 64: Inserting and fastening the cable cover

- ▶ Insert the cable cover in the recesses.
- ▶ Close the cable cover at the top.
- ▶ Make sure that the third guide engages in the recess of the cable guide (see circle).
- ▶ Secure the cable cover with the knurled screw.
- ▶ Reinstall the fan carrier as described in the [section "Installing the fan carrier" on page 105](#).
- ▶ Close the server, connect it to the power outlet, and switch it on as described in the [chapter "Completion" on page 105](#).



# 9 Further options



## CAUTION!

Follow the safety instructions in the [chapter "Safety instructions" on page 19](#).

## 9.1 TPM

The server can be equipped with a TPM (Trusted Platform Module).

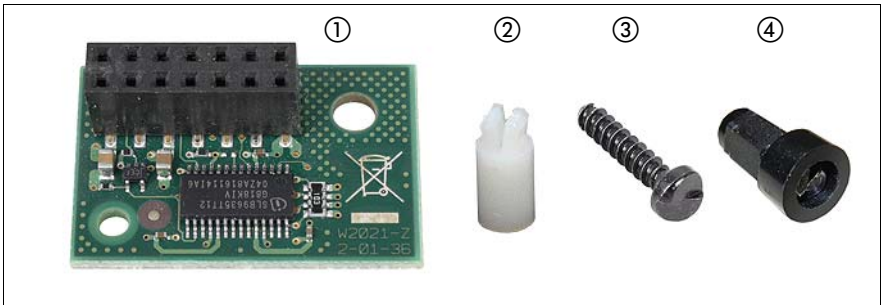

Figure 65: TPM installation kit

1	TPM (Trusted Platform Module)	3	Special screw for TPM
2	TPM spacer	4	TPM screwdriver insert bit for TPM special screw

- ▶ Open the server as described in the [chapter "Preparation" on page 27](#).
- ▶ Pull the hot-plug power supply unit from its slot (description see the Operating Manual).

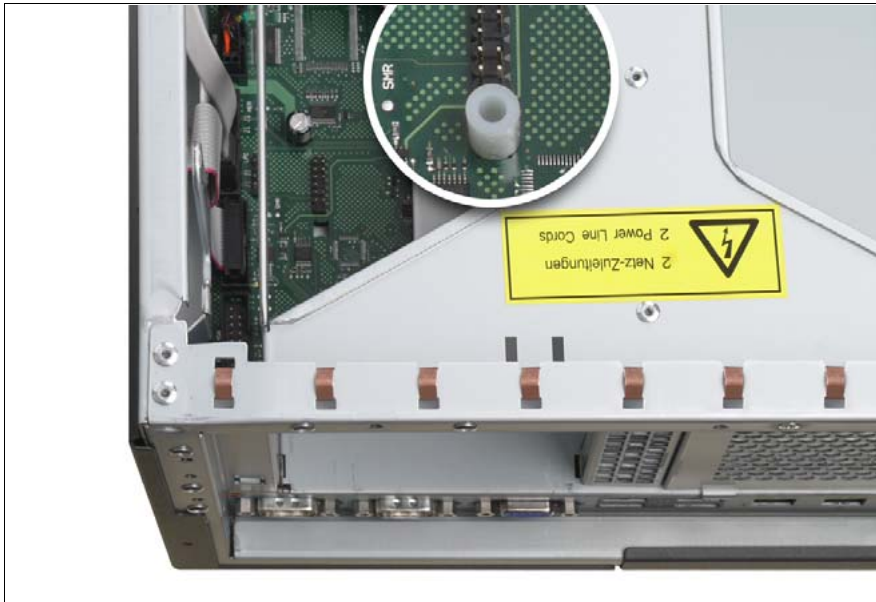

Figure 66: Inserting the TPM spacer on the system board

- ▶ Insert the TPM spacer into the hole on the system board.

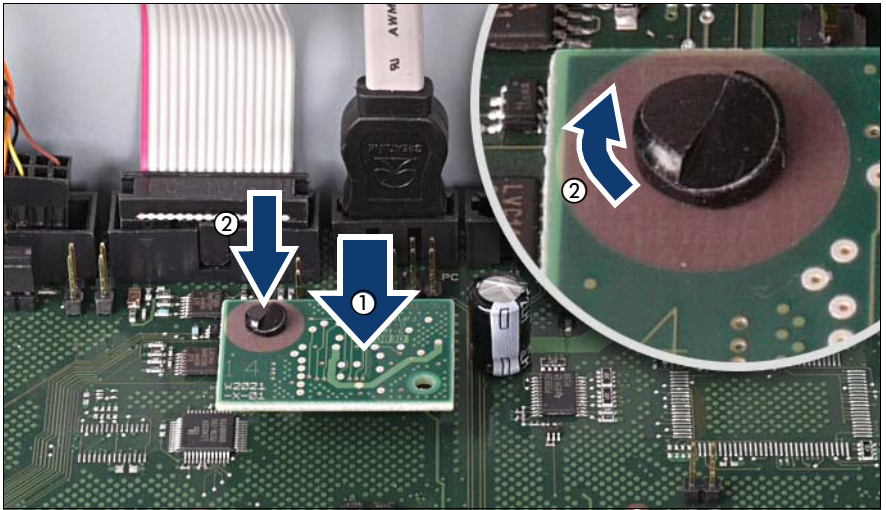

Figure 67: Securing the TPM

- ▶ Insert the TPM on the system board (1).
- ▶ Fasten the TPM with the special screw for the TPM (2).

Please use the TPM screwdriver insert bit to tighten the special screw.



Do not fasten the screw too tightly (torque value of 0.6 Nm).

- ▶ Reinstall the hot-plug power supply unit in its slot (description see the Operating Manual).
- ▶ Close the server, connect it to the power outlet, and switch it on as described in the [chapter "Completion" on page 105](#).



You can find information on configuring the TPM in the "D2619-N BIOS Setup Utility for PRIMERGY RX300 S6 and TX300 S6" manual.

## 9.2 USB Flash Module (UFM)

The server can be equipped with a USB Flash Module (UFM).

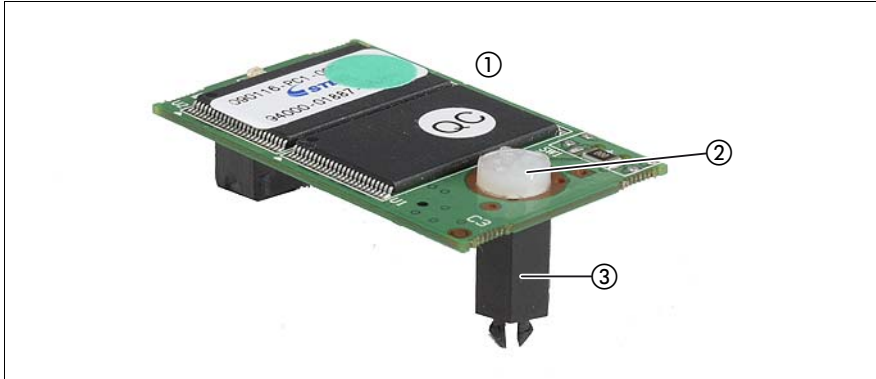

Figure 68: UFM installation kit

1	USB Flash Module (UFM)	3	UFM spacer
2	UFM nylon screw		

- Open the server as described in the [chapter "Preparation" on page 27](#).

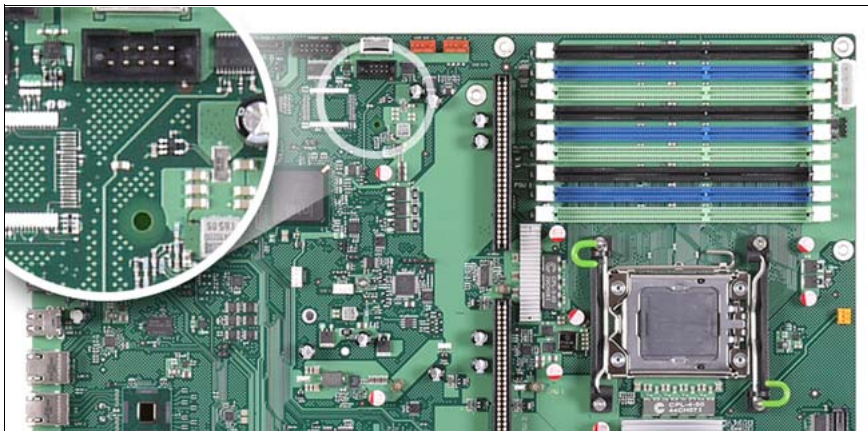

Figure 69: UFM - Position on the system board



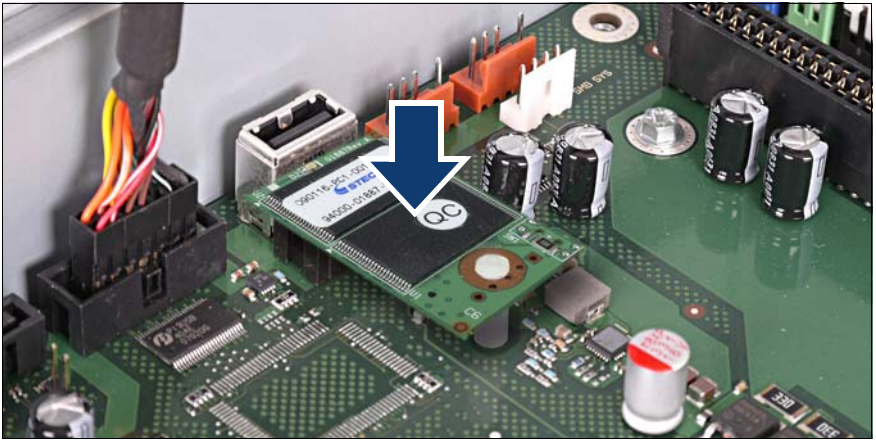

Figure 70: Connecting the UFM to the system board

- ▶ Connect the USB Flash Module to the system board. The spacer must click into the hole on the system board.
- ▶ Close the server, connect it to the power outlet, and switch it on as described in the [chapter "Completion" on page 105](#).



---

## 10 Conversion from a floorstand model to a rack model



### CAUTION!

Follow the safety instructions in the [chapter "Safety instructions" on page 19](#).

- ▶ Open the server and remove the front cover as described in the [chapter "Preparation" on page 27](#).



The front cover is no longer required.

- ▶ Remove the screw on the server rear side that secures the right-hand side cover to the server enclosure.



The right-hand side cover and the top cover build one part.

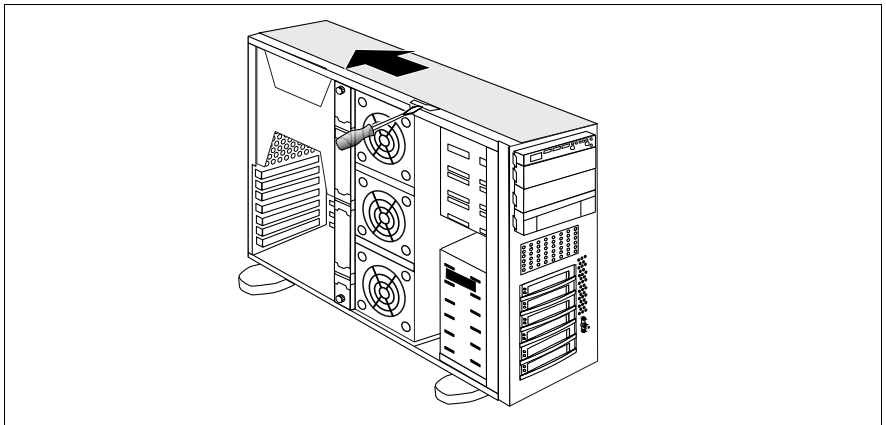

Figure 71: Removing the right-hand side cover

- ▶ Lift the hook up slightly using a screwdriver.
- ▶ Push the right-hand side cover in the direction of the arrow.
- ▶ Lift off the right-hand side cover.



The right-hand side cover is no longer required.

## Conversion from a floorstand model to a rack model

- ▶ If necessary, lay the server on its right-hand side.

Get a second person to help you do this. The server can weigh around 25 - 40 kg (depending on the configuration).

Make sure that the server feet protrude over the table edge.

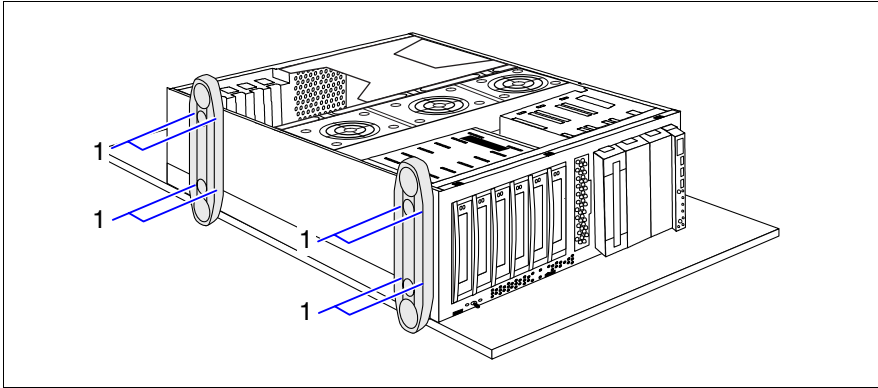

Figure 72: Removing the server feet

- ▶ Remove the four screws on each of the server feet (1).
- ▶ Remove the server feet.



The server feet are no longer required.

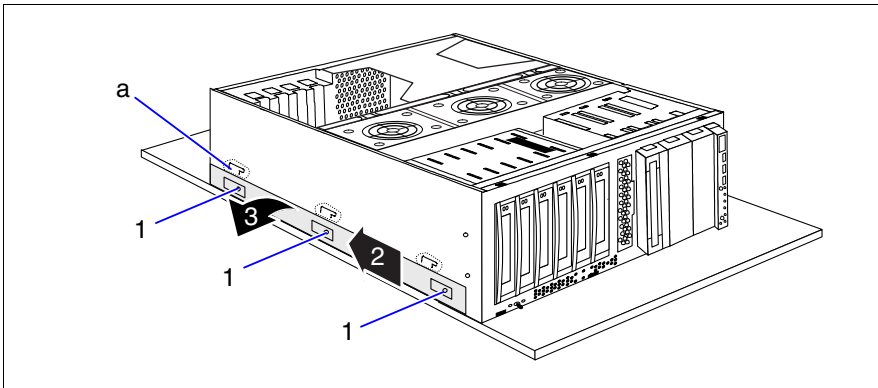



Figure 73: Removing the foot mounting rail

- ▶ Loosen the three screws (1) of the foot mounting rail.

- ▶ Slide the foot mounting rail backward (2) until the hooks (a) disengage.
- ▶ Remove the foot mounting rail (3).

 The foot mounting rail is no longer required.

 The drive cage for the accessible drives is constructed in such a way that the accessible drives and the front panel module can be taken out simply, turned through 90° to the left, and then be reinstalled.

- ▶ Remove the dummy covers from the drive cage (see [figure 26 on page 56](#)).
- ▶ Unplug the cables from the system board or the accessible drives and remove the drives from the drive cage.
- ▶ Pull the front panel module forward out of its mounting location until you can pull the VGA cable, the front panel cable and the USB cable out of the front panel module.
- ▶ Remove the front panel module.
- ▶ Turn the front panel module through 90° to the left.

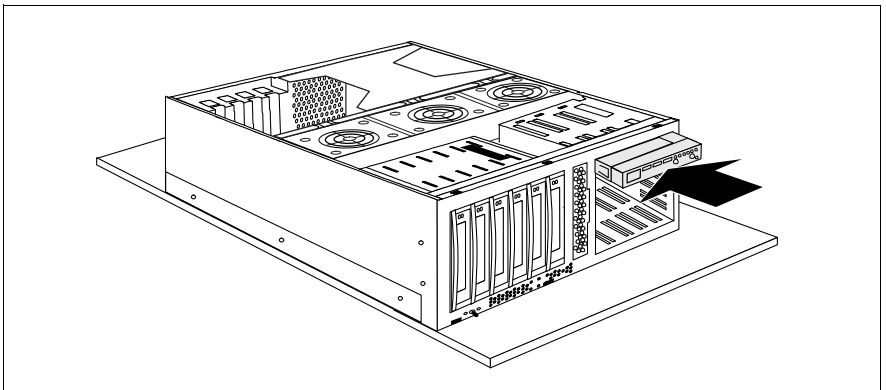

Figure 74: Installing the front panel module

- ▶ Push the front panel module halfway into the upper bay of the drive cage.
- ▶ Connect the VGA cable, the front panel cable and the USB cable to the front panel module.
- ▶ Now push the front panel module fully into the upper bay of the drive cage.
- ▶ Turn the drives removed beforehand through 90° to the left.

## Conversion from a floorstand model to a rack model

---

- ▶ Turn the dummy covers removed beforehand through 90° to the left.
- ▶ Install the drives and empty covers in the drive cage.
- ▶ Reestablish all connections to the drives.
- ▶ Attach the rack front cover as described in the [section "Attaching the rack front cover" on page 111](#).
- ▶ Close the server as described in the [section "Closing the server" on page 112](#).

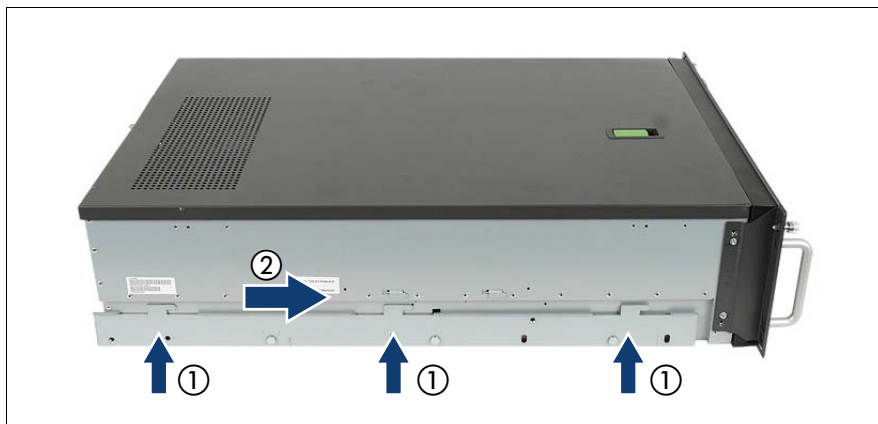

Figure 75: Inserting the rail adapter (shown rail adapter left)

**i** There are a left and a right rail adapter. Proceed the following three steps for both sides of the server.

- ▶ Insert the rail adapter (1).
- ▶ Slide the rail adapter frontward (2) until the hooks (a) engage.



Figure 76: Fastening the rail adapter (shown rail adapter left)

- ▶ Fasten the two screws of the rail adapter.



Figure 77: Attaching labels

- ▶ Attach the Fujitsu label and the PRIMERGY logo and model label to the rack front side.
- ▶ Install the rack model in the rack as described in the operating manual.

## Conversion from a floorstand model to a rack model

---

To enable the rack model to be shown correctly in ServerView Management user interfaces, proceed as follows:

- ▶ Boot the system from the ServerView Suite DVD1. The ServerView Installation Manager is started.
- ▶ In the first window, select your preferred GUI language.
- ▶ Select "No status backup" under "Status backup media", and continue by choosing "Continue".
- ▶ Select "Maintenance".
- ▶ Select "Server Configuration Manager".
- ▶ Activate the box for the rack model and store the setting with choosing "Save".



---

# 11 Completion



## CAUTION!

Follow the safety instructions in the [chapter "Safety instructions" on page 19](#).

## 11.1 Installing the fan carrier

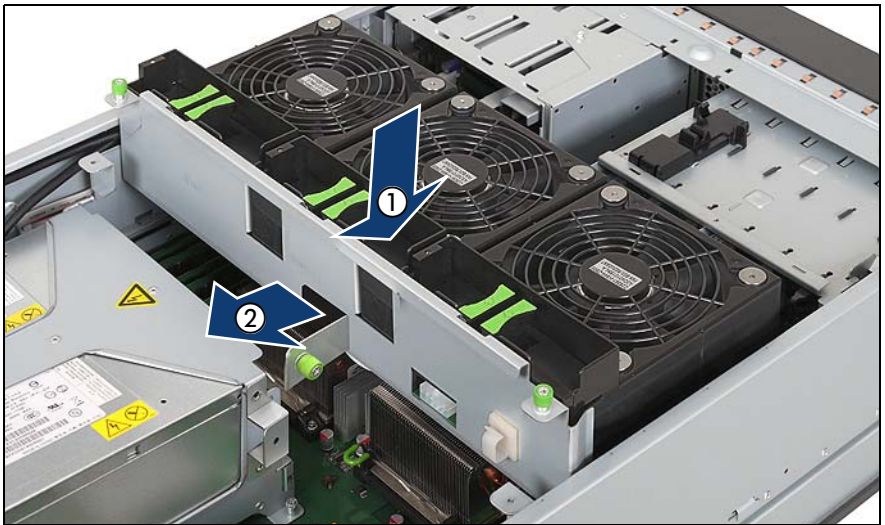

Figure 78: Installing the fan carrier

- ▶ Insert the fan carrier in the server (1).
- ▶ Push the fan carrier in the direction of the arrow (2).



## CAUTION!

Ensure that you do not damage the SAS cables when inserting and sliding in the fan carrier.



Figure 79: Connecting the power cable

- ▶ Fasten the fan carrier with the three knurled screws (1).
- ▶ Connect the power cable to the fan backplane (2).
- ▶ Secure the power cable with the cable clamp (3).

## 11.2 Floorstand model

### 11.2.1 Mounting the server feet



Figure 80: Mounting the server feet

- ▶ If required, reinstall the server feet.

To do this, you need to fasten four M3 x 6 mm screws to each of the server feet (see circles).

## 11.2.2 Attaching the front cover

Reattach the front cover after installing/removing accessible drives.



Figure 81: Attaching the front cover

- ▶ Hook the front cover in place at the top (see circles).
- ▶ Press the front cover against the housing in the direction of the arrow.



Figure 82: Locking buttons engaging

- ▶ Press the two green locking buttons (1) until they engage.



Figure 83: Attaching the HDD cover

- ▶ Hook the drive cover in place at the top and press it against the housing in the direction of the arrow (1).
- ▶ Hook the HDD cover in place at the bottom and press it against the housing in the direction of the arrow (2).

### 11.2.3 Closing the server

**i** The left side cover closes easily when the server is in the horizontal position.

- ▶ Lay the server on its right side.

Ask a second person to help you do this. The server can weigh up to 25-40 kg depending on its configuration.

Ensure that the feet project over the edge of the table.



Figure 84: Closing the server

- ▶ Pull the locking lever as far as it will go and insert the side cover (1).
- ▶ Push the side cover against the housing and at the same time push the locking lever shut (2).

This pushes the side cover forward and locks it in place.

- ▶ Insert the key.
- ▶ Lock the server.
- ▶ Connect all power plugs to the power outlets.
- ▶ Press the On/Off button to start up the server.

## 11.3 Rack model

### 11.3.1 Attaching the rack front cover

Reattach the rack front cover after implementing the following routines:

- Installing/removing accessible drives
- Conversion from a floorstand model to a rack model

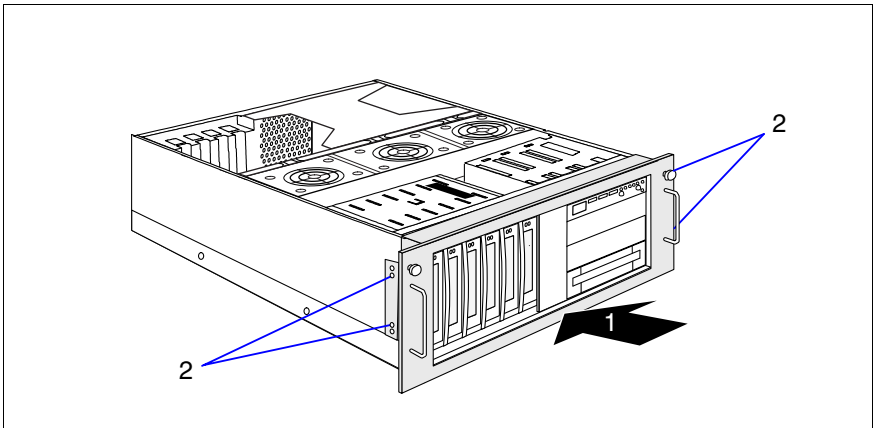

Figure 85: Attaching the rack front cover

- ▶ Attach the rack front cover, together with the plastic front cover, from the front (1).



#### CAUTION!

The rack front cover brackets are marked "Left" and "Right". Position the bracket marked "Left" on the left of the rack front.

- ▶ Attach the rack front cover using two M3 x 6 mm screws on each side (2).

### 11.3.2 Closing the server

- ▶ Pull the locking lever as far as it will go and insert the top cover (see also [figure 84 on page 110](#)).
- ▶ Push the top cover against the housing and push down the locking lever at the same time.

Closing the locking lever pushes the top cover forward and the hooks on the right edge of the top cover engage.

If you have not removed the server from the rack cabinet, please skip steps 1-4.

**CAUTION!**

At least two people are required to install the server in the rack cabinet.

Do not use the handles on the rack front cover to lift the server into the rack.

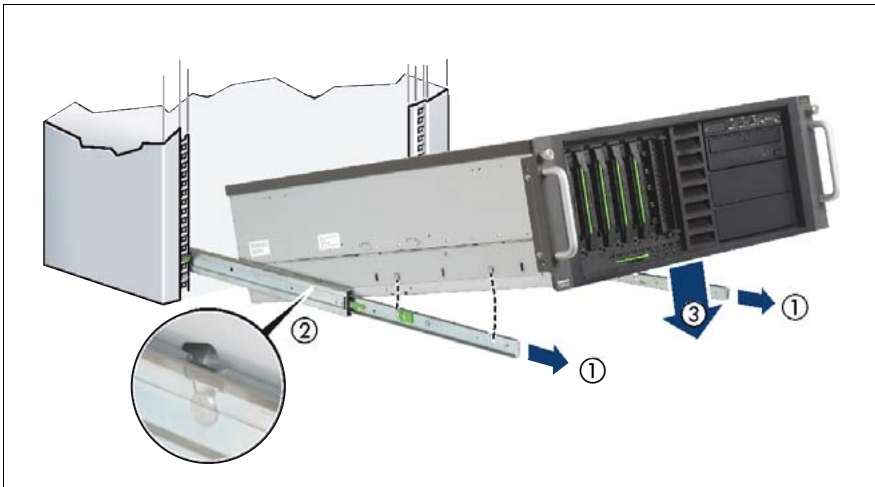

Figure 86: Inserting the server (a)



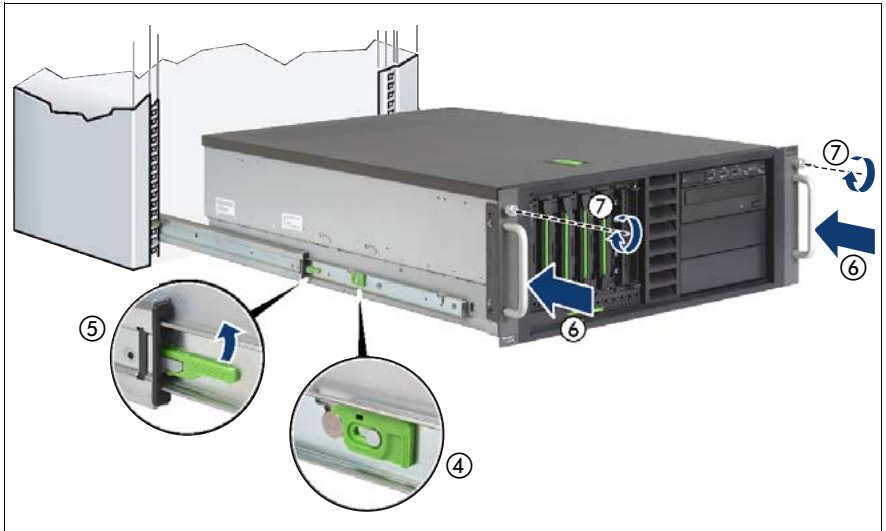



Figure 87: Inserting the server (b)

- ▶ Extend the telescopic rails completely to the front (1).
- ▶  They must click into place so that they can no longer be moved.
- ▶ Lower the server from above onto the projecting telescopic rails (2), (3). As you do this, the locking bar (4) engages.
- ▶ Push the locking mechanism of both telescopic rails up (5).
- ▶ Push the server as far as it will go into the rack (6).
- ▶ Fasten the server to the rack (7) using the two knurled screws (front panel).
- ▶ Connect all cables on the rear of the server.
- ▶ Connect all power cords to the outlets.
- ▶ Press the On/Off button to start up the server.



---

# 12 Appendix

## 12.1 Cabling

You will find suggestions for cabling on the next pages.



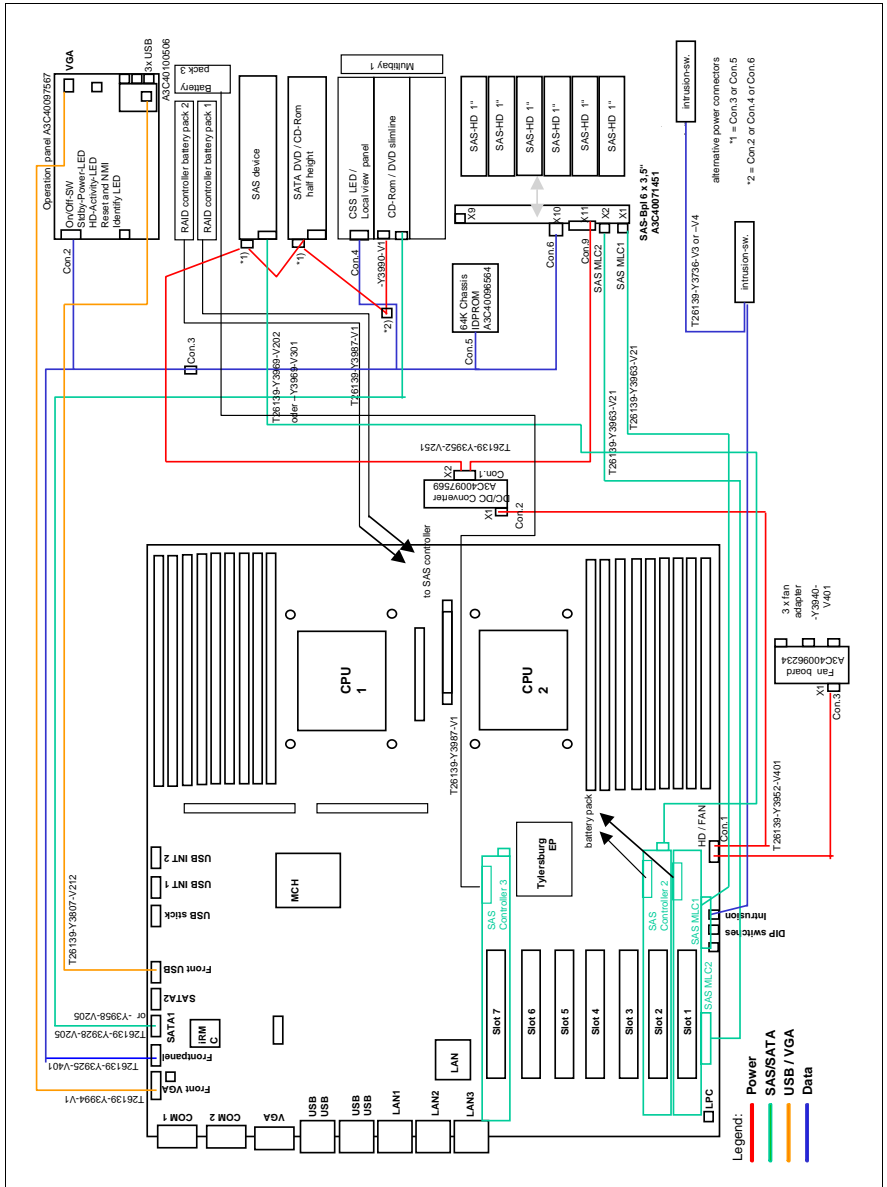

Figure 89: Server with 3.5-inch SAS HDDs and SAS backup

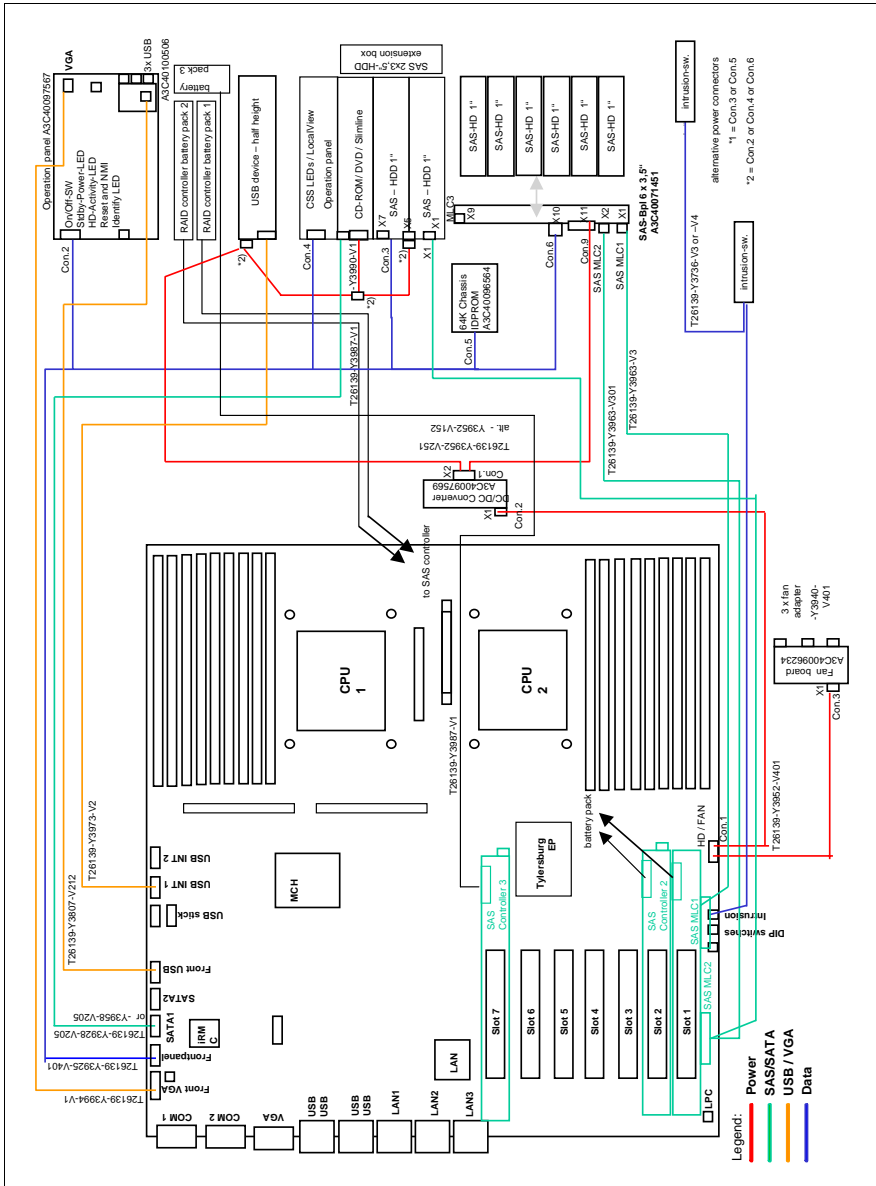

Figure 90: Server with 3.5-inch SAS HDDs and USB backup

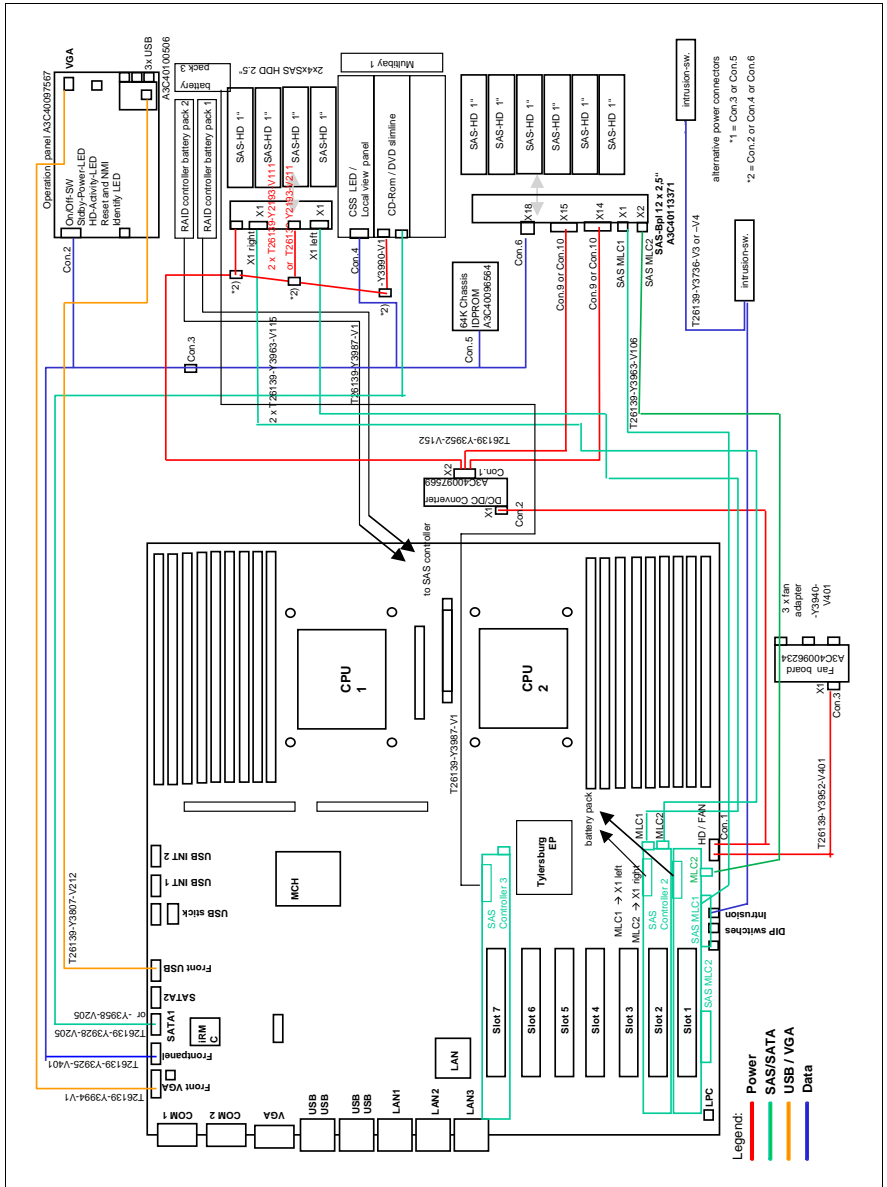

Figure 91: Server with 2.5-inch SAS HDDs and 2.5-inch HDD extension box

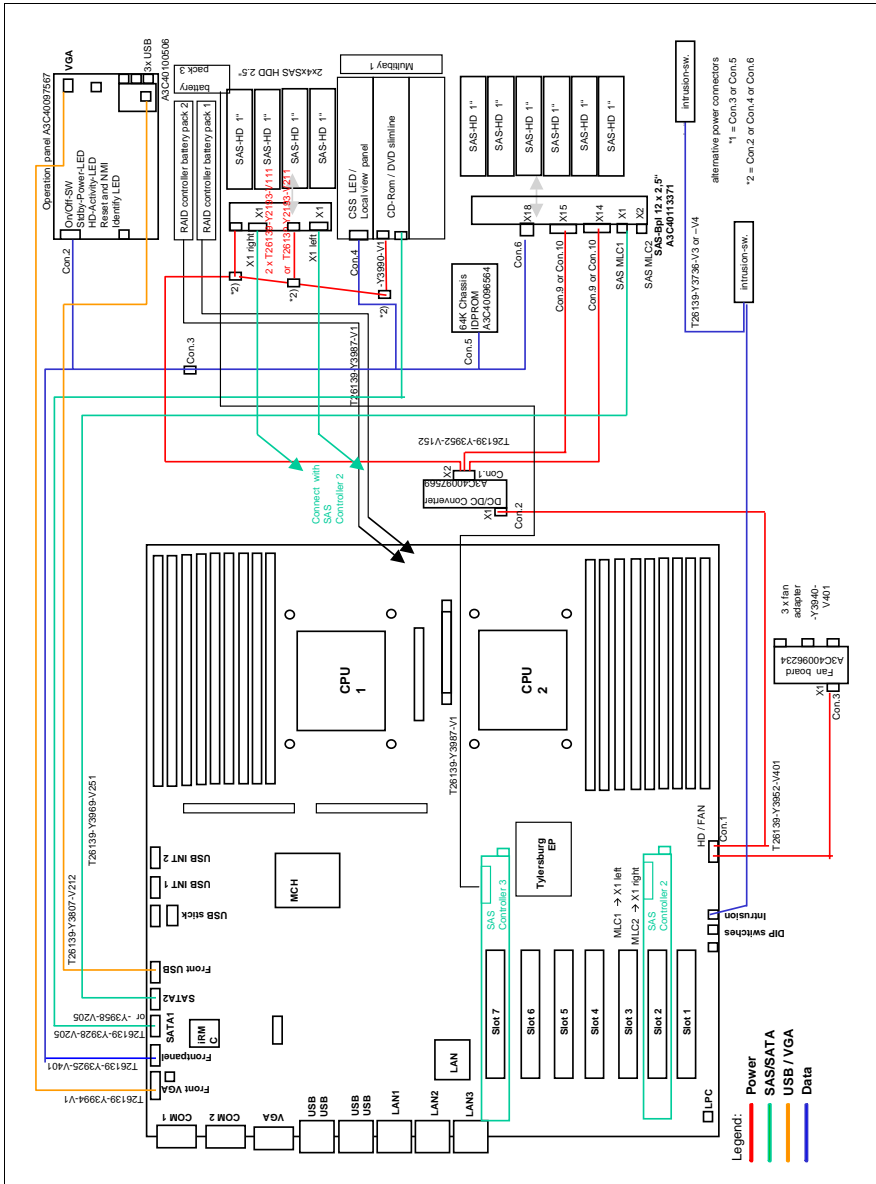

Figure 92: Server with 2.5-inch SAS HDDs (onboard SAS) and 2.5-inch HDD extension box



---

# Index

## A

- accessible drives
  - attaching EasyClick rails [58](#)
  - detaching EasyClick rails [57](#)
  - DVD burner [14](#)
  - DVD drive [14](#)
  - equipping bays [54](#), [55](#)
  - installing Multibay 1 [64](#)
  - magnetic tape drive [14](#)
  - removing dummy cover [56](#)
  - ServerView Local Service
    - Display [14](#)

appendix [115](#)

## B

- Battery Backup Unit [79](#)
- BBU [15](#)
  - installing [79](#)

## C

- cabling [115](#)
- cabling plan [115](#)
- conversion
  - floorstand to rack model [16](#), [99](#)

## D

- dual operation [42](#), [47](#)
- DVD drive [58](#)

## E

- EasyClick rails
  - attaching [58](#)
  - detaching [57](#)
- electrostatic-sensitive devices (ESD) [25](#)
- equipping bays [54](#), [55](#)
- expansion card [15](#)
  - BBU [79](#)
  - installing [76](#)

## F

- fan carrier
  - installing [105](#)
  - removing [35](#)
- floorstand model
  - attaching front cover [108](#)
  - closing [110](#)
  - mounting server feet [107](#)
  - opening [28](#)
  - removing front cover [29](#)
  - removing server feet [31](#)
- floorstand to rack model
  - conversion [16](#), [99](#)
- front cover
  - attaching [108](#)
  - removing [29](#)

## H

- HDD extension box
  - 2.5-inch hard disks [68](#)
  - 3.5-inch hard disks [68](#)

## I

- information, additional [13](#)

## L

- laser information [25](#)
- light emitting diode (LED) [25](#)
- lithium battery [23](#)
- LSD [59](#)
- LSP [59](#)

## M

- meaning of the symbols [16](#)
- multi-processor operating system [42](#), [47](#)
- Multibay 1
  - equipping [59](#)
  - installing [64](#)
  - installing DVD drive [61](#)
  - installing LSD [60](#)

## Index

---

installing LSP [60](#)

Multibay 2 [68](#)

installing [70](#)

## N

notational conventions [16](#)

## R

rack front cover

attaching [111](#)

removing [34](#)

rack model

opening [32](#)

removing rack front cover [34](#)

removing dummy cover [56](#)

## S

SAS/SATA RAID controller

BBU [79](#)

server

closing [110](#)

opening [28, 32](#)

server feet

mounting [107](#)

removing [31](#)

ServerView Local Service

Display [15, 59](#)

ServerView Local Service Panel [15,](#)

[59](#)

## T

target group [12](#)

TPM [15, 93](#)

Trusted Platform Module [15, 93](#)

## U

UFM [16, 96](#)

USB Flash Module [16, 96](#)

## Free Manuals Download Website

<http://myh66.com>

<http://usermanuals.us>

<http://www.somanuals.com>

<http://www.4manuals.cc>

<http://www.manual-lib.com>

<http://www.404manual.com>

<http://www.luxmanual.com>

<http://aubethermostatmanual.com>

Golf course search by state

<http://golfingnear.com>

Email search by domain

<http://emailbydomain.com>

Auto manuals search

<http://auto.somanuals.com>

TV manuals search

<http://tv.somanuals.com>