

# PRIMERGY TX200 S6 Server

Operating Manual

## Comments... Suggestions... Corrections...

The User Documentation Department would like to know your opinion of this manual. Your feedback helps us optimize our documentation to suit your individual needs.

Feel free to send us your comments by e-mail to [email: manuals@ts.fujitsu.com](mailto:manuals@ts.fujitsu.com).

## Certified documentation according to DIN EN ISO 9001:2000

To ensure a consistently high quality standard and user-friendliness, this documentation was created to meet the regulations of a quality management system which complies with the requirements of the standard DIN EN ISO 9001:2000.

cognitas. Gesellschaft für Technik-Dokumentation mbH  
[www.cognitas.de](http://www.cognitas.de)

## Copyright and Trademarks

Copyright © 2010 Fujitsu Technology Solutions GmbH.

All rights reserved.

Delivery subject to availability; right of technical modifications reserved.

All hardware and software names used are trademarks of their respective manufacturers.

- The contents of this manual may be revised without prior notice.
- Fujitsu assumes no liability for damages to third party copyrights or other rights arising from the use of any information in this manual.
- No part of this manual may be reproduced in any without the prior written permission of Fujitsu.

Microsoft, Windows, Windows Server, and Hyper V are trademarks or registered trademarks of Microsoft Corporation in the USA and other countries.

Intel and Xeon are trademarks or registered trademarks of Intel Corporation or its subsidiaries in the USA and other countries.

---

## **Before reading this manual**

### **For your safety**

This manual contains important information for safely and correctly using this product.

Carefully read the manual before using this product. Pay particular attention to the accompanying manual "Safety notes and other important information" and ensure these safety notes are understood before using the product. Keep this manual and the manual "Safety notes and other important information" in a safe place for easy reference while using this product.

### **Radio interference**

This product is a "Class A" ITE (Information Technology Equipment). In a domestic environment this product may cause radio interference, in which case the user may be required to take appropriate measures. VCCI-A

### **Aluminum electrolytic capacitors**

The aluminum electrolytic capacitors used in the product's printed circuit board assemblies and in the mouse and keyboard are limited-life components. Use of these components beyond their operating life may result in electrolyte leakage or depletion, potentially causing emission of foul odor or smoke.

As a guideline, in a normal office environment (25°C) operating life is not expected to be reached within the maintenance support period (5 years). However, operating life may be reached more quickly if, for example, the product is used in a hot environment. The customer shall bear the cost of replacing replaceable components which have exceeded their operating life. Note that these are only guidelines, and do not constitute a guarantee of trouble-free operation during the maintenance support period.

### **High safety use**

This product has been designed and manufactured for general uses such as general office use, personal use, domestic use and normal industrial use. It has not been designed or manufactured for uses which demand an extremely high level of safety and carry a direct and serious risk to life or body if such safety cannot be ensured.

---

These uses include control of nuclear reactions in nuclear power plants, automatic airplane flight control, air traffic control, traffic control in mass transport systems, medical devices for life support, and missile guidance control in weapons systems (hereafter, "high safety use"). Customers should not use this product for high safety use unless measures are in place for ensuring the level of safety demanded of such use. Please consult the sales staff of Fujitsu if intending to use this product for high safety use.

### **Measures against momentary voltage drop**

This product may be affected by a momentary voltage drop in the power supply caused by lightning. To prevent a momentary voltage drop, use of an AC uninterruptible power supply is recommended.

(This notice follows the guidelines of Voltage Dip Immunity of Personal Computer issued by JEITA, the Japan Electronics and Information Technology Industries Association.)

### **Technology controlled by the Foreign Exchange and Foreign Trade Control Law of Japan**

Documents produced by Fujitsu may contain technology controlled by the Foreign Exchange and Foreign Trade Control Law of Japan. Documents which contain such technology should not be exported from Japan or transferred to non-residents of Japan without first obtaining authorization in accordance with the above law.

### **Harmonic Current Standards**

This product conforms to harmonic current standard JIS C 61000-3-2.

### **Only for the Japanese market: About SATA hard disk drives**

The SATA version of this server supports hard disk drives with SATA / BC-SATA storage interfaces. Please note that the usage and operation conditions differ depending on the type of hard disk drive used.

Please refer to the following internet address for further information on the usage and operation conditions of each available type of hard disk drive:

<http://primeserver.fujitsu.com/primergy/harddisk/>

---

### **Only for the Japanese market:**



Although described in this manual, some sections do not apply to the Japanese market. These options and routines include:

- USB Flash Module (UFM)
- CSS (Customer Self Service)



---

# Contents

<b>1</b>	<b>Preface</b> . . . . .	<b>11</b>
<b>1.1</b>	<b>Concept and target groups for this manual</b> . . . . .	<b>12</b>
<b>1.2</b>	<b>Documentation overview</b> . . . . .	<b>12</b>
<b>1.3</b>	<b>Features</b> . . . . .	<b>14</b>
<b>1.4</b>	<b>Notational conventions</b> . . . . .	<b>25</b>
<b>1.5</b>	<b>Technical data</b> . . . . .	<b>26</b>
<b>2</b>	<b>Installation steps, overview</b> . . . . .	<b>29</b>
<b>3</b>	<b>Important information</b> . . . . .	<b>31</b>
<b>3.1</b>	<b>Safety instructions</b> . . . . .	<b>31</b>
<b>3.2</b>	<b>ENERGY STAR</b> . . . . .	<b>39</b>
<b>3.3</b>	<b>CE conformity</b> . . . . .	<b>40</b>
<b>3.4</b>	<b>FCC Class A Compliance Statement</b> . . . . .	<b>40</b>
<b>3.5</b>	<b>Transporting the server</b> . . . . .	<b>41</b>
<b>3.6</b>	<b>Notes on installing the server in the rack</b> . . . . .	<b>42</b>
<b>3.7</b>	<b>Environmental protection</b> . . . . .	<b>43</b>
<b>4</b>	<b>Hardware installation</b> . . . . .	<b>45</b>
<b>4.1</b>	<b>Unpacking the server</b> . . . . .	<b>46</b>
<b>4.2</b>	<b>Setting up the floorstand model</b> . . . . .	<b>47</b>
4.2.1	Mounting the anti-tilt bracket . . . . .	48
<b>4.3</b>	<b>Installing/removing the rack model</b> . . . . .	<b>49</b>
4.3.1	Rack system requirements . . . . .	49
4.3.2	Installation in PRIMECENTER/DataCenter/ 19-inch standard rack . . . . .	52
4.3.3	Installation in 3rd party racks . . . . .	57

# Contents

---

<b>4.4</b>	<b>Connecting devices to the server</b>	<b>59</b>
<b>4.5</b>	<b>Connecting the server to the mains</b>	<b>60</b>
4.5.1	Using cable ties	62
<b>4.6</b>	<b>Notes on connecting/disconnecting cables</b>	<b>63</b>
<b>5</b>	<b>Starting up and operation</b>	<b>65</b>
<b>5.1</b>	<b>Access to the drives (floorstand model)</b>	<b>65</b>
5.1.1	Access to the accessible drives	65
5.1.2	Access to the HDD modules	67
<b>5.2</b>	<b>Control elements and indicators</b>	<b>68</b>
5.2.1	Front of server	68
5.2.1.1	ID card	69
5.2.1.2	Control elements	69
5.2.1.3	LEDs on the control panel	70
5.2.1.4	Indicators on the drives	71
5.2.2	Rear of server	73
5.2.2.1	Indicators on the connector panel	73
5.2.2.2	Indicators on the hot-plug power supply unit	76
<b>5.3</b>	<b>Switching the server on and off</b>	<b>77</b>
<b>5.4</b>	<b>Configuring the server</b>	<b>79</b>
5.4.1	Configuring the onboard SATA controller	79
5.4.2	Configuring the SAS/SATA RAID controller	79
5.4.3	Configuring the server and installing the operating system with the ServerView Installation Manager	80
5.4.4	Configuring the server and installing the operating system without the ServerView Installation Manager	81
<b>5.5</b>	<b>Cleaning the server</b>	<b>82</b>
<b>6</b>	<b>Property and data protection</b>	<b>83</b>
<b>6.1</b>	<b>BIOS Setup security functions</b>	<b>83</b>
<b>7</b>	<b>Troubleshooting and tips</b>	<b>85</b>
<b>7.1</b>	<b>Power-on indicator remains unlit</b>	<b>85</b>
<b>7.2</b>	<b>Server switches itself off</b>	<b>86</b>



<b>7.3</b>	<b>Screen remains blank</b> . . . . .	<b>86</b>
<b>7.4</b>	<b>Flickering stripes on monitor screen</b> . . . . .	<b>87</b>
<b>7.5</b>	<b>No screen display or display drifts</b> . . . . .	<b>87</b>
<b>7.6</b>	<b>Incorrect date and time</b> . . . . .	<b>88</b>
<b>7.7</b>	<b>Drives reported as "dead" when starting system</b> . . . . .	<b>88</b>
<b>7.8</b>	<b>Added drive reported as defective</b> . . . . .	<b>89</b>
<b>7.9</b>	<b>Error message on screen</b> . . . . .	<b>89</b>
<b>8</b>	<b>CSS components</b> . . . . .	<b>91</b>
<hr/>		
<b>8.1</b>	<b>Hot-plug components</b> . . . . .	<b>92</b>
8.1.1	Hot-plug power supply units (optional) . . . . .	92
8.1.1.1	Replacing the hot-plug power supply unit . . . . .	92
8.1.2	Hot-plug hard disk drives . . . . .	93
8.1.2.1	3.5-inch HDD module and dummy module . . . . .	95
8.1.2.2	2.5-inch HDD module and dummy module . . . . .	96
8.1.2.3	Handling hard disk drives and HDD modules . . . . .	97
8.1.2.4	Floorstand: removing the hard disk cover . . . . .	98
8.1.2.5	Removing/installing the dummy module . . . . .	99
8.1.2.6	Installing the HDD module . . . . .	100
8.1.2.7	Removing the HDD module . . . . .	102
<b>8.2</b>	<b>Non-hot-plug components</b> . . . . .	<b>103</b>
8.2.1	Opening the server and identifying the defective CSS component . . . . .	104
8.2.1.1	Opening the server . . . . .	104
8.2.1.2	Removing system fan 2 (and 4) . . . . .	105
8.2.1.3	Removing system fan 1 (and 3) . . . . .	106
8.2.1.4	Identifying a CSS component . . . . .	107
8.2.2	Replacing a memory module . . . . .	108
8.2.2.1	Removing a defective memory module . . . . .	108
8.2.2.2	Installing a new memory module . . . . .	108
8.2.3	Replacing the system fan . . . . .	109
8.2.3.1	Replacing system fan 2 (and 4) . . . . .	109
8.2.3.2	Replacing system fan 1 (and 3) . . . . .	109
8.2.4	Replacing an expansion card . . . . .	110
8.2.4.1	Removing a defective expansion card . . . . .	110
8.2.4.2	Installing a new expansion card . . . . .	111
8.2.5	Reinstalling the fans and closing the server . . . . .	112

# Contents

---

- 8.2.5.1      Installing system fan 1 (and 3) . . . . . 112
- 8.2.5.2      Installing system fan 2 (and 4) . . . . . 113
- 8.2.5.3      Closing the server . . . . . 114
  
- 9            Appendix: server specification . . . . . 115**

---

- Index . . . . . 121**

---

---

# 1 Preface

The PRIMERGY TX200 S6 server is an Intel-based server for mid-size and large companies. The server is suitable for use as a file server and also as an application, information or Internet server. It is available as a floorstand or rack model. The floorstand model can be converted to a rack model using an optional conversion kit.

Due to its advanced hardware and software components, the PRIMERGY TX200 S6 server offers a high level of data security and availability. These components include hot-plug HDD modules, optional hot-plug power supply units, optional redundant system fans, the Server Management ServerView Suite, Prefailure Detection and Analysis (PDA) and Automatic Server Reconfiguration and Restart (ASR&R).

Security functions in the BIOS-Setup and on the system board protect the data on the server against manipulation. Additional security is provided by the intrusion detection and the completely lockable chassis of the floorstand model or the lockable rack door.

The rack model occupies 5 height units in the rack.

### 1.1 Concept and target groups for this manual

This operating manual describes how to install, set up and operate your server.

This operating manual is intended for those responsible for installing the hardware and ensuring that the system runs smoothly. It contains all the information you need to put your PRIMERGY TX200 S6 into operation.

To understand the various expansion options, you will need to be familiar with the fields of hardware and data transmission and you will require a basic knowledge of the underlying operating system.

### 1.2 Documentation overview

More information on your PRIMERGY TX200 S6 can be found in the following documents:

- "Quick Start Hardware - PRIMERGY TX200 S6" leaflet  
"はじめにお読みください -PRIMERGY TX200 S6" for the Japanese market  
(only included as a printed copy)
- "Quick Start Software - Quick Installation Guide" DVD booklet  
(only included with the ServerView Suite as a printed copy) except for the Japanese market
- "Safety notes and other important information" manual  
"安全上の注意およびその他の重要情報" for the Japanese market
- "Warranty" manual  
"保証書" for the Japanese market
- "ServerView Suite Local Service Concept - LSC" manual
- "Returning used devices" manual and "Service Desk" leaflet  
"サポート&サービス" for the Japanese market
- "PRIMERGY TX200 S6 Server Operating Manual"
- "PRIMERGY TX200 S6 Server Options Guide"
- "System Board D2799 for PRIMERGY TX200 S6 Technical Manual"
- "D2799 BIOS Setup Utility for TX200 S6" manual



PRIMERGY manuals are available in PDF format on the ServerView Suite DVD 2. The ServerView Suite DVD 2 is part of the ServerView Suite supplied with every server.

If you no longer have the ServerView Suite DVDs, you can obtain the relevant current versions using the order number U15000-C289 (the order number for the Japanese market: please refer to the configurator of the server <http://primeserver.fujitsu.com/primergy/system.html>).

The PDF files of the manuals can also be downloaded free of charge from the Internet. The overview page showing the online documentation available on the Internet can be found using the URL (for EMEA market): <http://manuals.ts.fujitsu.com>. The PRIMERGY server documentation can be accessed using the *Industry standard servers* navigation option.

For the Japanese market please use the URL:  
<http://primeserver.fujitsu.com/primergy/manual.html>.

#### Further sources of information:

- PRIMERGY Abbreviations and Glossary on the ServerView Suite DVD 2
- Manual for the monitor
- Documentation for the boards and drives
- Operating system documentation
- Information files in your operating system

### 1.3 Features

#### Customer Self Service (CSS)

The PRIMERGY Customer Self Service (CSS) concept enables you to identify and replace the affected component yourself in the case of certain error scenarios.

In the CSS concept, you can replace the following components yourself in the event of an error:

- Hot-plug hard disk drives
- Hot-plug power supply units
- Memory modules
- System fans
- Expansion cards

For information on replacing these components, see chapter "[CSS components](#)" on page 91.

CSS indicators on the control panel and on the back of the PRIMERGY server provide you with information if a CSS event arises (for more information on the behavior of these indicators, see chapter "[Starting up and operation](#)" on page 65 and the "ServerView Suite Local Service Concept - LSC" manual on the ServerView Suite DVD 2).

You can also fit your server with a ServerView Local Service Panel, which enables you to identify the type of component affected by the error directly on the server (for more information, see the "ServerView Suite Local Service Concept - LSC" manual on the ServerView Suite DVD 2).

In addition, CSS errors are displayed in the ServerView Operations Manager, the server management software from Fujitsu.

In the event of errors, the ServerView Operations Manager refers you directly to the affected component and its order information in the Illustrated Spares catalog of the server in question. (This feature is not available for the Japanese market.)

## System board

The features of the system board are described in the technical manual for the system board D2799 for the hardware and in the BIOS Setup manual for the firmware.

## Trusted Platform Module (TPM)

A Trusted Platform Module (TPM) for safer storage of keys can be implemented as an option. This module enables programs from third party manufacturers to store key information (e.g. drive encryption using Windows Bitlocker Drive Encryption).

The TPM is activated via the BIOS system (for more information, refer to the "D2799 BIOS Setup Utility for TX200 S6" manual).



### CAUTION!

- When using the TPM, note the program descriptions provided by the third party manufacturers.
- You must also create a backup of the TPM content. To do this, follow the third party manufacturer's instructions. Without this backup, if the TPM or the system board is faulty you will not be able to access your data.
- If a failure occurs, please inform your service about the TPM activation before it takes any action, and be prepared to provide them with your backup copies of the TPM content.

## Slots for expansion cards

The server can be expanded flexibly via six slots (one 32-bit PCI, two PCIe Gen2 x8, and three PCIe Gen2 x4).

PCIe Gen2 doubles the bandwidth of currently existing PCIe busses and allows improved system performance.

### Hard disk drives

The server is shipped with one of the following drive cages:

- For up to four 3.5-inch SAS/SATA hard disk drives:

Up to four SAS/SATA HDD modules can be used in the drive cage. Each HDD module can accommodate a SAS/SATA hard disk drive with a maximum height of 1 inch. The module is connected to the SAS/SATA backplane wirelessly. This allows HDD modules to be plugged in and pulled out easily.

As an option, a hard disk extension box (with a maximum of two SAS/SATA HDD modules) can be installed (see section "[Accessible drives](#)" on [page 18](#)).



Up to four SATA hard disk drives are controlled by the onboard SATA controller. An additional SAS/SATA RAID controller must be installed to control additional SATA hard disk drives or SAS hard disk drives.

- For up to eight 2.5-inch SAS/SATA hard disk drives:

Up to eight SAS/SATA HDD modules can be used in the drive cage. Each HDD module can accommodate an SAS/SATA hard disk drive with a 2.5-inch format. The modules are connected to the SAS/SATA backplane wirelessly. This allows HDD modules to be plugged in or pulled out easily.

As an option, a hard disk extension box (with a maximum of eight SAS/SATA HDD modules) can also be installed (see section "[Accessible drives](#)" on [page 18](#)).



Up to eight SAS/SATA hard disk drives are controlled by the SAS/SATA RAID controller already installed. The hard disk extension box for 2.5-inch SAS hard disk drives requires an additional SAS/SATA RAID controller.

If the server has the corresponding RAID configuration, HDD modules can also be replaced during operation.



## Onboard SATA controller

A SATA controller is integrated on the system board; up to four SATA hard disk drives can be connected to the controller. The LSI Embedded MegaRAID software (SATA Software RAID) supports RAID levels 0, 1 and 10.

For more information on configuring the controller, see section ["Configuring the onboard SATA controller" on page 79](#).

## SAS/SATA RAID controller

The server is available with the following SAS/SATA RAID controllers for operating the internal SAS/SATA hard disk drives:

- Modular RAID 0/1 controller with "Integrated Mirroring Enhanced" (SAS IME) for SAS1.0

RAID levels 0, 1 and 1E are supported for internal hard disk drive configurations.



For the Japanese market only RAID level 1 is supported for internal hard disk drive configurations.

- Modular RAID 0/1 controller with "MegaRAID functionality" (SAS MegaRAID) for SAS1.0 and SAS2.0

RAID levels 0, 1, 10 and 1E are supported for internal hard disk drive configurations.

- Modular RAID 5/6 controller with "MegaRAID functionality" (SAS MegaRAID) for SAS1.0 and SAS2.0

RAID levels 0, 1, 10, 1E, 5, 50, 6 and 60 are supported for internal hard disk drive configurations. As an option, a battery backup unit (BBU) can save the memory content even if the power fails. Cache memory size of 512 Mbyte is available.



For more information on configuring the controller, see section ["Configuring the onboard SATA controller" on page 79](#).

Further information on SAS/SATA RAID controllers is provided in the "Modular RAID Controller Installation Guide" (on ServerView Suite DVD 2 under *Industry Standard Servers - Expansion Cards - Storage Adapters - LSI RAID / SCSI Controllers*).

Further information on other SAS/SATA RAID controllers (e.g. for operating external SAS/SATA hard disk drives or tape drives) is available on ServerView Suite DVD 2 under *Industry Standard Servers - Expansion Cards - Storage Adapters - LSI RAID / SCSI Controllers*.

### Accessible drives

The server has three 5.25-inch bays that can be used in various ways:

The individual bays can be equipped with any 3.5-inch drives (height: 1.6 inch).

You can install a multibay (DVD-LSD/LSP) in the top bay. You can install a slimline DVD drive and the ServerView Local Service Display or ServerView Local Service Panel in the multibay (DVD-LSD/LSP).

The following expansion boxes are also available depending on the hard disk configuration selected:

- With one drive cage for up to two 3.5-inch SAS hard disk drives:

You can install an extension box for up to two 3.5-inch SAS hard disk drives in the two bottom bays. This box has bays for a slimline DVD drive, the ServerView Local Service Display/ServerView Local Service Panel, and up to two 3.5-inch SAS hard disk drives.

- With a drive cage for up to eight 2.5-inch SAS/SATA hard disk drives:

You can install an extension box for up to eight 2.5-inch SAS/SATA hard disk drives in the two bottom bays.



The HDD extension box for 2.5-inch SAS/SATA hard disk drives requires an additional SAS/SATA RAID controller.



Please note the following:

- A DVD drive must have been installed in order to operate the server.
- The accessible drives cannot be replaced during operation.
- Access to the accessible drives may have to be free in order to operate tape drives (see "[Access to the accessible drives](#)" on [page 65](#)).

## Power supply

In its basic configuration the server has a permanently installed power supply unit or a hot-plug power supply unit that adjusts automatically to any mains voltage in the range 100 V - 240 V. Besides the hot-plug power supply unit, a second hot-plug power supply unit can be installed optionally to serve as a redundant power supply. If one power supply unit fails, the second power supply unit in the redundant configuration ensures operation can continue uninterrupted. The faulty power supply unit can be replaced during operation (for further details see section "[Hot-plug power supply units \(optional\)](#)" on [page 92](#)).

## Cooling

In the standard configuration the server is cooled by two system fans and one power supply fan.

In the optional, redundant configuration the server is cooled by four system fans (two double fans) and one or two power supply fans. If one of the four system fans fails, one of the two predetermined fans (system fan 3 and system fan 4, see the "Options Guide" for the system) increases its power to ensure that the server is cooled properly.

### **High level of availability and data security**

When memory data is accessed, 1-bit errors are identified in the main memory and automatically corrected with the error correcting code (ECC) method. The patented memory scrubbing function regularly starts up the EDC mechanism, ensuring continuous data integrity.

The RDIMM memory modules used support SDDC technology (Chipkill™), which further increases the effectiveness of memory error monitoring and correction.

Memory modules can be protected against failure by mirroring (Memory Mirroring). Memory Mirroring is roughly comparable to RAID level 1 for hard disk arrays. The basic configuration requires two identical memory modules in two different banks.

Support is likewise provided for hot-spare memory technology, in which a memory bank is used like a replacement bank. If a memory module fails, the bank with the defective memory is automatically deactivated and the replacement bank is activated (provided it has been configured for appropriately in the BIOS). The deactivated memory bank is no longer used and the faulty memory module can be replaced during the next system maintenance. In order to be able to use the hot-spare memory function, all occupied memory banks have to be equipped with identical memory modules.

ASR&R (Automatic Server Reconfiguration and Restart) restarts the system in the event of an error and automatically "hides" the defective system components.

The PDA (Prefailure Detection and Analysis) technology from Fujitsu Technology Solutions analyzes and monitors all components that are critical for system reliability.

Optional RAID controllers support RAID levels like 0, 1, 5, ... and increase system availability.

The hot-plug HDD modules provide additional availability.

## iRMC S2 with integrated management LAN connector



The features of the iRMC S2 Advanced Video Redirection and Remote Storage are available as an option.

The iRMC S2 (integrated **R**emote **M**anagement **C**ontroller) is a BMC with integrated management LAN connector and expanded functionality that was previously only available with additional plug-in cards. In this way, the iRMC S2 enables complete control of PRIMERGY servers, regardless of system status, and thus particularly the control of PRIMERGY servers that are in the "out-of-band" system status.

Major functions supported by the iRMC S2 include the following:

- Browser access via iRMC S2-s own Web server
- Secure communication (SSH, SSL)
- Power Management for the managed server (depending on its system status)
- Power Consumption Management
- Connecting virtual drives as remote storage
- Text-based and graphic console bypass (Advanced Video Redirection)
- Command Line Interface (CLI)
- Simple, interactive or script-based iRMC S2 configuration
- Customer Self Service (CSS)
- iRMC S2-s own user management
- Multi-computer, global iRMC S2 user administration using an LDAP Directory Service
- Automatic network configuration via DNS / DHCP
- Power supply of the iRMC S2 via the system standby supply
- Full-coverage alarm management
- System Event Log (SEL) reading and processing

More information about the iRMC S2 can be found in the "iRMC S2 - integrated Remote Management Controller" user's guide (on the ServerView Suite DVD 2 under *Industry Standard Servers - Software - ServerView Suite - Out-Of-Band Management*).

### Server management

Server management is implemented using the ServerView Operations Manager supplied and the PDA (Prefailure Detection and Analysis) technology from Fujitsu. PDA reports the threat of a system error or overload at an early stage, allowing preventive measures to be taken.

The ServerView Operations Manager enables the management of all PRIMERGY servers in the network via a central console. The ServerView Operations Manager supports the following functions:

- Round-the-clock monitoring, regardless of server status
- High-performance, graphical console bypass (AVR) protected by HTTPS/SSL (128 bit)
- Remote storage via USB
- Remote power on
- Intrusion detection in the floorstand model
- Temperature monitoring of the CPU and the surrounding area
- Detailed status and error reports for processors and main memory
- Watchdog timer for Automatic Server Reconfiguration and Restart (ASR&R) in the event that memory modules or processors fail
- Power monitoring
- End-of-life monitoring of fans with prompt notification before failure
- Watchdog timer for monitoring the operating system with ASR&R

Further information on the ServerView Operations Manager is provided in the associated documentation.

## ServerView Installation Manager

You can configure the PRIMERGY server quickly and precisely with the ServerView Installation Manager software provided. User-guided menus are available for installing the server operating system (for further details see section "[Configuring the server](#)" on page 79).

## Service and support

PRIMERGY servers are easy to maintain and modular, thus enabling quick and simple maintenance.

The handles and locks (touch point) used to exchange components are colored green to ensure simple and immediate recognition.

In order to prevent the components from being damaged by incorrect handling when they are being installed and removed, the areas of all components that can be touched without damaging them are also marked green.

PRIMERGY diagnostic LEDs fitted on the system board show which component (memory module, processor, fan or expansion card) is not functioning properly.

The Flash EPROM program supplied with the Fujitsu utilities supports a fast BIOS update.

With the iRMC S2 (integrated Remote Management Controller) on the system board, the PRIMERGY TX200 S6 server can also be maintained and serviced remotely. This enables remote diagnosis for system analysis, remote configuration and remote restart should the operating system or hardware fail.

### ServerView Remote Management

ServerView Remote Management is the remote management solution from Fujitsu for PRIMERGY servers. ServerView Remote Management and the relevant hardware components integrated on the system board allow remote monitoring and maintenance as well as fast restoration of operation in the event of errors.

Remote monitoring and maintenance avoids time-consuming and costly on-site repairs and reduces service costs. This leads to a reduction in the total cost of ownership and an excellent return on investment for the remote management solution.

The administrator can access all system information and information from the sensors such as fan speeds or voltages via the iRMC S2's Web interface (see section ["iRMC S2 with integrated management LAN connector" on page 21](#)). You can also start the text-based or graphic console bypass (Advanced Video Redirection, AVR) and connect virtual drives as remote storage.





The features of the iRMC S2 Advanced Video Redirection and Remote Storage are available as an option.

More information about the iRMC S2 can be found in the "iRMC S2 - integrated Remote Management Controller" user's guide (on the ServerView Suite DVD 2 under *Industry Standard Servers - Software - ServerView Suite - Out-Of-Band Management*).



## 1.4 Notational conventions

The following notational conventions are used in this manual:

<i>Text in italics</i>	indicates commands or menu items.
"Quotation marks"	indicate names of chapters and terms that are being emphasized.
▶	describes activities that must be performed in the order shown.
 <b>CAUTION!</b>	pay particular attention to texts marked with this symbol. Failure to observe this warning may endanger your life, destroy the system or lead to the loss of data.
	indicates additional information, notes and tips.

# 1.5 Technical data

### Electrical data

Rated voltage range	100 V - 240 V
Frequency	47 Hz - 63 Hz
Rated current with basic configuration	100 V oder 240 V / 1.3 A - 0.6 A
Max. rated current	100 V - 127 V oder 200 V - 240 V / 9.5 A - 4.0 A
Effective power	max. 461 W
Apparent power	max. 490 VA
Heat dissipation	1659.6 kJ/h (1573 BTU)
Main power fuse	16 A
Protection class	I

### Compliance with regulations and standards

Product safety and ergonomics	IEC 60950-1 / EN 60950-1, UL/CSA 60950-1, CNS 14336 / GB 4943 / EN 50371
Electromagnetic compatibility	FCC class A CNS 13438 class A; VCCI class A AS/NZS CISPR 22 class A / GB 9254 class A GB 17625
interference emissions	EN 55022 class A
Harmonic current	EN 61000-3-2
Flicker	EN 61000-3-3
interference immunity	EN 55024, EN 300386
CE marking to EU directives	Low Voltage Directive 2006/95/EC (product safety) Electromagnetic compatibility 2004/108/EC
Mechanical environmental conditions	EN 60721-3-3; class 3M2

## Mechanical specifications

	Floorstand	Rack
Width (with anti-tilt bracket)	205 mm (306 mm)	482 mm
Total depth	584 mm	570 mm
Installation depth	-----	596 mm
Height	444 mm	5 HU
Dimension notes	Floorstand width 306 mm with tilt protection; depth measured excludes handles on redundant PSU. Rack depth excludes handles of redundant PSU and rack front.	

## Weight

max. 36.8 kg (depending on configuration).

## Ventilation clearance

At least 200 mm on the front and rear.

## Maintenance area for the floorstand model

1.2 m<sup>2</sup> on the left side. Emergency access must be assured.

## Ambient conditions

Environment class 3K2 Environment class 2K2	EN 60721 / IEC 721 Part 3-3 EN 60721 / IEC 721 Part 3-2
Temperature:	
Operation (3K2)	10 °C .... 35 °C
Transport (2K2)	-25 °C .... 60 °C
Humidity	10% .... 85% (non condensing)

Condensation during operation must be avoided!

## Preface

---

### Noise level with standard fan and standard power supply units

Sound power level $L_{WAd}$ (ISO 9296)	$\leq 5.2$ B (standby) $\leq 5.7$ B (operating)
Sound pressure level at adjacent position $L_{pAm}$ (ISO 9296)	$\leq 34$ dB (A) (standby) $\leq 36$ dB (A) (operating)

### Noise level with redundant system fans and redundant power supply

Sound power level $L_{WAd}$ (ISO 9296)	$\leq 5.5$ B (standby) $\leq 5.9$ B (operating)
Sound pressure level at adjacent position $L_{pAm}$ (ISO 9296)	$\leq 36$ dB (A) (standby) $\leq 39$ dB (A) (operating)

---

## 2 Installation steps, overview

This chapter contains an overview of the steps you need to carry out to install your server. Links take you to sections where you can find more detailed information about the respective steps:

- ▶ At first, please take notice of the safety instructions in chapter "[Important information](#)" on page 31 and following.
- ▶ Unpack the system, check the contents of the package for visible transport damage and check whether the items delivered match the details on the delivery note (see section "[Unpacking the server](#)" on page 46).
- ▶ Transport the server to the place where you want to set it up.
- ▶ Make sure that you have all necessary manuals (see "[Documentation overview](#)" on page 12); print out the PDF files if required.
- ▶ Components that have been ordered additionally may be delivered loose with the server. Install these in the server as described in the supplied documentation.
- ▶ Set up the floorstand model (see section "[Setting up the floorstand model](#)" on page 47) or install the rack model in the rack (see section "[Installing/removing the rack model](#)" on page 49).
- ▶ Wire the server. Follow the instructions in sections "[Connecting devices to the server](#)" on page 59 and "[Notes on connecting/disconnecting cables](#)" on page 63.
- ▶ Connect the server to the mains (see section "[Connecting the server to the mains](#)" on page 60).
- ▶ Familiarize yourself with the controls and indicators on the front and rear of the server (see section "[Control elements and indicators](#)" on page 68).

## Installation steps, overview

---

- ▶ Configure the server and install the desired operating system and applications. The following options are available:
  - Remote installation with the ServerView Installation Manager:

With the ServerView Suite DVD 1 provided, you can configure the server and install the operating system in a convenient manner.

Details on how to operate the ServerView Installation Manager, as well as some additional information, are included in the "ServerView Suite Installation Manager" user's guide (on ServerView Suite DVD 2 under *Industry Standard Servers - Software - ServerView Suite - Server Installation and Deployment*).

Configuration information can also be found in section "[Configuring the server and installing the operating system with the ServerView Installation Manager](#)" on page 80.
  - Local configuration and installation with or without the ServerView Installation Manager (see section "[Configuring the server and installing the operating system with the ServerView Installation Manager](#)" on page 80 or section "[Configuring the server and installing the operating system without the ServerView Installation Manager](#)" on page 81).



You will find more information on installing the server remotely or locally in the "ServerView Suite Installation Manager" user's guide (on the ServerView Suite DVD 2 under *Industry Standard Servers - Software - ServerView Suite - Server Installation and Deployment*).

---

## 3 Important information

In this chapter you will find essential information regarding safety when working on your server.

### 3.1 Safety instructions



The following safety instructions are also provided in the manual "Safety notes and other important information".

This device meets the relevant safety regulations for IT equipment. If you have any questions about whether you can install the server in the intended environment, please contact your sales outlet or our customer service team.



#### **CAUTION!**

- The actions described in this manual shall be performed by technical specialists. A technical specialist is a person who is trained to install the server including hardware and software.
- Repairs to the device that do not relate to CSS failures shall be performed by service personnel. Please note that unauthorized interference with the system will void the warranty and exempt the manufacturer from all liability.
- Any failure to observe the guidelines in this manual, and any improper repairs could expose the user to risks (electric shock, energy hazards, fire hazards) or damage the equipment.
- Before installing/removing internal options to/from the server, turn off the server, all peripheral devices, and any other connected devices. Also unplug all power cords from the power outlet. Failure to do so can cause electric shock.

## Important information

---

### Before starting up



#### CAUTION!

- During installation and before operating the device, observe the instructions on environmental conditions for your device (see [section "Technical data" on page 26](#)).
- If the server has been moved from a cold environment, condensation may form both inside and on the outside of the machine.

Wait until the server has acclimatized to room temperature and is absolutely dry before starting it up. Material damage may be caused to the server if this requirement is not met.

- Only transport the server in the original packaging or in packaging that protects it from impacts and jolts.

### Installation and operation



#### CAUTION!

- This unit should not be operated in ambient temperatures above 35 °C.
- If the unit is integrated into an installation that draws power from an industrial power supply network with an IEC309 connector, the power supply's fuse protection must comply with the requirements for non-industrial power supply networks for type A connectors.
- The unit automatically adjusts itself to a mains voltage in a range of 100 V - 240 V. Ensure that the local mains voltage lies within these limits.
- This device must only be connected to properly grounded power outlets or insulated sockets of the rack's internal power supply with tested and approved power cords.
- Ensure that the device is connected to a properly grounded power outlet close to the device.





### CAUTION!

- Ensure that the power sockets on the device and the properly grounded power outlets are freely accessible.
- The On/Off button or the main power switch (if present) does not isolate the device from the mains power supply. To disconnect it completely from the mains power supply, unplug all network power plugs from the properly grounded power outlets.
- Always connect the server and the attached peripherals to the same power circuit. Otherwise you run the risk of losing data if, for example, the server is still running but a peripheral device (e.g. memory subsystem) fails during a power outage.
- Data cables must be adequately shielded.
- Ethernet cabling has to comply with EN 50173 and EN 50174-1/2 standards or ISO/IEC 11801 standard respectively. The minimum requirement is a Category 5 shielded cable for 10/100 Ethernet, or a Category 5e cable for Gigabit Ethernet.
- Route the cables in such a way that they do not create a potential hazard (make sure no-one can trip over them) and that they cannot be damaged. When connecting the server, refer to the relevant instructions in this manual.
- Never connect or disconnect data transmission lines during a storm (risk of lightning hazard).
- Make sure that no objects (e.g. jewelry, paperclips etc.) or liquids can get inside the server (risk of electric shock, short circuit).
- In emergencies (e.g. damaged casing, controls or cables, penetration of liquids or foreign bodies), switch off the server immediately, remove all power plugs and contact your sales outlet or customer service team.



### CAUTION!

- Proper operation of the system (in accordance with IEC 60950-1 resp. EN 60950-1) is only ensured if the casing is completely assembled and the rear covers for the installation slots have been fitted (electric shock, cooling, fire protection, interference suppression).
- Only install system expansions that satisfy the requirements and rules governing safety and electromagnetic compatibility and those relating to telecommunication terminals. If you install other expansions, they may damage the system or violate the safety regulations. Information on which system expansions are approved for installation can be obtained from our customer service center or your sales outlet.
- The components marked with a warning notice (e.g. lightning symbol) may only be opened, removed or exchanged by authorized, qualified personnel. Exception: CSS components can be replaced.
- The warranty is void if the server is damaged during installation or replacement of system expansions.
- Only set screen resolutions and refresh rates that are specified in the operating manual for the monitor. Otherwise, you may damage your monitor. If you are in any doubt, contact your sales outlet or customer service center.
- Before installing/removing internal options to/from the server, turn off the server, all peripheral devices, and any other connected devices. Also unplug all power cords from the outlet. Failure to do so can cause electric shock.
- Do not damage or modify internal cables or devices. Doing so may cause a device failure, fire, or electric shock.
- Devices inside the server remain hot after shutdown. Wait for a while after shutdown before installing or removing internal options.
- The circuit boards and soldered parts of internal options are exposed and can be damaged by static electricity. Before handling them, first touch a metal part of the server to discharge static electricity from your body.
- Do not touch the circuitry on boards or soldered parts. Hold the metallic areas or the edges of the circuit boards.



### CAUTION!

- Install the screw removed during installation/detaching Internal Options in former device/position. To use a screw of the different kind causes a breakdown of equipment.
- The installation indicated on this note is sometimes changed to the kind of possible options without notice.

## Batteries



### CAUTION!

- Incorrect replacement of batteries may lead to a risk of explosion. The batteries may only be replaced with identical batteries or with a type recommended by the manufacturer (see the technical manual for the system board).
- Do not throw batteries into the trash can. They must be disposed of in accordance with local regulations concerning special waste.
- The battery must be disposed of in accordance with local regulations concerning special waste.
- Replace the lithium battery on the system board in accordance with the instructions in the technical manual for the system board.
- All batteries containing pollutants are marked with a symbol (a crossed-out garbage can). In addition, the marking is provided with the chemical symbol of the heavy metal decisive for the classification as a pollutant:

Cd Cadmium

Hg Mercury

Pb Lead

### Working with CDs/DVDs/BDs and optical drives

When working with devices with optical drives, these instructions must be followed.



#### **CAUTION!**

- Only use CDs/DVDs/BDs that are in perfect condition, in order to prevent data loss, equipment damage and injury.
- Check each CD/DVD/BD for damage, cracks, breakages etc. before inserting it in the drive.

Note that any additional labels applied may change the mechanical properties of a CD/DVD/BD and cause imbalance.

Damaged and imbalanced CDs/DVDs/BDs can break at high drive speeds (data loss).

Under certain circumstances, sharp CD/DVD/BD fragments can pierce the cover of the optical drive (equipment damage) and can fly out of the device (danger of injury, particularly to uncovered body parts such as the face or neck).

- High humidity and airborne dust levels are to be avoided. Electric shocks and/or server failures may be caused by liquids such as water, or metallic items, such as paper clips, entering a drive.
- Shocks and vibrations are also to be avoided.
- Do not insert any objects other than the specified CDs/DVDs/BDs.
- Do not pull on, press hard, or otherwise handle the CD/DVD/BD tray roughly.
- Do not disassemble the optical drive.
- Before use, clean the optical disk tray using a soft, dry cloth.
- As a precaution, remove disks from the optical drive when the drive is not to be used for a long time. Keep the optical disk tray closed to prevent foreign matter, such as dust, from entering the optical drive.
- Hold CDs/DVDs/BDs by their edges to avoid contact with the disk surface.

- Do not contaminate the CD/DVD/BD surface with fingerprints, oil, dust, etc. If dirty, clean with a soft, dry cloth, wiping from the center to the edge. Do not use benzene, thinners, water, record sprays, antistatic agents, or silicone-impregnated cloth.
- Be careful not to damage the CD/DVD/BD surface.
- Keep the CDs/DVDs/BDs away from heat sources.
- Do not bend or place heavy objects on CDs/DVDs/BDs.
- Do not write with ballpoint pen or pencil on the label (printed) side.
- Do not attach stickers or similar to the label side. Doing so may cause rotational eccentricity and abnormal vibrations.
- When a CD/DVD/BD is moved from a cold place to a warm place, moisture condensation on the CD/DVD/BD surface can cause data read errors. In this case, wipe the CD/DVD/BD with a soft, dry cloth then let it air dry. Do not dry the CD/DVD/BD using devices such as a hair dryer.
- To avoid dust, damage, and deformation, keep the CD/DVD/BD in its case whenever it is not in use.
- Do not store CDs/DVDs/BDs at high temperatures. Areas exposed to prolonged direct sunlight or near heating appliances are to be avoided.



You can prevent damage from the optical drive and the CDs/DVDs/BDs, as well as premature wear of the disks, by observing the following suggestions:

- Only insert disks in the drive when needed and remove them after use.
- Store the disks in suitable sleeves.
- Protect the disks from exposure to heat and direct sunlight.

### Laser information

The optical drive complies with IEC 60825-1 laser class 1.



#### **CAUTION!**

The optical drive contains a light-emitting diode (LED), which under certain circumstances produces a laser beam stronger than laser class 1. Looking directly at this beam is dangerous.

**Never remove parts of the optical drive casing!**

## Important information

---

### Modules with Electrostatic-Sensitive Devices

Modules with electrostatic-sensitive devices are identified by the following sticker:

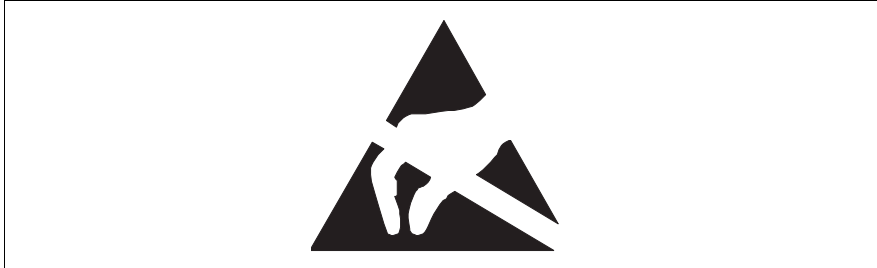

Figure 1: ESD label

When you handle components fitted with ESDs, you must always observe the following points:

- Switch off the system and remove the power plugs from the power outlets before installing or removing components with ESDs.
- You must always discharge static build-up (e.g. by touching a grounded object) before working with such components.
- Any devices or tools that are used must be free of electrostatic charge.
- Wear a suitable grounding cable that connects you to the external chassis of the system unit.
- Always hold components with ESDs at the edges or at the points marked green (touch points).
- Do not touch any connectors or conduction paths on an ESD.
- Place all the components on a pad which is free of electrostatic charge.



For a detailed description of how to handle ESD components, see the relevant European or international standards (EN 61340-5-1, ANSI/ESD S20.20).

**Other important information:**

- During cleaning, observe the instructions in section "[Cleaning the server](#)" on [page 82](#).
- Keep this operating manual and the other documentation (such as the technical manual, documentation DVD) close to the device. All documentation must be included if the equipment is passed on to a third party.

## 3.2 ENERGY STAR



Products that have been certified compliant with ENERGY STAR and identified as such are in full compliance with the specification at shipping. Note that energy consumption can be affected by software that is installed or any changes that are made to the BIOS or energy options subsequently. In such cases, the properties guaranteed by ENERGY STAR can no longer be assured.

The "ServerView Operations Manager" user guide contains instructions for reading out measurement values, including those relating to current energy consumption and air temperatures. Either the Performance Monitor or the Task Manager can be used to read out CPU utilization levels.



A specific model of this product is recognized in United States EPA, and registered. The model based on this is not sold in the Japanese market.

### 3.3 CE conformity



The system complies with the requirements of the EC directives 2004/108/EC regarding "Electromagnetic Compatibility" and 2006/95/EC "Low Voltage Directive". This is indicated by the CE marking (CE = Communauté Européenne).

### 3.4 FCC Class A Compliance Statement

If there is an FCC statement on the device, it applies to the products covered in this manual, unless otherwise specified herein. The statement for other products will appear in the accompanying documentation.

#### NOTE:

This equipment has been tested and found to comply with the limits for a "Class A" digital device, pursuant to Part 15 of the FCC rules and meets all requirements of the Canadian Interference-Causing Equipment Standard ICES-003 for digital apparatus. These limits are designed to provide reasonable protection against harmful interference in a residential installation. This equipment generates, uses and can radiate radio frequency energy and, if not installed and used in strict accordance with the instructions, may cause harmful interference to radio communications. However, there is no warranty that interference will not occur in a particular installation. If this equipment does cause harmful interference to radio or television reception, which can be determined by turning the equipment off and on, the user is encouraged to try to correct the interference by one or more of the following measures:

- Reorient or relocate the receiving antenna.
- Increase the separation between equipment and the receiver.
- Connect the equipment into an outlet on a circuit different from that to which the receiver is connected.
- Consult the dealer or an experienced radio/TV technician for help.

Fujitsu is not responsible for any radio or television interference caused by unauthorized modifications of this equipment or the substitution or attachment of connecting cables and equipment other than those specified by Fujitsu. The correction of interferences caused by such unauthorized modification, substitution or attachment will be the responsibility of the user.



The use of shielded I/O cables is required when connecting this equipment to any and all optional peripheral or host devices. Failure to do so may violate FCC and ICES rules.

**WARNING:**

This is a class A product. In a domestic environment this product may cause radio interference in which case the user may be required to take adequate measures.

### 3.5 Transporting the server



**CAUTION!**

Only transport the server in its original packaging or in packaging that protects it from impacts and jolts. Do not unpack the server until it is at its installation location.

If you need to lift or transport the server, ask other people to help you.

Never lift or carry the device by the handles on the front panel.

### 3.6 Notes on installing the server in the rack



#### CAUTION!

- For safety reasons, at least two people are required to install the server in the rack because of its weight and size.

(For the Japanese market, please refer to "安全上の注意およびその他の重要情報".)

- Never lift the server into the rack using the handles on the front panel.
- When connecting and disconnecting cables, observe the relevant instructions in the "Important Information" chapter of the technical manual for the corresponding rack. The technical manual is supplied with the corresponding rack.
- When installing the rack, make sure that the anti-tilt mechanism is correctly fitted.
- For safety reasons, no more than one unit may be removed from the rack at any one time during installation and maintenance work.
- If several units are simultaneously removed from the rack, there is a risk that the rack could tip over.
- The rack must be connected to the power supply by an authorized specialist (electrician).
- If the server is integrated into an installation that draws power from an industrial power supply network with an IEC309 type connector, the power supply's fuse protection must comply with the requirements for non-industrial power supply networks for the type A connector.

## 3.7 Environmental protection

### Environmentally-friendly product design and development

This product has been designed in accordance with the Fujitsu standard for "environmentally friendly product design and development". This means that key factors such as durability, selection and labeling of materials, emissions, packaging, ease of dismantling and recycling have been taken into account.

This saves resources and thus reduces the harm done to the environment. Further information can be found at:

- [http://ts.fujitsu.com/products/standard\\_servers/index.html](http://ts.fujitsu.com/products/standard_servers/index.html) (for the EMEA market)
- <http://primeserver.fujitsu.com/primergy/concept/> (for the Japanese market)

### Energy-saving information

Devices that do not need to be constantly switched on should be switched off until they are needed as well as during long breaks and after completion of work.

### Packaging information

This packaging information doesn't apply to the Japanese market.

Do not throw away the packaging. You may need it later for transporting the system. If possible, the equipment should only be transported in its original packaging.

### Information on handling consumables

Please dispose of printer consumables and batteries in accordance with the applicable national regulations.

In accordance with EU directives, batteries must not be disposed of with unsorted domestic waste. They can be returned free of charge to the manufacturer, dealer or an authorized agent for recycling or disposal.

## Important information

---

All batteries containing pollutants are marked with a symbol (a crossed-out garbage can). They are also marked with the chemical symbol for the heavy metal that causes them to be categorized as containing pollutants:

Cd Cadmium

Hg Mercury

Pb Lead

### Labels on plastic casing parts

Please avoid sticking your own labels on plastic parts wherever possible, since this makes it difficult to recycle them.

### Returns, recycling and disposal

Please handle returns, recycling and disposal in accordance with local regulations.



The device must not be disposed of with domestic waste. This device is labeled in compliance with European directive 2002/96/EC on waste electrical and electronic equipment (WEEE).

This directive sets the framework for returning and recycling used equipment and is valid across the EU. When returning your used device, please use the return and collection systems available to you. Further information can be found at

<http://ts.fujitsu.com/recycling>.

Details regarding the return and recycling of devices and consumables within Europe can also be found in the "Returning used devices" manual, via your local Fujitsu branch or from our recycling center in Paderborn:

Fujitsu Technology Solutions  
Recycling Center  
D-33106 Paderborn

Tel. +49 5251 8 18010

Fax +49 5251 8 333 18010

---

## 4 Hardware installation



### CAUTION!

- Follow the safety instructions in the chapter "[Important information](#)" on page 31.
- Do not expose the server to extreme environmental conditions (see "[Ambient conditions](#)" on page 27). Protect the server from dust, humidity and heat.
- Make sure that the server is acclimatized for the time indicated in this table before putting it into operation.

Temperature difference (°C)	Minimum acclimatization time (hours)
5	3
10	5
15	7
20	8
25	9
30	10

Table 1: Acclimatization time

In the [table "Acclimatization time"](#), the temperature difference refers to the difference between the operating environment temperature and the temperature to which the server was exposed previously (outside, transport or storage temperature).

### 4.1 Unpacking the server



#### CAUTION!

Follow the safety instructions in [chapter "Important information" on page 31](#).

The server must always be lifted or carried by at least two people.  
(For the Japanese market, please refer to "安全上の注意およびその他の重要情報".)

Do not unpack the server until it is at its installation location.

- ▶ Transport the server to the place where you want to set it up.
- ▶ Unpack all individual parts.  
Keep the original packaging in case you want to transport the server again (applies only to EMEA market).
- ▶ Check the delivery for any damage during transport.
- ▶ Check whether the items delivered match the details on the delivery note.

The product name and serial number of the product can be found on the ID card (see section ["ID card" on page 69](#)).

- ▶ Notify your supplier immediately should you discover that the items delivered do not correspond to the delivery note.

## 4.2 Setting up the floorstand model



If you are not installing a PRIMERGY TX200 S6 floorstand model, skip this section and continue reading at [section "Installing/removing the rack model" on page 49](#).



### CAUTION!

Follow the safety instructions in [chapter "Important information" on page 31](#).

- ▶ Transport the server to the place where you want to set it up.
- ▶ Unpack the server (see [section "Unpacking the server" on page 46](#)).
- ▶ Set up the server.

Note that for safety reasons (danger of tipping) the anti-tilt bracket must be mounted on the back of the server (see [section "Mounting the anti-tilt bracket" on page 48](#)).



### CAUTION!

- The device must be protected from direct sunlight.
  - The essential minimum clearance for servicing must be maintained (see ["Maintenance area for the floorstand model" on page 27](#)).
  - Access to the rear of the server must be assured so that other devices (e.g. memory subsystems) can be connected.
  - A clearance of at least 200 mm must be maintained in front of and behind the system to ensure proper ventilation.
  - The mains plug must be accessible easily and safely.
- ▶ Wire the server. Read the information in [section "Connecting devices to the server" on page 59](#) and [section "Notes on connecting/disconnecting cables" on page 63](#).
  - ▶ Connect the system to the mains (see [section "Connecting the server to the mains" on page 60](#)).

### 4.2.1 Mounting the anti-tilt bracket

**i** The anti-tilt bracket is only necessary for the redundant configuration (with two hot-plug power supplies).



Figure 2: Mounting the anti-tilt bracket

- ▶ Place the server on the anti-tilt bracket.
- ▶ Fasten the anti-tilt bracket using the two knurled screws (1).



## 4.3 Installing/removing the rack model



### CAUTION!

- Please observe the safety information and notes on rack mounting in [chapter "Important information" on page 31](#).
- At least two people are needed to install / remove the server in the rack. (For the Japanese market, please refer to "安全上の注意およびその他の重要情報".)
- The rack may tip over if more than one unit is removed at the same time.
- The server may not occupy the top height units of the rack (38HU/42HU PRIMECENTER Rack, DataCenter Rack, 19-inch standard rack (for the Japanese market)), as otherwise boards cannot be replaced even with the plug-in module fully extended.

### 4.3.1 Rack system requirements

The rack systems from Fujitsu PRIMECENTER Rack, DataCenter Rack and 19-inch standard rack (for the Japanese market) support the installation of PRIMERGY servers. Installation in most current rack systems from other manufacturers (3rd party racks) is also supported.

To accommodate the ventilation concept and ensure proper ventilation, any unused areas in the rack must be sealed using dummy covers.

The power is supplied via the multiple socket outlets fitted in the rack.

#### Fujitsu rack systems

The main features of PRIMECENTER Rack, DataCenter Rack and 19-inch standard rack (for the Japanese market) are as follows:

- support systems that can be mounted without tools
- support systems having a linear alignment feature to ensure that they can be adjusted to different rack depths

PRIMECENTER Rack and DataCenter Rack provide an enhanced cable management in the lateral rack area.

## Hardware installation

---



*For PRIMECENTER Racks and DataCenter Racks:*

The mounting of the rails in the different racks is described in the next sections. Installation of the cable management is described in detail in the Technical Manual for the respective rack.



*For 19-inch standard rack (for the Japanese market):*

For information on mounting of the rails in the 19-inch standard rack (for the Japanese market) please refer to the next sections or the "はじめにお読みください".

### 3rd party racks

Certain general conditions must be met:

– Installation dimensions (see the dimensions shown in [figure 3 on page 51](#)):

- 1 Front of rack
- 2 Rear of rack
- A Rack depth (comparison PRIMECENTER Rack 940/1000/1100 mm)
- B Rack width (comparison PRIMECENTER rack 700 mm)
- C Clearance for 19" installation level
- C1 Front 19" installation level
- C2 Rear 19" installation level
- D Cable routing area (cable area depth) and ventilation
- E Space for front panel and ventilation
- F Space for right and left support systems
- P PRIMERGY rack installation depth
- a1 Front left support upright
- a2 Front right support upright
- b1 Rear left support upright
- b2 Rear right support upright

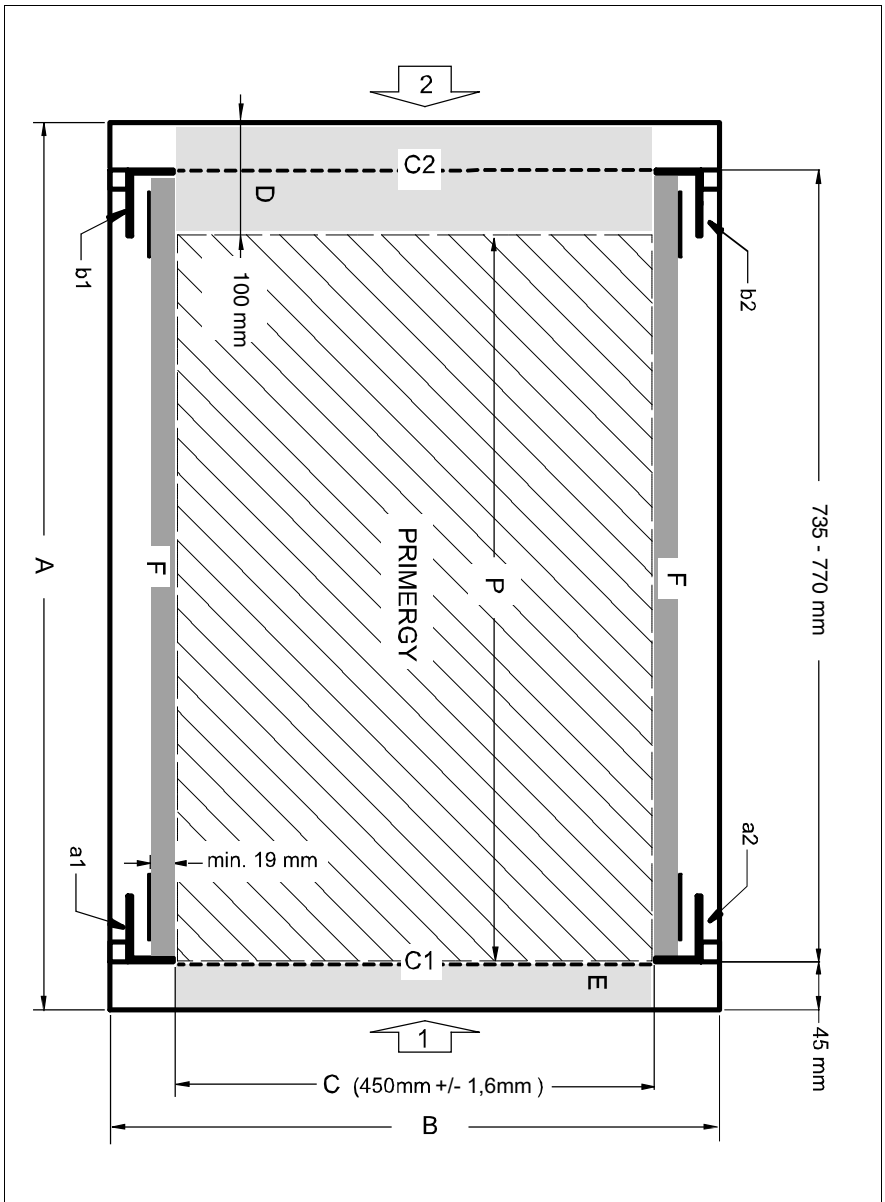

Figure 3: Mechanical requirements

## Hardware installation

---

- You must ensure that the safety mechanisms on the server, e.g. stoppers or retaining systems, are functioning correctly.

- The shape of the rack support uprights must ensure that the support systems can be bolted to the front.

The support systems have a linear alignment feature to ensure that they can be adjusted to different rack depths.

- No cable management support (delivered with the mounting kit).

- Climatic conditions:

An unobstructed air intake in the rack front and air discharge in the rear cover of the rack are essential for ventilation of the installed server.

In general, the ventilation concept ensures that the necessary cooling is achieved by the horizontal self-ventilation of the installed devices (air flow from the front to the rear).

- Power supply:

For installation in 3rd party racks, you must ensure that the appropriate socket strips are present.

### 4.3.2 Installation in PRIMECENTER/DataCenter/ 19-inch standard rack

For installation in a PRIMECENTER/DataCenter rack, the following parts are required:

- Support bracket (for the EMEA market)
- One support system on the left and one on the right
- M5 centering fixtures (screws with integrated plugwashers)



- The descriptions and figures in this section refer to the current support system. For other support systems you will find the appropriate description in the packaging of the rack mounting kit.
- General information regarding server installation in the rack is included in the technical manual for the appropriate rack.

### Fitting the support bracket

When mounting the left support system in the corresponding rack, the supplied support bracket must first be mounted flush with the underside of the device on the rear left support upright.

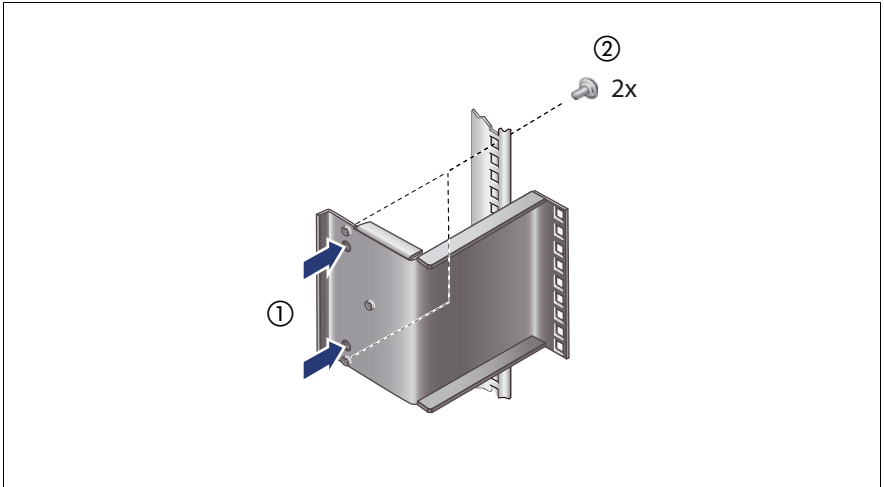

Figure 4: Fitting the support bracket

- ▶ Position the support bracket at the corresponding height on the rear left support upright, (place the knobs in the corresponding holes) (1) and secure it with the two supplied M5 centering fixtures (2).

### Installing the support systems

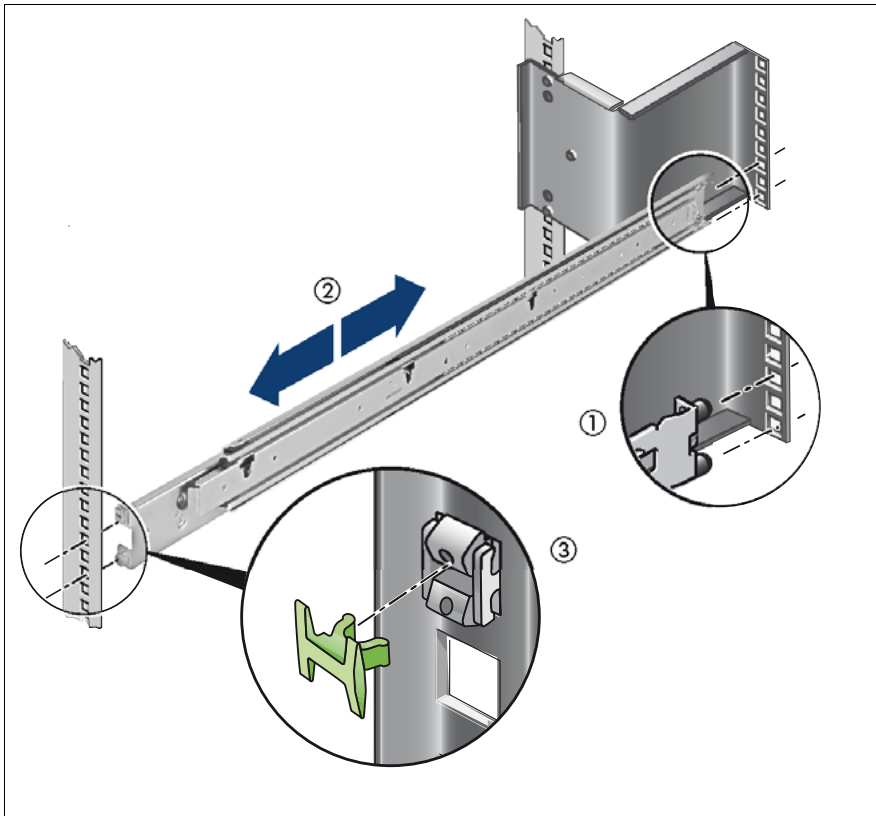

Figure 5: Fit the left support system in the PRIMECENTER/DataCenter rack

- ▶ Position the left support system in the support bracket (insert retaining bolts) - see (1).



For the Japanese market:

There is no support bracket. Please position the support system directly on the support upright.

- ▶ Clamp the left-hand support system (2) between the front left support upright and the support bracket by pressing the support system together, positioning it on the front support upright and releasing it again. The support system automatically adjusts to the rack depth.

 The support system no longer has to be fixed to the front support upright because the easy lock engages and ensures a firm fit.

- ▶ Insert (3) the safety lock into the easy lock (snap fit).



### CAUTION!

Ensure that the safety lock has been inserted before the server is inserted!

- ▶ Repeat the above steps for the right-hand support system (with the front and rear right support uprights).
- ▶ Fit the PRIMECENTER/DataCenter rack cable management as described in the technical manual for the corresponding rack.

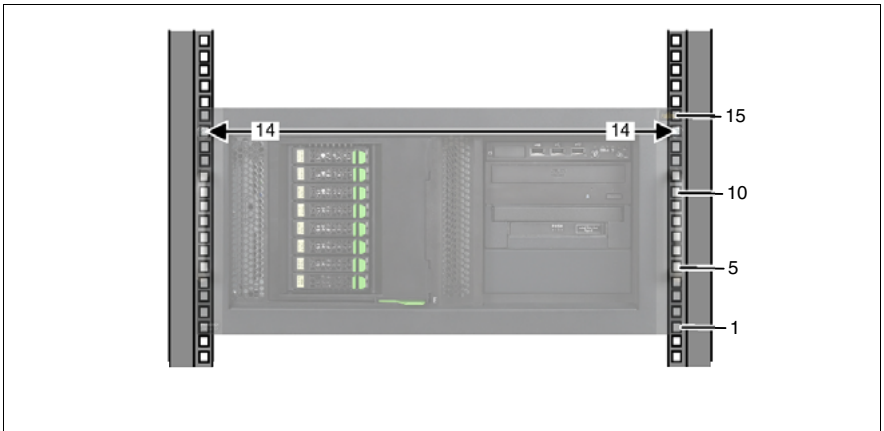

Figure 6: Position of the cage nuts

- ▶ Fit the cage nuts for securing the server in the corresponding catches on the right and left support uprights.
- ▶ Insert the server (see ["Inserting the server" on page 56](#)).

Inserting the server

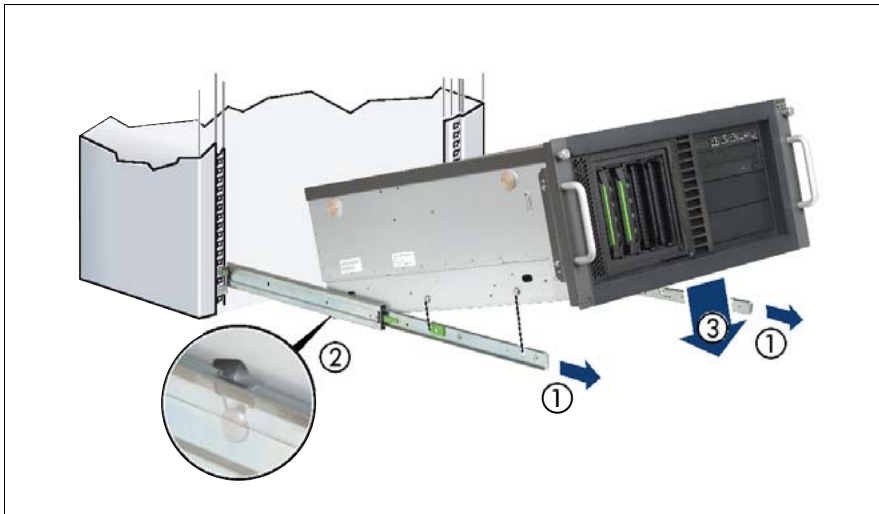

Figure 7: Inserting the server (a)

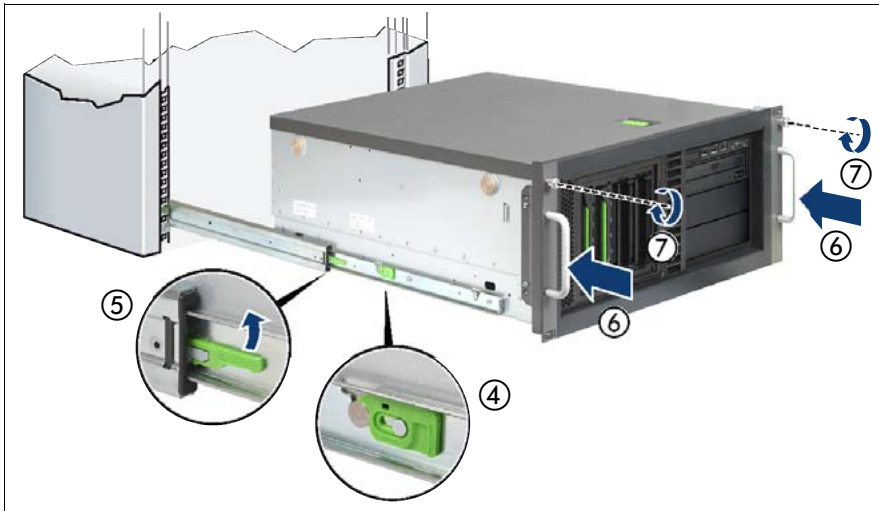

Figure 8: Inserting the server (b)





### CAUTION!

Ensure that the safety lock has been inserted **before** the server is inserted (see [figure 5 on page 54](#)).



### CAUTION!

At least two people are needed to position the server in the rack.  
(For the Japanese market, please refer to "安全上の注意およびその他の重要情報".)

- ▶ Extend the telescopic rails completely to the front (1).



They must click into place so that they can no longer be moved.

- ▶ Lower the server from above onto the projecting telescopic rails (2), (3). As you do this, the locking bar (4) engages.
- ▶ Push the locking mechanism of both telescopic rails up (5).
- ▶ For a final function test, slide the server in and out at least twice. The rails should move smoothly.
- ▶ Push the server as far as it will go into the rack (6).
- ▶ Fasten the server to the rack (7) using the two knurled screws (front panel).
- ▶ Route the cables as described in the technical manual for the rack in question with the server pushed in.

### 4.3.3 Installation in 3rd party racks



The support systems from Fujitsu are suitable for use in any 3rd party racks for standard servers (installation depth 714 - 785 mm) without restrictions.

- ▶ Refer to the manual from the rack manufacturer for details of the mechanical installation and the climatic conditions.



### CAUTION!

When installing in 3rd party racks, it must be ensured that an air flow from the front to the back of the rack is guaranteed.

- ▶ Fit the required original parts (support bracket or cable management system).

## Hardware installation

---



Under certain circumstances, you will not be able to use some of the parts from the rack installation kit supplied - you will need to use original 3rd party rack parts instead.

### Racks with installation depth of 735 mm

The lengths of the telescopic rails do not need to be adjusted with respect to each other for the installation in rack systems with 735 mm installation depth.

- ▶ Secure the support systems as described in section "[Installing the support systems](#)" on page 54.
- ▶ Mount the server (see "[Inserting the server](#)" on page 56) and route the cables as described in the original manual of the rack.



#### CAUTION!

Ensure that the safety lock has been inserted **before** the server is inserted (see [figure 5 on page 54](#)).

### Racks with installation depth smaller/greater than 735 mm

The support systems can be used for installation depths of 714 - 785 mm. The spring element of the support system is used to adjust the length as required.

- ▶ Secure the support systems as described in "[Installing the support systems](#)" on page 54.
- ▶ Mount the server (see "[Inserting the server](#)" on page 56) and route the cables as described in the original manual of the rack.



#### CAUTION!

Ensure that the safety lock has been inserted **before** the server is inserted (see [figure 5 on page 54](#)).

## 4.4 Connecting devices to the server

The connectors for external devices are on the front and rear of the server. The additional connectors available on your server depend on the expansion cards installed.

The standard connectors are indicated by symbols and color coding:

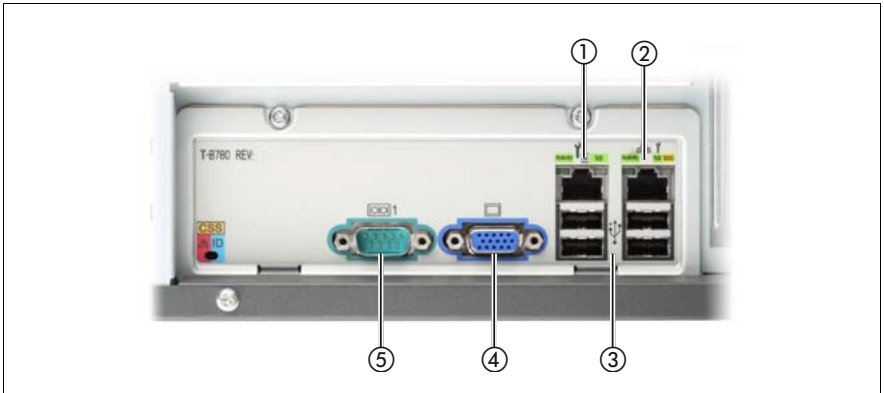

Figure 9: Connector panel on the rear side

1	Management LAN connector (LAN 1)
2	Shared LAN connector (LAN 2)
3	USB connectors (black)
4	Video connector (blue)
5	Serial connector COM1 (turquoise)

The corresponding indicators are explained in [section "Rear of server" on page 73](#).

**i** Some of the devices connected require special software (e.g. drivers) (see documentation for the connected device).

► Connect the data cables to the server and peripherals.

Three additional USB connectors are located on the front of the server (see [figure 15 on page 68](#)).

### Connecting the monitor

- ▶ Connect the monitor to the video connector of the server (see figure 9 on page 59).
- ▶ Connect the power cable of the monitor to a grounded mains outlet of the in-house mains and/or to the mains socket strip of the rack.



#### **CAUTION!**

The rated current for the monitor is indicated on the technical data label on the monitor or in the operating manual for the monitor.

## 4.5 Connecting the server to the mains

The server is either equipped with a standard power supply unit or with one or two hot-plug power supply units.

As an option, the standard power supply unit can be replaced with a hot-plug power supply unit. A second hot-plug power supply unit can be added to ensure a redundant power supply. If a defect occurs in one power supply unit, the other power supply unit ensures unimpaired further operation.



#### **CAUTION!**

The server is automatically set to a mains voltage in the range 100 V - 240 V. You may only operate the server if its rated voltage range corresponds to the local mains voltage.



A phase redundancy in the power supply of the server can be set up if two hot-plug power supply units are installed.

In this case the two power supply units are directly connected either to two different phases or two different power circuits of the in-house mains.

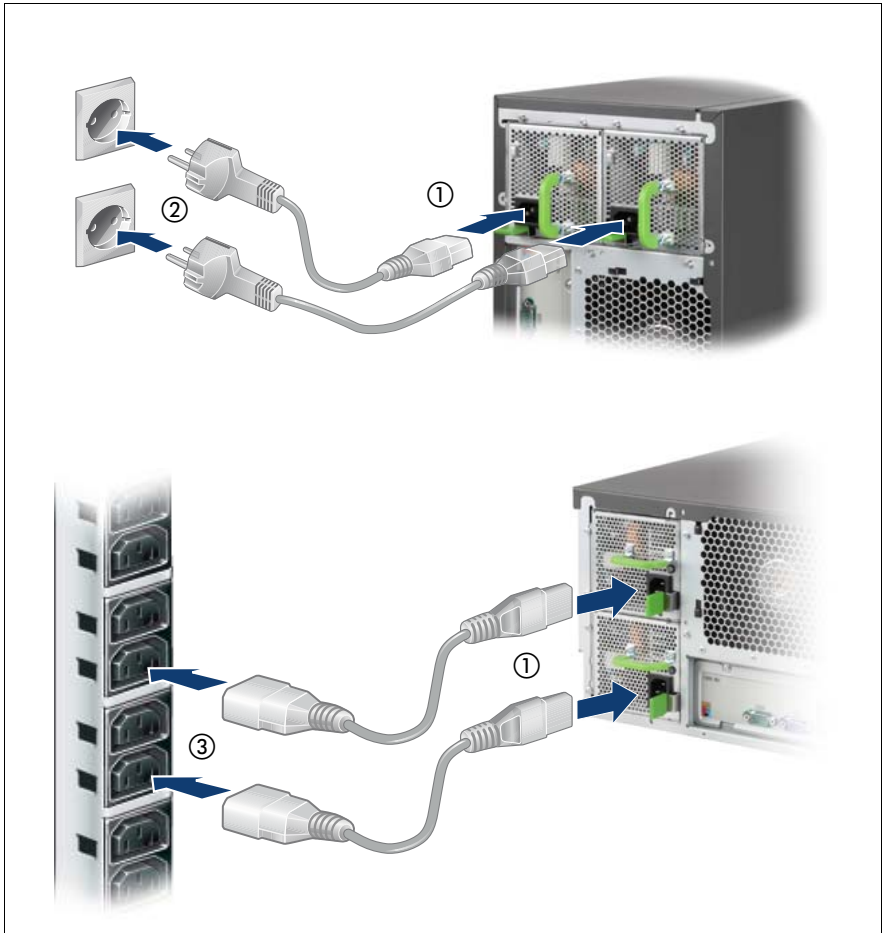

Figure 10: Connecting the server to the mains

- ▶ Connect the power cord to the server power supply unit (1).
- ▶ Connect the mains plug to a grounded mains outlet (2) in the in-house power supply network or a power outlet of the socket strip (3) in the rack (see technical manual for the rack).

### 4.5.1 Using cable ties

As an option, you can secure the power cable using a cable tie to ensure that the insulated connector cannot be disconnected from the server accidentally. The cable tie is included in the accessories pack that is delivered together with the server.



Figure 11: Using cable ties

- ▶ Thread the cable tie through the eye (1).
- ▶ Pull the cable tie tight to secure the power cable.

The insulated connector cannot now be disconnected from the server accidentally.



You can loosen the cable tie by opening the small locking lever (2).

## 4.6 Notes on connecting/disconnecting cables



### CAUTION!

Always read the documentation supplied with the device you wish to connect.

Never connect, or disconnect cables during a thunderstorm.

Never pull on a cable when disconnecting it. Always take hold of the cable by the plug.

Follow the sequence described below to connect or disconnect external devices to or from the server:

Be sure to wait for 10 seconds or more after shutdown before turning the server on.

### Connecting cables

- ▶ Turn off all power and equipment switches.
- ▶ Disconnect all power plugs from the properly grounded power outlets.
- ▶ Connect all cables to the server and peripherals.
- ▶ Plug all data communication cables into the utility sockets.
- ▶ Plug all power cords into the properly grounded power outlets.

### Disconnecting cables

- ▶ Turn off all power and equipment switches.
- ▶ Disconnect all power plugs from the properly grounded power outlets.
- ▶ Unplug all data communication cables from the utility sockets.
- ▶ Disconnect the relevant cables from the server and all the peripherals.





# 5 Starting up and operation



## CAUTION!

Follow the safety instructions in chapter "[Important information](#)" on [page 31](#).

## 5.1 Access to the drives (floorstand model)

### 5.1.1 Access to the accessible drives



Figure 12: Removing the drive cover and snapping it into the hard disk drive cover

- ▶ Unlock the server (1).
- ▶ Remove the drive cover (2).
- ▶ Place the drive cover on the hard disk cover (3).



Please note the following when operating with tape drives:

If the system is programmed to eject the media automatically, the accessible drives must not be obstructed.

The drive cover is replaced and the server locked in the reverse order.



Figure 13: Removing the drive cover from the hard disk drive cover

- ▶ Carefully pull out on the green release lever (1) and lift off the drive cover (2).

## 5.1.2 Access to the HDD modules



Figure 14: Removing the hard disk cover

- ▶ Unlock the server (1).
- ▶ Remove the hard disk cover (2).

The hard disk drive cover is replaced and the server locked in the reverse order.

## 5.2 Control elements and indicators

### 5.2.1 Front of server

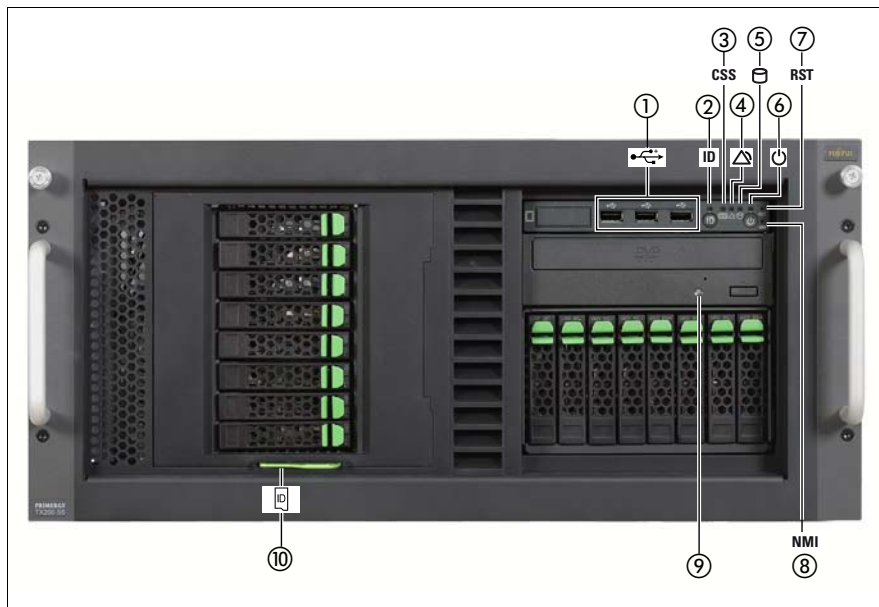

Figure 15: Front of server (example: rack model)

1	3 x USB connectors	6	Power-on indicator / On/Off button
2	ID indicator / ID button	7	Reset button
3	CSS indicator	8	NMI button
4	Global Error indicator	9	Optical drive activity indicator
5	Hard disk activity indicator	10	ID card

### 5.2.1.1 ID card

You can pull out the ID card as far as it will go and push it back in again.

The ID card contains various system information, such as the product name, serial number, order number, MAC addresses and DNS name.

### 5.2.1.2 Control elements



On/Off button

When the system is switched off, it can be switched on again by pressing the On/Off button.

When the system is operating, pressing the On/Off button will switch off the system.



#### **CAUTION!**

Risk of loss of data!



The On/Off button does not disconnect the server from the mains voltage. To disconnect from the mains completely, remove the power plug(s).

**NMI** NMI button



#### **CAUTION!**

Do not press! Risk of loss of data! The NMI button may only be used by service.

**RST** Reset button

Pressing the reset button reboots the system.



#### **CAUTION!**

Risk of loss of data!

**ID** ID button

ID LED lights up (blue) on the front and on the rear of the server when the ID button is pressed. Both ID indicators are synchronized.

### 5.2.1.3 LEDs on the control panel



Power indicator (two-color)

Glows green when the server is switched on.

Lights up orange when the server is switched OFF, but mains voltage is present (standby mode).



Hard disk activity indicator (green)

Lights up green when an internal hard disk drive is accessed.



Global Error indicator (orange)

- **Lights up orange** if a prefailure event has been detected that requires (precautionary) service intervention.
- **Flashes orange** if an error was detected that requires service intervention.
- **Does not light up** if there is no critical event.

If the event is still acute after a power failure, the indicator is activated after the restart.

The indicator also lights up in standby mode.

You can find more details on the indicated errors in the System Event Log (SEL), on the ServerView Local Service Panel, on the ServerView Local Service Display, in the ServerView Operations Manager or via the iRMC S2's Web interface.

### **CSS** CSS indicator (yellow)

- **Lights up yellow** if a prefailure event was detected for a CSS component that you can fix yourself (for reasons of precaution) with the CSS concept.
- **Flashes yellow** if an error was detected that you can fix yourself with the CSS concept.
- **Does not light up** when the system is OK.

If the event is still acute after a power failure, the indicator is activated after the restart.

The indicator also lights up in standby mode.

For more information on the CSS concept, see "[Customer Self Service \(CSS\)](#)" on page 14.

### **ID** ID indicator (blue)

Lights up blue when the system has been selected by pressing the ID button. To deactivate, press the button again.

The ID indicator can also be activated via the ServerView Operations Manager and the iRMC S2 Web interface and its status reported to the ServerView Operations Manager and the iRMC S2.

## **5.2.1.4 Indicators on the drives**

### **DVD drive activity indicator**

Lights up green when the storage medium is being accessed.

### Hard disk drive indicators



Figure 16: Indicators on the 3.5 inch and 2.5 inch HDD modules

1	HDD BUSY (green) <ul style="list-style-type: none"><li>– Lit: HDD in active phase (drive active, drive being accessed)</li><li>– Does not light: HDD inactive</li></ul>
2	HDD FAULT (orange) (in conjunction with a RAID controller) <ul style="list-style-type: none"><li>● SAS server variant<ul style="list-style-type: none"><li>– Does not light: no HDD error</li><li>– Lit: HDD Faulty (drive defective/needs replacing, drive failed, drive deactivated by software or the HDD module is not correctly inserted)</li><li>– Slow flashing: HDD Rebuild (the data is being restored after changing a drive)</li><li>– Fast flashing: HDD Identify</li></ul></li><li>● SATA server variant<ul style="list-style-type: none"><li>– Does not light: no HDD error</li><li>– Lit: HDD Faulty or Rebuild Stopped (drive defective and must be replaced, a rebuild process was stopped or the module is not correctly inserted)</li><li>– Slow flashing: HDD Rebuild (the data is being restored after changing a drive)</li><li>– Fast flashing: HDD Identify</li></ul></li></ul>



## 5.2.2 Rear of server

### 5.2.2.1 Indicators on the connector panel

#### CSS, Global Error and ID indicators



Figure 17: Indicators on the connector panel: CSS, Global Error and ID indicators

1	CSS, Global Error and ID indicators (yellow, orange and blue)
---	---



#### Global Error indicator (orange)

- **Lights up orange** if a prefailure event has been detected that requires (precautionary) service intervention.
- **Flashes orange** if an error was detected that requires service intervention.
- **Does not light up** if there is no critical event.

If the event is still acute after a power failure, the indicator is activated after the restart.

The indicator also lights up in standby mode.

You can find more details on the indicated errors in the System Event Log (SEL), on the ServerView Local Service Panel, on the ServerView Local Service Display, in the ServerView Operations Manager or via the iRMC S2's Web interface.

### CSS CSS indicator (yellow)

- **Lights up yellow** if a prefailure event was detected for a CSS component that you can fix yourself (for reasons of precaution) with the CSS concept.
- **Flashes yellow** if an error was detected that you can fix yourself with the CSS concept.
- **Does not light up** when the system is OK.

If the event is still acute after a power failure, the indicator is activated after the restart.

The indicator also lights up in standby mode.

For more information on the CSS concept, see "[Customer Self Service \(CSS\)](#)" on page 14.

### ID ID indicator (blue)

Lights up blue when the system has been selected by pressing the ID button. To deactivate, press the button again.

The ID indicator can also be activated via the ServerView Operations Manager and the iRMC S2 Web interface and its status reported to the ServerView Operations Manager and the iRMC S2.

## LAN indicators

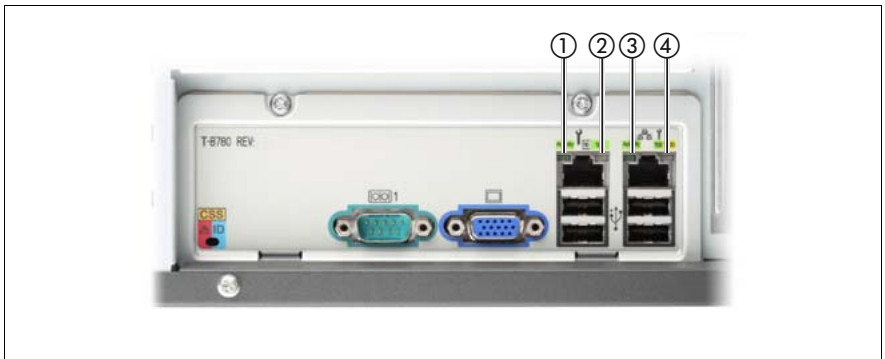

Figure 18: Indicators on the connector panel: LAN indicators

1	<p><b>LAN activity indicator (management LAN)</b></p> <p>Lights up green if a LAN connection exists. Does not light up if no LAN connection exists. Flashes green when a LAN transfer is in progress.</p>
2	<p><b>LAN transfer rate indicator (management LAN)</b></p> <p>Lights up green for a LAN transfer rate of 100 Mbit/s. Does not light up for a LAN transfer rate of 10 Mbit/s.</p>
3	<p><b>LAN activity indicator (shared LAN)</b></p> <p>Lights up green if a LAN connection exists. Does not light up if no LAN connection exists. Flashes green when a LAN transfer is in progress.</p>
4	<p><b>LAN transfer rate indicator (shared LAN)</b></p> <p>Lights yellow for a LAN transfer rate of 1 Gbit/s. Lights up green for a LAN transfer rate of 100 Mbit/s. Does not light up for a LAN transfer rate of 10 Mbit/s.</p>

**i** Depending on the settings in the BIOS, the shared LAN connector may also be used as a management LAN connector. You will find further information in the "D2799 BIOS Setup Utility for PRIMERGY TX200 S6" manual.

### 5.2.2.2 Indicators on the hot-plug power supply unit



Figure 19: Indicators on the hot-plug power supply units

1	<p>Indicator on hot-plug power supply unit (two colors)</p> <p>Flashes green when the server is switched off, but mains voltage is present (standby mode).</p> <p>Lights up green when the server is switched on and functioning properly.</p> <p>Lights up orange if the power supply unit has failed.</p>
---	---

## 5.3 Switching the server on and off



### CAUTION!

It nothing appears on the screen but flickering stripes after switching on the server, switch the server off immediately (see chapter "[Troubleshooting and tips](#)" on page 85).

The On/Off button does not disconnect the server from the mains voltage. To completely disconnect it from the mains voltage, remove the power plug(s) from the socket(s).

### Switching the server on

The power-on indicator (see figure [15 on page 68](#)) lights up orange (standby mode).

#### – Starting up for the first time:

- ▶ Press the On/Off button (see figure [15 on page 68](#)).
- ▶ Insert ServerView Suite DVD 1 in the DVD drive.
- ▶ Follow the on-screen instructions (see also section "[Configuring the server and installing the operating system with the ServerView Installation Manager](#)" on page 80 or section "[Configuring the server and installing the operating system without the ServerView Installation Manager](#)" on page 81).

#### – System already installed:

- ▶ Press the On/Off button.

The server is switched on, performs a system test and boots the operating system.



Depending on the configurations, the boot process may be prolonged and the screen may remain dark for a while.

### Switching the server off

Power-on indicator lights up green.

- ▶ Shut down the operating system properly.

The server is switched off automatically and goes into standby mode. The power-on indicator lights up orange.



If the operating system does not switch the server off automatically, press the On/Off button for at least four seconds and/or send a control signal for power button override.

### Other On/Off options

Besides the On/Off button, the server can be switched ON and OFF in the following ways:

- **Timer-controlled switch-on/off**

Using the ServerView Operations Manager or iRMC S2, you can configure that the server is switched on/off controlled by timer.

- **Ring indicator**

The server is switched on by an internal or external modem.

- **Wake up On LAN (WOL)**

The server is switched on by a command via the LAN (Magic Packet™).

- **After power failure**

The server automatically reboots following a power failure (depending on the settings in the BIOS or in iRMC S2).

- **Power button override**

The system can be switched off by pressing and holding down the On/Off button (for approximately 4 - 5 seconds).



### CAUTION!

There is a risk that data may be lost.

- **iRMC S2**

iRMC S2 offers various options for switching the server on and off, e.g. via the *Power On Off* page of the iRMC S2 Web interface.



## 5.4 Configuring the server

This section contains information about configuring the server and installing the operating system.

-  Make sure that the power saving functions are disabled in the *Power* menu of the BIOS Setup during operation.

### 5.4.1 Configuring the onboard SATA controller

A 6-port SATA controller is integrated on the system board. You can configure the onboard SATA controller either before or during installation with the ServerView Installation Manager. Using the ServerView Installation Manager is recommended.

-  The controller has its own configuration utility. For further information, refer to the "Embedded MegaRAID Software User's Guide" (on the ServerView Suite DVD 2 under *Industry Standard Servers - Expansion Cards - Storage Adapters - LSI RAID / SCSI Controllers*).
-  Descriptions of operating systems not covered in the controller manual are provided in the corresponding readme files on the driver CDs.
-  To control SAS hard disk drives an additional SAS/SATA RAID controller is necessary (see the following section).

### 5.4.2 Configuring the SAS/SATA RAID controller

The server has a SAS/SATA RAID controller with "Integrated Mirroring Enhanced" functionality or "MegaRAID functionality". You can configure the SAS/SATA RAID controller either before or during installation with the ServerView Installation Manager. Using the ServerView Installation Manager is recommended.

-  The controller makes a separate utility available for IME configuration. For further information, refer to the "Integrated RAID for SAS User's Guide" (on the ServerView Suite DVD 2 under *Industry Standard Servers - Expansion Cards - Storage Adapters - LSI RAID / SCSI Controllers*).

A separate utility is available to the controller for MegaRAID configuration. For further information, refer to the "SAS Software User's Guide" (on the ServerView Suite DVD 2 under *Industry Standard Servers - Expansion Cards - Storage Adapters - LSI Configuration Software*).

Further information on modular RAID controllers is provided in the "Modular RAID Controller Installation Guide" (on the ServerView Suite DVD 2 under *Industry Standard Servers - Expansion Cards - Storage Adapters - LSI RAID / SCSI Controllers*).

 Descriptions of operating systems not covered in the controller manual are provided in the corresponding readme files on the driver CDs.

### 5.4.3 Configuring the server and installing the operating system with the ServerView Installation Manager

Using the ServerView Installation Manager on the ServerView Suite DVD 1 provided, you can conveniently configure the server and install the operating system. This includes configuring the server-specific settings using the ServerView Configuration Manager and configuring the RAID controller using the **ServerView RAID Manager**.

#### Advantages of the ServerView Installation Manager

- Wizard assisted configuration of your server hardware and disk arrays
- Wizard assisted installation of all leading server operating systems
- Wizard-assisted creation of configuration files for unattended installation of several PRIMERGY servers with identical hardware configurations.
- Installation of drivers and additional software.

 The software that can be installed depends on your server's hardware configuration. This configuration is detected automatically.

 Descriptions of operating systems not covered in the RAID controller manual are provided in the corresponding readme files on the driver CDs.

To find out how to operate the ServerView Installation Manager and for further information, refer to the associated manual.



If you are using the ServerView Installation Manager, you can skip the following section on how to configure the server and install the operating system. Continue from section "[Cleaning the server](#)" on page 82.

### 5.4.4 Configuring the server and installing the operating system without the ServerView Installation Manager

#### Configure onboard SATA controller

Configure the controller as described in section "[Configuring the onboard SATA controller](#)" on page 79.

#### Configure SAS/SATA RAID controller with "Integrated Mirroring Enhanced"

Configure the controller as described in section "[Configuring the onboard SATA controller](#)" on page 79.

#### Configure SAS/SATA RAID controller with "MegaRAID functionality"

Configure the controller as described in section "[Configuring the onboard SATA controller](#)" on page 79.

#### Installing the operating system

- ▶ Insert the CD/DVD for the operating system you want to install.
- ▶ Reboot the server.
- ▶ Follow the instructions on screen and in the manual for the operating system.

### 5.5 Cleaning the server



#### **CAUTION!**

Switch the server off and disconnect the power plugs from the properly grounded power outlets.

Do not clean any interior parts yourself; leave this job to a service technician.

Do not use any cleaning agents that contain abrasives or may corrode plastic.

Ensure that no liquid enters the system. Ensure that the ventilation areas of the server and the monitor are clear.

Do not use any cleaning sprays (including flammable types). It may cause a device failure or a fire.

Clean the keyboard and the mouse with a disinfecting cloth.

Wipe the server and monitor casing with a dry cloth. If particularly dirty, use a cloth that has been moistened in a mild domestic detergent and then carefully wrung out.

---

## 6 Property and data protection

The floorstand model is protected against unauthorized opening by a lock. Apart from this, the server is also fitted with an intrusion detection switch which enables the ServerView Operations Manager program to detect and log any removal of the side cover or top cover and the cover for the HDD modules.

To prevent it being removed from its location, the floorstand model can be secured to a fixed object with a steel cable running through a clip on the back.

The rack model is protected against unauthorized access by a lockable rack door.

To protect the system and data internally against unauthorized access, you can activate the security functions of the BIOS Setup.

### 6.1 BIOS Setup security functions

The *Security* menu in BIOS Setup offers various options for protecting your data from unauthorized access. By combining these options, you can also achieve optimum protection for your system.



A detailed description of the *Security* menu and how to assign passwords can be found in the BIOS Setup documentation on the ServerView Suite DVD 2.



---

# 7 Troubleshooting and tips



## CAUTION!

Follow the safety instructions in the "Safety notes and other important information" manual and in chapter "[Important information](#)" on page 31.

If a fault occurs, attempt to resolve it using the measures described:

- in this chapter,
- in the documentation for the connected devices,
- in the help systems of the software used.

If you fail to correct the problem, proceed as follows:

- ▶ Make a list of the steps performed and the circumstances that led to the fault. Also make a list of any error messages that were displayed.
- ▶ Switch off the server.
- ▶ Contact our customer service team.

## 7.1 Power-on indicator remains unlit

The power-on indicator remains dark after you switch on your device.

### Power cable incorrectly connected

- ▶ Make sure that the power cable(s) is/are correctly connected to the server and the grounded power outlet(s).

### Power supply overloaded

- ▶ Disconnect the server power plug(s) from the grounded power outlet(s).
- ▶ Wait a few seconds before you plug it/them into the grounded power outlet(s) again.
- ▶ Switch on your server.

### 7.2 Server switches itself off

#### Server Management has detected an error

- ▶ Check the error list of System Event Log in ServerView Operations Manager or in the iRMC S2 web interface, and attempt to eliminate the error.

### 7.3 Screen remains blank

#### Monitor is switched off

- ▶ Switch on your monitor.

#### Screen has gone blank

- ▶ Press any key on the keyboard.  
or
- ▶ Deactivate screen saver. Enter the appropriate password.

#### Brightness control is set to dark

- ▶ Set the brightness control on the monitor to light. For detailed information, refer to the operating manual supplied with your monitor.

#### Power cable or monitor cable not connected

- ▶ Switch off the monitor and the server.
- ▶ Check whether the power cable is properly connected to the monitor and to the grounded power outlet.
- ▶ Check whether the monitor cable is properly connected to the server and monitor (if it is plugged in with a connector). If a separate graphics card is installed in the server, then the monitor cable must be connected to the graphics card.
- ▶ Switch on the monitor and the server.

## 7.4 Flickering stripes on monitor screen



### **CAUTION!**

Switch off the server immediately. Risk of damaging the server.

### **Monitor does not support the set horizontal frequency**

- ▶ Find out which horizontal frequency your monitor screen supports. You will find the horizontal frequency (also known as line frequency or horizontal deflection frequency) in the documentation for your monitor.
- ▶ Refer to the documentation for your operating system or the software for the screen controller for details of how to set the correct horizontal frequency for your monitor, and follow the procedure accordingly.

## 7.5 No screen display or display drifts

### **The wrong horizontal frequency or resolution has been selected for the monitor or for the application program.**

- ▶ Find out which horizontal frequency your monitor screen supports. You will find the horizontal frequency (also known as line frequency or horizontal deflection frequency) in the documentation for your monitor.
- ▶ Refer to the documentation for your operating system or the software for the screen controller for details of how to set the correct horizontal frequency for your monitor, and follow the procedure accordingly.

### 7.6 Incorrect date and time

- ▶ Set the date and time in the operating system or in the BIOS Setup under the Main menu, using System Date and System Time respectively.

**i** Note that the operating system may affect the system time. For example, the operating system time may deviate from the system time under Linux, and would overwrite the system time in the default setting on shutdown.

If the date and time are still wrong after the server has been switched off and back on again, replace the lithium battery (for a description refer to the Technical Manual for the D2799 system board) or contact our customer service team.

### 7.7 Drives reported as "dead" when starting system

#### **RAID controller configuration incorrect**

- ▶ Check and correct the settings for the drives using the RAID controller utility.

Further information is provided in the manual for the RAID controller.



## 7.8 Added drive reported as defective

### RAID controller is not configured for this drive

The drive was probably installed when the system was switched off.

- ▶ Reconfigure the RAID controller for the drive using the corresponding utility. Information is provided in the documentation for the RAID controller.

or

- ▶ Remove and reinstall the drive while the system is switched ON.

If the hard disk drive continues to be shown as defective, then replace it (see "[Hot-plug hard disk drives](#)" on page 93).

## 7.9 Error message on screen

The meaning of the error message is explained in the documentation for the relevant components and programs on the ServerView Suite DVD 2.



---

## 8 CSS components

This chapter describes how to handle CSS components and how to identify defective CSS components and replace them yourself.



Further information on the CSS concept is provided in the "ServerView Suite Local Service Concept - LSC" manual on the ServerView Suite DVD 2.



### **CAUTION!**

Follow the safety instructions in the chapter ["Important information" on page 31](#).

In the PRIMERGY TX200 S6 server, the following components are considered to be CSS components:

- Hot-plug components
  - Hot-plug power supply units
  - Hot-plug hard disk drives

You can expand or replace the hot-plug components during operation.

- Non-hot-plug components
  - Memory modules
  - System fan
  - Expansion cards

These components can be changed by you in the event of an error. Expansions and upgrades may only be carried out by authorized specialist personnel. These operations are described in the "Options Guide".

# 8.1 Hot-plug components

This section describes how to handle hot-plug components and how to modify your server hardware (e.g. adding/replacing hot-plug power supply units or hot-plug HDD modules).

The hot-plug procedure increases the availability of system operation and guarantees a high degree of data integrity and failsafe performance.

## 8.1.1 Hot-plug power supply units (optional)

With two hot-plug power supply units installed, if a defect occurs in one power supply unit, the other power supply unit ensures unimpaired further operation. The defective power supply unit can be replaced without interrupting operation.

### 8.1.1.1 Replacing the hot-plug power supply unit

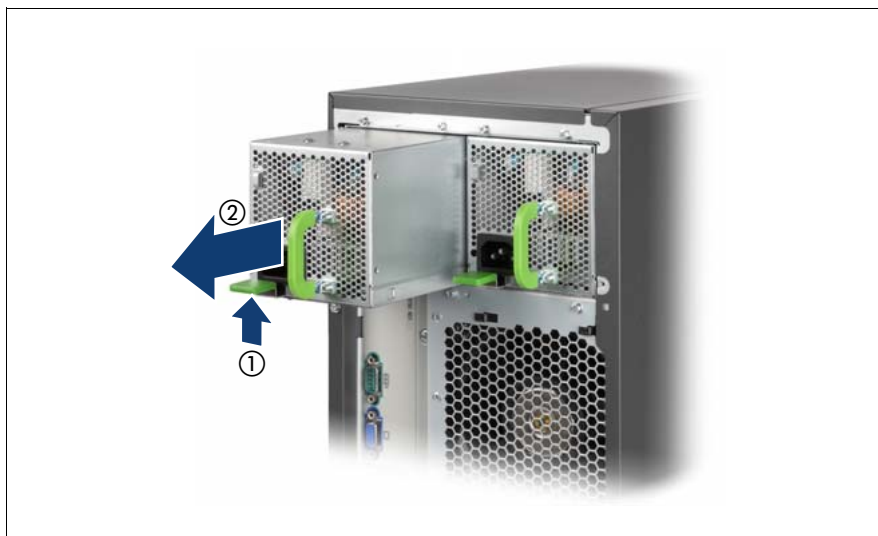

Figure 20: Unlocking and removing the power supply unit



#### CAUTION!

When replacing a **non-defective** hot-plug power supply unit in a non-redundant configuration (**only one** power supply unit), the server **must** be switched off first.

- ▶ Remove the power cable from the installed power supply unit.
- ▶ Push the green catch in the direction of the arrow (1) while pulling the power supply unit out of its mounting location (2) by the handle.
- ▶ Slide the new power supply unit into the empty slot until the locking mechanism engages.



Make sure that the power supply unit engages correctly in the slot and is locked in position.

This is the only way to prevent the power supply unit from sliding out of its mountings and being damaged during transportation.

- ▶ Connect the newly installed power supply unit.

## 8.1.2 Hot-plug hard disk drives

The hard disk drives which can be ordered for the PRIMERGY TX200 S6 are supplied already mounted in an installation frame so that defective hard disk drives can be replaced and new hard disk drives can be added during operation. The hard disk drive and installation frame together make up the HDD module.



### CAUTION!

- The hard disk drive must not be removed from the installation frame by anyone except a service technician.
- The HDD modules (drives) must all be marked clearly so that they can be put back in their original places after an upgrade. If this is not done, existing data can be lost.
- The hot-plug function is only possible in conjunction with a corresponding RAID configuration.

Further information about the RAID configuration or RAID level can be found in the RAID controller documentation.

- Do not touch the circuitry on boards or soldered parts. Hold the metallic areas or the edges of the circuit boards.
- Before removing the unit, turn the power off and wait for about 30 seconds until the disk stops spinning completely.
- When the hard disk unit is starting up, you may hear a resonant noise for a while, but this does not mean a failure.

- Depending on the OS, you can configure the write cache settings for the hard disk drives. However, disable the write cache for use in this server. If the power failure should occur while the write cache is enabled, cached data may be lost.
- When disposing of, transferring, or returning a hard disk unit, wipe out the data on the drive for your own security.
- Rough handling of hard disk units can damage the stored data. To cope with any unexpected problems, always back up important data. When backing up data to another hard disk drive, you should make backups on a file or partition basis.
- Be careful not to hit the hard disk unit or bring it into contact with metallic objects.
- Use the device on a shock and vibration free surface.
- Do not use the unit in extremely hot or cold locations, or locations with extreme temperature changes.
- Never attempt to disassemble the hard disk unit.

8.1.2.1 3.5-inch HDD module and dummy module



Figure 21: 3.5-inch HDD module and dummy module

1	Dummy module
2	Tabs for unlocking the dummy module
3	HDD module (installation frame with hard disk drive installed)
4	Indicators HDD Busy (LED green) HDD Fault (LED orange) For description see section <a href="#">"Hard disk drive indicators" on page 72.</a>
5	Handle for locking and unlocking the HDD module
6	Button for locking and unlocking the handle
7	Ridge for applying a sticker with the current drive name and drive size

### 8.1.2.2 2.5-inch HDD module and dummy module

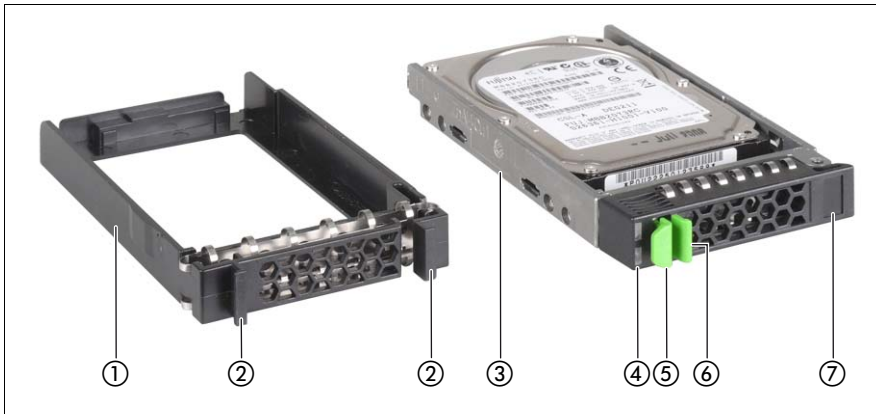

Figure 22: 2.5-inch HDD module and dummy module

1	Dummy module
2	Tabs for unlocking the dummy module
3	HDD module (installation frame with hard disk drive installed)
4	Indicators HDD Busy (LED green) HDD Fault (LED orange) For description see section <a href="#">"Hard disk drive indicators" on page 72.</a>
5	Handle for locking and unlocking the HDD module
6	Button for locking and unlocking the handle
7	Ridge for applying a sticker with the current drive name and drive size



### 8.1.2.3 Handling hard disk drives and HDD modules

Hard disk drives incorporated in the HDD modules are highly sensitive electromagnetic devices and must be handled with great care. Incorrect handling can cause partial or total failure of the hard disk drives. These failures can result in data errors and to a loss of data or to total corruption of the hard disk drive.

Observe the following rules to prevent such problems occurring:

- Only store and transport HDD modules within the limits stipulated in the specification.
- When transporting HDD modules (even over short distances), always use the original packaging (ESD label).
- Never expose HDD modules to a temperature shock. Avoid the formation of condensation inside and on the outside of the hard disk drive.



#### CAUTION!

The HDD module must be acclimatized in its operating environment for an acclimatization time before it is started up for the first time.

Temperature difference (°C) (operating environment/ outside)	Minimum acclimatization time (hours)
5	3
10	5
15	7
20	8
25	9
30	10

Table 2: Acclimatization times for HDD modules

- Always set the HDD module down carefully, with the large surface facing downwards to prevent it from tipping over.

### 8.1.2.4 Floorstand: removing the hard disk cover

For a floorstand server you make the HDD modules accessible by removing the hard disk cover:



Figure 23: Removing the hard disk cover

- ▶ Unlock the server (1).
- ▶ Remove the hard disk cover (2).

The hard disk drive cover is replaced and the server locked in the reverse order.

### 8.1.2.5 Removing/installing the dummy module

Free slots are provided with dummy modules. Remove the dummy module before installing an additional HDD module.

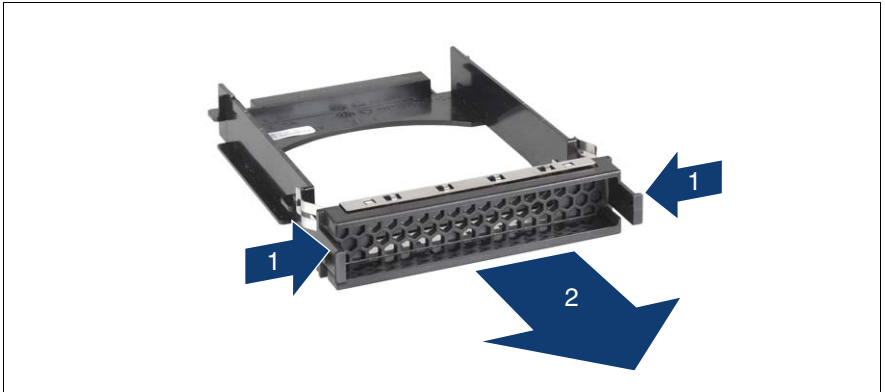

Figure 24: Removing/installing the dummy module (example: 3.5-inch dummy module)

- ▶ Press both tabs on the dummy module together until the locking mechanism disengages (1).
- ▶ Pull the dummy module out of the slot (2).

To install a dummy module, follow the same procedure in reverse order.



#### **CAUTION!**

Keep the dummy module for future use. If you have removed a HDD module and do not install a new one in its place, put the dummy module back in its place for cooling, to comply with EMC regulations (regulations regarding electromagnetic compatibility), and for protection against fire. Ensure that the dummy module engages correctly in the bay.

### 8.1.2.6 Installing the HDD module

#### Unlocking the HDD module

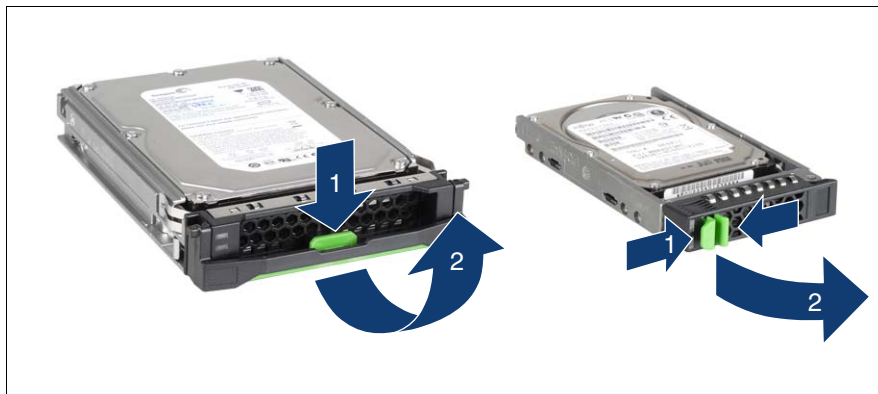

Figure 25: Unlocking the 3.5-inch and 2.5-inch HDD modules

- ▶ Release the locking mechanism by pressing the locking button (1).
- ▶ Push the handle of the HDD module fully in the direction of the arrow (2).  
The HDD module is now unlocked.

## Installing the HDD module



Figure 26: Installing the 3.5-inch and 2.5-inch HDD modules

- ▶ Unlock the HDD module as described in section "[Unlocking the HDD module](#)" on page 100.
- ▶ Carefully push the HDD module into the empty slot (1) until it stops.
- ▶ Push the handle of the HDD module as far as it will go in the direction of the arrow (2) until the locking mechanism is engaged.

### 8.1.2.7 Removing the HDD module



#### CAUTION!

- Only remove a HDD module during operation if the drive is not currently being accessed. Observe the control LEDs for the corresponding HDD modules (see ["Hard disk drive indicators" on page 72](#)).
- Under no circumstances should you remove a HDD module while the system is in operation if you are not sure that the hard disk drive is operated by a RAID controller and belongs to a disk array that is operating in RAID level 1, 5 or 6.

A HDD module can only be replaced during operation in conjunction with a corresponding RAID configuration.

- All HDD modules (drives) must be uniquely identified so that they can be reinstalled in their original mounting locations later. If this is not done, existing data can be lost.

If you want to remove a HDD module during operation, proceed as follows:

- ▶ If you want to remove a HDD module that is not defective, the drive must be first set to "Offline" via the software (RAID controller configuration software).
- ▶ Unlock the HDD module as described in section ["Unlocking the HDD module" on page 100](#).
- ▶ Pull the HDD module out a few centimeters.
- ▶ Wait for at least 60 seconds.



This period is necessary for the RAID controller to recognize that a HDD module has been removed and for the hard disk drive to come to a stop.

- ▶ Pull the HDD module out completely.

- ▶ Install the new HDD module, as described in ["Installing the HDD module" on page 101](#).

**CAUTION!**

If you have removed a HDD module and do not install a new one in its place, put the dummy module back in its place for cooling, to comply with EMC regulations (regulations regarding electromagnetic compatibility), and for protection against fire. Ensure that the dummy module engages correctly in the bay.

## 8.2 Non-hot-plug components

If a defective non-hot-plug component is detected (for more information, see chapter ["Starting up and operation" on page 65](#) and the "ServerViewSuite Local Service Concept - LSC" manual on the ServerView Suite DVD 2), proceed as follows:

- ▶ Exit all applications and shut down the server properly (see section ["Switching the server on and off" on page 77](#)).
- ▶ Pull all power connectors out of the power outlets.
- ▶ If the model is a rack model, remove the server from the rack (see section ["Installing/removing the rack model" on page 49](#)) and place the server on a table, for example.
- ▶ Open the server (see section ["Opening the server" on page 104](#)).
- ▶ Press the Indicate CSS button on the system board (see the technical manual for the system board D2799).

The PRIMERGY Diagnostic LED of the defective CSS component lights up orange, thereby indicating which CSS component (memory module, fan or expansion card) on the system board must be replaced (see technical manual for the system board D2799).

## 8.2.1 Opening the server and identifying the defective CSS component

### 8.2.1.1 Opening the server



#### CAUTION!

The device can be seriously damaged if it is opened without authorization or if repairs are attempted by untrained personnel.

It is essential to observe the safety instructions in chapter ["Important information"](#) on page 31.

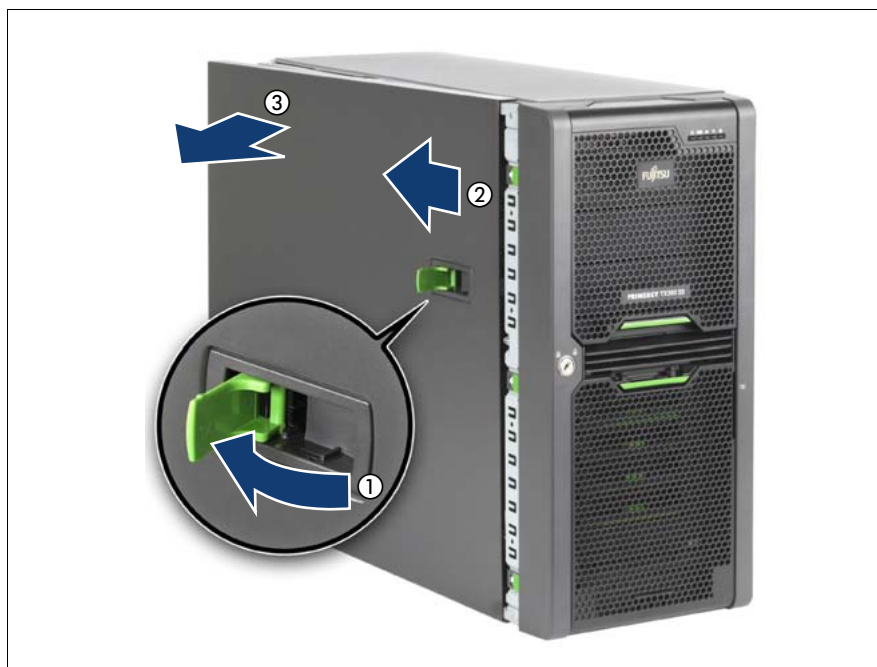

Figure 27: Opening the server (example: floorstand model)

- ▶ Unlock the server.
- ▶ Pull the locking lever as far as it will go (1).  
This pushes the side cover backward (2).
- ▶ Remove the side cover (3).



### 8.2.1.2 Removing system fan 2 (and 4)



Figure 28: System fan 2 and system fan 2&4

The standard system fan 2 has just one fan cable; the redundant system fan 2&4 (double fan) has two fan cables (as two fans are integrated internally).

The procedure for installing and removing both system fans is identical except for connecting the fan cables.



Figure 29: Example: Removing system fan 2&4

- ▶ Disconnect the fan cable from the connector FAN2 (if there is a second fan cable, disconnect this from FAN4) on the system board (see the technical manual for the system board D2799).
- ▶ Press the two green locks of the air duct together (1).
- ▶ Press the green lock of the air duct in the direction of the arrow (2).
- ▶ Lift the air duct with the integrated system fan 2 (and 4) up and out (3).

### 8.2.1.3 Removing system fan 1 (and 3)

- ▶ Remove system fan 2 (and 4) (see ["Removing system fan 2 \(and 4\)" on page 105](#)).

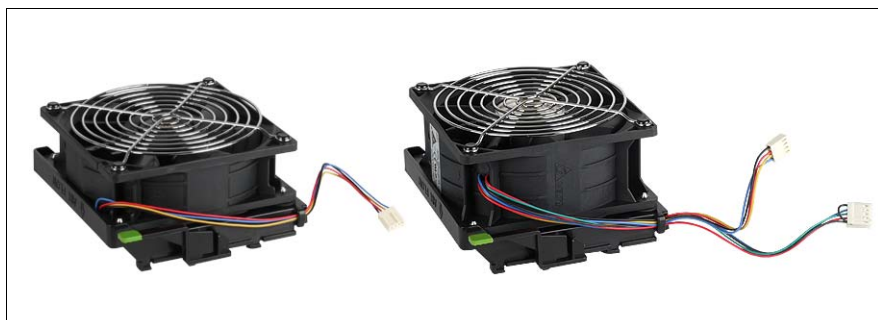

Figure 30: System fan 1 and system fan 1&3

The standard system fan 1 is shorter and has just one fan cable; the redundant system fan 1&3 is taller (as 2 fans are integrated internally) and has two fan cables.

The procedure for installing and removing both system fans is identical except for connecting the fan cables.

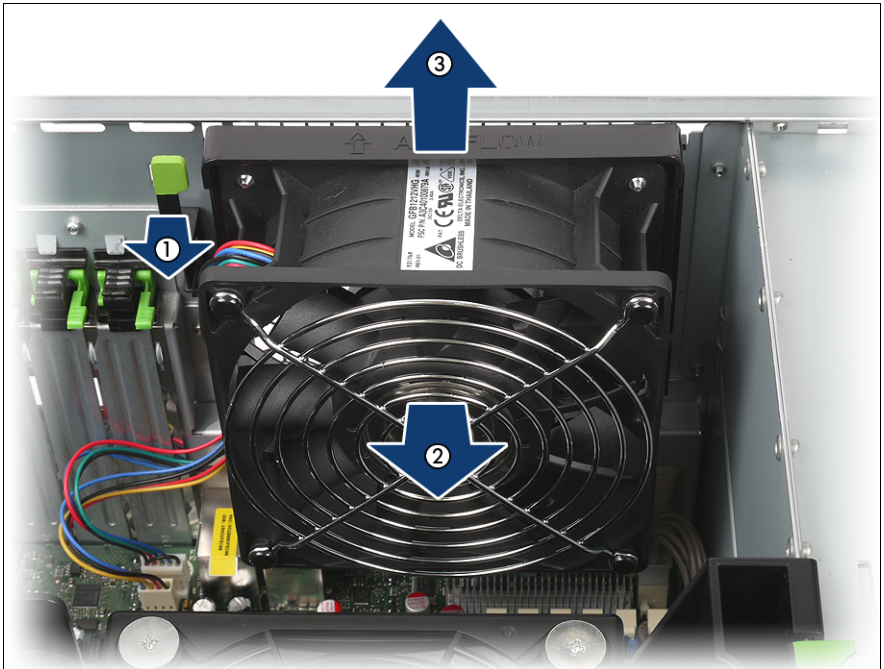

Figure 31: Example: Removing system fan 1&3

- ▶ Disconnect the fan cable from the connector FAN1 on the system board (if there is a second fan cable, disconnect this from FAN3).
- ▶ Push the locking lever in the direction of the arrow (1).
- ▶ Pull system fan 1 (and 3) in the direction of the arrow (2) to disengage the four hooks.
- ▶ Take system fan 1 (and 3) out (3).

#### 8.2.1.4 Identifying a CSS component

- ▶ Press the Indicate CSS button on the system board (see the technical manual for the system board D2799).

The PRIMERGY Diagnostic LED of the defective CSS component lights up orange, thereby indicating which CSS component (memory module, fan or expansion card) on the system board must be replaced (see technical manual for the system board D2799).

## 8.2.2 Replacing a memory module

### 8.2.2.1 Removing a defective memory module

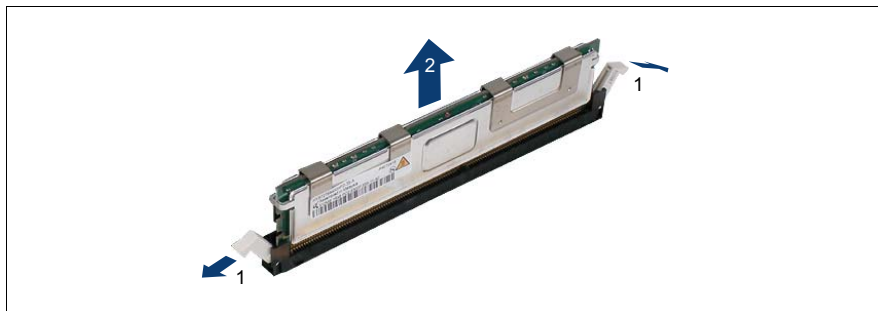

Figure 32: Removing a memory module

- ▶ Press the securing clips on both sides of the memory slot concerned outward. (1).
- ▶ Pull the defective memory module out of the slot (2).

### 8.2.2.2 Installing a new memory module



#### CAUTION!

Please note the equipping rules in the technical manual for the system board D2799.

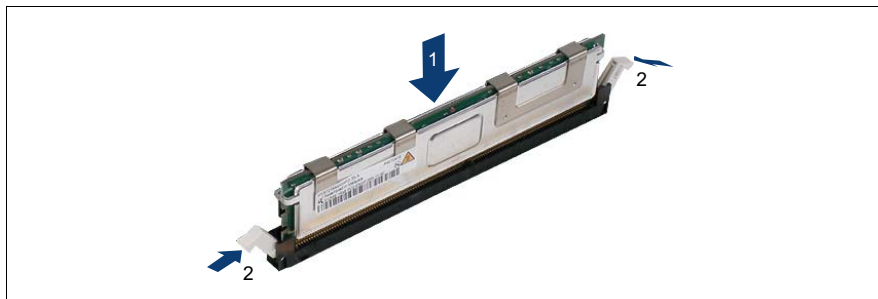

Figure 33: Inserting a memory module

- ▶ Carefully press the memory module into the slot (1) until the securing clips on both sides of it engage (2).

## 8.2.3 Replacing the system fan



### CAUTION!

Since the standard system fans 1 and 2 are not redundant, these system fans have to be replaced **immediately**.

If one of the four redundant system fans (1&3 and 2&4) fails, one of the two predetermined fans (system fan 3 and 4) increases its power to ensure that the server is cooled properly. The redundant system fans should be replaced as soon as possible.

### 8.2.3.1 Replacing system fan 2 (and 4)

- ▶ Remove the defective system fan 2 (and 4) (see "[Removing system fan 2 \(and 4\)](#)" on page 105).
- ▶ Install the new system fan 2 (and 4) (see "[Installing system fan 2 \(and 4\)](#)" on page 113).

### 8.2.3.2 Replacing system fan 1 (and 3)

- ▶ Remove the defective system fan 1 (and 3) (see "[Removing system fan 1 \(and 3\)](#)" on page 106).
- ▶ Install the new system fan 1 (and 3) (see "[Installing system fan 1 \(and 3\)](#)" on page 112).

## 8.2.4 Replacing an expansion card

### 8.2.4.1 Removing a defective expansion card

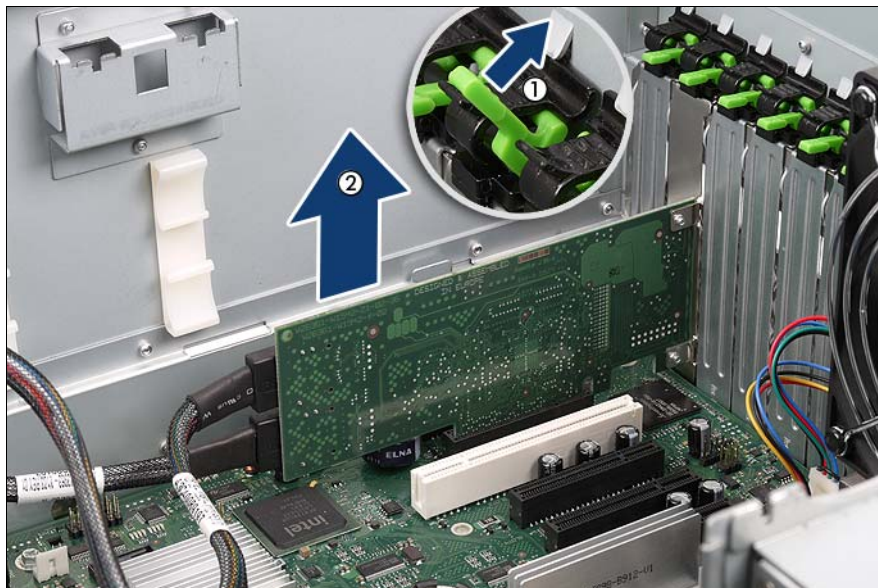

Figure 34: Removing a defective expansion card

- ▶ If necessary, remove the cables from the defective expansion card.
- ▶ Push the lever upwards (1).
- ▶ Press onto the clip and remove it.
- ▶ Pull the defective expansion card out of its slot (2).

### 8.2.4.2 Installing a new expansion card

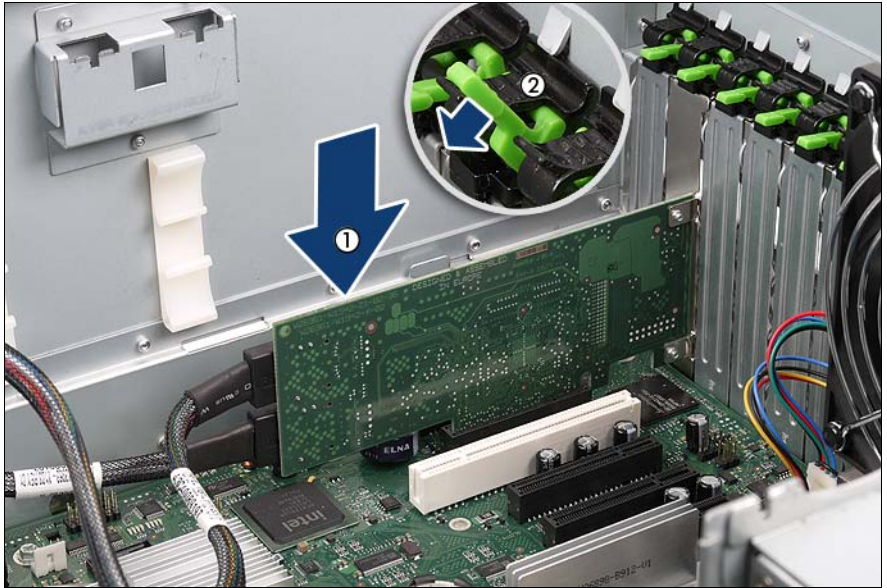

Figure 35: Installing a new expansion card

- ▶ Carefully press the new expansion card into the slot until it clicks into place (1).  
Make sure that the lug on the slot cover clicks into place in the corresponding hole.
- ▶ Fit the clip onto the slot cover so that the pin fits into the hole.
- ▶ Push the clip under the metal nose until it clicks into place.
- ▶ Swing the lever (2) downwards into its locking position.
- ▶ If necessary, connect the cables to the expansion card.

### 8.2.5 Reinstalling the fans and closing the server

#### 8.2.5.1 Installing system fan 1 (and 3)

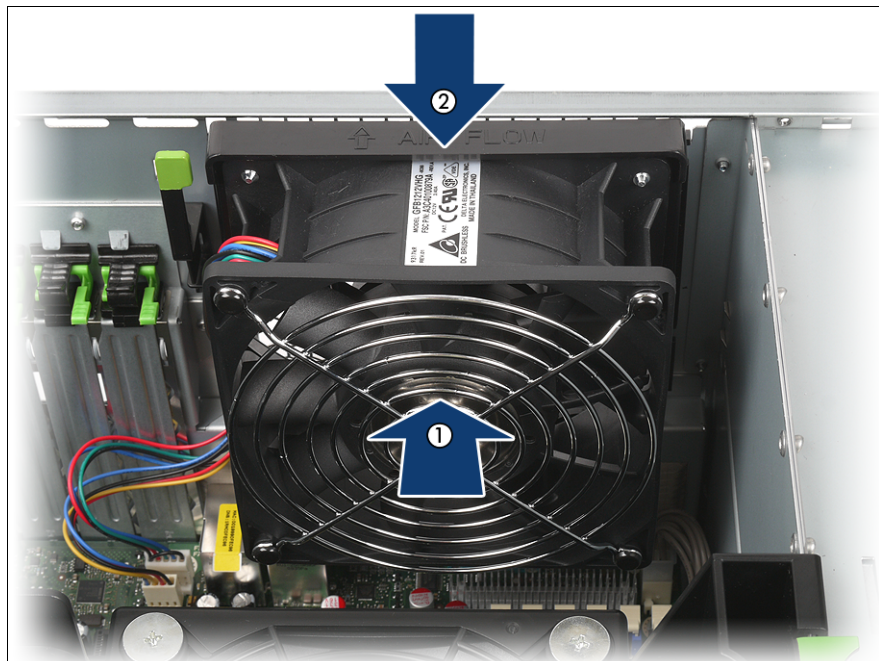

Figure 36: Installing system fan 1 (and 3)

- ▶ Place the hooks of system fan 1 (and 3) into the recesses on the rear of the server (1).
- ▶ Push system fan 1 (and 3) in the direction of the arrow until the locking lever engages (2).
- ▶ Connect the fan cable to the connector FAN1 (if there is a second fan cable, connect this in FAN3) on the system board (see the technical manual for the system board D2799).



### 8.2.5.2 Installing system fan 2 (and 4)

- ▶ Connect the fan cable to the connector FAN2 (if there is a second fan cable, connect this in FAN4) on the system board (see the technical manual for the system board D2799).



Figure 37: Installing system fan 2 (and 4)

- ▶ Carefully insert the air duct with the integrated system fan 2 (and 4) (1).  
Make sure that the locks (2) of the air duct engage in the housing bracket and in the recess of the fixing plate (standard power supply) or the power supply cage (redundant power supply).

### 8.2.5.3 Closing the server

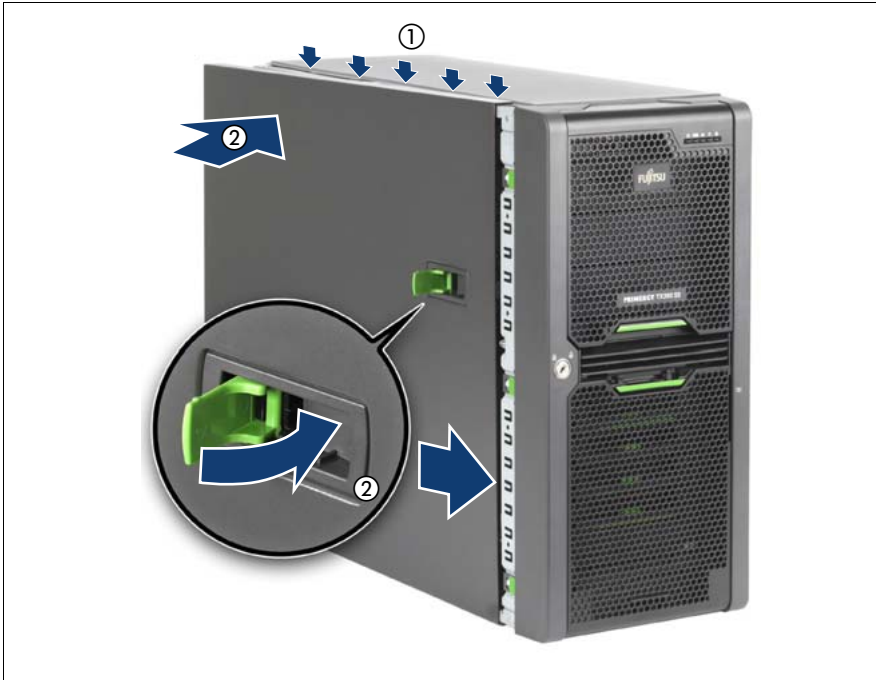

Figure 38: Closing the server (example: floorstand model)

- ▶ Pull the locking lever as far as it will go and insert the side cover in the five recesses (see small arrows) of the housing (1).
- ▶ Press the side cover against the housing and at the same time push the locking lever shut (2).

Closing the locking lever pushes the side cover forwards and the hooks on the upper edge of the side cover engage.

- ▶ In the case of rack models, you still have to slide the server back into the rack (see section "[Installing/removing the rack model](#)" on page 49).
- ▶ Connect all power plugs to the power outlets.
- ▶ Press the On/Off button to start up the server.

---

## 9 Appendix: server specification

This section explains the specifications for the server. The specifications for this server are liable to be updated without any notice. Please be forewarned.

### System Board

System board type	D2799
Chipset	Intel 5500

### Processor

Processor quantity and type	1 or 2 Intel Xeon processors
-----------------------------	------------------------------

### Memory Modules Configuration

Memory slots	12
Memory slot type	DIMM (DDR3)
Memory capacity (min. - max.)	2 GB - 96 GB
Memory protection	Advanced ECC; Memory Scrubbing; SDDC (Chipkill™); Hot-spare memory support Memory Mirroring support
Memory notes	max. 96 GB registered; min. 2 GB unbuffered; Memory Mirroring with 2 identical modules, Hot-spare Memory with three identical modules per channel

### Interfaces

USB connectors	10 x USB 2.0 (3x front, 4x rear, 3x internal for backup devices plus 1x USB stick)
Graphics (15-pin)	1 x VGA
Serial 1 (9-pin)	1 x serial RS-232-C, usable for iRMC S2 or system or shared

## Appendix: server specification

Serial 2 (9-pin)	1 x serial RS-232-C, optional - occupies an unused slot
LAN / Ethernet (RJ-45)	1 x Gbit/s Ethernet
Service LAN (RJ45)	1 x dedicated service LAN connector for iRMC S2 (10/100 Mbit/s) Service LAN traffic can be switched to shared onboard Gbit LAN port

### Onboard or integrated controllers

RAID Controller	Modular RAID 0/1 controller with "Integrated Mirroring Enhanced" (SAS IME) for SAS1.0. RAID levels 0, 1 and 1E are supported for internal hard disk drive configurations. For the Japanese market only RAID level 1 is supported for internal hard disk drive configurations.
	Modular RAID 0/1 controller with "MegaRAID functionality" (SAS MegaRAID) for SAS1.0 and SAS2.0. RAID levels 0, 1, 10 and 1E are supported for internal hard disk drive configurations.
	Modular RAID 5/6 controller with "MegaRAID functionality" (SAS MegaRAID) for SAS1.0 and SAS2.0. RAID levels 0, 1, 10, 1E, 5, 50, 6 and 60 are supported for internal hard disk drive configurations.
SATA Controller	ICH10R, 6-port SATA (4x for internal hard disks, 2x for accessible drives)
SATA Controller type notes	On board SATA controller supports RAID levels 0, 1, 10
Remote Management Controller	Integrated Remote Management Controller (iRMC S2, 32 MB attached memory incl. graphics controller), IPMI 2.0 compatible
Trusted Platform Module (TPM)	Infineon TCG V1.2 compliant (option)

**PCI-Slots**

PCI-Express 2.0 x4 (mech. x8)	2 x full height (1x long, 1x short)
PCI-Express 2.0 x8	2 x full height (1x notched, thus usable for x16 cards operating in x8 mode)
PCI-Express x4 (mech. x8)	1 x full height
PCI	1 x
Slot notes	PCI slot: 32-bit / 33 MHz, 5 V; in SAS-configurations 1x PCI-Express slot is occupied by the modular RAID-Controller

**Drive bays**

Hard disk bay configuration	4x 3,5-inch, for SAS / SATA or 8x 2,5-inch for SAS/SATA/SSD optional
Accessible drive bays	3 x 5.25/1.6-inch
Notes accessible drives	all possible options described in relevant system configurator

**Operating Panel**

Operating buttons	On/off switch
	NMI button
	Reset button
Status LEDs	System status (orange / yellow)
	Identification (blue)
	Hard disks access (green)
	Power (orange / green)
Status LED at system rear side:	System status (orange / yellow)
	Identification (blue)
	LAN connection (green)
	LAN speed (green / yellow)

## Appendix: server specification

---

Service displays (optional):	ServerView Local Service Panel (LSP)
	ServerView Local Service Display (LSD)

### Weight

Weight	up to 36.8 kg
Weight notes	Weight may vary depending on actual configuration
Rack mounting kit	Rack mounting kit as option; for the Japanese market, the rack mounting kit is standard

### Dimensions (Base unit specific)

Floor-stand (W x D x H)	205 (306) x 584 x 444 mm
Rack (W x D x H)	482 x 570 x 220mm
Mounting Depth Rack	596 mm
Dimension notes	Floorstand width 306 mm with tilt protection; depth measured excludes handles on redundant PSU. Rack depth excludes handles of redundant PSU and rack front.

### Environmental

Noise emission	Measured according to ISO 7779 and declared according to ISO9296
Sound pressure (LpAm)	34 dB(A) (idle) / 36 dB(A) (operating)
Sound power (LWAd; 1B = 10dB)	5.2 B (idle) / 5.7 B (operating)
Operating ambient temperature	10 - 35°C
Operating relative humidity	10 - 85 % (non condensing)

**Electrical values**

Power supply configuration	1x standard, 1x hot-plug or 2x redundant
Max. output of single power supply	685 W
Standard power supply output	700 W
Hot-plug power supply output	800 W
Rated voltage range	100 - 240 V
Rated frequency range	47- 63 Hz
Rated current	max. 9.5 A – 4.0 A (100 V / 240 V)





---

# Index

3rd party rack  
installing in 57  
requirements 50

## A

acclimatization time 45, 97  
Advanced Video Redirection 21  
ambient conditions 27  
ASR&R 20  
availability 20  
AVR 21

## B

batteries 35  
BIOS  
security functions 83  
BIOS update 23

## C

cables  
connecting 63  
disconnecting 63  
CE marking 26, 40  
Class A Compliance Statement 40  
cleaning  
keyboard 82  
monitor 82  
mouse 82  
server 82  
closing, server 114  
components  
hardware 11  
software 11  
configuration, server 79  
connecting cables 63  
Connecting the monitor 60  
connectors 59, 68  
COM1 59  
LAN connector 59  
management LAN connector 59

USB connector 59  
video connector 59  
consumables 43  
control elements 68  
control panel 68  
correcting faults 85  
CSS indicator 68, 71, 74

## D

data manipulation 11  
data protection 83  
data security 20  
DataCenter rack  
installing server 52  
requirements 49  
date, incorrect 88  
delivery note 29, 46  
devices, connecting to server 59  
disconnecting cables 63  
disposal, devices 44  
drive  
"dead" 88  
defective 89  
indicators 71  
dummy module, HDD module 99,  
103  
DVD drive activity  
indicator 68  
DVD drive activity indicator 71

## E

ECC 20  
EDC 20  
electrical data 26  
electromagnetic compatibility 26, 40  
electrostatic-sensitive devices  
(ESD) 38  
EMC directive 26  
EMC regulations 99, 103  
ENERGY STAR 39  
environment class 27

## Index

---

- environmental protection 43
- error
  - drifting display on monitor 87
  - drive “dead” 88
  - drive defective 89
  - incorrect date 88
  - incorrect time 88
  - no display on monitor 87
  - power-on indicator does not light 85
  - screen remains blank 86
  - screen shows flickering stripes 87
  - server switches itself off 86
- Error Correcting Code 20
- Error Detection Code 20
- error message on screen 89
- expansion card
  - installing 111
  - replacing 110
- expansion card, removing 110
- F**
- fault
  - drifting display on monitor 87
  - drive defective 89
  - incorrect date 88
  - incorrect time 88
  - no display on monitor 87
  - screen remains blank 86
  - screen shows flickering stripes 87
- FCC statement 40
- features 14
- flash EPROM 23
- G**
- Global Error indicator 68, 70, 73
- H**
- hard disk activity indicator 68, 70
- hard disk drive
  - handling 97
  - hot-plug 93
  - installation frame 93
- hard disk drive indicators 72
- HDD module 93
  - acclimatization time 97
  - installation frame 100
  - installing 100
- hot-plug HDD module 93
- hot-plug power supply unit 60
- hot-spare memory, memory module 20
- I**
- ID button 68, 69
- ID card 68, 69
  - product name 46, 69
  - serial number 46, 69
- ID indicator 68, 71, 74
- IME 17, 79
- indicators
  - CSS 68, 71, 74
  - DVD drive activity 68, 71
  - Global Error 68, 70, 73
  - hard disk activity 68, 70
  - hard disk drive 72
  - ID 68, 71, 74
  - LAN activity 75
  - LAN transfer rate 75
  - on power supply unit 76
  - on server 68
  - operation 68
  - system error 70, 73
- information, additional 13
- installing in
  - 3rd party rack 57
  - DataCenter rack 52
  - PRIMECENTER rack 52
- installing in the rack, notes 42
- Installing the operating system 81
- installing, server 49
- Integrated Mirroring Enhanced 17, 79
- integrated Remote Management Controller 21
- iRMC S2 21

**L**

labels 44  
LAN activity indicator 75  
LAN transfer rate, indicator 75  
laser information 37  
light emitting diode (LED) 37  
lithium battery 35  
Low Voltage Directive 26, 40

**M**

MAC address 69  
Main memory 108  
mains voltage, connecting server 60  
management LAN connector 21, 59  
meaning of the symbols 25  
MegaRAID 17, 79  
memory module  
    hot-spare memory 20  
    inserting 108  
    removing 108  
memory scrubbing 20  
monitor  
    display drifts 87  
    no display 87  
Mounting the anti-tilt bracket 48

**N**

NMI button 68, 69  
noise level 28  
notational conventions 25

**O**

On/Off button 68, 69  
onboard SATA controller 17, 79  
    configuring 81  
open, server 104  
operation 65  
overload 22

**P**

packaging 43, 46  
PCI SAS controller, configuring 81  
PDA 20, 22  
power on indicator 70

power supply unit

    cable clamp 62  
    hot-plug 60, 92  
    indicators 76  
    replacing 92  
    standard 60

power supply, redundant 60

power-on indicator 68

    does not light 85

PRIMECENTER Rack

    requirements 49

PRIMECENTER rack

    installing server 52

PRIMERGY Diagnostic

    LED 23

product name 46, 69

property protection 83

**R**

rack

    requirements 49

RAID controller is not configured for  
    this drive 89

RAID level 20

recycling devices 44

regulations and standards 26

Remote Storage 21

removing, server 49

Replacing the system fan 109

replacing, power supply unit 92

requirements

    3rd party rack 50

    DataCenter rack 49

    PRIMECENTER Rack 49

reset button 68, 69

return of devices 44

routing

    cables 55

**S**

Safety instructions 31

safety standards 26

SAS IME controller 17

SAS MegaRAID controller 17

- SAS/SATA RAID controller 17
    - configuring 79
  - saving energy 43
  - screen
    - error message 89
    - flickering 87
    - remains blank 86
    - shows flickering stripes 87
  - SDDC, Single Device Data
    - Correction 20
  - security function 11
  - serial number 46, 69
  - server
    - closing 114
    - configuration 23, 79
    - connecting external devices 59
    - connecting mains voltage 60
    - connectors 59
    - control panel 68
    - correcting faults 85
    - data protection 83
    - dimensions 27
    - electrical data 26
    - fitting in rack 49
    - hot-plug power supply unit 92
    - indicators 68
    - installing 49
    - LAN connector 59
    - NMI button 68
    - noise level 28
    - open 104
    - operation 65
    - power on indicator 70
    - product name 46
    - property protection 83
    - removing 49
    - routing cables 55
    - serial number 46
    - service 23
    - setting up 47
    - starting up 65
    - switches itself off (error) 86
    - switching off 77
    - switching on 77
    - technical data 26
    - transport 41
    - troubleshooting 85
    - unpacking 46
    - ventilation clearance 27
    - weight 27
  - server management 22
  - ServerView Installation Manager 23, 80
  - ServerView Operations Manager 22
    - supported functions 22
  - ServerView Remote Management 24
  - service
    - PRIMERGY Diagnostic LED 23
    - server 23
    - touch point 23
  - service LAN connector 21
  - setting up, server 47
  - Single Device Data Correction (SDDC) 20
  - Support bracket 53
  - switch off time, defining 78
  - switch on time, defining 78
  - switching off, server 77
  - switching on, server 77
  - system board
    - PRIMERGY Diagnostic LED 23
  - system board, features 15
  - system fan 1, 1&3
    - installing 112
    - removing 106
  - system fan 2, 2&4
    - installing 113
    - removing 105
  - system information 69
- ## T
- target group 12
  - technical data 26
    - ambient conditions 27
  - time, incorrect 88
  - tips 85
  - touch point

- service [23](#)
- TPM [15](#)
- transport damage [29, 46](#)
- transporting the server [41](#)
- troubleshooting [85](#)
- Trusted Platform Module [15](#)

**U**

- unpacking, server [46](#)
- USB connector [59, 68](#)
- using the cable clamp [62](#)

**V**

- ventilation clearance [27](#)
- video connector [59](#)

**W**

- weight [27](#)



## Free Manuals Download Website

<http://myh66.com>

<http://usermanuals.us>

<http://www.somanuals.com>

<http://www.4manuals.cc>

<http://www.manual-lib.com>

<http://www.404manual.com>

<http://www.luxmanual.com>

<http://aubethermostatmanual.com>

Golf course search by state

<http://golfingnear.com>

Email search by domain

<http://emailbydomain.com>

Auto manuals search

<http://auto.somanuals.com>

TV manuals search

<http://tv.somanuals.com>