

PRIMERGY RX330 S1 Server

Operating Manual

Edition May 2007

Comments... Suggestions... Corrections...

The User Documentation Department would like to know your opinion of this manual. Your feedback helps us optimize our documentation to suit your individual needs.

Feel free to send us your comments by e-mail to manuals@fujitsu-siemens.com.

Certified documentation according to DIN EN ISO 9001:2000

To ensure a consistently high quality standard and user-friendliness, this documentation was created to meet the regulations of a quality management system which complies with the requirements of the standard DIN EN ISO 9001:2000.

cognitas. Gesellschaft für Technik-Dokumentation mbH
www.cognitas.de

Copyright and Trademarks

Copyright © 2007 Fujitsu Siemens Computers GmbH.

All rights reserved.

Delivery subject to availability; right of technical modifications reserved.

All hardware and software names used are trademarks of their respective manufacturers.

Contents

1	Introduction	7
1.1	Documentation overview	7
1.2	Features	9
1.3	Notational conventions	16
1.4	Technical data	17
2	Installation steps, overview	19
3	Important information	21
3.1	Safety	21
3.2	CE conformity	28
3.3	FCC Class A Compliance Statement	28
3.4	Transporting the server	29
3.5	Notes on installing in the rack	30
3.6	Environmental protection	31
4	Hardware installation	33
4.1	Unpacking the server	34
4.2	Installing/removing the server in/from the rack	35
4.2.1	Installation in PRIMECENTER/DataCenter Rack	39
4.2.2	Installation in 3rd party racks	42
4.2.3	Inserting the server	43
4.3	Connecting devices to the server	45
4.4	Connecting the server to the mains	47
4.5	Notes on connecting/disconnecting cables	48

Contents

5	Starting up and operation	49
5.1	Controls and displays	49
5.1.1	Front of server	49
5.1.2	Rear of server	53
5.2	Switching the server on and off	56
5.3	Configuring the server	58
5.3.1	Configuring onboard SAS controller	58
5.3.2	Configuration with ServerStart	59
5.3.3	Configuration without ServerStart	60
5.4	Cleaning the server	60
6	Property and data protection	61
6.1	BIOS Setup security functions	61
7	Troubleshooting and tips	63
7.1	Power-on indicator remains unlit	63
7.2	Server switches itself off	64
7.3	Screen remains blank	64
7.4	Flickering stripes on monitor screen	65
7.5	No screen display or display drifts	65
7.6	No mouse pointer displayed on screen	65
7.7	Incorrect date and time	66
7.8	System will not boot	66
7.9	Drives reported as “dead” when starting system	67
7.10	Added drive reported as defective	67
7.11	Error message on screen	67

8	Hot-plug components	69
8.1	Hot-plug power supply units	69
8.1.1	Remove the dummy module	70
8.1.2	Installing/removing the hot-plug power supply unit	71
8.1.3	Replacing the hot-plug power supply unit	72
8.2	Hot plug hard disk drives	73
8.2.1	Handling hard disk drives and HDD modules	75
8.2.2	Removing/Installing the dummy module	76
8.2.3	Installing/removing the HDD module	77
Abbreviations		81
Literature		87
Index		89

1 Introduction

The PRIMERGY RX330 S1 server is an AMD-based server for workgroups and small networks. The server is suitable for use as a file server and also as an application, information or Internet server.

Thanks to its highly developed hardware and software components, the PRIMERGY RX330 S1 server offers a high level of data security and availability. These components include hot-plug hard disk modules, redundant power supply units, and the Server Management *ServerView Suite*, Prefailure Detection and Analysing (PDA) and Automatic Server Reconfiguration and Restart (ASR&R).

Security functions in the *BIOS setup* protect the data on the server against manipulation. Additional security is provided by the lockable rack door.

The server occupies 2 height units (HU) in the rack.

1.1 Documentation overview



PRIMERGY manuals are available in PDF format on the *ServerBooks* DVD. The *ServerBooks* DVD is part of the *ServerStart Suite* supplied with every server.

The PDF files of the manuals can also be downloaded free of charge from the Internet. The overview page showing the online documentation available on the Internet can be found using the URL:

<http://manuals.fujitsu-siemens.com>. The PRIMERGY server documentation can be accessed using the *Industry standard servers* navigation option.

Concept and target groups for this manual

This operating manual describes how to install, set up and operate your server.

This manual is intended for those people responsible for installing the hardware and ensuring that the system runs smoothly. The manual contains all the information required to install and operate your PRIMERGY RX330 S1.

It is assumed that users have some knowledge of hardware and data transmission, and a basic familiarity with the operating system that is being used.

Additional server documentation

The PRIMERGY RX330 S1 documentation also includes:

- “Quick Start Hardware - PRIMERGY RX330 S1” (leaflet)
- “Quick Start Software - PRIMERGY ServerView Suite” (leaflet)
- “Warranty” manual (print version supplied with the system, PDF file available on the *ServerBooks* DVD supplied)
- “Safety notes and other important information” manual (print version supplied with the system, PDF file available on the *ServerBooks* DVD supplied)
- “Ergonomics” manual (PDF file available on the *ServerBooks* DVD supplied)
- “Returning used devices” manual (PDF file available on the *ServerBooks* DVD supplied)
- “Helpdesk” (leaflet with worldwide helpdesk telephone numbers)
- Technical manual for the system board D2440 (PDF file available on the *ServerBooks* DVD supplied)
- “BIOS Setup” (PDF file available on the *ServerBooks* DVD supplied)
- “PRIMERGY RX330 S1 Server Options Guide” (PDF file available on the *ServerBooks* DVD)



The “Options Guide” describes the server expansion and modification options.

- “ServerView Suite” includes the *ServerStart* Disc 1, the *ServerStart* Disc 2 and the *ServerBooks* DVD. The version of the “PRIMERGY ServerView Suite - ServerStart” user manual is available on the *ServerBooks* DVD.



If you need a replacement copy of the *ServerBooks* DVD, send the details of your server to the following e-mail address: Reklamat-PC-LOG@fujitsu-siemens.com

- “ServerView RAID User Manual” (PDF file available on the *ServerBooks* DVD supplied)
- “Integrated RAID for SAS User’s Guide” (PDF file available on the *ServerBooks* DVD supplied)
- “Integrated Mirroring User’s Guide” (PDF file available on the supplied *ServerBooks* DVD)
- “LSI SATA Software RAID User’s Guide” (PDF file available on the *ServerBooks* DVD supplied)

Further sources of information:

- Technical Manual for the relevant rack
- Manual for the monitor
- Manual on *ServerView* Server Management
- Manual for the remote testing and diagnostic system *RemoteView*
- Documentation for boards and drives
- Documentation for your operating system
- Information files on your operating system

(See also [“Literature” on page 87.](#))

1.2 Features

System board

The features of the system board are described in the technical manual for the system board D2440 for the hardware and in the “BIOS Setup” for the firmware (see [“Literature” on page 87.](#))

Hard disk drives

The server includes two drive cages with up to six (2x3) SAS/SATA2 hard disk modules. Each hard disk module can accommodate an SAS/SATA2 hard disk drive with a maximum height of 1 inch. The module is connected to the SAS/SATA2 backplane wirelessly. This allows hard disk drive modules to be simply plugged in or pulled out (for further details see [“Hot plug hard disk drives” on page 73.](#))

The hard disk subsystem is designed for SAS/SATA 2, each with one channel for each hard disk drive.

If the server has the corresponding RAID configuration, HDD modules can also be exchanged during operation.

Onboard SAS controller with Integrated Mirroring Enhanced functionality

An onboard SAS controller with "Integrated Mirroring Enhanced" (IME) functionality is fitted to operate the six hard drives. IME also offers RAID functionality for configuring the internal hard disk drives (RAID level 0, 1).



A separate utility is available to the controller for IME configuration. Further information can be found in the "Integrated RAID for SAS User's Guide" (on the *ServerBooks* DVD under "Controllers").

The RAID functionality can optionally be expanded with a corresponding PCI expansion module (zero-channel RAID controller). In addition to RAID levels 0 and 1, this RAID controller also offers the option of configuring RAID 5. The ZCR controller uses the Onboard SAS controller using logic that is specially integrated on the system board.

Accessible drives

A 5.25 inch bay is available for a CD/DVD drive or a magnetic tape drive. The accessible drive installed here cannot be replaced during operation.

USB port

The USB interface on the front of the server supports activities carried out by the service technician. The maximum length of the external cable are three meters.

Power supply

The basic configuration of the server includes a hot-plug power supply unit, which automatically sets itself to a mains voltage in the range of 100 V - 127 V or 200 V - 240 V. As an option, the power supply can be expanded with an extra power supply unit to create a redundant power supply. If a power supply unit fails, the redundant configuration assures continued operation. The defective power supply unit can be replaced during operation (for further details see ["Hot-plug power supply units" on page 69](#)).

High level of availability and data security

When memory data is accessed, 1-bit errors in the main memory are identified and automatically corrected with the ECC (Error Correcting Code) method. The patented memory scrubbing function regularly starts up the EDC mechanism and thus ensures continuous data integrity.

The memory modules used support SDDC technology (Chipkill™), which also increases the effectiveness of the monitoring and correction of memory errors.

ASR&R (Automatic Server Reconfiguration and Restart) restarts the system in case of an error and automatically “hides” the defective system components.

The PDA (Prefailure Detection and Analyzing) technology from Fujitsu Siemens Computers analyzes and monitors all components that are critical for system reliability.

The onboard SAS controller in conjunction with the ZCR controller supports RAID levels 0, 1, and 5, thereby increasing the availability of the system. Additional security is provided by the hot-plug HDD modules (depending on the server variant).

iRMC with integrated service LAN port



The features of the iRMC Advanced Video Redirection and Remote Storage are available as an option.

The iRMC (integrated **R**emote **M**anagement **C**ontroller) is a BMC with integrated service LAN port and expanded functionality that was previously only available with additional plug-in cards. In this way, the iRMC enables complete control of PRIMERGY servers, regardless of system status, and thus particularly the control of PRIMERGY servers that are in the "out-of-band" system status.

By default, the service LAN port is assigned to the iRMC. However, you can also configure LAN port 2 as the service LAN port in the BIOS setup. LAN port 2 then fulfills the tasks of a standard LAN port and those of a service LAN port at the same time (virtual LAN with 2 different IP addresses).

Major functions supported by the iRMC include the following:

- Browser access via iRMC's own Web server
- Secure communication (SSH, SSL)
- Power Management for the managed server (depending on its system status)
- Text console bypass
- Command Line Interface (CLP)
- Simple, interactive or script-based iRMC configuration
- iRMC-s own user management
- Automatic network configuration via DNS / DHCP
- Power supply to the iRMC via the system standby supply
- Full-coverage alarm management
- System Error and Event Log (SEL) reading and processing

More information about the iRMC can be found in the "PRIMERGY ServerView Suite - integrated Remote Management Controller (iRMC)" manual (see "[Literature](#)" on page 87).

Server management

Server management is implemented using the *ServerView* software supplied combined with PDA (Prefailure Detection and Analyzing) technology from Fujitsu Siemens Computers. PDA reports the threat of a system error or overload at an early stage, allowing preventive measures to be taken.

ServerView enables the management of all PRIMERGY servers in the network via a central console. The following key functions and others are supported by *ServerView*:

- Round-the-clock monitoring, regardless of server status
- High-performance, graphical console bypass (AVR) protected by HTTPS/SSL (128 bit)
- Remote storage via USB
- Remote power on (Wake On LAN)
- Automatic switch-off when the housing is opened (Housing monitoring)
- Temperature monitoring of the CPU and the surrounding area
- Watchdog timer for Automatic Server Reconfiguration and Restart (ASR&R) in the event of failure of memory modules or processors
- Power monitoring
- End-of-life monitoring of fans with prompt notification before failure
- Watchdog timer for operating system monitoring and application monitoring with ASR&R

Further information about *ServerView* server management is provided in the associated documentation (see [“Literature” on page 87](#)).

ServerStart

You can configure the PRIMERGY server quickly and precisely with the Server-Start software provided. User-guided menus are available for installing the server operating system (for further details see section [“Configuring the server” on page 58](#)).

Service and support

PRIMERGY servers are service-friendly and modular, thus enabling quick and simple maintenance.

The handles and locks (touch point) on the different hot pluggable components are colored green to ensure simple and immediate recognition.

In order to avoid damage to components by incorrect handling when they are being installed and removed, green highlighting also identifies the areas of all components that can be touched without causing damage to the respective component.

The Flash EPROM program supplied with the Fujitsu Siemens Computers utilities supports a fast BIOS update.

With the iRMC (integrated Remote Management Controller) on the system board and the optional remote testing and diagnostic system *RemoteView*, the PRIMERGY RX330 S1 server can also be maintained and serviced remotely. This enables remote diagnosis for system analysis, remote configuration and remote restart should the operating system or hardware fail.

RemoteView

RemoteView is the remote management solution from Fujitsu Siemens Computers for PRIMERGY servers. *RemoteView* and the relevant hardware components integrated on the system board allow remote monitoring and maintenance as well as fast restoration of operation in the event of errors.

Remote monitoring and maintenance avoids time-consuming and costly on-site repairs and reduces service costs. This leads to a reduction in the total cost of ownership and an excellent return on investment for the remote management solution.



The administrator can access all system information and information from the sensors such as fan speeds or voltages via the iRMC's Web interface (see section "[iRMC with integrated service LAN port](#)" on page 11). He can also start the text-based or graphic console bypass (Advanced Video Redirection, AVR) and get information about remote storage.



The features of the iRMC Advanced Video Redirection and Remote Storage are available as an option.

1.3 Notational conventions

The following notational conventions are used in this manual:

<i>Text in italics</i>	indicates commands, menu items or software programs.
“Quotation marks”	indicate names of chapters and terms that are being emphasized.
▶	describes activities that must be performed in the order shown.
 CAUTION!	pay particular attention to texts marked with this symbol. Failure to observe this warning may endanger your life, destroy the system or lead to the loss of data.
	indicates additional information, notes and tips.

1.4 Technical data

Electrical data (hot-plug power supply unit)

Rated voltage range	100 V - 127 V or 200 V - 240 V
Frequency	50 Hz - 60 Hz
Rated current with basic configuration	100 V - 240 V / 1.7 A - 0.8 A
Max. rated current	100 V - 240 V / 4.7 A - 2.0 A
Effective power	453 W
Apparent power	462 VA
Heat dissipation	1630 kJ/h (1545 btu/h)
Main power fuse	16 A
Protection class	I

Compliance with regulations and standards

Product safety and ergonomics	IEC 60950-1 / EN 60950-1, UL/CSA 60950-1, CNS 14336 / GB 4943 / EN 50371
Electromagnetic compatibility	FCC class A CNS 13438 class A; VCCI class A AS/NZS CISPR 22 class A / GB 9254 class A GB 17625
Interference emissions	EN 55022 class A
Harmonic current	EN 61000-3-2
Flicker	EN 61000-3-3
Interference immunity	EN 55024, EN 300386
CE marking to EU directives	Low Voltage Directive 73/23/EEC (Product Safety) Electromagnetic Compatibility 89/336/EEC

Mechanical values

Width	431 mm
Depth	686 mm
Height	87 mm (2 HU)
Installation depth in the rack	651 mm
Cable depth in the rack	200.0 mm (1000 mm rack recommended)

Weight

Approx. 24 - 27 kg (depending on configuration).

Ventilation clearance

At least 200 mm on the front and rear.

Ambient conditions

Environment class 3K2 Environment class 2K2	EN 60721 / IEC 721 Part 3-3 EN 60721 / IEC 721 Part 3-2
Temperature:	
Operation (3K2)	10 °C ... 35 °C
Transport (2K2)	-25 °C ... 60 °C
Humidity	10% ... 85%

Condensation during operation must be avoided!

Noise level

Sound power level L_{WAd} (ISO 9296)	< 6.6 B (standby) < 7.3 B (operation)
Sound pressure level at adjacent workstation L_{pAm} (ISO 9296)	< 49 dB (A) (standby) < 56 dB (A) (operation)

2 Installation steps, overview

This chapter contains an overview of the steps necessary to install your server. Links guide you to sections where you can find more detailed information on the individual steps:

- ▶ First of all, it is essential that you familiarize yourself with the safety information in the [“Important information” on page 21](#) chapter.
- ▶ Unpack the system, check the contents of the package for visible transport damage and check whether the delivery agrees with the details in the delivery note (see [“Unpacking the server” on page 34](#)).
- ▶ The server includes loose parts. Keep these parts in a safe place. They are designed to be used for installing optional components at a later time.
- ▶ Transport the server to the place where you want to install it
- ▶ Make sure that all necessary manuals (see [“Additional server documentation” on page 8](#)) are available; print out the PDF files if required.
- ▶ Mount the server into the rack (see [“Installing/removing the server in/from the rack” on page 35](#)).
- ▶ Wire the server. To do this, refer to sections [“Connecting devices to the server” on page 45](#) and [“Notes on connecting/disconnecting cables” on page 48](#).
- ▶ Connect the system to the line voltage (see [“Connecting the server to the mains” on page 47](#)).
- ▶ Make yourself familiar with the operating and indicator elements on the front and on the rear side of the server (see [“Controls and displays” on page 49](#)).

- ▶ Configure the server and install the desired operating system and applications. The following options are available:

- Remote configuration and installation with *ServerStart*:

The *ServerStart* disc supplied allows you to conveniently configure the server and install the operating system.

Details on how to operate *ServerStart*, as well as some additional information, can be found in the “PRIMERGY ServerView Suite - ServerStart” manual.

Configuration information can also be found in the “[Configuration with ServerStart](#)” on page 59 section.

- Local configuration and installation with or without *ServerStart* (see the “[Configuration with ServerStart](#)” on page 59 section or the “[Configuration without ServerStart](#)” on page 60 section).



You will find more information on installing the server remotely or locally in the *ServerStart* manual. This manual contains the installation steps (“Quick Step Guide”). A corresponding file in PDF format is included on the *ServerBooks* DVD.

3 Important information

In this chapter you will find essential information regarding safety when working on your server.

3.1 Safety



The following safety instructions are also provided in the manual “Safety notes and other important information”.

This device complies with the relevant safety regulations for data processing equipment. If you have any questions about where you can set up the device, contact your sales outlet or our customer service team.



CAUTION!

- The actions described in this manual should only be performed by technical specialists.
- Equipment repairs should only be performed by service personnel.
- Any unauthorized opening and improper repairs could expose the user to risks (electric shock, energy hazards, fire hazards) and could also damage the equipment.
- Any unauthorized opening of the device will result in the invalidation of the warranty and exclusion from all liability.

Before starting up



CAUTION!

- During installation and before operating the device, observe the instructions on environmental conditions for your device (see [section “Technical data” on page 17](#)).
- If the server has been moved from a cold environment, condensation may form both inside and on the outside of the machine.

Wait until the server has acclimatized to room temperature and is absolutely dry before starting it up. Material damage may be caused to the server if this requirement is not met.

- Only transport the server in the original packaging or in packaging that protects it from impacts and jolts.

Installation and operation



CAUTION!

- This unit should not be operated in ambient temperatures above 35°C.
- If the unit is integrated into an installation that draws power from an industrial power supply network with an IEC309 connector, the power supply's fuse protection must comply with the requirements for non-industrial power supply networks for type A connectors.
- The unit automatically adjusts itself to a mains voltage in a range of 100 V - 127 V or 200 V - 240 V. Ensure that the local mains voltage lies within these limits.
- This device must only be connected to properly grounded shock-proof sockets or insulated sockets of the rack's internal power supply with tested and approved power cables.
- Ensure that the device is connected to a grounded shockproof socket close to the device.

**CAUTION!**

- Ensure that the power sockets on the device and the grounded shock-proof sockets are freely accessible.
- The On/Off button or the main power switch (if present) does not isolate the device from the mains power supply. To disconnect it completely from the mains power supply, unplug all network power plugs from the grounded shockproof sockets.
- Always connect the server and the attached peripherals to the same power circuit. Otherwise you run the risk of losing data if, for example, the central processing unit is still running but a peripheral device (e.g. memory subsystem) fails during a power outage.
- Data cables must be adequately shielded.
- The EN 50173 and EN 50174-1/2 standards apply for LAN cabling. The minimum requirement is the use of a category 5 screened LAN cable for 10/100 Mbps Ethernet, or a category 5e cable for Gigabit Ethernet. The requirements from the ISO/IEC 11801 specification must also be met.
- Route the cables in such a way that they do not create a potential hazard (make sure no-one can trip over them) and that they cannot be damaged. When connecting the server, refer to the relevant instructions in this manual.
- Never connect or disconnect data transmission lines during a storm (risk of lightning strike).
- Make sure that no objects (e.g. jewelry, paperclips etc.) or liquids get inside the unit (electric shock hazard, short circuit).
- In emergencies (e.g. damaged casing, controls or cables, penetration of liquids or foreign bodies), switch off the server immediately, remove all power plugs and contact your sales outlet or customer service team.

**CAUTION!**

- Proper operation of the system (in accordance with IEC 60950-1/ EN 60950-1) is only ensured if the casing is completely assembled and the rear covers for the installation slots have been fitted (electric shock, cooling, fire protection, interference suppression).
- Only install system expansions that satisfy the requirements and rules governing safety and electromagnetic compatibility and those relating to telecommunication terminals. If you install other expansions, they may damage the system or violate the safety regulations. Information on which system expansions are approved for installation can be obtained from our customer service center or your sales outlet.
- The components marked with a warning notice (e.g. lightning symbol) may only be opened, removed or exchanged by authorized, qualified personnel. Exception: hot-pluggable power supply units can be replaced.
- The warranty is void if the server is damaged during installation or replacement of system expansions.
- Only set screen resolutions and refresh rates that are specified in the operating manual for the monitor. Otherwise, you may damage your monitor. If you are in any doubt, contact your sales outlet or customer service center.

Working with CDs/DVDs and CD/DVD drives

When working with devices with CD/DVD drives, these instructions must be followed.



CAUTION!

- Only use CDs/DVDs that are in perfect condition in your server's CD/DVD drive, in order to prevent data loss, equipment damage and injury.
- Check each CD/DVD for damage, cracks, breakages etc. before inserting it in the drive.

Note that any additional labels applied may change the mechanical properties of a CD/DVD and cause imbalance.

Damaged and imbalanced CDs/DVDs can break at high drive speeds (data loss).

Under certain circumstances, sharp CD/DVD fragments can pierce the cover of the CD/DVD drive (equipment damage) and can fly out of the device (danger of injury, particularly to uncovered body parts such as the face or neck).



You can prevent mechanical damage and damage to the CD/DVD drive, as well as premature CD/DVD wear, by observing the following suggestions:

- Only insert CDs/DVDs in the drive when needed and remove them after use.
- Store the CDs/DVDs in suitable sleeves.
- Protect the CDs/DVDs from exposure to heat and direct sunlight.

Laser information

The CD/DVD drive complies with IEC 60825-1 laser class 1.



CAUTION!

The CD/DVD drive contains a light-emitting diode (LED), which under certain circumstances produces a laser beam stronger than laser class 1. Looking directly at this beam is dangerous.

Never remove parts of the CD/DVD drive casing!

Batteries



CAUTION!

- Incorrect replacement of batteries may lead to a risk of explosion. The batteries may only be replaced with identical batteries or with a type recommended by the manufacturer (see the technical manual for the system board under “Literature” on page 87).
- Do not throw batteries into the trash can. They must be disposed of in accordance with local regulations concerning special waste.
- The battery must be disposed of in accordance with local regulations concerning special waste.
- Replace the lithium battery on the system board in accordance with the instructions in the technical manual for the system board (see “Literature” on page 87).
- All batteries containing pollutants are marked with a symbol (a crossed-out garbage can). In addition, the marking is provided with the chemical symbol of the heavy metal decisive for the classification as a pollutant:

Cd Cadmium

Hg Mercury

Pb Lead

Modules with Electrostatic-Sensitive Devices

Modules with electrostatic-sensitive devices are identified by the following sticker:

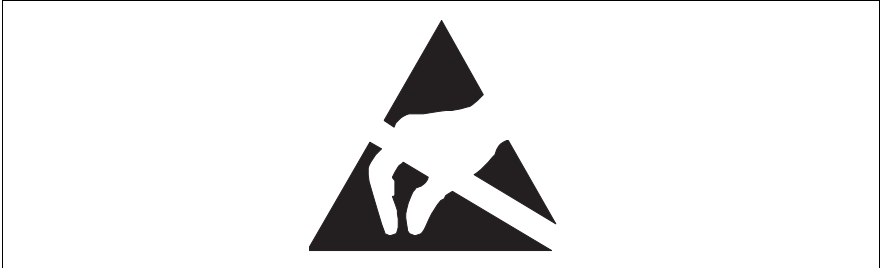

Figure 1: ESD label

When you handle components fitted with ESDs, you must always observe the following points:

- Switch off the system and remove the power plugs from the power outlets before installing or removing components with ESDs.
- You must always discharge static build-up (e.g. by touching a grounded object) before working with such components.
- Any devices or tools that are used must be free of electrostatic charge.
- Wear a suitable grounding cable that connects you to the external chassis of the system unit.
- Always hold components with ESDs at the edges or at the points marked green (touch points).
- Do not touch any connectors or conduction paths on an ESD.
- Place all the components on a pad which is free of electrostatic charge.



For a detailed description of how to handle ESD components, see the relevant European or international standards (EN 61340-5-1, ANSI/ESD S20.20).

Other important information:

- During cleaning, observe the instructions in section [“Cleaning the server” on page 60](#).
- Keep this operating manual and the other documentation (such as the technical manual, CD) close to the device. All documentation must be included if the equipment is passed on to a third party.

3.2 CE conformity

 The system complies with the requirements of the EC directives 89/336/EEC regarding “Electromagnetic Compatibility” and 73/23/EEC “Low Voltage Directive”. This is indicated by the CE marking (CE = Communauté Européenne).

3.3 FCC Class A Compliance Statement

If there is an FCC statement on the device, then:

The following statement applies to the products covered in this manual, unless otherwise specified herein. The statement for other products will appear in the accompanying documentation.

NOTE:

This equipment has been tested and found to comply with the limits for a “Class A” digital device, pursuant to Part 15 of the FCC rules and meets all requirements of the Canadian Interference-Causing Equipment Standard ICES-003 for digital apparatus. These limits are designed to provide reasonable protection against harmful interference in a residential installation. This equipment generates, uses and can radiate radio frequency energy and, if not installed and used in strict accordance with the instructions, may cause harmful interference to radio communications. However, there is no warranty that interference will not occur in a particular installation. If this equipment does cause harmful interference to radio or television reception, which can be determined by turning the equipment off and on, the user is encouraged to try to correct the interference by one or more of the following measures:

- Reorient or relocate the receiving antenna.
- Increase the separation between equipment and the receiver.
- Connect the equipment into an outlet on a circuit different from that to which the receiver is connected.
- Consult the dealer or an experienced radio/TV technician for help.

Fujitsu Siemens Computers is not responsible for any radio or television interference caused by unauthorized modifications of this equipment or the substitution or attachment of connecting cables and equipment other than those specified by Fujitsu Siemens Computers. The correction of interferences caused by such unauthorized modification, substitution or attachment will be the responsibility of the user.

The use of shielded I/O cables is required when connecting this equipment to any and all optional peripheral or host devices. Failure to do so may violate FCC and ICES rules.

WARNING:

This is a class A product. In a domestic environment this product may cause radio interference in which case the user may be required to take adequate measures.

3.4 Transporting the server



CAUTION!

Only transport the server in its original packaging or in packaging that protects it from impacts and jolts. Do not unpack the server until it is at its installation location.

If you need to lift or transport the server, ask other people to help you.

Never lift or carry the device by the handles on the front panel.

3.5 Notes on installing in the rack



CAUTION!

- **For safety reasons, at least two people are required to install the rack model because of its weight and size.**
- Never lift the server into the rack using the handles on the front panel.
- When connecting and disconnecting cables, observe the relevant instructions in the “Important Information” chapter of the technical manual for the corresponding rack. The technical manual is supplied with the corresponding rack.
- When installing the rack, make sure that the anti-tilt mechanism is correctly fitted.
- For safety reasons, no more than one unit may be removed from the rack at any one time during installation and maintenance work.
- If several units are simultaneously removed from the rack, there is a risk that the rack could tip over.
- The rack must be connected to the power supply by an authorized specialist (electrician).
- If the rack model is integrated into an installation that draws power from an industrial power supply network with an IEC309 type connector, the power supply's fuse protection must comply with the requirements for non-industrial power supply networks for the type A connector.

3.6 Environmental protection

Environmentally-friendly product design and development

This product has been designed in accordance with the Fujitsu Siemens Computers standard for “environmentally friendly product design and development”. This means that key factors such as durability, selection and labeling of materials, emissions, packaging, ease of dismantling and recycling have been taken into account.

This saves resources and thus reduces the harm done to the environment.

Energy-saving information

Devices that do not need to be constantly switched on should be switched off until they are needed as well as during long breaks and after completion of work.

Packaging information

Do not throw away the packaging. You may need it later for transporting the system. If possible, the equipment should only be transported in its original packaging.

Information on handling consumables

Please dispose of printer consumables and batteries in accordance with the applicable national regulations.

In accordance with EU directives, batteries must not be disposed of with unsorted domestic waste. They can be returned free of charge to the manufacturer, dealer or an authorized agent for recycling or disposal.

All batteries containing pollutants are marked with a symbol (a crossed-out garbage can). They are also marked with the chemical symbol for the heavy metal that causes them to be categorized as containing pollutants:

Cd Cadmium

Hg Mercury

Pb Lead

Labels on plastic casing parts

Please avoid sticking your own labels on plastic parts wherever possible, since this makes it difficult to recycle them.

Returns, recycling and disposal



The device must not be disposed of with domestic waste. This device is labeled in compliance with European directive 2002/96/EC on waste electrical and electronic equipment (WEEE). This directive sets the framework for returning and recycling used equipment and is valid across the EU. When returning your used device, please use the return and collection systems available to you. Further information can be found at www.fujitsu-siemens.com/recycling.

Details regarding the return and recycling of devices and consumables within Europe can also be found in the “Returning used devices” manual, via your local Fujitsu Siemens Computers branch or from our recycling center in Paderborn:

Fujitsu Siemens Computers
Recycling Center
D-33106 Paderborn

Tel. +49 5251 8 18010

Fax +49 5251 8 18015

4 Hardware installation



CAUTION!

- Follow the safety instructions in the chapter [“Important information” on page 21](#).
- Do not expose the server to extreme environmental conditions (see [“Ambient conditions” on page 18](#)). Protect the server from dust, humidity and heat.
- Make sure that the server is acclimatized for the time indicated in this table before putting it into operation.

Temperature difference (°C)	Minimum acclimatization time (hours)
5	3
10	5
15	7
20	8
25	9
30	10

Table 1: Acclimatization time

In [table “Acclimatization time”](#), the temperature difference refers to the difference between the operating environment temperature and the temperature to which the server was exposed previously (outside, transport or storage temperature).

4.1 Unpacking the server



CAUTION!

Follow the safety instructions in the [“Important information” on page 21](#) chapter.

The server must always be lifted or carried by at least two people.

Do not unpack the server until it is at its installation location.

- ▶ Transport the server to the place where you want to set it up.
- ▶ Unpack all individual parts.
Keep the original packaging in case you want to transport the server again.
- ▶ Check the delivery for any damage during transport.
- ▶ Check whether the items delivered match the details on the delivery note.

The product name and serial number of the product can be found on the identification rating plate.

- ▶ Notify your supplier immediately should you discover that the items delivered do not correspond to the delivery note.

4.2 Installing/removing the server in/from the rack



CAUTION!

- Follow the safety instructions in chapter “[Important information](#)” on page 21 and section “[Notes on installing in the rack](#)” on page 30.
- At least two people are needed to position the server into/out of the rack.
- The rack can tip over when more than one unit is removed.
- The server may not occupy the top height unit of the rack (38 HU/42 HU PRIMECENTER Rack and/or DataCenter Rack), as otherwise boards or fans cannot be replaced even with the plug-in module fully extended.

Rack requirements

The rack systems from Fujitsu Siemens Computers (PRIMECENTER Rack and DataCenter Rack) support installation of PRIMERGY servers. Installation in most current rack systems from other manufacturers (3rd party racks) is also supported.

To accommodate the ventilation concept and ensure proper ventilation, any unused areas in the rack must be sealed using dummy covers.

The power is supplied via the multiple socket outlets fitted in the rack.

The main features of the rack systems from Fujitsu Siemens Computers are as follows:

PRIMECENTER Rack

- Telescopic rails screwed to the front

The rails have a linear alignment feature to ensure that they can be adjusted to different rack depths.

- Enhanced cable management in the lateral rack area.

DataCenter Rack

- Telescopic rails screwed to the front (except in the rear left area, where a support bracket is used).
- Enhanced cable management in the lateral rack area.

The mounting of the rails in the different racks is described in the next sections.

Installation of the cable management is described in detail in the Technical Manual for the respective rack.

For rack systems from other manufacturers:

3rd party rack

Certain general conditions must be met:

- Installation dimensions (see the dimensions shown in [figure 2 on page 38](#)):
 - 1 Front of rack
 - 2 Rear of rack
 - A Rack depth (comparison PRIMECENTER Rack 940/1000 mm)
 - B Rack width (comparison PRIMECENTER Rack 700 mm)
 - C Clearance for 19" installation level
 - C1 Front 19" installation level
 - C2 Rear 19" installation level
 - D Cable routing area (cable area depth) and ventilation
 - E Space for front panel and ventilation
 - F Space for right and left support systems
 - P PRIMERGY rack installation depth
 - a1 Front left support upright
 - a2 Front right support upright
 - b1 Rear left support upright
 - b2 Rear right support upright
- You must ensure that the safety mechanisms on the server, e.g. stoppers or retaining systems, are functioning correctly.
- The shape of the rack support uprights must ensure that the rails can be bolted to the front.
- Telescopic rails screwed to the front

The rails have a linear alignment feature to ensure that they can be adjusted to different rack depths.

- No support of the cable management (delivered with the mounting kit).
- Climatic conditions.

An unobstructed air intake in the rack front and air discharge in the rear cover of the rack are essential for ventilation of the installed server.

In principle the ventilation concept plans that the necessary cooling is reached by the horizontal self-ventilation of the installed devices (air flow from the front to the rear).

- Power supply:
For installation in 3rd party racks, you must ensure that the appropriate socket strips are present.

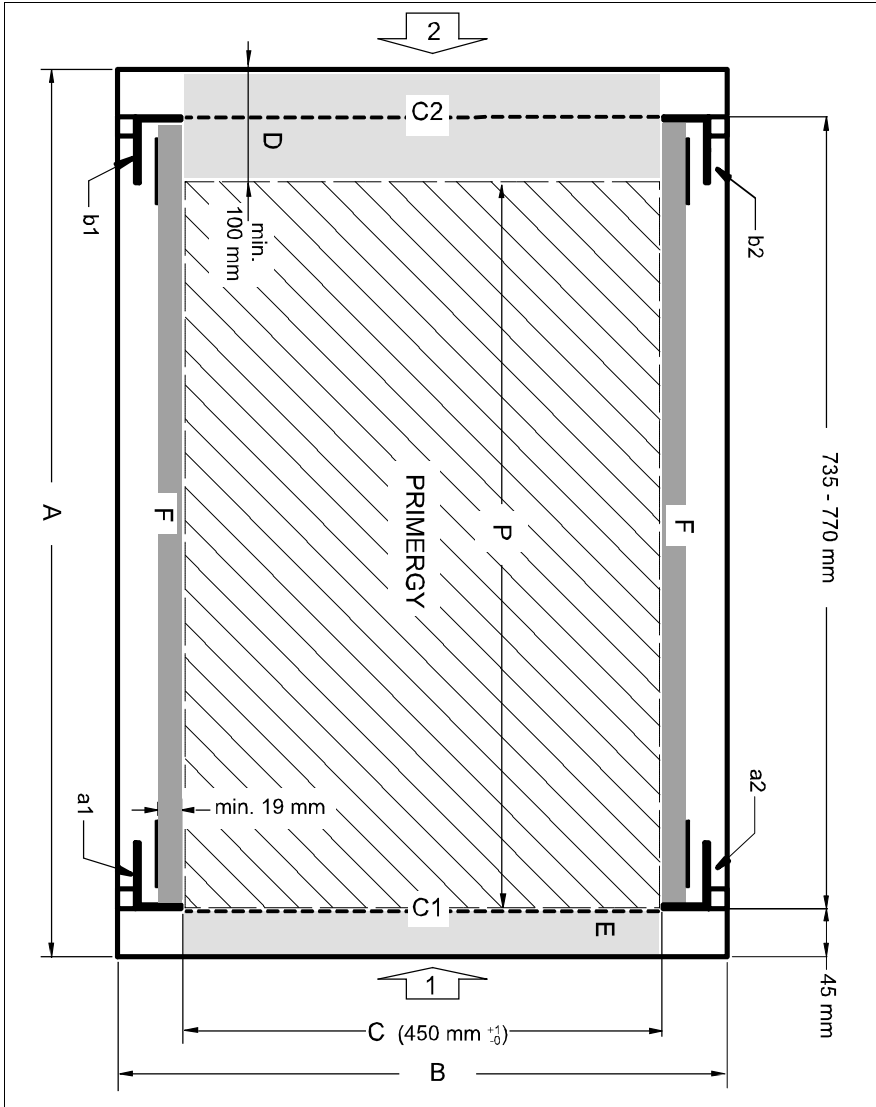



Figure 2: Mechanical requirements

4.2.1 Installation in PRIMECENTER/DataCenter Rack

For installation in a PRIMECENTER/DataCenter Rack, the following parts are required:

- Support bracket
 - One left and one right telescopic rail (assembled)
 - M5x10 screws with integrated plugwashers
-  – Or, M5x10 screws with separate plugwashers can also be used. In this case, two plugwashers each must be fitted beforehand on the support uprights and the support bracket.
- The descriptions and figures in this section refer to the current variable support.
 - General information is provided in the Technical Manual for the PRIMECENTER and/or DataCenter Rack (see [“Literature” on page 87](#)).

When mounting the left telescopic rail in the PRIMECENTER/DataCenter Rack, the supplied support bracket must first be mounted on the rear left support upright flush with the bottom edge of the device.

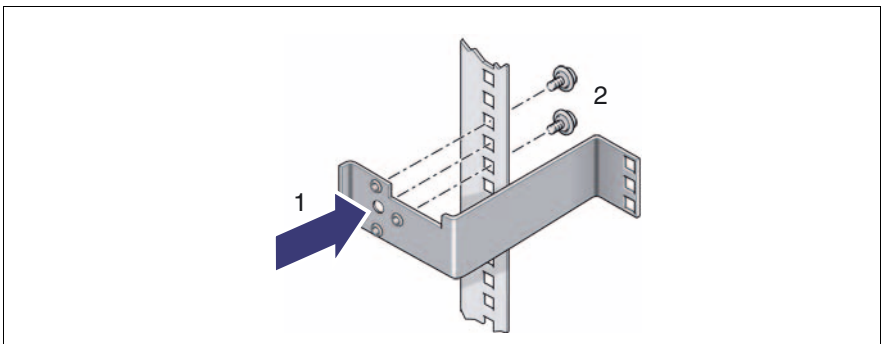

Figure 3: Fitting the support bracket

- ▶ Position the support bracket at the corresponding height on the rear left support upright, (insert lug in corresponding hole) (1).
- ▶ Secure the bracket with two screws incl. plug washers (2).

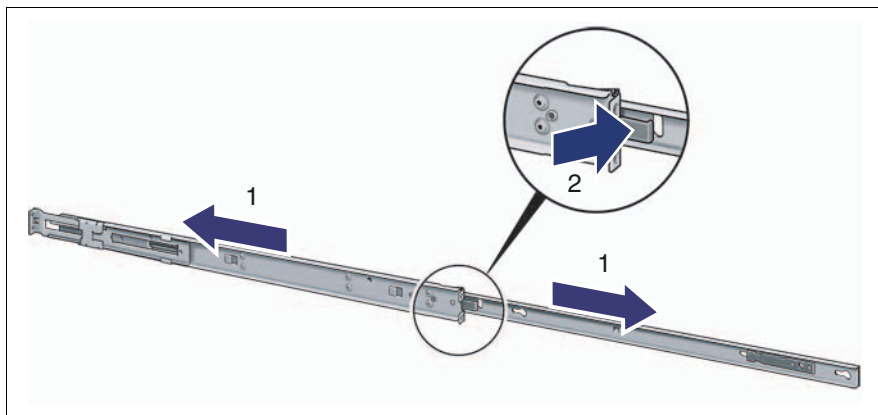

Figure 4: Remove the outer telescopic rail

- ▶ Extend the telescopic rail fully (1).
- ▶ Press the release spring (2) and remove the server rail.
- ▶ Repeat both steps with the second telescopic rail.



No nuts are required to secure the telescopic rails as the fixing holes on the rails are threaded.



Installing the telescopic rail with variable support

Figure 5: Fit the left telescopic rail in the PRIMECENTER/DataCenter Rack

- ▶ Position the left-hand rail (1) in the support bracket with the vertical lug (a) in the middle square catch.
- ▶ Press the left rail together until its front end passes behind the front left support upright (2), then release.
- ▶ Secure the rail on the front left support upright (3) and the support bracket in the rack (4) with two (M5) screws each.
- ▶ Repeat the steps with the right telescopic rail (to be secured to the right support uprights).
- ▶ Fit the PRIMECENTER/DataCenter Rack cable management as described in the technical manual for the rack.
- ▶ Insert the server (see the [“Inserting the server” on page 43](#) section).
- ▶ Route the cables once the server has been inserted, as described in the Technical Manual for the rack in question.

4.2.2 Installation in 3rd party racks

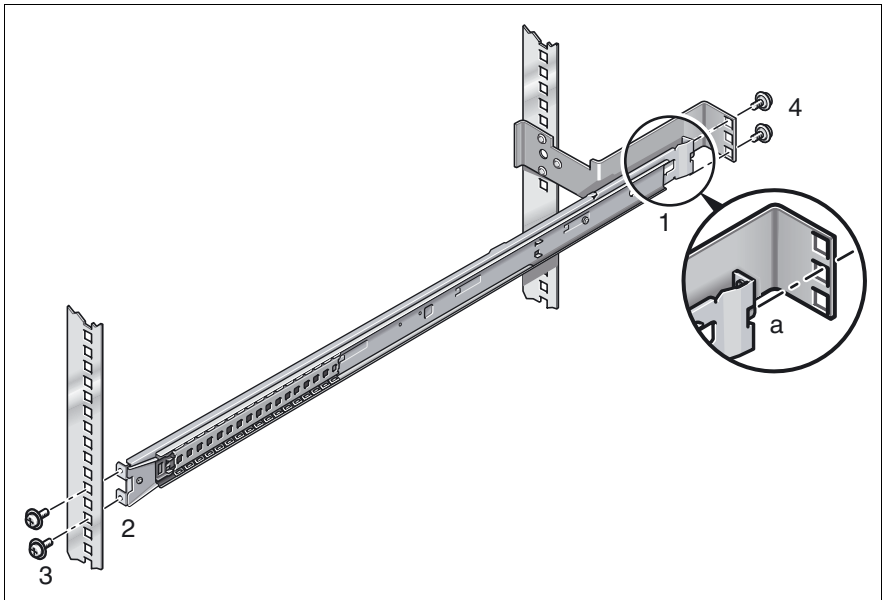
The following parts are required to install the server in 3rd party racks:

- One left and one right telescopic rail (assembled)
 - M5x10 screws with integrated plugwashers
 -  – Or, M5x10 screws with separate plugwashers can also be used. In this case, two plugwashers each must be fitted beforehand on the support uprights and the support bracket.
 - The descriptions and figures in this section refer to the current variable support.
- ▶ Refer to the manual from the rack manufacturer for details of the mechanical installation and the climatic conditions.



CAUTION!

For installation in 3rd party racks, it must be ensured that an air flow from the front to the back of the rack is guaranteed.

- ▶ Fit the required original parts (support bracket or cable management system).
-  Under certain circumstances, you will not be able to use some of the parts from the rack installation kit supplied - you will need to use original 3rd party rack parts instead.
- ▶ Remove the outer telescopic rail as described in [page 40 \(figure 4\)](#).

Racks with installation depth of 735 mm

The lengths of the telescopic rails do not need to be adjusted with respect to each other for the installation in rack systems with 735 mm installation depth.

- ▶ Secure the telescopic rails as described in section “[Installation in PRIME-CENTER/DataCenter Rack](#)” on [page 39](#).
- ▶ Mount the server (see section “[Inserting the server](#)” on [page 43](#)) and route the cables as described in the rack manual.

Racks with installation depth smaller/greater than 735 mm

The lengths of the telescopic rails have to be adjusted with respect to each other when installing in rack systems with an installation depth greater than/less than 735 mm. The length is adjusted with the spring element on the variable support

- ▶ Secure the telescopic rails as described in section “[Installation in PRIME-CENTER/DataCenter Rack](#)” on page 39.
- ▶ Mount the server (see section “[Inserting the server](#)” on page 43) and route the cables as described in the rack manual.

4.2.3 Inserting the server

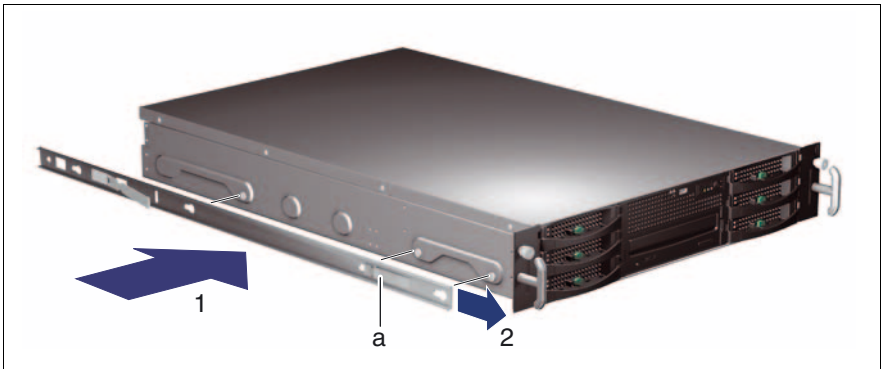

Figure 6: Preparing the server

- ▶ Place the server rails on the three screws on both sides of the server (1) and slide the server rails forwards to secure them (2).

The safety spring (a) must engage with an audible click.

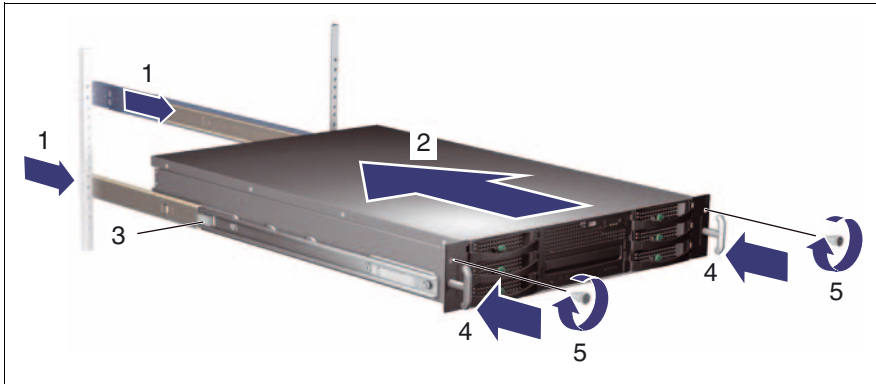

Figure 7: Inserting the server

**CAUTION!**

At least two people are needed to position the server in the rack.

- ▶ Fully extend the fitted telescopic rails (1). They must click into place so that they can no longer be moved.
- ▶ Push the prepared server into the rails that are attached to the rack until the server rails engage (2).



Ensure that the server is inserted horizontally and is not tilted.

- ▶ Press the safety springs in on both sides (3).
- ▶ Gently push the server as far as it will go into the rack (4).
- ▶ Fasten the server to the rack (5) using the two knurled screws (front panel).

To remove the server, follow this procedure in reverse.

4.3 Connecting devices to the server

The ports for external devices are on the rear of the server. The additional ports available on your server depend on the options and PCI boards installed.

The standard ports ([figure 8](#)) are marked with symbols, and some are color-coded:

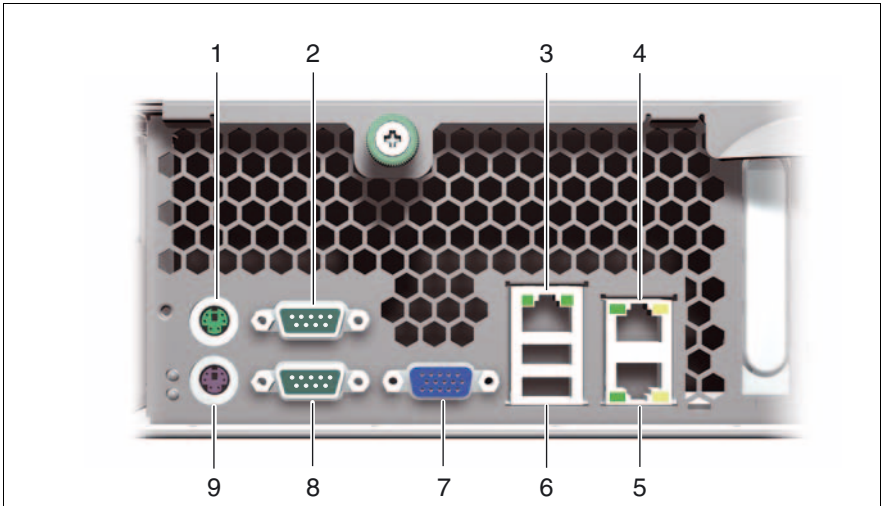

Figure 8: Ports on the rear

1	Mouse port (PS/2) (green)	6	2 x USB ports (black)
2	Serial port COM 2 (turquoise)	7	Monitor port (VGA) (blue)
3	Service LAN port	8	Serial port COM 1 (turquoise) (alternative service port)
4	LAN port 2	9	Keyboard port (PS/2) (purple)
5	LAN port 1		



Some of the devices that can be connected may require special drivers (see the documentation for the connected device).

- Connect the desired devices to the server.

You can find an additional USB port (1) on the front of the server ([figure 9](#)):

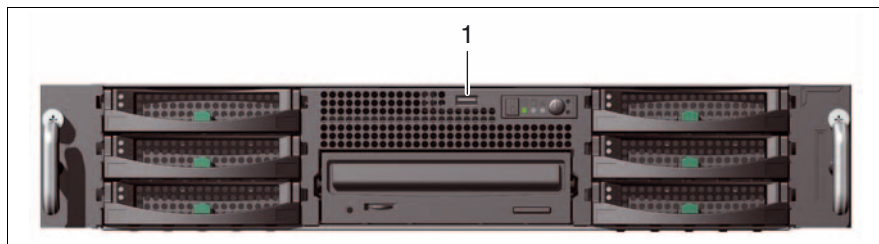

Figure 9: USB port on the front

Connecting the keyboard, mouse and monitor

- ▶ Connect the monitor, keyboard and mouse to the standard ports of the server (see table and [figure 8 on page 45](#)).

i If a separate graphics card is installed in a slot, the graphic controller on the system board is automatically deactivated. The corresponding monitor port (VGA) can not be used. Plug the data cable of the monitor into the monitor port of the graphics card.

- ▶ Connect the power cable of the monitor to the mains socket strip of the rack.

i The rated current for the monitor can be found on the technical data label on the monitor or in the operating manual for the monitor.

4.4 Connecting the server to the mains

In its basic configuration level the server has a hot-plug power supply unit. A second hot plug power supply unit can be added to achieve redundant power supply. If a defect occurs in one power supply unit, the other power supply unit ensures continued operation of the server.



CAUTION!

The installed power supply units automatically set themselves to a mains voltage in the range of 100 V - 127 V or 200 V - 240 V. Make sure that your local mains voltage is within the correct range.



Figure 10: Connecting the server to the mains

- ▶ Connect the power cable with the insulated connector (1) to the power supply unit of the server, and plug the power plug (2) into a grounded outlet on the mains socket strip on the rack (see the technical manual for the rack).



A phase redundancy in the power supply of the server can be set up if two hot plug power supply units are installed.

In this case, the two power supply units are connected to two different phases.

4.5 Notes on connecting/disconnecting cables



CAUTION!

Always read the documentation supplied with the device you wish to connect.

Never connect, or disconnect cables during a thunderstorm.

Never pull on a cable when disconnecting it. Always take hold of the cable by the plug.

Follow the sequence described below to connect or disconnect external devices to or from the server:

Connecting cables

- ▶ Turn off all power and equipment switches.
- ▶ Disconnect all power plugs from the grounded shockproof sockets.
- ▶ Connect all cables to the server and peripherals.
- ▶ Plug all data communication cables into the utility sockets.
- ▶ Plug all power cables into the grounded shockproof sockets.

Disconnecting cables

- ▶ Turn off all power and equipment switches.
- ▶ Disconnect all power plugs from the grounded shockproof sockets.
- ▶ Unplug all data communication cables from the utility sockets.
- ▶ Disconnect the relevant cables from the server and all the peripherals.

5 Starting up and operation



CAUTION!

Follow the safety instructions in the chapter [“Important information” on page 21](#).

5.1 Controls and displays

5.1.1 Front of server

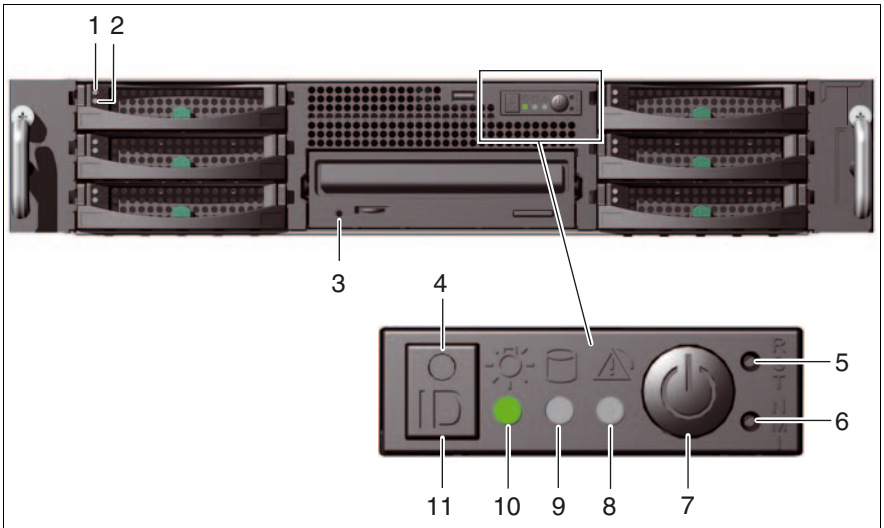

Figure 11: Controls and indicators on the front

1	HDD BUSY indicator	7	On/Off button
2	HDD FAULT indicator	8	Global error indicator
3	CD/DVD indicator	9	Drive access indicator
4	ID indicator	10	Power-on indicator
5	Reset button	11	ID button
6	NMI button		

Controls

On/Off button



When the system is switched off, it can be switched on again by pressing the On/Off button. When the system is operating, pressing the On/Off button will switch off the system.



The On/Off button does not disconnect the server from the mains. To disconnect from the mains completely, remove the power plug(s).

NMI NMI button



Do not press! The NMI button may only be used by service personnel.

RST Reset button

Pressing the reset button reboots the system.

ID ID button

Lights up (blue) on the front and on the rear of the server when the ID button is pressed. The two ID indicators are synchronized.

Indicators on the control panel

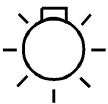

Power-on indicator (three colors)

Lights red when the server is switched off but line voltage is present.

Lights yellow during power up delay.



If the server is switched off and then immediately switched on again, a server is only restarted after a power up delay. This prevents a current overload, for example.

You can set the power up delay (in seconds) in the *BIOS setup* in the *Server Menu* menu with *Power Cycle Delay*.

Lights up green when the server is switched ON.

Flashes green when the server has been switched on and is in standby mode.



Drive access indicator (green)

Flashes green when an internal hard disk drive is being accessed.



Global Error indicator (red)

Does not light up when the system is OK. No service incident or critical event has occurred.

Lights up red when a predictable error has been detected. Users can check the system and event log or via *ServerView* for more detailed information.

Flashes red when a critical event has occurred. Users can check for event details in the BIOS Setup, the system and event log or via *ServerView*.

If the event is still acute after a power failure, the indicator is activated after the restart.

ID ID indicator (blue)

Lights up blue when the system has been selected by pressing the ID button. To deactivate, press the button again.

The ID indicator can also be activated via *ServerView* and its status reported to *ServerView*.

Indicators on the drives

CD/DVD indicator

Lights up green when the storage medium is being accessed.

Indicators on the HDD module

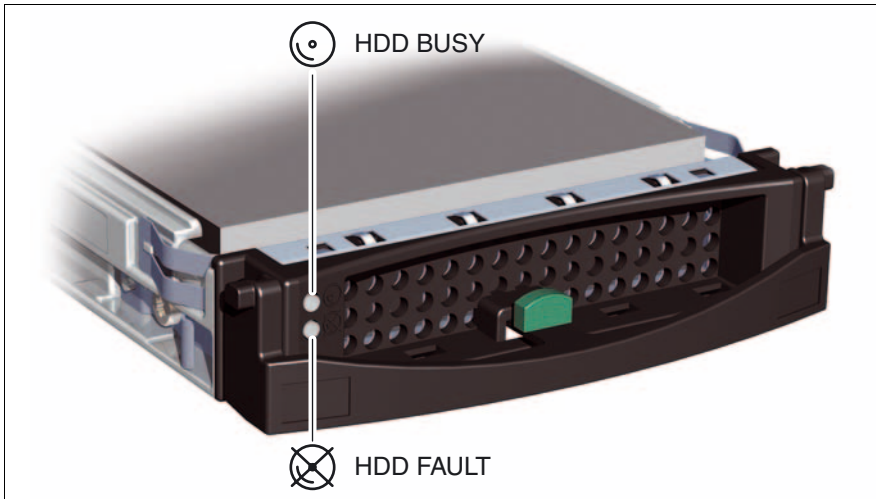

Figure 12: Indicators on the HDD module

<p>LED green</p>	<p>HDD BUSY</p> <ul style="list-style-type: none"> - lights: HDD in active phase - does not light: HDD inactive (drive inactive)
<p>LED red</p>	<p>HDD FAULT (in conjunction with a RAID controller)</p> <ul style="list-style-type: none"> - does not light: no HDD error - Lit: HDD Faulty or Rebuild Stopped (drive defective/needs replacing, a rebuild process was stopped or the HDD module is not correctly inserted) - Slow flashing: HDD Rebuild (the data is being restored after changing a hard disk drive) - Fast flashing: HDD Identify - four fast blinks/pause: HDD Predicted Fault - Two fast flashes/pause: HDD Hot Spare (Hot spare drive active. The corresponding drive has failed).

5.1.2 Rear of server

Indicators on connection panel (global error indicator and ID indicator)



Figure 13: Global error indicator and ID indicator

1	<p>ID indicator (blue)</p> <p>Lights blue when the system has been selected by pressing the ID button on the front. To deactivate, press the button again.</p> <p>The ID indicator on the front also lights up at the same time. The two ID indicators are synchronized.</p> <p>The ID indicator can also be activated via <i>ServerView</i> and its status reported to <i>ServerView</i>.</p>
2	<p>Global Error indicator (red)</p> <p>Does not light up when the system is OK. No service incident or critical event has occurred.</p> <p>Lights up red when a predictable error has been detected. Users can check the system and event log or via <i>ServerView</i> for more detailed information.</p> <p>Flashes red when a critical event has occurred. Users can check BIOS Setup, system- and eventlog or via <i>ServerView</i> for event details.</p> <p>If the event is still acute after a power failure, the indicator is activated after the restart.</p>

Indicators on the connection panel (LAN indicators)

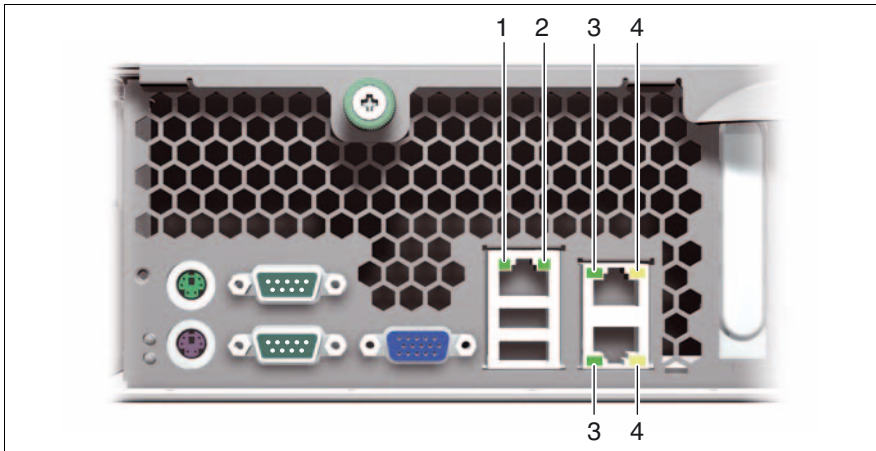

Figure 14: LAN indicators

1	<p>LAN link/active indicator (service LAN)</p> <p>Lights up green if a LAN connection exists. Does not light up if no LAN connection exists. Flashes green when a LAN transfer is in progress.</p>
2	<p>LAN transfer rate indicator (service LAN)</p> <p>Lights up green for a LAN transfer rate of 100 Mbps. Does not light up for a LAN transfer rate of 10 Mbps.</p>
3	<p>LAN link/Active indicator (standard LAN)</p> <p>Lights up green if a LAN connection exists. Does not light up if no LAN connection exists. Flashes green when a LAN transfer is in progress.</p>
4	<p>LAN transfer rate indicator (standard LAN)</p> <p>Lights yellow for a LAN transfer rate of 1 Gbps. Lights up green for a LAN transfer rate of 100 Mbps. Does not light up for a LAN transfer rate of 10 Mbps.</p>

Hot-plug PSU indicators



Figure 15: Hot-plug PSU indicators

LED	Status	Meaning	
1	AC	On	Mains voltage on
	AC	Off	Mains voltage off
2	DC	On	PSU in operation
	DC	Off	PSU in standby mode or failed

5.2 Switching the server on and off



CAUTION!

If nothing appears on the screen but flickering stripes after switching on the server, switch the server off immediately (see section [“Flickering stripes on monitor screen”](#) on page 65).

The On/Off button does not disconnect the server from the mains. To disconnect from the mains completely, remove the power plug(s).

Switching the server on

The power-on indicator (item 10 in [figure 11 on page 49](#)) lights red.

– Starting up for the first time:

- ▶ Press the On/Off button (position 7 in [figure 11 on page 49](#)).

The power-on indicator lights up green (item 10 in [figure 11 on page 49](#)).

- ▶ Insert *ServerStart* disc 1 in the CD/DVD drive.
- ▶ Follow the on-screen instructions (see also [section “Configuration with ServerStart”](#) on page 59 or [section “Configuration without ServerStart”](#) on page 60).

– System already installed:

- ▶ Press the On/Off button (position 7 in [figure 11 on page 49](#)).

The power-on indicator lights up green (item 10 in [figure 11 on page 49](#)).

The server is switched on, performs a system test and boots the operating system.

Switching the server OFF

Power-on indicator (position 10 in [figure 11 on page 49](#)) lights green.

- ▶ Shut down the operating system properly.

The server is automatically switched off. The Power-on indicator lights red.



If the operating system does not switch the server off automatically, press the On/Off button for at least four seconds and/or send a corresponding control signal.

Other on/off options

In addition to the On/Off button, the server can be switched ON and OFF in the following ways:

- **Specified switch on time / switch off time**

The server is switched ON or OFF at a time specified in the *ServerView* program

- **Ring indicator**

The server is switched on by an internal or external modem.

- **Wake On LAN (WOL)**

The server is switched on by a command via the LAN (Magic Packet).

- **After power failure**

The server automatically reboots following a power failure (depending of the settings in the BIOS).

- **“Power override” function**

The server can be switched off immediately by pressing and holding the On/Off button (approx. 4-5 sec.).



CAUTION!

There is a risk that data may be lost.

– IPMI

The server is switched on by an IPMI console via serial port COM1 (item 8 in [figure 8 on page 45](#)) or via LAN port M (item 3 in [figure 8 on page 45](#)).

5.3 Configuring the server

This section contains information about configuring the server and installing the operating system.



Make sure that the energy saving functions are disabled in the *BIOS Setup* during server operation.

5.3.1 Configuring onboard SAS controller

The server has an onboard SAS controller with “Integrated Mirroring Enhanced” functionality. You can configure the Onboard-SAS-Controller either before or during *ServerStart*. Using *ServerStart* is recommended.



A separate utility is available to the controller for IME configuration. Further information can be found in the "Integrated RAID for SAS User's Guide" (on the *ServerBooks* DVD under "Controllers").



Descriptions of operating systems not covered in the RAID controller manual are provided in the appropriate readme files on the driver CDs.

5.3.2 Configuration with ServerStart

With the *ServerStart* Disc 1 provided, you can configure the server and install the operating system in a convenient manner. Menu-guided configuration includes server configuration with the *SCU* and RAID controller configuration with *ServerViewRAID*.

The ServerStart advantages

- Automatic configuration of your server's hardware and disk arrays.
- Installation assistance for all leading server operating systems.
- Creation of configuration files for unattended installation of several PRIMERGY servers with identical hardware configurations.
- Installation of drivers and additional software.



The software that can be installed depends on your server's hardware configuration. This configuration is detected automatically.



Descriptions of operating systems not covered in the RAID controller manual are provided in the appropriate readme files on the driver CDs.

To find out how to operate *ServerStart* and for further information, refer to the corresponding manual (see [“Literature” on page 87](#)).

If you are using *ServerStart*, you can skip the following section on how to configure the server and install the operating system. Continue from the [“Cleaning the server” on page 60](#) section.

5.3.3 Configuration without ServerStart

Configuring onboard SAS controller

Configure the controller as described in section [“Configuring onboard SAS controller” on page 58](#).

Operating system installation

- ▶ Insert the CD for the operating system you want to install.
- ▶ Reboot the server.
- ▶ Follow the instructions on screen and in the manual for the operating system.

If your server is equipped with a RAID controller, please read how to install the desired operating system in the related manual.

5.4 Cleaning the server



CAUTION!

Switch the server off and disconnect the power plugs from the grounded shockproof sockets.

Do not clean any interior parts yourself; leave this job to a service technician.

Do not use any cleaning agents that contain abrasives or may corrode plastic.

Ensure that no liquid enters the system. Ensure that the ventilation areas of the server and the monitor are clear.

Clean the keyboard and the mouse with a disinfecting cloth.

Wipe the server and monitor casing with a dry cloth. If particularly dirty, use a cloth that has been moistened in a mild domestic detergent and then carefully wrung out.

6 Property and data protection

The lockable rack door protects the server against unauthorized access.

To protect your system and data internally against unauthorized access, you can use the *BIOS Setup* security functions.

6.1 BIOS Setup security functions

The *Security* menu in the *BIOS Setup* provides you with various options for protecting your data from unauthorized access. By combining these options, you can also achieve optimum protection for your system.



You will find a detailed description of the *Security* menu and how to assign passwords in the manual for the *BIOS Setup* and on the *ServerBooks* DVD (see [“Literature” on page 87](#)).

Preventing unauthorized BIOS Setup calls

You can activate this protection by entering a setup password in the *Security* menu. You can also suppress the `Press F2 for Setup` message in this menu. This message is then no longer displayed while the server's startup routine is in progress.

Preventing unauthorized system access

You can activate this protection by entering a system password in the *Security* menu.

Preventing unauthorized access to the boards with their own BIOS

You can activate this protection by selecting the *Extended* item for *Setup Password Lock* field in the *Security* menu.

Preventing the system from booting from the floppy disk drive

You can activate this protection by selecting the item *Diskette Lock* for the *System Load* field in the *Security* menu.

Preventing unauthorized writings of floppy disks

To activate this protection, select the value *Disabled* for the *Diskette Write* field in the *Security* menu.

Protecting BIOS from being overwritten

To activate this protection, select the value *Disabled* for the *Flash Write* field in the *Security* menu.

Protecting the server from being switched on by an external device

To activate this protection, select the value *Disabled* for the *Remote Power On* field in the *Security* menu.

Protecting the server from being switched off by a program

To activate this protection select the value *Disabled* for the *Soft Power Off* field in the *Security* menu.

7 Troubleshooting and tips



CAUTION!

Follow the safety instructions in the “Safety notes and other important information” manual and in the [“Important information” on page 21](#) chapter.

If a fault occurs, attempt to resolve it using the measures described:

- in this chapter,
- in the documentation for the connected devices,
- in the help systems of the software used.

If you fail to correct the problem, proceed as follows:

- ▶ Make a list of the steps performed and the circumstances that led to the fault. Also make a list of any error messages that were displayed.
- ▶ Switch off the server.
- ▶ Contact our customer service team.

7.1 Power-on indicator remains unlit

The power-on indicator remains dark after you switch on your device.

Power cable incorrectly connected

- ▶ Make sure that the power cable(s) is/are correctly connected to the server and the grounded socket(s).

Power supply overloaded

- ▶ Disconnect the server power plug(s) from the power socket(s).
- ▶ Wait a few seconds before you plug it/them into the grounded socket(s) again.
- ▶ Switch on your server.

7.2 Server switches itself off

Server Management has detected an error

- ▶ Check the error list or the ErrorLog file in the *ServerView* program, and attempt to eliminate the error.

7.3 Screen remains blank

Monitor is switched off

- ▶ Switch on your monitor.

Screen has gone blank

- ▶ Press any key on the keyboard.
or
- ▶ Deactivate screen saver. Enter the appropriate password.

Brightness control is set to dark

- ▶ Set the brightness control on the monitor to light. For detailed information, refer to the operating manual supplied with your monitor.

Power cable or monitor cable not connected

- ▶ Switch off the monitor and the server.
- ▶ Check whether the power cable is properly connected to the monitor and to the grounded socket.
- ▶ Check whether the monitor cable is properly connected to the server and monitor (if it is plugged in with a connector). If a separate graphics card is installed in the server, then the monitor cable must be connected to the graphics card.
- ▶ Switch on the monitor and the server.

7.4 Flickering stripes on monitor screen



CAUTION!

Switch off the server immediately. Risk of damaging the server.

Monitor does not support the set horizontal frequency

- ▶ Find out which horizontal frequency your monitor screen supports. You will find the horizontal frequency (also known as line frequency or horizontal deflection frequency) in the documentation for your monitor.
- ▶ Refer to the documentation for your operating system or the software for the screen controller for details of how to set the correct horizontal frequency for your monitor, and follow the procedure accordingly.

7.5 No screen display or display drifts

The wrong horizontal frequency or resolution has been selected for the monitor or for the application program.

- ▶ Find out which horizontal frequency your monitor screen supports. You will find the horizontal frequency (also known as line frequency or horizontal deflection frequency) in the documentation for your monitor.
- ▶ Refer to the documentation for your operating system or the software for the screen controller for details of how to set the correct horizontal frequency for your monitor, and follow the procedure accordingly.

7.6 No mouse pointer displayed on screen

Mouse driver not loaded

- ▶ Check whether the mouse driver is properly installed and is activated when the application program is started. Detailed information can be found in the user manuals for the mouse, the operating system and the application program.

Mouse controller disabled

The mouse controller on the system board must be enabled if you are using the mouse supplied.

- ▶ Check in the *BIOS Setup* that the mouse controller is *Enabled*.

7.7 Incorrect date and time

- ▶ Set the date and time in the operating system or in the *BIOS Setup* under the *Main* menu, using *System Date* and *System Time* respectively.



Note that the operating system may affect the system time. For example, the operating system time may deviate from the system time under Linux, and would overwrite the system time in the default setting on shutdown.

If the date and time are still wrong after the server has been switched off and back on again, replace the lithium battery (for a description refer to the Technical Manual for the D2440 system board) or contact our customer service team.

7.8 System will not boot

The system will not boot after installing a new hard disk drive.

SAS configuration incorrect

- ▶ Check the settings for the hard disk drives (*SAS Device Configuration*) and the additional settings in the SAS configuration menu.

7.9 Drives reported as “dead” when starting system

This error message can occur when the onboard SAS controller has RAID functionality or the server is equipped with a PCI RAID controller.

RAID controller configuration incorrect

- ▶ Check and correct the settings for the drives using the RAID controller utility.

Further information is provided in the manual for the RAID controller.

7.10 Added drive reported as defective

RAID controller is not configured for this drive

The drive was probably installed when the system was switched off.

- ▶ Reconfigure the RAID controller for the drive using the corresponding utility. Information is provided in the documentation for the RAID controller.

or

- ▶ Remove and reinstall the drive while the system is switched ON.

If the drive continues to be reported as defective, then replace it (see [“Installing/removing the HDD module” on page 77](#) and [“Removing the HDD module” on page 79](#)).

7.11 Error message on screen

The meaning of the error message is explained in the manual for the *BIOS-Setup* and in the documentation for the relevant components and programs on the PRIMERGY *ServerBooks* DVD.

8 Hot-plug components

This chapter describes how to handle the hot-plug components and how to modify your server hardware (e.g. installing/removing hot-plug power supply units or hot-plug HDD modules) .



Upgrades, updates and replacement of non-hot-pluggable components are described in the “Options Guide” or in the service supplement and may only be performed by authorized specialist personnel.

The hot-plug procedure increases the availability of system operation and guarantees a high degree of data integrity and failsafe performance.



CAUTION!

Follow the safety instructions in the chapter [“Important information” on page 21](#).

8.1 Hot-plug power supply units



A redundant power supply can be created by installing a second hot-pluggable power supply unit (optional). If one power supply unit fails, the other unit ensures operation can continue. The defective power supply unit can be replaced online.

8.1.1 Remove the dummy module

The mounting location for the second hot-plug power supply unit contains a dummy module. This dummy module must be removed before installing a second power supply unit.

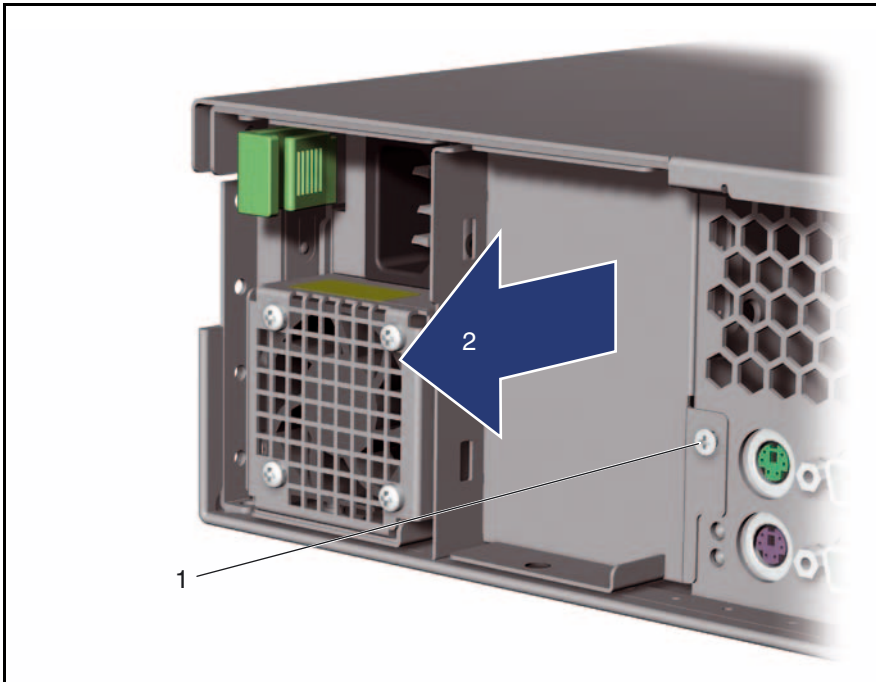

Figure 16: Remove the dummy module

- ▶ Loosen the fixing screw (1) and remove the dummy module from the second power supply mounting location (2).



CAUTION!

Store the dummy module in a safe place. If the power supply unit is removed and not replaced with a new unit, the dummy module must be reinstalled due to cooling, to comply with applicable EMC regulations (regulations on electromagnetic compatibility) and to protect against fire.

8.1.2 Installing/removing the hot-plug power supply unit

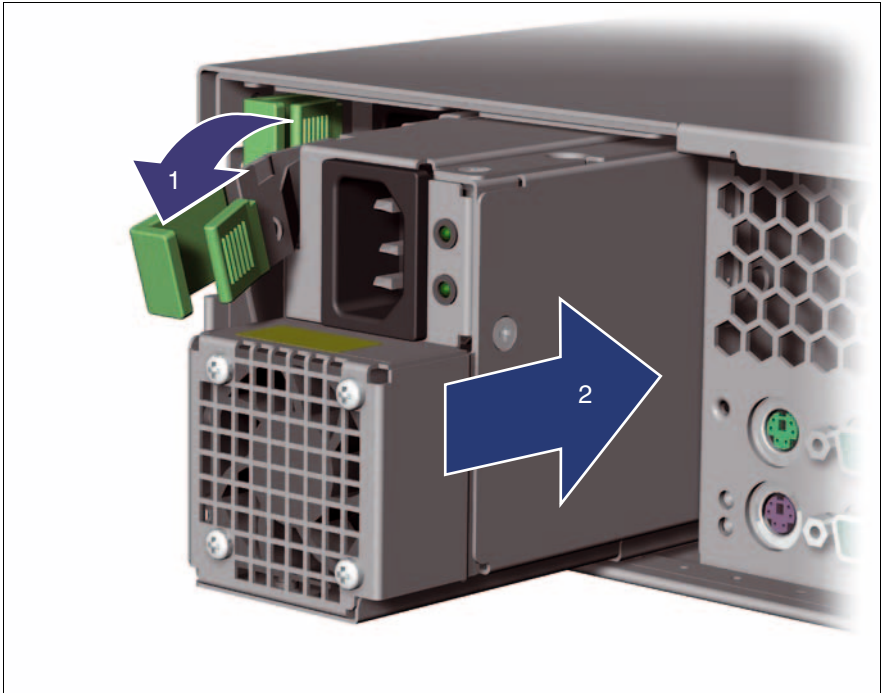

Figure 17: Unlocking and installing the power supply unit

- ▶ Fold down the locking lever (1) and slide the power supply unit into the mounting location (2) as far as it will go.
The locking lever will turn upwards and engage.
- ▶ Check that the locking lever is properly locked in place.
If necessary, push the lever up.
- ▶ Connect the power supply unit to the mains (see section [“Connecting the server to the mains”](#) on page 47).

To remove the server, follow this procedure in reverse.

8.1.3 Replacing the hot-plug power supply unit



CAUTION!

Before replacing a non-defective power supply unit in a non-redundant configuration (only one power supply unit present), the server **must** have been switched off.

- ▶ Remove the cable of the defective power supply unit.
- ▶ Remove the defective power supply unit (see section [“Installing/removing the hot-plug power supply unit” on page 71](#)).
- ▶ Install the new power supply unit in the empty mounting location (see section [“Installing/removing the hot-plug power supply unit” on page 71](#)).



Make sure that the power supply unit engages correctly in the mounting location and is locked in position.

This is the only way to avoid the power supply unit being shaken out of its mountings and damaged during transportation.

- ▶ Connect the newly installed power supply unit.

8.2 Hot plug hard disk drives

Up to six hot-plug hard disk drives can be installed in the PRIMERGY RX330 S1 Server.

The hard disk drives which can be ordered for the PRIMERGY RX330 S1 are supplied already mounted in an installation frame so that defective hard disk drives can be replaced and new drives can be added during operation. The HDD drive and installation frame together make up the HDD module.



CAUTION!

- The HDD must not be removed from the installation frame by anyone except a service technician.
- The HDD modules (drives) must all be marked clearly so that they can be put back in their original places after an upgrade. If this is not done, existing data can be lost.
- The hot-plug function is only possible in conjunction with a corresponding RAID configuration.

Further information about RAID configuration or the RAID level can be found in the RAID controller documentation (see [“Literature” on page 87](#)).



CAUTION!

Hybrid operation using both SAS and SATA2 hard disk drives is not supported.

HDD module and dummy module

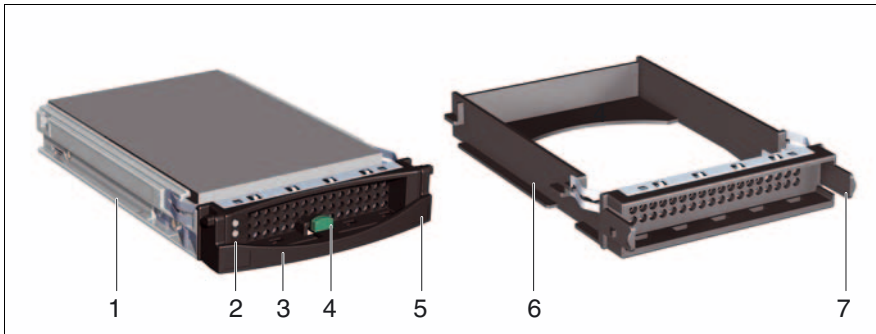

1	HDD module (installation frame with hard disk drive installed)
2	Indicators HDD Busy (LED green) HDD Fault (LED orange) For description see section “Indicators on the HDD module” on page 52.
3	Handle for locking and unlocking the HDD module
4	Button for locking and unlocking the handle
5	Ridge for the application of a sticker with the current drive name
6	Dummy module
7	Tabs for unlocking the dummy module

8.2.1 Handling hard disk drives and HDD modules

Hard disk drives incorporated in the HDD modules are highly sensitive electro-magnetic devices and must be handled with great care. Incorrect handling can cause partial or total failure of the hard disk drives. These failures can result in data errors and to a loss of data or to total corruption of the hard disk drive.

Observe the following rules to prevent such problems occurring:

- Only store and transport HDD modules within the limits stipulated in the specification.
- When transporting HDD modules (even over short distances), always use the original packaging (ESD label).
- Never expose HDD modules to a temperature shock. Avoid the formation of condensation inside and on the outside of the hard disk drive.



CAUTION!

The HDD module must be acclimatized in its operating environment for an acclimatization time before it is started up for the first time.

Temperature difference (°C) (operating environment/outside)	Minimum acclimatization time (hours)
5	3
10	5
15	7
20	8
25	9
30	10

Table 2: Acclimatization times for HDD modules

- Always set the HDD module down carefully, with the large surface facing downwards to prevent it from tipping over.

8.2.2 Removing/Installing the dummy module

Free slots are provided with dummy modules. Remove the dummy module before installing an additional HDD module.

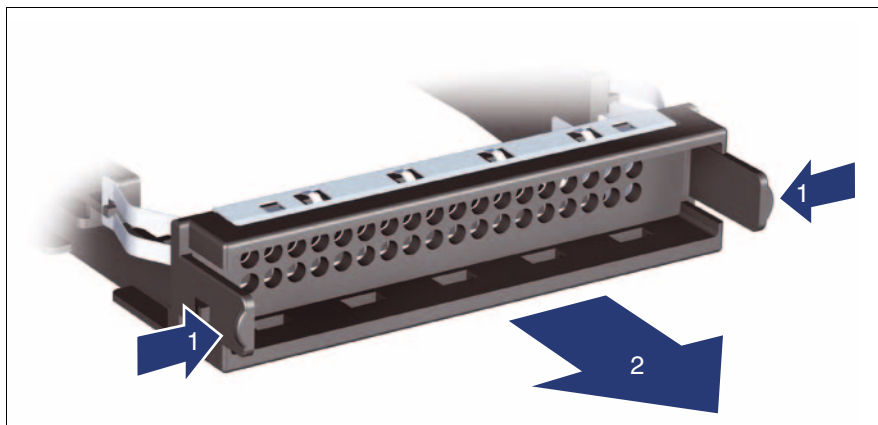

Figure 18: Removing the dummy module

- ▶ Press both tabs on the dummy module together until the locking mechanism disengages (1).
- ▶ Pull the dummy module out of the slot (2).

To install a dummy module, follow the same procedure in reverse order.



CAUTION!

Store the dummy module in a safe place. If you have removed an HDD module and do not install a new one in its place, put the dummy module back in its place for cooling, to comply with EMC regulations (regulations regarding electromagnetic compatibility), and for protection against fire. Ensure that the dummy module engages correctly in the slot.

8.2.3 Installing/removing the HDD module

Unlocking the HDD module

- i** If HDD modules are provided with a transport lock, remove the lock before releasing the locking mechanism.



Figure 19: Removing the transport lock

- ▶ Pull the transport lock out in the direction of the arrow.



Figure 20: Unlocking the HDD module

- ▶ Open the locking mechanism by pressing the locking button (1).
- ▶ Push the handle of the HDD module fully in the direction of the arrow (2).
The HDD module is now unlocked.

Installing the HDD module



Figure 21: Installing the HDD module

- ▶ Unlock the HDD module as described in section [“Unlocking the HDD module” on page 77](#).
- ▶ Carefully push the HDD module into the empty mounting location (1) until it stops.
- ▶ Push the handle completely in the direction of the arrow (2) until the locking mechanism engages.

Removing the HDD module



CAUTION!

- Only remove a HDD module during operation if the drive is not currently being accessed. Observe the control LEDs for the corresponding HDD modules (see [“Indicators on the HDD module” on page 52](#)).
- Under no circumstances should you remove an HDD module while the system is in operation if you are not sure whether the hard disk drive is operated by a RAID controller and belongs to a disk array which is operating at RAID level 1 or 5.

An HDD module can only be replaced during operation in conjunction with a corresponding RAID configuration.

- All HDD modules (drives) must be uniquely identified so that they can be reinstalled in their original mounting locations later. If this is not done, existing data can be lost.

If you want to remove an HDD module during operation, proceed as follows:

- ▶ If you want to remove a HDD module that is not defective, the drive must be first set to offline via the software (RAID controller configuration software).
- ▶ Unlock the HDD module as described in section [“Unlocking the HDD module” on page 77](#).
- ▶ Pull the HDD module out a few centimeters.
- ▶ Wait for at least 60 seconds.



This period is necessary for the RAID controller to recognize that an HDD module has been removed and for the hard disk drive to come to a stop.

- ▶ Pull the HDD module out completely.

- ▶ Install the new HDD module, as described in [“Unlocking the HDD module” on page 77](#) and [“Installing the HDD module” on page 78](#).

**CAUTION!**

If you have removed an HDD module and do not install a new one in its place, put the dummy module back in its place for cooling, to comply with EMC regulations (regulations regarding electromagnetic compatibility), and for protection against fire. Ensure that the dummy module engages correctly in the slot.

Abbreviations

AC

Alternating Current

ANSI

American National Standard Institut

ASR&R

Automatic Server Reconfiguration and Restart

ATA

Advanced Technology Attachments

BIOS

Basic Input-Output System

BMC

Baseboard Management Controller

CC

Cache Coherency

CD

Compact Disk

CD-ROM

Compact Disk-Read Only Memory

CHS

Cylinder Head Sector

CMOS

Complementary Metal Oxide Semiconductor

COM

Communication

CPU

Central Processing Unit

Abbreviations

DC	Direct Current
DIMM	Dual Inline Memory Module
DIP	Dual Inline Package
DMA	Direct Memory Access
DMI	Desktop Management Interface
ECC	Error Checking and Correcting
ECP	Extended Capabilities Port
EEPROM	Electrically Erasable Programmable Read-Only Memory
EGB	Elektrostatisch Gefährdete Bauteile (component are in danger of electrostatic)
EMP	Emergency Management Port
EPP	Enhanced Parallel Port
EMV	Elektromagnetische Verträglichkeit (electromagnetic compatibility)
ESD	ElectroStatic Discharge (elektrostatische Entladung)
FPC	Front Panel Controller

FRU	Field Replaceable Unit
FSB	Front Side Bus
GUI	Graphical User Interface
HDD	Hard Disk Drive
HSC	Hot-Swap Controller
I²C	Inter-Integrated Circuit
I/O	Input/Output
ICM	Intelligent Chassis Management
ID	Identification
IDE	Intergrated Drive Electronics
IME	Intergrated Mirroring Enhanced
iRMC	integrated Remote Management Controller
IRQ	Interrupt Request Line
LAN	Local Area Network

Abbreviations

LBA	Logical Block Address
LCD	Liquid Crystal Display
LUN	Logical Unit Number
LVD	Low-Voltage Differential
LWL	LichtWellenLeiter (fiber optic cable)
MMF	Multi Mode Faser
MRL	Manually Retention Latch
NMI	Non Maskable Interrupt
NVRAM	Non Volatile Random Access Memory
OS	Operating System
PCI	Peripheral Component Interconnect
PDA	Prefailure Detection and Analysing
POST	Power ON Self Test
RAID	Redundant Arrays of Independent Disks

RAM	Random Access Memory
ROM	Read-Only Memory
RSB	Remote Service Board
RTC	Real Time Clock
RTDS	Remote Test- und Diagnose-System
SAF-TE	SCSI Accessed Fault-Tolerance Enclosures
SAS	Serial Attached SCSI
SATA	Serial ATA
SBE	Single Bit Error
SCA	Single Connector Attachment
SCSI	Small Computer System Interface
SDDC	Single Device Data Correction
SDR	Sensor Data Record
SDRAM	Synchronous Dynamic Random Access Memory

Abbreviations

SEL

System Event Log

SMI

System Management Interrupt

SSU

System Setup Utility

SVGA

Super Video Graphics Adapter

USB

Universal Serial Bus

VGA

Video Graphics Adapter

Literature

PRIMERGY server manuals are also available as PDF files on the *ServerBooks* DVD. The *ServerBooks* DVD is part of the *PRIMERGY ServerView Suite*, which is supplied with every server.

The current versions of the required manuals may be downloaded for free from the Internet as PDF files. The overview page showing the online documentation available on the Internet can be found at the URL: <http://manuals.fujitsu-siemens.com>. The server PRIMERGY documentation can be accessed using the *Industry standard servers* navigation option.

- [1] **Safety notes and other important information**
- [2] **Warranty**
- [3] **Ergonomics**
- [4] **Returning used devices**
- [5] **Quick Start Hardware - PRIMERGY RX330 S1**
Leaflet
- [6] **Quick Start Software - Quick Installation Guide**
Leaflet
- [7] **PRIMERGY RX330 S1 Server**
Options guide
- [8] **System Board D2440 for RX330 S1**
Technical manual
- [9] **BIOS Setup**
Reference manual
- [10] **PRIMERGY ServerView Suite**
ServerStart
User manual

Literature

- [11] **PRIMERGY ServerView Suite
ServerView S2**
Server Management
User Guide

- [12] **PRIMERGY ServerView Suite
ServerView**
Server Management
User Guide

- [13] **PRIMERGY ServerView Suite**
integrated Remote Management Controller (iRMC)

- [14] **ServerView RAID**
User manual

- [15] **Integrated RAID for SAS**
User's guide

- [16] **LSI SATA Software RAID**
User's guide

- [17] **Integrated Mirroring**
User's guide

- [18] **PRIMECENTER Rack**
Technical manual

- [19] **DataCenter Rack**
Technical manual

- [20] **19-Zoll-Rack/19 inch rack**
Technical manual

- [21] **PRIMERGY ServerView Suite
RemoteView**
User manual

Index

3rd party rack
installing in 42
requirements 37

A

Accessible drives
CD-RW 10
DVD-RW 10
magnetic tape drive 10
Acclimatization time 33, 75
Advanced Video Redirection 11
Ambient conditions 18
Articulated cable guide 41
ASR&R 11
Availability 10
AVR 11

B

BIOS update 14
BIOS, security functions 61

C

Cables
connecting 48
disconnecting 48
CD drive, indicator 49
CD/DVD indicator 51
CE marking 17, 28
Chipkill 11
Class A Compliance Statement 28
Cleaning
keyboard 60
monitor 60
mouse 60
server 60
Components
hardware 7
software 7
Configuration, server 58

Configuring onboard SAS
controller 60
Configuring RAID 58
Connecting cables 48
Connecting devices to the server 45
Connecting external devices 45
Connections 45
Consumables 31
Control panel 49
Controls 49
Correcting faults 63

D

Data manipulation 7
Data protection 61
Data security 10
DataCenter Rack, requirements 36
Date, incorrect 66
Delivery note 19, 34
Disconnecting cables 48
Disposal, devices 32
Drive
“dead” 67
defective 67
Drive access
indicator 49, 51
Dummy module, HDD module 76,
80
DVD drive, indicator 49

E

ECC 10
EDC 10
Electrical data 17
Electromagnetic compatibility 17, 28
Electrostatic-sensitive devices
(ESD) 27
EMC directive 17
EMC regulations 76, 80
Environment class 18
Environmental protection 31

Error

- drifting display on monitor 65
 - drive “dead” 67
 - drive defective 67
 - incorrect date 66
 - incorrect time 66
 - no display on monitor 65
 - no mouse pointer 65
 - power-on indicator does not light 63
 - screen remains blank 64
 - screen shows flickering stripes 65
 - server switches itself off 64
 - system does not boot 66
- Error Correcting Code 10
- Error Detection Code 10
- Error message on screen 67
- ESD (electrostatic-sensitive devices) 27
- External devices, connecting 45

F

Fault

- drifting display on monitor 65
 - incorrect date 66
 - incorrect time 66
 - no display on monitor 65
 - screen remains blank 64
 - screen shows flickering stripes 65
 - system does not boot 66
- FCC statement 28
- Features 9
- Flash EPROM 14

G

- Global Error, indicator 49, 51, 53
- Graphics card 46

H

- Hard disk drive 9
- handling 75
 - hard disk module 73
 - hot-plug hard disk drive 73
 - indicator 51, 52
 - installation frame 73
 - replacing online 79
- Hard disk module
- dummy module 73
 - handling 73
- HDD module 11
- acclimatization time 33, 75
 - installation frame 77
 - installing/removing 77
- Hot-plug HDD module 11, 73
- Hot-plug power supply unit 10, 47, 69
- Hot-spare memory, memory module 11

I

- ID button 49, 50
- ID indicator 49, 51, 53
- IME (Integrated Mirroring Enhanced) 58
- Indicators
- CD 49
 - drive access 51
 - DVD 49
 - front of device 49
 - Global Error 49, 51, 53
 - hard disk drive 52
 - HDD access 49
 - hot-plug power supply unit 55
 - ID 49, 51, 53
 - LAN connection/active 54
 - LAN transfer rate 54
 - on power supply unit 55
 - on the connection panel 53, 54
 - Power on indicator 49
 - rear of device 53, 54, 55
- Information material, additional 9

- Installation
 - server 43
 - telescopic rails 44
- Installing in
 - 3rd party rack 42
 - PRIMECENTER Rack 39
- Installing in the rack, notes 30
- Installing, server 35
- Integrated Mirroring Enhanced RAID functionality 10
- Integrated Mirroring Enhanced (IME) 58
- integrated Remote Management Controller 11
- iRMC 11

- K**
- Keyboard port 45

- L**
- Labels 32
- LAN connection/active indicator 54
- LAN port 1 45
- LAN port 2 11, 45
- LAN port, service 45
- LAN transfer rate indicator 54
- Laser information 25
- Light emitting diode (LED) 25
- Lithium battery 26
- Low Voltage Directive 17, 28

- M**
- Mains voltage, connecting server 47
- meaning of the symbols 16
- Memory module, hot-spare memory 11
- Memory scrubbing 10
- Monitor
 - display drifts 65
 - no display 65
- Mouse port 45
- Mouse, no mouse pointer on screen 65

- N**
- NMI button 49, 50
- Noise level 18
- Norms and standards 17
- Notational conventions 16

- O**
- On/Off button 49, 50
- Operating system installation 60
- Operation 49
- Overload 13

- P**
- Packaging 31, 34
- PDA 11, 13
- Ports
 - keyboard port 45
 - LAN port 1 45
 - LAN port 2 45
 - mouse port 45
 - service LAN port 45
 - USB 10, 45
- Power on indicator 50
- Power supply unit 69
 - dummy module 70
 - hot-plug 10
 - indicators 55
 - installing 71
 - redundant 47
 - removing 71
 - replacing 72
 - wide range 10
- Power supply, redundant 10, 47
- Power-on indicator
 - does not light 63
- Power-supply unit 47
- PRIMECENTER Rack
 - installing in 39
 - requirements 36
- Property protection 61

- R**
- Rack
 - requirements 35
 - telescopic rails 44
- RAID controller is not configured for this drive 67
- RAID functionality 10
- RAID level 11
- Rating plate 34
- Recycling devices 32
- Redundancy, power supply 10
- Remote Storage 11
- RemoteView 14, 15
- Removing, server 35
- Replacing online 79
- Requirements
 - 3rd party rack 37
 - DataCenter Rack 36
 - PRIMECENTER Rack 36
- Reset button 49, 50
- Return of devices 32
- Routing cables 41
- S**
- Safety 21
- Safety standards 17
- SAS controller
 - configuring RAID 58
 - IME configuration 58
 - Integrated Mirroring
 - Enhanced 10
- Saving energy 31
- Screen
 - error message 67
 - flickering 65
 - remains blank 64
 - shows flickering stripes 65
- Security functions 7
 - setup password 61
 - system password 61
 - unauthorized access 61
- Server
 - ambient conditions 18
 - configuration 14, 58
 - connecting mains voltage 47
 - dimensions 18
 - electrical data 17
 - fitting in rack 35
 - installation 43
 - installing 35
 - noise level 18
 - removing 35
 - routing cables 41
 - service 14
 - switches itself off (error) 64
 - switching off 56
 - switching on 56
 - technical data 17
 - transportation 29
 - unpacking 34
 - ventilation clearance 18
 - weight 18
- Server management 13
- ServerStart 14, 59
- ServerView 13
 - supported functions 13
- Service
 - server 14
 - touch-point 14
- Service LAN port 11, 45
- Setting up 49
- Setup password 61
- Support bracket 39
- Switch off time, defining 57
- Switch on time, defining 57
- Switching off, server 56
- Switching on, server 56
- System board 9
- System does not boot 66
- System password 61
- T**
- Target group 7
- Technical data 17
- Telescopic rail 41
- Telescopic rails 44
- Time, incorrect 66
- Touch-point 14

Transport damage [19, 34](#)
Troubleshooting [63](#)

U

Unauthorized access [61](#)
Unpacking, server [34](#)
USB port
 front of device [46](#)
 rear of device [45](#)
 service technician [10](#)

V

Ventilation clearance [18](#)

W

Weight [18](#)

Free Manuals Download Website

<http://myh66.com>

<http://usermanuals.us>

<http://www.somanuals.com>

<http://www.4manuals.cc>

<http://www.manual-lib.com>

<http://www.404manual.com>

<http://www.luxmanual.com>

<http://aubethermostatmanual.com>

Golf course search by state

<http://golfingnear.com>

Email search by domain

<http://emailbydomain.com>

Auto manuals search

<http://auto.somanuals.com>

TV manuals search

<http://tv.somanuals.com>