

PRIMERGY RX200 S2 Serversystem

Options Guide

Edition October 2004

Comments... Suggestions... Corrections...

The User Documentation Department would like to know your opinion of this manual. Your feedback helps us optimize our documentation to suit your individual needs.

Fax forms for sending us your comments are included in the back of the manual.

There you will also find the addresses of the relevant User Documentation Department.

Certified documentation according to DIN EN ISO 9001:2000

To ensure a consistently high quality standard and user-friendliness, this documentation was created to meet the regulations of a quality management system which complies with the requirements of the standard DIN EN ISO 9001:2000.

cognitas. Gesellschaft für Technik-Dokumentation mbH
www.cognitas.de

Copyright and Trademarks

Copyright © 2004 Fujitsu Siemens Computers GmbH.

All rights reserved.

Delivery subject to availability; right of technical modifications reserved.

All hardware and software names used are trademarks of their respective manufacturers.

This manual is printed on paper treated with chlorine-free bleach.

Preface

Procedure

Safety Instructions

Preparation

Main Memory

Processors

Accessible Drives

Controllers in Non-Hot-Plug PCI Slots

RemoteView Components

Completion

Abbreviations

Related publications

Index

Contents

1	Preface	1
1.1	Overview of the documentation	1
1.2	Extensions and conversions	3
1.3	Notational conventions	5
2	Procedure	7
3	Safety Instructions	9
4	Preparation	15
4.1	Opening the server	15
5	Main Memory	17
5.1	Installation rules	17
5.2	Upgrading / exchanging main memory	18
6	Processors	19
6.1	Installing a second processor	19
6.2	Exchanging the processor	24
6.3	Exchanging the heat sink	27
7	Accessible Drives	29
7.1	Installing the LocalView Module	30
7.2	Installing a CD-ROM/DVD drive	32
7.3	Installing a floppy disk drive	35
8	Controllers in Non-Hot-Plug PCI Slots	39
8.1	Installing controllers	40
9	RemoteView Components	43
9.1	Installing the RemoteView Service Board S2 LP	43
10	Completion	45
10.1	Closing the server	45
	Abbreviations	47
	Related publications	53
	Index	55

1 Preface

The PRIMERGY RX200 S2 is an Intel-based server for mid-tier applications in server farms. The server is well suited for front end services as well as for use as an e-mail server, Internet server, or general applications server.

1.1 Overview of the documentation

 PRIMERGY manuals are available in PDF format on the ServerBooks CD which is supplied as part of the ServerView Suite package for every server system.

These PDF files can also be downloaded free of charge from the Internet: At <http://manuals.fujitsu-siemens.com> you will find an overview page showing the online documentation available on the Internet. You can go to the PRIMERGY Server documentation by clicking on “intel based Servers”.

Concept and target groups

This Options Guide shows you how you can expand and upgrade the server.



Caution!

The activities described in this manual may only be performed by specialist personnel with technical training.



How to install/remove the hot-plug components is described in the Operating Manual for the server.

Additional documentation about the server

The PRIMERGY RX200 S2 documentation comprises the following additional manuals:

- The “Security” manual (printed copy always supplied with the server, and available as a PDF file on the *ServerBooks* CD supplied)
- The “Guarantee” manual (printed copy always supplied with the server, and available as a PDF file on the *ServerBooks* CD supplied)
- The Operating Manual for PRIMERGY RX200 S2 (PDF available on the *ServerBooks* CD supplied)
- The Technical Manual for the system board D1790 (PDF available on the *ServerBooks* CD supplied)

- The “BIOS Setup” manual (PDF available on the *ServerBooks* CD supplied)
- The “Service Supplement for PRIMERGY RX200 S2” (PDF available on the *ServerBooks* CD supplied)
- The “ServerView Suite” manual (printed copy always supplied with the server, and available as PDF file on the *ServerBooks* CD supplied)
- The “Adaptec HostRAID User’s Guide” (PDF available on the *ServerBooks* CD supplied)
- The “Ergonomics” manual (PDF available on the *ServerBooks* CD supplied).



You can order a supplementary *ServerBooks* CD by sending an e-mail to the following address, quoting your server data:

Reklamat-PC-LOG@fujitsu-siemens.com

Further sources of information:

- Technical Manual on the relevant rack
- Manual on the monitor
- Manual on *ServerView* Server Management
- Manual on the *RemoteView* Remote Test and Diagnostics System
- Documentation on boards and drives
- Documentation on your operating system
- Information files on your operating system

(see also “Related publications” on page 53)

1.2 Extensions and conversions

Second processor

The system board can be upgraded with a second processor. Only processors of the same type may be used on the system board. The second processor must have the same clock frequency as the first processor.

Extension of the main memory

The eight slots for the main memory are suitable for PC2-3200 DDR DIMM memory modules. Their organization in four memory banks, 0 to 3, allows fast memory access with two-way interleaving.

Memory modules must always be installed in pairs. A memory bank must always be fully equipped and with the same type of memory modules.

Additional accessible drives

The accessible drives available are a floppy disk drive and a CD-ROM/DVD drive. The drives can be installed in the two top bays. The left-hand bay is intended for a 3.5 x 0.5 inch floppy drive or a LocalView module, while the right-hand bay takes a 5.25 x 0.5 inch CD-ROM/DVD drive.

LocalView module (alphanumeric system display)

The LocalView module gives you the option of displaying system information and hardware system faults alphanumerically. This is an intelligent module with a microcontroller and its own memory, which functions independently of the server system.

The LocalView module consists of an LCD display panel and a toggle switch, both accommodated in a suitable mount. The mechanism used allows the LCD display panel to be pulled out and opened out.

For more information on operation and display modes, see the documentation for the LocalView module [6].

Additional controllers in non-hot-plug PCI slots

The system board offers two PCI-X slots:

- PCI-X slot 1: 64 bit/133 MHz, max. length 315 mm
- PCI-X slot 2: 64 bit/66 MHz, low profile, max. length 175 mm



Both slots are **not** hot-pluggable.

RemoteView

RemoteView provides you with a comprehensive remote test and diagnostics package.

RemoteView Service Board S2 LP

The RemoteView Service Board S2 “low profile” (RSB S2 LP) is a PCI board with a completely independent system, i.e. it has its own operating system with Web server and SNMP agents and can optionally be equipped with an external power supply.

The RSB S2 LP is inserted into a standard-PCI slot via a riser card and connected to the system board by means of a cable.

The RSB S2 LP permits remote diagnosis for system analysis, remote system configuration and remote restart even in the event of operating system failure or hardware faults. It has its own LAN connection and its own COM port. All the functions of the RSB S2 LP are thus available either via LAN or via modem.

1.3 Notational conventions

The following notational conventions are used in this manual:



<i>Italics</i>	indicate commands, menu items or software programs.
“Quotation marks”	indicate names of chapters and terms that should be emphasized.
▶	text which follows this symbol describes activities that must be performed in the order shown.
 CAUTION!	pay particular attention to text marked with this symbol. Failure to observe this warning may endanger your life, damage the server, or lead to loss of data.
	supplementary information, remarks and tips follow this symbol.

Table 1: Notational conventions

2 Procedure



CAUTION!

- The actions described in this manual should only be performed by engineers, service personnel or technical specialists.
 - Equipment repairs should only be performed by authorized, qualified staff.
 - Any failure to observe the guidelines in this manual, and any unauthorized openings and improper repairs could expose the user to risks (e.g. electric shock, fire hazards) and could also damage the equipment.
 - Please note that any unauthorized opening of the device will result in the invalidation of the warranty and exclusion from all liability.
- ▶ First of all please familiarize yourself with the safety instructions in the chapter “Safety Instructions” on page 9ff.
 - ▶ Make sure that all required manuals (see “Additional documentation about the server” on page 1) are available, printing out the PDF files if necessary.

You will definitely need

- the Operating Manual for the server and
 - the Service Supplement for the server
 - the Technical Manual for the system board.
- ▶ Shut down the server correctly, switch it off, pull out the power plug, and open the server as described in the chapter “Preparation” on page 15ff.
 - ▶ Extend or upgrade your server as described in the relevant chapter.
-  How to install/remove the hot-plug components is described in the Operating Manual for the server.
- ▶ Close the server, plug all mains plugs into the power outlets, and switch on the server as described in the chapter “Completion” on page 45ff.
 - ▶ Start the operating system and, if necessary, configure it as required (see the Operating Manual).

3 Safety Instructions



The following safety instructions can also be found in the manual entitled “Safety”.

This device complies with the relevant safety regulations for data processing equipment, including electronic office machines for use in an office environment.

If you have any questions as to whether you can set up the device in your particular environment, please contact your sales outlet or our customer service centre.



CAUTION!

- The actions described in this manual should only be performed by engineers, service personnel or technical specialists.
- Equipment repairs should only be performed by qualified staff.
- Any failure to observe the guidelines in this manual, and any unauthorized openings and improper repairs could expose the user to risks (e.g. electric shock, fire hazards) and could also damage the equipment.
- Please note that any unauthorized opening of the device will result in the invalidation of the warranty and exclusion from all liability.

Before setting up



CAUTION!

- During installation and before operating the device, observe the instructions on environmental conditions for your device.
- If the device is brought in from a cold environment, condensation may form both inside and on the outside of the machine.

Before operating the device, wait until it is absolutely dry and has reached approximately the same temperature as the installation site. Failure to observe these guidelines can lead to material damage of the device.

- Transport the device only in its original packaging or in packaging which protects it from knocks and jolts.

Installation and operation



CAUTION!

- If the rack model is integrated in an installation that receives power from an industrial (public) power supply network with the IEC309 connector, the (public) power supply protection must comply with the requirements for the non-industrial (public) power supply networks for the type A connector.
- The server automatically adjusts to a mains voltage between 100 V and 240 V. Make sure that the local mains voltage is neither above nor below this range.
- This device has safety-tested power cables and must only be connected to properly grounded power outlets.
- Make sure that the power socket on the device or the grounded mains outlet is freely accessible.
- The power switch does not disconnect the device from the mains voltage. To completely disconnect it from the mains voltage, you must remove the power plug from the power outlet.
- Always connect the device and the attached peripherals to the same power circuit. Otherwise you run the risk of losing data if, for example, a power outage occurs and the central processing unit is still running but the peripheral device (e.g. a storage subsystem) has failed.
- Data cables must be adequately shielded to avoid interference.
- For the LAN wiring, the requirements according to standards EN 50173 and EN 50174-1/2 apply. The minimum requirement is the use of a protected LAN line of category 5 for 10/100 Mbps Ethernet, and/or of category 5e for Gigabit Ethernet. The requirements of the specification ISO/IEC 11801 must also be taken into account.
- Route the cables in such a way that they do not form a potential hazard (tripping) and that they cannot be damaged. When connecting the device, refer to the relevant notes in the operating manual.
- Do not connect or disconnect any data transmission cables during a thunderstorm (lightning hazard).



CAUTION!

- Be careful to ensure that no objects (e.g. jewelry, paper clips etc.) or liquids get inside the device (electric shock, short circuit).
- In emergencies (e.g. damaged casing, elements, or cables, penetration of liquids or foreign bodies), switch off the device immediately, remove the power connector from the grounded power outlet, and contact your customer service centre.
- Proper operation of the device (in accordance with IEC 60950/DIN EN 60950) is only ensured if the casing is completely assembled and the rear covers for the installation openings have been put in place (electric shock, cooling, fire protection, interference suppression)
- Install only system extensions that satisfy the requirements and rules governing safety, electromagnetic compatibility, and telecommunications terminal equipment.

If you install other extensions, you may damage the system or violate these safety regulations.

Information on which system extensions are suitable can be obtained from the customer service centre or your sales outlet.

- The components marked with a warning label (e.g. lightning symbol) may only be opened, removed, or exchanged by authorized, qualified personnel.
- The warranty is invalidated if the device is damaged during the installation or replacement of system extensions.
- You may set only those resolutions and refresh rates specified in the operating manual for your monitor.
Otherwise, you may damage the monitor. If you are in any doubt, contact your sales outlet or customer service centre.

Batteries



CAUTION!

- Incorrect replacement of batteries may lead to risk of explosion. The batteries may only be replaced with identical batteries or with a type recommended by the manufacturer (see the Technical Manual for the system board under “Related publications” on page 67).
- Do not throw batteries into the trash can. They must be disposed of in accordance with local regulations concerning special waste.
- Replace the lithium battery on the system board in accordance with the instructions in the Technical Manual for the system board (see “Related publications” on page 67).
- All batteries containing pollutants are marked with a symbol (a crossed-out garbage can). The marking also contains the chemical symbol of the heavy metal that determines the classification as a pollutant:

Cd Cadmium

Hg Mercury

Pb Lead

Notes on handling CDs in CD-ROM/DVD drives



CAUTION!

- Use only CDs in proper condition in the CD-ROM/DVD drive of your server to prevent data loss, damage to the device, or injuries.

Therefore, check each CD for damage, cracks, breakage etc. before inserting it in the drive.

- Please note that any additional labels applied may change the mechanical properties of a CD and cause imbalance.
- Damaged and imbalanced CDs can break at high drive speeds (data loss).
- Under certain conditions, sharp-edged pieces of broken CDs can penetrate the cover of the drive (cause damage to the device) and be thrown out of the device (therefore causing injury to uncovered body parts, particularly the face or neck).



To protect the CD-ROM/DVD drive and prevent mechanical damage, as well as premature wearing of the CDs, you should observe the following advice:

- Only insert the CDs in the drive when needed and remove them after use.
- Store the CDs in suitable sleeves.
- Protect the CDs from exposure to heat and direct sunlight.

Note on the laser

The CD-ROM/DVD drive contains a light-emitting diode (LED) classified according to IEC 825-1:1993:LASER CLASS 1.

Modules with electrostatic-sensitive devices

Electrostatic-sensitive components are identified by the following sticker:

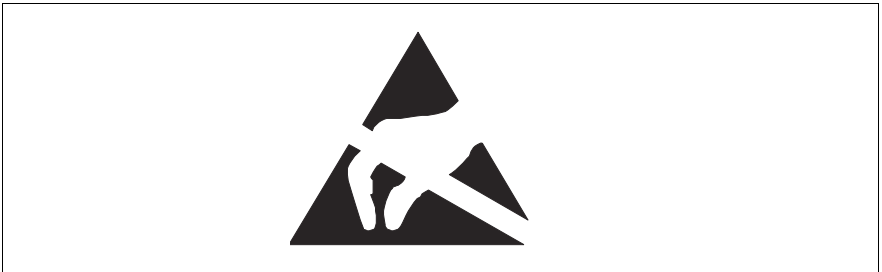

Figure 1: ESD label



CAUTION!

When you handle components fitted with ESDs, you must observe the following points under all circumstances:

- Remove the power plug from the power socket before inserting or removing components containing ESDs.
- You must always discharge static build-up (e.g. by touching a grounded object) before working with such components.
- The equipment and tools you use must be free of static charge.
- Use a grounding cable designed for this purpose to connect yourself to the system unit as you install components.



CAUTION!

- Always hold components with ESDs at the points marked green (touch points).
- Do not touch any exposed pins or conductors on a component.
- Place all components on a static-free base.



You will find a detailed description of handling ESD components in the relevant European or international standards (EN 61340-5-1, ANSI/ESD S20.20).

4 Preparation



CAUTION!

Please observe the safety information in the chapter “Safety Instructions” on page 9ff.

4.1 Opening the server

- ▶ Exit all applications and shut down the server correctly.
- ▶ Press the on/off button.
- ▶ Unplug the power plugs.

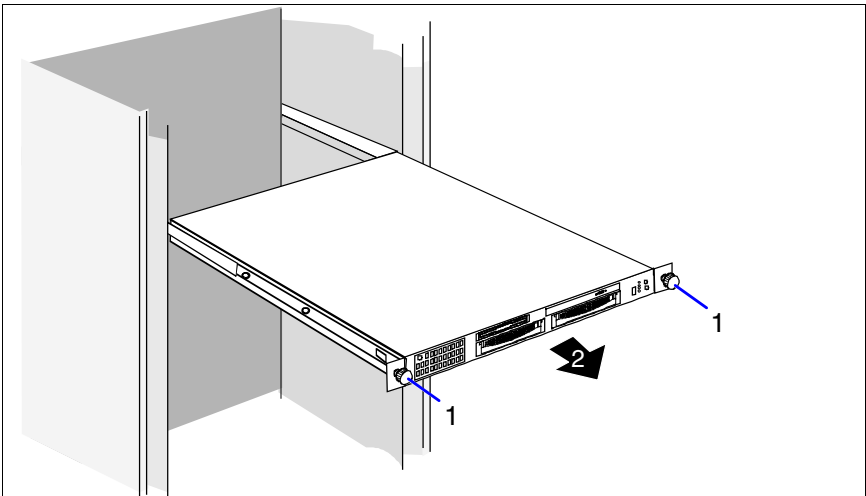

Figure 2: Removing the server

- ▶ Undo the knurled screws (1) and pull the server carefully out of the rack (2) as far as possible.

In the majority of cases it makes sense to remove the server from the rack.

**CAUTION!**

There is **no cable management** for the server in the rack!
Before you remove the server from the rack, you must therefore unplug all cables connected to the server from their sockets.



How to remove the server from the rack is described in the operating manual.

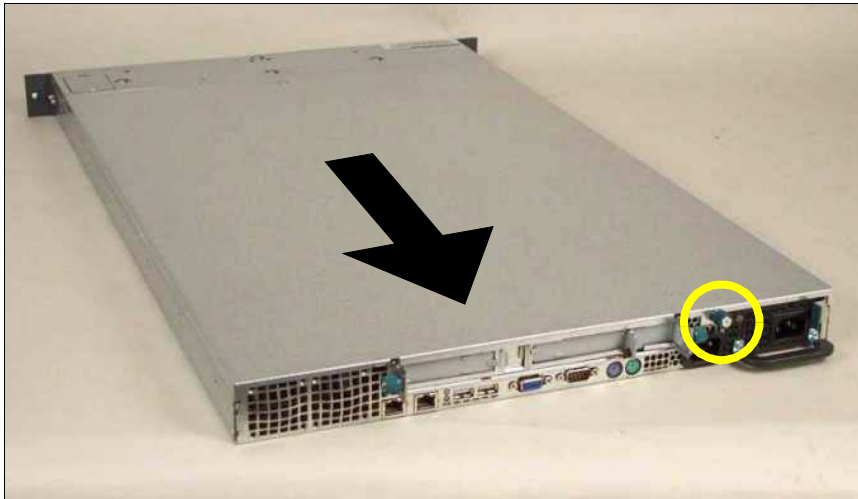

Figure 3: Removing the cover

- ▶ Undo the knurled screw on the back of the device (see figure).
- ▶ Pull the server cover back a few centimeters.
- ▶ Lift up the server cover and remove it.

5 Main Memory



CAUTION!

Please observe the safety information in the chapter “Safety Instructions” on page 9ff.

The eight slots for the main memory are suitable for PC2-3200 DDR-II DIMM memory modules. The board supports a maximum of 13-16 Gbytes of main memory (depending on the configuration). Organization in four memory banks, 0 to 3, enables fast memory access with two-way interleaving.

5.1 Installation rules



CAUTION!

Memory modules have to be installed in pairs. Each memory bank must always be fully equipped with the same type of modules.

The following memory configurations are permitted:

Mem. module Bank/DIMM no. Socket label	1 1.1 DIMM A1	2 1.2 DIMM B1	3 1.2 DIMM A2	4 1.2 DIMM B2	5 1.2 DIMM A3	6 1.2 DIMM B3	7 1.2 DIMM A4	8 1.2 DIMM B4	Mounted memory banks ↓
Populated with 2 DIMMs	X	X							1
Populated with 4 DIMMs	X	X	X	X					2
Populated with 6 DIMMs	X	X	X	X	X	X			3
Populated with 8 DIMMs	X	X	X	X	X	X	X	X	4

5.2 Upgrading / exchanging main memory

- ▶ Open the server as described in the chapter “Preparation” on page 15f.

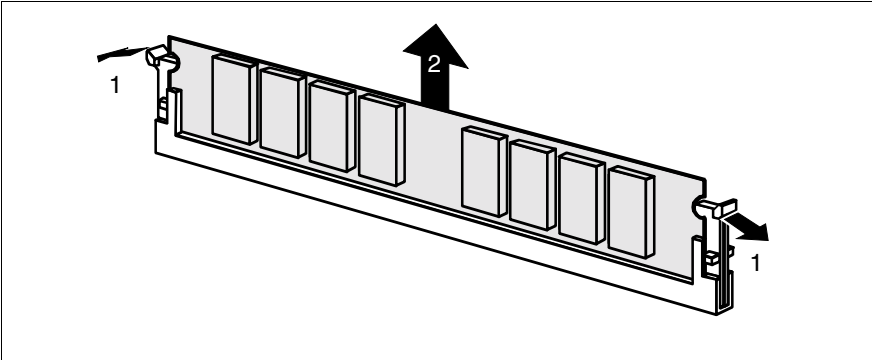

Figure 4: Removing a memory module

- ▶ Flip the ejector tabs on each side of the slot outward (1). This levers an installed memory module out of its slot.
- ▶ Remove the memory module from the slot (2).

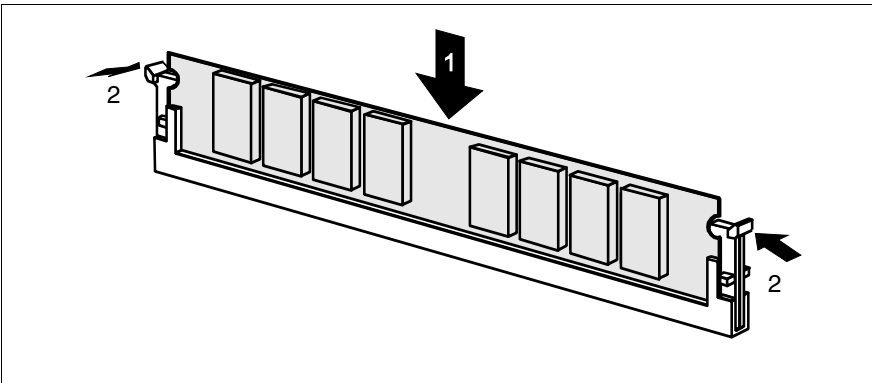

Figure 5: Installing a memory module

- ▶ Carefully press the memory module into the slot (1) until the ejector tabs on both sides of it engage (2).
- ▶ Close the server, plug in the power plugs, and switch on the server as described in the chapter “Completion” on page 45f.

6 Processors



CAUTION!

Please observe the safety information in the chapter “Safety Instructions” on page 9ff.



CAUTION!

Processors are components which are extremely sensitive to electrostatic discharge and must be handled with caution. When you take a processor out of its protective wrapper or out of a socket, place it on an insulated, antistatic surface with the smooth side down. Never slide a processor over a surface.

6.1 Installing a second processor

The system board can be upgraded with a second processor.



CAUTION!

You may only use processors of the same type. The second processor must have the same clock frequency as the first. For dual-processor mode use a suitable multiprocessor operating system.

- ▶ Open the server as described in the chapter “Preparation” on page 15f.

Removing the ventilation duct

Figure 6: Removal of the ventilation duct

- ▶ Lift off the ventilation duct upwards.

Removing the heat sink dummy

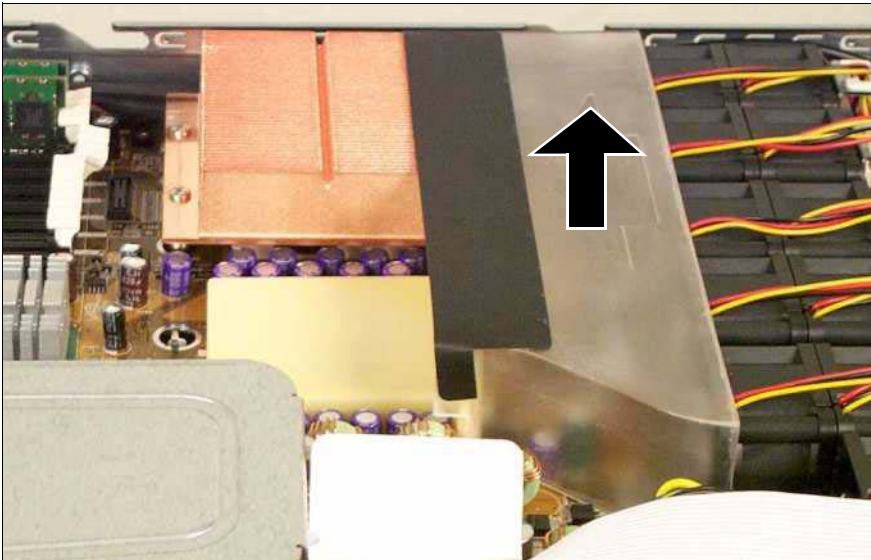
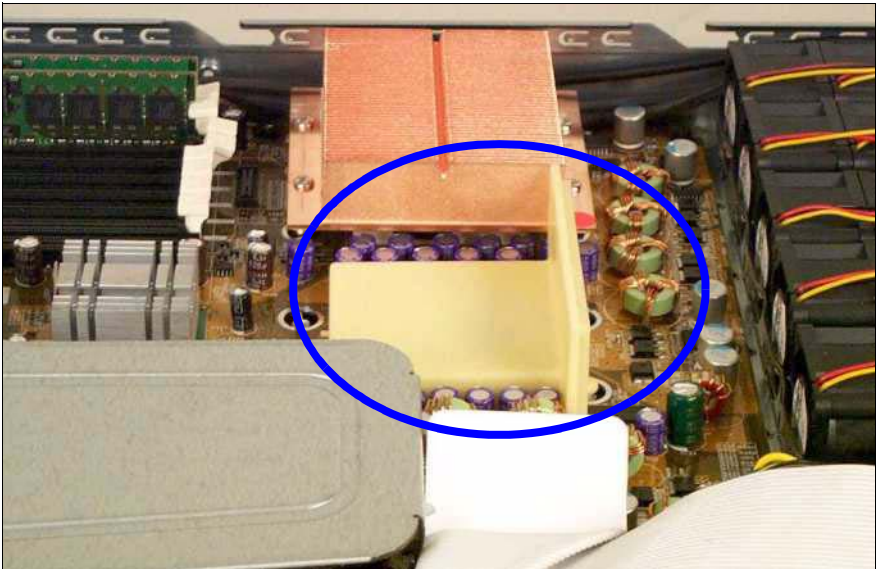

Figure 7: Removing the heat sink dummy

- ▶ Remove the heat sink dummy.

Installing the processor

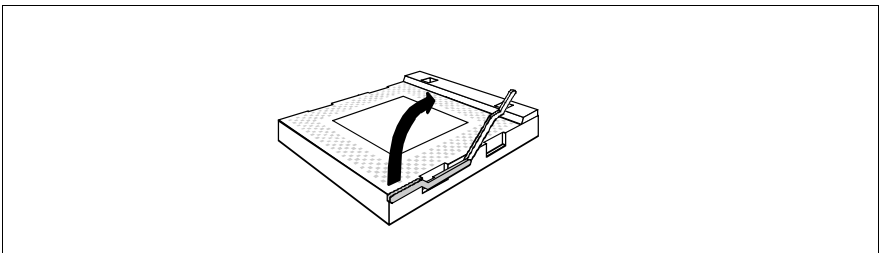

Figure 8: Opening the socket lever

- ▶ Release the socket lever by pressing it sideways and lifting it up as far as it will go.

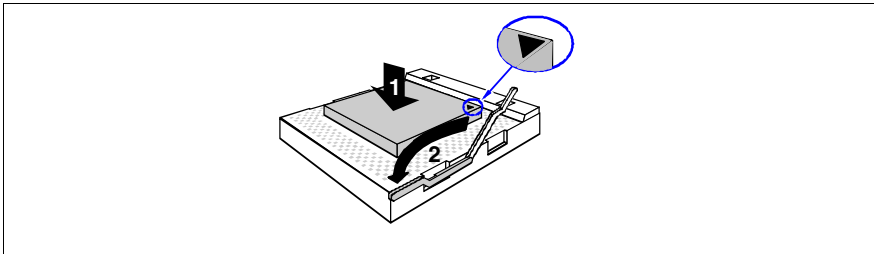

Figure 9: Installing the processor

- ▶ Position the new processor over the socket and fit it into the socket by carefully pushing it downwards (1).



CAUTION!

The processor can only be installed in one direction. Pay attention to the marking on one of the corners for the correct alignment (see figure). To avoid damaging the pins or the processor, do not force the processor into the socket.

- ▶ Lock the processor into place in the socket by pushing the socket lever back into its original position (2).

Installing the heat sink

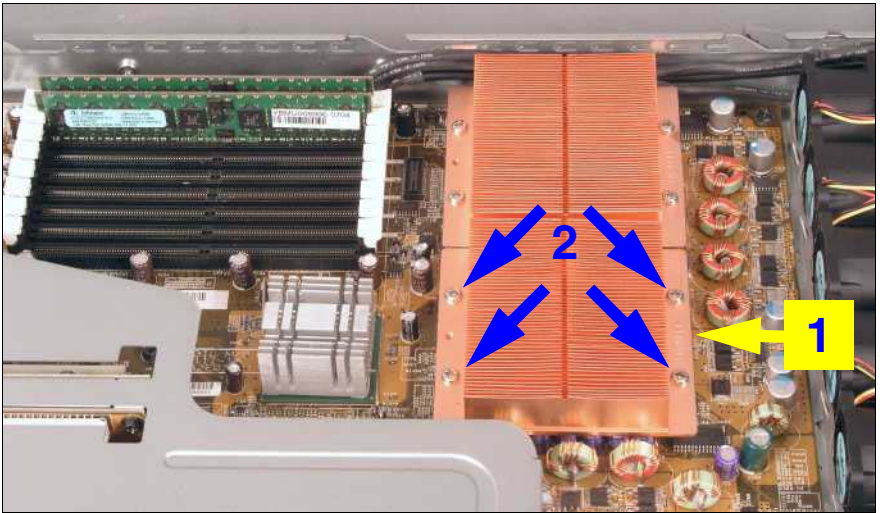

Figure 10: Installing the heat sink

- ▶ Fit the heat sink on the processor such that the side labeled “FRONT” (see arrow (1) in figure above) is facing the front of the server.
- ▶ Attach the heat sink with four screws. Tighten the screws in diagonally opposite sequence (2).



CAUTION!

Never install a processor without a heat sink! The processor is likely to overheat, which may cause damage to the processor and the system board.

Installing the ventilation duct

- ▶ Reinstall the ventilation duct (see page 20).
- ▶ Close the server, plug in the power plugs, and switch on the server as described in the chapter “Completion” on page 45.

6.2 Exchanging the processor



CAUTION!

You may only use processors of the same type on the system board.

- ▶ Open the server as described in the chapter “Preparation” on page 15f.
- ▶ Remove the ventilation duct (see page 20).

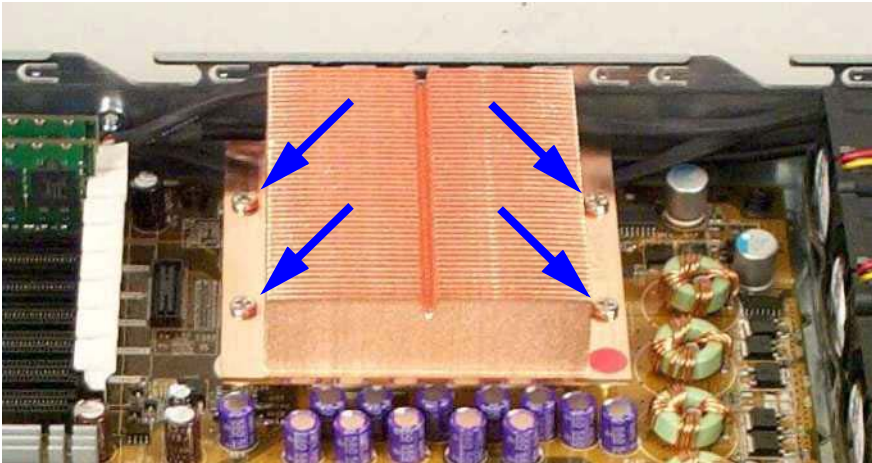

Figure 11: Removing the processor heat sink

- ▶ Remove the four screws of the heat sink in diagonally opposite sequence (see figure).
- ▶ Turn the heat sink carefully back and forth to loosen it. Then lift it out to remove it.
- ▶ Remove the residual thermal paste from the underside of the heat sink.
- ▶ Clean the underside of the heat sink using a lint-free cloth.

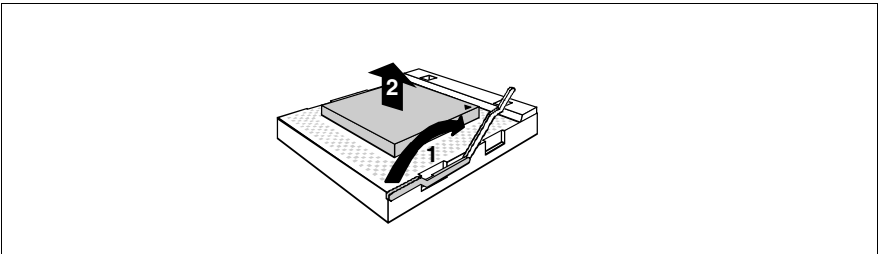

Figure 12: Removing the old processor

- ▶ Release the socket lever by pressing it sideways and lifting it up as far as it will go (1).
- ▶ Lift the installed processor carefully out of its socket (2).

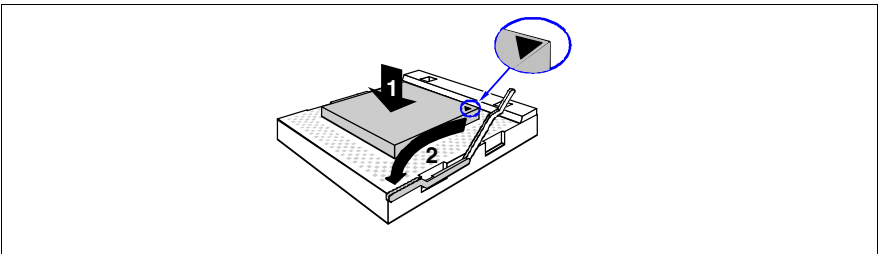

Figure 13: Installing the new processor

- ▶ Position the new processor above the socket, and press it carefully into the socket (1).

**CAUTION!**

The processor can only be installed in one direction. Pay attention to the marking on one of the corners for the correct alignment. To avoid damaging the pins or the processor, do not force the processor into the socket.

- ▶ Lock the processor into place in the socket by pushing the socket lever back into its original position (2).

- ▶ Apply a small amount of thermal paste to the top of the new processor.
- ▶ Spread the paste thinly and evenly.
- ▶ Fit the heat sink on the processor such that the side labeled “FRONT” is facing the front of the server (see page 23).
- ▶ Attach the heat sink with four screws. Tighten the screws in diagonally opposite sequence (see page 23).
- ▶ Reinstall the ventilation duct (see page 20).
- ▶ Close the server, plug in the power plugs, and switch on the server as described in the chapter “Completion” on page 45.

6.3 Exchanging the heat sink

- ▶ Open the server as described in the chapter “Preparation” on page 15f.
- ▶ Remove the ventilation duct (see page 20).
- ▶ Remove the four screws of the heat sink in diagonally opposite sequence (see page 24).
- ▶ Turn the heat sink carefully back and forth to loosen it. Then lift it out to remove it.
- ▶ Clean the surface of the processor with a lint-free cloth.
- ▶ Fit the heat sink on the processor such that the side labeled “FRONT” is facing the front of the server (see page 23).
- ▶ Attach the heat sink with four screws. Tighten the screws in diagonally opposite sequence (see page 23).
- ▶ Reinstall the ventilation duct (see page 20).
- ▶ Close the server, plug in the power plugs, and switch on the server as described in the chapter “Completion” on page 45f.

7 Accessible Drives



CAUTION!

Please observe the safety information in the chapter “Safety Instructions” on page 9ff.

The PRIMERGY RX200 S2 server offers a total of two slots for accessible drives. Available are a floppy disk drive and a CD-ROM/DVD drive. Instead of the floppy drive a LocalView module can be installed.

The drives can be installed into the two top bays. The left-hand bay is intended for a 3.5 x 0.5 inch floppy drive or a LocalView module, while the right-hand bay takes a 5.25 x 0.5 inch CD-ROM/DVD drive.

7.1 Installing the LocalView Module

The LocalView module is an optional extra for servers in the PRIMERGY series. It allows you to read status messages directly from the server on the LocalView display panel. These status messages provide system information and warnings of hardware errors (e.g. fan failure, CPU overvoltage, etc.)

The LocalView module can be pulled out like a drawer. You can also angle the LCD panel downwards.

In the RX200 S2 server, the LocalView module can be installed next to the 5.25 x 0.5 inch CD-ROM/DVD drive bay instead of a floppy disk drive.



Figure 14: LocalView module

- ▶ Open the server as described in the chapter “Preparation” on page 15f.

- ▶ Remove the dummy cover with a screwdriver.

**CAUTION!**

Keep the dummy cover for future use. If you remove the LocalView module without installing a new one, you must reinstall the dummy cover to comply with EMC regulations and to satisfy cooling requirements and fire protection measures.

- ▶ Push the LocalView module into its bay until it engages.

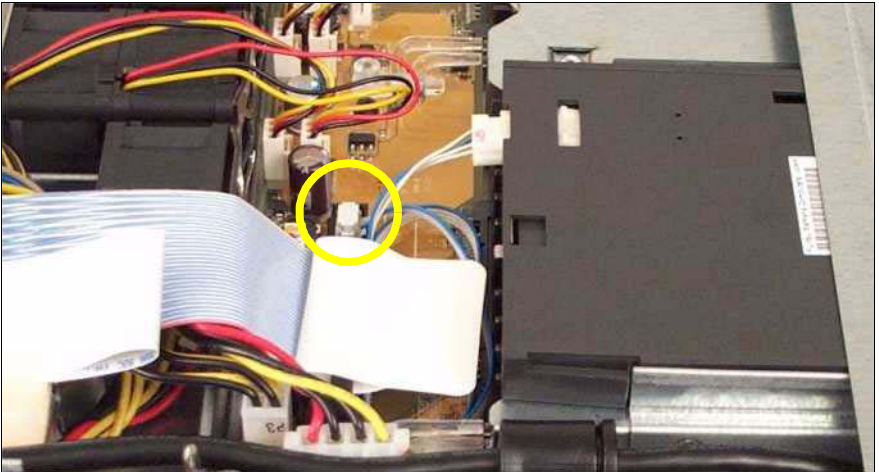

Figure 15: Connecting the LocalView module

- ▶ Connect the CN6 plug of the SCSI/fan board (see figure) using the IPMB cable with the connector on the rear of the LocalView module.
- ▶ Close the server, plug in the power plugs, and switch on the server as described in the chapter “Completion” on page 45.



For information on operation and display modes, see the user documentation for the LocalView module [6].

7.2 Installing a CD-ROM/DVD drive

You can install a CD-ROM/DVD drive in the top right bay (seen from the front). If the bay is empty, a dummy cover will have been fitted.

Removing the dummy cover

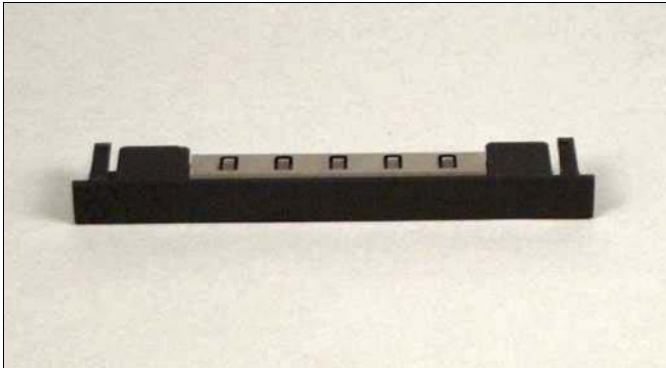

Figure 16: Dummy cover

- ▶ Remove the dummy cover with a screwdriver.



CAUTION!

Keep the dummy cover for future use. If you remove the drive without installing a new one, you must reinstall the dummy cover to comply with EMC regulations and to satisfy cooling requirements and fire protection measures.

Installing a CD-ROM/DVD drive

Figure 17: Mounting the drive in its frame

- ▶ Insert the CD-ROM/DVD drive in its frame and secure it with four screws.
- ▶ Push the CD-ROM/DVD drive into its bay from the front until it engages.

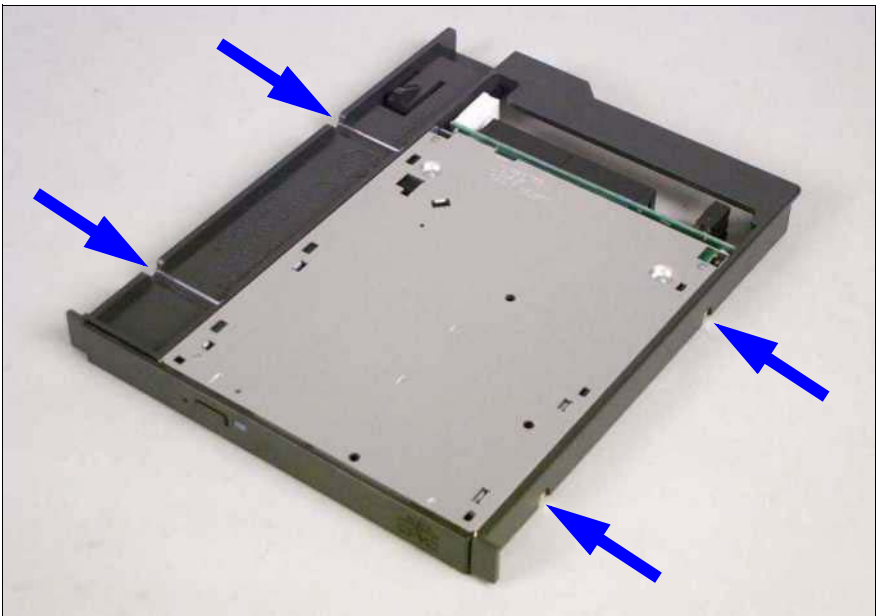
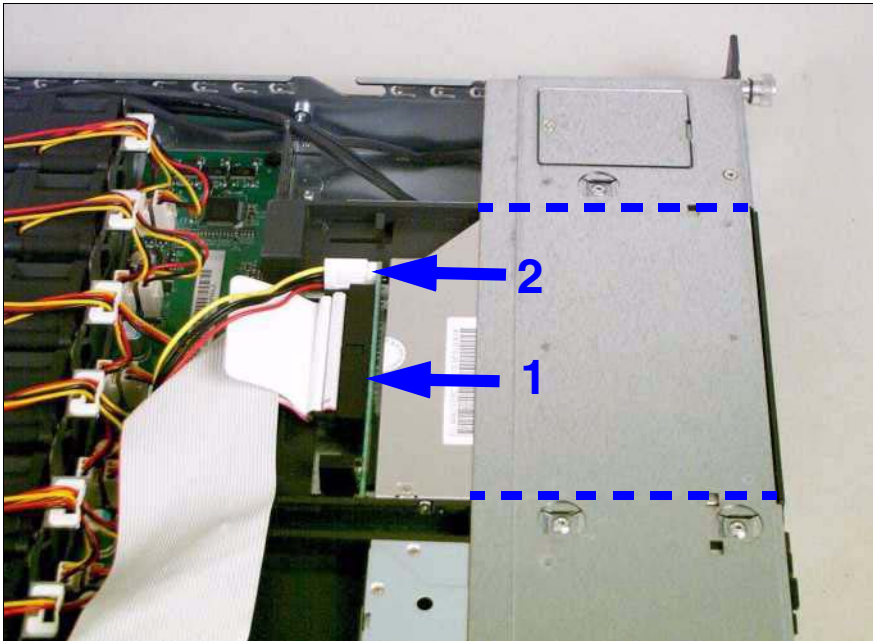

Figure 18: Installing the CD-ROM/DVD drive

- ▶ Plug the data cable (1) and the power cable (2) into the CD-ROM/DVD drive.
- ▶ Close the server, plug in the power plugs, and switch on the server as described in the chapter “Completion” on page 45f.

7.3 Installing a floppy disk drive

You can install a floppy disk drive in the top left bay (seen from the front). If the bay is empty, a dummy cover will have been fitted.

Removing the dummy cover



Figure 19: Dummy cover

- ▶ Remove the dummy cover with a screwdriver.



CAUTION!

Keep the dummy cover for future use. If you remove the drive without installing a new one, you must reinstall the dummy cover to comply with EMC regulations and to satisfy cooling requirements and fire protection measures.

Removing/installing a floppy disk drive

Figure 20: Mounting the drive in its frame

- ▶ Insert the floppy disk drive in its frame and secure it with two screws.
- ▶ Push the floppy disk drive in its frame into the bay from the front until it engages.

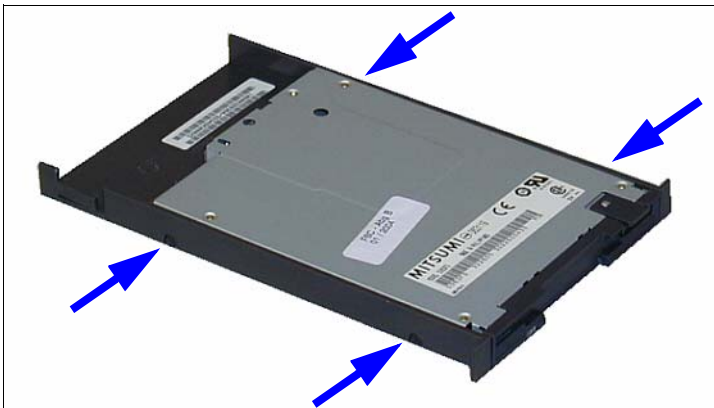
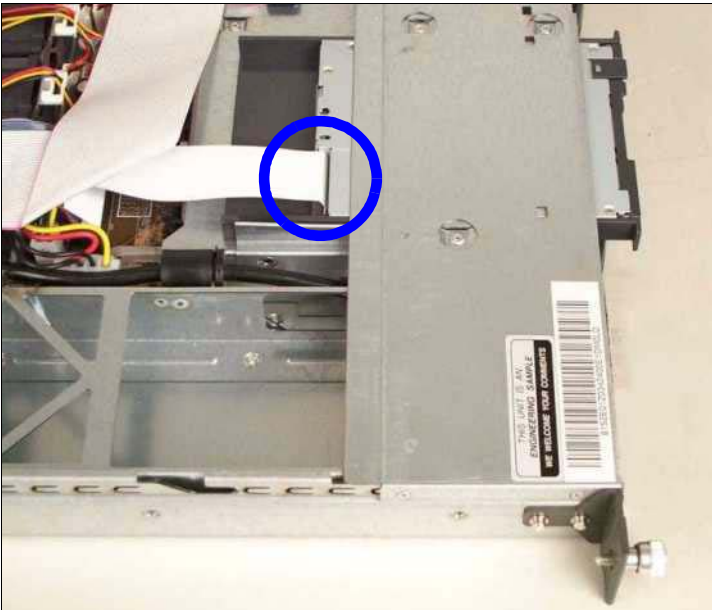

Figure 21: Connecting the data cable

- ▶ Remove the capton foil from the data cable and connect the cable to the rear of the floppy drive (see figure).
- ▶ Close the server, plug in the power plugs, and switch on the server as described in the chapter “Completion” on page 45f.

8 Controllers in Non-Hot-Plug PCI Slots



CAUTION!

Please observe the safety information in the chapter “Safety Instructions” on page 9ff.

If you want to replace components which are **not** hot-pluggable, you **must** proceed as follows:

- ▶ Shut down the operating system
- ▶ Switch off the server, and
- ▶ Unplug the power plugs.

The system board contains two PCI-X slots, which can only be used via a riser card because of the height of the server:

- PCI-X slot 1: 64 bit/133 MHz, max. length 315 mm
- PCI-X slot 2: 64 bit/66 MHz, low profile, max. length 175 mm



Both slots are **not** hot-pluggable.

8.1 Installing controllers

- ▶ Open the server as described in the chapter “Preparation” on page 15f.

Removing the riser card holder

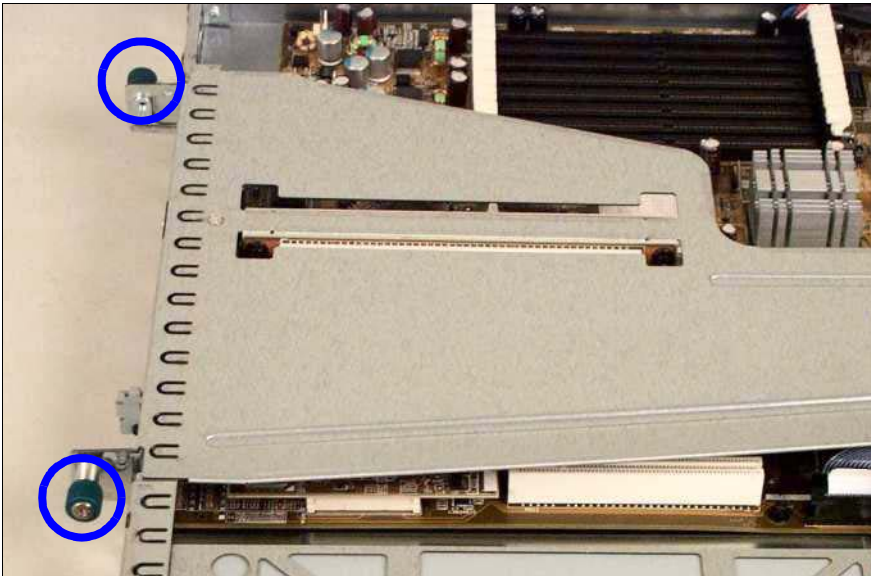

Figure 22: Removing the riser card holder

- ▶ Undo the two knurled screws (see figure).
- ▶ Pull out the riser card holder upwards.

Installing a PCI board

- ▶ Please read the documentation supplied with the PCI board.
- ▶ Plug any necessary cables into the PCI board.
- ▶ Remove the slot cover from the PCI board.

i Keep the slot cover for future use. If you remove the board without installing a new one, you must reinstall the slot cover to comply with EMC regulations (regulations on electromagnetic compatibility) and to satisfy cooling requirements and fire protection measures.

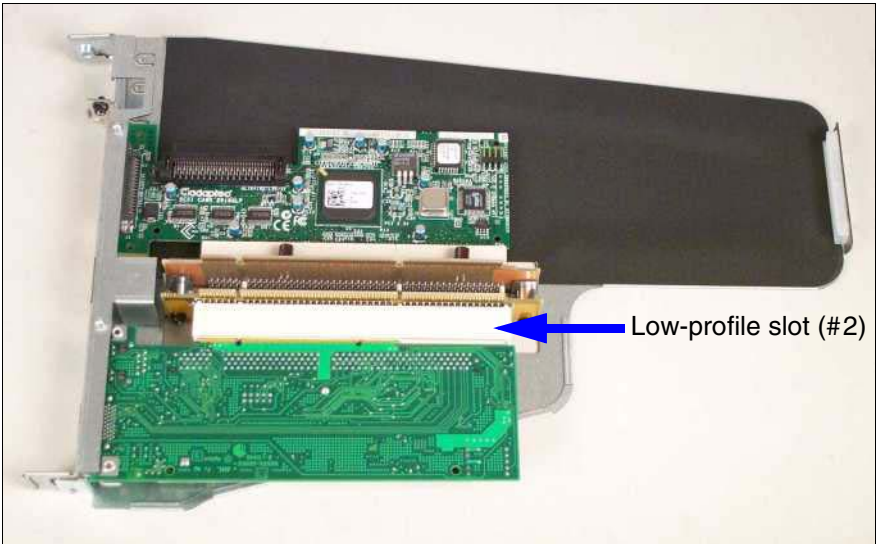

Figure 23: Mounting the board

- ▶ Plug the board into the PCI slot on the riser card that is suitable for the height of the board.



Make sure that the slot cover fits into the appropriate recess.

- ▶ If necessary, plug in the cables on the board and other components.

Reinstalling the riser card holder

- ▶ Plug the riser card holder into the system board.
- ▶ Attach the riser card holder to the rear of the housing with two knurled screws (see page 40).
- ▶ Close the server, plug in the power plugs, and switch on the server as described in the chapter “Completion” on page 45f.

9 RemoteView Components



CAUTION!

Please observe the safety information in the chapter “Safety Instructions” on page 9ff.

9.1 Installing the RemoteView Service Board S2 LP



How to install/remove and configure the RSB S2 LP is described in detail in the manual “RemoteView Service Board S2/S2 LP 1.x, Mounting and Setting Up”.

The RemoteView Service Board S2 LP (RSB S2 LP) is a PCI board including a completely independent system, i.e. it has a separate operating system with a Web server and SNMP agent and can be driven by an external power supply.

The RSB S2 LP should preferably be installed in the low-profile PCI slot, but can also be installed in the full-height slot.

It is connected to the system board via a data cable and a power cable. The RSB S2 LP enables remote diagnostics for system analysis, remote system configuration, and a remote restart if the operating system fails or if a hardware error occurs.

- ▶ Open the server as described in the chapter “Preparation” on page 15f.
- ▶ Remove the riser card holder (see page 40).
- ▶ Plug the supplied power cable into the J302 connector on the RSB S2 LP.
- ▶ Plug the supplied data cable into the J104 connector on the RSB S2 LP.

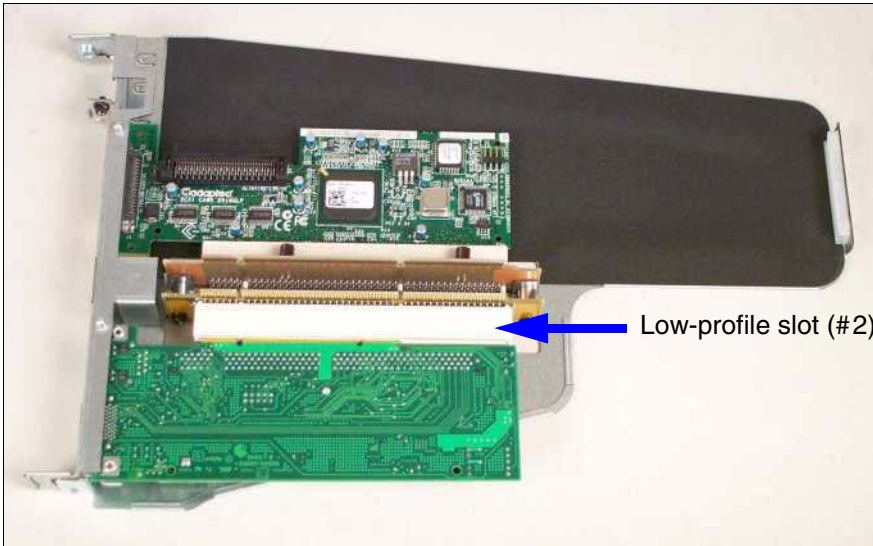

Figure 24: Installing the RSB S2 LP

- ▶ Remove the slot cover.

i Keep the slot cover for future use. If you remove the RSB S2 without installing a new one, you must reinstall the slot cover to comply with EMC regulations (regulations on electromagnetic compatibility) and to satisfy cooling requirements and fire protection measures.

- ▶ Install the RSB S2 LP in the low-profile PCI slot (#2) of the riser card. The procedure is described in the section “Installing controllers” on page 40.
- ▶ Plug the power cable into the CN7 connector of the system board.

i The position of the connectors is described in the “Technical Manual of the System Board D1790”.

- ▶ Plug the data cable into the CN6 socket (IPMB) of the system board.
- ▶ Install the riser card holder (see page 41).
- ▶ Close the server, plug in the power plugs, and switch on the server as described in the chapter “Completion” on page 45f.

10 Completion



CAUTION!

Please observe the safety information in the chapter “Safety Instructions” on page 9ff.

10.1 Closing the server

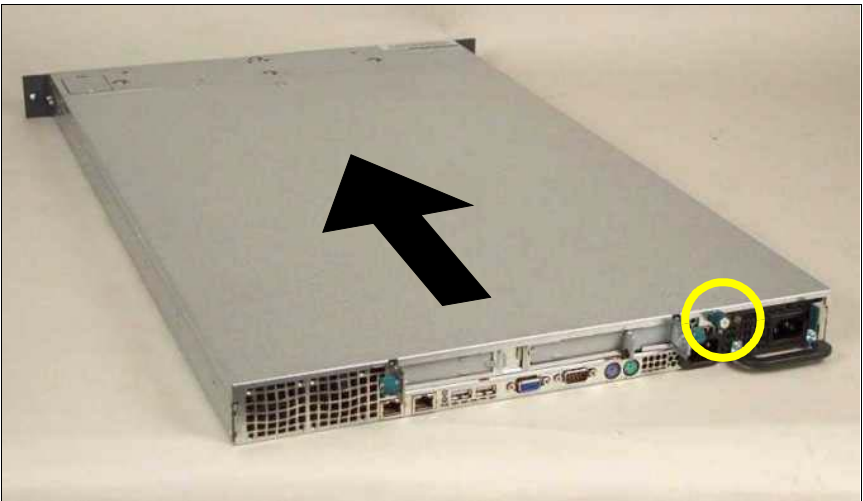

Figure 25: Installing the cover

- ▶ Position the cover in such a way that the rear edge protrudes 3-4 cm from the housing.
- ▶ Push the cover to the front as far as it will go.
- ▶ Attach the cover with the knurled screw (see circle in figure) at the back of the housing.
- ▶ Install the server in the rack.



How to install the server in the rack is described in the operating manual.

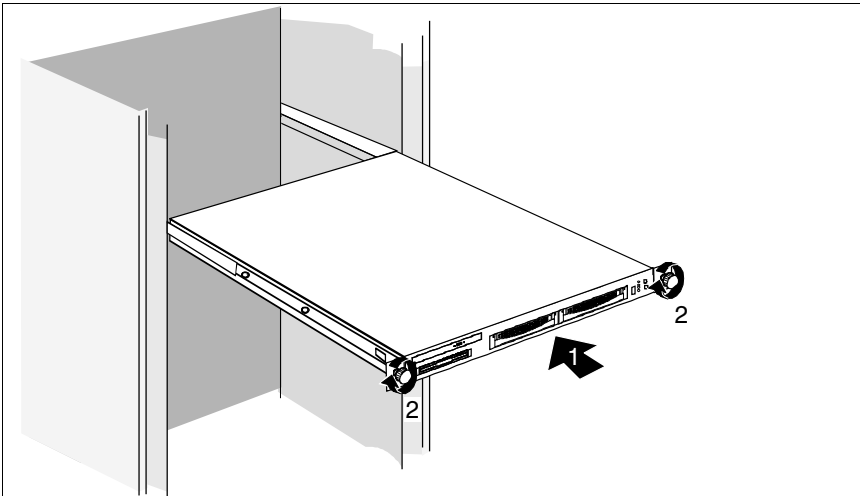

Figure 26: Installing the server

- ▶ Slide the server into the rack (1).



After you have inserted the server, you should pull it out again as far as it will go and then push it back in. This ensures that the server runs cleanly on the telescopic rails.

- ▶ Fasten the server at the front using the two knurled screws (2).
- ▶ Plug in the power plugs and switch the server on.

Abbreviations

AC

Alternating Current

ANSI

American National Standards Institute

ASR&R

Automatic Server Reconfiguration and Restart

BIOS

Basic Input/Output System

BMC

Baseboard Management Controller

CC

Cache Coherency

CD

Compact Disk

CD-ROM

Compact Disk Read-Only Memory

CHS

Cylinder Head Sector

CMOS

Complementary Metal Oxide Semiconductor

COM

Communication

CPU

Central Processing Unit

DC

Direct Current

Abbreviations

DIMM

Dual Inline Memory Module

DIP

Dual Inline Package

DMA

Direct Memory Access

DMI

Desktop Management Interface

ECC

Error Checking and Correcting

ECP

Extended Capabilities Port

EEPROM

Electrically Erasable Programmable Read-Only Memory

EMC

ElectroMagnetic Compatibility

EMP

Emergency Management Port

EPP

Enhanced Parallel Port

ESD

Electrostatic-Sensitive Devices

FPC

Front Panel Controller

FRU

Field Replaceable Unit

FSB

Front Side Bus

GAM	Global Array Manager
GUI	Graphical User Interface
HDD	Hard Disk Drive
HSC	Hot-Swap Controller
I²C	Inter-Integrated Circuit
I/O	Input/Output
ICM	Intelligent Chassis Management
ID	Identification
IDE	Integrated Drive Electronics
IRQ	Interrupt Request Line
LAN	Local Area Network
LBA	Logical Block Address
LCD	Liquid Crystal Display
LUN	Logical Unit Number

Abbreviations

LVD	Low-Voltage Differential SCSI
MMF	Multi-Mode Fiber
MRL	Manual-Retention Latch
NMI	Non-Maskable Interrupt
NVRAM	Non-Volatile Random Access Memory
OS	Operating System
PCI	Peripheral Component Interconnect
PDA	Prefailure Detection and Analysis
POST	Power-ON Self-Test
RAID	Redundant Arrays of Independent Disks
RAM	Random Access Memory
ROM	Read-Only Memory
RSB	Remote Service Board
RTC	Real-Time Clock

RTDS

Remote Test and Diagnosis System

SAF-TE

SCSI Accessed Fault-Tolerance Enclosures

SBE

Single-Bit Error

SCA

Single-Connector Attachment

SCSI

Small Computer System Interface

SDR

Sensor Data Record

SDRAM

Synchronous Dynamic Random Access Memory

SEL

System Event Log

SMI

System Management Interrupt

SSU

System Setup Utility

SVGA

Super Video Graphics Adapter

USB

Universal Serial Bus

VGA

Video Graphics Adapter

ZCR

Zero Channel RAID

Related publications

PRIMERGY manuals are available as PDF file on the ServerBooks CD. The **ServerBooks** CD is part of the **ServerStart Bundle** delivered with each server system.

The actual version of the necessary manuals can be downloaded free of charge from the Internet. The overview page showing the online documentation available in the Internet can be found via the URL:

<http://manuals.fujitsu-siemens.com> (choose: intel based servers.)

- [1] **Safety**
- [2] **Warranty**
- [3] **19 inch rack**
Technical Manual
- [4] **DataCenter Rack**
Technical Manual
- [5] **PRIMECENTER Rack**
Technical Manual
- [6] **LocalView**
User Manual
- [7] **ServerView**
Server Management
User Manual
- [8] **ServerView Extension**
ServerView Extension for HP OpenView NNM
- [9] **ServerView/Plus for Tivoli**
- [10] **RemoteView**
User Manual
- [11] **RemoteView Service Board S2/S2 LP 1.x**
Mounting and Setting Up
User's Guide

Related publications

- [12] **PRIMERGY ServerView Suite**
ServerStart
- [13] **PRIMERGY RX200 S2**
Service Supplement
- [14] **System Board D1790**
Technical Manual
- [15] **BIOS-Setup**
Reference Manual
- [16] **Integrated Mirroring**
User's Guide
- [17] **Global Array Manager Client Software**
User's Guide
- [18] **Global Array Manager Server Software**
User's Guide
- [19] **Ergonomics**
- [20] **Configurator**
For partners and distributors only:
<http://extranet.fujitsu-siemens.com/cafe/products/primergy>

Index

A

- accessible drives 3
- additional documentation 1

B

- batteries 12

C

- CD-ROM/DVD drive
 - installation 33
 - upgrade 32
- controller 4
 - upgrade 40
- cover
 - installation 45
 - removal 16

D

- dual-processor mode 19
- dummy cover 32, 35

E

- EGB label 13
- electrostatic sensitive devices 13
- ESD 13
- ESD label 13
- exchange
 - main memory 18
 - processor 24

F

- floppy disk drive
 - upgrade 35

H

- heat sink
 - exchange 27
 - installation 23
 - removing the dummy 21

I

- information material 2

installation

- CD-ROM/DVD drive 33
 - cover 45
 - RemoteView Service Board S2 LP 43
- riser card holder 41
- ventilation duct 23

L

- light-emitting diode (LED) 13
- lithium battery
 - exchange 12
- LocalView module 3
 - upgrade 30

M

- main memory
 - exchange 18
 - upgrade 3, 18
- meaning of the symbols 5
- multiprocessor operating system 19

N

- notational conventions 5
- notes
 - on handling CDs 12
 - on the laser 13

P

- PCI board
 - upgrade 40
- processor
 - exchange 24
 - installation 19, 21
 - module 21
 - upgrade 3

R

- RemoteView 4
- RemoteView Service Board S2 LP
 - installation 43

Index

- introduction 4
- removal
 - cover 16
 - riser card holder 40
 - ventilation duct 20
- riser card holder
 - installation 41
 - removal 40

T

- target group 1

U

- upgrade
 - CD-ROM/DVD drive 32
 - controller 40
 - floppy disk drive 35
 - LocalView module 30
 - main memory 18
 - PCI board 40

V

- ventilation duct
 - installation 23
 - removal 20

Fujitsu Siemens Computers GmbH
User Documentation
33094 Paderborn
Germany

Fax: 0 700 / 372 00001

email: manuals@fujitsu-siemens.com
<http://manuals.fujitsu-siemens.com>

Submitted by

Comments on PRIMERGY RX200 S2
Serversystem

Comments
Suggestions
Corrections



Fujitsu Siemens Computers GmbH
User Documentation
33094 Paderborn
Germany

Comments
Suggestions
Corrections

Fax: 0 700 / 372 00001

email: manuals@fujitsu-siemens.com
<http://manuals.fujitsu-siemens.com>

Submitted by

Comments on PRIMERGY RX200 S2
Serversystem



Free Manuals Download Website

<http://myh66.com>

<http://usermanuals.us>

<http://www.somanuals.com>

<http://www.4manuals.cc>

<http://www.manual-lib.com>

<http://www.404manual.com>

<http://www.luxmanual.com>

<http://aubethermostatmanual.com>

Golf course search by state

<http://golfingnear.com>

Email search by domain

<http://emailbydomain.com>

Auto manuals search

<http://auto.somanuals.com>

TV manuals search

<http://tv.somanuals.com>