

FUJIOH

Operation Manual RANGE HOOD

MODEL: BUF-011/021

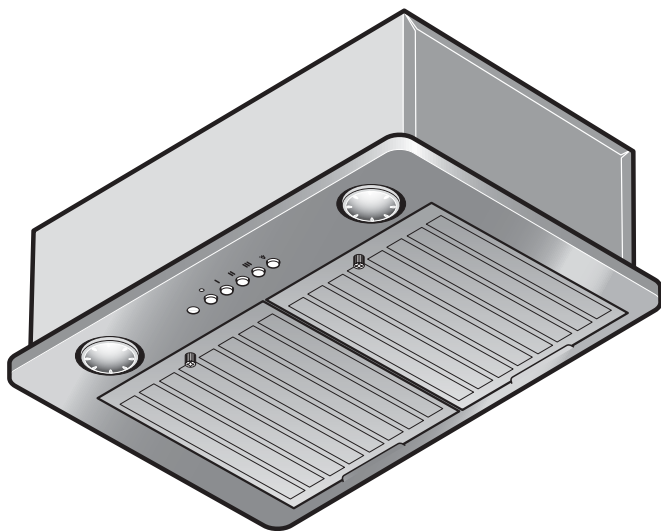
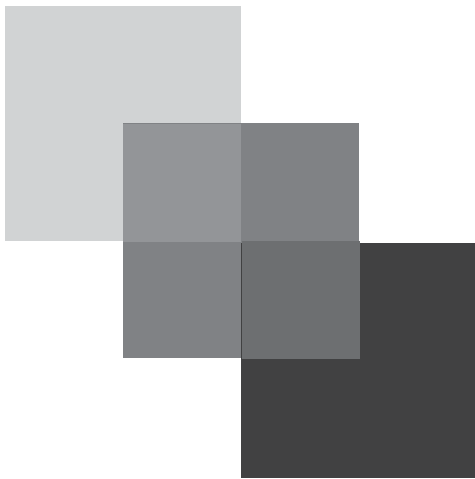

TABLE OF CONTENTS

Safety Instructions	2
Name of Parts	4
Operating the Range Hood	4
How to Use	5
Care and Maintenance	6
Disassembling	7
Cleaning	7
Re-assembling	7
Replacing the Light Bulb	8
Requesting Service	9
Prior to Requesting Service	9
Inspection Label	9
Specifications	10
Circuit Diagram	10
Parts List	11
Limited Product Warranty	12

READ AND SAVE THESE INSTRUCTIONS.
 Keep this manual in a convenient place for future reference.

FUJI INDUSTRIAL CO., LTD.

Fujioh at kitchen::accessories

SAFETY INSTRUCTIONS

Before installation and operation, read these instructions carefully and use this product only in the manner described by the manufacturer in the operation manual.

The signal words shown below are used to alert you to potential personal injury and property damage hazards.

There are three hazard classifications based on potentially dangerous situations.







Obey all safety instructions that show these symbols to avoid possible injury, death and property damage.

 **WARNING:** WARNING indicates a potentially hazardous situation which, if not avoided, could result in death or serious injury.







 **CAUTION:** CAUTION indicates a potentially hazardous situation which, if not avoided, may result in minor or moderate injury.

CAUTION: CAUTION used without the safety alert symbol indicates a potentially hazardous situation which, if not avoided, may result in property damage.

WARNING

- | | |
|---|---|
|  | <p>1. TO REDUCE THE RISK OF FIRE, ELECTRIC SHOCK, OR INJURY TO PERSONS, OBSERVE THE FOLLOWING:</p> <p>a) Use this unit only in the manner intended by the manufacturer. If you have questions, contact the manufacturer.</p> <p>b) Before servicing or cleaning the unit, switch power off at service panel and lock the service disconnecting means to prevent power from being switched on accidentally. When the service disconnecting means cannot be locked, securely fasten a prominent warning device, such as a tag, to the service panel.</p> |
|  | <p>2. TO REDUCE THE RISK OF A RANGE TOP GREASE FIRE:</p> <p>a) Never leave surface units unattended at high settings. Boilovers cause smoking and greasy spillovers that may ignite. Heat oils slowly on low or medium settings.</p> <p>b) Always turn hood ON when cooking at high heat or when flambeing foods (i.e. Crepes Suzette, Cherries Jubilee, Peppercorn Beef Flambe).</p> <p>c) Clean ventilating fans frequently. Grease should not be allowed to accumulate on fan or filter.</p> <p>d) Use proper pan size. Always use cookware appropriate for the size of the surface element.</p> |
|  | <p>3. TO REDUCE THE RISK OF INJURY TO PERSONS IN THE EVENT OF A RANGE TOP GREASE FIRE, OBSERVE THE FOLLOWING:</p> <p>a) SMOTHER FLAMES with a close-fitting lid, cookie sheet, or metal tray, then turn off the burner. BE CAREFUL TO PREVENT BURNS. If the flames do not go out immediately, EVACUATE AND CALL THE FIRE DEPARTMENT.</p> <p>b) NEVER PICK UP A FLAMING PAN - you may be burned.</p> <p>c) DO NOT USE WATER, including wet dishcloths or towels - a violent steam explosion will result.</p> <p>d) Use an extinguisher ONLY if:</p> <ol style="list-style-type: none"> 1) You have a class ABC extinguisher, and know how to operate it. 2) The fire is small and contained in the area where it started. 3) The fire department is being called. 4) You can fight the fire with your back to an exit. |
|  | <p>4. Do not place any electrical parts in water or spray water on them. Such a situation could result in fire or electrical shock.</p> |
|  | <p>5. In the situation of a potential gas leakage, do not switch the unit on and off as it could result in a gas explosion.</p> |
|  | <p>6. Do not attempt to modify or repair this product. Refer all servicing to qualified personnel, otherwise it may result in fire, electric shock, or injury.</p> |

⚠ CAUTION

- | | |
|---|---|
|  | 1. For general ventilating use only. Do not use to exhaust hazardous or explosive material and vapors. |
|  | 2. To reduce the risk of fire and to properly exhaust air, be sure to duct air outside. Do not vent exhaust air into spaces within walls, ceilings or into attics, crawl spaces or garages. |
|  | 3. Read specification label on this product for further information and requirements. |
|  | 4. Switch power off at the service panel when you won't be using the range hood for a long period. If you do not do so, damage to the electrical insulation may result. |
|  | 5. Fasten the filter and other parts securely. Incorrect attachment may result in personal injury or damage to property. |
|  | 6. Do not use a commercially sold filter or filter cover on the filter part as it may affect its performance and cause trouble. |
|  | 7. To protect hands from injury from the edges of the sheet metal, wear working gloves while servicing. |

NOTE: The safety instructions are explained with the following pictographic symbols.



⊘ : means prohibition. It indicates actions, if any, that mustn't be done.



● : means forcible execution. It indicates actions, if any, that must be done.

name of parts

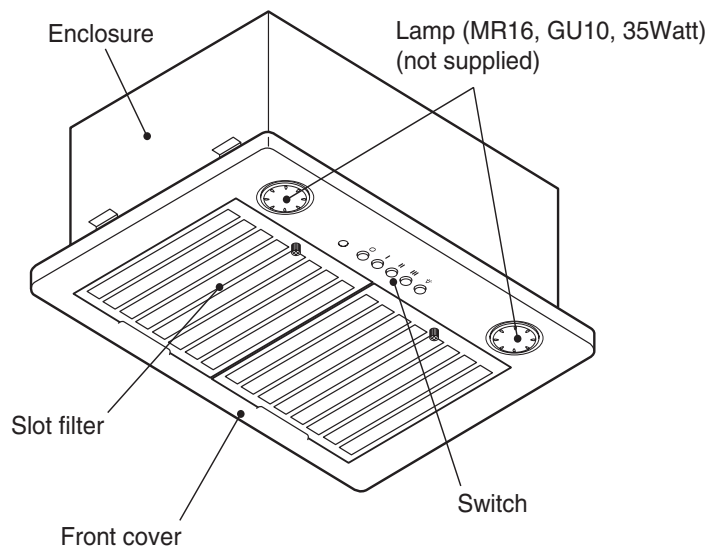

● Control Switches

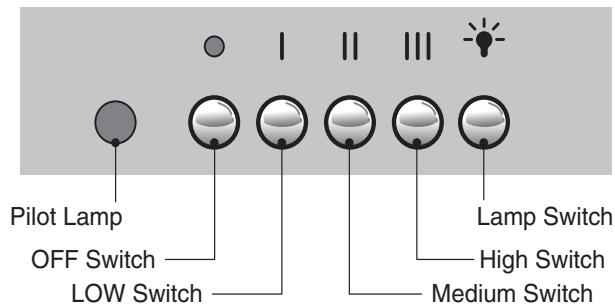

operating the Range Hood

The range hood has five control switch buttons on its front cover.

1 Push one of the switches (I, II, III) according to your cooking need. The fan will start rotating.

I (Low) ————— In case of light cooking

II (Medium) ——— Usual position

III (High) ——— In case of heavy cooking

2 To stop the fan, just push the ● button.

3 Push the ✨ button if you want to turn the light on. To turn it off, push the button again.

how to use

Before operation, make sure that the screws of the filters are tightened securely.

CAUTION

- During cooking, do not touch the filters or their screws. If the filters are attached incorrectly, they may become detached and fall down.
- Do not touch the lamps or their peripheral areas when they are ON, or your hand may be burned as they get hot.

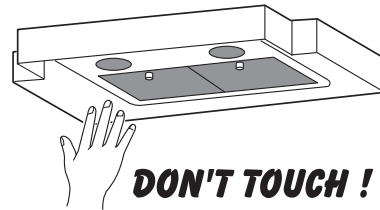

- Do not use a gas range with nothing on the burners. Otherwise the range hood could become overheated and it might be a cause of failure.

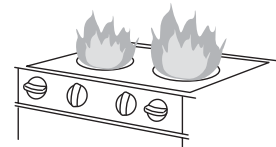

- Stop running the range hood immediately if a fire occurs while cooking. Continued operation of the range hood will add intensity to the fire.

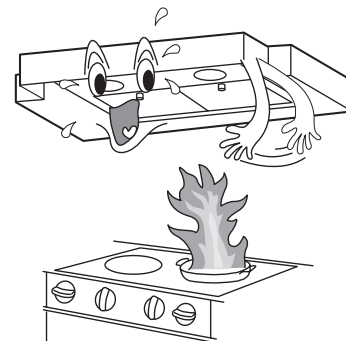

Care and maintenance

Clean the range hood as many times as possible (especially, clean the filter once a month) as it becomes dirty and deteriorates in function if it's left unclean. For a family size of 4 to 5 people and cooking twice a day, clean the filter once every two weeks to avoid grease contamination and grease build-up, which is difficult to clean.

CAUTION

- Before replacing the light bulb or cleaning the range hood, be sure to set the lamp and off switches to the OFF position, then switch off the breaker of service panel.
- For safety, always wear working gloves, safety glasses or goggles while cleaning the filter, etc.
- Keep people away when cleaning to avoid injury from unexpected falling of filter or splashing of detergent.

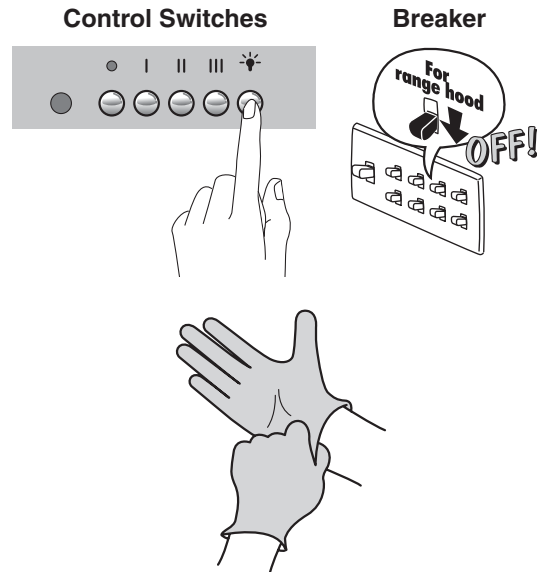

CAUTION

- Do not splash water on the electric parts such as the switch or connectors. Do not use a spray type detergent to clean electric parts. It may cause trouble.

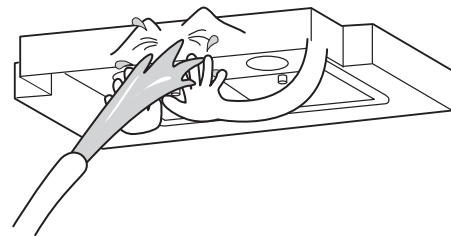

- Do not use solvents such as thinner, benzine or the like and polishing powder for cleaning the painted surfaces, face plates, etc. as these parts may become lusterless or scratched.



- Do not wash parts with a hard brush or the like for cleaning as they can cause damage.

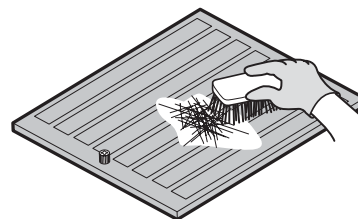

disassembling

Filter

First, loosen the knob holding the filter, then slide it in the direction of the arrow to disengage from the catches.

NOTE: As the filter may have grease built-up, be careful when removing it.

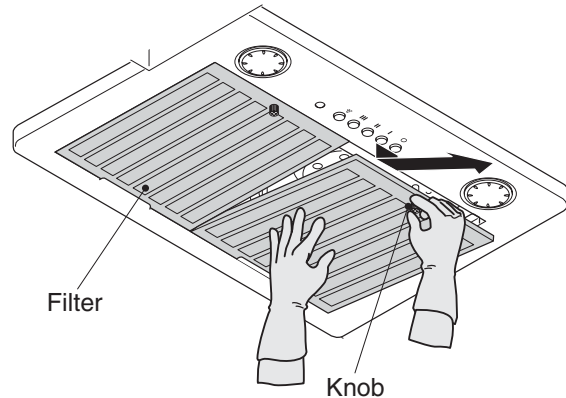

cleaning

1 Filter

After immersing the filter in water with a mild detergent for 30 to 40 minutes, wash it with a toothbrush or the like to remove dirt. Clean the filter frequently to avoid grease contamination and grease build-up, which is difficult to clean.

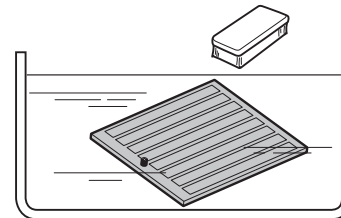

2 Front Cover

After wiping the front cover off with a cloth immersed in a mild detergent, wipe off moisture thoroughly with a dry cloth.

NOTE: The stainless type of the front cover is clear coated to avoid greasy dirt. Be careful not to scour strongly when cleaning as it may be scratched or discolored.

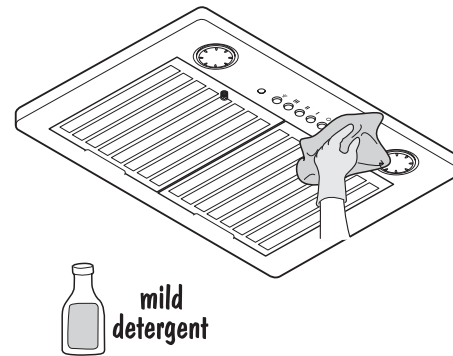

re-assembling

Re-assembly will be done by following the opposite way of disassembly procedure described in Item “disassembling”.

- (1) Make sure that the filter is fixed in the appropriate position firmly.
- (2) Make sure that there is no abnormal vibration sound when running.

replacing the light bulb

Two 35W halogen light bulbs can be installed in this range hood.

Prior to replacing the light bulb, purchase a halogen light bulb (Bulb type MR16, GU10), rated 120V - 35W or below.

1 To remove the light bulb, push and turn it counterclockwise. Then, replace the light bulb with a new one.

NOTE:

- When replacing the bulb, wait until it has cooled off before removing, or you may burn your hand.
- When installing the bulb, be sure to fix to the socket securely.

● To remove the light bulb

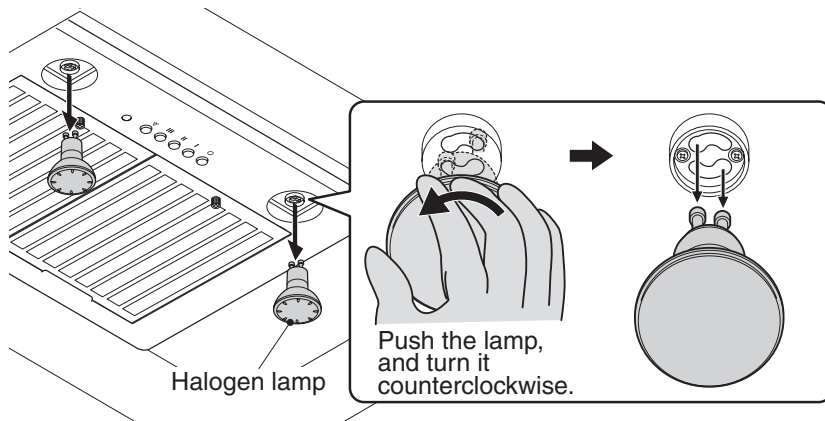

● To install the light bulb

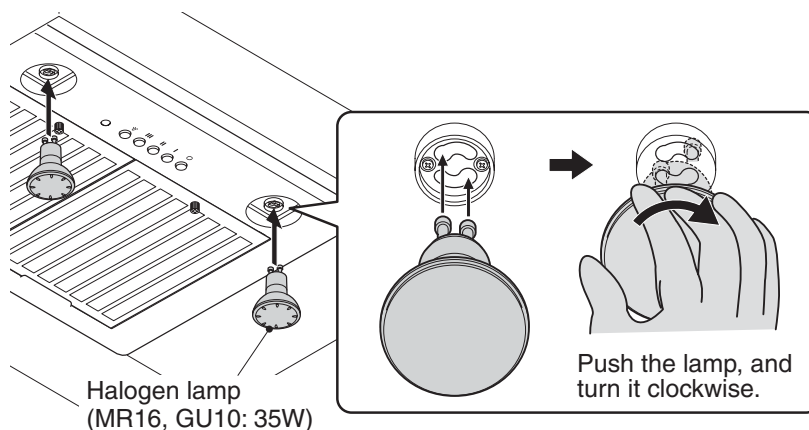

specifications

Refer to the following table.

Model	Voltage (V)	Frequency (Hz)	Speed	Power Consumption (W)	Air Flow (CFM)		Noise Level (dB)	Weight (lbs)
					at 0 Pa	at 25 Pa		
BUF-011	120	60	Hi	100	260	240	48.0	18
			Me	70	200	170	41.0	
			Lo	30	100	70	27.0	
BUF-021	120	60	Hi	230	370	350	56.0	18
			Me	160	230	200	44.5	
			Lo	125	150	120	35.5	

NOTE

FUJI INDUSTRIAL CO., LTD. has measured airflow under HVI-916 and noise levels under Japanese Industrial Standard (JIS) C9603 items 8.8 and 8.9.

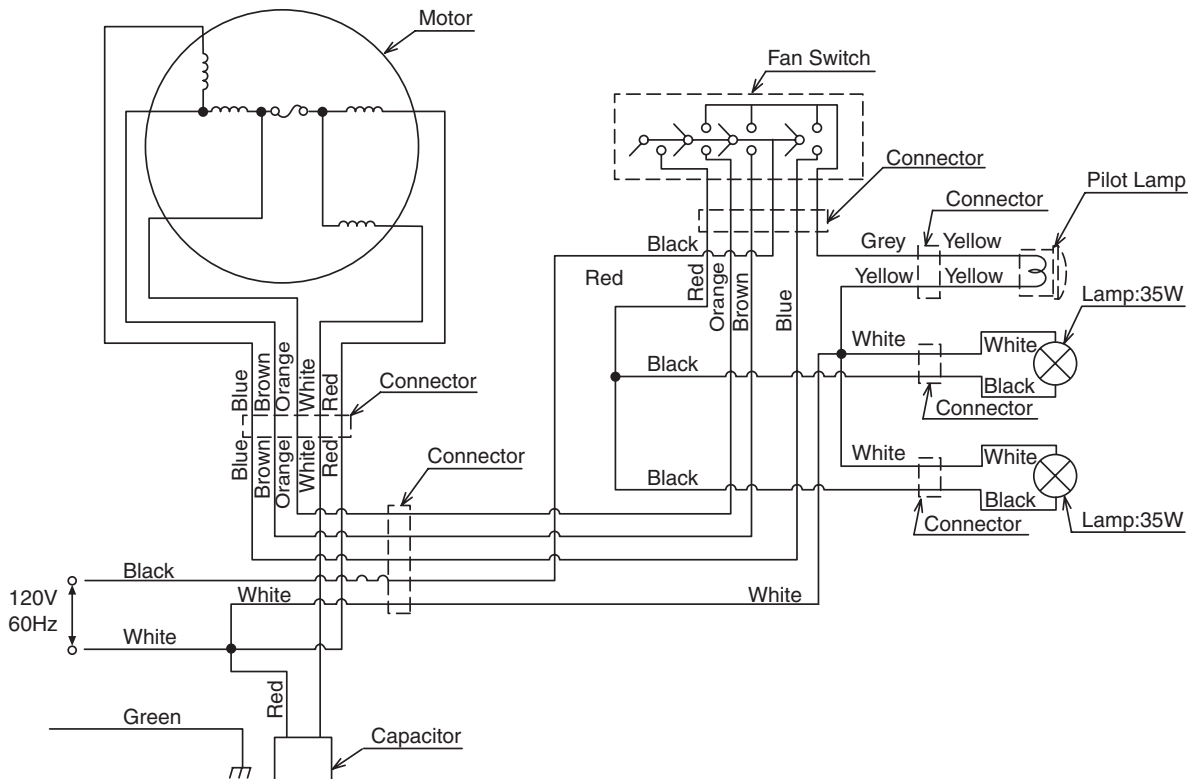

circuit diagram

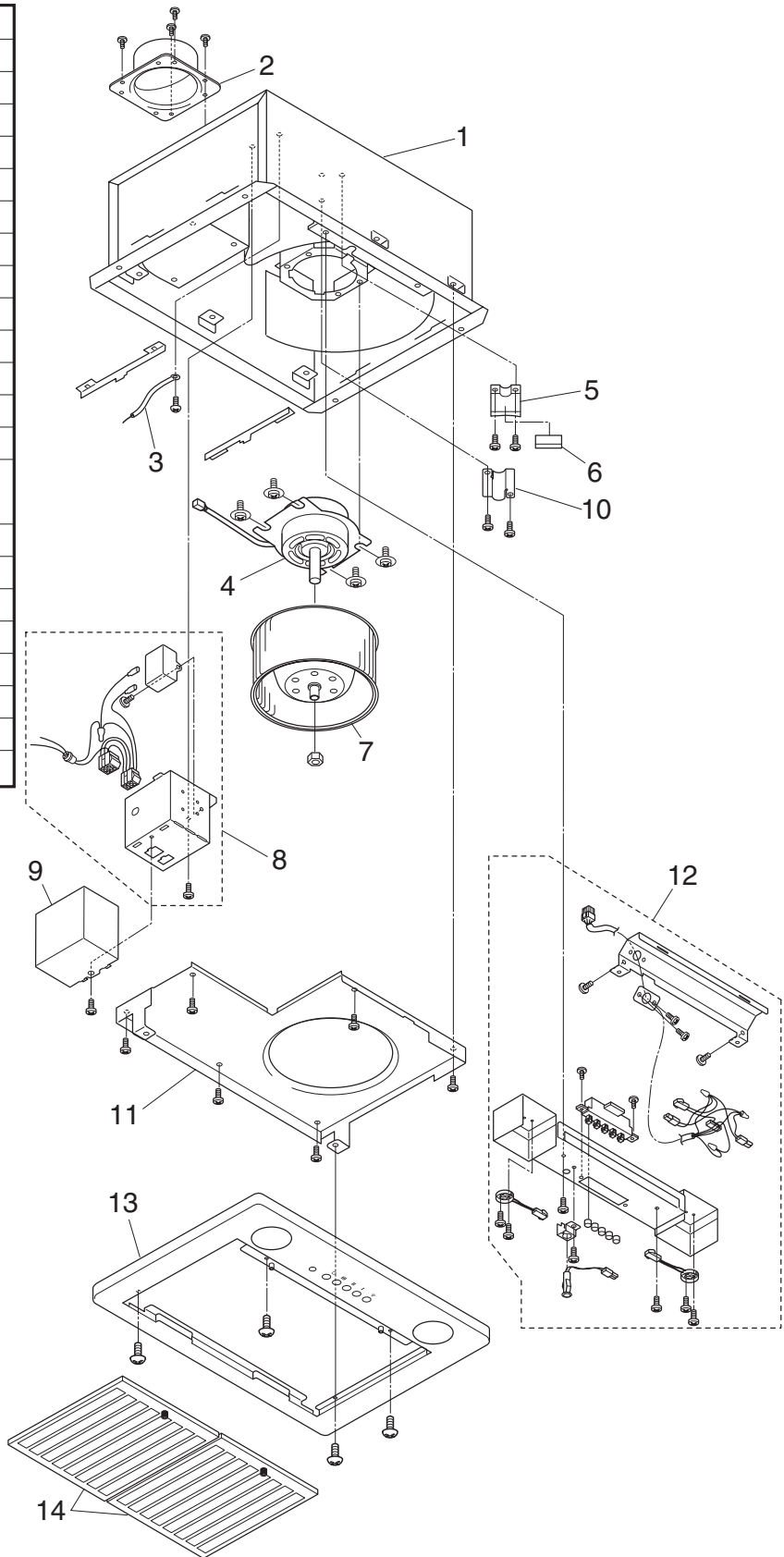

parts list

No.	Component / Part
1	Enclosure
2	Exhaust Pipe Unit
3	Earth Wire Unit
4	Motor
5	Wire Holder
6	Seal
7	Sirocco Fan
8	Wire Box Unit
9	Wire Cover
10	Motor Wire Cover
11	Partition Board
12	Switch Box Unit
	(For Clear Coated Stainless)
	(For White, Black, Biscuit and Silver Metallic)
13	Front Cover
	(White)
	(Black)
	(Biscuit)
	(Silver Metallic)
	(Clear Coated Stainless)
14	Filter
15	Attachment



Attachment	
Name of parts	Figure
Screw M5 × 30	 Four(4) Pieces
Nut with plate M5	 Four(4) Pieces

limited product warranty

The Fujioh product warranty is to the original purchaser (consumer) of its products only and is not transferable. Fujioh warrants that its products will be free from defects in materials or workmanship for a period of three years from the date of original purchase. THERE ARE NO OTHER WARRANTIES, EXPRESS OR IMPLIED, INCLUDING, BUT NOT LIMITED TO, IMPLIED WARRANTIES OF MERCHANTABILITY OR FITNESS FOR A PARTICULAR PURPOSE.

During this three year warranty period, Fujioh will, at its option, repair or replace, free of charge, any product or part that is found to be defective under normal use and service.

This warranty does not cover: (1) Normal maintenance and service; or (2) Any products or parts that have been subject to misuse, negligence, accident, improper maintenance or repair, faulty installation or installation not in accordance to recommended installation instructions. (3) Light Bulbs.

The duration of any implied warranty is also limited to the three year period as specified above for the express warranty. In that case above limitation may not apply to you.

FUJIOH'S OBLIGATION TO REPAIR OR REPLACE PRODUCT OR PARTS, AT FUJIOH'S OPTION, SHALL BE THE PURCHASER'S SOLE AND EXCLUSIVE REMEDY UNDER THIS WARRANTY. FUJIOH WILL NOT BE LIABLE FOR INDIRECT INCIDENTAL, CONSEQUENTIAL OR SPECIAL DAMAGES ARISING OUT OF OR IN CONNECTION WITH PRODUCT USE OR PERFORMANCE. Some states do not allow the exclusion of incidental or consequential damages. In that case the above limitation may not apply to you.

This warranty gives the original purchaser (consumer) specific legal rights, and there may also be other rights that vary from state. This warranty supersedes all prior warranties.

To qualify for warranty service, first; (1) Notify Fujioh at the address shown below or telephone: 1-888-547-9880; (2) Give the model number and part identification and; (3) Describe the nature of any defect in the product or part. At the time warranty service is requested, proof of purchase and evidence showing the original purchase date must be presented.

Keep this book and your sales slip together for future reference. You must provide proof of purchase or installation date for in-warranty service.

Write down the following information about your Range Hood to better help you obtain assistance or service if you ever need it. You will need to know your complete model number and serial number. You can find this information on the Inspection Label, located on your appliance as shown in the Operation Manual "REQUESTING SERVICE".

Dealer Name _____
Address _____
Phone Number _____
Model Number _____
Serial Number _____
Purchase Number _____

Free Manuals Download Website

<http://myh66.com>

<http://usermanuals.us>

<http://www.somanuals.com>

<http://www.4manuals.cc>

<http://www.manual-lib.com>

<http://www.404manual.com>

<http://www.luxmanual.com>

<http://aubethermostatmanual.com>

Golf course search by state

<http://golfingnear.com>

Email search by domain

<http://emailbydomain.com>

Auto manuals search

<http://auto.somanuals.com>

TV manuals search

<http://tv.somanuals.com>