

Use & Care Manual

Visit the frigidaire Web Site at: <http://www.frigidaire.com>

Over-the Range Microwave Oven

TMV151F

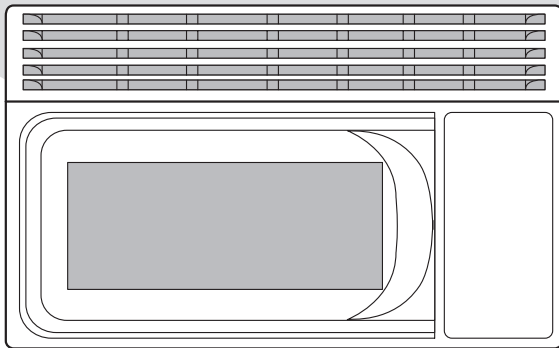









Español.....25

Français.....49

Questions or for Service Call:

1-800-944-9044 (U.S.)

1-800-668-4606 (Canada)

Welcome & Congratulations.....2	
Important Safety Instructions.....3	
Features & Specifications.....7	
Before Operating.....9	
Manual Operation.....10	
Operating Instructions.....14	
Care and Cleaning.....20	
Before You Call.....22 (Troubleshooting Guide)	
Warranty.....24	



Welcome & Congratulations

Congratulations on your purchase of a new range! At Electrolux Home Products, we are very proud of our product and are completely committed to providing you with the best service possible. Your satisfaction is our number one priority.

We know you'll enjoy your new range and Thank You for choosing our product.
We hope you consider us for future purchases.

PLEASE CAREFULLY READ AND SAVE THESE INSTRUCTIONS

This Use & Care Manual provides specific operating instructions for your model. Use your microwave oven only as instructed in this manual. These instructions are not meant to cover every possible condition and situation that may occur. Common sense and caution must be practiced when installing, operating and maintaining any appliance.

Please record your model and serial numbers below for future reference.

Model Number : _____

Serial Number : _____

Purchase Date : _____

This Use & Care Manual contains general operating instructions for your range and feature information for several models. Your microwave oven may not have all the described features. The graphics shown are representational. The graphics on your microwave oven may not look exactly like those shown.



Important Safety Instructions

What You Need to Know About Safety Instructions

Warning and Important Safety Instructions appearing in this Use & Care Guide are not meant to cover all possible conditions and situations that may occur. Common sense, caution, and care must be exercised when installing, maintaining, or operating microwave.

Always contact your dealer, distributor, service agent, or manufacturer about problems or conditions you do not understand.

Recognize Safety Symbols, Words, Labels

DANGER

DANGER – Immediate hazards which **WILL** result in severe personal injury or death.

WARNING

WARNING – Hazards or unsafe practices which **COULD** result in severe personal injury or death.

CAUTION

CAUTION – Hazards or unsafe practices which **COULD** result in minor personal injury.

CAUTION

To avoid personal injury or property damage, observe the following:

1. **Do not** deep fat fry in oven. Fat could overheat and be hazardous to handle.
2. **Do not** cook or reheat eggs in shell or with an unbroken yolk using microwave energy. Pressure may build up and erupt. Pierce yolk with fork or knife before cooking.
3. Pierce skin of potatoes, tomatoes, and similar foods before cooking with microwave energy. When skin is pierced, steam escapes evenly.
4. **Do not** operate oven without load or food in oven cavity.
5. Use only popcorn in packages designed and labeled for microwave use. Popping time varies depending on oven wattage. **Do not** continue to heat after popping has stopped. Popcorn will scorch or burn. **Do not** leave oven unattended.
6. **Do not** use regular cooking thermometers in oven. Most cooking thermometers contain mercury and may cause an electrical arc, malfunction, or damage to oven.
7. **Do not** use metal utensils in oven.
8. **Never** use paper, plastic, or other combustible materials that are not intended for cooking.
9. When cooking with paper, plastic, or other combustible materials, follow manufacturer's recommendations on product use.
10. **Do not** use paper towels which contain nylon or other synthetic fibers. Heated synthetics could melt and cause paper to ignite.
11. **Do not** heat sealed containers or plastic bags in oven. Food or liquid could expand quickly and cause container or bag to break. Pierce or open container or bag before cooking.
12. To avoid pacemaker malfunction, consult physician or pacemaker manufacturer about effects of microwave energy on pacemaker.

SAVE THESE INSTRUCTIONS



Important Safety Instructions

WARNING

To avoid risk of electrical shock or death, this oven must be grounded and plug must not be altered.

Grounding Instructions

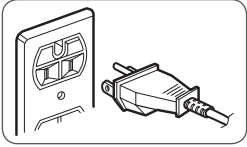

Oven MUST be grounded.

Grounding reduces risk of electric shock by providing an escape wire for the electric current if an electrical short occurs. This oven is equipped

with a cord having a grounding wire with a grounding plug. The plug must be plugged into an outlet that is properly installed and grounded. See Installation Instructions.

Consult a qualified electrician or servicer if grounding instructions are not completely understood, or if doubt exists as to whether the oven is properly grounded.

Do not use an extension cord. If the product power cord is too short, have a qualified electrician install a three-slot receptacle. This oven should be plugged into a separate 60 hertz circuit with the electrical rating as shown in specifications table. When the oven is on a circuit with other equipment, an increase in cooking times may be required and fuses can be blown.

Microwave operates on standard household current, 110-120V.

Federal Communications Commission Radio Frequency Interference Statement (U.S.A. Only)

This equipment generates and uses ISM frequency energy and if not installed and used properly, that is in strict accordance with the manufacturer's instructions, may cause interference to radio and television reception. It has been type tested and found to comply with limits for ISM Equipment pursuant to part 18 of FCC Rules, which are designed to provide reasonable protection against such interference in a residential installation.

However, there is no guarantee that interference will not occur in a particular installation. If this equipment does cause interference to radio or television reception, which can be determined by turning the equipment off and on, the user is encouraged to try to correct the interference by one or more of the following:

- Reorient the receiving antenna of the radio or television.
- Relocate the microwave oven with respect to the receiver.
- Move the microwave oven away from the receiver.
- Plug the microwave oven into a different outlet so that the microwave oven and the receiver are on different branch circuits.

The manufacturer is not responsible for any radio or television interference caused by **unauthorized modification** to this microwave oven. It is the responsibility of the user to correct such interference.

SAVE THESE INSTRUCTIONS



Important Safety Instructions

Precautions to Avoid Possible Exposure to Excessive Microwave Energy

- A. **DO NOT** attempt to operate this oven with the door open since open door operation can result in harmful exposure to microwave energy. It is important not to defeat or tamper with the safety interlocks.
- B. **DO NOT** place any object between the oven front face and the door or allow soil or cleaner residue to accumulate on sealing surfaces.
- C. **DO NOT** operate the oven if it is damaged. It is particularly important that oven door close properly and that there is no damage to:
 - 1. door (bent),
 - 2. hinges and latches (broken or loosened),
 - 3. door seals and sealing surfaces.
- D. Oven should not be adjusted or repaired by anyone except properly qualified service personnel.

WARNING

Liquids such as water, coffee, or tea are able to be overheated beyond the boiling point without appearing to be boiling due to surface tension of the liquid. Visible bubbling or boiling when the container is removed from the microwave oven is not always present. **THIS COULD RESULT IN VERY HOT LIQUIDS SUDDENLY BOILING OVER WHEN A SPOON OR OTHER UTENSIL IS INSERTED INTO THE LIQUID.** To reduce the risk of injury to persons:

1. **Do not** overheat the liquid.
2. Stir the liquid both before and halfway through heating it.
3. **Do not** use straight-sided containers with narrow necks.
4. After heating, allow the container to stand in the microwave oven for a short time before removing the container.
5. Use extreme care when inserting a spoon or other utensil into the container.

SAVE THESE INSTRUCTIONS



Important Safety Instructions

WARNING

When using electrical appliances, basic safety precautions should be followed to reduce the risk of burns, electric shock, fire, or injury to persons or exposure to excessive microwave energy.

1. **READ** all instructions before using oven.
2. **READ AND FOLLOW** the specific "PRECAUTIONS TO AVOID POSSIBLE EXPOSURE TO EXCESSIVE MICROWAVE ENERGY" on page 5.
3. Install or locate this oven **ONLY** in accordance with the installation instructions in this manual.
4. Some products such as whole eggs and sealed containers—for example, closed glass jars—are able to explode and **SHOULD NOT** be **HEATED** in this oven.
5. Use this oven **ONLY** for its intended use as described in this manual. Do not use corrosive chemicals or vapors in this oven. This type of oven is specifically designed to heat, cook, or dry food. It is not designed for industrial or laboratory use.
6. As with any appliance, **CLOSE SUPERVISION** is necessary when used by **CHILDREN** or **INFIRM PERSONS**.
7. See door cleaning instructions in the Care and Cleaning section on page 20.
8. Baby food jars shall be open when heated and contents stirred or shaken before consumption, in order to avoid burns.
9. **DO NOT** use this oven for commercial purposes. It is made for household use only.
10. **DO NOT** heat baby bottles in oven.
11. **DO NOT** operate this oven if it has a damaged cord or plug, if it is not working properly, or if it has been damaged or dropped.
12. This oven, including power cord, must be serviced **ONLY** by qualified service personnel. Special tools are required to service oven. Contact nearest authorized service facility for examination, repair, or adjustment.
13. **DO NOT** cover or block filter or other openings on oven.
14. **DO NOT** store this oven outdoors. **DO NOT** use this product near water – for example, near a kitchen sink, in a wet basement, near a swimming pool or similar locations.
15. **DO NOT** immerse cord or plug in water.
16. Keep cord **AWAY** from **HEATED** surfaces.
17. **DO NOT** let cord hang over edge of table or counter.
18. Clean the ventilating hood frequently.
19. **DO NOT** allow grease to accumulate on the hood or filters.
20. Use care when cleaning the ventilating hood filters. Corrosive cleaning agents such as lye-based oven cleaners may damage the filters.
21. When flaming foods under the hood, turn the fan on.
22. Suitable for use above both gas and electric cooking equipment 36 inches or less wide.

CAUTION

To avoid risk of fire in the oven cavity:

- a. **DO NOT** overcook food. Carefully attend oven when paper, plastic, or other combustible materials are placed inside the oven to facilitate cooking.
- b. Remove wire twist-ties from paper or plastic bags before placing bag in oven.
- c. If materials inside the oven ignite, keep oven door **CLOSED**, turn oven off and disconnect the power cord, or shut off power at the fuse or circuit breaker panel.
- d. **DO NOT** use the cavity for storage. **DO NOT** leave paper products, cooking utensils, or food in the cavity when not in use.

SAVE THESE INSTRUCTIONS



Features & Specifications

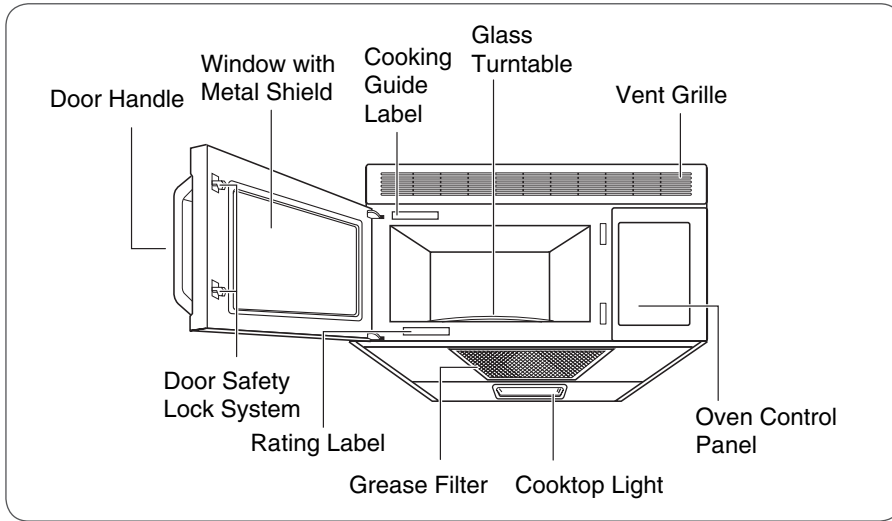

OVEN SPECIFICATIONS

Power Supply	120 VAC, 60 Hz
Input Power	1,650 W
Cooking Power	1,000 W (IEC 60705 Standard)
Frequency	2,450 MHz
Rated Current	14.5 A
Outer Dimensions (WxHxD)	29 7/8" x 16 1/2" x 15"
Cavity Volume	1.5 Cu. Ft.
Net Weight	45.4 lbs.

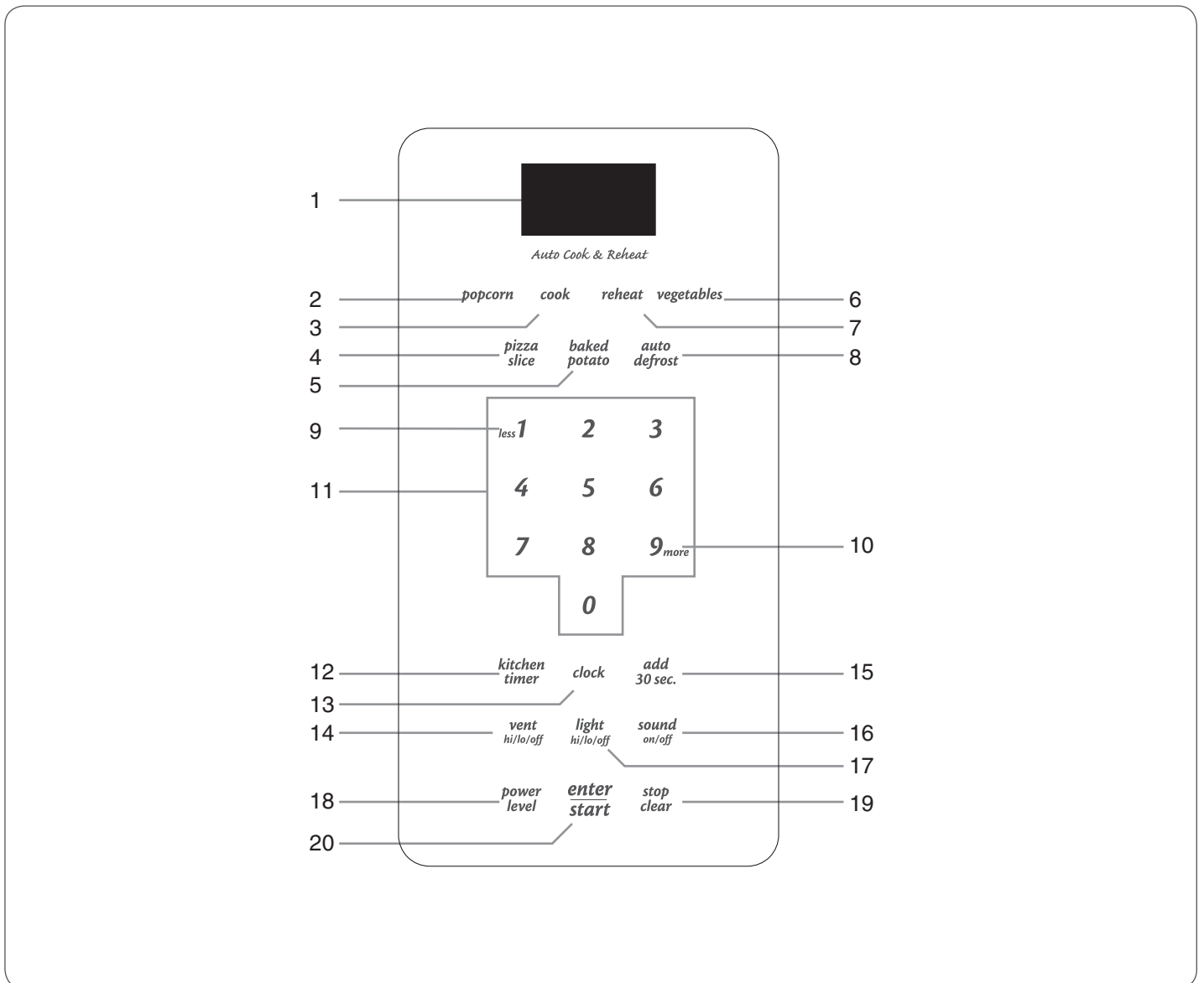



Features & Specifications

FEATURES

- 1. DISPLAY:** The Display includes a clock and indicators to tell you time of day, cooking time settings and cooking functions selected.
- 2. POPCORN:** Touch this pad when popping popcorn in your microwave oven. See page 14 for more information.
- 3. COOK:** Touch this pad to cook beverage, bacon, frozen dinner, frozen breakfast. See page 15 for more information.
- 4. PIZZA SLICE:** Touch this pad to reheat pizza. See page 14 for more information.
- 5. BAKED POTATO:** Touch this pad to cook potatoes. See page 14 for more information.
- 6. VEGETABLES:** Touch this pad to cook fresh vegetables, frozen vegetables. See page 14 for more information.
- 7. REHEAT:** Touch this pad to reheat dinner plate, casserole, and pasta. See page 16 for more information.
- 8. AUTO DEFROST:** Touch this pad to defrost food by weight. See page 17 for more information.
- 9. LESS:** Touch this pad to subtract the cooking time. See page 11 for more information.
- 10. MORE:** Touch this pad to add more cooking time. See page 11 for more information.
- 11. NUMBER:** Touch number pads to enter cooking time, power level, quantities, or weights.
- 12. KITCHEN TIMER:** Touch this pad to set the kitchen timer. See page 10 for more information.
- 13. CLOCK:** Touch this pad to enter the time of day. See page 9 for more information.
- 14. VENT HI/LO/OFF:** Touch this pad to turn the fan on or off. See page 10 for more information.
- 15. ADD 30 SEC:** Touch this pad to set and start quickly at 100% power level. See page 10 for more information.
- 16. SOUND ON/OFF:** Touch this pad to turn off the sound. OFF will appear in the display.
- 17. LIGHT HI/LO/OFF:** Touch this pad to turn on the cooktop light. See page 10 for more information.
- 18. POWER LEVEL:** Touch this pad to select a cooking power level.
- 19. STOP/CLEAR:** Touch this pad to stop the oven or to clear all entries.
- 20. ENTER/START:** Touch this pad to start a function. If you open the door after oven begins to cook, close door and touch ENTER/START again.



Before Operating

LEARN ABOUT YOUR MICROWAVE OVEN

This section introduces you to the basics you need to know to operate your microwave oven. Please read this information before use.

⚠ CAUTION

- To avoid risk of personal injury or property damage, do not run oven empty.
- To avoid risk of personal injury or property damage, do not use stoneware, aluminum foil, metal utensils, or metal trimmed utensils in the oven.

CLOCK

Example: To set 8:00.

- clock* 1. Touch **Clock** pad.
- 8 0 0 2. Enter the time by using the number pads.
- enter start* 3. Touch **ENTER/START** pad.

MICROWAVE UTENSIL GUIDE

USE	DO NOT USE
<p>OVEN PROOF GLASS (treated for high intensity heat): Utility dishes, loaf dishes, pie plates, cake plates, liquid measuring cups, casseroles and bowls without metallic trim.</p> <p>CHINA: Bowls, cups, serving plates and platters without metallic trim.</p> <p>PLASTIC: Plastic wrap (as a cover)-- lay the plastic wrap loosely over the dish and press it to the sides. Vent plastic wrap by turning back one edge slightly to allow excess steam to escape. The dish should be deep enough so that the plastic wrap will not touch the food. As the food heats it may melt the plastic wrap wherever the wrap touches the food. Use plastic dishes, cups, semirigid freezer containers and plastic bags only for short cooking times. Use these with care because the plastic may soften from the heat of the food.</p> <p>PAPER: Paper towels, waxed paper, paper napkins, and paper plates with no metallic trim or design. Look for the manufacturer's label for use in the microwave oven.</p>	<p>METAL UTENSILS: Metal shields the food from microwave energy and produces uneven cooking. Also avoid metal skewers, thermometers or foil trays. Metal utensils can cause arcing, which can damage your microwave oven.</p> <p>METAL DECORATION: Metal-trimmed or metal-banded dinnerware, casserole dishes, etc. The metal trim interferes with normal cooking and may damage the oven.</p> <p>ALUMINUM FOIL: Avoid large sheets of aluminum foil because they hinder cooking and may cause harmful arcing. Use small pieces of foil to shield poultry legs and wings. Keep ALL aluminum foil at least 1 inch from the side walls and door of the oven.</p> <p>WOOD: Wooden bowls and boards will dry out and may split or crack when you use them in the microwave oven. Baskets react in the same way.</p> <p>TIGHTLY COVERED UTENSILS: Be sure to leave openings for steam to escape from covered utensils. Pierce plastic pouches of vegetables or other food items before cooking. Tightly closed pouches could explode.</p> <p>BROWN PAPER: Avoid using brown paper bags. They absorb too much heat and could burn.</p> <p>FLAWED OR CHIPPED UTENSILS: Any utensil that is cracked, flawed, or chipped may break in the oven.</p> <p>METAL TWIST TIES: Remove metal twist ties from plastic or paper bags. They become hot and could cause a fire.</p>



Manual Operation

KITCHEN TIMER

You can use your microwave oven as a timer. Use the Kitchen Timer for timing up to 99 minutes, 99 seconds.

Example: To set for 3 minutes.

- kitchen timer*
1. Touch **Kitchen Timer** pad.
 2. Enter the time by using the number pads.
- 3 0 0
- enter start*
3. Touch **ENTER/START** pad.

When the time is over, you will hear beeps and **End** will display.

SOUND ON/OFF

- sound on/off*
1. Touch **Sound On/off** pad. The display shows On.
- sound on/off*
2. Touch **Sound On/off** pad. The display shows OFF.
- enter start*
3. Touch **ENTER/START** pad. The display returns to the time of day.

VENT HI/LO/OFF

The VENT moves steam and other vapors from the cooking surface. The vent will operate at low speed whenever the oven is on.

- vent hi/lo/off*
- To operate the vent manually: Touch **Vent Hi/Lo/Off** pad once for High fan speed, twice for Low fan speed, or three times to turn the fan off.

NOTE

- If the temperature gets too hot around the microwave oven, the fan in the vent hood will automatically turn on at the LOW setting to cool the oven. The fan will automatically turn off when the internal parts are cool. When this occurs, the vent cannot be turned off.

CHILD LOCK

You may lock the control panel to prevent the microwave from being accidentally started or used by children.

The Child Lock feature is also useful when cleaning the control panel. Child Lock prevents accidental programming when wiping the control panel.

Example: To set the child lock.

- enter start*
- Touch and hold **ENTER/START** pad more than **3 seconds**. **L** will appear in the display window with one beep.

Example: To cancel the child lock.

- enter start*
- Touch and hold **ENTER/START** pad more than **3 seconds**. **L** will disappear and you hear one beep.

LIGHT HI/LO/OFF

- light hi/lo/off*
- Touch **Light Hi/Lo/Off** pad once for bright light, twice for night light, or three times to turn the light off.

ADD 30 SEC.

A time-saving pad, this simplified control lets you quickly set and start microwave cooking without the need to touch the **ENTER/ START** pad at 100% power level.

Example: To set ADD 30 SEC. for 2 minutes.

- add 30 sec.*
- Touch **Add 30 Sec.** pad 4 times. The oven begins cooking and display shows time counting down.



Manual Operation

DEMONSTRATION MODE

You can use the Demonstration mode to see how your microwave oven operates without the oven heating.

0 less 1 Touch **0** pad and **1** pad at the same time.

To turn demo mode off, repeat step 1 above.

MORE/LESS

The **More(9)/Less(1)** pads allow you to adjust pre-set cooking times. They only work in the Reheat, Auto Cooking, Add 30 sec, Time Cook modes. Use the **More(9)/Less(1)** pads only after you have already begun cooking with one of these procedures.

- 9 more* 1. To ADD more time to an automatic cooking procedure: Touch the **More(9)** pad.
- less 1* 2. To REDUCE the time of an automatic cooking procedure: Touch the **Less(1)** pad.

COOKING AT HIGH POWER LEVELS

Example: To cook food for 8 minutes 30 seconds at 100% power.

- 8 3 less 1* 1. Enter the cook time.
- enter start* 2. Touch **ENTER/ START** pad.

When the cook time is over, you will hear four beeps and **End** will display.

COOKING AT LOWER POWER LEVELS

HIGH power cooking does not always give you the best results with foods that need slower cooking, such as roasts, baked goods, or custards. Your oven has 9 power settings in addition to HIGH.

Example: To cook food for 7 minutes 30 seconds at 70% power.

- 7 3 less 1* 1. Enter the cook time.
- power level* 2. Touch **Power Level** pad.
- 7* 3. Enter the power level.
- enter start* 4. Touch **ENTER/ START** pad.

When the cook time is over, you will hear four beeps and **End** will display.

See cooking guide for Power levels, page 12.

COOKING WITH MORE THAN ONE COOK CYCLE

For best results, some recipes call for one Power Level for a certain length of time, and another Power Level for another length of time. Your oven can be set to change from one to another automatically, for up to three cycles at the first cycle is defrost.

Example: To cook food for 3 minutes at 90% power and then 70% power for 7 minutes 30 seconds.

- 3 0 0* 1. Enter the first cook time.
- power level* 2. Touch **Power Level** pad.
- 9 more* 3. Enter the power level.
- 7 3 0* 4. Enter the second cook time.
- power level* 5. Touch **Power Level** pad.
- 7* 6. Enter the power level.
- enter start* 7. Touch **ENTER/ START** pad.

When the cook time is over, you will hear four beeps and **End** will display.



COOKING GUIDE FOR POWER LEVELS

The 9 power levels in addition to HIGH allow you to choose the best power level for the food you are cooking. Below are listed all the power levels, examples of foods best cooked at each level, and the amount of microwave power you are using.

POWER LEVEL	MICROWAVE OUTPUT	USE
10 High	100 %	<ul style="list-style-type: none">• Boil water.• Cook ground beef.• Make candy.• Cook fresh fruits and vegetables.• Cook fish and poultry.• Preheat browning dish.• Reheat beverages.• Bacon slices.
9	90 %	<ul style="list-style-type: none">• Reheat meat slices quickly.• Saute onions, celery, and green pepper.
8	80 %	<ul style="list-style-type: none">• All reheating.• Cook scrambled eggs.
7	70 %	<ul style="list-style-type: none">• Cook breads and cereal products.• Cook cheese dishes, veal.• Cook cakes, muffins, brownies, cupcakes.
6	60 %	<ul style="list-style-type: none">• Cook pasta.
5	50 %	<ul style="list-style-type: none">• Cook meats, whole poultry.• Cook custard.• Cook whole chicken, turkey, spare ribs, rib roast, sirloin roast.
4	40 %	<ul style="list-style-type: none">• Cook less tender cuts of meat.• Reheat frozen convenience foods.
3	30 %	<ul style="list-style-type: none">• Thaw meat, poultry, and seafood.• Cook small quantities of food.• Finish cooking casserole, stew, and some sauces.
2	20 %	<ul style="list-style-type: none">• Soften butter and cream cheese.• Heat small amounts of food.
1	10 %	<ul style="list-style-type: none">• Soften ice cream.• Raise yeast dough.



Getting The Best Cooking Results

To get the best results from your microwave oven, read and follow the guidelines below.

- **Storage Temperature:** Foods taken from the freezer or refrigerator take longer to cook than the same foods at room temperature.
- **Size:** Small pieces of food cook faster than large ones, pieces similar in size and shape cook more evenly. For even cooking, reduce the power level when cooking large pieces of food.
- **Natural Moisture:** Very moist foods cook more evenly because microwave energy is attracted to water molecules.
- **Stir** foods such as casseroles and vegetables from the outside to the center to distribute the heat evenly and speed cooking. Constant stirring is not necessary.
- **Turn over** foods like pork chops, roasts, or whole cauliflower halfway through the cooking time to expose all sides equally to microwave energy.
- **Place** delicate areas of foods, such as asparagus tips, toward the center of the dish.
- **Arrange** unevenly shaped foods, such as chicken pieces or salmon steaks, with the thicker, meatier parts toward the outside of the dish.
- **Shield**, with **small** pieces of aluminum foil, parts of food that may cook quickly, such as wing tips and leg ends of poultry.
- **Let It Stand:** After you remove the food from the microwave, cover food with foil or casserole lid and let it stand to finish cooking in the center and avoid overcooking the outer edges. The length of standing time depends on the density and surface area of the food.
- **Wrapping in waxed paper or paper towel:** Sandwiches and many other foods containing prebaked bread should be wrapped prior to microwaving to prevent drying out.



Operating Instructions

POPCORN

CAUTION

- DO NOT leave microwave oven unattended while popping corn.

Popcorn pad lets you pop 3.0 and 3.5 ounce bags of commercially packaged microwave popcorn. Pop only one package at a time. If you are using a microwave popcorn popper, follow manufacturer's instructions.

To correctly set your microwave oven, follow this chart:

Bag Size-ounces	Times to touch
3.5	Once
3.0 - 3.5	Twice

Example: To pop a 3.5 oz. bag.

- popcorn*
1. Touch **Popcorn** pad once.
 2. The oven will start automatically.

When the cook time is over, you will hear four beeps and **End** will display.

Recommended amounts: 3.0-3.5 ozs.

IMPORTANT

When using Auto Cook, the oven must cool for 5 minutes between uses or food will not cook properly.

BAKED POTATO

The **Baked Potato** pad lets you cook potatoes with the preset times and cook powers. You can choose from 1 to 4 potatoes.

NOTES

- Cooking times based on an average 8-10 oz. potato.
- Before baking, pierce potato with fork several times.
- After baking, let stand for 5 minutes.

Example: To cook 2 potatoes.

- baked potato*
1. Touch **Baked Potato** pad twice.
 2. The oven will start automatically.

When the cook time is over, you will hear four beeps and **End** will display.

Recommended amounts: 1-4 potatoes (about 8-10 ozs. each).

PIZZA SLICE

Pizza Slice pad lets you reheat up to three 3-5 oz. slices of pizza.

Example: To reheat 1 slice of pizza.

- pizza slice*
1. Touch **Pizza Slice** pad once.
 2. The oven will start automatically.

When the cook time is over, you will hear four beeps and **End** will display.

Recommended amounts: 1-3 slices, (about 3-5 ozs. per each slice)

NOTE

Use the **More/Less** pads to fit your temperature preference.

VEGETABLES

The **Vegetables** pad lets you cook Vegetables with the preset times and cook powers.

VEGETABLES provide two preset categories (fresh and frozen) with a choice of 1 to 4 servings for each category.

Example: To cook 2 servings of Frozen vegetables.

- vegetable*
1. Touch **Vegetables** pad twice.
 2. Enter the serving size (1 to 4) using the number pads.
- enter start*
3. Touch **ENTER/START** pad.

When the cook time is over, you will hear four beeps and **End** will display.

NOTE

If food is not thoroughly cooked or reheated when using the Auto Cook feature, complete cooking using a power level and cooking time.

DO NOT continue using the **Auto Cook** pad.



Operating Instructions

COOK

Cook pad provides four preset categories for cooking.

Example: To Cook 8 ozs of Frozen Dinner.

- cook* 1. Touch **Cook** pad three times.
- 3* 2. Touch number pads to enter quantity, serving size or package weight.
- enter start* 3. Touch **ENTER/START** pad.

Category	Times to touch	Display
Beverage	once	Ac-1
Bacon	twice	Ac-2
Frozen Dinner	three times	Ac-3
Frozen Breakfast	four times	Ac-4

When the cook time is over, you will hear four beeps and **End** will display.

COOK TABLE

CATEGORY		DIRECTIONS	AMOUNT
Popcorn		Use only one microwave-only bag of popcorn at a time. Use caution when removing and opening the hot bag from oven. Let oven cool for at least 5 minutes before using again.	3.0-3.5 oz 1 package
Potato		Prick each potato several times with fork. Place on turntable in spoke-like fashion. Let stand 3-5 minutes. Let oven cool for at least 5 minutes before using again. Use More(9) pad when cooking larger potatoes.	1 to 4 potatoes
VEGETABLES	(Fr-1) Fresh Vegetables	Place fresh vegetables in microwave-safe ceramic, glass or plastic dish and add 2-4 Tbs. water. Cover with lid or vented plastic wrap during cooking and stir before standing. Let oven cool for at least 5 minutes before using again. Use More(9) pad when cooking dense vegetables such as carrots or broccoli spears.	1 to 4 servings
	(Fr-2) Frozen Vegetables	Place frozen vegetables in microwave-safe ceramic, glass or plastic dish and add 2-4 Tbs. water. Cover with lid or vented plastic wrap during cooking and stir before standing. Let oven cool for at least 5 minutes before using again. Use More(9) pad when cooking dense vegetables such as carrots or broccoli spears.	1 to 4 servings
Pizza Slice		Put 1-3 slices of pizza on a microwave-safe plate with wide end of slice toward the outside edge of the plate. Do not let slices overlap. Do not cover. Let oven cool for at least 5 minutes before using again. Use More(9) pad to increase reheat time for thick crust pizza.	1 to 3 slices
COOK	(Ac-1) Beverage	Use measuring cup or mug; do not cover. Place the beverage in the oven. After heating, stir well. Let oven cool for at least 5 minutes before using again. Note: <ul style="list-style-type: none"> • Reheat times based on an 8 ounce cup. • Beverage heated with the beverage feature may be very hot. • Remove container with care. 	0.5 cup 1 cup 2 cups
	(Ac-2) Bacon	Place 2 paper towels on plate and arrange bacon on towels, do not overlap. Cover with additional paper towel. Remove paper towel immediately after cooking. Use More(9)/Less(1) pads for desired crispness.	2 to 6 slices
	(Ac-3) Frozen Dinner	Remove food from outer wrapping and follow box instructions for covering and standing. Let oven cool for at least 5 minutes before using again.	8 to 14 oz.
	(Ac-4) Frozen Breakfast	Follow package instructions for covering and standing. Use this pad for frozen sandwich, breakfast entree, etc. Let oven cool for at least 5 minutes before using again.	4 to 8 oz.

NOTE

Desired food temperature varies from person to person. Use the **More(9)/Less(1)** pads to fit your temperature preference.



Operating Instructions

REHEAT

Reheat pad provides three preset categories for reheating.

Example: To reheat 3 servings of Casserole.

- reheat* 1. Touch **Reheat** pad 2 times.
- 3 2. Touch number pads to enter quantity/ servings.
- enter start* 3. Touch **ENTER/START** pad.

Category	Times to touch	Display
Dinner Plate	once	rh-1
Casserole	twice	rh-2
Pasta	3 times	rh-3

When the cook time is over, you will hear four beeps and **End** will display.

REHEAT TABLE

CATEGORY	DIRECTIONS	AMOUNT
Dinner Plate	Use only pre-cooked, refrigerated foods. Cover plate with vented plastic wrap or waxed paper, tucked under plate. If food is not as hot as you prefer after heating with REHEAT, continue heating using time and power. Contents: • 3-4 oz. meat, poultry or fish (up to 6 oz. with bone) • 1/2 cup starch (potatoes, pasta, rice, etc.) • 1/2 cup vegetables (about 3-4 oz.)	1 serving (1 plate)
Casserole	Cover plate with lid or vented plastic wrap. If food is not as hot as you prefer after heating with REHEAT, continue heating using time and power.	1 to 4 servings
Pasta	Stir foods once before serving. Contents: • Casserole-refrigerated foods. (Examples: Beef stew, Lasagna) • Pasta-Canned spaghetti and ravioli, refrigerated foods.	

NOTES

- Desired food temperature varies from person to person. Use the **More(9)/Less(1)** pads to fit your temperature preference.
- Allow food to stand 1 to 5 minutes before serving.



Operating Instructions

AUTO DEFROST

Defrost choices are preset in the oven. The defrost feature provides you with the best defrosting method for frozen foods, because the oven automatically sets the defrosting times according to the weight you enter. For added convenience, the AUTO DEFROST beeps to remind you to check or turn over the food during the defrost cycle.

After touching the **Auto Defrost** pad once, select the food weight. Available weight ranges are 0.1 to 6.0 lbs.

Example: To defrost 1.2 lbs of meat.

auto defrost

1. Touch **Auto Defrost** pad.

less 1 2

2. Enter the weight.

enter start

3. Touch **ENTER/START** pad.



NOTES

- After you touch **ENTER/ START** pad, the display counts down the defrost time. The oven will beep twice during the Defrost cycle. At this time, open the door and turn the food as needed. Remove any portions that have thawed then return frozen portions to the oven and touch **ENTER/START** pad to resume the defrost cycle.
- **The oven will not stop during the BEEP unless the door is opened.**

DEFROSTING GUIDE

Follow the instructions below when defrosting different types of food.

Food	Standard Amount	Procedure
Roast Beef, Pork	2.5-6.0 lbs.	Start with the food placed fat side down. After each stage, turn the food over and shield any warm portions with narrow strips of aluminum foil. Let stand, covered for 15-30 minutes.
Steaks, Chops, Fish	0.5-3.0 lbs.	After each stage, rearrange the food. If there are any warm or thawed portions of food, shield them with narrow flat pieces of aluminum foil. Remove any pieces of food that are nearly defrosted. Let stand, covered, for 5-10 minutes.
Ground Meat	0.5-3.0 lbs.	After each stage, remove any pieces of food that are nearly defrosted. Let stand, covered with foil, for 5-10 minutes.

Food	Standard Amount	Procedure
Whole Chicken	2.5-6.0 lbs.	Remove giblets before freezing poultry. Start defrosting with the breast side down. After the first stage, turn the chicken over and shield any warm portions with narrow strips of aluminum foil. After the second stage, again shield any warm portions with narrow strips of aluminum foil. Let stand, covered, for 30-60 minutes in the refrigerator.
Chicken Pieces	0.5-3.0 lbs.	After each stage, rearrange or remove any pieces of food that are nearly defrosted. Let stand for 10-20 minutes.

DEFROST TIPS

- When using AUTO DEFROST, the weight to be entered is the net weight in pounds and tenths of pounds (the weight of the food minus the container).
- Use AUTO DEFROST only for raw food. AUTO DEFROST gives best results when food to be thawed is a minimum of 0°F (taken directly from a true freezer). If food has been stored in a refrigerator-freezer that does not maintain a temperature of 5°F or below, always program a lower food weight (for a shorter defrosting time) to prevent cooking the food.
- If the food is stored outside the freezer for up to 20 minutes, enter a lower food weight.
- The shape of the package alters the defrosting time. Shallow rectangular packets defrost more quickly than a deep block.
- Separate pieces as they begin to defrost. Separated pieces defrost more easily.
- Shield areas of food with small pieces of foil if they start to become warm.
- You can use small pieces of aluminum foil to shield foods like chicken wings, leg tips, and fish tails, but the foil must not touch the side of the oven. Foil causes arcing, which can damage the oven lining.



Operating Instructions

COOKING GUIDE

Guide for Cooking Meat in Your Microwave

- Place meat on a microwave-safe roasting rack in a microwave-safe dish.
- Start meat fat side down. Use narrow strips of aluminum foil to shield any bone tips or thin meat areas.
- Check the temperature in several places before letting the meat stand the recommended time.
- The following temperatures are removal temperatures. The temperature of the food will rise during the standing time.

Food	Cook time	Power level	Directions
Roast Beef Boneless (Up to 4 lbs.)	10-15 min./lb. for 145° F (Rare)	High(10) for first 5 minutes, then medium(5)	Place roast fat-side down on roasting rack. Cover with wax paper. Turn over half way through cooking. Let stand 10 to 15 minutes.
	12-17 min./lb. for 160° F (Medium)		
	14-19 min./lb. for 170° F (Well Done)		
Roast Pork Boneless or bone-in (Up to 4 lbs.)	15-20 min./lb. for 170° F (Well Done)	High(10) for first 5 minutes, then medium(5)	Place roast fat-side down on roasting rack. Cover with wax paper. Turn over half way through cooking. Let stand 10 to 15 minutes.

- Expect a 10°F rise in temperature during the standing time.

Food		Remove from oven	After standing (10 -15 min.)
Beef	Rare	135°F	145°F
	Medium	150°F	160°F
	Well Done	160°F	170°F
Pork	Medium	150°F	160°F
	Well Done	160°F	170°F
Poultry	Dark meat	170°F	180°F
	Light meat	160°F	170°F

Guide for Cooking Poultry in Your Microwave

- Place poultry on a microwave-safe roasting rack in a microwave-safe dish.
- Cover poultry with wax paper to prevent spattering.
- Use aluminum foil to shield bone tips, thin meat areas, or areas that start to overcook.
- Check the temperature in several places before letting the poultry stand the recommended time.

Food	Cook Time/Power Level	Directions
Whole Chicken Up to 4 lbs.	Cooking Time: 7-10 min. / lb. 180°F dark meat 170°F light meat Power Level: Medium High(7).	Place chicken breast-side down on roasting rack. Cover with wax paper. Turn over half way through cooking. Cook until juices run clear and meat near the bone is no longer pink. Let stand 5-10 minutes.
Chicken Pieces Up to 2 lbs.	Cooking Time: 7-10 min. / lb. 180°F dark meat 170°F light meat Power Level: Medium High(7).	Place chicken bone-side down on dish, with the thickest portions toward the outside of the dish. Cover with wax paper. Turn over half way through cooking. Cook until juices run clear and meat near the bone is no longer pink. Let stand 5-10 minutes.



Operating Instructions

Guide for Cooking Seafood in Your Microwave

- Cook fish until it flakes easily with a fork.
- Place fish on a microwave-safe roasting rack in a microwave-safe dish.
- Use a tight cover to steam fish. A lighter cover of wax paper or paper towel provides less steaming.
- Do not overcook fish; check it at minimum cooking time.

Food	Cook Time/Power Level	Directions
Steaks Up to 1.5 lbs.	Cooking Time: 7-11 min. / lb. Power Level: Medium-High(7).	Arrange steaks on roasting rack with meaty portions towards the outside of rack. Cover with wax paper. Turn over and rearrange when cooking time is half up. Cook until fish flakes easily with a fork. Let stand 3-5 minutes.
Fillets Up to 1.5 lbs.	Cooking Time: 4-8 min. / lb Power Level: Medium-High(7).	Arrange fillets in a baking dish, turning any thin pieces under. Cover with wax paper. If over ½ inch thick, turn over and rearrange when cooking time is half up. Cook until fish flakes easily with a fork. Let stand 2-3 minutes.
Shrimp Up to 1.5 lbs.	Cooking Time: 4-6 ½ min. / lb. Power Level: Medium-High(7).	Arrange shrimp in a baking dish without overlapping or layering. Cover with wax paper. Cook until firm and opaque, stirring 2 or 3 times. Let stand 5 minutes.

Guide for Cooking Eggs in Your Microwave

- Never cook eggs in the shell, and never warm hard-cooked eggs in the shell; they can explode.
- Always pierce whole eggs to keep them from bursting.
- Cook eggs just until set; they become tough if overcooked.

Guide for Cooking Vegetables in Your Microwave

- Vegetables should be washed just before cooking. Often, no extra water is needed. If dense vegetables such as potatoes, carrots and green beans are being cooked, add about ¼ cup water.
- Small vegetables (sliced carrots, peas, lima beans, etc.) will cook faster than larger ones.
- Whole vegetables, such as potatoes, acorn squash or corn on the cob, should be arranged in a circle on the turntable before cooking. They will cook more evenly if turned over after half the cooking time has passed.
- Always place vegetables like asparagus and broccoli with the stem ends pointing towards the edge of the dish and the tips toward the center.
- When cooking cut vegetables, always cover the dish with a lid or vented microwavable plastic wrap.
- Whole, unpeeled vegetables such as potatoes, squash, eggplant, etc., should have their skin pricked in several spots before cooking to prevent them from bursting.
- For more even cooking, stir or rearrange whole vegetables halfway through the cooking time.
- Generally, the denser the food, the longer the standing time (Standing time refers to the time necessary for dense, large foods and vegetables to finish cooking after they come out of the oven.). A baked potato can stand on the counter for five minutes, while a dish of peas can be served immediately.



Care and Cleaning

CARE AND CLEANING

For best performance and safety, keep the oven clean inside and out-side. Take special care to keep the inner door panel and the oven front frame free of food or grease build-up. **Never use rough powder or pads.** Wipe the microwave oven inside and out, including the hood bottom cover, with a soft cloth and a warm (not hot) mild detergent solution. Then rinse and wipe dry. Use a chrome cleaner and polish on chrome, metal and aluminum surfaces. Wipe spatters immediately with a wet paper towel, especially after cooking chicken or bacon. Clean your oven weekly or more often, if needed.

Follow these instructions to clean and care for your oven.

- Keep the inside of the oven clean. Food particles and spilled liquids can stick to the oven walls, causing the oven to work less efficiently.
- Wipe up spills immediately. Use a damp cloth and mild soap. Do not use harsh detergents or abrasives.
- To help loosen baked on food particles or liquids, heat two cups of water (add the juice of one lemon if you desire to keep the oven fresh) in a four-cup measuring glass at High power for five minutes or until boiling. Let stand in the oven for one or two minutes.
- Remove the glass tray from the oven when cleaning the oven or tray. To prevent the tray from breaking, handle it carefully and do not put it in water immediately after cooking. Wash the tray carefully in warm sudsy water or in the dishwasher.
- Clean the outside surface of the oven with soap and a damp cloth. Dry with a soft cloth. To prevent damage to the operating parts of the oven, don't let water seep into the openings.
- Wash the door window with very mild soap and water. Be sure to use a soft cloth to avoid scratching.
- If steam accumulates inside or outside the oven door, wipe with a soft cloth. Steam can accumulate when operating the oven in high humidity and in no way indicates microwave leakage.
- Never operate the oven without food in it; this can damage the magnetron tube or glass tray. You may wish to leave a cup of water in the oven when it is not in use to prevent damage if the oven is accidentally turned on.

CLEANING THE GREASE FILTER

The grease filter should be removed and cleaned often, at least once a month.

⚠ CAUTION

To avoid risk of personal injury or property damage, do not operate oven hood without filters in place.

1. To remove grease filter, slide filter to the side. Pull filter downward and push to the other side. The filter will drop out.

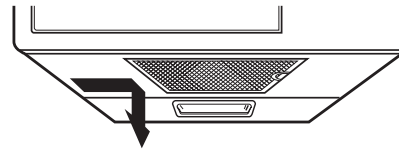

2. Soak grease filter in hot water and a mild detergent. Rinse well and shake to dry. **Do not use ammonia or place in a dishwasher. The aluminum will darken.**

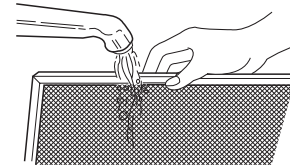

3. To reinstall the filter, slide it into the side slot, then push up and toward oven center to lock.

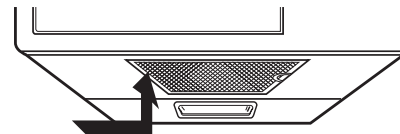

CHARCOAL FILTER REPLACEMENT

If your oven is vented to the inside, the charcoal filter should be replaced every 6 to 12 months, and more often if necessary. The charcoal filter cannot be cleaned. To order a new charcoal filter, contact the Parts Department at your nearest Authorized Service Center or call:

1-800-944-9044 (U.S.)

1-800-668-4606 (Canada)

1. Unplug oven or turn off power at the main power supply.
2. Open the door.
3. Remove the two vent grille mounting screws. (3 middle screws)



Care and Cleaning

- Slide the grille to the left, then pull straight out.

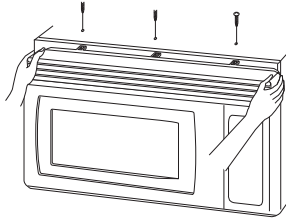

- Push the hook and remove old filter.

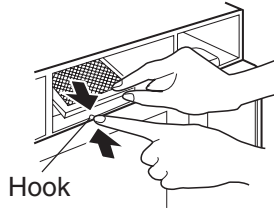

- Slide a new charcoal filter into place. The filter should rest at the angle shown.

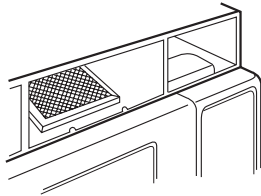

- Replace the grille and 3 screws and close the door. Turn the power back on at the main power supply and set the clock.

CHARCOAL FILTER PART NO.

COOKTOP/NIGHT LIGHT REPLACEMENT

⚠ CAUTION

To avoid personal injury or property damage, wear gloves when replacing light bulb.

- Unplug the oven or turn off power at the main power supply.
- Remove the bulb cover mounting screws.

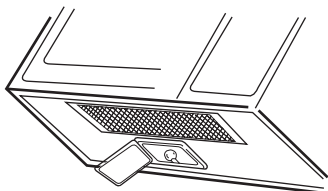

- Replace bulb with 40 watt appliance bulb.

- Replace bulb cover, and mounting screws.
- Turn the power back on at the main power supply.

OVEN LIGHT REPLACEMENT

- Unplug oven or turn off power at the main power supply.
- Open the door.
- Remove the vent cover mounting screws. (3 middle screws)
- Slide the grille to the left, then pull straight out.

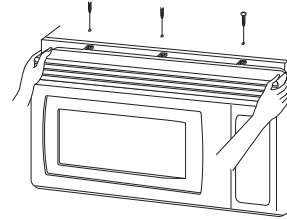

- Remove the charcoal filter, if present.

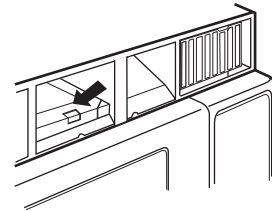

- Press and hold the center snap while lifting the tab on the left corner. Remove the cover. Remove the bulb by turning gently.

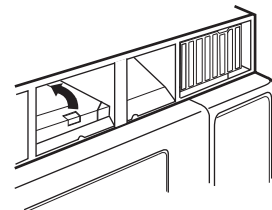

- Replace bulb with a 40 watt appliance bulb.
- Replace the bulb holder.
- Replace the grille and 2 screws. Turn the power back on at the main power supply.



Before You Call

TROUBLESHOOTING GUIDE

Before you call a repair person for your oven, check this list of possible problems and solutions.

Neither the oven's display nor the oven operate.

- Properly insert the plug into a grounded outlet.
- If the outlet is controlled by a wall switch, make sure the wall switch is turned on.
- Remove the plug from the outlet, wait ten seconds, then plug it in again.
- Reset the circuit breaker or replace any blown fuse.
- Plug another appliance into the outlet; if the other appliance doesn't work, have a qualified electrician repair the outlet.
- Plug the oven into a different outlet.

The oven's display works, but the power won't come on.

- Make sure the door is closed securely.
- Check to see if packing material or other material is stuck to the door seal.
- Check for door damage.
- Press **STOP/CLEAR** pad twice and re-enter all cooking instructions.

The power goes off before the set time has elapsed.

- If there has not been a power outage, remove the plug from the outlet, wait ten seconds, then plug it in again. If there was a power outage, the time indicator will display:



- Reset the clock and any cooking instructions.
- Reset the circuit breaker or replace any blown fuse.

The food is cooking too slowly.

- Make sure the oven is on its own 20 amp circuit line. Operating another appliance on the same circuit can cause a voltage drop. If necessary, move the oven to its own circuit.

You see sparks or arcing.

- Remove any metallic utensils, cookware, or metal ties. If using foil, use only narrow strips and allow at least one inch between the foil and interior oven walls.

The turntable makes noises or sticks.

- Clean the turntable, roller ring and oven floor.
- Make sure the turntable and roller ring are positioned correctly.

Using your microwave causes TV or radio interference.

- This is similar to the interference caused by other small appliances, such as hair dryers. Move your microwave further away from other appliances, like your TV or radio.

NOTE

If the oven is set to cook for more than 25 minutes, it will automatically adjust itself to 70 percent power after 25 minutes to avoid overcooking.

If you have a problem you cannot solve, please call our service line:

1-800-944-9044 (U.S.)

1-800-668-4606 (Canada)



Note

A large, empty rectangular area with rounded corners and a light gray background, intended for writing a note or comment.



Major Appliance Warranty Information

Your appliance is covered by a one year limited warranty. For one year from your original date of purchase, Electrolux will pay all costs for repairing or replacing any parts of this appliance that prove to be defective in materials or workmanship when such appliance is installed, used and maintained in accordance with the provided instructions.

Exclusions

This warranty does not cover the following:

1. Products with original serial numbers that have been removed, altered or cannot be readily determined.
2. Product that has been transferred from its original owner to another party or removed outside the USA or Canada.
3. Rust on the interior or exterior of the unit.
4. Products purchased "as-is" are not covered by this warranty.
5. Food loss due to any refrigerator or freezer failures.
6. Products used in a commercial setting.
7. Service calls which do not involve malfunction or defects in materials or workmanship, or for appliances not in ordinary household use or used other than in accordance with the provided instructions.
8. Service calls to correct the installation of your appliance or to instruct you how to use your appliance.
9. Expenses for making the appliance accessible for servicing, such as removal of trim, cupboards, shelves, etc., which are not a part of the appliance when it is shipped from the factory.
10. Service calls to repair or replace appliance light bulbs, air filters, water filters, other consumables, or knobs, handles, or other cosmetic parts.
11. Surcharges including, but not limited to, any after hour, weekend, or holiday service calls, tolls, ferry trip charges, or mileage expense for service calls to remote areas, including the state of Alaska.
12. Damages to the finish of appliance or home incurred during installation, including but not limited to floors, cabinets, walls, etc.
13. Damages caused by: services performed by unauthorized service companies; use of parts other than genuine Electrolux parts or parts obtained from persons other than authorized service companies; or external causes such as abuse, misuse, inadequate power supply, accidents, fires, or acts of God.

DISCLAIMER OF IMPLIED WARRANTIES; LIMITATION OF REMEDIES

CUSTOMER'S SOLE AND EXCLUSIVE REMEDY UNDER THIS LIMITED WARRANTY SHALL BE PRODUCT REPAIR OR REPLACEMENT AS PROVIDED HEREIN. CLAIMS BASED ON IMPLIED WARRANTIES, INCLUDING WARRANTIES OF MERCHANTABILITY OR FITNESS FOR A PARTICULAR PURPOSE, ARE LIMITED TO ONE YEAR OR THE SHORTEST PERIOD ALLOWED BY LAW, BUT NOT LESS THAN ONE YEAR. ELECTROLUX SHALL NOT BE LIABLE FOR CONSEQUENTIAL OR INCIDENTAL DAMAGES SUCH AS PROPERTY DAMAGE AND INCIDENTAL EXPENSES RESULTING FROM ANY BREACH OF THIS WRITTEN LIMITED WARRANTY OR ANY IMPLIED WARRANTY. SOME STATES AND PROVINCES DO NOT ALLOW THE EXCLUSION OR LIMITATION OF INCIDENTAL OR CONSEQUENTIAL DAMAGES, OR LIMITATIONS ON THE DURATION OF IMPLIED WARRANTIES, SO THESE LIMITATIONS OR EXCLUSIONS MAY NOT APPLY TO YOU. THIS WRITTEN WARRANTY GIVES YOU SPECIFIC LEGAL RIGHTS. YOU MAY ALSO HAVE OTHER RIGHTS THAT VARY FROM STATE TO STATE.

If You Need Service

Keep your receipt, delivery slip, or some other appropriate payment record to establish the warranty period should service be required. If service is performed, it is in your best interest to obtain and keep all receipts. Service under this warranty must be obtained by contacting Electrolux at the addresses or phone numbers below.

This warranty only applies in the USA and Canada. In the USA, your appliance is warranted by Electrolux Major Appliances North America, a division of Electrolux Home Products, Inc. In Canada, your appliance is warranted by Electrolux Canada Corp. Electrolux authorizes no person to change or add to any obligations under this warranty. Obligations for service and parts under this warranty must be performed by Electrolux or an authorized service company. Product features or specifications as described or illustrated are subject to change without notice.

USA

1.800.944.9044

Electrolux Major Appliances
North America
P.O. Box 212378
Augusta, GA 30907



Canada

1.800.668.4606

Electrolux Canada Corp.
5855 Terry Fox Way
Mississauga, Ontario, Canada
L5V 3E4

Free Manuals Download Website

<http://myh66.com>

<http://usermanuals.us>

<http://www.somanuals.com>

<http://www.4manuals.cc>

<http://www.manual-lib.com>

<http://www.404manual.com>

<http://www.luxmanual.com>

<http://aubethermostatmanual.com>

Golf course search by state

<http://golfingnear.com>

Email search by domain

<http://emailbydomain.com>

Auto manuals search

<http://auto.somanuals.com>

TV manuals search

<http://tv.somanuals.com>