



A Sierra Monitor Company

Driver Manual
(Supplement to the FieldServer Instruction Manual)

FS-8700-20 Profibus DP

APPLICABILITY & EFFECTIVITY

Effective for all systems manufactured after May 1, 2001

Driver Version:	1.02
Document Revision:	4

Table of Contents

1. Profibus DP Description	3
2. Driver Scope of Supply	4
2.1. Supplied by FieldServer Technologies for this driver	4
2.2. Provided by the Supplier of 3 rd Party Equipment.....	4
2.2.1. <i>Hardware</i>	4
2.2.2. <i>Software</i>	4
3. Hardware Connections	5
3.1. Hardware Troubleshooting	5
3.2. SST Profibus card LEDs	5
3.3. Profibus Master Configuration.....	6
3.4. Using the SST Configuration Tool for Profibus Master Configuration	6
3.5. Using COM PROFIBUS for Profibus Master Configuration.....	6
4. Configuring the FieldServer as a Profibus DP Master	7
4.1. General.....	7
4.2. Data Arrays/ Descriptors	7
4.3. Client Side Connection Descriptions	8
4.4. Client Side Node Descriptors	8
4.5. Client Side Map Descriptors.....	9
4.6. Creating the Network Configuration File for the Master	10
5. Configuring the FieldServer as a Profibus DP Slave Only	13
5.1. General.....	13
5.2. Data Arrays/ Descriptors	13
5.3. Server Side Connection Descriptions.....	14
5.4. Server Side Node Descriptors.....	14
5.5. Server Side Map Descriptors	15
Appendix A. Special Driver Parameters	16
Appendix A.1. DP_Buffer	16
Appendix A.2. Data_Type, Address & Length	16
Appendix B. Driver Notes	17
Appendix B.1. Understanding buffer types and Map Descriptor functions.....	17
Appendix C. Troubleshooting	19
Appendix C.1. FieldServer as a Profibus slave	19
Appendix C.2. FieldServer as a Profibus Master	20
Appendix C.3. Error and Informational Messages on Ruinet E and F screens.....	21

1. Profibus DP Description

The Profibus DP driver allows the FieldServer to transfer data to and from devices using Profibus DP protocol. The Communications Adapter card is included with the FieldServer. The FieldServer can function as either a Master or a Slave on the Profibus Network.

When acting as a DP Master, the FieldServer requires a Profibus master configuration file in addition to its own configuration file. The Profibus master configuration file (bridge.bss/bridge.2bf) describes the operating network, and the FieldServer configuration file (config.csv) describes the data that will be accessed within the Profibus slaves. As slaves are added or removed from the Profibus network, the Profibus master configuration file will need to be updated. The Profibus master configuration is created using a Profibus configuration tool. The tool provided on the SST CD can be used to create this file.

As a slave, the Profibus DP driver allows the FieldServer to be a single slave station to another master. This slave is capable of transferring 244 bytes of input and 244 bytes of output to the other master. If it is necessary to transfer more data to a Profibus master, then the Profibus DPMS driver and adapter card will be necessary. For Slave applications, the Profibus master configuration file is not used, and only the FieldServer configuration file will be used to set the FieldServer's Profibus Slave station address and buffer sizes.

To connect to the Profibus network, the FieldServer has been equipped with a 5136-PFB-ISA card. This card has a standard DB-9 Profibus port that will accommodate a DB9 (Male) Profibus connector (supplied) and drop cable (not supplied).

The 5136-PFB-ISA card requires firmware (PFB DP.SS1) which will be factory installed onto the FieldServer prior to shipment.

The information that follows describes how to expand upon the factory defaults provided in the configuration files included with the FieldServer.

2. Driver Scope of Supply

2.1. Supplied by FieldServer Technologies for this driver

FieldServer Technologies PART #	Description
SST 5136-PFB-ISA	Profibus ISA card
	SST CD "For Profibus Interface Cards"
	Profibus connector without terminating resistor
FS-8700-20	Driver Manual.

2.2. Provided by the Supplier of 3rd Party Equipment

2.2.1. Hardware

PART #	DESCRIPTION
	Profibus DP Network Components
	PC for configuration tool
	Profibus connector with terminating resistor (if required)

2.2.2. Software

PART #	DESCRIPTION
	User is required to create gsd file if required. Template gsd is available on the SST CD provided.

3. Hardware Connections

The FieldServer is equipped with a SST 5136-PFB-ISA interface card, which has a standard Profibus DB-9 interface available for connection to the Profibus network. If the FieldServer is located at an end of the network, termination will be required. For more information on Profibus cables and connections, please refer to the documentation provided on the SST CD.

WARNING: Improper cabling can cause physical layer problems that are hard to diagnose.

The FieldServer is connected to the Profibus DP as shown in the connection drawing below:

Configure the Profibus DP according to manufacturer's instructions

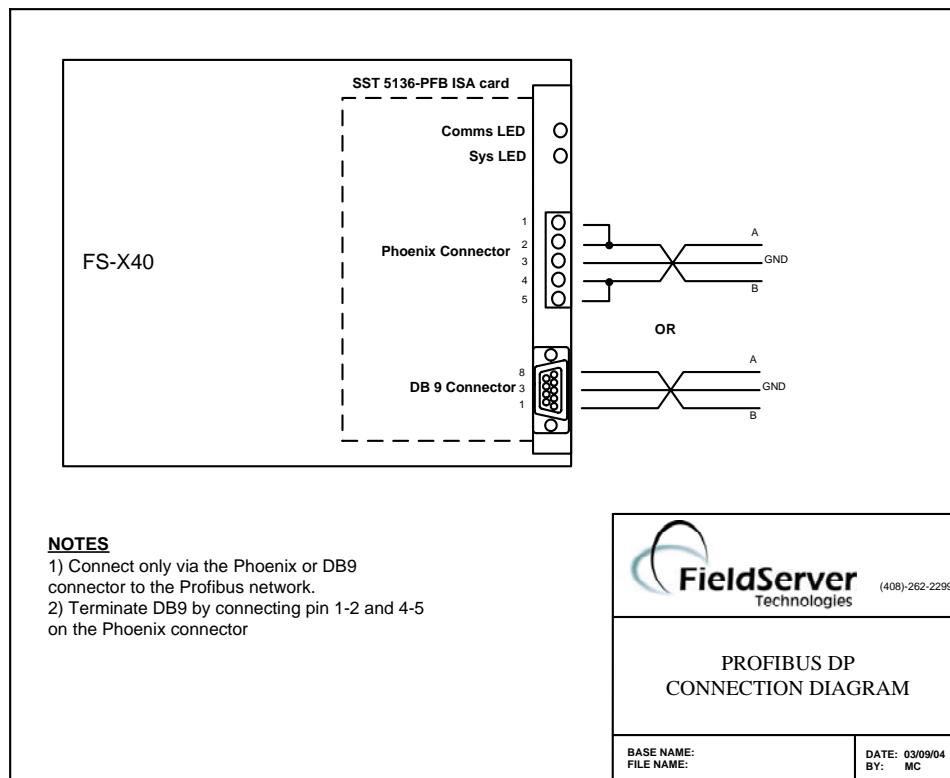

3.1. Hardware Troubleshooting

During initialization, the Profibus DP driver checks for the 5136-PFB-ISA hardware and checks for any conflicts with other hardware. If any errors occur during initialization, an entry in the error log will be produced.

3.2. SST Profibus card LEDs

There are two LEDs on the SST Profibus Card. When operating normally the COM LED should remain solid green. Any communications errors will cause it to flash red for at least one second. The SYS LED shows the status of both the master and slave. If using either the slave or master, the SYS LED will show green if all is ok, amber if all is ok but the bus is running in program mode, and red if there is a problem. If running both master and slave, the LED will sequence through the master status, the slave status and then off.

3.3. Profibus Master Configuration

If using the FieldServer as a Profibus master, provide a configuration file to fully describe the network connected to the FieldServer. The Profibus driver will accept a 2BF file or a BSS file. The 2BF file is created using COM PROFIBUS from Siemens. The BSS file is created using the SST Profibus Configuration tool. These files can be loaded onto the FieldServer using the FieldServer RUI utilities.

If no configuration file is found on the FieldServer, the Profibus DP driver will still be available as a slave if the System_Station_Address and local Node ID values match. See section on configuring as a Slave for more details. After power up, the FieldServer will continually try to detect the Profibus baud rate. Once detected, the FieldServer will go online and send its inputs to the master, and receive its outputs from the master. The size of the input and output buffers are determined by examining the Map Descriptors within the FieldServer configuration file.

3.4. Using the SST Configuration Tool for Profibus Master Configuration

To use the SST Configuration tool, install it onto a Windows machine from the CD provided.

After starting the tool:

Create a new network specifying the SST 5163-PFB-ISA as the master.

Set the network properties such as baud rate by right clicking on the PROFIBUS-DP icon.

Add the slaves intended to connect to the network.

When complete, save the network and from the Edit menu, select export binary. Save the binary file as bridge.bss.

Send bridge.bss to the FieldServer using RUI utilities.

3.5. Using COM PROFIBUS for Profibus Master Configuration.

Please refer to the COM PROFIBUS manual for instructions on how to create a master configuration file using COM PROFIBUS. Once completed, save the binary file as bridge.2bf and send it to the FieldServer using RUI utilities.

4. Configuring the FieldServer as a Profibus DP Master

The sections below describe the parameters available for configuring the driver as a Client. Note that * indicates an optional parameter, with the bold legal value being the default.

4.1. General

Section Title		
FieldServer		
Column Title	Function	Legal Values
Title	Provide a title for the configuration file (displays on RUI editor)	Up to 15 alphanumeric characters
System_Station_Address	Profibus DP Master Station ID of the FieldServer	0-125

Example:

// Common information		
FieldServer		
Title,	System_Station_Address	
Profibus DP Master,	0	

4.2. Data Arrays/ Descriptors

Data Arrays are the neutral data buffers used by the FieldServer to pass data between communications drivers, and are defined as follows:

Section Title		
Data_Arrays		
Column Title	Function	Legal Values
Data_Array_Name	Provide name for Data Array	Up to 15 alphanumeric characters
Data_Format	Provides data format	FLOAT, BIT, UInt16, SInt16, Packed_Bit, Byte, Packed_Byte, Swapped_Byte
Data_Array_Length	Number of Data Objects	1-10,000

Example

// Data Arrays		
Data_Arrays		
Data_Array_Name,	Data_Format,	Data_Array_Length
DA_AI_01,	UInt16,	200
DA_AO_01,	UInt16,	200

4.3. Client Side Connection Descriptions

The adapter used for the Profibus driver must be declared in the connections section.

Section Title		
Connections		
Column Title	Function	Legal Values
Adapter	Adapter Name	Prof_DP
Protocol	Specify protocol used	Profibus_DP

Example

// Client Side Connections	
Connections	
Adapter, Prof_DP,	Protocol Profibus_DP

4.4. Client Side Node Descriptors

For each Profibus slave that the user wishes to access data on, an entry into a node table must be made. The table associates a name with the node number and connection.

Section Title		
Nodes		
Column Title	Function	Legal Values
Node_Name	Provide name for node	Up to 32 alphanumeric characters
Node_ID	Station ID of destination Profibus device	0-125 (do not use same ID as in System_Station_Address)
Protocol	Specify protocol used	Profibus_DP
Adapter	Specify which adapter is connected to the FieldServer	Prof_DP

Example

// Client Side Nodes			
Nodes			
Node_Name, PDP_01,	Node_ID, 1,	Protocol, Profibus_DP,	Adapter Prof_DP

4.5. Client Side Map Descriptors

Map Descriptors control when and how data is transferred to or from the Profibus slaves.

Column Title	Function	Legal Values
Map_Descriptor_Name	Name of this Map Descriptor	Up to 32 alphanumeric characters
Data_Array_Name	Name of Data Array where data is to be stored in the FieldServer	One of the Data Array names from "Data Array" section above
Data_Array_Offset	Starting location in Data Array	0 to maximum specified in "Data Array" section above
Function	Function of Client Map Descriptor	RDBC, WRBC
Node_Name	Name of Node to fetch data or write data to	One of the node names specified in "Client Side Nodes" above
Data_Type	Data type	FLOAT, WORD, BYTE, BIT
DP_Buffer	Specify buffer in the DP card being accessed.	Input, Output
Address	Address in DP_Buffer being accessed, expressed in byte offset	0-243 Note: When using Data_Type BIT, the address is in bit e.g. from 0 - 1951
Length	Number of points in DP_Buffer being accessed, expressed in points defined by Data_Type	1- 1952, depending on Data_Type e.g. when Data Type is WORD and length is 10, it means that 10*2 = 20 bytes are used in the buffer

Example

```
// Client Side Map Descriptors

Map_Descriptors
Map_Descriptor_Name, Data_Array_Name, Data_Array_Offset, Function, Node_Name, DP_Type, DP_Buffer, Address, Length
FLOAT_IN_01, DA_FI_01, 0, WRBC, PDP_01, FLOAT, Output, 0000, 20
INT_IN_01, DA_AI_01, 0, WRBC, PDP_01, WORD, Output, 0080, 20
BYTE_IN_01, DA_BI_01, 0, WRBC, PDP_01, BYTE, Output, 0120, 20
BIT_IN_0,1 DA_DI_01, 0, WRBC, PDP_01, BIT, Output, 0140, 32

FLOAT_OUT_01, DA_FO_01, 0, RDBC, PDP_01, FLOAT, Input, 0000, 20
INT_OUT_01, DA_AO_01, 0, RDBC, PDP_01, WORD, Input, 0080, 20
BYTE_IN_01, DA_BO_01, 0, RDBC, PDP_01, BYTE, Input, 0120, 20
BIT_IN_01, DA_DO_01, 0, RDBC, PDP_01, BIT, Input, 0140, 32
```

4.6. Creating the Network Configuration File for the Master

The output of this procedure is a bridge.bss file that has to be downloaded to the FieldServer.

- 1) Start the SST Profibus Network Configuration Tool and drag the 5136-PFB-ISA MASTER [Rev 1.3] Master device into the right-hand window pane.

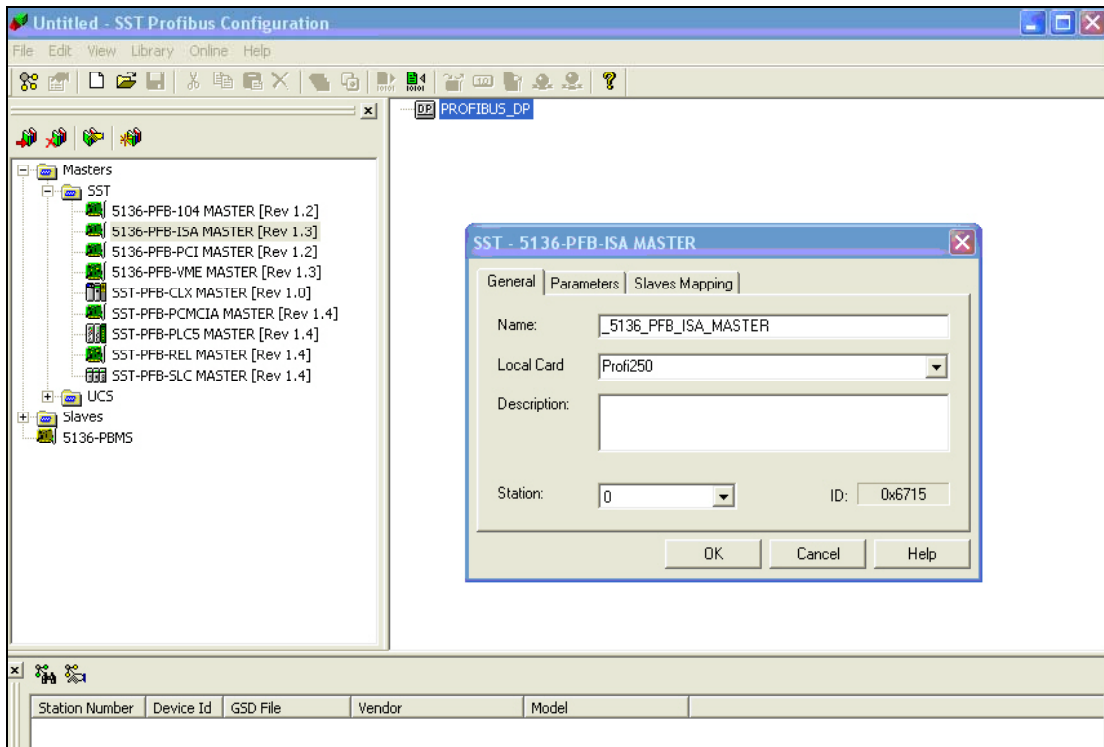

- 2) Set the Station to be the same as defined under System_Station_Address in the config.csv file. Click OK to close the Master window.
- 3) Right-click on the PROFIBUS_DP icon and choose Properties to configure the network.

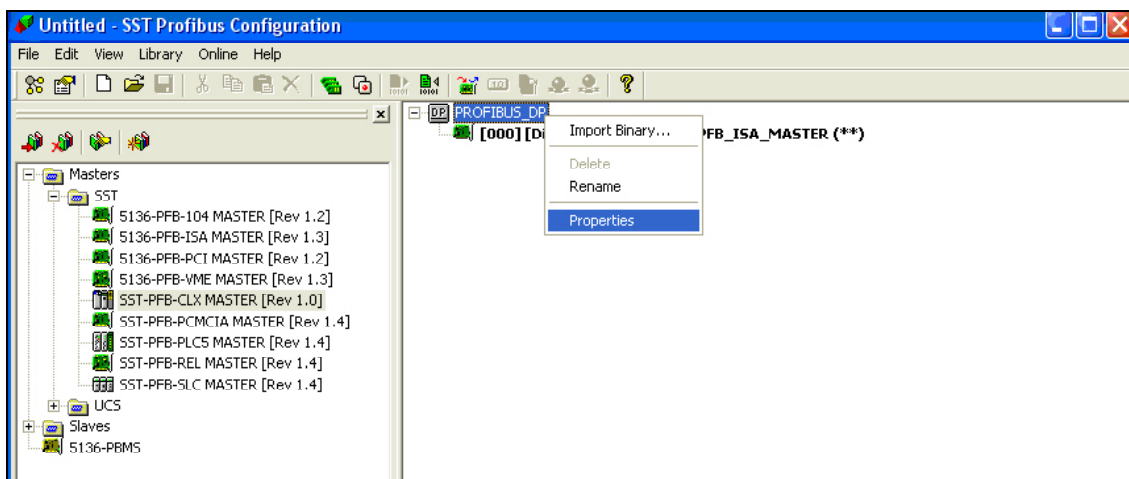

4) Set the Baud Rate to a value supported by the Slaves and your cabling media. Choose a highest Station on the network if you wish to enhance performance, which will prevent the Master from scanning non-existent Stations. Click OK to complete the network configuration.

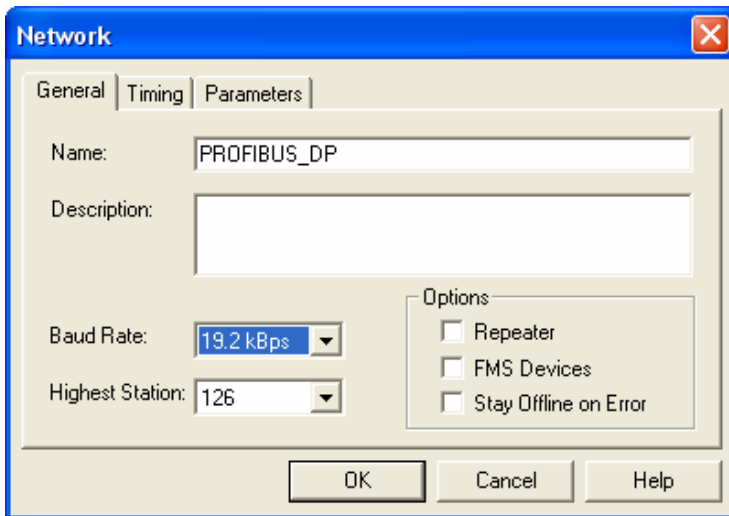

5) Drag your Slave devices onto the right window pane and configure them as per manufacturer's instructions. Choose a unique Station ID for each Slave.

There has to be Node descriptor with matching Node ID to Station ID for each Slave setup in the FieldServer's config.csv file.

Important Note:

All Profibus Masters check for a match in the connection size in bytes to Slaves before allowing a connection. Make sure you add the appropriate Modules for Input/Output Data to create a connection size that matches the connection size setup in the Slave device; otherwise the Master will not connect to the Slave.

6) Right-click on the PFB_ISA_MASTER Icon and select Export Binary and create a file called bridge.bss. Download this file to your FieldServer using Ruinet and restart the FieldServer.

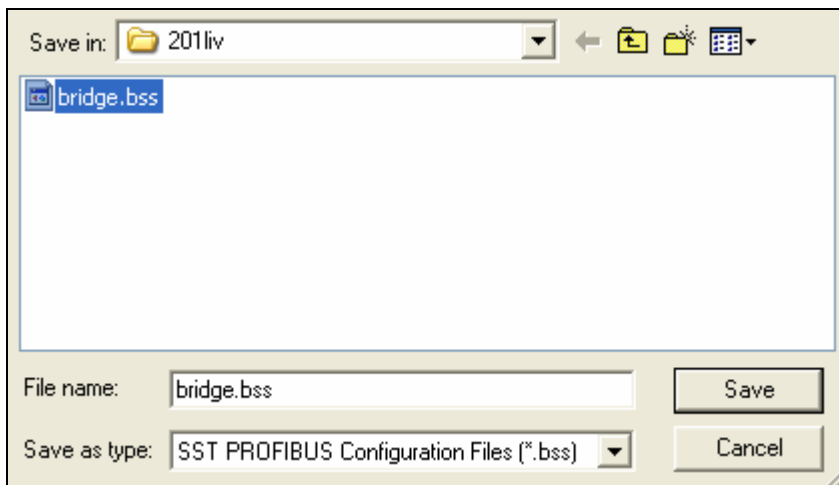
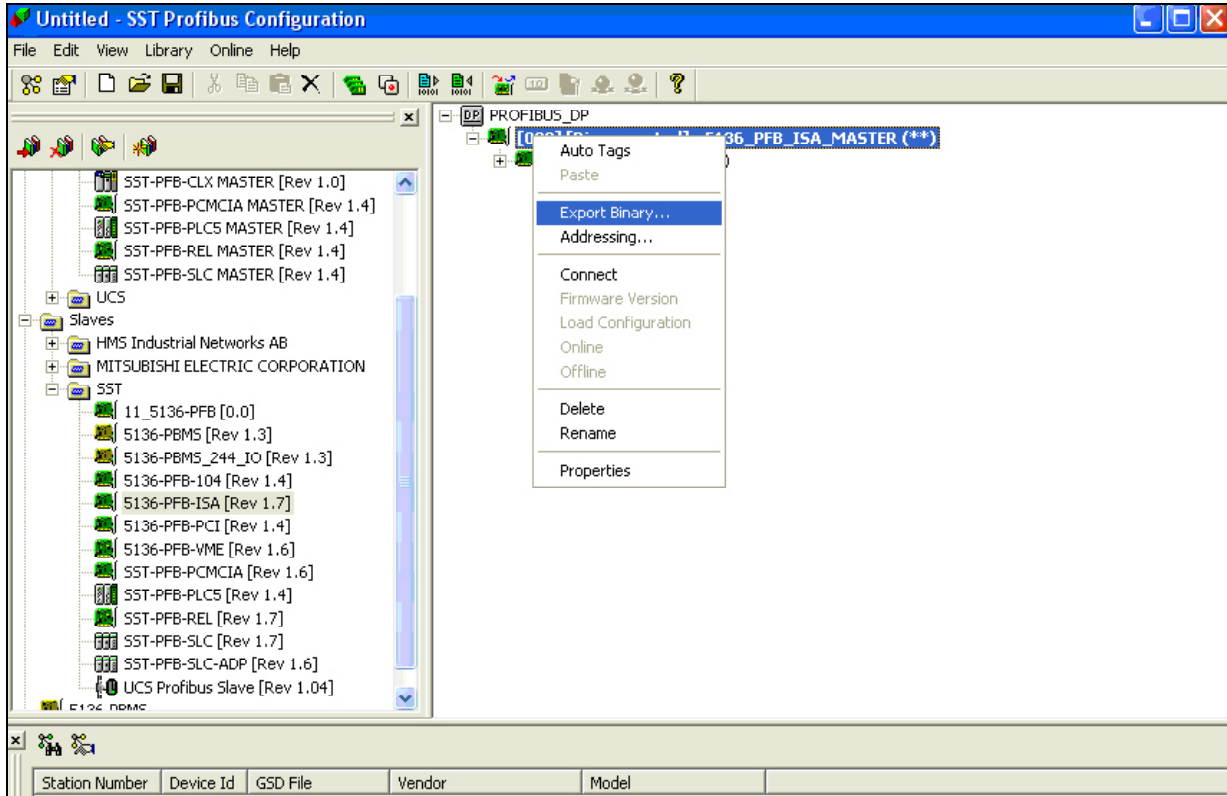

5. Configuring the FieldServer as a Profibus DP Slave Only

The sections below describe the parameters available for configuring the driver as a Server. Note that * indicates an optional parameter, with the bold legal value being the default.

5.1. General

Section Title		
FieldServer		
Column Title	Function	Legal Values
Title	Provide a title for the configuration file (displays on RUI editor)	Up to 15 alphanumeric characters
System_Station_Address	Profibus DP Slave Station ID of the FieldServer	0-125

Example:

// Common information		
FieldServer		
Title,	System_Station_Address	
Profibus DP Slave,	1	

5.2. Data Arrays/ Descriptors

Data Arrays are the neutral data buffers used by the FieldServer to pass data between communications drivers, and are defined as follows:

Section Title		
Data_Arrays		
Column Title	Function	Legal Values
Data_Array_Name	Provide name for Data Array	Up to 15 alphanumeric characters
Data_Format	Provides data format	FLOAT, BIT, UInt16, SInt16, Packed_Bit, Byte, Packed_Byte, Swapped_Byte
Data_Array_Length	Number of Data Objects	1-10,000

Example

// Data Arrays		
Data_Arrays		
Data_Array_Name,	Data_Format,	Data_Array_Length
DA_AI_01,	UInt16,	200
DA_AO_01,	UInt16,	200

5.3. Server Side Connection Descriptions

The adapter used for the Profibus driver must be declared in the connections section.

Section Title		
Connections		
Column Title	Function	Legal Values
Adapter	Adapter Name	Prof_DP
Protocol	Specify protocol used	Profibus_DP
Profibus_DP_Baud	Specifies network baudrate	9600, 19200, 93.75K, 187.5K, 500K, 750K, 1.5M, 3M, 6M, 12M

Example

// Client Side Connections		
Connections		
Adapter, Prof_DP,	Protocol, Profibus_DP,	Profibus_DP_Baud 19200

5.4. Server Side Node Descriptors

Section Title		
Nodes		
Column Title	Function	Legal Values
Node_Name	Provide name for node	Up to 32 alphanumeric characters
Node_ID	Station ID of the Slave	0-125 Must be same as Value used for System_Station_Address
Protocol	Specify protocol used	Profibus_DP
Adapter	Specify which adapter is connected to the FieldServer	Prof_DP

Example

// Client Side Nodes			
Nodes			
Node_Name, PDP_01,	Node_ID, 1,	Protocol, Profibus_DP,	Adapter Prof_DP

5.5. Server Side Map Descriptors

Map Descriptors control when and how data is transferred to or from the card buffers for an external Profibus Master to access.

Column Title	Function	Legal Values
Map_Descriptor_Name	Name of this Map Descriptor	Up to 32 alphanumeric characters
Data_Array_Name	Name of Data Array where data is to be stored in the FieldServer	One of the Data Array names from "Data Array" section above
Data_Array_Offset	Starting location in Data Array	0 to maximum specified in "Data Array" section above
Function	Function of Server Map Descriptor	RDBC, WRBC
Node_Name	Name of DP Server Node	The node name specified in "Server Side Nodes" above
Data_Type	Data type	FLOAT, WORD, BYTE, BIT
DP_Buffer	Specify buffer in the DP card being accessed.	Input, Output
Address	Address in DP_Buffer being accessed, expressed in byte offset	0-243 Note: When using Data_Type BIT, the address is in bit eg. from 0 - 1951
Length	Number of points in DP_Buffer being accessed, expressed in points defined by Data_Type	1- 1952, depending on Data_Type eg. when Data Type is WORD and length is 10, it means that 10*2 = 20 bytes are used in the buffer

Example

```
// Server Side Map Descriptors

Map_Descriptors
Map_Descriptor_Name,  Data_Array_Name,  Data_Array_Offset,  Function,  Node_Name,  DP_Type,  DP_Buffer,  Address,  Length
FLOAT_IN_01,         DA_FI_01,         0,                RDBC,     PDP_01,     FLOAT,     Output,     0000,     20
INT_IN_01,           DA_AI_01,         0,                RDBC,     PDP_01,     WORD,      Output,     0080,     20
BYTE_IN_01,          DA_BI_01,         0,                RDBC,     PDP_01,     BYTE,      Output,     0120,     20
BIT_IN_0,1           DA_DI_01,         0,                RDBC,     PDP_01,     BIT,       Output,     0140,     32

FLOAT_OUT_01,        DA_FO_01,         0,                WRBC,     PDP_01,     FLOAT,     Input,      0000,     20
INT_OUT_01,          DA_AO_01,         0,                WRBC,     PDP_01,     WORD,      Input,      0080,     20
BYTE_IN_01,          DA_BO_01,         0,                WRBC,     PDP_01,     BYTE,      Input,      0120,     20
BIT_IN_01,           DA_DO_01,         0,                WRBC,     PDP_01,     BIT,       Input,      0140,     32
```

Appendix A. Special Driver Parameters

Appendix A.1. DP_Buffer

Within the Profibus DP card, the FieldServer can access data from two distinct buffers. The Input buffer is the data that is sent from the slave to master. The Output buffer is the data sent from the master to the slave. Each Map Descriptor specifies which one of these buffers to access in the card.

DP_Buffer	Description
Input	Data to the master from a slave
Output	Data from the master to a slave

Appendix A.2. Data_Type, Address & Length

Each Map Descriptor also specifies the Profibus DP data type. The data arrives from a Slave or is sent from a Master as a sequence of bytes. By specifying the DP data type, the driver knows how to interpret the bytes within the buffer. The supported types are Bit, Byte, Word and Float. To indicate where in the buffer to access the data, the Address field is used. For Byte, Word and Float type mappings, the address specifies the offset in bytes from the beginning of the buffer. For Bit type mappings, the address specifies the offset in bits from the beginning of the buffer. A bit offset of 0 would access the least significant bit in the first byte in the designated buffer.

Data_Type	Description
Bit	Transfer Length bits to Data Array
Byte	Transfer Length bytes to Data Array
Word	Swap the bytes and transfer Length words to Data Array
Float	Swap the bytes and transfer Length floats to Data Array

Appendix B. Driver Notes

Appendix B.1. Understanding buffer types and Map Descriptor functions

The following DP_Buffer types and Map Descriptor functions are normally used together when the FieldServer is used as a DP Master:

DP Master:

DP_Buffer	Function
Output	WRBC
Input	RDBC

The Buffer functions are reversed when using the FieldServer as a DP Slave:

DP Slave:

DP_Buffer	Function
Output	RDBC
Input	WRBC

The diagram below explains the data flows for both buffers when using the FieldServer as a DP Master:

Note that for the Input buffer, the data is coming from the external DP Slave and is transferred into the DP Master card's internal input buffer. The Map Descriptor being of the RDBC function (Read Data Block Continuous) transfers the data from the card buffer into the FieldServer's Data Array packing it correctly according to the specified DP_Type.

For the Output buffer, the data is written from the FieldServer's Data Array by the WRBC function Map Descriptor (Write Data Block Continuous) into the DP Master card's internal output buffer from where it is transferred across the Profibus network to the external DP Slave's input buffer.

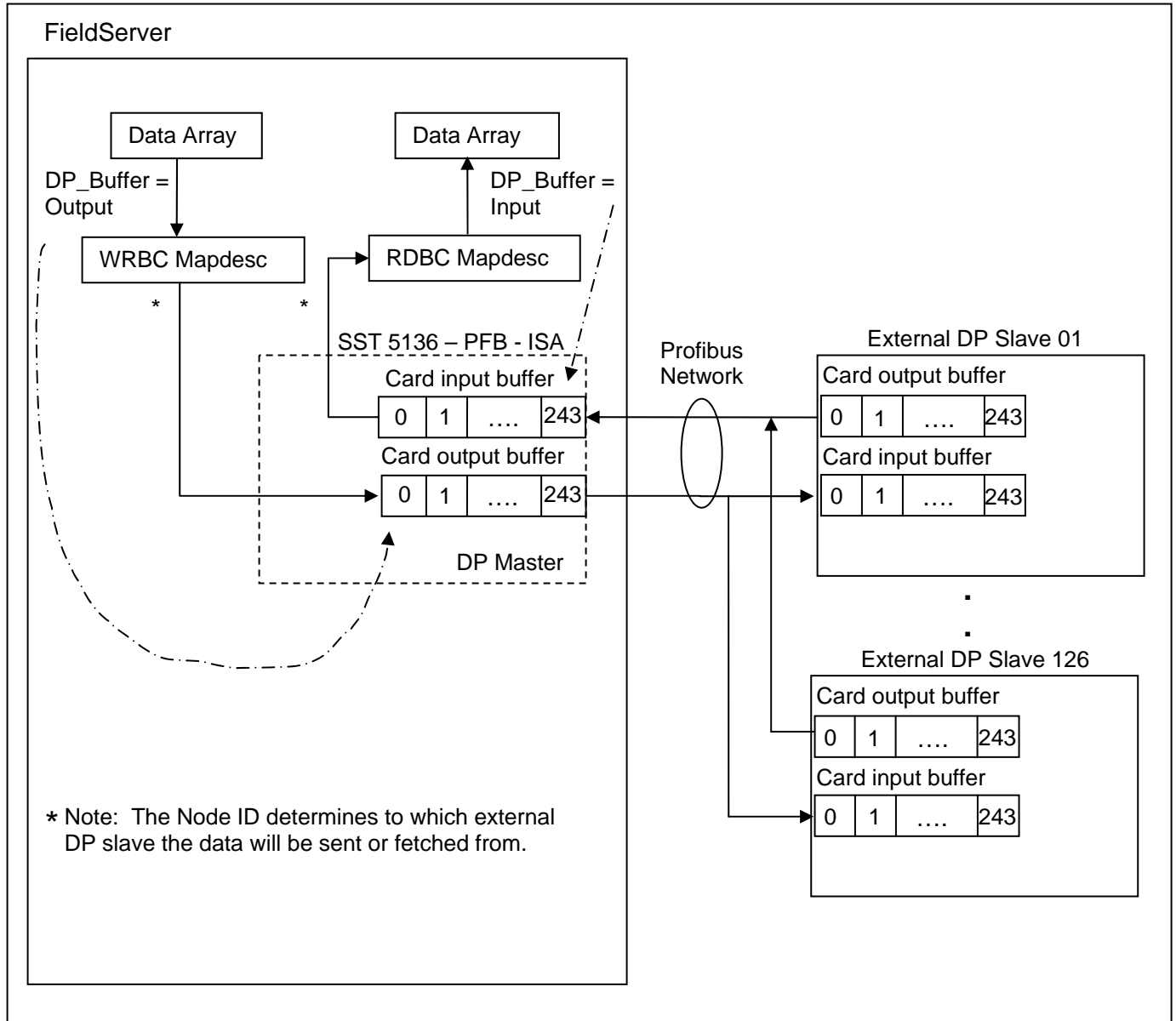

Appendix C. Troubleshooting

Appendix C.1. FieldServer as a Profibus slave

If no communications is being experienced between a Profibus Master and a FieldServer Profibus Slave, check for the following most common issues:

- The baud rate for this driver must be specified in the Connections section of the configuration.
- Baud rate must match the baud rate being used on the network.
- The Node_ID must match the System_Station_Address in the configuration - having these two parameters match in the configuration tells the FieldServer that the buffer referenced in the Node_ID refers to the buffers in the Profibus card attached to the FieldServer.
- The gse file must match the FieldServer hardware being used
 - FieldServer offers several hardware platforms that support Profibus. Each hardware platform requires it's own gse file. Make sure that the gse file being used is the correct file for the hardware platform in use.
 - The gse file can be opened with a text editor. The Vendor and model name can be checked in this file. For the FieldServer X40 Profibus Master/Slave, the Vendor is "SST", and the Model Name is "5136-PFB-ISA". The current revision is 1.9, which uses Hardware revision 1.0 and software release 1.8.
- The byte count for the gse profile must match the byte count configured in the FieldServer
 - The gse being used is either going to allow the client(via the network configuration tool) to select the bytes to be used, or the byte make-up will be fixed and specified in the gse. Either way, the largest byte offset used by the client must match the largest byte offset configured in the FieldServer.
 - When selecting byte count with a network configuration tool, the total amount of bytes/words/bits setup per Input/Output buffer in the FieldServer configuration map descriptors must match those selected in the network config tool otherwise a connection length mismatch will occur and the connection will not be established. The Fieldserver shows the connection size it expects on the F (driver message) screen in the RUI utility in order that this value may be checked against the network configuration tool.
- The FieldServer may have bridge.bss loaded, which will configure it as a master
 - The bridge.bss file is loaded by default when FieldServers ship with the default Profibus Master configuration. This file must not exist in applications where FieldServer is being used as a slave.
 - To check for the file, try uploading the file from the FieldServer using the RUI Utility. If it uploads successfully, then it will need to be deleted. See the FieldServer Utilities manual for instructions on how to do this.
- The FieldServer may be missing the pfbdp.ss1 file
 - This file is compulsory for all SST Profibus applications, and may be missing for some reason.
 - To check for the file, try uploading the file from the FieldServer using the RUI Utility. If it uploads successfully, then this is not the problem.
- The direction of the communications (Input/Output Buffer) may be incorrectly configured.
 - Buffer names can be confusing, especially when looking at the Slave. The buffers are named according to their direction of communication in the Master.

Hence, an Input buffer in the slave will write data to the master, and data will be received from the master in the output buffer.

- Remember that as a slave, the FieldServer will have to write data into the input buffer (function=wrbc), and read data from the output buffer (function=rdbc).
- The Profibus card may be faulty.
- If this is the case, then there will be an error message in the FieldServer RUI error screen indicating that the card could not be reached. Check for this message. If it is there, try opening up the FieldServer and re-seating the card. If this does not help, contact FieldServer Technical support for jumper settings on the card, and further possible troubleshooting or return authorization.

```

C:\WINDOWS\system32\cmd.exe - rn 20
System Errors
20 T05> File : config.csv, line 93
21 T05> Line : BYTE_IN_01 , DA_BI_01 , 0 , Passive_Client , PDP_01 , BYTE , Inpu
22 T05> ----- Configuration File Error -----
23 T05> Desc : Could not create map descriptor; Prof_DP adapter not initialized
24 T05> Error: 66
25 T05> File : config.csv, line 94
26 T05> Line : BIT_IN_01 , DA_DI_01 , 0 , Passive_Client , PDP_01 , BIT , Input
27 T05> ----- Configuration File Error -----
28 T05> Desc : Could not create map descriptor; Prof_DP adapter not initialized
29 T05> Error: 66
30 T05> File : config.csv, line 95
31 T05> Line : BYTE_IN_01 , DA_BI_01 , 20 , Passive_Client , PDP_01 , BYTE , Inp
32 T05> ----- Configuration File Error -----
33 T05> Desc : Could not create map descriptor; Prof_DP adapter not initialized
34 T05> Error: 66
35 T05> DRU-> PDP : Warning, FLOAT_OUT_01 writing to DP master's output buffer.
36 T05> DRU-> PDP : Be sure this is what you want to do.
37 T05> ----- Configuration File Error -----
38 T05> Desc : Could not create map descriptor; Prof_DP adapter not initialized
39 T05> Error: 66
Keys: <R>reset  Display <U>ersion  <ESC>
      <Page Down> Next Page  <Page Up> Previous Page

```

- The Data Type/Offset/Length combination may be incorrectly set up
 - In the FieldServer configuration, the Offset Parameter almost always refers to the buffer offset in bytes (starting at 0), regardless of data type. The only exception is the BIT data type which specifies offset in bits to allow for offsets that are not a multiple of 8. The Length parameter always refers to length in items, which means Float data will be the number of float values, Word data will be the number of words, etc.

Appendix C.2. FieldServer as a Profibus Master

The most important aspect of using the FieldServer as a Profibus Master is that the .bss file must be configured and loaded into the FieldServer as bridge.bss. The SST configuration tool must be used to configure this file. This tool can be found on the SST CD supplied with the FieldServer.

As a Master, the FieldServer also needs to have the pfbdp.ss1 file loaded, and care must also be taken with direction of communication and Data type/length specification. Note that as a Master, the FieldServer will be writing to Output buffers (function=wrbc) and reading from input buffers (function=rdbc).

Appendix C.3. Error and Informational Messages on Ruinet E and F screens

Master Mode not enabled

This message means that the FieldServer is not set up to be a Profibus DP Master. This indicates that the FieldServer did not find a Master scanner file, (bridge.bss). This message is normal if you configured the FieldServer to be a DP Slave. See the sections on configuring the FieldServer as either a DP Master or Slave.

THIS PAGE INTENTIONALLY LEFT BLANK

Free Manuals Download Website

<http://myh66.com>

<http://usermanuals.us>

<http://www.somanuals.com>

<http://www.4manuals.cc>

<http://www.manual-lib.com>

<http://www.404manual.com>

<http://www.luxmanual.com>

<http://aubethermostatmanual.com>

Golf course search by state

<http://golfingnear.com>

Email search by domain

<http://emailbydomain.com>

Auto manuals search

<http://auto.somanuals.com>

TV manuals search

<http://tv.somanuals.com>