

**INSTRUCTION MANUAL  
GUIDE D'UTILISATION  
MANUAL DE INSTRUCCIONES**

**DEWALT®**

**INSTRUCTION MANUAL  
DW250/DW270 V.S.R. Drywall Screwdriver  
DW250/DW270 Tournevis pour murs secs  
DW250/DW270 Destornillador para tablaroca VVR**

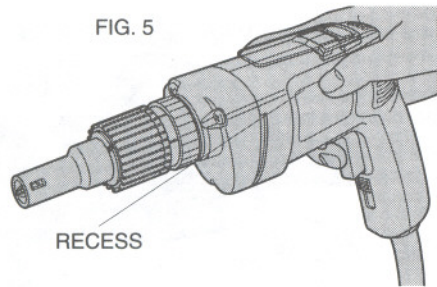

FIG. 5

RECESS

## Maintenance

### CLEANING

With the motor running, blow dirt and dust out of all air vents with dry air at least once a week. Wear safety glasses when performing this. Exterior plastic parts may be cleaned with a damp cloth and mild detergent. Although these parts are highly solvent resistant, NEVER use solvents.

Depth locator and adjustment collar should be removed and dust blown out of clutch area housing at least once a week.

### CHANGING CLUTCHES (FIG. 6)

1. Remove clutch housing by unscrewing in clockwise direction (left hand thread).
2. Clamp tool or clutch housing in a resilient clamp.
3. Remove round clutch retaining rings with a very small screwdriver or sharp pointed tool.
4. Install new clutches and new retaining rings. **NOTE:** If the output spindle slides toward inside of gear case, remove dead spindle spring and thread a 5/16"-18 bolt or cap screw into end of spindle and lift up to expose retaining ring groove. Re-assemble dead spindle spring allowing no more than 1/4" projecting from end of spindle.
5. Relubricate clutches. (See Lubrication.)

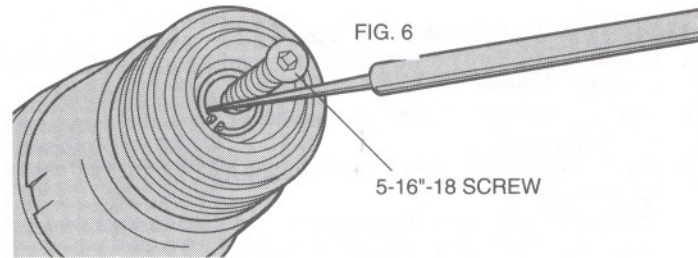

FIG. 6

5-16"-18 SCREW

### Lubrication (Fig. 7)

All bearings are factory lubricated for the life of the bearings. Gearing and gear case should be relubricated every six months or when gear case is removed for servicing as follows: (more often if the tool is used constantly on production jobs)

1. Remove three gear case screws from front and disassemble gear case.
2. Clean out old grease and thoroughly clean all parts.
3. Relubricate gear case and gearing with the quantity of heavy duty grease as called for on parts bulletin.
4. Reassemble.

Clutches should be lubricated at the same time the gearing is relubricated in accordance with the following procedure:

1. Remove clutch housing by unscrewing in clockwise direction. (left hand thread).
2. Slip clutch assembly from clutch housing.
3. Lightly brush or coat areas marked A, B with clutch grease. Coat clutch face inside nose of gear case.
4. Reassemble clutch housing.

IF YOU HAVE ANY QUESTIONS OR COMMENTS ABOUT THIS  
OR ANY DeWALT TOOL, CALL US TOLL FREE AT:  
**1-800-4-DEWALT (1-800-433-9258)**

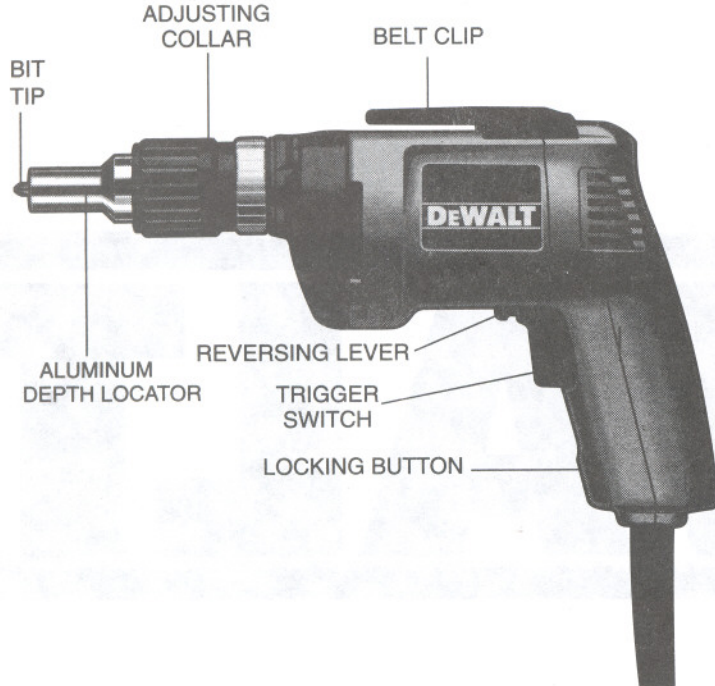

## **Important Safety Instructions**

**WARNING:** When using electric tools, basic safety precautions should always be followed to reduce risk of fire, electric shock, and personal injury, including the following:

**READ ALL INSTRUCTIONS**

### **Double Insulation**

Double insulated tools are constructed throughout with two separate layers of electrical insulation or one double thickness of insulation between you and the tool's electrical system. Tools built with this insulation system are not intended to be grounded. As a result, your tool is equipped with a two prong plug which permits you to use extension cords without concern for maintaining a ground connection.

**NOTE:** Double insulation does not take the place of normal safety precautions when operating this tool. The insulation system is for added protection against injury resulting from a possible electrical insulation failure within the tool.

**CAUTION:** WHEN SERVICING USE ONLY IDENTICAL REPLACEMENT PARTS. Repair or replace damaged cords.

### **Polarized Plugs**

Polarized plugs (one blade is wider than the other) are used on equipment to reduce the risk of electric shock. When provided, this plug will fit into a polarized outlet only one way. If the plug does not fit fully into the outlet, reverse the plug. If it still does not fit, contact a qualified electrician to install the proper outlet. Do not change the plug in any way.



## Safety Instructions For All Tools

- **KEEP WORK AREA CLEAN.** Cluttered areas and benches invite injuries.
- **CONSIDER WORK AREA ENVIRONMENT.** Don't expose power tools to rain. Don't use power tools in damp or wet locations. Keep work area well lit. Do not use tool in presence of flammable liquids or gases.
- **GUARD AGAINST ELECTRIC SHOCK.** Prevent body contact with grounded surfaces. For example; pipes, radiators, ranges, and refrigerator enclosures.
- **KEEP CHILDREN AWAY.** Do not let visitors contact tool or extension cord. All visitors should be kept away from work area.
- **STORE IDLE TOOLS.** When not in use, tools should be stored in dry, and high or locked-up place — out of reach of children.
- **DON'T FORCE TOOL.** It will do the job better and safer at the rate for which it was intended.
- **USE RIGHT TOOL.** Don't force small tool or attachment to do the job of a heavy-duty tool. Don't use tool for purpose not intended.
- **DRESS PROPERLY.** Do not wear loose clothing or jewelry. They can be caught in moving parts. Rubber gloves and non-skid footwear are recommended when working outdoors. Wear protective hair covering to contain long hair.
- **USE SAFETY GLASSES.** Also use face or dust mask if operation is dusty.
- **DON'T ABUSE CORD.** Never carry tool by cord or yank it to disconnect from receptacle. Keep cord from heat, oil, and sharp edges.
- **SECURE WORK.** Use clamps or a vise to hold work. It's safer than using your hand and it frees both hands to operate tool.
- **DON'T OVERREACH.** Keep proper footing and balance at all times.
- **MAINTAIN TOOLS WITH CARE.** Keep tools sharp and clean for better and safer performance. Follow instructions for lubricating and changing accessories. Inspect tool cords periodically and if

damaged, have repaired by authorized service facility. Inspect extension cords periodically and replace if damaged. Keep handles dry, clean, and free from oil and grease.

- **DISCONNECT OR LOCK OFF TOOLS** when not in use, before servicing, and when changing accessories, such as blades, bits, cutters.
- **REMOVE ADJUSTING KEYS AND WRENCHES.** Form habit of checking to see that keys and adjusting wrenches are removed from tool before turning it on.
- **AVOID UNINTENTIONAL STARTING.** Don't carry tool with finger on switch. Be sure switch is off when plugging in.
- **EXTENSION CORDS.** Make sure your extension cord is in good condition. When using an extension cord, be sure to use one heavy enough to carry the current your product will draw. An undersized cord will cause a drop in line voltage resulting in loss of power and overheating. The following table shows the correct size to use depending on cord length and nameplate ampere rating. If in doubt, use the next heavier gage. The smaller the gage number, the heavier the cord.

Minimum Gage for Cord Sets

Volts	Total Length of Cord in Feet				
	0-25	26-50	51-100	101-150	
120V	0-25	26-50	51-100	101-150	
240V	0-50	51-100	101-200	201-300	
Ampere Rating		AWG			
More Than	Not more Than				
0 -	6	18	16	16	14
6 -	10	18	16	14	12
10 -	12	16	16	14	12
12 -	16	14	12	Not Recommended	

- **OUTDOOR USE EXTENSION CORDS.** When tool is used outdoors, use only extension cords intended for use outdoors and so marked.
- **STAY ALERT.** Watch what you are doing. Use common sense. Do not operate tool when you are tired.

- **CHECK DAMAGED PARTS.** Before further use of the tool, a guard or other part that is damaged should be carefully checked to determine that it will operate properly and perform its intended function. Check for alignment of moving parts, binding of moving parts, breakage of parts, mounting, and any other conditions that may affect its operation. A guard or other part that is damaged should be properly repaired or replaced by an authorized service center unless otherwise indicated elsewhere in this instruction manual. Have defective switches replaced by authorized service center. Do not use tool if switch does not turn it on and off.
- **CAUTION:** When drilling or driving into walls, floors or wherever live electrical wires may be encountered, **DO NOT TOUCH ANY METAL PARTS OF THE TOOL!** Hold the tool only by insulated grasping surfaces to prevent electric shock if you drill or drive into a live wire.

## SAVE THESE INSTRUCTIONS

### Switches (Fig. 1 & 2)

To start unit, depress trigger switch; to stop unit, release trigger. To lock trigger in "ON" position for continuous operation, depress trigger and push up locking button "A" Fig. 1, then gently release trigger. To release locking mechanism, depress trigger fully, then release it. Before using the tool (each time) be sure that the lock button release mechanism is working freely.

Be sure to release the switch locking button before disconnecting the plug from the power supply. Failure to do so will cause the tool to start immediately the next time it is plugged in. Damage or injury could result.

The variable speed trigger switch permits speed contro—the farther the trigger is depressed, the higher the speed of the unit.

For maximum tool life, use lower speed only for starting the fastener. Continuous use at lower speed is not recommended.

The reversing switch is located above the trigger switch (Fig. 2). To

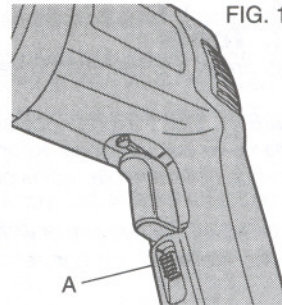

FIG. 1

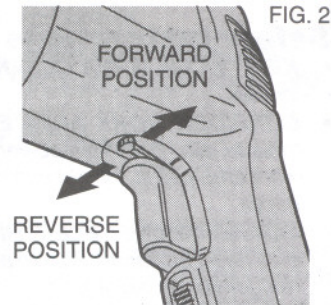

FIG. 2

reverse the motor, release the trigger **FIRST** and then push the lever to the left (when viewed as in Fig. 2). When removing screws, use reversing switch in low speed to keep bit seated firmly in screw head. After any reversing operations, return switch to forward position by pushing it to the right (when viewed as in Fig. 2).

### Brushes

DEWALT uses an advanced brush system which automatically stops the tool when the brushes wear out. This prevents serious damage to the motor.

### Changing Bit Tip (Fig. 3)

1. Pull forward on adjustment collar and remove from clutch housing.
2. Use pliers to remove worn bit.
3. Install new bit tip.

### Dead Spindle Action

All DEWALT screwdrivers provide a "dead" front spindle to permit fasteners to be located in the driving accessory. Clutches are held apart by light spring pressure permitting the driving clutch to rotate without turning the driven clutch and accessory. When sufficient forward pressure is applied to the unit, the clutches engage and rotate the spindle and accessories.



## Depth Adjustment (Fig. 4)

1. Rotate adjustment collar. Clockwise rotation will provide deeper seating of screws.
2. Test drive a fastener in scrap material to determine if fastener is correctly seating.
3. Further adjustment may be necessary to increase or decrease the fastener depth.

**TO INCREASE**, turn the adjustment collar so that end of bit extends further beyond the end of locator.

**TO DECREASE**, turn the adjustment collar so that end of bit is closer to end of locator.

DEWALT screwdrivers have very fine depth settings; each "click" is .007". One complete revolution of the locator collar equals .083" change in depth setting.

## Operation

1. Install bittip in bit tip holder.
2. Adjust depth locator.
3. Check for correct rotation, start screwdriver and place screw on bit.
4. Contact work surface applying forward pressure to drive screw until depth locator contacts work surface. Screwdriver will ratchet automatically disengaging bit from screw.
5. This depth sensitive screwdriver is suitable for driving both deck and drywall screws.

## Tips For Driving Screws Into Deck

1. Select proper length deck screws to insure complete anchoring into the wood.
2. Although the screwdriver will drive drywall screws into decks, we recommend screws specifically designed for deck assembly. Other fasteners may not drive as well or hold as satisfactorily.
3. When using the tool for the first time to drive screws into pressure-treated lumber, practice driving some screws in scrap material to get the "feel" and to adjust for proper seating depth.

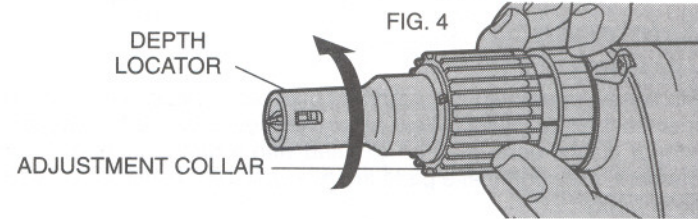
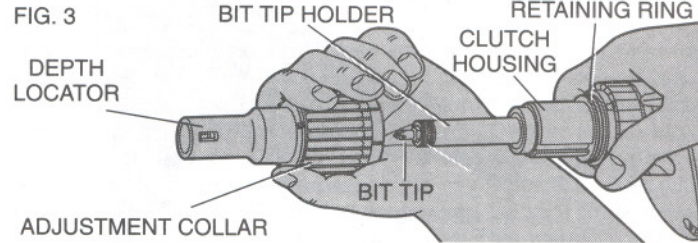

4. Once a screw has started driving, do not stop the screwdriver until the screw is seated. Keep firm pressure on the tool. Because of the high driving torque required in pressure-treated wood, the head of the deck screw may strip if the screwdriver user fails to maintain steady pressure on the bit.
5. More pressure can be applied to the bit if the screwdriver is gripped by sliding the thumb and index finger along the side of the tool near the top. Actuate the trigger with middle finger and/or fourth finger. DEWALT has designed recesses along the top sides of your screwdriver to allow for a comfortable grip. (See Fig. 5.)
6. Before driving deck screws check that there is no gap between the boards to be fastened together.
7. Avoid driving screws through knots. Screws are difficult to start into knots. If a knot can't be avoided, first drill a pilot hole equal in diameter to the body diameter of the deck screw.
8. Keep a few additional bits on hand before starting any job.

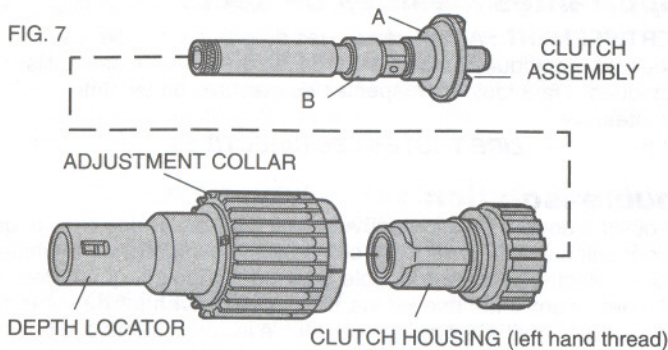

## Accessories

Recommended accessories for use with your tool are available at extra cost from your local dealer or authorized service center. If you need assistance in locating any accessory for your tool, please contact your local dealer or authorized service center.

**CAUTION:** The use of any other accessory not recommended for use with this tool could be hazardous.

## Important

To assure product SAFETY and RELIABILITY, repairs, maintenance and adjustment should be performed by D<sub>E</sub>WALT certified service centers or other qualified service organizations. These service organizations service D<sub>E</sub>WALT tools always using D<sub>E</sub>WALT replacement parts. Black & Decker (U.S.) Inc. industrial tool service centers are certified for servicing D<sub>E</sub>WALT industrial tools.

## Full Warranty

D<sub>E</sub>WALT heavy duty industrial tools are warranted for one year from date of purchase. We will repair, without charge, any defects due to faulty materials or workmanship. Arrangements have been made with the Industrial Tool Division of Black & Decker (U.S.) Inc. to provide warranty repairs for D<sub>E</sub>WALT tools. Please return the complete unit, transportation prepaid, to any Black & Decker (U.S.) Inc. Industrial Service Center or Authorized Service Station listed under "Tools, Electric" in the Yellow Pages. This warranty does not apply to accessories or damage caused where repairs have been made or attempted by others. This warranty gives you specific legal rights and you may have other rights which vary from state to state.

In addition to the warranty, D<sub>E</sub>WALT tools are covered by our:

### 30 DAY NO RISK SATISFACTION GUARANTEE

If you are not completely satisfied with the performance of your DeWalt heavy duty industrial tool, simply return it to the participating seller within 30 days for a full refund. Please return the complete unit, transportation prepaid. Proof of purchase may be required.

Imported by  
Black & Decker (U.S.) Inc.,  
701 E. Joppa Rd.  
Towson, MD 21286 U.S.A.

See 'Tools-Electric'  
- Yellow Pages -  
for Service & Sales



## Free Manuals Download Website

<http://myh66.com>

<http://usermanuals.us>

<http://www.somanuals.com>

<http://www.4manuals.cc>

<http://www.manual-lib.com>

<http://www.404manual.com>

<http://www.luxmanual.com>

<http://aubethermostatmanual.com>

Golf course search by state

<http://golfingnear.com>

Email search by domain

<http://emailbydomain.com>

Auto manuals search

<http://auto.somanuals.com>

TV manuals search

<http://tv.somanuals.com>