

# Comfort Glow®

## VENT-FREE PROPANE/LP GAS COMPACT FIREPLACE

### OWNER'S OPERATION AND INSTALLATION MANUAL

#### CGCF26PRA

15,000 to 26,000 Btu/Hr  
Remote Control Ready

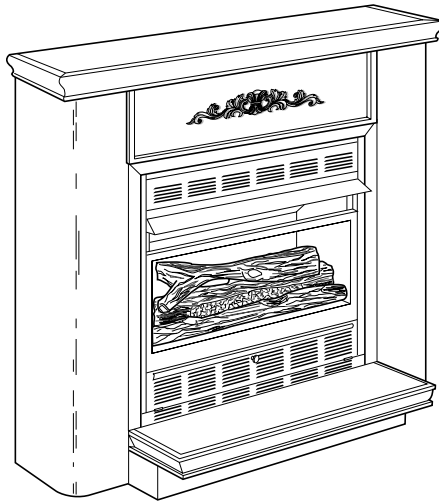

Shown with Optional  
Cabinet Mantel/Hearth  
Base Accessory

**WARNING:** If the information in this manual is not followed exactly, a fire or explosion may result causing property damage, personal injury, or loss of life.

- Do not store or use gasoline or other flammable vapors and liquids in the vicinity of this or any other appliance.
- **WHAT TO DO IF YOU SMELL GAS**
  - Do not try to light any appliance.
  - Do not touch any electrical switch; do not use any phone in your building.
  - Immediately call your gas supplier from a neighbor's phone. Follow the gas supplier's instructions.
  - If you cannot reach your gas supplier, call the fire department.
- Installation and service must be performed by a qualified installer, service agency, or the gas supplier.

**WARNING:** Improper installation, adjustment, alteration, service, or maintenance can cause injury or property damage. Refer to this manual for correct installation and operational procedures. For assistance or additional information consult a qualified installer, service agency, or the gas supplier.

**WARNING:** This is an unvented gas-fired heater. It uses air (oxygen) from the room in which it is installed. Provisions for adequate combustion and ventilation air must be provided. Refer to *Air for Combustion and Ventilation* section on page 5 of this manual.

This appliance may be installed in an aftermarket\* manufactured (mobile) home, where not prohibited by state or local codes.

\*Aftermarket: Completion of sale, not for purpose of resale, from the manufacturer. (I.E. Installation of this product is permitted after the manufactured (mobile) home is sited)

**Save this manual for future reference.**

Download from [Www.Somanuals.com](http://Www.Somanuals.com). All Manuals Search And Download.

## VENT-FREE PROPANE COMPACT FIREPLACE

### SAFETY INFORMATION

#### WARNINGS

**IMPORTANT:** Read this owner's manual carefully and completely before trying to assemble, operate, or service this fireplace. Improper use of this fireplace can cause serious injury or death from burns, fire, explosion, electrical shock, and carbon monoxide poisoning.

** DANGER:** Carbon monoxide poisoning may lead to death!

**Carbon Monoxide Poisoning:** Early signs of carbon monoxide poisoning resemble the flu, with headaches, dizziness, or nausea. If you have these signs, the fireplace may not be working properly. **Get fresh air at once!** Have fireplace serviced. Some people are more affected by carbon monoxide than others. These include pregnant women, people with heart or lung disease or anemia, those under the influence of alcohol, and those at high altitudes.

**Propane Gas:** Propane gas is odorless. An odor-making agent is added to the gas. The odor helps you detect a gas leak. However, the odor added to the gas can fade. Gas may be present even though no odor exists.

Make certain you read and understand all warnings. Keep this manual for reference. It is your guide to safe and proper operation of this fireplace.

** WARNING:** Any change to this fireplace or its controls can be dangerous.

1. This appliance is only for use with the type of gas indicated on the rating plate. This appliance is not convertible for use with other gases.
2. Do not place propane supply tank(s) inside any structure. Locate propane supply tank(s) outdoors.
3. If you smell gas
  - shut off gas supply
  - do not try to light any appliance
  - do not touch any electrical switch; do not use any phone in your building
  - immediately call your gas supplier from a neighbor's phone. Follow the gas supplier's instructions
  - if you cannot reach your gas supplier, call the fire department
4. This fireplace shall not be installed in a bedroom or bathroom.
5. Never install the fireplace
  - in a recreational vehicle.
  - where curtains, furniture, clothing, or other flammable objects are less than 36 inches from the front, top, or sides of the fireplace.
  - as a fireplace insert.
  - in high traffic areas.
  - in windy or drafty areas.
6. Do not use this fireplace as a wood-burning fireplace. Use only the logs provided with the fireplace.
7. Do not add extra logs or ornaments such as pine cones, vermiculite, or rock wool. Using these added items can cause sooting. Do not add lava rock around base. Rock and debris could fall into the control area of fireplace.
8. You must operate this fireplace with the fireplace screen in place. Make sure fireplace screen is in place before running fireplace.
9. This fireplace is designed to be smokeless. If logs ever appear to smoke, turn off fireplace and call a qualified service person. **Note:** During initial operation, slight smoking could occur due to log curing and fireplace burning manufacturing residues.
10. To prevent the creation of soot, follow the instructions in *Cleaning and Maintenance*, page 17.
11. Do not allow fans to blow directly into the fireplace. Avoid any drafts that alter burner flame patterns. Ceiling fans can create drafts that alter burner flame patterns. Altered burner patterns can cause sooting.
12. Before using furniture polish, wax, carpet cleaner, or similar products, turn heater off. If heated, the vapors from these products may create a white powder residue within burner box or on adjacent walls or furniture.
13. This fireplace needs fresh air ventilation to run properly. This fireplace has an oxygen depletion sensor (ODS) pilot light safety system. The ODS shuts down the fireplace if not enough fresh air is available. See *Air for Combustion and Ventilation*, pages 5 through 7. If fireplace keeps shutting off, see *Troubleshooting*, pages 19 through 21.
14. Do not run fireplace
  - where flammable liquids or vapors are used or stored.
  - under dusty conditions.
15. Do not use this fireplace to cook food or burn paper or other objects.
16. Never place any objects in the fireplace or on logs.
17. Fireplace front and screen becomes very hot when running fireplace. Keep children and adults away from hot surfaces to avoid burns or clothing ignition. Fireplace will remain hot for a time after shutdown. Allow surfaces to cool before touching.
18. Carefully supervise young children when they are in same room with fireplace.
19. Do not use fireplace if any part has been under water. Immediately call a qualified service technician to inspect the room fireplace and to replace any part of the control system and any gas control which has been under water.
20. Turn off and unplug fireplace and let cool before servicing. Only a qualified service person should service and repair fireplace.
21. Operating fireplace above elevations of 4,500 feet could cause pilot outage.
22. Do not use a blower insert, heat exchanger insert, or other accessory not approved for use with this fireplace.
23. Do not operate fireplace if any log is broken. Do not operate fireplace if a log is chipped (dime-sized or larger).
24. To prevent performance problems, do not use propane fuel tank of less than 100 lbs. capacity.

# OWNER'S MANUAL

## PRODUCT IDENTIFICATION

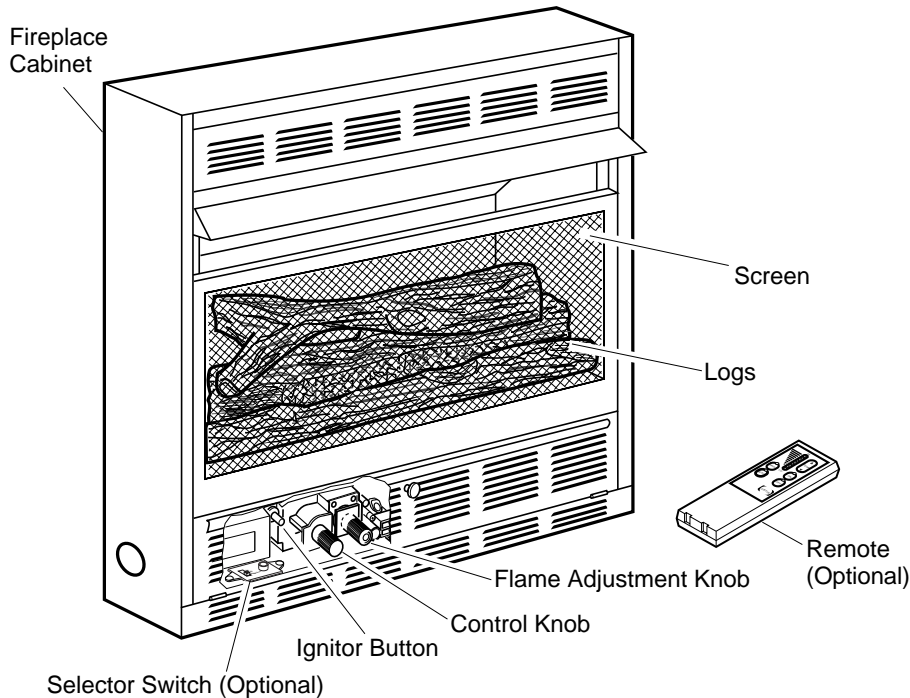

Figure 1 - Vent-Free Propane Gas Compact Fireplace

## LOCAL CODES

Install and use fireplace with care. Follow all local codes. In the absence of local codes, use the latest edition of *The National Fuel Gas Code ANS Z223.1*, also known as NFPA 54\*.

\*Available from:

American National Standards Institute, Inc.  
1430 Broadway  
New York, NY 10018

National Fire Protection Association, Inc.  
Batterymarch Park  
Quincy, MA 02269

## UNPACKING

1. Remove log box and fireplace from carton. The hood is not attached.
2. Remove all protective packaging applied to fireplace for shipment.
3. Make sure your fireplace includes one hardware packet and one remote control packet which includes batteries.
4. Check fireplace for any shipping damage. If fireplace is damaged, promptly inform dealer where you bought fireplace.

## PRODUCT FEATURES

### SAFETY PILOT

This fireplace has a pilot with an Oxygen Depletion Sensor Shutoff System (ODS). The ODS/pilot is a required feature for vent-free room fireplaces. The ODS/pilot shuts off the fireplace if there is not enough fresh air.

### PIEZO IGNITION SYSTEM

This fireplace has a piezo ignitor. This system requires no matches, batteries, or other sources to light fireplace.

## REMOTE CONTROL ACCESSORIES

There are four optional remote controls that can be purchased separately for this log heater:

- hand-held ON/OFF remote
- hand-held thermostat remote

See *Accessories*, page 24.

# VENT-FREE PROPANE COMPACT FIREPLACE

## ASSEMBLY

**⚠ WARNING:** Always have branch support and screen in place before operating fireplace. This prevents excessive temperatures on fireplace surfaces.

### ASSEMBLING FIREPLACE

Tools Required:

- Phillips screwdriver,
- 5/16" hex wrench
- Slotted screwdriver

### Installing Log

1. Remove back log, branch, and hood from log box. Discard protective packaging.
2. Remove two shipping screws above screen (see Figure 2).
3. Lift screen up and pull out to remove.
4. An optional blower is available. See *Accessories*, page 24. Install optional blower now. Follow installation instructions provided with blower.
5. Gently place back log on burner support (see Figure 2). The log should fit flat against top of burner support. Place two #10 one-inch-long screws through burner support into the log and tighten. Place branches on branch support (see Figure 2).
6. Do not allow branch to contact flame. If flame contacts branch, soot will be created.
7. Reattach screen by placing notches in screen frame over shoulder screws and pushing down.

**⚠ WARNING:** Failure to position the parts in accordance with these diagrams or failure to use only parts specifically approved with this fireplace may result in property damage or personal injury.

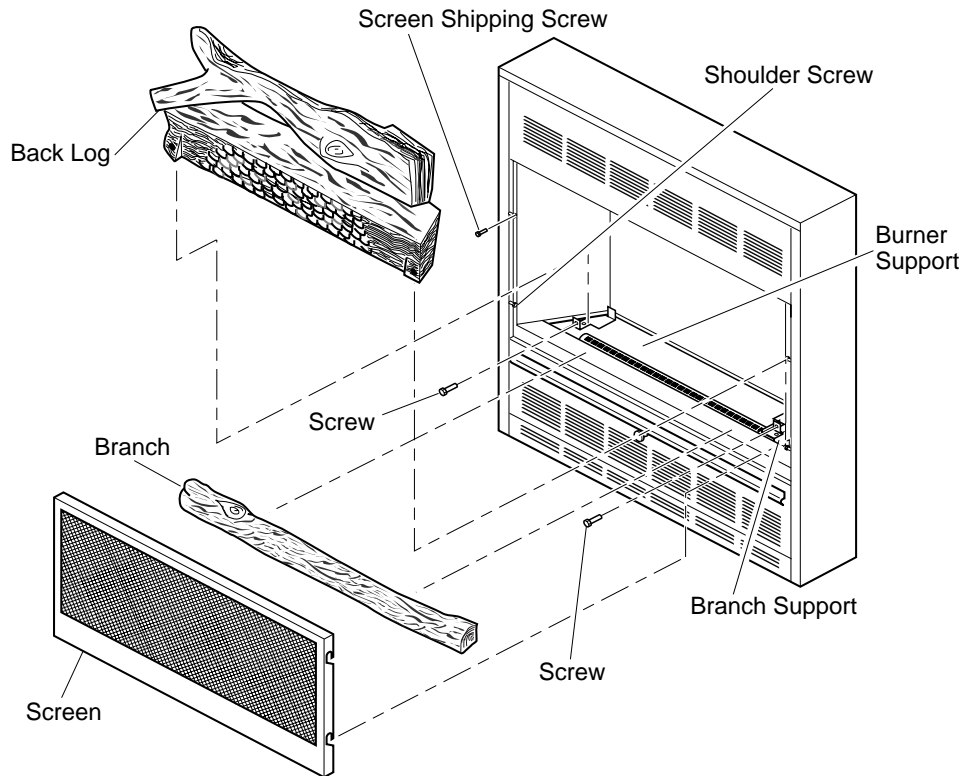

Figure 2 - Assembling Fireplace

### Assembling Hood

1. Locate four #10-3/8" black phillips sheet metal screws from the hardware packet.
2. Remove two 1 3/4" screws from underneath middle rail (see Figure 3).
3. Slip top of hood between middle rail and top of firebox wrapper (see Figure 3).
4. Reinstall two 1 3/4" screws removed in step 2. Make sure screw pass through hood and middle rail and attach into upper louver assembly (see Figure 3).
5. Attach four #10-3/8" hood screws as shown in Figure 3.

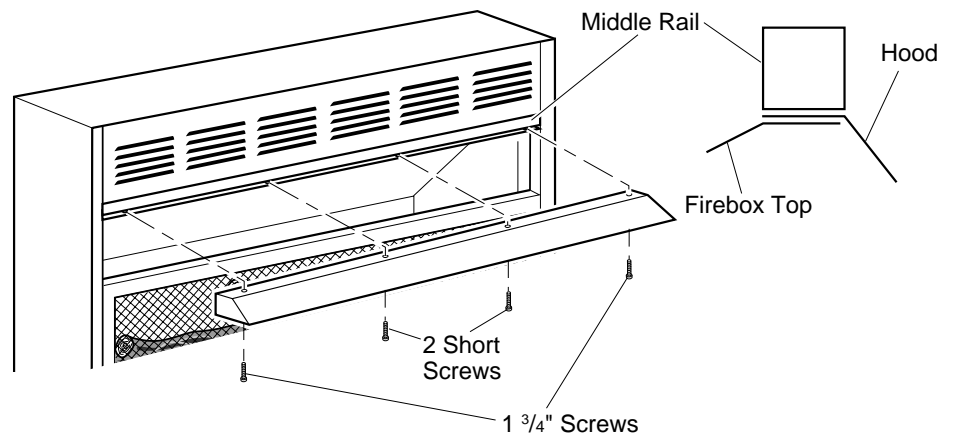

Figure 3 - Assembling Hood

## AIR FOR COMBUSTION AND VENTILATION

**⚠ WARNING: This heater shall not be installed in a confined space or unusually tight construction unless provisions are provided for adequate combustion and ventilation air. Read the following instructions to insure proper fresh air for this and other fuel-burning appliances in your home.**

Today's homes are built more energy efficient than ever. New materials, increased insulation, and new construction methods help reduce heat loss in homes. Home owners weather strip and caulk around windows and doors to keep the cold air out and the warm air in. During heating months, home owners want their homes as airtight as possible.

While it is good to make your home energy efficient, your home needs to breathe. Fresh air must enter your home. All fuel-burning appliances need fresh air for proper combustion and ventilation.

Exhaust fans, fireplaces, clothes dryers, and fuel burning appliances draw air from the house to operate. You must provide adequate fresh air for these appliances. This will insure proper venting of vented fuel-burning appliances.

## PROVIDING ADEQUATE VENTILATION

The following are excerpts from *National Fuel Gas Code. NFPA 54/ANS Z223.1, Section 5.3, Air for Combustion and Ventilation.*

All spaces in homes fall into one of the three following ventilation classifications:

1. Unusually Tight Construction
2. Unconfined Space
3. Confined Space

The information on pages 5 through 7 will help you classify your space and provide adequate ventilation.

### Unusually Tight Construction

The air that leaks around doors and windows may provide enough fresh air for combustion and ventilation. However, in buildings of unusually tight construction, you must provide additional fresh air.

**Unusually tight construction is defined as construction where:**

- a. **walls and ceilings exposed to the outside atmosphere have a continuous water vapor retarder with a rating of one perm ( $6 \times 10^{-11}$  kg per pa-sec- $m^2$ ) or less with openings gasketed or sealed *and***
- b. **weather stripping has been added on openable windows and doors *and***
- c. **caulking or sealants are applied to areas such as joints around window and door frames, between sole plates and floors, between wall-ceiling joints, between wall panels, at penetrations for plumbing, electrical, and gas lines, and at other openings.**

**If your home meets all of the three criteria above, you must provide additional fresh air. See *Ventilation Air From Outdoors*, page 7.**

**If your home does not meet all of the three criteria above, proceed to *Determining Fresh-Air Flow For Fireplace Location*, page 6.**

## Confined and Unconfined Space

*The National Fuel Gas Code (ANS Z223.1, 1992 Section 5.3)* defines a confined space as a space whose volume is less than 50 cubic feet per 1,000 Btu per hour (4.8 m<sup>3</sup> per kw) of the aggregate input rating of all appliances installed in that space and an unconfined space as a space whose volume is not less than 50 cubic feet per 1,000 Btu per hour (4.8 m<sup>3</sup> per kw) of the aggregate input rating of all appliances installed in that space. Rooms communicating directly with the space in which the appliances are installed\*, through openings not furnished with doors, are considered a part of the unconfined space.

This heater shall not be installed in a confined space or unusually tight construction unless provisions are provided for adequate combustion and ventilation air.

\* Adjoining rooms are communicating only if there are doorless passageways or ventilation grills between them.

*Continued*

# VENT-FREE PROPANE COMPACT FIREPLACE

## AIR FOR COMBUSTION AND VENTILATION

*Continued*

### DETERMINING FRESH-AIR FLOW FOR FIREPLACE LOCATION

#### Determining if You Have a Confined or Unconfined Space

Use this worksheet to determine if you have a confined or unconfined space.

**Space:** Includes the room in which you will install fireplace plus any adjoining rooms with doorless passageways or ventilation grills between the rooms.

1. Determine the volume of the space (length x width x height).

Length x Width x Height = \_\_\_\_\_ cu. ft. (volume of space)

*Example:* Space size 20 ft. (length) x 16 ft. (width) x 8 ft. (ceiling height) = 2560 cu. ft. (volume of space)

If additional ventilation to adjoining room is supplied with grills or openings, add the volume of these rooms to the total volume of the space.

2. Divide the space volume by 50 cubic feet to determine the maximum Btu/Hr the space can support.

\_\_\_\_\_ (volume of space) ÷ 50 cu. ft. = (Maximum Btu/Hr the space can support)

*Example:* 2560 cu. ft. (volume of space) ÷ 50 cu. ft. = 51.2 or 51,200 (maximum Btu/Hr the space can support)

3. Add the Btu/Hr of all fuel burning appliances in the space.

Vent-free fireplace \_\_\_\_\_ Btu/Hr

Gas water heater\* \_\_\_\_\_ Btu/Hr

Gas furnace \_\_\_\_\_ Btu/Hr

Vented gas heater \_\_\_\_\_ Btu/Hr

Gas fireplace logs \_\_\_\_\_ Btu/Hr

Other gas appliances\* + \_\_\_\_\_ Btu/Hr

Total = \_\_\_\_\_ Btu/Hr

*Example:*

Gas water heater                      30,000      Btu/Hr

Vent-free fireplace +                26,000      Btu/Hr

Total                                      =            56,000      Btu/Hr

\* Do not include direct-vent gas appliances. Direct-vent draws combustion air from the outdoors and vents to the outdoors.

4. Compare the maximum Btu/Hr the space can support with the actual amount of Btu/Hr used.

\_\_\_\_\_ Btu/Hr (maximum the space can support)

\_\_\_\_\_ Btu/Hr (actual amount of Btu/Hr used)

*Example:* 51,200 Btu/Hr (maximum the space can support)

56,000 Btu/Hr (actual amount of Btu/Hr used)

The space in the above example is a confined space because the actual Btu/Hr used is more than the maximum Btu/Hr the space can support. You must provide additional fresh air. Your options are as follows:

- A. Rework worksheet, adding the space of an adjoining room. If the extra space provides an unconfined space, remove door to adjoining room or add ventilation grills between rooms. See *Ventilation Air From Inside Building, page 7.*
- B. Vent room directly to the outdoors. See *Ventilation Air From Outdoors, page 7.*
- C. Install a lower Btu/Hr fireplace, if lower Btu/Hr size makes room unconfined.

If the actual Btu/Hr used is less than the maximum Btu/Hr the space can support, the space is an unconfined space. You will need no additional fresh air ventilation.

**⚠ WARNING:** If the area in which the heater may be operated is smaller than that defined as an unconfined space or if the building is of unusually tight construction, provide adequate combustion and ventilation air by one of the methods described in the *National Fuel Gas Code, ANS Z223.1, 1992, Section 5.3* or applicable local codes.

## AIR FOR COMBUSTION AND VENTILATION

*Continued*

### VENTILATION AIR

#### Ventilation Air From Inside Building

This fresh air would come from an adjoining unconfined space. When ventilating to an adjoining unconfined space, you must provide two permanent openings: one within 12" of the ceiling and one within 12" of the floor on the wall connecting the two spaces (see options 1 and 2, Figure 4). You can also remove door into adjoining room (see option 3, Figure 4). Follow the *National Fuel Gas Code NFPA 54/ANS Z223.1, Section 5.3, Air for Combustion and Ventilation* for required size of ventilation grills or ducts.

**⚠ WARNING:** Rework worksheet, adding the space of the adjoining unconfined space. The combined spaces must have enough fresh air to supply all appliances in both spaces.

#### Ventilation Air From Outdoors

Provide extra fresh air by using ventilation grills or ducts. You must provide two permanent openings: one within 12" of the ceiling and one within 12" of the floor. Connect these items directly to the outdoors or spaces open to the outdoors. These spaces include attics and crawl spaces.

**IMPORTANT:** Do not provide openings for inlet or outlet air into attic if attic has a thermostat-controlled power vent. Heated air entering the attic will activate the power vent.

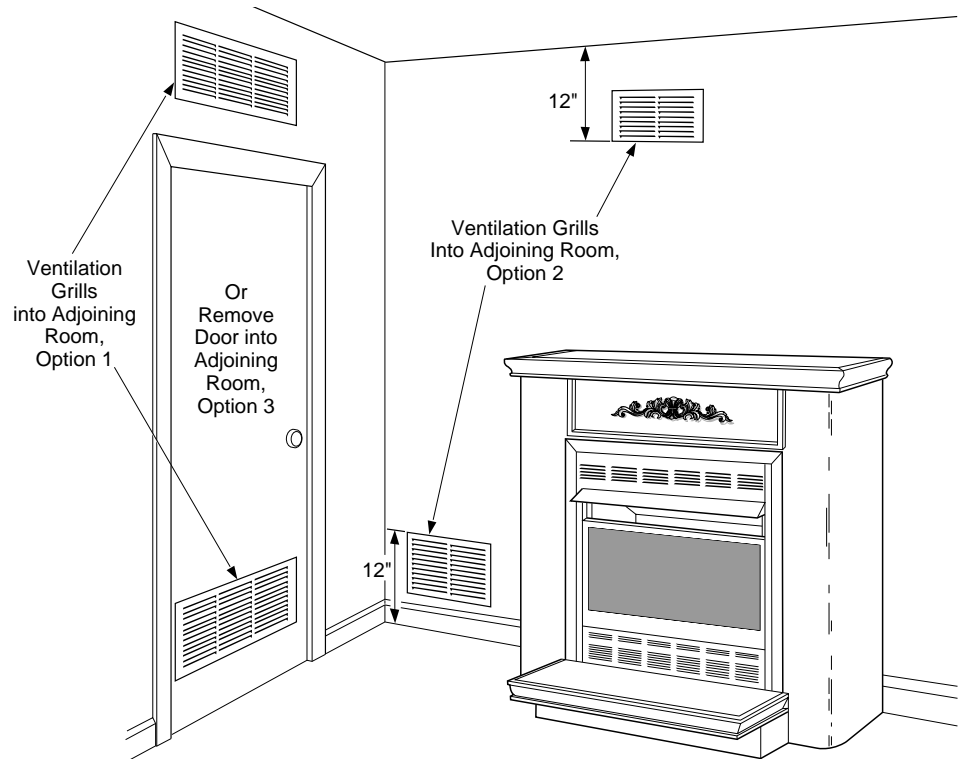

Figure 4 - Ventilation Air from Inside Building Shown with Optional Mantel

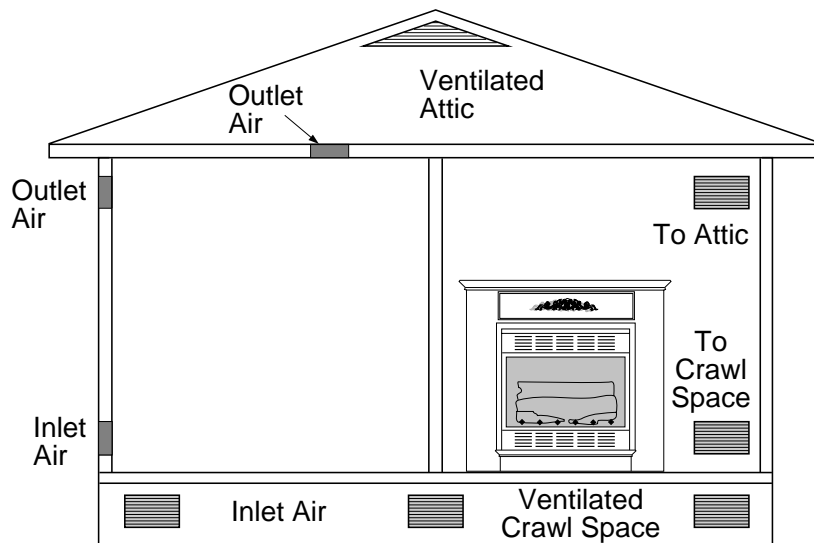

Figure 5 - Ventilation Air from Outdoors Shown with Optional Mantel

# VENT-FREE PROPANE COMPACT FIREPLACE

## INSTALLATION

**NOTICE:** This heater is intended for use as supplemental heat. Use this heater along with your primary heating system. Do not install this heater as your primary heat source. If you have a central heating system, you may run system's circulating blower while using heater. This will help circulate the heat throughout the house. In the event of a power outage, you can use this heater as your primary heat source.

**NOTICE:** A qualified service person must install fireplace. Follow all local codes.

*Note:* Your Comfort Glow fireplace is designed to be used in zero clearance installations. Wall or framing material can be placed directly against any exterior surface of your fireplace, except where standoff spacers are integrally attached. If standoff spacers are attached to your fireplace, these spacers can be placed directly against wall or framing materials.

Use the dimensions shown for rough openings to create the easiest installation (see *Built-In Fireplace Installation*, page 9).

### CHECK GAS TYPE

Use only propane gas. If your gas supply is not propane, do not install fireplace. Call dealer where you bought fireplace for proper type fireplace.

### INSTALLATION ITEMS

Before installing fireplace, make sure you have the items listed below.

- external regulator (supplied by installer)
- piping (check local codes)
- sealant (resistant to propane/LP gas)
- manual shutoff valve \*
- ground joint union
- sediment trap
- tee joint
- pipe wrench
- test gauge connection\*

\* An A.G.A. design-certified manual shutoff valve with 1/8" NPT tap is an acceptable alternative to test gauge connection. Purchase the optional A.G.A. design-certified manual shutoff valve from your dealer. See *Accessories*, page 24.

*Note:* If desired, purchase a four-sided brass trim kit for built-in installations. See *Accessories*, page 24.

### LOCATING FIREPLACE

**WARNING:** Maintain the minimum clearances shown in Figures 6 and 7. If you can, provide greater clearances from floor, ceiling, and joining wall.

You can recess firebox into the wall. You can also position fireplace in the optional cabinet or corner mantels. **IMPORTANT:** Only use optional cabinet or corner mantels specified in this manual. Purchase the optional mantel from your dealer (see *Accessories*, page 24).

**WARNING:** Never install the fireplace

- in a bedroom or a bathroom
- in a recreational vehicle
- where curtains, furniture, clothing, or other flammable objects are less than 36 inches from the front, top, or sides of the fireplace
- as a fireplace insert
- in high traffic areas
- in windy or drafty areas

**CAUTION:** This fireplace creates warm air currents. These currents move heat to wall surfaces next to fireplace. Installing fireplace next to vinyl or cloth wall coverings or operating fireplace where impurities (such as tobacco smoke, aromatic candles, cleaning fluids, oil or kerosene lamps, etc.) in the air exist, may discolor walls.

**IMPORTANT:** Vent-free fireplaces add moisture to the air. Although this is beneficial, installing fireplace in rooms without enough ventilation air may cause mildew to form from too much moisture. See *Air for Combustion and Ventilation*, pages 5 through 7.

**CAUTION:** If you install the fireplace in a home garage

- fireplace pilot and burner must be at least 18 inches above floor.
- locate fireplace where moving vehicle will not hit it.

For convenience and efficiency, install fireplace

- where there is easy access for operation, inspection, and service.
- in coldest part of room.

An optional blower kit is available from your dealer. See *Accessories*, page 24. If planning to use blower, locate fireplace near an electrical outlet.

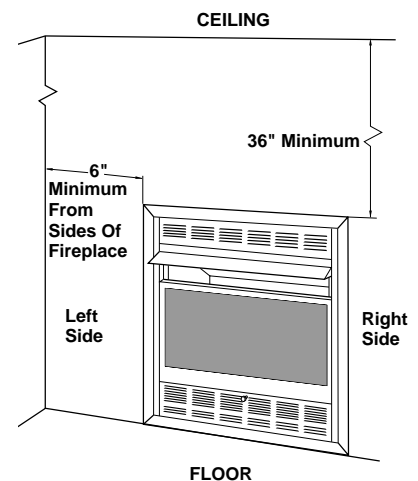

Figure 6 - Mounting Clearances As Viewed From Front of Fireplace Shown Built In The Wall

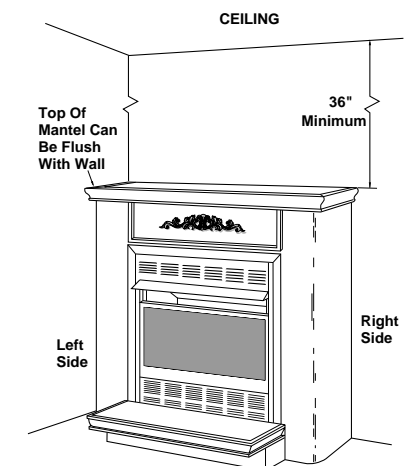

Figure 7 - Mounting Clearances As Viewed From Front of Fireplace Shown with Optional Mantel



## INSTALLATION

### Continued

### BUILT-IN FIREPLACE INSTALLATION

Built-in installation of this fireplace involves installing fireplace into a framed-in enclosure. This makes the front of fireplace flush with wall. An optional brass trim kit accessory is available (see *Accessories*, page 24). Brass trim will extend past sides of fireplace approximately 1/2 inch. This will cover the rough edges of the wall opening. If installing a built-in mantel above the fireplace, but you must follow the clearances shown in Figure 11, page 10. Follow the instructions below to install the fireplace in this manner.

	Actual	Framing
Height	26"	26 7/8"
Front Width	26 3/4"	26 7/8"
Depth	9 1/2"	10 1/2"
Bottom	3/4"	3/4"

1. Frame in rough opening. Use dimensions shown in Figure 8 for the rough opening.

If installing in a corner, use dimensions shown in Figure 9 for the rough opening. The height is 26 1/8" which is the same as the wall opening above.

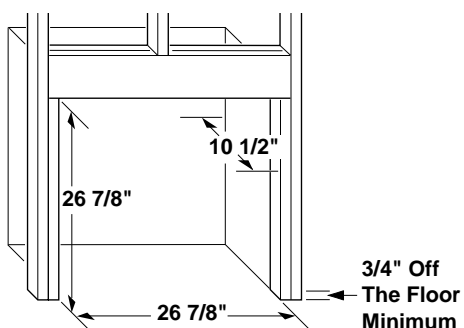

Figure 8 - Rough Opening for Installing in Wall

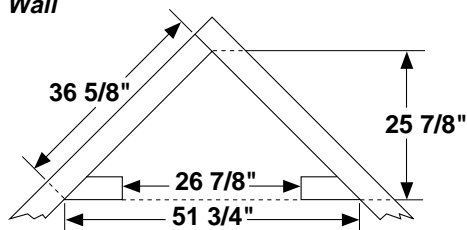

Figure 9 - Rough Opening for Installing in Corner

2. An optional blower accessory is available (see *Accessories*, page 24). There are two options for connecting blower to electrical source.

**Option one:** Have a licensed electrician install a properly grounded, three-prong 120-volt electrical outlet at fireplace location. Locate outlet inside the framed enclosure. Blower power cord will plug into this outlet.

**Option two:** Have a licensed electrician connect blower to electrical source at junction box inside fireplace.

If using option one, have electrical outlet installed at this time. If using option two, do not connect blower to electrical source at junction box until step 7.

3. Install gas piping to fireplace location. This installation includes an approved flexible gas line (if allowed by local codes) after the manual shutoff valve. The flexible gas line must be the last item installed on the gas piping.
4. If you have not assembled firebox, follow instructions on page 4.
5. Carefully set fireplace in front of rough opening with back of fireplace inside wall opening.
6. Attach flexible gas line to fireplace gas regulator. See *Connecting Fireplace to Gas Supply*, page 12.
7. If the optional blower has been installed connect blower to electrical source.

**Option one:** Route blower electrical cord through side or rear access door of fireplace. Plug electrical cord into electrical outlet.

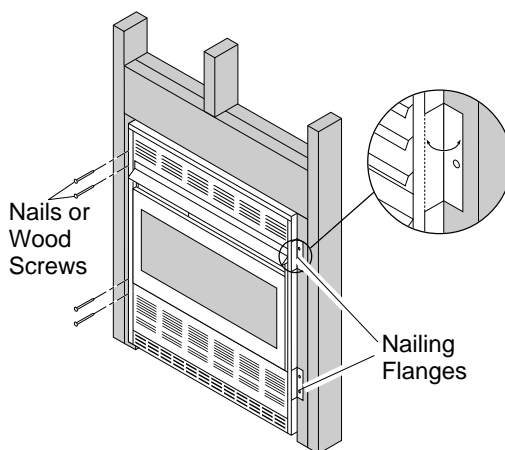

Figure 10 - Attaching Fireplace to Wall Studs

**Option two:** Have a licensed electrician connect blower to electrical source at junction box inside fireplace.

8. Bend four nailing flanges on outer casing with pliers (see Figure 10).
9. Attach fireplace to wall studs using nails or wood screws through holes in nailing flange.
10. Check all gas connections for leaks. See *Checking Gas Connections*, page 13.
11. If using optional brass trim kit, install the trim after final finishing and/or painting of wall. See instructions included with brass trim accessory for attaching brass trim.

**IMPORTANT:** When finishing your firebox, combustible materials such as wall board, gypsum board, sheet rock, drywall, plywood, etc. may be butted up next to the sides and top of the firebox. Combustible materials should never overlap the firebox front facing.

**WARNING:** Do not allow any combustible materials to overlap the firebox front facing.

**IMPORTANT:** Noncombustible materials such as brick, tile, etc. may overlap the front facing, but should never cover any necessary openings like louvered slots.

**WARNING:** Do not allow noncombustible materials to cover any necessary openings like louvered slots.

**WARNING:** Never modify or cover the louvered slots on the front of the firebox.

**WARNING:** Use only noncombustible mortar or adhesives when overlapping the front facing with noncombustible facing material.

Continued

# VENT-FREE PROPANE COMPACT FIREPLACE

## INSTALLATION

### Continued

### MANTEL CLEARANCES FOR BUILT-IN INSTALLATION

If placing mantel above built-in fireplace, you must meet minimum clearance between mantel shelf and top of fireplace opening. If your installation does not meet the minimum clearances in Figure 11, you must:

- raise the mantel to an acceptable height,
- OR
- remove the mantel.

### OPTIONAL MANTEL INSTALLATION

*Note:* Refer to instructions provided with the mantel for assembly instructions. Refer to instructions below for system installation. Refer to instructions on page 4 for firebox assembly. Blower accessory should be installed if it is being used (see *Accessories*, page 24).

1. Unscrew four brass screws that attach top louver to fireplace. Remove louver from fireplace and set aside.
2. Place fireplace on wood base.
3. Place mantel around fireplace/base assembly.
4. Assemble brass trim kit. See *Assembling Brass Trim*.
5. Firmly snap brass trim kit on shoulder screws. Shoulder screws are located on fireplace cabinet (see Figure 12).
6. Align brass trim kit for flush fit around opening.
7. Use two 3" wood screws provided and attach fireplace base to wooden base (see Figure 12).
8. Remove brass trim kit and mantel. Be careful not to damage wall or mantel.
9. Place wood base next to wall at installation location.
10. Attach wood base to floor with two 1 3/4" black screws provided (see Figure 13). If the floor is concrete use anchor method (see *Attaching Wood Base to Solid Floor*, page 11).
11. Install gas line. See *Connecting To Gas Supply*, page 11.
12. Check for leaks. See *Checking Gas Connections*, page 13.

13. Place mantel around fireplace. Be careful not to damage wall or mantel.
14. Place brass trim kit on the shoulder screws located on the side and top of the fireplace. Firmly snap the brass trim over the shoulder screws on fireplace (see Figure 12).
15. Adjust assembly to remove any gaps. Attach remaining two 3" wood screws from hardware pack through openings inside of fireplace sides into the mantel. The openings are located at top behind the area for the brass louvers (see Figure 13).
16. Reinstall top brass louvers.

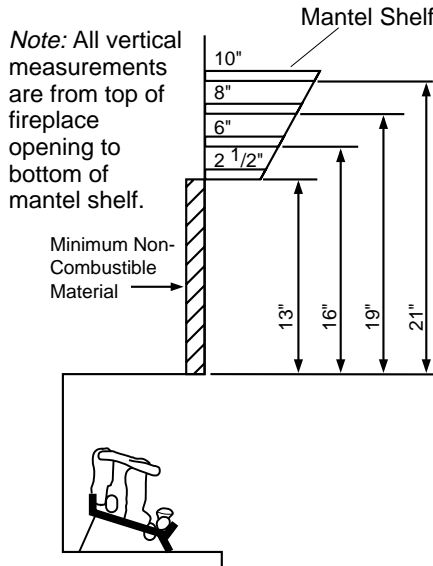

**Figure 11 - Minimum Mantel Clearances for Built-In Installation**

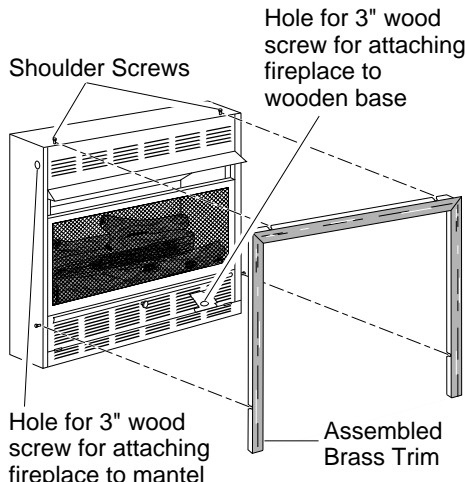

**Figure 12 - Attaching Brass Trim to Fireplace**

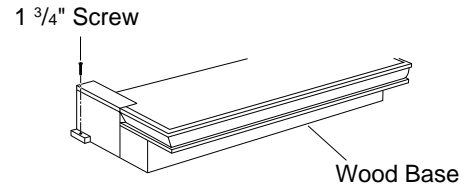

**Figure 13 - Attaching Wood Base to Floor**

### Assembling Brass Trim (Brass trim shipped with mantel)

1. Remove packaging from three remaining pieces of brass trim.
2. Locate two adjusting plates with set screws, and two shims in the hardware packet.
3. Align shim under adjusting plate as shown in Figure 14.
4. Slide one end of adjusting plate/shim in slot on mitered edge of top brass trim (see Figure 14).
5. Slide other end of adjusting plate/shim in slot on mitered edge of side brass trim (see Figure 14).
6. While firmly holding edges of brass trim together, tighten both set screws on the adjusting plate with slotted screwdriver.
7. Repeat steps 1 through 6 for other corner.
8. Set Brass Assembly aside for later installation.

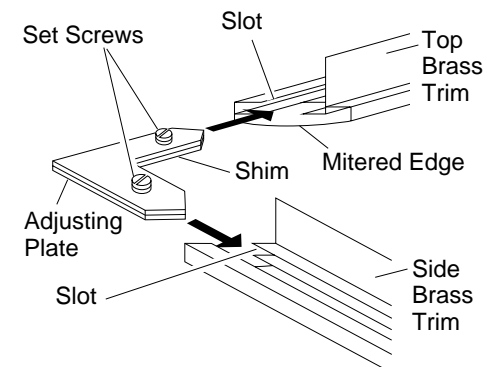

**Figure 14 - Assembling Brass Trim**

# OWNER'S MANUAL

## INSTALLATION

### Continued

#### Attaching Wood Base to Solid Floor

For attaching base to solid floors (concrete or masonry)

**Note:** Floor anchors and mounting screws are in hardware package. The hardware package is provided with fireplace.

1. Drill holes at marked locations using 5/16" drill bit. For solid floors (concrete or masonry), drill at least 1" deep.
2. Fold floor anchor as shown in Figure 15.
3. Insert floor anchor (wings first) into hole. Tap anchor flush to floor.
4. Insert mounting screws through base and into floor anchors.
5. Tighten screws until base is firmly fastened to floor.

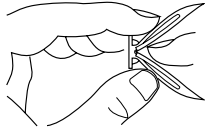

Figure 15 - Folding Anchor

#### CONNECTING TO GAS SUPPLY

**NOTICE:** A qualified service person must connect fireplace to gas supply. Follow all local codes.

**CAUTION:** Never connect fireplace directly to the propane supply. This fireplace requires an external regulator (not supplied). Install the external regulator between the fireplace and propane supply.

The installer must supply an external regulator. The external regulator will reduce incoming gas pressure. You must reduce incoming gas pressure to between 11 and 14 inches of water. If you do not reduce incoming gas pressure, fireplace regulator damage could occur. Install external regulator with the vent pointing down as shown in Figure 16. Pointing the vent down protects it from freezing rain or sleet.

**CAUTION:** Use only new, black iron or steel pipe. Internally-tinned copper tubing may be used in certain areas. Check your local codes. Use pipe of 1/2" or greater diameter to allow proper gas volume to fireplace. If pipe is too small, undue loss of pressure will occur.

Installation must include a manual shutoff valve, union, and plugged 1/8" NPT tap. Locate NPT tap within reach for test gauge hook up. NPT tap must be upstream from fireplace (see Figure 17).

Apply pipe joint sealant lightly to male threads. This will prevent excess sealant from going into pipe. Excess sealant in pipe could result in clogged fireplace valves.

**CAUTION:** Use pipe joint sealant that is resistant to liquid petroleum (LP) gas.

Install sediment trap in supply line as shown in Figure 17. Locate sediment trap where it is within reach for cleaning. Locate sediment trap where trapped matter is not likely to freeze. A sediment trap traps moisture and contaminants. This keeps them from going into fireplace controls. If sediment trap is not installed or is installed wrong, fireplace may not run properly.

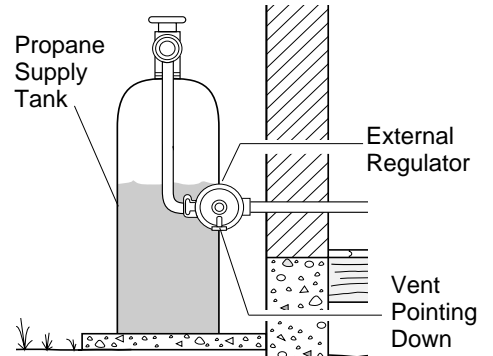

Figure 16 - External Regulator with Vent Pointing Down

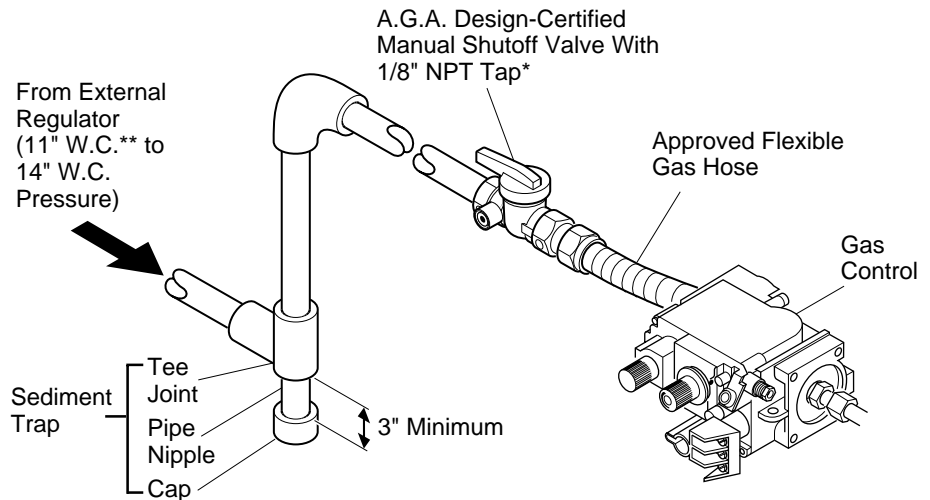

Figure 17 - Gas Connection

\* Purchase the optional A.G.A. design-certified manual shutoff valve from your dealer. See *Accessories*, page 24.

\*\* Minimum inlet pressure for purpose of input adjustment.

# VENT-FREE PROPANE COMPACT FIREPLACE

## INSTALLATION

*Continued*

### CONNECTING FIREPLACE TO GAS SUPPLY

#### Installation Items Needed

- Phillips screwdriver
- sealant (resistant to propane gas, not provided)

1. Remove fireplace screen. Remove two screws that hold fireplace screen in place for shipping. These screws are located near top of screen. Discard screws. Lift fireplace screen up and pull out to remove.
2. Remove screws that attach branch support to fireplace (see Figure 18). Carefully lift up branch support and remove from fireplace (see Figure 18).
3. Route flexible gas line (provided by installer) from manual shutoff valve into fireplace through side or rear access holes in outer casing. Route flexible gas supply line through fireplace access holes in outer casing.

**NOTICE: Most building codes do not permit concealed gas connections. A flexible gas line is provided to allow accessibility from the fireplace (see Figure 19). The flexible gas supply line connection to the manual shutoff valve should be accessible.**

4. Apply pipe joint sealant lightly to male threads of gas connector attached to flexible gas line (see Figure 19). Connect flexible gas line to flexible gas line attached to gas valve of fireplace (see Figure 19).
5. Check all gas connections for leaks. See *Checking Gas Connections*, page 13.
6. Replace branch support back into fireplace. Feed flexible gas line into fireplace base area while replacing branch support. Make sure the entire flexible gas line is in fireplace base area. Reattach branch support to fireplace with screws removed in step 2.

**⚠ CAUTION: Avoid damage to regulator. Hold gas regulator with wrench when connecting it to gas piping and/or fittings.**

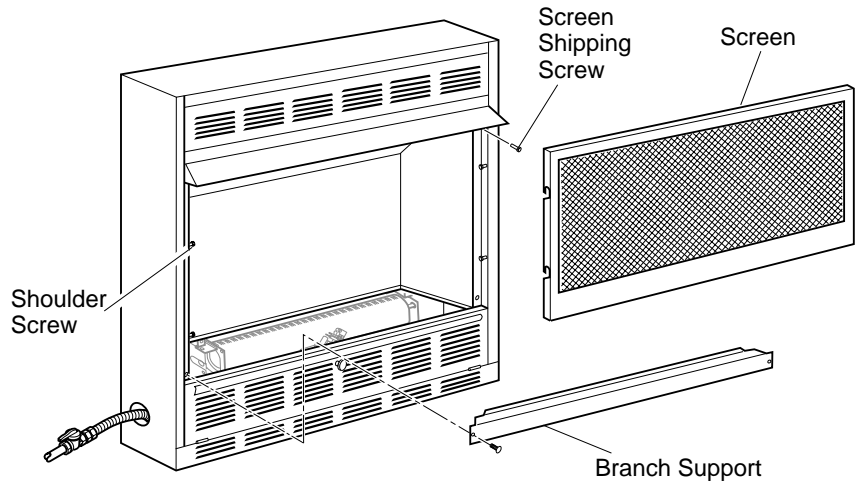

**Figure 18 - Removing Branch Support From Fireplace**

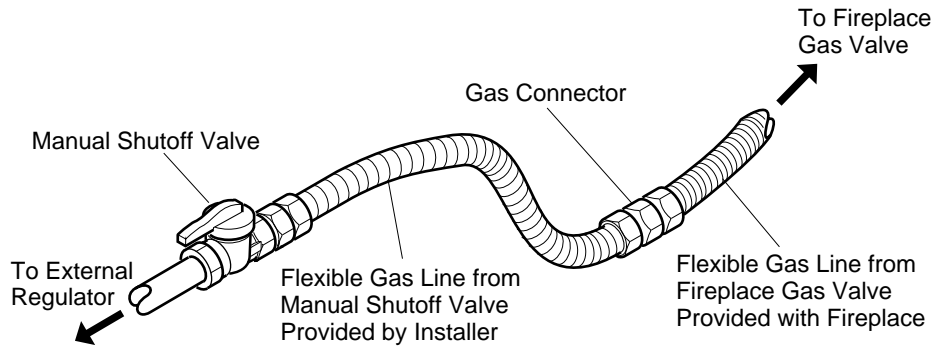

**Figure 19 - Attaching Flexible Gas Lines Together**

## INSTALLATION

*Continued*

### CHECKING GAS CONNECTIONS

**⚠ WARNING:** Test all gas piping and connections for leaks after installing or servicing. Correct all leaks at once.

**⚠ WARNING:** Never use an open flame to check for a leak. Apply a mixture of liquid soap and water to all joints. Bubbles forming show a leak. Correct all leaks at once.

**⚠ CAUTION:** Make sure external regulator has been installed between propane supply and fireplace. See guidelines under *Connecting to Gas Supply*, page 11.

### Pressure Testing Gas Supply Piping System

#### Test Pressures In Excess Of 1/2 PSIG

1. Disconnect fireplace and its individual manual shutoff valve from gas supply piping system. Pressures in excess of 1/2 psig will damage fireplace regulator.
2. Cap off open end of gas pipe where manual shutoff valve was connected.
3. Pressurize supply piping system by either using compressed air or opening propane supply tank valve.
4. Check all joints of gas supply piping system. Apply mixture of liquid soap and water to gas joints. Bubbles forming show a leak.
5. Correct all leaks at once.
6. Reconnect heater and manual shutoff valve to gas supply. Check reconnected fittings for leaks.

#### Test Pressures Equal To or Less Than 1/2 PSIG

1. Close manual shutoff valve (see Figure 20).
2. Pressurize supply piping system by either using compressed air or opening propane supply tank valve.
3. Check all joints from propane supply tank to manual shutoff valve (see Figure 21). Apply mixture of liquid soap and water to gas joints. Bubbles forming show a leak.
4. Correct all leaks at once.

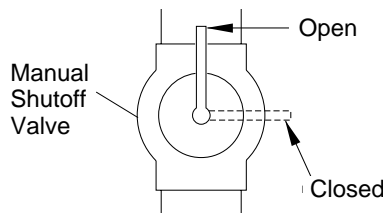

**Figure 20 - Manual Shutoff Valve**

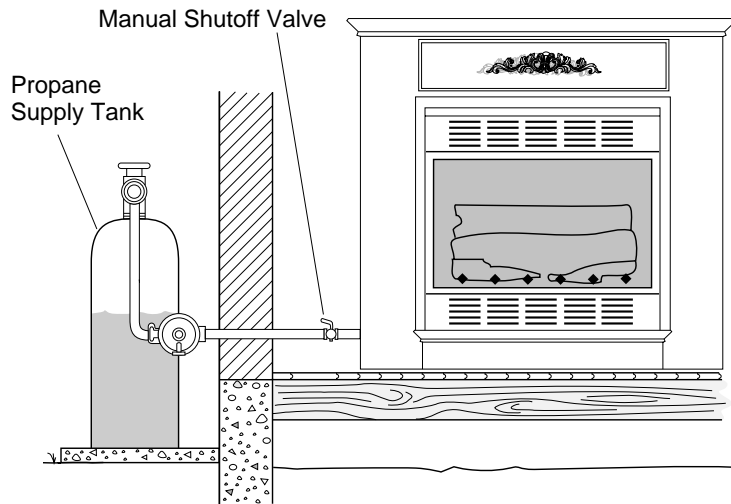

**Figure 21 - Checking Gas Joints Shown with Optional Mantel**

### Pressure Testing Fireplace Gas Connections

1. Open manual shutoff valve (see Figure 20).
2. Open propane supply tank valve.
3. Make sure control knob of fireplace is in the OFF position.
4. Check all joints from manual shutoff valve to thermostat gas valve (see Figure 21). Apply mixture of liquid soap and water to gas joints. Bubbles forming show a leak.
5. Correct all leaks at once.
6. Light fireplace (see *Operating Fireplace*, pages 15 through 17). Check all other internal joints for leaks.
7. Turn off fireplace (see *To Turn Off Gas to Appliance*, page 16).
8. Replace front panel.

*Continued*

# VENT-FREE PROPANE COMPACT FIREPLACE

## INSTALLATION

*Continued*

### OPTIONAL WIRELESS HAND-HELD REMOTE CONTROL ACCESSORIES (CGHRC Series and CGHRCT Series)

#### Installing Receiver

1. Remove screws.
2. Disconnect switch wires from the control valve.
3. Remove switch plate (see Figure 22). Discard switch plate after removing. Save the screws.
4. Locate the battery clip mounted on the back of the receiver (see Figure 23).
5. Slide 9-volt battery (not included) through the clip.
6. Attach the terminal wires to the battery (see Figure 23).
7. Connect wires as shown in Figure 24.
8. Install remote receiver unit onto gas heater base using the two screws removed in step one (see Figure 24).

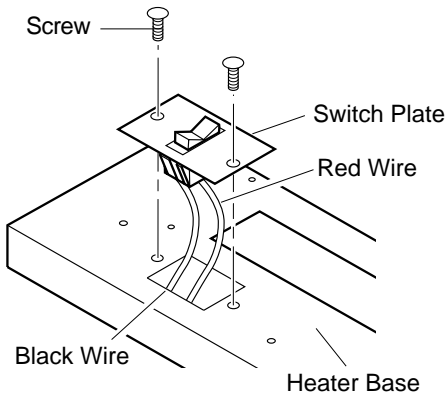

**Figure 22 - Switch Plate and Wiring Harness**

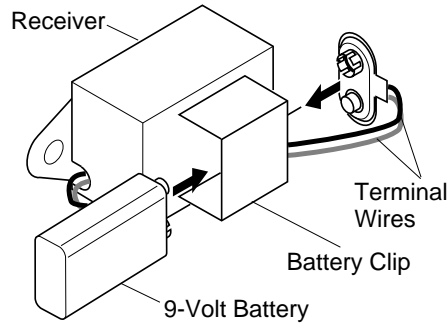

**Figure 23 - Attaching Battery to Receiver**

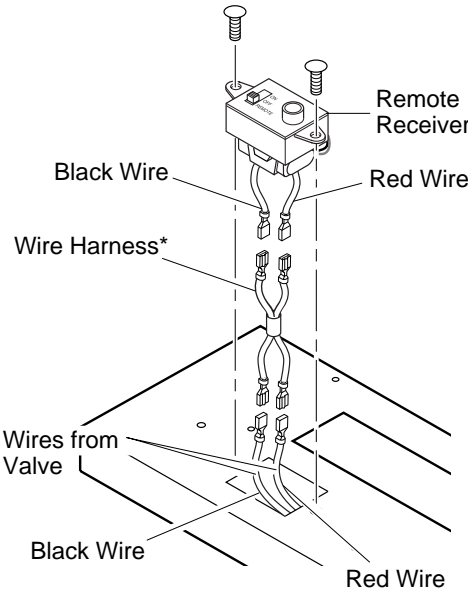
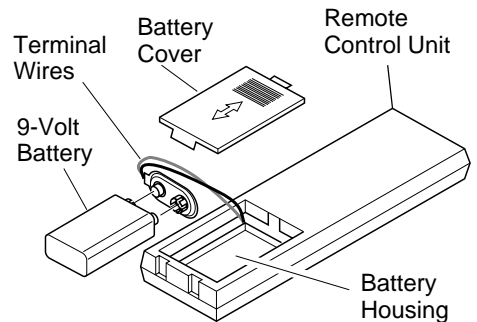

**Figure 24 - Installing Remote Receiver**

\* Wire harness provided in the fireplace hardware pack.

#### Installing 9-Volt Battery in Hand-Held Remote Control Unit

1. Remove battery cover on back of remote control unit.
2. Attach terminal wires to the battery (not included). Place battery into the battery housing.
3. Replace battery cover onto remote control unit.



**Figure 25 - Installing Battery in Hand-Held Remote Control Unit**

# OWNER'S MANUAL

## OPERATING FIREPLACE

FOR YOUR SAFETY READ BEFORE LIGHTING

**WARNING:** If you do not follow these instructions exactly, a fire or explosion may result causing property damage, personal injury or loss of life.

- A. This appliance has a pilot which must be lighted by hand. When lighting the pilot, follow these instructions exactly.
- B. **BEFORE LIGHTING** smell all around the appliance area for gas. Be sure to smell next to the floor because some gas is heavier than air and will settle on the floor.

### WHAT TO DO IF YOU SMELL GAS

- Do not try to light any appliance.
  - Do not touch any electric switch; do not use any phone in your building.
  - Immediately call your gas supplier from a neighbor's phone. Follow the gas supplier's instructions.
  - If you cannot reach your gas supplier, call the fire department.
- C. Use only your hand to push in or turn the gas control knob. Never use tools. If the knob will not push in or turn by hand, don't try to repair it, call a qualified service technician or gas supplier. Force or attempted repair may result in a fire or explosion.
- D. Do not use this appliance if any part has been under water. Immediately call a qualified service technician to inspect the appliance and to replace any part of the control system and any gas control which has been under water.

## LIGHTING INSTRUCTIONS

### WARNING:

- If fireplace has glass doors, never operate this heater with glass doors closed. If you operate heater with doors closed, heat buildup inside fireplace will cause glass to burst. Also if fireplace opening has vents at the bottom, you must open the vents before operating heater.
- You must operate this heater with a fireplace screen in place. Make sure fireplace screen is closed before running heater.

1. STOP! Read the safety information, column 1.
2. Make sure manual shutoff valve is fully open.
3. Set selector switch in the OFF position.

**WARNING:** Burner will come on automatically within one minute when the selector switch is in the ON position after the pilot is lit.

4. Press in and turn control knob clockwise to the OFF position.
5. Wait five (5) minutes to clear out any gas. Then smell for gas, including near the floor. If you smell gas, STOP! Follow "B" in the safety information, column 1. If you don't smell gas, go to the next step.
6. Press in and turn control knob counterclockwise to the PILOT position. Press in control knob for five (5) seconds (see Figure 26).

**Note:** You may be running this heater for the first time after hook-

ing up to gas supply. If so, the control knob may need to be pressed in for 30 seconds or more. This will allow air to bleed from the gas system.

7. With control knob pressed in, press and release ignitor button. This will light pilot. The pilot is attached to the burner. If needed, keep pressing ignitor button until pilot lights.

**Note:** If pilot does not stay lit, contact a qualified service person or gas supplier for repairs. Until repairs are made, light pilot with match. To light pilot with match, see *Manual Lighting Procedure* on page 16.

8. Keep control knob pressed in for 30 seconds after lighting pilot. After 30 seconds, release control knob.
  - If control knob does not pop out when released, contact a qualified service person or gas supplier for repairs.
- Note:** If pilot goes out, repeat steps 4 through 8.
9. Slightly push in and turn control knob counterclockwise to the ON position.
10. Wait one minute and switch selector switch to the ON position to light burner.
11. Set flame adjustment knob to any level between HI and LO.

**CAUTION:** Do not try to adjust heating levels by using the manual shutoff valve.

**WARNING:** Make sure the selector switch is in the OFF position when you are away from home for long periods of time. Heater will come on automatically with selector switch in the ON position.

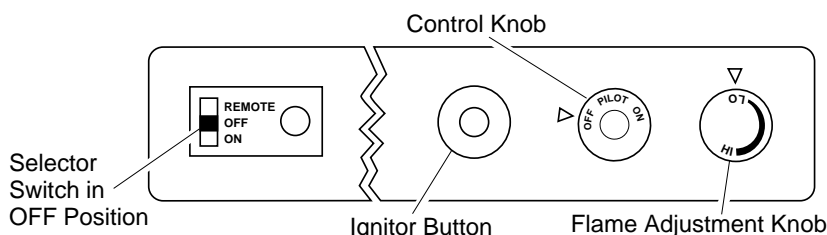

Figure 26 - Control Knob and Ignitor Button Location

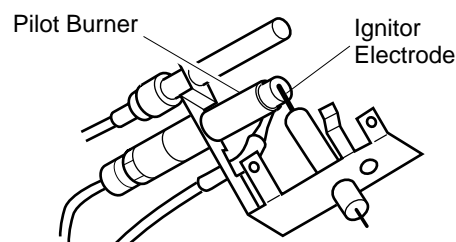

Figure 27 - Pilot

# VENT-FREE PROPANE COMPACT FIREPLACE

## OPERATING FIREPLACE

Continued

### TO TURN OFF GAS TO APPLIANCE

#### Shutting Off Fireplace

1. Turn control knob clockwise  to the OFF position.
- 2a. Set selector switch in the OFF position.
- 2b. If Using Optional Hand-Held Remote: Set selector switch in the OFF position to prevent draining battery.

#### Shutting Off Burner Only (pilot stays lit)

You may shut off the burner and keep the pilot lit by doing one of the following:

1. Turn control knob clockwise  to the PILOT position.
2. Use remote control manual OFF button.
3. Set selector switch in the OFF position.

### MANUAL LIGHTING PROCEDURE

1. Follow steps 1 through 6 under *Lighting Instructions*, page 15.
2. Depress control knob and light pilot with match.
3. Keep control knob pressed in for 30 seconds after lighting pilot. After 30 seconds, release control knob. Now follow steps 9 through 11, on page 15.

### OPTIONAL REMOTE OPERATION

**Note:** All remote control accessories must be purchased separately (see *Accessories*, page 24). Follow installation instructions on pages 14 of this manual.

#### Thermostat Control Operation

(Optional CGHRCT Series Only) The thermostat control setting on the remote control unit can be set to any comfort level between HI and LO. The burner will turn on and off automatically to maintain the comfort level you select. The ideal comfort setting will vary by household depending upon the amount of space to be heated, the output of the central heating system, etc.

**NOTICE:** You must light the pilot before using the hand-held remote control unit. See *Lighting Instructions* on page 15.

1. After lighting, let pilot flame burn for about one minute. Turn control knob to ON position. Adjust flame adjustment knob anywhere between HI and LO. Slide the selector switch to the REMOTE position. **NOTE:** The burner may light if hand-held remote ON button was on when selector switch was last turned off. You can now turn the burner on and off with the hand-held remote control unit.

**IMPORTANT:** Do not leave the selector switch in the REMOTE position when the pilot is not lit. This will drain the battery.

**IMPORTANT:** Be sure to press the ON/OFF buttons on the hand-held remote control unit for up to 3 seconds to assure proper operation.

#### CGHRC Series Operation:

- 2a. Press the ON/OFF button to turn the burner on and off. When turning burner off, the pilot will remain lit.

#### CGHRCT Series Operation:

- 2b. Select the MAN (manual) or AUTO button on the hand-held remote control unit (see Figure 29, page 17).
  - In manual mode, turn burner on or off by pressing the ON or OFF buttons on the hand-held remote control unit.

- In auto mode, the room temperature is controlled by the thermostat in the hand-held remote control unit. To increase the room temperature, press the top arrow of the TEMP button. To lower room the temperature, press the bottom arrow of the TEMP button. At higher settings the heater will run more.

**IMPORTANT:** This remote control has been specially engineered to take an air temperature sample every 5.5 minutes in the AUTO mode. It will not respond immediately to the temperature setting being turned up or down.

**IMPORTANT:** The hand-held remote control unit must be near the heater. Do not keep the hand-held remote control unit too close to the heater. The thermostat on the hand-held remote control unit will heat up too quickly and turn the heater off.

3. Use the STATUS button on the hand-held remote control unit to see the operation mode being used and the temperature setting selected. A red light will come on beside the operation mode being used when the status button is pressed (see Figure 29, page 17).
4. To turn the burner off when operating in the manual mode, press the OFF button. If operating in the auto mode, press the MAN button, then press the OFF button. The pilot will remain lit (see Figure 29, page 17). **IMPORTANT:** To turn the pilot off, manually turn the control knob on the heater to the OFF position.

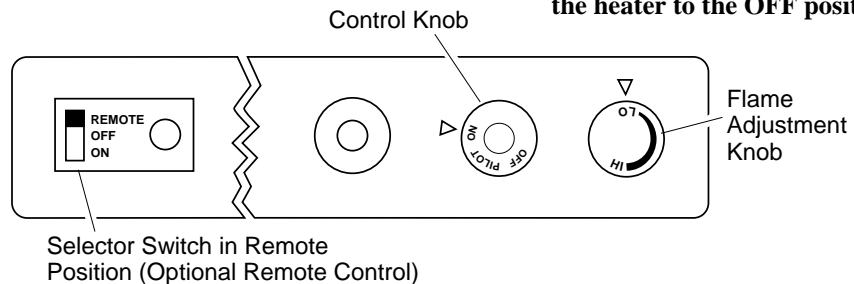

**Figure 28 - Setting the Selector Switch, Control Knob, and Flame Adjustment Knob for Remote Operation**



## OPERATING FIREPLACE

*Continued*

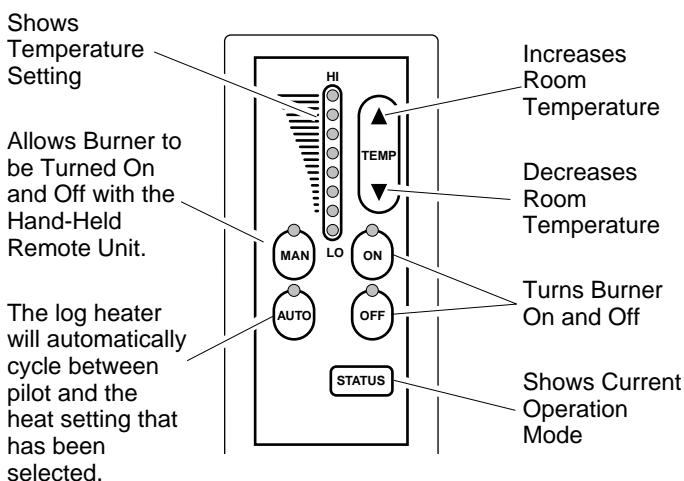

Figure 29 - Thermostat Hand-Held Remote Control Unit Selections (CGHRCT only)

## INSPECTING BURNERS

Check pilot flame pattern and burner flame patterns often.

### PILOT FLAME PATTERN

Figure 30 shows a correct pilot flame pattern. Figure 31 shows an incorrect pilot flame pattern. The incorrect pilot flame is not properly heating the thermocouple. When the thermocouple cools, the heater will shut down.

If pilot flame pattern is incorrect, as shown in Figure 31

- turn heater off (see *To Turn Off Gas to Appliance*, page 16)
- see *Troubleshooting*, pages 19 through 21

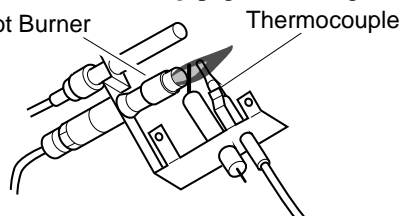

Figure 30 - Correct Pilot Flame Pattern

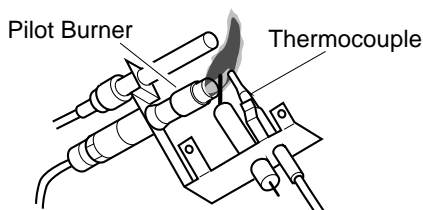

Figure 31 - Incorrect Pilot Flame Pattern

### BURNER FLAME PATTERN

Figure 32 shows a correct burner flame pattern. Figure 33 shows an incorrect burner flame pattern. The incorrect burner flame pattern shows yellow tipping of the flame. It also shows the flame higher than one inch above the log.

*Note:* When using the fireplace the first time, the flame will be yellow for approximately one hour until the log cures.

**WARNING:** If yellow tipping occurs, your fireplace could produce increased levels of carbon monoxide. If burner flame pattern shows yellow tipping, follow instructions in column 3 of this page.

**NOTICE:** Do not mistake orange flames with yellow tipping. Dirt or other fine particles enter the fireplace and burn causing brief patches of orange flame.

If burner flame pattern is incorrect, as shown in Figure 33

- turn fireplace off (see *To Turn Off Gas to Appliance*, page 16)
- see *Troubleshooting*, pages 19 through 21

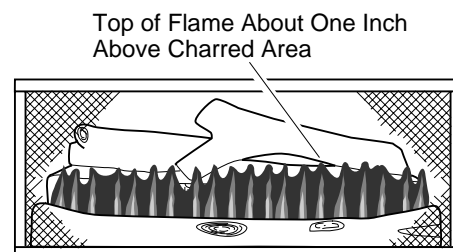

Figure 32 - Correct Burner Flame Pattern

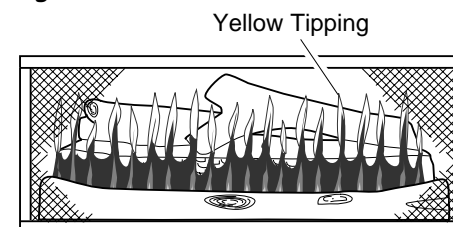

Figure 33 - Incorrect Burner Flame Pattern

## CLEANING AND MAINTENANCE

**WARNING:** Turn off fireplace and let cool before cleaning.

**CAUTION:** You must keep control areas, burner, and circulating air passageways of fireplace clean. Inspect these areas of fireplace before each use. Have fireplace inspected yearly by a qualified service person. Fireplace may need more frequent cleaning due to excessive lint from carpeting, pet hair, etc.

### ODS/PILOT AND BURNER

- Use a vacuum cleaner or small, soft bristled brush to clean.

### CABINET

#### Air Passageways

- Use a vacuum cleaner or pressurized air to clean.

#### Exterior

- Use a soft cloth dampened with a mild soap and water mixture. Wipe the cabinet to remove dust.

# VENT-FREE PROPANE COMPACT FIREPLACE

## REPLACEMENT PARTS

*Note:* Use only original replacement parts. This will protect your warranty coverage for parts replaced under warranty.

### PARTS UNDER WARRANTY

Contact authorized dealers of this product. If they can't supply original replacement part(s) call DESA International's Technical Service Department at 1-800-323-5190 for referral information.

When calling DESA International, have ready

- your name
- your address
- model number of your fireplace
- how fireplace was malfunctioning
- type of gas used (propane/LP or natural gas)
- purchase date

Usually, we will ask you to return the defective part to the factory.

### PARTS NOT UNDER WARRANTY

Contact authorized dealers of this product or Parts Central (see page 25). If they can't supply original replacement part(s) call DESA International's Parts Department at 1-800-972-7879 for referral information.

When calling DESA International, have ready

- model number of your fireplace
- the replacement part number

## SPECIFICATIONS

Btu (Variable)	15,000/26,000
Type Gas	Propane/LP Only
Ignition	Piezo
Manifold Pressure	8" W.C.
Inlet Gas Pressure (in. of water) *	
Maximum	14"
Minimum	11"
Dimensions, Inches (H x W x D)	
Fireplace	25 7/8 x 26 <sup>13</sup> / <sub>16</sub> x 9 <sup>3</sup> / <sub>8</sub>
Carton	32 <sup>5</sup> / <sub>8</sub> x 27 <sup>3</sup> / <sub>16</sub> x 11 <sup>5</sup> / <sub>8</sub>
Weight, pounds	
Fireplace	44 <sup>1</sup> / <sub>2</sub> lbs.
Shipping	48 lbs.

\* For purposes of input adjustment

## TECHNICAL SERVICE

You may have further questions about installation, operation, or troubleshooting.

If so, contact DESA International's Technical Service Department at 1-800-DESA LOG (1-800-337-2564).

You can also visit DESA International's technical services web site at [www.desatech.com](http://www.desatech.com).

## SERVICE HINTS

### When Gas Pressure Is Too Low

- pilot will not stay lit
- burner will have delayed ignition
- heater will not produce specified heat
- propane gas supply may be low

### When Gas Quality Is Bad

- pilot will not stay lit
- burner will produce flames and soot
- heater will backfire when lit

You may feel your gas pressure is too low or gas quality is bad. If so, contact your local natural gas supplier.

## WIRING DIAGRAM

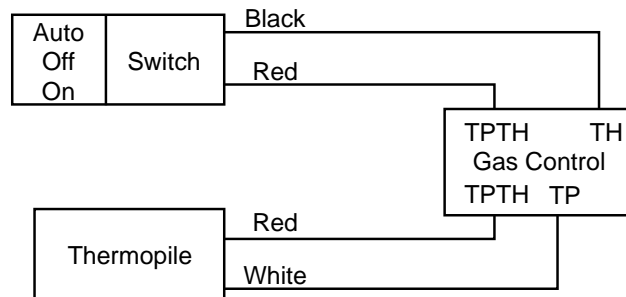

# OWNER'S MANUAL

## TROUBLESHOOTING

*Note:* For additional help, visit DESA International's technical service web site at [www.desatech.com](http://www.desatech.com).

**⚠ WARNING:** Turn off heater and let cool before servicing. Only a qualified service person should service and repair heater.

**⚠ CAUTION:** Never use a wire, needle, or similar object to clean ODS/pilot. This can damage ODS/pilot unit.

*Note:* All troubleshooting items are listed in order of operation.

OBSERVED PROBLEM	POSSIBLE CAUSE	REMEDY
When ignitor button is pressed, there is no spark at ODS/pilot	<ol style="list-style-type: none"><li>1. Ignitor electrode not connected to ignitor cable</li><li>2. Ignitor cable pinched or wet</li><li>3. Piezo ignitor nut is loose</li><li>4. Broken ignitor cable</li><li>5. Bad piezo ignitor</li><li>6. Ignitor electrode broken</li><li>7. Ignitor electrode positioned wrong</li></ol>	<ol style="list-style-type: none"><li>1. Reconnect ignitor cable</li><li>2. Free ignitor cable if pinched by any metal or tubing. Keep ignitor cable dry</li><li>3. Tighten nut holding piezo ignitor to base panel of log set. Nut is located behind base panel.</li><li>4. Replace ignitor cable</li><li>5. Replace piezo ignitor</li><li>6. Replace piezo ignitor</li><li>7. Replace piezo ignitor</li></ol>
When ignitor button is pressed, there is spark at ODS/pilot but no ignition	<ol style="list-style-type: none"><li>1. Gas supply turned off or manual shutoff valve closed</li><li>2. Control knob not in PILOT position</li><li>3. Control knob not pressed in while in PILOT position</li><li>4. Air in gas lines when installed</li><li>5. Depleted gas supply</li><li>6. ODS/pilot is clogged</li><li>7. Gas regulator setting is not correct</li></ol>	<ol style="list-style-type: none"><li>1. Turn on gas supply or open manual shutoff valve</li><li>2. Turn control knob to PILOT position</li><li>3. Press in control knob while in PILOT position</li><li>4. Continue holding down control knob. Repeat igniting operation until air is removed</li><li>5. Contact local propane gas company</li><li>6. Clean ODS/pilot (see <i>Cleaning and Maintenance</i>, page 17) or replace ODS/pilot assembly</li><li>7. Replace gas control</li></ol>
ODS/pilot lights but flame goes out when control knob is released	<ol style="list-style-type: none"><li>1. Control knob not fully pressed in</li><li>2. Control knob not pressed in long enough</li><li>3. Manual shutoff valve not fully open</li><li>4. Pilot flame not touching thermocouple, which allows thermocouple to cool, causing pilot flame to go out. This problem could be caused by one or both of the following:<ol style="list-style-type: none"><li>A) Low gas pressure</li><li>B) Dirty or partially clogged ODS/pilot</li></ol></li><li>5. Thermocouple connection loose at control valve</li><li>6. Thermocouple damaged</li><li>7. Control valve damaged</li></ol>	<ol style="list-style-type: none"><li>1. Press in control knob fully</li><li>2. After ODS/pilot lights, keep control knob pressed in 30 seconds</li><li>3. Fully open manual shut-off valve</li><li>4. <ol style="list-style-type: none"><li>A) Contact local propane gas company</li><li>B) Clean ODS/pilot (see <i>Cleaning and Maintenance</i>, page 17) or replace ODS/pilot assembly</li></ol></li><li>5. Hand tighten until snug, then tighten 1/4 turn more</li><li>6. Replace thermocouple</li><li>7. Replace control valve</li></ol>

# VENT-FREE PROPANE COMPACT FIREPLACE

## TROUBLESHOOTING

*Continued*

OBSERVED PROBLEM	POSSIBLE CAUSE	REMEDY
Burner does not light after ODS/pilot is lit	<ol style="list-style-type: none"> <li>1. Burner orifice clogged</li> <li>2. Inlet gas pressure is too low</li> <li>3. Burner orifice diameter is too small</li> <li>4. Thermopile leads disconnected or improperly connected</li> <li>5. Burner will not come on in remote position</li> </ol>	<ol style="list-style-type: none"> <li>1. Clean burner (see <i>Cleaning and Maintenance</i>, page 17) or replace burner orifice</li> <li>2. Contact local propane gas company</li> <li>3. Replace burner orifice</li> <li>4. Reconnect leads (see <i>Wiring Diagram</i>, page 18)</li> <li>5. Replace battery in transmitter and receiver</li> </ol>
Delayed ignition burner	<ol style="list-style-type: none"> <li>1. Manifold pressure is too low</li> <li>2. Burner orifice clogged</li> </ol>	<ol style="list-style-type: none"> <li>1. Contact local propane gas company</li> <li>2. Clean burner (see <i>Cleaning and Maintenance</i>, page 17) or replace burner orifice</li> </ol>
Burner backfiring during combustion	<ol style="list-style-type: none"> <li>1. Burner orifice is clogged or damaged</li> <li>2. Damaged burner</li> <li>3. Gas regulator defective</li> </ol>	<ol style="list-style-type: none"> <li>1. Clean burner (see <i>Cleaning and Maintenance</i>, page 17) or replace burner orifice</li> <li>2. Replace damaged burner</li> <li>3. Replace gas control</li> </ol>
Slight smoke or odor during initial operation	<ol style="list-style-type: none"> <li>1. Not enough air</li> <li>2. Gas regulator defective</li> <li>3. Residues from manufacturing processes and logs curing</li> </ol>	<ol style="list-style-type: none"> <li>1. Check burner for dirt and debris. If found, clean burner (see <i>Cleaning and Maintenance</i>, page 17)</li> <li>2. Replace gas control</li> <li>3. Problem will stop after a few hours of operation</li> </ol>
Moisture/condensation noticed on windows	<ol style="list-style-type: none"> <li>1. Not enough combustion/ventilation air</li> </ol>	<ol style="list-style-type: none"> <li>1. Refer to <i>Air for Combustion and Ventilation</i> requirements (page 5)</li> </ol>
Heater produces a whistling noise when burner is lit	<ol style="list-style-type: none"> <li>1. Turning control knob to HI position when burner is cold</li> <li>2. Air in gas line</li> <li>3. Air passageways on heater blocked</li> <li>4. Dirty or partially clogged burner orifice</li> </ol>	<ol style="list-style-type: none"> <li>1. Turn control knob to LO position and let warm up for a minute</li> <li>2. Operate burner until air is removed from line. Have gas line checked by local propane gas company</li> <li>3. Observe minimum installation clearances (see pages 8 through 10)</li> <li>4. Clean burner (see <i>Cleaning and Maintenance</i>, page 17) or replace burner orifice</li> </ol>
White powder residue forming within burner box or on adjacent walls or furniture	<ol style="list-style-type: none"> <li>1. When heated, vapors from furniture polish, wax, carpet cleaners, etc. turn into white powder residue</li> </ol>	<ol style="list-style-type: none"> <li>1. Turn heater off when using furniture polish, wax, carpet cleaners, or similar products</li> </ol>
Remote does not function	<ol style="list-style-type: none"> <li>1. Battery is not installed. Battery power is low</li> </ol>	<ol style="list-style-type: none"> <li>1. Replace 9-volt batteries in receiver and remote control</li> </ol>

# OWNER'S MANUAL

## TROUBLESHOOTING

*Continued*

- ⚠ WARNING: If you smell gas**
- Shut off gas supply.
  - Do not try to light any appliance.
  - Do not touch any electrical switch; do not use any phone in your building.
  - Immediately call your gas supplier from a neighbor's phone. Follow the gas supplier's instructions.
  - If you cannot reach your gas supplier, call the fire department.

*IMPORTANT:* Operating heater where impurities in air exist may create odors. Cleaning supplies, paint, paint remover, cigarette smoke, cements and glues, new carpet or textiles, etc., create fumes. These fumes may mix with combustion air and create odors. These odors will disappear over time.

OBSERVED PROBLEM	POSSIBLE CAUSE	REMEDY
Heater produces a clicking/ticking noise just after burner is lit or shut off	1. Metal expanding while heating or contracting while cooling	1. This is common with most heaters. If noise is excessive, contact qualified service person
Heater produces unwanted odors	1. Heater burning vapors from paint, hair spray, glues, cleaners, chemicals, new carpet, etc. (See <i>IMPORTANT</i> statement above) 2. Gas leak. <b>See Warning statement at top of page</b>	1. Open window and ventilate room. Stop using odor causing products while heater is running 2. Locate and correct all leaks (see <i>Checking Gas Connections</i> , page 13)
Heater shuts off in use (ODS operates)	1. Not enough fresh air is available 2. Low line pressure 3. ODS/pilot is partially clogged	1. Open window and/or door for ventilation 2. Contact local natural gas company 3. Clean ODS/pilot (see <i>Cleaning and Maintenance</i> , page 17)
Gas odor even when control knob is in OFF position	1. Gas leak. <b>See Warning statement at top of page</b> 2. Control valve defective	1. Locate and correct all leaks (see <i>Checking Gas Connections</i> , page 13) 2. Replace control valve
Gas odor during combustion	1. Foreign matter between control valve and burner 2. Gas leak. <b>See Warning statement at top of page</b>	1. Take apart gas tubing and remove foreign matter 2. Locate and correct all leaks (see <i>Checking Gas Connections</i> , page 13)

*Comfort Glow*<sup>®</sup>

# VENT-FREE PROPANE COMPACT FIREPLACE

## ILLUSTRATED PARTS BREAKDOWN

CGCF26PRA

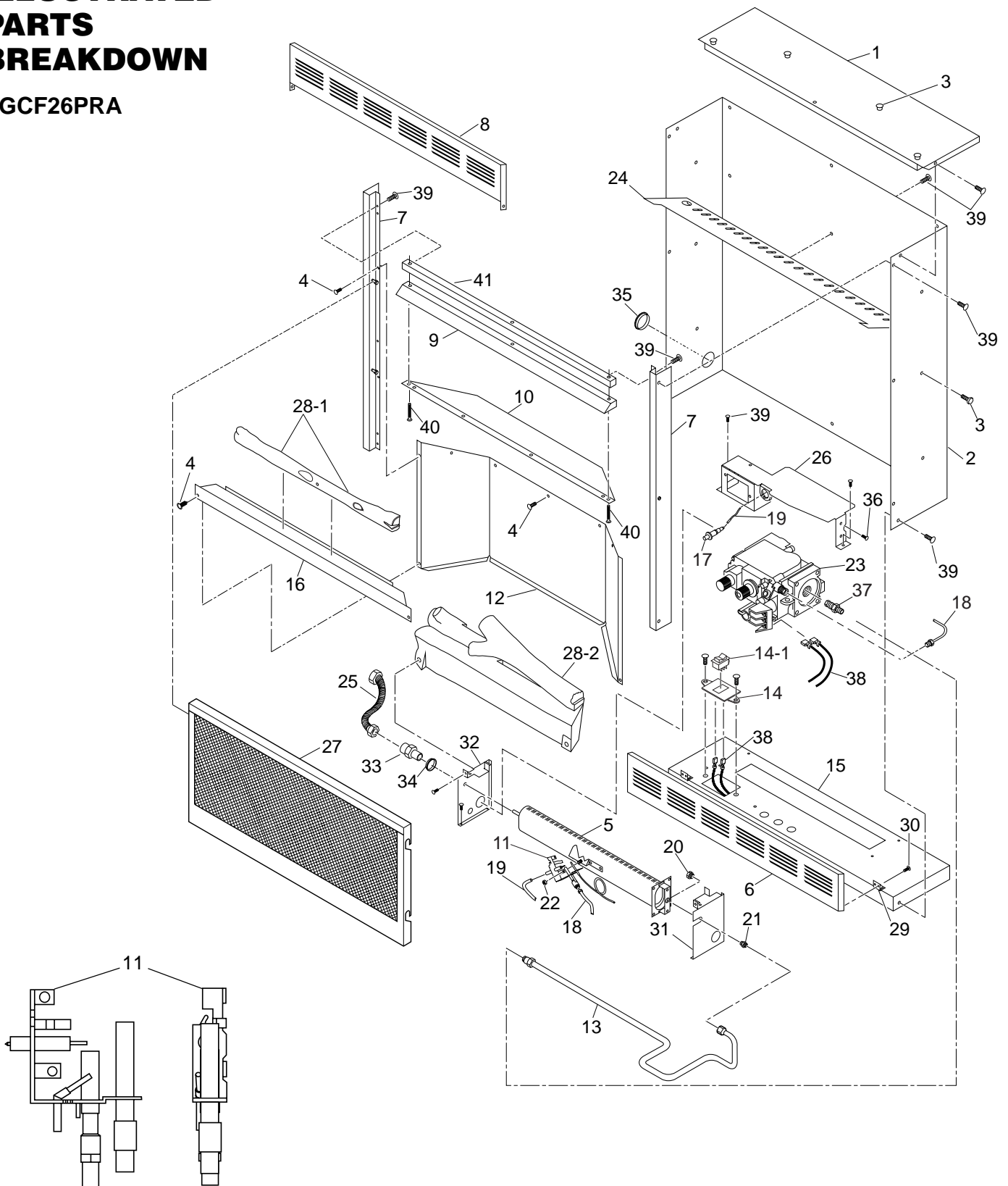

# OWNER'S MANUAL

## PARTS LIST

### CGCF26PRA

This list contains replaceable parts used in your fireplace. When ordering parts, follow the instructions listed under *Replacement Parts* on page 18 of this manual.

KEY NO.	PART NO.	DESCRIPTION	QTY.
1	102633-02CK	Outer Casing Top	1
2	102624-02	Outer Casing	1
3	099230-02	Shoulder Screw	6
4	098304-01	Screw, #10 x 3/8"	41
5	103447-02	Burner	1
6	104230-02	Louvered Door, Service Assembly	1
7	102635-02CK	Left and Right Side Front	2
8	103692-01CK	Top Louver	1
9	101712-04	Firebox Hood	1
10	102638-01	Firebox Top	1
11	103778-01	ODS/Pilot Assembly	1
12	102460-01CJ	Firebox Wrapper	1
13	104322-01	Burner Tube	1
14	103587-02	Plate Switch	1
14-1	099998-01	Switch, Heater	1
15	104335-01CK	Outer Shell Base	1
16	102649-02CJ	Branch Support	1
17	097159-04	Piezo	1
18	099387-13	Pilot Tube	1
19	098271-07	Ignitor Cable	1
20	098251-03	Injector	1
21	098250-01	Injector Holder	1
22	098249-01	Nut, M5	6
23	103781-02	Gas Valve	1
24	102639-01	Baffle	1
25	101628-01	Flexible Connector	1
26	104305-01	Control Shield	1
27	103295-02CJ	Screen Assembly	1
28-1	104058-01	Branch	1
28-2	104077-01	Main Log	1
29	101386-02	Hinge	2
30	099194-11	Rivets	8
31	102645-02	Burner Support, Right	1
32	102645-03	Burner Support, Left	1
33	097809-02	Connector, Male	1
34	101629-01	Bushing	1
35	101629-02	Bushing	1
36	M12461-26	Gas Valve Screws	2
37	098264-02	Connector, Male	1
38	103284-03	Wire Harness	1
39	M11084-26	Hex Head Screws #10 x .38	30
40	097403-02	Pan Head Screw, 1 3/4"	2
41	102458-01CK	Middle Rail	1
<b>PARTS AVAILABLE — NOT SHOWN</b>			
	103877-01	Lighting Instructions Plate	1
	100563-01	Warning Plate	1
	103470-01	Hardware Package	1
	104319-03	Information Video	1

## VENT-FREE PROPANE COMPACT FIREPLACE

### ACCESSORIES

Purchase these fireplace accessories from your local dealer or Parts Central (see page 27). If they cannot supply these accessories call DESA International's Sales Department at 1-800-458-2472 for referral information. You can also write to the address listed on the back page of this manual.

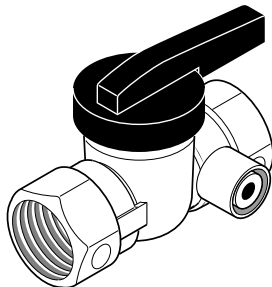

#### MANUAL SHUTOFF VALVE - GA5010

Manual shutoff valve with 1/8" NPT tap.

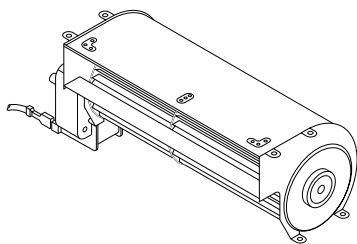

#### THERMOSTATICALLY CONTROLLED BLOWER KIT - GA3450T

Provides better heat distribution. Blower turns off and on automatically, as needed. Complete installation and operating instructions included.

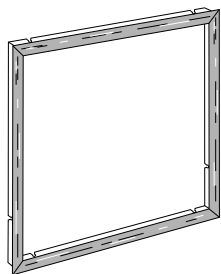

#### BRASS TRIM KIT - GA6095

Optional four-sided brass trim kit for built-in installations. Provides a finished appearance covering rough edges of wall opening.

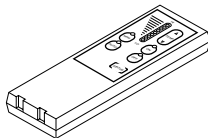

#### RECEIVER AND HAND-HELD THERMOSTAT REMOTE CONTROL KIT - CGHRCT SERIES

For all models. Allows the gas log heater to be operated in a manually or thermostatically controlled mode. You can turn the gas log heater on and off without ever leaving the comfort of your easy chair.

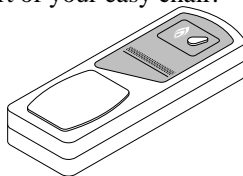

#### RECEIVER AND HAND-HELD REMOTE CONTROL KIT - CGHRC SERIES

For all models. Allows the gas log heater to be turned on and off by using a hand-held remote control.

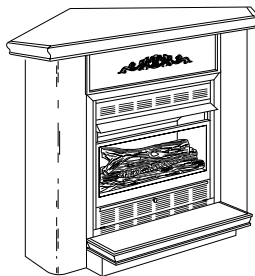

#### CORNER MANTEL WITH BUILT-IN HEARTH BASE Unfinished Hardwood Veneer - GMC20U Finished Hardwood Veneer - GMC19F

For use with fireplace. Space-saving mantel and hearth base corner design features clean, classic lines. Available in a walnut finish or an unfinished hardwood, ready to stain or paint. Complete assembly instructions included. Three-sided brass trim kit included.

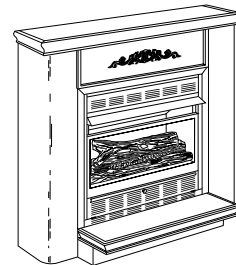

#### CABINET MANTEL WITH BUILT-IN HEARTH BASE Unfinished Hardwood Veneer - GMC16U Walnut Finished Hardwood Veneer - GMC15F Medium Stained Oak Veneer - GMC17F

For use with fireplace. A hardwood mantel and hearth base offers compact styling and completes the fireplace look. Available in a walnut stain, medium oak stain, or an unfinished hardwood, ready to stain or paint. Complete assembly instructions included. Three-sided brass trim kit included.

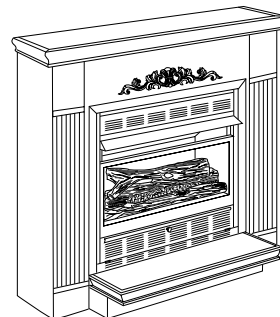

#### CORNER MANTEL WITH BUILT-IN HEARTH BASE AND TRADITIONAL SQUARE LEG STYLING Finished Oak Veneer - GMC43F Unfinished Oak Veneer - GMC44U Finished Walnut Hardwood Veneer - GMC38F Unfinished Hardwood Veneer - GMC39U

For use with fireplace. A hardwood mantel and hearth base offers compact styling and completes the fireplace look. Available in a stained or an unfinished (ready to stain or paint) Oak Veneer over hardwood. Complete assembly instructions included. Three-sided brass trim kit included.



# OWNER'S MANUAL

## PARTS CENTRALS

These Parts Centrals are privately owned businesses. They have agreed to support our customer's needs by providing original replacement parts and accessories.

### **Baltimore Electric**

1348 Dixwell Avenue  
Hamden, CT 06514-0322  
1-800-397-7553  
203-248-7553  
Parts Department

### **Portable Heater Parts**

342 N. County Rd. 400 East  
Valparaiso, IN 46383-9704  
All States  
219-462-7441  
1-800-362-6951  
Parts Department

### **FBD**

1349 Adams St.  
Bowling Green, KY 42103-3413  
502-846-1199  
1-800-654-8534  
Fax: 1-800-846-0090

### **Four Flags Power Products**

1115 Stateline Road  
Niles, MI 49120-4728  
616-684-2697  
1-800-268-4983  
Parts Only

### **Master Parts Distributors**

1251 Mound Ave. NW  
Grand Rapids, MI 49504-2672  
616-791-0505  
Fax: 1-616-791-8270  
Parts Department  
1-800-446-1446

### **Washer Equipment Co.**

1715 Main Street  
Kansas City, MO 64108-2195  
KS, MO, AR  
816-842-3911  
Parts Department

### **East Coast Energy Products**

707 Broadway  
W. Long Branch, NJ 07764-1542  
908-870-8809  
1-800-755-8809  
Parts Department

### **Tarantin Tank Co.**

P.O. Box 6129  
Freehold, NJ 07728-6129  
908-780-9340  
1-800-922-0724  
Parts Department

### **Heater & Fireplace Store**

1922 N Route 9  
Cape May Court, NJ 08210-1110  
609-624-0678  
Parts Department

### **Dayton Hardware**

P.O. Box 275  
North Dayton Station  
Dayton, OH 45404-0275  
All States  
513-258-3721  
Parts Department  
1-800-762-3426

### **Halco Enterprises**

208 Carter Drive, Unit 21  
West Chester, PA 19382-4500  
610-430-7717  
1-800-368-0803  
Parts Department

### **LaPorte's Parts & Service**

2444 North 5th Street  
Hartsville, SC 29550-7704  
803-332-0191  
Parts Department

### **Cans Unlimited, Inc.**

P.O. Box 645  
Taylor, SC 29687-0013  
All States  
803-879-3009  
1-800-845-5301  
Parts Department

# WARRANTY INFORMATION

## KEEP THIS WARRANTY

Model _____
Serial No. _____
Date Purchased _____

Always specify model and serial numbers when communicating with the factory.

We reserve the right to amend these specifications at any time without notice. The only warranty applicable is our standard written warranty. We make no other warranty, expressed or implied.

### LIMITED WARRANTY VENT-FREE PROPANE/LP GAS HEARTH FIREPLACE

DESA International warrants this product to be free from defects in materials and components for two (2) years from the date of first purchase, provided that the product has been properly installed, operated and maintained in accordance with all applicable instructions. To make a claim under this warranty the Bill of Sale or cancelled check must be presented.

This warranty is extended only to the original retail purchaser. This warranty covers the cost of part(s) required to restore this fireplace to proper operating condition and an allowance for labor when provided by a DESA Authorized Service Center. Warranty part(s) MUST be obtained through authorized dealers of this product and/or DESA International who will provide original factory replacement parts. Failure to use original factory replacement parts voids this warranty. The fireplace MUST be installed by a qualified installer in accordance with all local codes and instructions furnished with the unit.

This warranty does not apply to parts that are not in original condition because of normal wear and tear, or parts that fail or become damaged as a result of misuse, accidents, lack of proper maintenance or defects caused by improper installation. Travel, diagnostic cost, labor, transportation and any and all such other costs related to repairing a defective fireplace will be the responsibility of the owner.

TO THE FULL EXTENT ALLOWED BY THE LAW OF THE JURISDICTION THAT GOVERNS THE SALE OF THE PRODUCT; THIS EXPRESS WARRANTY EXCLUDES ANY AND ALL OTHER EXPRESSED WARRANTIES AND LIMITS THE DURATION OF ANY AND ALL IMPLIED WARRANTIES, INCLUDING WARRANTIES OF MERCHANTABILITY AND FITNESS FOR A PARTICULAR PURPOSE TO TWO (2) YEARS ON ALL COMPONENTS FROM THE DATE OF FIRST PURCHASE; AND DESA INTERNATIONAL'S LIABILITY IS HEREBY LIMITED TO THE PURCHASE PRICE OF THE PRODUCT AND DESA INTERNATIONAL SHALL NOT BE LIABLE FOR ANY OTHER DAMAGES WHATSOEVER INCLUDING INDIRECT, INCIDENTAL OR CONSEQUENTIAL DAMAGES.

Some states do not allow a limitation on how long an implied warranty lasts or an exclusion or limitation of incidental or consequential damages, so the above limitation on implied warranties, or exclusion or limitation on damages may not apply to you.

This warranty gives you specific legal rights, and you may also have other rights that vary from state to state.

For information about this warranty write:

**DESA**  
INTERNATIONAL  
2701 Industrial Drive  
P.O. Box 90004  
Bowling Green, KY 42102-9004  
www.desatech.com



105616 01

NOT A UPC

105616-01  
REV. A  
02/99

## Free Manuals Download Website

<http://myh66.com>

<http://usermanuals.us>

<http://www.somanuals.com>

<http://www.4manuals.cc>

<http://www.manual-lib.com>

<http://www.404manual.com>

<http://www.luxmanual.com>

<http://aubethermostatmanual.com>

Golf course search by state

<http://golfingnear.com>

Email search by domain

<http://emailbydomain.com>

Auto manuals search

<http://auto.somanuals.com>

TV manuals search

<http://tv.somanuals.com>