

DENON

CD/HDD MUSIC SYSTEM

CHR-F103

OPERATING INSTRUCTIONS

BEDIENUNGSANLEITUNG

MODE D'EMPLOI

ISTRUZIONI PER L'USO

INSTRUCCIONES DE FUNCIONAMIENTO

GEBRUIKSAANWIJZING

BRUKSANVISNING



☐ SAFETY PRECAUTIONS



CAUTION

RISK OF ELECTRIC SHOCK

DO NOT OPEN



CAUTION:
TO REDUCE THE RISK OF ELECTRIC SHOCK, DO NOT REMOVE COVER (OR BACK). NO USER-SERVICEABLE PARTS INSIDE. REFER SERVICING TO QUALIFIED SERVICE PERSONNEL.

 The lightning flash with arrowhead symbol, within an equilateral triangle, is intended to alert the user to the presence of uninsulated "dangerous voltage" within the product's enclosure that may be of sufficient magnitude to constitute a risk of electric shock to persons.

 The exclamation point within an equilateral triangle is intended to alert the user to the presence of important operating and maintenance (servicing) instructions in the literature accompanying the appliance.

WARNING:
TO REDUCE THE RISK OF FIRE OR ELECTRIC SHOCK, DO NOT EXPOSE THIS APPLIANCE TO RAIN OR MOISTURE.

CLASS 1 LASER PRODUCT
 LUOKAN 1 LASERLAITE
 KLAS 1 LASERAPPARAT

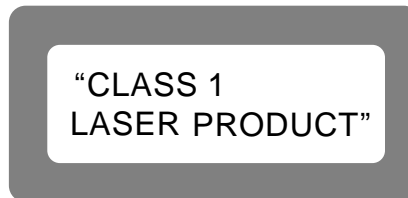

ADVARSEL: USYNLIG LASERSTRÅLING VED ÅBNING, NÅR SIKKERHEDSAFBRYDERE ER UDE AF FUNKTION. UNDGÅ UDSAETTELSE FOR STRÅLING.

VAROITUS! LAITTEEN KÄYTTÄMINEN MUULLA KUIN TÄSSÄ KÄYTTÖOHJEESSA MAINITULLA TAVALLA SAATTAÄ ALTISTAA KÄYTTÄJÄN TURVALLISUUSLUOKAN 1 YLITTÄVÄLLE NÄKYMÄMTTÖMÄLLE LASERSÄTEILYLLE.

WARNING: OM APPARATEN ANVÄNDS PÅ ANNAT SÄTT ÄN I DENNA BRUKSANVISNING SPECIFICERATS, KAN ANVÄNDAREN UTSÄTTAS FÖR OSYNLIG LASERSTRÅLNING SOM ÖVERSKRIDER GRÄNSEN FÖR LASERKLASS 1.

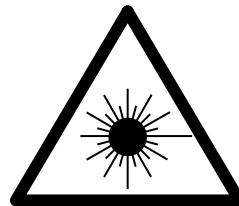





ATTENZIONE: QUESTO APPARECCHIO E' DOTATO DI DISPOSITIVO OTTICO CON RAGGIO LASER. L'USO IMPROPRIO DELL'APPARECCHIO PUO' CAUSARE PERICOLOSE ESPOSIZIONI A RADIAZIONI!

CAUTION:
USE OF CONTROLS OR ADJUSTMENTS OR PERFORMANCE OF PROCEDURES OTHER THAN THOSE SPECIFIED HEREIN MAY RESULT IN HAZARDOUS RADIATION EXPOSURE.
THIS PRODUCT SHOULD NOT BE ADJUSTED OR REPAIRED BY ANYONE EXCEPT PROPERLY QUALIFIED SERVICE PERSONNEL.

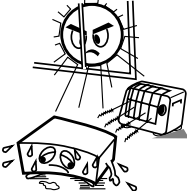
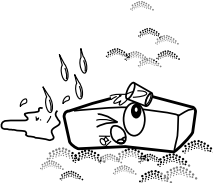
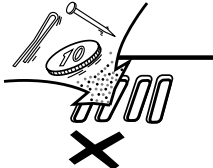
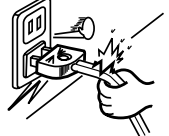
- **DECLARATION OF CONFORMITY**
 We declare under our sole responsibility that this product, to which this declaration relates, is in conformity with the following standards: EN60065, EN55013, EN55020, EN61000-3-2 and EN61000-3-3. Following the provisions of 73/23/EEC, 89/336/EEC and 93/68/EEC Directive.
- **ÜBEREINSTIMMUNGSERKLÄRUNG**
 Wir erklären unter unserer Verantwortung, daß dieses Produkt, auf das sich diese Erklärung bezieht, den folgenden Standards entspricht: EN60065, EN55013, EN55020, EN61000-3-2 und EN61000-3-3. Entspricht den Verordnungen der Direktive 73/23/EEC, 89/336/EEC und 93/68/EEC.
- **DECLARATION DE CONFORMITE**
 Nous déclarons sous notre seule responsabilité que l'appareil, auquel se réfère cette déclaration, est conforme aux standards suivants: EN60065, EN55013, EN55020, EN61000-3-2 et EN61000-3-3. D'après les dispositions de la Directive 73/23/EEC, 89/336/EEC et 93/68/EEC.
- **DICHIARAZIONE DI CONFORMITÀ**
 Dichiariamo con piena responsabilità che questo prodotto, al quale la nostra dichiarazione si riferisce, è conforme alle seguenti normative: EN60065, EN55013, EN55020, EN61000-3-2 e EN61000-3-3. In conformità con le condizioni delle direttive 73/23/EEC, 89/336/EEC e 93/68/EEC. QUESTO PRODOTTO E' CONFORME AL D.M. 28/08/95 N. 548
- **DECLARACIÓN DE CONFORMIDAD**
 Declaramos bajo nuestra exclusiva responsabilidad que este producto al que hace referencia esta declaración, está conforme con los siguientes estándares: EN60065, EN55013, EN55020, EN61000-3-2 y EN61000-3-3. Siguiendo las provisiones de las Directivas 73/23/EEC, 89/336/EEC y 93/68/EEC.
- **EENVORMIGHEIDSVERKLARING**
 Wij verklaren uitsluitend op onze verantwoordelijkheid dat dit produkt, waarop deze verklaring betrekking heeft, in overeenstemming is met de volgende normen: EN60065, EN55013, EN55020, EN61000-3-2 en EN61000-3-3. Volgens de bepalingen van de Richtlijnen 73/23/EEC, 89/336/EEC en 93/68/EEC.
- **ÖVERENSSTÄMMELSESINTYG**
 Härmed intygas helt på eget ansvar att denna produkt, vilken detta intyg avser, uppfyller följande standarder: EN60065, EN55013, EN55020, EN61000-3-2 och EN61000-3-3. Enligt stadgarna i direktiv 73/23/EEC, 89/336/EEC och 93/68/EEC.

NOTE ON USE / HINWEISE ZUM GEBRAUCH / OBSERVATIONS RELATIVES A L'UTILISATION / NOTE SULL'USO / NOTAS SOBRE EL USO / ALVORENS TE GEBRUIKEN / OBSERVERA

 <ul style="list-style-type: none"> • Avoid high temperatures. Allow for sufficient heat dispersion when installed in a rack. • Vermeiden Sie hohe Temperaturen. Beachten Sie, daß eine ausreichend Luftzirkulation gewährleistet wird, wenn das Gerät auf ein Regal gestellt wird. • Eviter des températures élevées. Tenir compte d'une dispersion de chaleur suffisante lors de l'installation sur une étagère. • Evitate di esporre l'unità a temperature alte. Assicuratevi che ci sia un'adeguata dispersione del calore quando installate l'unità in un mobile per componenti audio. • Evite altas temperaturas. Permite la suficiente dispersión del calor cuando está instalado en la consola. • Vermijd hoge temperaturen. Zorg voor een degelijk hitteafvoer indien het apparaat op een rek wordt geplaatst. • Undvik höga temperaturer. Se till att det finns möjlighet till god värmeavledning vid monteringen i ett rack. 	 <ul style="list-style-type: none"> • Keep the apparatus free from moisture, water, and dust. • Halten Sie das Gerät von Feuchtigkeit, Wasser und Staub fern. • Protéger l'appareil contre l'humidité, l'eau et lapoussiére. • Tenete l'unità lontana dall'umidità, dall'acqua e dalla polvere. • Mantenga el equipo libre de humedad, agua y polvo. • Laat geen vochtigheid, water of stof in het apparaat binnendringen. • Utsätt inte apparaten för fukt, vatten och damm. 	 <ul style="list-style-type: none"> • Do not let foreign objects into the apparatus. • Keine fremden Gegenstände in das Gerät kommen lassen. • Ne pas laisser des objets étrangers dans l'appareil. • E' importante che nessun oggetto è inserito all'interno dell'unità. • No deje objetos extraños dentro del equipo. • Laat geen vreemde voorwerpen in dit apparaat vallen. • Se till att främmande föremål inte tränger in i apparaten. 	<p>CAUTION:</p> <ul style="list-style-type: none"> • The ventilation should not be impeded by covering the ventilation openings with items, such as newspapers, tablecloths, curtains, etc. • No naked flame sources, such as lighted candles, should be placed on the apparatus. • Attention should be drawn to the environmental aspects of battery disposal. • Do not expose the set to dripping or splashing fluids. • No objects filled with liquids, such as vases, shall be placed on the apparatus. <p>ACHTUNG:</p> <ul style="list-style-type: none"> • Die Belüftung sollte auf keinen Fall durch das Abdecken der Belüftungsöffnungen durch Gegenstände wie beispielsweise Zeitungen, Tischtücher, Vorhänge o. Ä. behindert werden. • Auf dem Gerät sollten keinerlei direkten Feuerquellen wie beispielsweise angezündete Kerzen aufgestellt werden. • Bitte beachten Sie bei der Entsorgung der Batterien die geltenden Umweltbestimmungen. • Das Gerät sollte keinerlei Flüssigkeit, also keinem Tropfen oder Spritzen ausgesetzt werden. • Auf dem Gerät sollten keinerlei mit Flüssigkeit gefüllten Behälter wie beispielsweise Vasen aufgestellt werden.
 <ul style="list-style-type: none"> • Handle the power cord carefully. Hold the plug when unplugging the cord. • Gehen Sie vorsichtig mit dem Netzkabel um. Halten Sie das Kabel am Stecker, wenn Sie den Stecker herausziehen. • Manipuler le cordon d'alimentation avec précaution. Tenir la prise lors du débranchement du cordon. • Maneggiare il filo di alimentazione con cura. Agitare per la spina quando scollegate il cavo dalla presa. • Maneje el cordón de energía con cuidado. Sostenga el enchufe cuando desconecte el cordón de energía. • Hanteer het netsnoer voorzichtig. Houd het snoer bij de stekker vast wanneer deze moet worden aan- of losgekoppeld. • Hantera nätkabeln varsamt. Håll i kabeln när den kopplas från el-uttaget. 	 <ul style="list-style-type: none"> • Unplug the power cord when not using the apparatus for long periods of time. • Wenn das Gerät eine längere Zeit nicht verwendet werden soll, trennen Sie das Netzkabel vom Netzstecker. • Débrancher le cordon d'alimentation lorsque l'appareil n'est pas utilisé pendant de longues périodes. • Disinnestate il filo di alimentazione quando avete l'intenzione di non usare il filo di alimentazione per un lungo periodo di tempo. • Desconecte el cordón de energía cuando no utilice el equipo por mucho tiempo. • Neem altijd het netsnoer uit het stopcontact wanneer het apparaat gedurende een lange periode niet wordt gebruikt. • Koppla ur nätkabeln om apparaten inte kommer att användas i lång tid. 	 <ul style="list-style-type: none"> • Do not let insecticides, benzene, and thinner come in contact with the apparatus. • Lassen Sie das Gerät nicht mit Insektiziden, Benzin oder Verdünnungsmitteln in Berührung kommen. • Ne pas mettre en contact des insecticides, du benzène et un diluant avec l'appareil. • Assicuratevi che l'unità non venga in contatto con insetticidi, benzolo o solventi. • No permita el contacto de insecticidas, gasolina y diluyentes con el equipo. • Laat geen insektenverdelgende middelen, benzine of verfverdunder met dit apparaat in contact komen. • Se till att inte insektsmedel på spraybruk, bensen och thinner kommer i kontakt med apparatens hölje. 	<p>ATTENTION:</p> <ul style="list-style-type: none"> • La ventilation ne doit pas être gênée en recouvrant les ouvertures de la ventilation avec des objets tels que journaux, rideaux, tissus, etc. • Aucune flamme nue, par exemple une bougie, ne doit être placée sur l'appareil. • Veillez à respecter l'environnement lorsque vous jetez les piles usagées. • L'appareil ne doit pas être exposé à l'eau ou à l'humidité. • Aucun objet contenant du liquide, par exemple un vase, ne doit être placé sur l'appareil. <p>PRECAUZIONI:</p> <ul style="list-style-type: none"> • Le aperture di ventilazione non devono essere ostruite coprendole con oggetti, quali giornali, tovaglie, tende e così via. • Non posizionare sull'apparecchiatura fiamme libere, come ad esempio le candele accese. • Prestare attenzione agli aspetti legati alla tutela dell'ambiente quando si smaltisce la batteria. • L'apparecchiatura non deve essere esposta a gocciolii o spruzzi. • Non posizionare sull'apparecchiatura nessun oggetto contenete liquidi, come ad esempio i vasi. <p>PRECAUCIÓN:</p> <ul style="list-style-type: none"> • La ventilación no debe quedar obstruida por hacerse cubierto las aperturas con objetos como periódicos, manteles, cortinas, etc. • No debe colocarse sobre el aparato objetos llenos de líquido, como jarras. • A la hora de deshacerse de las pilas, respete la normativa para el cuidado del medio ambiente. • No se expondrá el aparato al goteo o salpicaduras cuando se utilice. • No se colocarán sobre el aparato objetos llenos de líquido, como jarras.
 <p>* (For apparatuses with ventilation holes)</p> <ul style="list-style-type: none"> • Do not obstruct the ventilation holes. • Die Belüftungsöffnungen dürfen nicht verdeckt werden. • Ne pas obstruer les trous d'aération. • Non coprite i fori di ventilazione. • No obstruya los orificios de ventilación. • De ventilatieopeningen mogen niet worden geblokkeerd. • Täpp inte till ventilationsöppningarna. 	 <ul style="list-style-type: none"> • Never disassemble or modify the apparatus in any way. • Versuchen Sie niemals das Gerät auseinander zu nehmen oder auf jegliche Art zu verändern. • Ne jamais démonter ou modifier l'appareil d'une manière ou d'une autre. • Non smontate mai, nè modificate l'unità in nessun modo. • Nunca desarme o modifique el equipo de ninguna manera. • Nooit dit apparaat demonteren of op andere wijze modificeren. • Ta inte isär apparaten och försök inte bygga om den. 	<p>WAARSCHUWING:</p> <ul style="list-style-type: none"> • De ventilatie mag niet worden belemmerd door de ventilatieopeningen af te dekken met bijvoorbeeld kranten, een tafelkleed, gordijnen, enz. • Plaats geen open vlammen, bijvoorbeeld een brandende kaars, op het apparaat. • Houd u steeds aan de milieuvoorschriften wanneer u gebruikte batterijen wegdoet. • Stel het apparaat niet bloot aan druppels of spatten. • Plaats geen voorwerpen gevuld met water, bijvoorbeeld een vaas, op het apparaat. <p>OBSERVERA:</p> <ul style="list-style-type: none"> • Ventilationen bör inte förhindras genom att täcka för ventilationsöppningarna med föremål såsom tidningar, bordsdukar, gardiner osv. • Inga blottade brandkällor, såsom tända ljus, bör placeras på apparaten. • Tänk på miljöaspekterna när du bortskaffar batteri. • Apparaten får inte utsättas för vätska. • Inga objekt med vätskor, såsom vaser, får placeras på apparaten. 	

A NOTE ABOUT RECYCLING:

This product's packaging materials are recyclable and can be reused. Please dispose of any materials in accordance with the local recycling regulations.

When discarding the unit, comply with local rules or regulations.

Batteries should never be thrown away or incinerated but disposed of in accordance with the local regulations concerning chemical waste.

This product and the accessories packed together constitute the applicable product according to the WEEE directive except batteries.

**HINWEIS ZUM RECYCLING:**

Das Verpackungsmaterial dieses Produktes ist für zum Recyceln geeignet und kann wieder verwendet werden. Bitte entsorgen Sie alle Materialien entsprechend der örtlichen Recycling-Vorschriften.

Beachten Sie bei der Entsorgung des Gerätes die örtlichen Vorschriften und Bestimmungen.

Die Batterien dürfen nicht in den Hausmüll geworfen oder verbrannt werden; bitte geben Sie die Batterien gemäß örtlichen Bestimmungen an den Sammelstellen oder Sondermüllplätzen ab.

Dieses Produkt zusammen mit den Zubehörteilen ist das geltende Produkt der WEEE-Direktive, davon ausgenommen sind die Batterien.

UNE REMARQUE CONCERNANT LE RECYCLAGE:

Les matériaux d'emballage de ce produit sont recyclables et peuvent être réutilisés. Veuillez disposer de tout matériau conformément aux règlements de recyclage locaux.

Lorsque vous mettez cet appareil au rebut, respectez les lois ou réglementations locales.

Les piles ne doivent jamais être jetées ou incinérées, mais mises au rebut conformément aux règlements locaux concernant les déchets chimiques.

Ce produit et les accessoires emballés ensemble sont des produits conformes à la directive DEEE sauf pour les piles.

NOTA RELATIVA AL RICICLAGGIO:

I materiali di imballaggio di questo prodotto sono riutilizzabili e riciclabili. Smaltire i materiali conformemente alle normative locali sul riciclaggio.

Per smaltire l'unità, osservare la normativa in vigore nel luogo di utilizzo.

Non gettare le batterie, né incenerirle, ma smaltirle conformemente alla normativa locale sui rifiuti chimici.

Questo prodotto e gli accessori inclusi nell'imballaggio sono applicabili alla direttiva RAEE, ad eccezione delle batterie.

ACERCA DEL RECICLAJE:

Los materiales de embalaje de este producto son reciclables y se pueden volver a utilizar. Disponga de estos materiales siguiendo los reglamentos de reciclaje de su localidad.

Cuando se deshaga de la unidad, cumpla con las reglas o reglamentos locales.

Las pilas nunca deberán tirarse ni incinerarse. Deberá disponer de ellas siguiendo los reglamentos de su localidad relacionados con los desperdicios químicos.

Este producto junto con los accesorios empacados es el producto aplicable a la directiva RAEE excepto pilas.

EEN AANTEKENING WAT BETREFT HET RECYCLEREN:

Het inpakmateriaal van dit product is recycleerbaar en kan opnieuw gebruikt worden. Er wordt verzocht om zich van elk afvalmateriaal te ontdoen volgens de plaatselijke voorschriften.

Volg voor het wegdoen van de speler de voorschriften voor de verwijdering van wit- en bruingoed op.

Batterijen mogen nooit worden weggegooid of verbrand, maar moeten volgens de plaatselijke voorschriften betreffende chemisch afval worden verwijderd.

Op dit product en de meegeleverde accessoires, m.u.v. de batterijen is de richtlijn voor afgedankte elektrische en elektronische apparaten (WEEE) van toepassing.

EN KOMMENTAR OM ÅTERVINNING:

Produktens emballage är återvinningsbart och kan återanvändas. Kassera det enligt lokala återvinningsbestämmelser. När du kasserar enheten ska du göra det i överensstämmelse med lokala regler och bestämmelser.

Batterier får absolut inte kastas i soporna eller brännas. Kassera dem enligt lokala bestämmelser för kemiskt avfall.

Denna apparat och de tillbehör som levereras med den är de som uppfyller gällande WEEE-direktiv, med undantag av batterierna.

CAUTION:

To completely disconnect this product from the mains, disconnect the plug from the wall socket outlet.

The mains plug is used to completely interrupt the power supply to the unit and must be within easy access by the user.

VORSICHT:

Um dieses Gerät vollständig von der Stromversorgung abzutrennen, trennen Sie bitte den Netzstecker von der Wandsteckdose ab.

Die Hauptstecker werden verwendet, um die Stromversorgung zum Gerät völlig zu unterbrechen; er muss für den Benutzer gut und einfach zu erreichen sein.

PRECAUTION:

Pour déconnecter complètement ce produit du courant secteur, débranchez la prise de la prise murale.

La prise secteur est utilisée pour couper complètement l'alimentation de l'appareil et l'utilisateur doit pouvoir y accéder facilement.

ATTENZIONE:

Per scollegare definitivamente questo prodotto dalla rete di alimentazione elettrica, togliere la spina dalla relativa presa.

La spina di rete viene utilizzata per interrompere completamente l'alimentazione all'unità e deve essere facilmente accessibile all'utente.

PRECAUCIÓN:

Para desconectar completamente este producto de la alimentación eléctrica, desconecte el enchufe del enchufe de la pared.

El enchufe de la alimentación se utiliza para interrumpir por completo el suministro de alimentación a la unidad y debe de encontrarse en un lugar al que el usuario tenga fácil acceso.

VOORZICHTIGHEID:

Om de voeding van dit product volledig te onderbreken moet de stekker uit het stopcontact worden getrokken.

De netstekker wordt gebruikt om de stroomtoevoer naar het toestel volledig te onderbreken en moet voor de gebruiker gemakkelijk bereikbaar zijn.

FÖRSIKTIHETSMÅTT:

Koppla loss stickproppen från eluttaget för att helt skilja produkten från nätet.

Stickproppen används för att helt bryta strömförsörjningen till apparaten, och den måste vara lättillgänglig för användaren.

Thank you for purchasing this DENON CD/HDD Music System. Please read the operation instructions thoroughly in order to acquaint yourself with the CD/HDD Music System and achieve maximum satisfaction from it.

Be sure to keep these instructions for future reference, should any questions or problems arise.

Contents

Getting Started		Operation		Playback	
Accessories	2	Before operating		Playing tracks on the HDD	22
Features of the CHR-F103	2, 3	Turning the power on.....	14	Searching for and playing tracks on the HDD.....	22, 23
Before using	3	Selecting the function.....	14	CD playback	
Cautions on handling the hard disk		Loading discs.....	14	Playing CDs.....	23
(also referred to as hard disk drive or “HDD”)	3	Switching the display.....	15	Playing music files	
About discs		Dimmer function	15	Before playing MP3 or WMA files.....	24
Discs usable on this set.....	4			Creating MP3 or WMA discs (CD-R/CD-RW discs)	
Holding discs.....	4			compatible with the CHR-F103	24
Loading discs.....	4			Playing files.....	25
Cautions on loading discs.....	4	Setup		Special playback features	
Cautions on handling.....	4	Setting operations	15	Playing programs.....	25
Cautions on storing discs.....	4	Making the recording mode settings (Store Setting)		Playing in random order.....	25
Cleaning discs.....	5	Setting the recording sound quality (Store Mode)	15	Playing tracks (files) repeatedly.....	26
About the remote control unit		Recording monitor auto playback setting (Store Monitor).....	16	Listening to Internet radio.....	26, 27
Inserting the batteries.....	5	Making the network settings (Network Setting)		Registering Internet radio stations as your favorites.....	27
Operating range of the remote control unit.....	5	Making the IP address settings (IP Address).....	16	Presetting (registering) Internet radio stations.....	27
Part names and functions		Making the Internet radio settings (Internet Radio).....	17	Updating the list of radio stations.....	28
Front panel.....	6	Making other settings (Others)		Playing music files stored on a computer (music server).....	28, 29
Display.....	6	PC applications (PC Connect Mode).....	17	Playback of USB memory devices	
Rear panel.....	7	HDD information (HDD Info).....	17	Before playing a USB memory device.....	29
Remote control unit.....	8, 9	Setting the display characters (Character).....	17	Playing USB memory devices.....	29
Recommended system layout	10	Inputting the computer's language (PC Language).....	18		
		Updating the CDDb (CDDb Update).....	18	Editing	
				Inputting characters	
Connections				Changing titles.....	30
Cable indications	10	Recording and Deleting		Changing genre names.....	31
System connections	11	Before recording		Creating playlists	
Using the network audio function		Sources that can be recorded.....	19	Adding tracks to playlists.....	31
Gracenote® music recognition service.....	12	Setting the recording mode.....	19	Clearing tracks from playlists.....	31
Internet radio function.....	12	Recording		Changing the order of tracks on playlists.....	31
Music server function.....	12	Recording CDs.....	19	Clearing playlists.....	31
Network audio connection and required system.....	12, 13	Monitoring the tracks being recorded.....	20	Clearing all the playlists.....	31
Network-related settings.....	13	Deleting			
		Deleting single tracks.....	20		
		Deleting tracks by album or artist name.....	21		
		Deleting all tracks.....	21		

System Operations

Auto power on function32
 Auto function selection32
 CD synchronized recording33
 Timer playback function33
 Edit function33

PC applications

Denon Music Manager function

Required recommended equipment and environment
 for using Denon Music Manager34
 Installing Denon Music Manager34
 Connecting to a computer34

Others

Trademarks35
 Troubleshooting36, 37
 Hard disk inspection and repairs37
 Specifications38

Getting Started

Accessories

Check that the following parts are attached in addition to the main unit:

① Operating instructions1
 ② Service station list.....1
 ③ Remote control unit (RC-1042)1
 ④ R6P/AA batteries2
 ⑤ Pin-plug cable (Cable length: Approx. 0.6 m).....1
 ⑥ System cable (mini-plug cable)
 (Cable length: Approx. 0.5 m)1
 ⑦ Denon Music Manager disc (CD-ROM)
 (including installation instructions)1

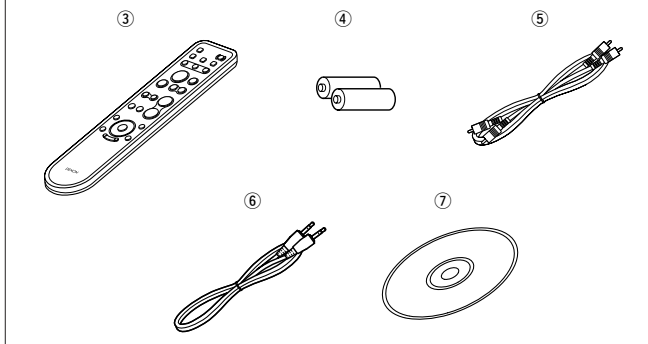

Features of the CHR-F103

Recording of your CD library onto the hard disk

Recording of up to 900 CD tracks in linear PCM format offering the same quality as CDs*1 or up to about 10,000 tracks in high quality compression WMA (Windows Media Audio)*2 format onto the CHR-F103's hard disk.

*1: Calculated based on 4 minutes per track
 *2: In the standard mode

Automatic display of titles using the Gracenote® database

The CHR-F103 includes a database of the titles of some 350,000 CDs*3, so when the tracks from a CD are recorded on to the hard disk, the CD's album name, track names and artist names are also recorded and displayed automatically. An Internet environment can be used to acquire and display the track data for new releases and CDs not included in the built-in database over the Internet from the Gracenote® server.

*3: Information for some 350,000 titles is included from the Gracenote® database as of April 2006.

Easy searching thanks to various search menus

In addition to the "genre", "artist", "album" and "track" search menus, it is also possible to create up to 20 original playlists or use two automatically generated playlists (of recently recorded tracks and recently played tracks) to easily search for the desired track among the many tracks recorded on the hard disk.

Monitoring of the tracks being recorded

When recording from a CD onto the hard disk, it is possible to monitor the tracks being recorded or to play tracks previous recorded on the hard disk.

Editing of files from a computer using Denon Music Manager

"Denon Music Manager", an exclusive application, can be used to edit the titles of track lists or to edit playlists. It can also be used to import music files from a computer onto the CHR-F103 or backup the tracks from the hard disk onto a computer.

Internet Radio function

The CHR-F103 can be used to listen to radio broadcasts distributed around the world from Internet radio stations. "vTuner", an Internet radio station database service, offers access to radio stations using a list customized for DENON users.

Music server compatibility

The CHR-F103 is compatible with network music players. Music files stored on a computer can be played on the CHR-F103 via a LAN.

USB port for playing USB memory devices

Large display for easy checking of titles

192 kHz/24 bit high precision D/A converter

8x oversampling digital filter

Deluxe looking front design

Playback of MP3 and WMA audio files recorded on CD-R/CD-RW discs

System functions when used in combination with DENON F102 series components

- Auto power on
- Auto function selection
- CD Synchro recording
- Timer playback
- Repeat play/CD programmed play/Random play

Optical digital output terminals

Before using

Pay attention to the following before using this unit:

• Moving the unit.

First eject the disc and turn off the power, wait 3 minutes after turning off the power, then unplug the power cord from the power outlet.

Disconnect the connection cables between the different components before doing this.

• Cautions on using mobile phones.

Using a mobile phone near this unit may result in noise. If so, move the mobile phone away from this unit when it is in use.

• Condensation (dew).

Water droplets may condense on internal operation parts if the set is brought into a heated room from the cold outdoors or when the room is heated rapidly. If this happens, the set may not operate properly.

• Should condensation occur.

The condensation will evaporate in one hour or less, at which time the system will function normally.

• Before turning the power operation switch on.

Check once again that all connections are correct and that there are not problems with the connection cables. Always set the power operation switch to the standby position before connecting and disconnecting connection cables.

• Sufficiently ventilate the place of installation.

If the unit is left in a room full of the smoke from cigarettes, etc., for long periods of time, the surface of the optical pickup could get dirty, in which case it will not be able to read the signals properly.

• Store the operating instructions in a safe place.

After reading the operating instructions, store them in a safe place as they could come in handy in the future.

• Power is supplied to some of the circuitry even when the power is set to the standby mode using the power operation switch. When traveling or leaving home for long periods of time, be sure to unplug the power supply cord from the power outlet.

• Note that the illustrations in these instructions may differ from the actual unit for explanation purposes.

NOTE:

- This CD/HDD music system uses a semiconductor laser. To ensure stable operation, it is recommended to use the set indoors at a temperature of 5°C (41°F) ~ 35°C (95°F).

Cautions on handling the hard disk (also referred to as hard disk drive or "HDD")

The HDD is a recording medium with many fragile elements. Be careful of the following when handling it.

Cautions on the installation environment

- Do not obstruct the cooling fan's ventilation holes on the rear panel.
- Set on a flat surface that is not subject to vibrations or shocks.
- Do not place on receivers (amplifiers) or other components that get hot during operation.
- Place in a room that does not fill with smoke. (Cigarette smoke, the smoke from the food smoking process, insecticides and the like can damage the HDD.)

Cautions during operation

To avoid partial damage to the HDD's recording surface or malfunction of the HDD, heed the following during operation:

- Do not subject to vibrations or shocks.
- Do not unplug the power cord. (Note that the sound being recorded or played could be lost if there is a power failure during operation.)

Backing up the HDD

By way of precaution against HDD breakdown, it is recommended that you periodically back up the recorded data onto a computer (☞ page 34).

Notice of exemption from responsibility for compensation for loss of recorded information

DENON will accept no responsibility whatsoever for compensation for recordings or editings that could not be performed properly or for loss of recorded or edited content, regardless of the cause of the problem.

Also note that DENON will accept no responsibility for loss of contents during repairing of the CHR-F103.

About discs

Discs usable on this set

1 Music CDs

Discs with the mark at the right can be used on this set.

Note however that discs with special shapes (heart-shaped discs, octagonal discs, etc.) cannot be played. Do not attempt to play them, as doing so could damage the set.

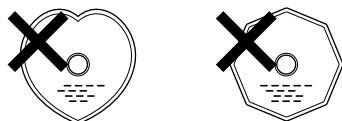

2 CD-R/CD-RW

- Some discs and some recording formats may not be playable.
- Non-finalized discs cannot be played.

※ Finalization:

Finalization is the process that makes recorded CD-R/CD-RW discs playable on compatible players.

Holding discs



Do not touch the signal surface.

Loading discs

- Set the disc with the labeled side facing up.
- Make sure the disc tray is fully open when inserting the disc.
- Place the discs flatly, 12 cm discs in the outer tray guide (Figure 1), 8 cm discs in the inner tray guide (Figure 2).

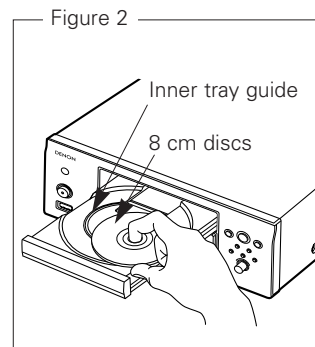
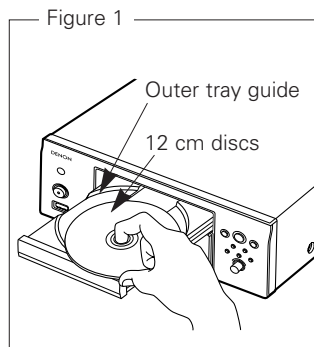

- Place 8 cm discs in the inner tray guide without using an adapter.



- In the following cases, "No Disc" is shown on the display:
 - When no disc is loaded
 - When the disc is loaded upside-down
 - When the disc's information could not be read properly

Cautions on loading discs

- Only load one disc at a time. Loading two or more discs can damage the set or scratch the discs.
- Do not use cracked or warped discs or discs that have been repaired with adhesive, etc.
- Do not use discs on which the sticky part of cellophane tape or labels is exposed or on which there are traces of where labels have been removed. Such discs could get caught inside the player and damage it.

Cautions on handling

- Do not get fingerprints, oil or dirt on discs.
- Take special care not to scratch discs when removing them from their cases.
- Do not bend or heat discs.
- Do not enlarge the hole at the center.
- Do not write on the labeled (printed) surface with ball-point pens, pencils, etc., or stick new labels on discs.
- Water droplets may form on discs if they are moved suddenly from a cold place (outdoors for example) to a warm place, but do not try to dry them off using a hairdryer, etc.

Cautions on storing discs

- Be sure to remove discs after using them.
- Be sure to store discs in their cases to protect them from dust, scratches, warping, etc.
- Do not store discs in the following places:
 1. Places exposed to direct sunlight for long periods of time
 2. Dusty or humid places
 3. Places exposed to heat from heating appliances, etc.

Cleaning discs

- If there are fingerprints or dirt on discs, wipe them off before using the disc. If not the sound quality could be reduced and the sound may be broken.
- Use a commercially available disc cleaning set or a soft cloth to clean discs.



Gently wipe the disc from the inside towards the outside.

Do not wipe with a circular motion.

NOTE:

- Do not use record spray, antistatic agents, or benzene, thinner or other solvents.

About the remote control unit

The included remote control unit (RC-1042) can be used to operate not only the CHR-F103 but also other components in the F102 series (page 32).

NOTE:

- The system remote control unit included with the receiver (DRA-F102/F102DAB) cannot be used to operate the CHR-F103. Use the remote control unit included with the CHR-F103.

Inserting the batteries

- ① Remove the remote control unit's rear cover.
- ② Set two R6P/AA batteries in the battery compartment in the indicated direction.
- ③ Put the rear cover back on.

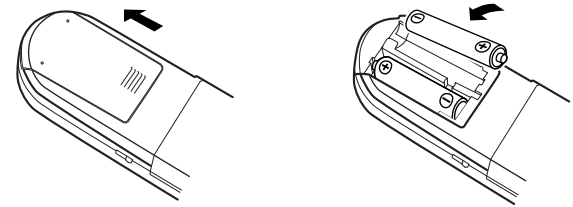

- ③ Put the rear cover back on.

Notes on batteries:

- Replace the batteries with new ones if the set does not operate even when the remote control unit is operated nearby the unit. (The attached batteries are only for verifying operation.)
- When inserting the batteries, be sure to do so in the proper direction, following the “⊕” and “⊖” marks in the battery compartment.
- To prevent damage or leakage of battery fluid:
 - Do not use a new battery together with an old one.
 - Do not use two different types of batteries.
 - Do not short-circuit, disassemble, heat or dispose of batteries in flames.
- If the battery fluid should leak, carefully wipe the fluid off the inside of the battery compartment and insert new batteries.
- Remove the batteries from the remote if it will not be in use for long periods.

Operating range of the remote control unit

- Point the remote control unit at the remote sensor when operating it.
- When used connected to other components in the F102 series, point the remote control unit at the remote control sensor of the receiver (DRA-F102/F102DAB) when operating it.
- The remote control unit can be used from a distance of up to about 7 meters, at a horizontal angle of up to 30° with respect to the sensor.

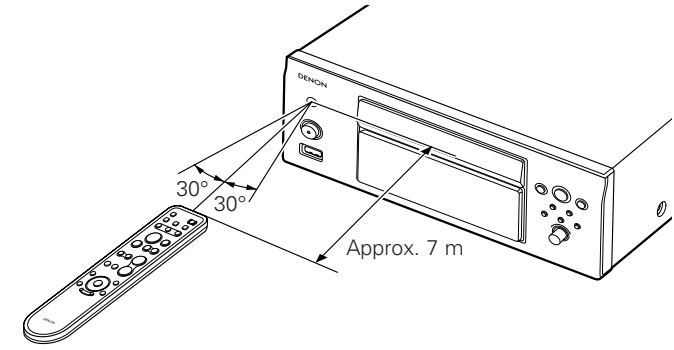

NOTE:

- The set may function improperly or the remote control unit may not operate if the remote control sensor is exposed to direct sunlight, strong artificial light from an inverter type fluorescent lamp or infrared light.

Part names and functions

For buttons not explained here, see the page indicated in parentheses ().

Front panel

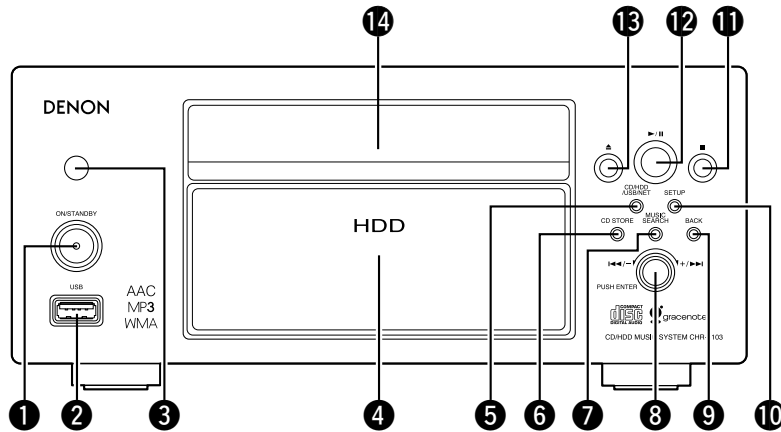

- 1 Power operation switch (ON/STANDBY)(14)
- 2 USB input terminal(29)
- 3 Remote control sensor(5)
- 4 Display
- 5 CD/HDD/USB/NET button(14)
- 6 CD STORE button(19)
- 7 MUSIC SEARCH button(22)
- 8 Jog dial/PUSH ENTER button(15)
 Turn: To select (+/-) while a list is displayed
 During playback: Skip (◀◀/▶▶)
- Press: Set (ENTER)
- 9 BACK button(15)
- 10 SETUP button(15)
- 11 Stop button (■)(19)
- 12 Play/pause button (▶/||)(22, 23)
- 13 Disc tray open/close button (▲)(14)
- 14 Disc tray(4)

Display

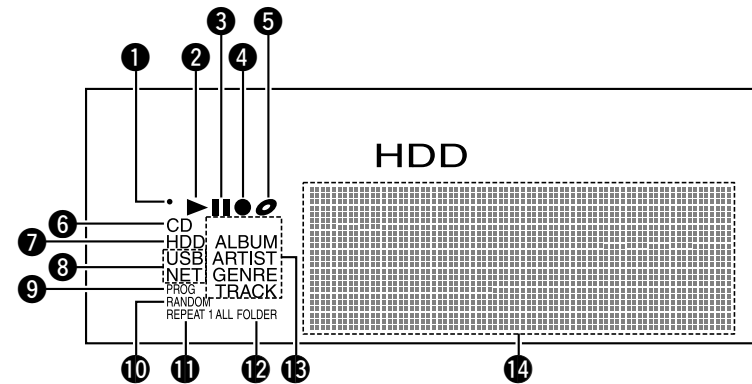

- 1 Lights when a remote control signal is received.
- 2 Lights when a disc is playing.
- 3 Lights when the pause mode is set.
- 4 Lights during recording from a CD onto the HDD.
- 5 Lights while a disc is being loaded.
- 6 Lights when the CD function is set.
- 7 Lights when the HDD function is set.
- 8 Lights when the USB/NET function is set.
- 9 Lights during programmed playback.
- 10 Lights during random playback.
- 11 Lights during repeat playback.
- 12 Lights when the folder mode is set.
- 13 Light to indicate the type of file currently displayed on the list when the HDD function is set.
- 14 Display screen

Rear panel

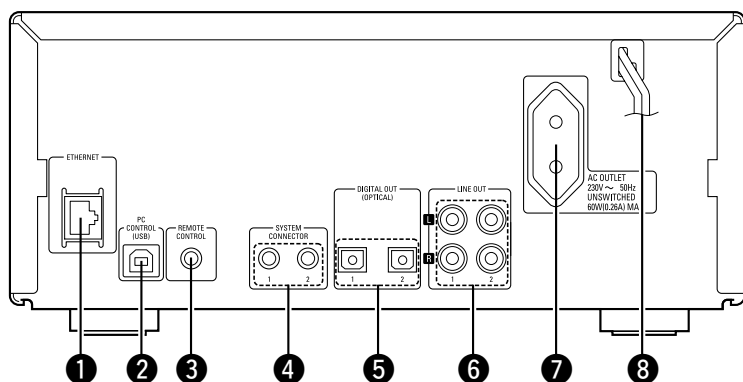

- 1** ETHERNET terminal(12)
- 2** PC CONTROL (USB) terminal(34)
- 3** REMOTE CONTROL jack
This terminal will be used in the future for additional functions.
- 4** SYSTEM CONNECTOR jacks(11)
- 5** DIGITAL OUT (OPTICAL) terminals(11)
- 6** LINE OUT terminals(11)
Use the LINE OUT 1 terminals as the main output, the LINE OUT 2 terminals as the recording output.
- 7** AC outlet(11)
- 8** Power supply cord(11)

Remote control unit

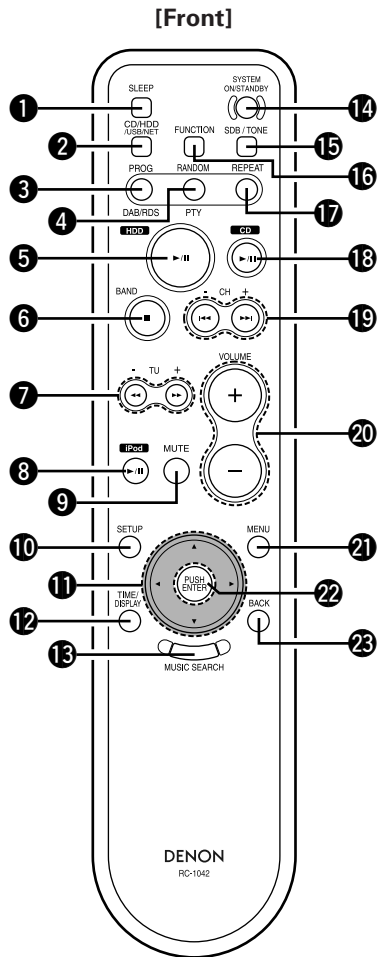

- ❶ SLEEP button*
- ❷ CD/HDD/USB/NET button(14)
- ❸ PROGRAM button(25)
- ❹ RANDOM button(25)
- ❺ HDD play/pause button (▶/⏸)(22)
- ❻ Stop (■)/BAND* button(19)
- ❼ Tuning buttons (+, -)*
Search buttons (◀◀, ▶▶)(23)
- ❽ iPod play/pause button (▶/⏸)*
- ❾ MUTE button*
- ❿ SETUP button(15)
- ⓫ Cursor buttons (△, ▽, ◀, ▶)(15)
- ⓬ TIME/DISPLAY button(15)
- ⓭ MUSIC SEARCH button(22)
- ⓮ SYSTEM ON/STANDBY button(14)
- ⓯ SDB/TONE button*
- ⓰ FUNCTION button*
- ⓱ REPEAT button(26)
- ⓲ CD play/pause button (▶/⏸)(23)
- ⓳ Channel buttons (+, -)*
Skip buttons (I◀◀, ▶▶I)(23)
- ⓴ VOLUME buttons (+, -)*
- ⓵ MENU button(33)
- ⓶ PUSH ENTER button(15)
- ⓷ BACK button(15)

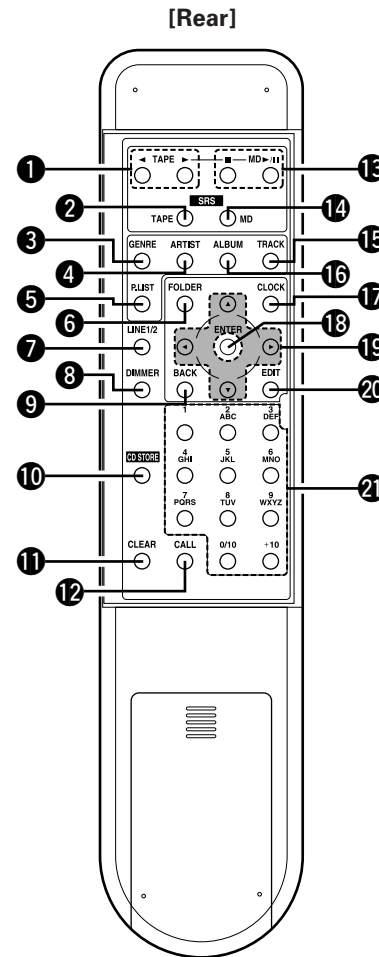

- ❶ TAPE buttons*
- ❷ TAPE SRS button*
- ❸ GENRE button(22)
- ❹ ARTIST button(22)
- ❺ PLAY LIST button(22)
- ❻ FOLDER button(24)
- ❼ LINE 1/2 button*
- ❽ DIMMER button(15)
- ❾ BACK button(15)
- ❿ CD STORE button(19)
- ⓫ CLEAR button(25)
- ⓬ CALL button(25)
- ⓭ MD buttons*
- ⓮ MD SRS button*
- ⓯ TRACK button(22)
- ⓰ ALBUM button(22)
- ⓱ CLOCK button*
- ⓲ ENTER button(15)
- ⓳ Cursor buttons (△, ▽, ◀, ▶)(19)
- ⓴ EDIT button(20)
- ⓵ Number buttons (0 ~ 9, 0/10, +10)(15)

* : Indicates buttons that can be used when system connections are made (see page 11). Refer to the operating instructions of the components connected using system connections.

NOTE:
• If buttons on the front or rear are pressed strongly, the button on the opposite side will be activated too.

□ Buttons operable for the different functions

CD function

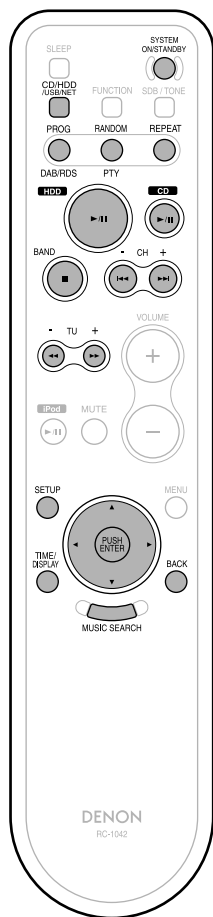

HDD function

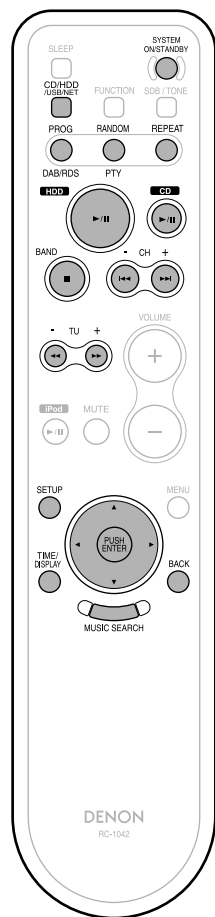

USB/NET function

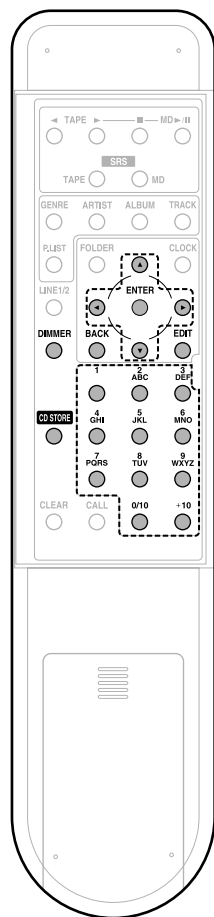
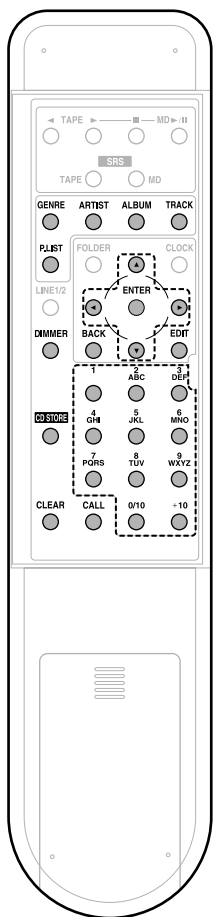
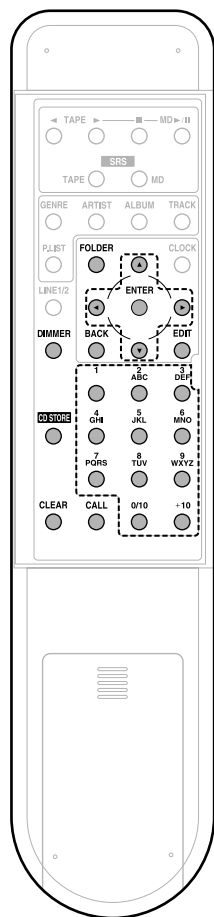
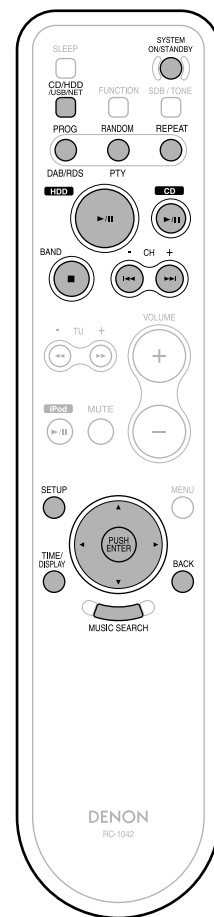

Recommended system layout

To ensure performance and safety, it is recommended to arrange the components as shown below when connecting to models in the F102 series.

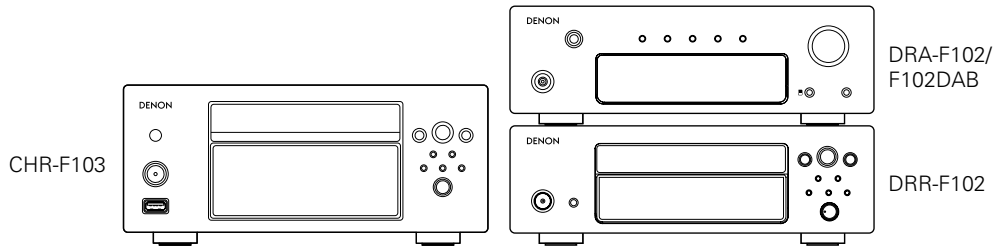

NOTE:

- Arrange in such a way that the receiver's ventilation holes are not obstructed so that the heat can dissipate.
- Do not place other components directly on top of the receiver.
- To ensure safety, do not make stacks of more than three components.

Connections

NOTE:

- Do not plug in the power supply cord until all connections have been completed.
- When making connections, also refer to the operating instructions of the other components.
- Be sure to connect the left and right channels properly (left with left, right with right).
- Do not bundle power supply cords together with speaker cables. Doing so could result in humming or noise.
- Making connections with the power turned on could result in noise or damage the speakers.
- Bunching the power supply cords and connection cables together could result in humming or noise.
- Connect all the connection cables between the different components firmly. The system may not operate properly if the connections are incomplete.
- Be sure to disconnect the power supply cords when changing the connections. Changing the connections while the system is operating could result in malfunction.

Cable indications

Connect using the connection cables shown below.

Audio cable	Signal direction
<p>A Analog connections (Stereo)</p> <p>(White) (Red)</p> <p>Pin-plug cable</p> <p>B System connections</p> <p>System cable</p>	<p>Audio signal</p> <p>IN OUT</p> <p>OUT IN</p>

System connections

System operations can be performed when the components of the F102 series are connected with system cables (see page 32, 33).



- All of the system operations are controlled from the receiver (DRA-F102/F102DAB).
- It is also possible to connect devices other than F102 series components. In this case, however, system operations cannot be performed.

□ When connecting the optical digital output connector with an optical transmission cable (commercially available)

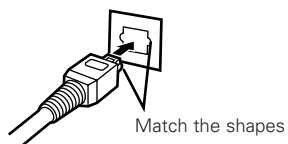

Match the shapes then insert firmly all the way in.

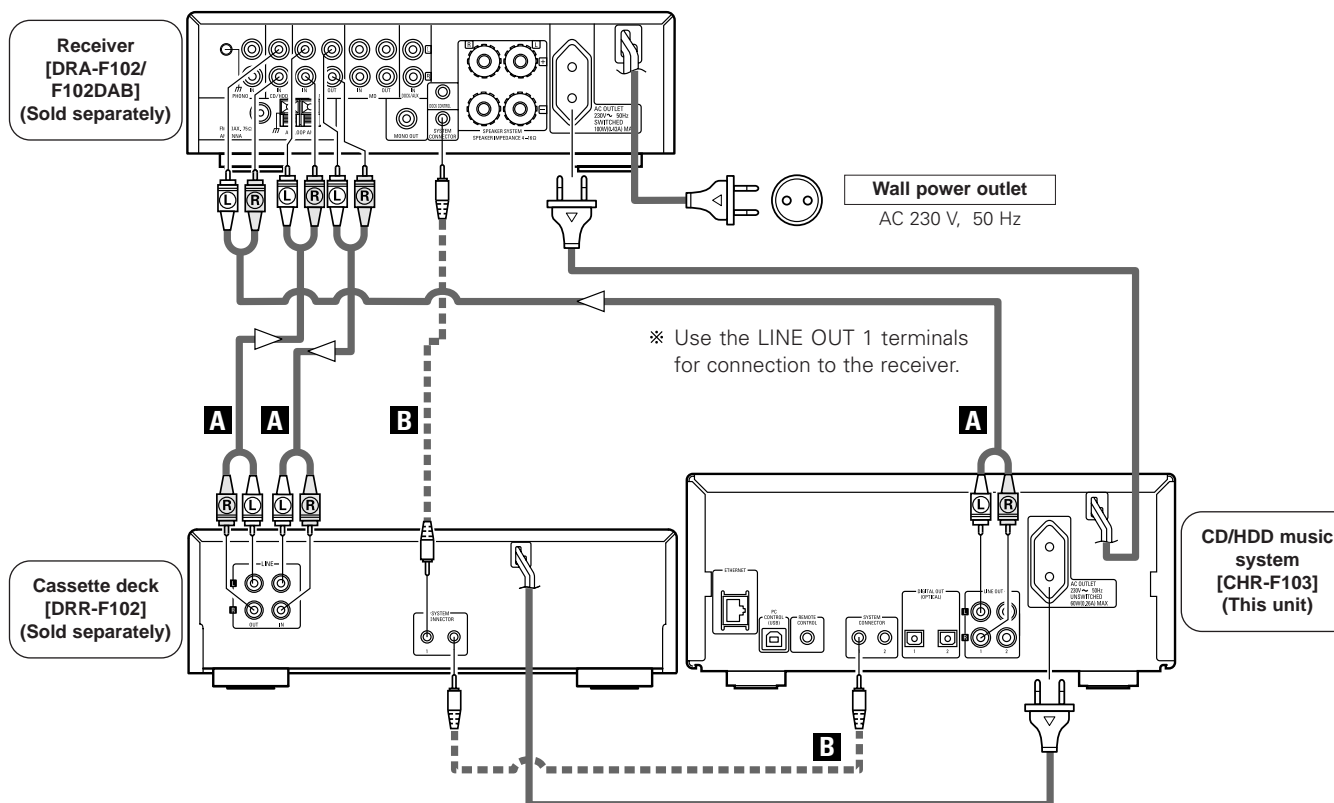

NOTE:

- Do not unplug the power supply cord while the system is operating.
- The maximum total power consumption of devices connected to the CHR-F103's AC outlets is 60 W. Do not connect devices with power consumptions greater than 60 W.

Using the network audio function

When connected to a network, the following functions can be used:

- Gracenote® music recognition service
- Internet radio
- Music server

Gracenote® music recognition service

The “Gracenote® music recognition service” is the name of a service provided by Gracenote® and generally known as “CDDB”.

Text information on CD titles, artist names, track names, etc., can be obtained automatically and displayed on the CHR-F103’s display by accessing the Gracenote® server over the Internet.

If you do not have the environment for connecting to the Internet

The CHR-F103 has part of the Gracenote® database stored in it*, so some title information can be obtained without connecting to the Internet.

Note, however, that the internal database may not contain title information for recently released CDs.

*: Information for approximately 350,000 titles selected from the Gracenote® database in April 2006 is stored in the CHR-F103.

Using the “Gracenote® music recognition service”

You do not have to perform any operation in particular.

When a CD is inserted or when recording or playback of a CD begins, the CD’s text information is acquired automatically and displayed on the CHR-F103.

Internet radio function

Internet radio refers to radio programs broadcast over the Internet. With this function you can listen to Internet radio broadcasts from all over the world.

- Stations can be selected by genre or region.
- Up to 60 stations can be preset.
- MP3 format Internet radio programs can be played.
- Your favorite radio stations can be registered by accessing an exclusive DENON Internet radio URL from a Web browser on a computer. (A setting must be made for automatic download (☞ page 28).) (The function is managed for individual users, so you must provide your MAC or e-mail address.) Exclusive URL: <http://www.radiodenon.com>

vTuner

The CHR-F103’s Internet radio station list uses “vTuner”, a radio station database service. This database service is edited and prepared for the CHR-F103.

Music server function

This function plays music files stored on a computer via a LAN (local area network).

Connection to the server is done using one of the following technologies:

- Windows Media Connect
- Windows Media DRM10

Network audio connection and required system

Broadband Internet connection

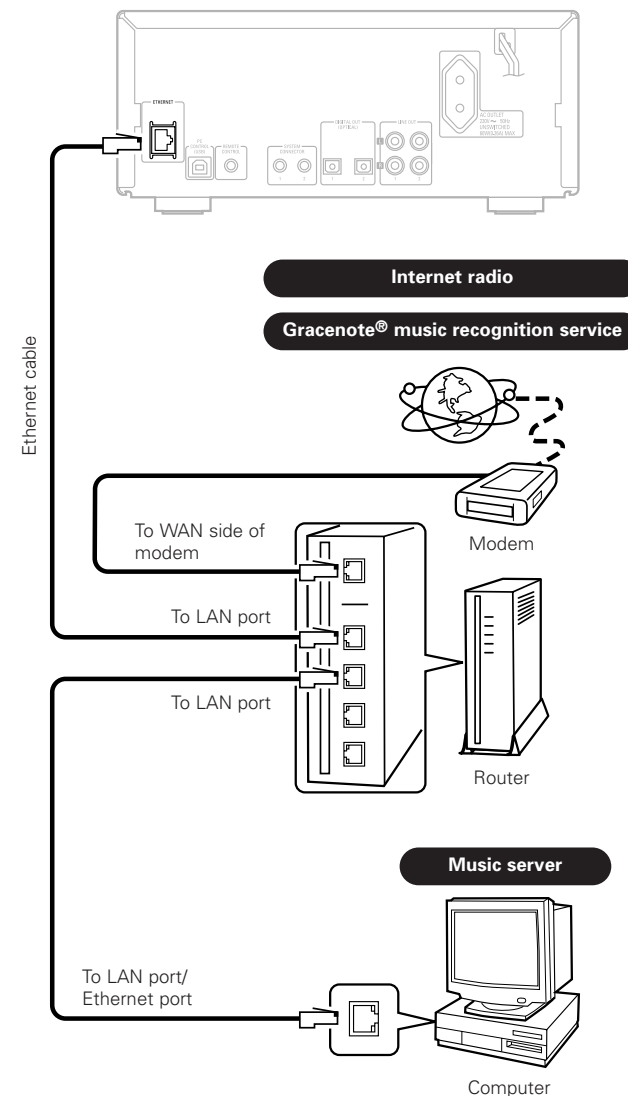

Modem

Router

When using the CHR-F103, we recommend using a router equipped with the functions listed below.

- Built-in DHCP (Dynamic Host Configuration Protocol) server
This is a function that automatically assigns IP addresses to devices on the LAN.
- Built-in 100BASE-TX switch
To connect multiple devices, it is recommended to have a built-in switching hub with a speed of 100 Mbps or greater.

Ethernet cable (CAT-5 or greater recommended)

No Ethernet cable is included with the CHR-F103. Procure a cable with the necessary length.

NOTE:

- Be sure to use a shielded type cable for USB/Ethernet connections.
Depending on the connected computer/router, there may be much noise generated from the cable.

Personal computer

For the music server function, a computer with the following specifications is required:

- 1) OS (Operating System):
Windows® XP Service pack 2
- 2) Processor:
Intel Pentium®II or AMD processor, etc.
We recommend 1 GHz or greater.
- 3) RAM:
Min. 128 MB, we recommend 256 MB or greater.
- 4) Software:
.NET Framework 1.1
- 5) Internet browser:
Microsoft Internet Explorer 5.01 or later
- 6) LAN port required
- 7) 300 MB or greater free hard disc space required

※ Free hard disk space is required to store music files.
The following table gives an approximate estimate of the required free space.

Format	Bit rate	Per one minute	Per one hour
MP3/WMA	128 kbps	Approx. 1 MB	Approx. 60 MB
	192 kbps	Approx. 1.5 MB	Approx. 90 MB
	256 kbps	Approx. 2 MB	Approx. 120 MB
	392 kbps	Approx. 3 MB	Approx. 180 MB
WAV (LPCM)	1400 kbps	Approx. 10 MB	Approx. 600 MB



- Depending on the server, video files may also be displayed, but they cannot be played on the CHR-F103.

NOTE:

- You must have a contract with an Internet service provider (ISP) in order to connect to the Internet.
(If you already have a broadband connection to the Internet, no new contract is required.)
- For instructions on connecting to the Internet, contact your ISP or a computer store.
- The types of routers that can be used depend on the ISP.
For details, contact your ISP or a store selling computers and related equipment.

Network-related settings

Router settings

- **We recommend enabling the router's DHCP server function (setting for automatically assigning IP addresses). Normally it is enabled, so there is no need to change it.**
- Depending on the security settings of the router, etc., it may not be possible for the CHR-F103 to connect to the Internet.
- Also refer to the router's operating instructions.

CHR-F103 settings

- **If the router's DHCP server function is enabled, the CHR-F103 can be used as is with the settings already made upon purchase.**
- Depending on the router's settings, it may be necessary to change the CHR-F103's settings (🔧 page 16) (to assign a fixed IP address and connect to the network, etc.).

Others

- When the contract with your provider is of the type by which the network settings are made manually, you must make the "Network-related settings".
- The CHR-F103 is not compatible with PPPoE. If your contract is of the PPPoE setting type, you need a PPPoE-compatible router.
- For some ISPs (Internet Service Providers), you may have to make proxy server settings in order to use the Internet radio function. If proxy server settings for connecting to the Internet have been made on the computer, make the same settings on the CHR-F103.
- The CHR-F103 is designed to make the network settings automatically using the DHCP and Auto IP functions.

NOTE:

- Sophisticated knowledge of networks is required to make router security settings.
Make the security settings at your own discretion. DENON will accept no responsibility for any problems arising due to security settings. Furthermore, DENON will not respond to inquiries on the settings and operation of the various devices.

Operation

Operation

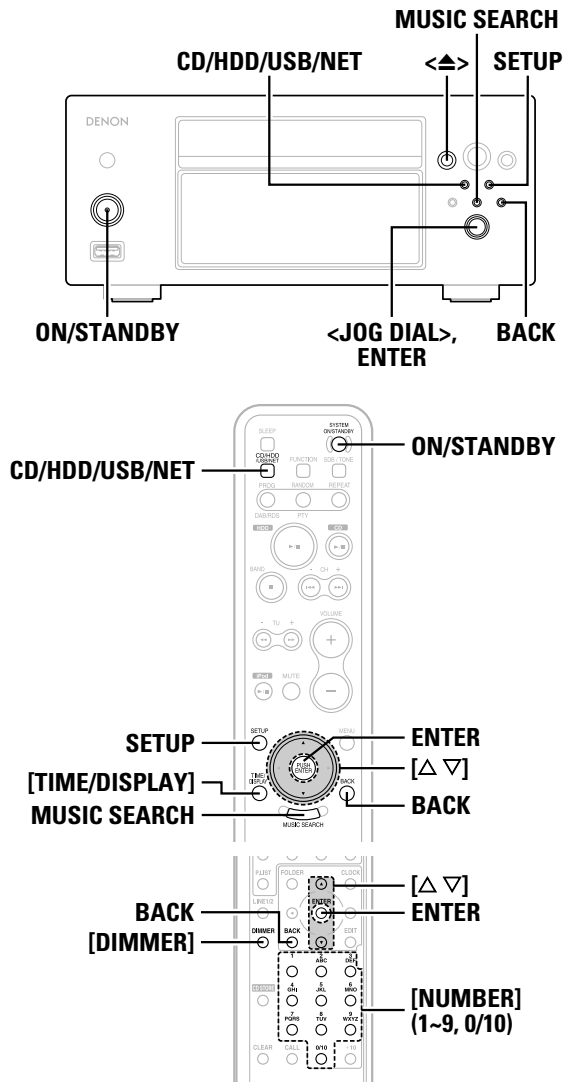

Before operating

Turning the power on

Press ON/STANDBY.

- When the power turns on, the power indicator lights green.

Turning the power off (to the standby mode):

Press <ON/STANDBY> again.

- The power indicator lights red while switching to the standby mode.
- The power indicator turns off once the standby mode is set.

NOTE:

- When in the standby mode, a very small amount of power is consumed, even if all the indicators are turned off.

Selecting the function

With the CHR-F103, it is possible to switch playback between three sources: music discs, the HDD and an external source (USB audio, network audio, etc.).

1 Press CD/HDD/USB/NET to select the function of the source to be played.

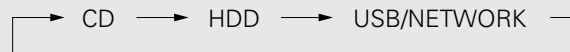

2 Playback of the selected function starts.

- ※ Listening to CD (page 23)
- ※ Listening to HDD (page 22)
- ※ Listening to USB/NETWORK (page 26 ~ 29)

Loading discs

1 Press <▲> to open the disc tray.

2 Load a disc.

- When a CD is loaded, the album name, track name, etc., are displayed automatically (page 23).



- If there are multiple data entries in the Gracenote® database corresponding to that CD, "Select CD Info" is displayed. Use <JOG DIAL> or [Δ ▽] to select the entry to be display, then press ENTER.
- To change the displayed information, stop playback and press BACK.

NOTE:

- Playback of discs not conforming to CD standards (CDs with copy control, for example), is not guaranteed.
- Do not press the disc tray in by hand when the power is turned off. Doing so could damage the set.
- Do not insert foreign objects into the disc tray. Doing so could damage the set.

About the button names in this explanation

- < > : Buttons on the main unit
- [] : Buttons on the remote control unit

Button name only :

Buttons on the main unit and remote control unit

Switching the display

To change the number of lines displayed:

Press **[TIME/DISPLAY]** while in the stop mode.

3-line display ↔ 6-line display

- ※ The display is set to 3 lines upon purchase.
- ※ Kanji can only be displayed in the 3-line display mode.

Changing the displayed contents

(**CD** **HDD** **USB/NET**):

Press **[TIME/DISPLAY]** during playback.

- ※ The display switches as follows each time **[TIME/DISPLAY]** is pressed:

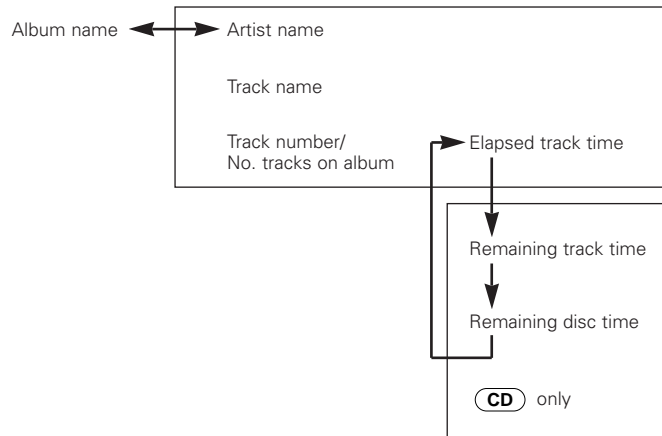

Dimmer function

The brightness of the display can be changed.

The brightness of the display switches as follows each time **[DIMMER]** is pressed:



Setup

The following settings can be made:

- Recording mode setting (Store Setting)
- Network settings (Network Setting)
- Others (Others)

Setting operations

Use the procedure described below to make the settings using the setup menu.

1 Press **SETUP**.

- “Setup Menu” is displayed.

2 Use **<JOG DIAL>** or **[Δ ∇]** to select the setting menu, then press **ENTER** to set.

3 For settings at which you input numbers: Use **[NUMBER]** (1 ~ 9, 0/10) to input all the places, then press **ENTER** to set.

- ※ When a button is pressed, the cursor moves automatically to the next input position.

4 Press **SETUP**.

- The setting mode is quit.

- ※ At the different items, either select “Exit” and press **ENTER** or press **BACK** to return to the setting menu one step before.
- ※ To return all the setup data to the defaults set upon purchase, in the standby mode, press **ON/STANDBY** while pressing in **MUSIC SEARCH**.

Making the recording mode settings (Store Setting)

The following settings can be made:

- Recording sound quality setting (Store Mode)
- Recording monitor auto play setting (Store Monitor)

Setting the recording sound quality (Store Mode)

Use this procedure to set the quality of the sound recorded on the HDD.

- Upon purchase this is set to “HQ”.

1 From the “Store Setting” mode, select “Store Mode” then press **ENTER**.

2 Use **<JOG DIAL>** or **[Δ ∇]** to select.

LPCM (Linear PCM):

Up to about 900 tracks can be recorded.

HQ (High Quality):

WMA (Windows Media Audio 44.1 kHz/192 kbps)

Up to about 7,000 tracks can be recorded.

Normal:

WMA (Windows Media Audio 44.1 kHz/128 kbps)

Up to about 10,000 tracks can be recorded.

- ※ The sound quality increases in the order Normal → HQ → LPCM, but the higher the sound quality, the fewer the number of tracks that can be recorded.

3 Press **ENTER**.

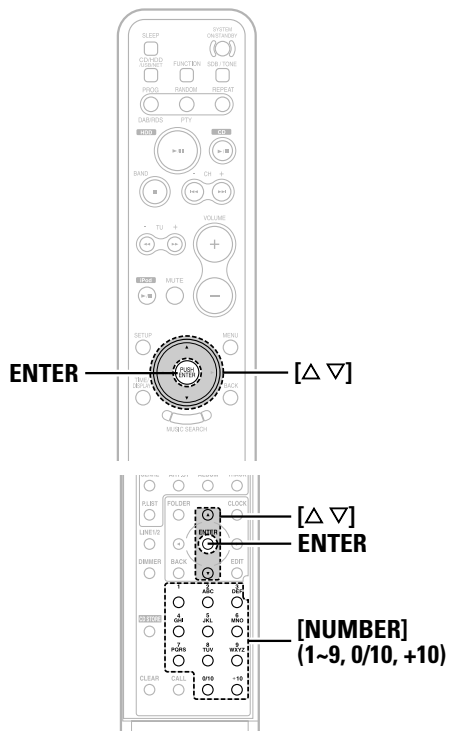
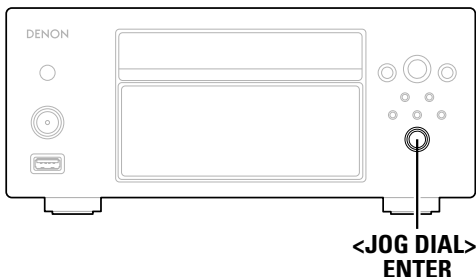

About the button names in this explanation

- < > : Buttons on the main unit
- [] : Buttons on the remote control unit

Button name only :

Buttons on the main unit and remote control unit

Recording monitor auto playback setting (Store Monitor)

- Upon purchase this is set to “On”.

1 From the “Store Setting” mode, select “Store Monitor” then press **ENTER**.

2 Use <JOG DIAL> or [Δ ▽] to select.

On:

The sound being recorded is automatically monitored (played).

Off:

The sound being recorded is not automatically monitored (played).

3 Press **ENTER**.

Making the network settings (Network Setting)

The following settings can be made:

- IP address setting (IP Address)
- Proxy setting (Proxy)
- Internet radio setting (Internet Radio)

Making the IP address settings (IP Address)

Automatic setting of the IP address

When the router’s DHCP server function is enabled (setting for automatically assigning IP addresses), the CHR-F103 can be used as set upon purchase (“On” – DHCP server enabled).

Manual setting of the IP address

If the router does not have a DHCP server function or it is disabled and a fixed IP address must be set, make the setting described below.

※ For the IP address and other information, contact your ISP (Internet service provider).

1 From the “Network Setting” mode, select “IP Address” then press **ENTER**.

2 Select “DHCP” then press **ENTER**.

3 Select “Off” then press **ENTER**.
• The manual setting mode is set.

4 Use <JOG DIAL> or [Δ ▽] to select the next setting item, then press **ENTER**.

- IP Address
- Subnet Mask
- Gateway
- Primary DNS
- Secondary DNS

5 Use [NUMBER] (1 ~ 9, 0/10) to input all the places, then press **ENTER**.

6 Repeat steps **4** and **5** to set all the items.

Making the proxy settings (Proxy)

When the ISP specifies the proxy setting

If no proxy setting is specified, there is no need to make the setting.

1 From the “Network Setting” mode, select “Proxy” then press **ENTER**.

2 Select “Proxy” then press **ENTER**.

3 Select “On” then press **ENTER**.

Setting the proxy by address or name

4 Select “Proxy (Address)” or “Proxy (Name)” then press **ENTER**.

5 Select “Address” or “Name” according to the proxy type specified by the ISP, then press **ENTER**.

6 Use [NUMBER] (1 ~ 9, 0/10, +10) to input the address (numbers) or name (letters), then press **ENTER** once all the places have been input.

When the ISP has specified the port setting

7 Select “Port” then press **ENTER**.

8 Use [NUMBER] (1 ~ 9, 0/10) to input all the places, then press **ENTER**.

Making the Internet radio settings (Internet Radio)

Updating the list of Internet radio stations (☞ page 28)

Making other settings (Others)

The following settings can be made:

- PC applications (PC Connect Mode)
- HDD information (HDD Info)
- Display character setting (Character)
- Setting of the input language used on the computer for the music server (PC Language)
- CDDB update (CDDB Update)

PC applications (PC Connect Mode)

☞ page 34

HDD information (HDD Info)

The HDD's usage conditions are displayed.

From the “Others” mode, select “HDD Info” then press **ENTER**.

Stored Tracks XXXXX:

The number of tracks recorded on the HDD is displayed.

Free Space XX %:

The HDD's free space (%) is displayed.

※ XX indicates numbers.

Setting the display characters (Character)

Use this procedure to set the MP3 ID3-Tag character code type played with the USB input.

- Upon purchase this is set to “Auto”.

1 From the “Others” mode, select “Character Set” then press **ENTER**.

2 Use <JOG DIAL> or [△ ▽] to select.

Auto:

The character code type is selected automatically.

Latin:

ISO 8859-1 Latin-1 is selected.

Japanese:

Shift JIS is selected.

3 Press **ENTER**.

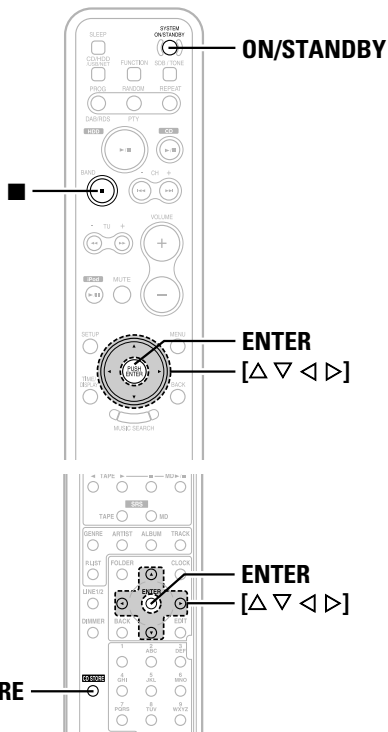
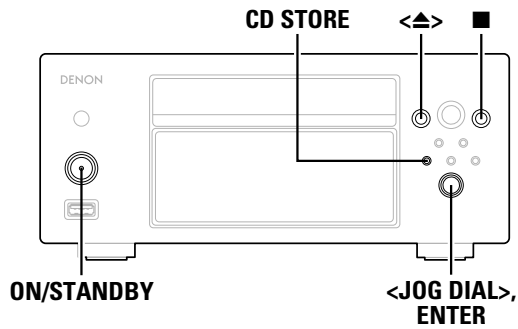

Inputting the computer's language (PC Language)

If you wish to display the character data from the computer used as the music server in English, use this procedure to input the language used on the computer. Normally the characters are displayed in the same language as used on the computer so there is no need to change this setting. Only change it if the character data from the computer is not displayed properly on the CHR-F103.

- 1 From the "Others" mode, select "PC Language" then press ENTER.
- 2 Use <JOG DIAL> or [Δ ∇] to select.
- 3 Press ENTER.

Updating the CDDB (CDDB Update)

- Use this procedure to update the Gracenote® database (CDDB) stored in the CHR-F103.
- An update disc (available for a charge) is required for this update. For details, contact a DENON customer inquiry center.

- 1 From the "Others" mode, select "CDDB Update" then press ENTER.
- 2 From the "CDDB Update" mode, use [Δ ∇] to select "Yes", then press ENTER.
 - The disc tray opens.
- 3 Load the update disc.
 - The tray closes and updating of the CDDB data begins. ("Updating the Gracenote Database..." flashes.)
 - Once updating is completed, "Complete" is displayed and the disc tray opens.
- 4 Remove the update disc, press <▲> to close the tray, then press ON/STANDBY to turn off the power.
 - Updating is completed.

About the button names in this explanation

- < > : Buttons on the main unit
- [] : Buttons on the remote control unit

Button name only :

Buttons on the main unit and remote control unit

Recording and Deleting

Before recording

Sources that can be recorded

CDDA (Music CDs)

NOTE:

- CD-R/CD-RW sources containing music files in such formats as MP3 and WMA cannot be recorded.
- Copyright protected tracks cannot be recorded.

Setting the recording mode

Recording sound quality setting (🔧 page 16)

Recording

Recording CDs

CD

1 Load the CD.

2 Press CD STORE.

※ Select this to record all the tracks or only specific tracks.

3 Use <JOG DIAL> or [△ ▽] to select “All Track” (to record all the tracks) or “Select Track” (to record selected tracks).

4 When “Select Track” is selected:

- ① Press **ENTER** or **CD STORE**.
- ② Use <JOG DIAL> or [△ ▽] to select a track to be recorded, then press **ENTER** to add a “ ✓ ” mark.
- ③ Once the tracks have been selected, press **CD STORE**.

• Recording starts.

4 When “All Track” is selected:

- ① Press **ENTER** or **CD STORE**.

• Recording starts.

※ The recording progress is displayed (“Storing 00%”).

※ Recording is performed at approximately 12 times the normal speed when the file type is set to “LPCM”, approximately 4 times the normal speed otherwise.

※ The stop mode is set automatically once recording is completed.

※ If an error arises during recording and normal recording is not possible, that track is skipped and recording continues. In this case, “Storing Completed - Some Tracks Aborted” is displayed once recording is completed.

To stop recording
Press **■**, use <JOG DIAL> or [◀ ▶] to select “Y”, then press **ENTER**.

- If the CD has already been recorded, “Already Stored - Start Storing?” is displayed.
- The HDD, USB audio and network audio sound can be played while a CD is being recorded. (The function can be switched and the normal playback operations can be performed.)
- When the remaining free space on the HDD is low, “Remaining Capacity Low” is displayed. Delete any unnecessary files to free space.

NOTE:

- The tracks being recording will not be stored if the power cord is unplugged during recording.

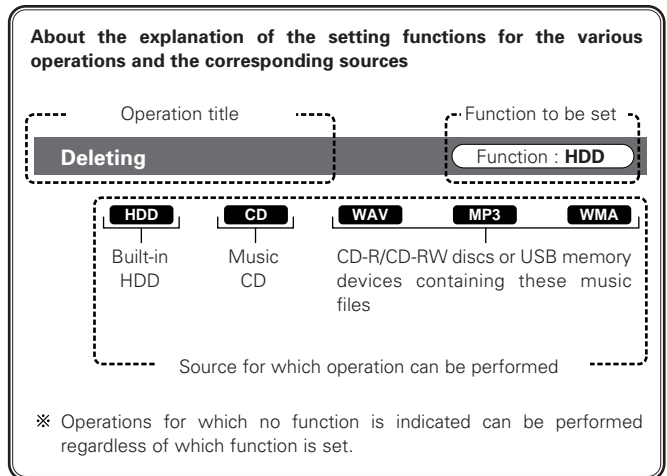

Recording and Deleting

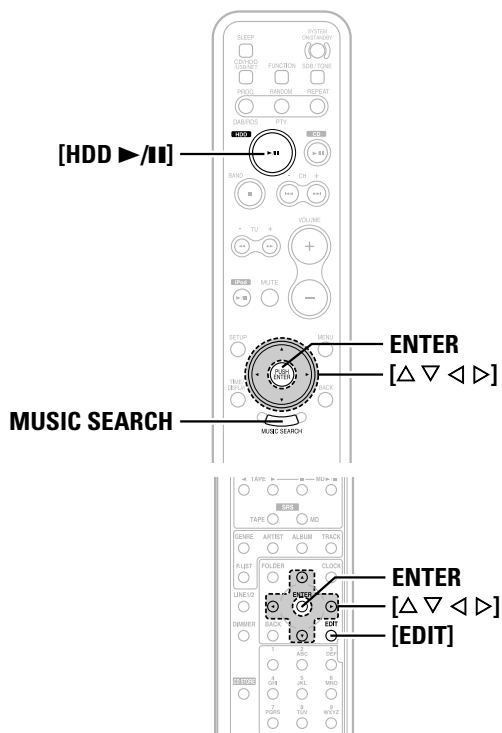
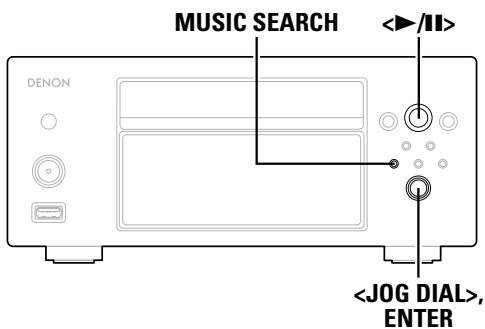

About the button names in this explanation

< > : Buttons on the main unit
[] : Buttons on the remote control unit

Button name only :
Buttons on the main unit and remote control unit

Monitoring the tracks being recorded

Use this procedure to listen to the tracks being recorded.
Stop playback of other sources.

- When “Recording monitor auto playback setting” (page 16) is set to “On”**
A while after recording starts, the function switches to HDD and playback of the recorded track starts.

- When “Recording monitor auto playback setting” (page 16) is set to “Off”**

- 1 Press MUSIC SEARCH.**
 - 2 Use <JOG DIAL> or [Δ ∇] to select “Store Monitor”, then press ENTER.**
• The recorded track is displayed during recording.
 - 3 Use <JOG DIAL> or [Δ ∇] to select the track to be monitored, then press <>, [HDD > / ||] or ENTER.**
• Recording monitoring starts.
- ※ With the monitor function, the sound actually recorded is played. Directly after recording starts, monitor playback only begins after enough data for monitoring has been recorded on the HDD.



- The repeat and random play modes are canceled when monitor playback starts.

Deleting Function : HDD

Use this procedure to delete tracks you no longer need.

NOTE:

- Once tracks are deleted, they cannot be retrieved. Check carefully before deleting.

Deleting single tracks Function : HDD

- 1 In the stop mode, press MUSIC SEARCH.**
• The search menu is displayed.
- 2 Use <JOG DIAL> or [Δ ∇] to select “Tracks”, then press ENTER.**
- 3 Select the track to be deleted, then press [EDIT].**
- 4 Use <JOG DIAL> or [Δ ∇] to select “Track Erase”, then press ENTER.**
- 5 Use <JOG DIAL> or [◀ ▶] to select “Y”, then press ENTER.**
• “Complete” is displayed once the track is deleted.

Deleting tracks by album or artist nameFunction : **HDD**

Use this procedure to delete multiple tracks by album or artist name.

1 In the stop mode, press MUSIC SEARCH.

- The search menu is displayed.

2 Use <JOG DIAL> or [Δ ∇] to select the album or artist name to be deleted, then press [EDIT].**3 Use <JOG DIAL> or [Δ ∇] to select “Album Erase” or “Artist Erase”, then press ENTER.****4 Use <JOG DIAL> or [\triangleleft \triangleright] to select “Y”, then press ENTER.**

- “Complete” is displayed once the track is deleted.



- If deleted tracks were included on playlists, they are removed from the playlists.
- Some time may be required for the deleting procedure, depending on how many tracks are to be deleted.

Deleting all tracksFunction : **HDD**

All the tracks on the HDD are erased at once.

1 In the stop mode, press MUSIC SEARCH.

- The search menu is displayed.

2 Select “Artists”, “Albums”, “Tracks” or “Genres” then press [EDIT].

- “All Erase” is displayed.

3 Press ENTER.

- “All Erase?” is displayed.

4 Use <JOG DIAL> or [\triangleleft \triangleright] to select “Y”, then press ENTER.

- “Really?” is displayed.

5 Use <JOG DIAL> or [\triangleleft \triangleright] to select “Y”, then press ENTER.

- During the deleting procedure, “Process in Progress...” flashes on the display.
- Several minutes may be required for the tracks to be deleted.
- Once the track is deleted, “Complete” is displayed, then “No Track” is displayed.

Playback

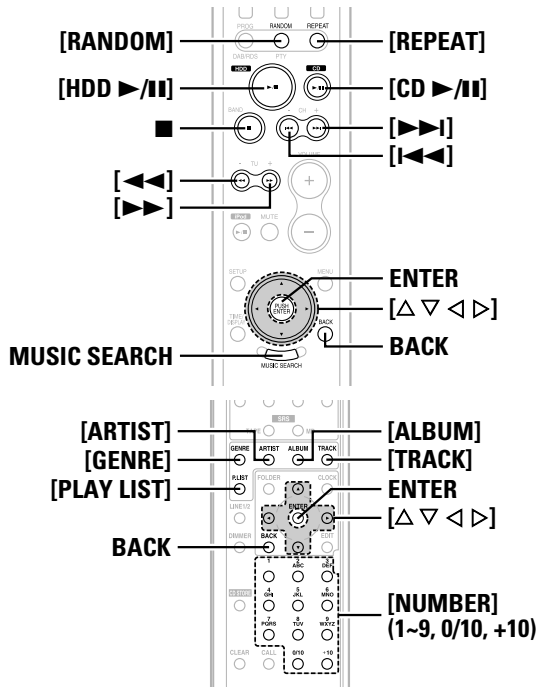
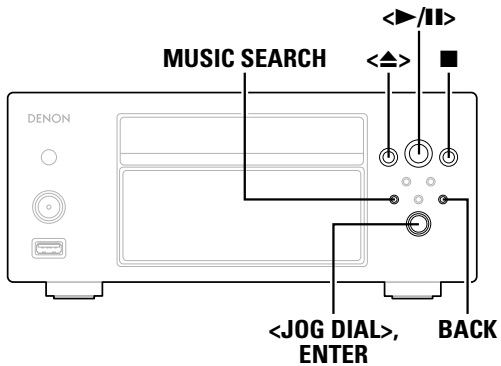

About the button names in this explanation
 < > : Buttons on the main unit
 [] : Buttons on the remote control unit
Button name only :
 Buttons on the main unit and remote control unit

Playing tracks on the HDD Function : HDD

Tracks stored on the HDD are sorted by genre, artist and album. They can also be grouped into playlists. These categories can be used to quickly find the tracks you want to hear.

- Narrow-in search menu**
 Use this procedure to search by narrowing in on the desired track in the following order:

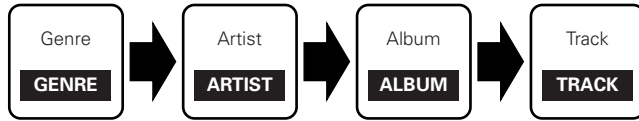

- Favorites search menu**
 - Recently listened to tracks
 Recently Played
 Maximum 256 tracks : Stored automatically
 - Recently recorded CDs
 Recently Stored
 Maximum 20 : Stored automatically
 - Playlist
 Playlist
 Maximum 20 lists : Maximum 256 tracks per list

- The names of playlists can be changed as desired (page 30).

Searching for and playing tracks on the HDD Function : HDD

- 1 Press MUSIC SEARCH.**
 - The search menu is displayed.
- 2 Use <JOG DIAL> or [Δ ∇] to select the search menu, then press ENTER.**
 - Playlists:**
To search among playlists.
 - Artists:**
To search by artist.
 - Albums:**
To search by album name.
 - Tracks:**
To search by track name.
 - Genres:**
To search by genre.

※ You can also display the search menus by pressing [PLAY LIST], [ARTIST], [ALBUM], [TRACK] or [GENRE].
- 3 Press <▶/II> or [HDD ▶/II].**
 - The selected track or all the tracks on the menu are played.

- Stopping playback:**
Press ■.
- Resuming from the point at which playback was last stopped:**
In the stop mode, press <▶/II> or [HDD ▶/II].

NOTE:
 • After recording or editing, it is not possible to listen from the point at which the stop mode was last set.

Handy functions for searching from lists:

- ① Searching by switching between first letters
Use [**<**] [**>**] to switch the first letter (A ⇔ B ⇔ C...).
 - ② Searching by narrowing in on letters
Use [**NUMBER**] (1 ~ 9, 0/10, +10) to input the first letter of the desired title, then the second letter, etc.,
 - The titles are narrowed in each time a letter is input.
- Press [**RANDOM**] or [**REPEAT**] after selecting the desired menu (genre, artist, album, etc.) to play the tracks on that menu in random order or repeatedly.

CD playback Function : CD

Playing CDs Function : CD

1 Press <▲> to open the tray and load the CD.

- ※ Loading the CD : (page 4)
- ※ When the tray closes, the CD's information is searched automatically and the album and track names are displayed (page 14).

CD	o	Accessing Gracenote Database
----	---	------------------------------------

CD	o	⊙	THE BEST HIT	1/18
TRACK	▶	▶	SONG_A	
		▶	SONG_B	

- ※ If the corresponding CD information cannot be found

CD	o	⊙	(Unknown)	1/15
TRACK	▶	▶	TR01	
		▶	TR02	

2 Use <JOG DIAL>, [I-◀▶I**] or [**△ ▽**] to select the track to be played.**

3 Press <▶/II>, [CD ▶/II**] or ENTER.**

CD	▶	o	●	Artist A	
			♪	SONG_A	
			3/18		0:06

Stopping playback:

Press **■**.

Stopping playback temporarily:

During playback, press <▶/II> or [**CD ▶/II**].

※ To resume playback, press <▶/II> or [**CD ▶/II**] again.

To fast-forward or fast-reverse (search):

During playback, press and hold [**▶▶▶**] or [**◀◀◀**].



- Normal playback resumes when the button is released.
- When the searching operation is started while in the pause mode, searching is performed at high speed.

Cueing (moving to the beginning of tracks):

During playback, use <JOG DIAL> or [**I-◀▶I**] to select the track to be cued.



- During playback, press **BACK** to display the track name list.

Direct search:

- Press [**NUMBER**] (1 ~ 9, 0/10, +10).

Example: 4th track : [**4**]

Example: 12th track : [**+ 10**] [**2**]

Example: 20th track : [**+ 10**] [**0/10**]

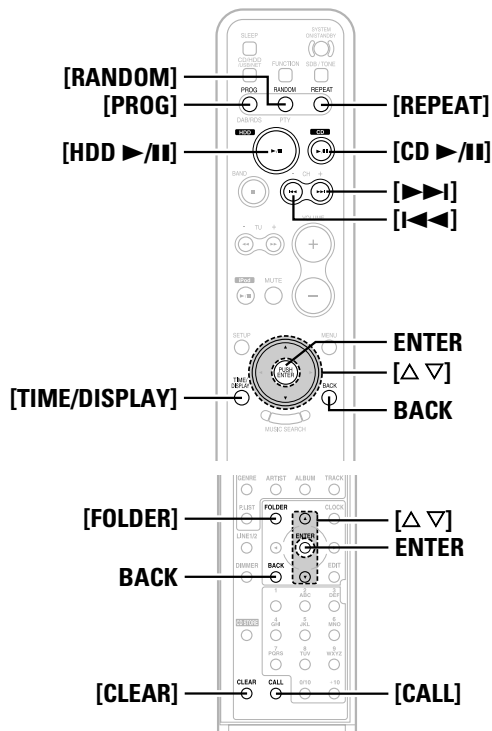
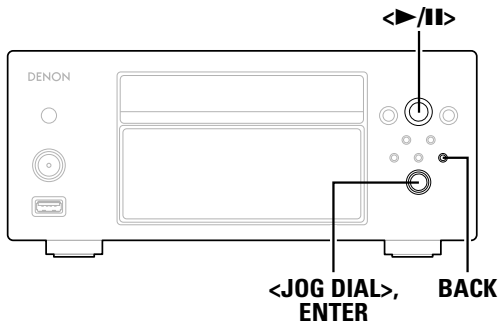

About the button names in this explanation

< > : Buttons on the main unit
 [] : Buttons on the remote control unit
Button name only :
 Buttons on the main unit and remote control unit

Playing music files

Function : **CD**

MP3 **WMA**

Before playing MP3 or WMA files

There are many music distribution sites on the Internet from which you can download files in MP3 or WMA (Windows Media Audio) format. Music (files) downloaded from these sites can be played on the CHR-F103 if they have been burned onto CD-R/CD-RW discs.



The WMA logo, Windows Media and the Windows logo are registered trademarks or trademarks in the United States and other countries of Microsoft Corporation of the United States.

Creating MP3 or WMA discs (CD-R/CD-RW discs) compatible with the CHR-F103

- When recording MP3 or WMA files onto CD-R/CD-RW discs, set the writing software's format to "ISO9660 level 1". Files recorded in other formats may not play properly.
- When burning MP3 or WMA files onto CD-R/CD-RW discs, avoid using a folder hierarchy with more than 8 levels. Files and folders from folder level 9 or lower cannot be played.
- The maximum number of files and folders that can be played is 1,000 (total for the number of files and folders). The maximum number of folders is 255.
- The CHR-F103 is not compatible with packet write software or playlists.
- Also read the operating instructions of the software used to create the MP3 or WMA files.
- Be sure to give the extension ".MP3" or ".WMA" to MP3 or WMA files. The files cannot be played if they have any other extensions. (For Macintosh computers, MP3 files can be played by giving the files the extension ".MP3" after a file name consisting of no more than 8 capital letters or numbers before storing them on the CD-R/CD-RW disc.)

* Your recordings may be used for your personal enjoyment only, and may not be used for other purposes without the consent of the copyright holder as per copyright laws.

Playable MP3 and WMA files

File format	Sampling frequency (kHz)	Bit rate (kbps)	Extension
MP3	32, 44.1, 48	32 ~ 320	.MP3
WMA	32, 44.1, 48	64 ~ 192	.WMA

- The CHR-F103 is compatible with "MPEG-1 Audio Layer-3" standards. It is not compatible with "MPEG-2 Audio Layer-3", "MPEG-2.5 Audio Layer-3", "MP1" or "MP2" standards, etc.
- The CHR-F103 is compatible with MP3 ID3-Tag standards up to Version 2.3.
- The CHR-F103 is compatible with WMA META tags for title, artist and album names.

Settings for folders and files to be played

(folder mode/disc mode):
 Use [FOLDER] to switch.

Folder mode

The "FOLDER" indicator is lit.
 The files in the selected folder and the folders underneath it are played.

Disc mode (folder mode: off):

The "FOLDER" indicator is off.
 The entire disc from the position of the selected file is played.

Playing files

Function : CD

MP3

WMA

1 Set a CD-R/CD-RW disc containing music files in MP3 or WMA format in the disc tray (🔑 page 4).

2 Use <JOG DIAL> or [△ ▽] to select the folder or file.

3 Press <▶/II>, [CD ▶/II] or ENTER.
• The track or file name is displayed and playback starts.

- ※ The track name, artist name and album name are only displayed if they are recorded on the disc.
- ※ The folder name and file name are displayed if the track name, artist name and album name are not recorded on the disc.
- ※ Use [TIME/DISPLAY] to switch the contents displayed on the first line.

To change the folder or file during playback:

Press **BACK** to display the list, then use [△ ▽] or [◀▶▶▶] to select the folder or file.



- When a copyright-protected file or a file that cannot be played properly is selected, "Can't Play" is displayed. Select a different file.

NOTE:

- Programmed playback is not possible with discs containing files in MP3 or WMA format.
- The time may not be displayed properly if the search or pause operation is performed while playing files recorded with a variable bit rate.

Special playback features

Playing programs

Function : CD

CD

Up to 25 tracks can be programmed.

1 Press [PROG].
• "PROG" is displayed.

2 Use <JOG DIAL> or [△ ▽] to select the name of the track to be programmed, then press ENTER.
• The number in the program is displayed to the left of the track name.

- ※ Repeat this operation until you have programmed all the desired tracks.

3 Press <▶/II> or [CD ▶/II].
• The tracks are played in the programmed order.

Checking the order of the programmed tracks:

- In the stop mode, press [CALL].
- The track names are displayed in the programmed order.

Clearing programmed tracks:

- Press [CLEAR].
- The program at the position of the cursor is cleared.

Stopping programmed playback:

- In the stop mode, press [PROG].

NOTE:

- The program is cleared if the disc tray is opened.

Playing in random order

Function : HDD or CD

HDD

CD

MP3

WMA

1 In the stop mode, press [RANDOM].
• "RANDOM" is displayed.

2 Press [HDD ▶/II], [CD ▶/II] or <▶/II>.

Stopping random playback:

- In the stop mode, press [RANDOM].
- The "RANDOM" indicator is off.



- When the function is set to **HDD**, random playback is possible by genre, artist, or album.
- If [REPEAT] is pressed during random playback, the tracks are played once in a random order, then played again in a different random order.
- The files played randomly differ according to the music file playback mode.
 - In the folder mode: Files in selected folder and folders underneath it
 - In the disc mode: All the files on the disc

NOTE:

- When the random mode is set during programmed playback, the program is cleared.
- When the random mode is set in the single track repeat mode, the mode switches to all-track repeat.

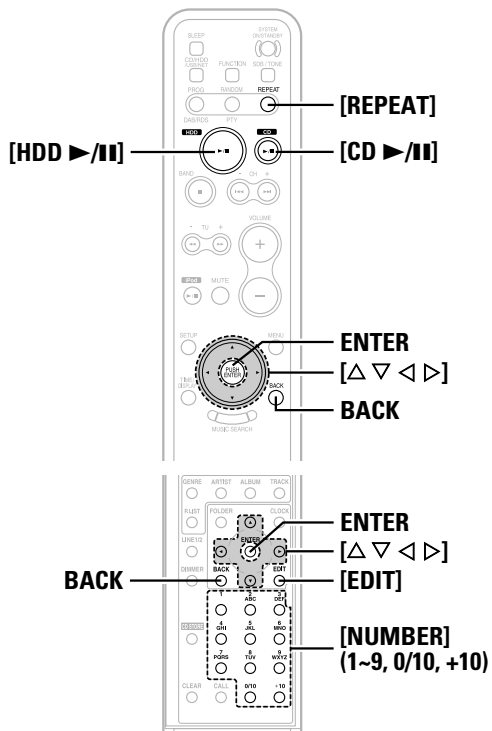
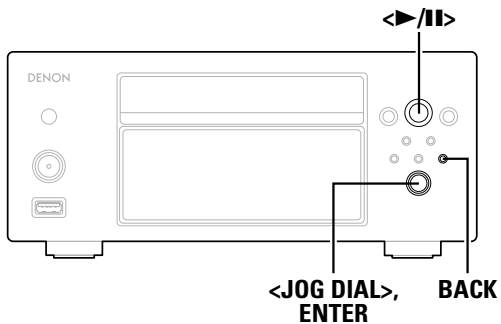

About the button names in this explanation
 < > : Buttons on the main unit
 [] : Buttons on the remote control unit
Button name only :
 Buttons on the main unit and remote control unit

Playing tracks (files) repeatedly
 Function : **HDD or CD**

HDD CD MP3 WMA

During the stop or play mode, use [REPEAT] to select the repeat mode.

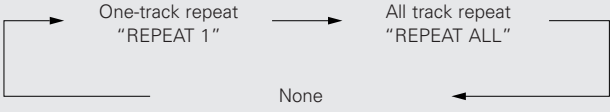

※ In the stop mode, press [HDD >/II], [CD >/II] or <>/II to start playback.

Stopping repeat play
 In the stop mode, press [REPEAT] until the "REPEAT" indicator turns off.

- In the **HDD** mode it is possible to set repeat play by genre, artist or album.
- The files played repeatedly depend on the music file playback mode.
 - In the folder mode: Files in selected folder and folders underneath it
 - In the disc mode: All files on the disc

Listening to Internet radio
 Function : **USB/NET**

Connections to the required system and specific settings must be made in order to listen to Internet radio (page 12, 16). When you first connect to an Internet radio station, "Update?" appears on the display.

- 1 Set the input source to "USB/NET".**
 - The Network Audio screen appears.
- 2 Use <JOG DIAL> or [Δ ▽] to select "Internet Radio", then press ENTER.**
 - The initial screen when not connected to the Internet appears.
- 3 Connecting to an Internet radio station for the first time: Press ENTER.**
 - The update screen appears.
- 4 Press ENTER.**
 - The most recent list of radio stations is downloaded from the vTuner website (several minutes are required for the download).
- 5 Use <JOG DIAL> or [Δ ▽] to select the desired item, then press ENTER.**



※ At the end, the station list is displayed.

- 6 Use <JOG DIAL> or [Δ ▽] to select the desired station, then press ENTER or [▷].**
 - Connection starts, and playback begins once the buffer reaches "100%".
 - The pause mode is set if [▷] is pressed during playback, and playback resumes when [▷] is pressed again.
 - Press **BACK** in the play or pause mode to display the previous menu screen.



- There are many Internet radio stations on the Internet, and the quality of the programs they broadcast as well as the bit rate of the tracks varies widely. Generally, the higher the bit rate, the higher the sound quality, but depending on the communications lines and the server's traffic, streamed music or sound with a high bit rate can easily be fragmentary. Inversely, a lower bit rate means lower sound quality, but less tendency to break up.
- "Radio Station Server Full" or "Connection Down" is displayed if the station is busy or not broadcasting.

Registering Internet radio stations as your favorites

Function : **USB/NET**

Favorites are listed at the top of the menu screen, so when they are registered they can be tuned in easily.

1 Press [EDIT] while the Internet radio station you want to register is playing.

- The registration menu screen appears.



2 Use <JOG DIAL> or [Δ ▽] to select "Favorites", then press ENTER.

- The favorites registration menu screen appears.

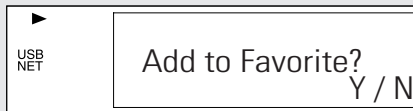

3 Use <JOG DIAL> or [◀ ▶] to select "Y", then press ENTER.

Presetting (registering) Internet radio stations

Function : **USB/NET**

There are two ways to register stations, by presetting them or by storing them in your favorites. When preset, stations can be tuned in directly with the remote control unit.

1 Press [EDIT] while the Internet radio station you want to register is playing.

- The registration menu screen appears.



2 Use <JOG DIAL> or [Δ ▽] to select "Preset", then press ENTER.

- The preset registration menu screen appears.

3 Use [NUMBER] (1 ~ 9, 0/10, +10) to register the station at the desired preset channel.

- This completes the registration procedure.

NOTE:

- Presettings are cleared if a new entry is preset at a preset channel that has already been used.

Listening to preset Internet radio stations

Select the "USB/NET" function, then use [NUMBER] (1 ~ 9, 0/10, +10).

- The station is connected to automatically and playback begins.

Listening to Internet radio stations registered in your favorites

1 Select the "USB/NET" function, use <JOG DIAL> or [Δ ▽] to select "Favorites", then press ENTER.

- The Internet radio stations registered in your favorites are displayed.

2 Use <JOG DIAL> or [Δ ▽] to select the desired station, then press ENTER.

- Playback starts.

Clearing radio stations from your favorites

1 In the stop mode, at the screen displayed in step 2 under "Listening to Internet radio stations registered in your favorites", use <JOG DIAL> or [Δ ▽] to select the radio station you want to clear.

2 Press [EDIT].

- The clear screen appears.



3 Use <JOG DIAL> or [◀ ▶] to select "Y", then press ENTER.

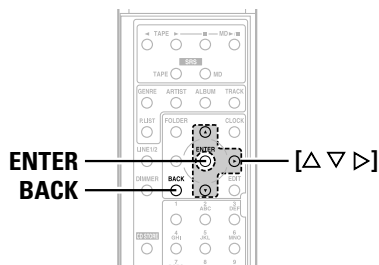
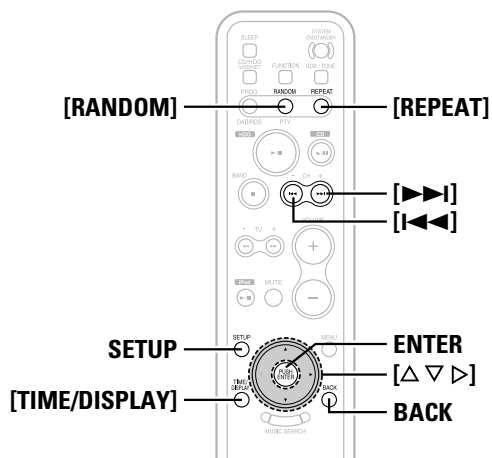
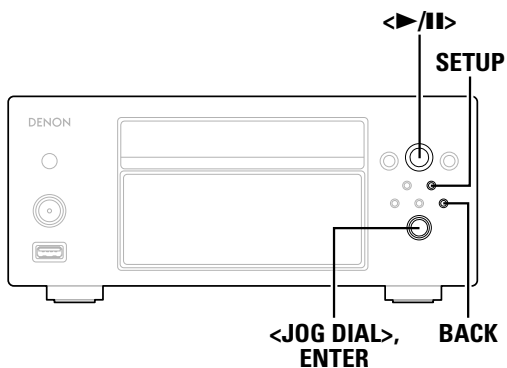

About the button names in this explanation

< > : Buttons on the main unit
 [] : Buttons on the remote control unit

Button name only :

Buttons on the main unit and remote control unit

Updating the list of radio stations

1 Use **SETUP** to select “Network Setting”, then press **ENTER** (☞ page 16).

2 Use **<JOG DIAL>** to select “Internet Radio”, then press **ENTER**.

3 Use **<JOG DIAL>** or **[Δ ∇]** to select “Auto Update” or “Manual Update”, then press **ENTER**.

- The update screen appears.

※ If “Radio List Version” is selected, the current version is displayed.

4 When “Auto Update” is selected:
 Use **<JOG DIAL>** or **[Δ ∇]** to select “ON”, then press **ENTER**.

- The radio station list is updated automatically.

4 When “Manual Update” is selected:
 Use **<JOG DIAL>** to select “Start”, then press **ENTER**.

- The radio station list is updated.

Playing music files stored on a computer (music server)

Function : **USB/NET**

Connections to the required system and specific settings must be made in order to play music files.

Use this procedure to play music files (in WMA, MP3 or WAV format) or playlists (m3u or wpl) stored on a computer (music server) connected to the CHR-F103 via a network.

Before starting, you must launch the computer’s server software and set the files as server contents. For details, see the operating instructions of your server software.

1 Set the input source to “USB/NET”.

- ※ The host names of the computers (music servers) in the network are also displayed.

2 Use **<JOG DIAL>** or **[Δ ∇]** to select the host name of the computer (music server) on which the music files you want to play are located, then press **ENTER**.

3 Use **<JOG DIAL>** or **[Δ ∇]** to select the search item or the desired folder, then press **ENTER**.

- ※ When a folder is selected and **[▷]** is pressed, playback of the files in the folder begins.

4 Use **<JOG DIAL>** or **[Δ ∇]** to select the desired music file, then press **ENTER** or **[▷]**.

- Connection starts, and playback begins once the buffer reaches “100%”.

- ※ Press **[▶▶]** to select the next file, **[◀◀]** to select the previous file.

- ※ The pause mode is set if **[▷]** is pressed during playback, and playback resumes when **[▷]** is pressed again.

- ※ Press **BACK** during playback to display the previous menu screen.

☐ **Playing music files that have been preset or registered in your favorites**

Music files can be preset or registered in your favorites and played using the same procedure as for Internet radio stations.

NOTE:

- Presettings are cleared if a new entry is preset at a preset channel that has already been used.
- When the following operations are performed, the music server's database is updated and it may no longer be possible to play music files that have been preset or registered in your favorites.
 - When the music server is stopped then restarted
 - When music files are deleted or added to the music server

Playback of USB memory devicesFunction : **USB/NET****WAV****MP3****WMA**

This procedure can be used to play music files (in MP3, WMA or WAV format) stored on a USB memory device.

Before playing a USB memory device

- The CHR-F103 can only play USB memory devices compatible with the mass storage class.
- The CHR-F103 is compatible with USB memory devices in "FAT16" or "FAT32" format.
- If the USB memory device is divided into multiple partitions, only the top drive can be selected.

Playable MP3 and WMA files

File format	Sampling frequency (kHz)	Bit rate (kbps)	Extension
MP3	32, 44.1, 48	32 ~ 320	.MP3
WMA	32, 44.1, 48	48 ~ 192	.WMA

- The CHR-F103 is compatible with "MPEG-1 Audio Layer-3" standards. It is not compatible with "MPEG-2 Audio Layer-3", "MPEG-2.5 Audio Layer-3", "MP1" or "MP2" standards, etc.
- The CHR-F103 is compatible with MP3 ID3-Tag (Ver. 2) standards.
- The CHR-F103 is compatible with WMA META tags.
- The CHR-F103 can only play music files that are not copyright protected*.

*: Contents downloaded from pay music sites on the Internet are copyright protected. Tracks ripped on a computer from a CD, etc., and encoded in WMA format may be copyright protected, depending on the computer's settings.

Playing USB memory devices**1 Connect the USB memory device to the USB input terminal.****2 Use <JOG DIAL> to select "USB", then press ENTER.**

- The files and folders stored on the USB memory device are displayed.

※ "USB" is not displayed if no USB memory device is connected.

3 Use <JOG DIAL> or [△ ▽] to select the folder or file you want to play, then press <▶/||> or [▷].

- Playback starts.
- When a file is selected, playback can also be started by pressing **ENTER**.

- ※ The CHR-F103 can display folder and file names like titles. Up to 95 letters and numbers can be displayed. Non-compatible characters are replaced with a "." (period).
- ※ The display can be switched between the artist and album name using **[TIME/DISPLAY]**.

 Repeat mode

The repeat mode switches when **[REPEAT]** is pressed while playing a USB memory device.

 **Random mode**

The random mode is switched on and off each time **[RANDOM]** is pressed.



- When **<▶/||>** is pressed while the USB memory device or folder is selected, playback of all the files on the USB memory device or in the folder begins.

NOTE:

- The audio signals are not output from the digital output terminal.
- DENON will accept no responsibility for any loss of or damage to data on a USB memory device when the USB memory device is being used connected to the CHR-F103.
- USB memory devices will not operate via a USB hub.
- DENON does not guarantee operation or supply of power to all USB memory devices.
- It is not possible to connect a USB cable between to the CHR-F103's USB terminal and a computer and use the units as such.
- The CHR-F103 is not compatible with the iPod shuffle.

Editing

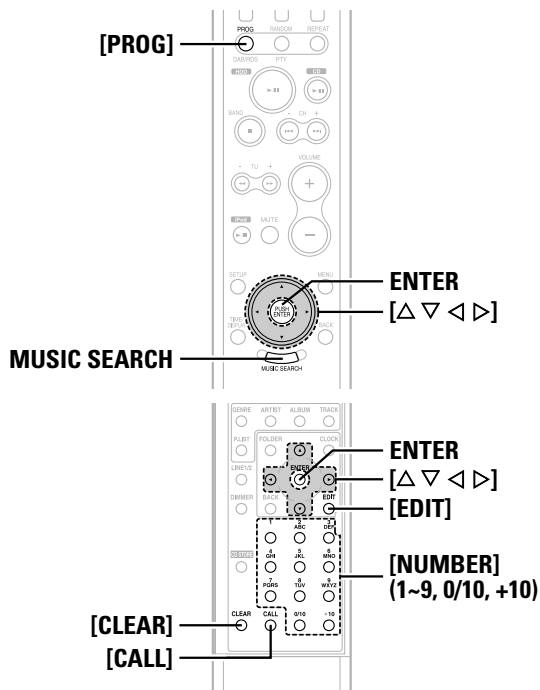
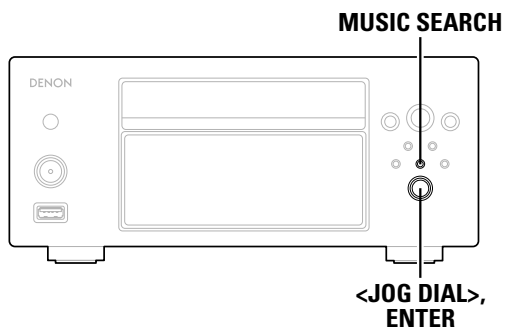

About the button names in this explanation

< > : Buttons on the main unit

[] : Buttons on the remote control unit

Button name only :

Buttons on the main unit and remote control unit

Inputting characters Function : HDD

Letters (capital and small) and numbers can be used to change the artist, album, track, playlist and track genre names.

Changing titles Function : HDD

- 1** In the stop mode, display the title you want to change (☞ page 22).
- 2** Press [EDIT].
- 3** Use <JOG DIAL> or [Δ ∇] to select “Rename”, then press ENTER.
- 4** Use <JOG DIAL> or [Δ ∇] to select the item to be changed, then press ENTER.

Title Rename:	To change the track/file name
Artist Rename:	To change the artist name
Album Rename:	To change the album name
Playlist Rename:	To change the playlist name
Genre Change:	To change the genre name

※ When an artist or album name is selected and the name is changed, all the tracks with that artist or album name are changed as well.

※ When a track is selected and its artist or album name is changed, the artist or album name is only changed for that track.

- 5** To clear one character at a time:
-1 Use [◀ ▶] to set the cursor to the letter to be cleared, then press [CLEAR].

- 5** To clear the entire title:
-2 Press and hold in [CLEAR] for at least 2 seconds.
- 6** Use [CALL] to switch between capital and small letters.
- 7** Use [NUMBER] (1 ~ 9, 0/10, +10) to select the character to be input.
※ A maximum of 114 characters per title can be input.

Characters assigned to the different buttons

[NUMBER]	Capital letter	Small letter
1	1!"#\$%&'()*+,-./	1!"#\$%&'()*+,-./
2	ABC2ÀÁÂÃÄÅÆÇ	abc2àáâãäåæç
3	DEF3ÈÉÊË	def3èéêë
4	GHI4ÌÍÎÏ	ghi4ìíîï
5	JKL5	jkl5
6	MNO6ÑÓÔÕÖØ	mno6ñóôõöø
7	PQRS7ß	pqr7ß
8	TUV8ÚÛÜ	tuv8úûü
9	WXYZ9Ý	wxyz9ýÿ
0/10	0_ (space)	0_ (space)
+10	::;<=>?@[\]^_{ }£	::;<=>?@[\]^_{ }£

- 8** Repeat steps 5 to 7 to input the title.
- 9** Press ENTER to set the characters you have input.

Changing genre names

Function : HDD

- 1** Perform steps **1** to **3** under “Changing titles”.
- 2** Use <JOG DIAL> or [Δ ∇] to select “Genre Change”, then press **ENTER**.
- 3** Use <JOG DIAL> or [Δ ∇] to select the new genre name.
 - ※ Select one of the 25 genre names.
- 4** Press **ENTER** to set the genre name you have chosen.

Creating playlists

Function : HDD

This feature can be used to organize the tracks stored on the HDD in 20 groups consisting of up to 256 tracks each.

- ※ The playlists only consist of data on the track order, etc. They are used to call out the tracks on the HDD in the specified order to play them.
- ※ Clearing a track from a playlist does not delete it from the HDD.

Adding tracks to playlists

- 1** In the stop mode, display the track you want to add (☞ page 22).
- 2** Press **[EDIT]**.
 - ※ **[PROG]** can be used to add the currently playing track to the playlist.
- 3** Use <JOG DIAL> or [Δ ∇] to select “Add to Playlist”, then press **ENTER**.
- 4** Use <JOG DIAL> or [Δ ∇] to select the track to be added to the playlist, then press **ENTER**.
 - The track is added to the end of the playlist, and “Complete” is displayed.

Clearing tracks from playlists

- 1** In the stop mode, select the track you want to clear from the playlist, then press **[EDIT]** (☞ page 22).
- 2** Use <JOG DIAL> or [Δ ∇] to select “Track Clear”, then press **ENTER**.
- 3** Use <JOG DIAL> or [\triangleleft \triangleright] to select “Y”, then press **ENTER**.
 - The track is cleared from the playlist and “Complete” is displayed.

Changing the order of tracks on playlists

- 1** In the stop mode, select the track on the playlist whose order you want to change, then press **[EDIT]** (☞ page 22).
- 2** Use <JOG DIAL> or [Δ ∇] to select “Track Move”, then press **ENTER**.
- 3** Use <JOG DIAL> or [Δ ∇] to select the position to which you want to move the track, then press **ENTER**.
 - The order of the track on the playlist is changed and “Complete” is displayed.

Clearing playlists

- 1** In the stop mode, select the playlist you want to clear, then press **[EDIT]** (☞ page 22).
- 2** Use <JOG DIAL> or [Δ ∇] to select “All Track Clear”, then press **ENTER**.
- 3** Use <JOG DIAL> or [\triangleleft \triangleright] to select “Y”, then press **ENTER**.
 - The playlist is cleared and “Complete” is displayed.

Clearing all the playlists

- 1** In the stop mode, press **MENU SEARCH**.
 - The search menu is displayed.
- 2** Use <JOG DIAL> or [Δ ∇] to select “Playlist”, then press **[EDIT]**.
- 3** Use <JOG DIAL> or [\triangleleft \triangleright] to select “All Playlist Clear”, then press **ENTER**.
 - “All Clear?” is displayed.
- 4** Use <JOG DIAL> or [\triangleleft \triangleright] to select “Y”, then press **ENTER**.
 - All the playlists are cleared and “Complete” is displayed.

NOTE:

- The contents of the “Recently Played” and “Recently Stored” playlists are also cleared.

System Operations

This unit [CHR-F103]

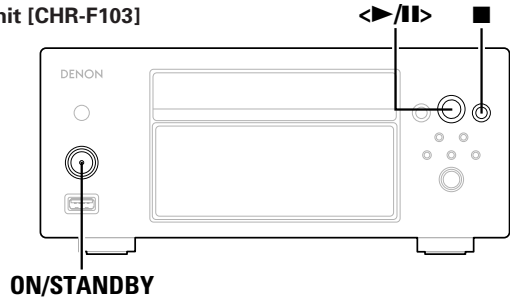

Receiver [DRA-F102/F102DAB]

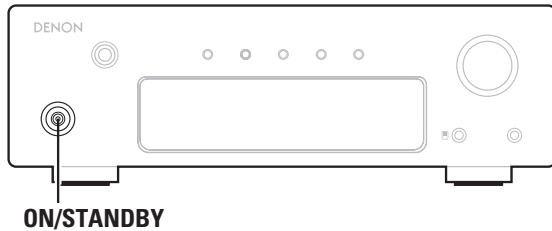

Cassette deck [DRR-F102]

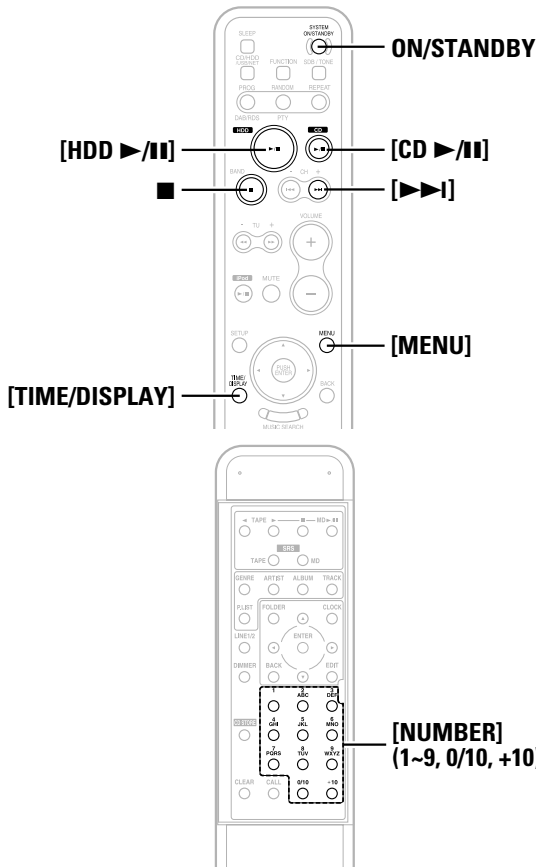
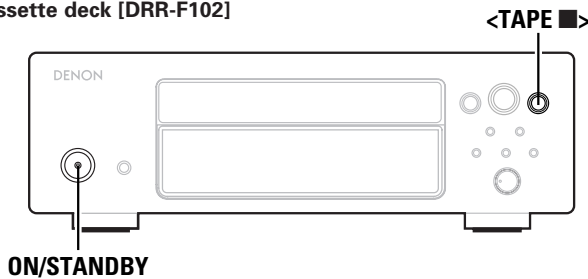

About the button names in this explanation
 < > : Buttons on the main unit
 [] : Buttons on the remote control unit
Button name only :
 Buttons on the main unit and remote control unit

When the CHR-F103 is used in conjunction with other components in the F102 series, such system operations as CD Synchro recording can be performed and the system remote control unit (included with the receiver (DRA-F102/F102DAB)) can be used to operate the various components.



- All of the system operations are controlled from the receiver (DRA-F102/F102DAB).
- Also read the operating instructions of the various components.
- The system remote control unit included with the receiver (DRA-F102/F102DAB) cannot be used to operate the CHR-F103. Use the system remote control unit included with the CHR-F103.

Auto power on function

Press [HDD ▶/⏸] or [CD ▶/⏸] when the power of the various components is set to the standby mode.

- The power of the various components turns on and the receiver's function automatically switches to "CD/HDD".
 - Press [HDD ▶/⏸] to play the hard disc drive, [CD ▶/⏸] to play a CD.
- ※ The auto power on function does not work even when <▶/⏸> is pressed.

Auto function selection

Press <▶/⏸>, [HDD ▶/⏸] or [CD ▶/⏸] during playback on one of the other components.

- Playback stops and the receiver's function automatically switches to "CD/HDD".
- Press <▶/⏸> to play the function currently selected on the CHR-F103, [HDD ▶/⏸] to play the hard disc drive, [CD ▶/⏸] to play a CD.

CD synchronized recordingFunction : **CD**

This function lets you easily record the tracks from a CD onto a cassette tape.

For instructions, see the cassette deck's operating instructions.

Timer playback function

The receiver's timer function can be used to conduct playback at set times.

For operating instructions, refer to the manual included with the receiver.

- Switch the CHR-F103's function to the function you want to play before setting the timer standby mode.

Edit functionFunction : **CD**

This function lets you record onto cassette tapes with automatic editing according to the length of the tape.

※ Load the CD and cassette tape before starting.

1 Turn on the power of the various components.**2 Press [MENU] three times in a row.**

- "EDIT" is displayed on the receiver's display.

3 Use [▶▶] to set the length of the cassette tape.

Example: To record onto a 60-minute cassette tape, use [▶▶] to select "C-60".

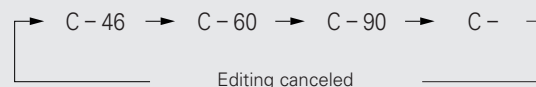

(The length of the cassette tape is the total length for sides A and B.)

- When the cassette tape length is set, the numbers of the tracks and the total playing time for sides A and B respectively are displayed.

CD	Tape Edit	C 46
TRACK	Edit 01-06	A 20:26
	Edit 07-09	B 11:23

4 Press <▶/II> or [CD ▶/II].

- Recording of the CD starts.

Setting a specific cassette tape length:

When "C -" is displayed, use [NUMBER] (1 ~ 9, 0/10, +10) to input the time.

Example: To set to 54 minutes

[+10] [+10] [+10] [+10] [+10] [4]

※ The length can be set to up to 150 minutes.

Canceling the editing function:

Press ■ or <TAPE ■>.

NOTE:

- The editing function does not work with discs containing 26 tracks or more.
- When using the edited recording function, be sure to load the cassette tape with side A facing upwards. The beginning of the cassette tape is found automatically before recording starts.
- When using a tape that is already recorded on, erase the tape before conducting edited recording.
- When using the edited recording function, set the cassette deck's reverse mode to "↶".
- In some cases it may not be possible to record all the tracks on the cassette tape even if its length is longer than the total length of the tracks on the disc, due to the fact that the tracks must be divided between sides A and B. "OVER" is displayed on the CHR-F103's display if there are tracks that cannot be recorded. If "OVER" is displayed, change the length of the cassette tape as described in step 3.
- When the editing function is in use, no buttons other than **ON/STANDBY**, **[MENU]**, **[▶▶]**, **[CD ▶/II]**, **■**, **<TAPE ■>** and **[TIME/DISPLAY]** will operate.
- Edited recording is not possible with discs containing files in MP3 or WMA format.

PC applications

Denon Music Manager function

Denon Music Manager can be used for the operations described below.

- Displaying lists of and editing the tracks on the HDD
- Editing playlists
- Importing music files from a computer
- Backing up the tracks on the HDD onto a computer
- Restoring backed up data onto the CHR-F103

We recommend backing up the data recorded on the CHR-F103's HDD periodically. If the HDD should fail, the recordings you have backed up can be retrieved.

Required recommended equipment and environment for using Denon Music Manager

- Computer on which Windows XP Service Pack 2 is installed
- HDD with sufficient free space
- USB 2.0 connection terminal

NOTE:

- When connecting a computer and the CHR-F103, do not use any software other than Denon Music Manager. Using any software other than Denon Music Manager could destroy the data on the HDD or damage the CHR-F103.

Installing Denon Music Manager

1 Load the included CD-ROM (Denon Music Manager) onto the computer.

- The installation wizard screen appears.

※ If the installation menu screen does not appear, open the CD-ROM drive in "My Computer" and launch "SETUP.EXE".

2 Follow the instructions on the screen and click "Next".

Check the settings for installation, then finally click "Install".

- Installation is executed. A dialog box appears to indicate that installation is finished.

3 Click "Finish".

- This completes installation.

Connecting to a computer

1 Turn on the power of the computer on which Denon Music Manager is installed.

※ Leave the CHR-F103's power off.

2 Once the computer has started up, connect it to the PC CONTROL (USB) terminal on the CHR-F103's rear panel using a commercially available USB cable (sold separately).

3 Turn on the CHR-F103's power.

4 Select "PC Connect Mode" from "Others" on the setup menu, then press ENTER.

5 Select "OK", then press ENTER.

- "PC Connect Mode" is displayed.

6 Double-click the Denon Music Manager icon on the computer to launch Denon Music Manager.

7 Follow the instructions in the operating instructions included on the Denon Music Manager's CD-ROM to perform the operations on the computer (data backup, etc.).

8 Once all operations are completed, turn off the CHR-F103's power.

※ After the power turns off, disconnect the USB cable.

NOTE:

- NEVER disconnect the USB cable or turn off the power of the computer or the CHR-F103 while using Denon Music Manager. Doing so could destroy the data on the HDD or damage the CHR-F103 or the computer.

Others

Trademarks

Music recognition technology and related data are provided by Gracenote®. Gracenote is the industry standard in music recognition technology and related content delivery. For more information visit www.gracenote.com.

CD and music-related data from Gracenote, Inc., copyright© 2000-2006 Gracenote. Gracenote Software, copyright© 2000-2006 Gracenote. This product and service may practice one or more of the following U.S. Patents: #5,987,525; #6,061,680; #6,154,773, #6,161,132, #6,230,192, #6,230,207, #6,240,459, #6,330,593, and other patents issued or pending. Some services supplied under license from Open Globe, Inc. for U.S. Patent: #6,304,523. Gracenote and CDDB are registered trademarks of Gracenote. The Gracenote logo and logotype, and the "Powered by Gracenote" logo are trademarks of Gracenote.



USE OF THIS PRODUCT IMPLIES ACCEPTANCE OF THE TERMS BELOW.

This product contains technology and data from Gracenote of Emeryville, California ("Gracenote"). The technology from Gracenote (the "Gracenote Embedded Software") enables this product to do disc identification and obtain music-related information, including name, artist, track, and title information ("Gracenote Data"), which is included on the Gracenote Database (the "Gracenote Database").

- You agree that you will use Gracenote Data, the Gracenote Database, and Embedded Software for your own personal non-commercial use only.
- You agree that you will access Gracenote Data only by means of the standard end user functions and features of this product.
- You agree not to assign, copy, transfer or transmit the Embedded Software or any Gracenote Data to any third party.
- YOU AGREE NOT TO USE OR EXPLOIT GRACENOTE DATA, THE GRACENOTE DATABASE, OR GRACENOTE COMPONENT, EXCEPT AS EXPRESSLY PERMITTED HEREIN.
- You agree that your non-exclusive license to use the Gracenote Data, the Gracenote Database, and Embedded Software will terminate if you violate these restrictions. If your license terminates, you agree to cease any and all use of the Gracenote Data, the Gracenote Database, and Gracenote Embedded Software.
- Gracenote reserves all rights in the Gracenote Data, Gracenote Database, and Gracenote Embedded Software, including all ownership rights.
- You agree that Gracenote may enforce its rights under this Agreement against you directly in its own name.

The Embedded Software and each item of Gracenote Data are licensed to you "AS IS." Gracenote makes no representations or warranties, express or implied, regarding the accuracy of any Gracenote Data. Gracenote reserves the right to delete data or to change data categories in any Data updates and for any cause that Gracenote deems sufficient.

No warranty is made that the Embedded Software is error-free or that functioning of the Embedded Software will be uninterrupted. Gracenote is not obligated to provide you with any new enhanced or additional data types or categories that Gracenote may choose to provide in the future.

GRACENOTE DISCLAIMS ALL WARRANTIES EXPRESS OR IMPLIED, INCLUDING, BUT NOT LIMITED TO, IMPLIED WARRANTIES OF MERCHANTABILITY, FITNESS FOR A PARTICULAR PURPOSE, TITLE, AND NON-INFRINGEMENT. GRACENOTE DOES NOT WARRANT THE RESULTS THAT WILL BE OBTAINED BY YOUR USE OF THE GRACENOTE COMPONENT OR ANY GRACENOTE SERVER. IN NO CASE WILL GRACENOTE BE LIABLE FOR ANY CONSEQUENTIAL OR INCIDENTAL DAMAGES OR FOR ANY LOST PROFITS OR LOST REVENUES.

"This product is protected by certain intellectual property rights of Microsoft. Use or distribution of such technology outside of this product is prohibited without a license from Microsoft."

"Content owners use Windows Media digital rights management technology (WMDRM) to protect their intellectual property, including copyrights. This device uses WMDRM software to access WMDRM protected content. If the WMDRM software fails to protect the content, content owners may ask Microsoft to revoke the software's ability to use WMDRM to play or copy protected content. Revocation does not affect unprotected content. When you download licenses for protected content, you agree that Microsoft may include a revocation list with the licenses. Content owners may require you to upgrade WMDRM to access their content. If you decline an upgrade, you will not be able to access content that requires the upgrade."

vTuner

This product is protected by certain intellectual property rights of Nothing Else Matters Software and BridgeCo. Use or distribution of such technology outside of this product is prohibited without a license from Nothing Else Matters Software and BridgeCo or an authorized subsidiary.

Troubleshooting

If a problem should arise, first check the following.

1. Are all connections proper ?

2. Have you operated the player according to the Operating Instructions ?

If this unit is not operating properly, check the items listed in the table below. Should the problem persist, there may be a malfunction. Disconnect the power immediately and contact your store of purchase.

System

Symptom	Cause	Measures	Page
Display does not light and no sound is produced when power is turned on.	• Power supply cord is not plugged into power outlet.	• Plug the power supply cord into the power outlet.	11
No sound is produced or sound is distorted.	• Incomplete connections with the various devices.	• Check the connections.	11
	• The receiver's function setting or adjustments are not right.	• Check the receiver's function and controls and adjust as necessary.	—
Display is dim.	• Dimmer function is on.	• Turn the dimmer function off by pressing the DIMMER button on the remote control unit.	15

CD

Symptom	Cause	Measures	Page
"No Disc" is shown on the display even though a CD is loaded.	• The disc is not properly loaded.	• Reload the disc.	4
Disc is not played when ▶/ button is pressed.	• The disc is dirty or scratched.	• Wipe the dirt off the disc or replace the disc.	4
A specific part of a disc is not played.	• The disc is dirty or scratched.	• Wipe the dirt off the disc or replace the disc.	4
A CD-R or CD-RW disc cannot be played.	• The disc has not been finalized.	• Finalize the disc then play it.	4
	• The recording conditions are bad or the quality of the disc itself is poor.	• Use a properly recorded disc.	—
MP3 and WMA files cannot be played.	• The file formats, extensions or settings made when disc was created are not compatible with the CHR-F103.	• Create discs with file formats, extensions or settings compatible with the CHR-F103.	24
CD disc information is not displayed.	• You are not connected to the network.	• Connect to the network.	12
	• The CD information is not included in the Gracenote database on the HDD.		12

HDD

Symptom	Cause	Measures	Page
Selected tracks are not recorded.	<ul style="list-style-type: none"> • Copyright protected tracks cannot be recorded. • MP3 and WMA files cannot be recorded. 	• Copy from the computer onto the internal HDD using Denon Music Manager.	19
			19
Recorded tracks are not displayed.	• Track registration information may not be displayed properly if recording was not completely normally, if the AC power cord was unplugged during recording, etc.	• If the track registration information is not normal, press the ON/STANDBY button while pressing the ■ button and the CD/HDD/USB/NET button simultaneously with the CHR-F103 in the standby mode. "Rebuild Index Mode" is displayed. Select "Yes" then press the ENTER button to rebuild the information registered on the HDD.	—
CD recording takes a lot of time.	• Recording can take a long time if the CD is scratched or dirty.	• Wipe the dirt off the disc or replace the disc.	4

NET

Symptom	Cause	Measures	Page
You are not connected to the network.	• The LAN cable is disconnected.	• Connect properly with a LAN cable.	12
	• (Server and CHR-F103) connected by cross cable.	• Connect properly with a LAN cable.	13
	• Router's or hub's power is off.	• Turn on the power of the router or hub.	13
	• Network settings are wrong.	• Check the router's or hub's operating instructions.	—
		• Contact your line administrator or provider.	—
Sound is broken.	• The sound may be broken depending on the network environment.	• If the playback bit rate is high or the server traffic is heavy, stop the other applications running on the server.	13
No sound is produced.	• Playback data is in a format with which the CHR-F103 is not compatible.		28

□ USB

Symptom	Cause	Measures	Page
USB memory device is not recognized.	<ul style="list-style-type: none"> • USB memory device is in a format other than one with which the CHR-F103 is compatible ("FAT16" and "FAT32"). 	<ul style="list-style-type: none"> • Use a USB memory device with a format with which the CHR-F103 is compatible. 	29
Files on a USB memory device cannot be played.	<ul style="list-style-type: none"> • USB memory device is divided into several partitions. 	<ul style="list-style-type: none"> • The CHR-F103 only selects the top drive, so move the files to be played to the top drive. 	29
"Not Support" is displayed when playing files recorded in MP3 or WMA format.	<ul style="list-style-type: none"> • You have selected a copyright-protected file or a file that cannot be played normally. 	<ul style="list-style-type: none"> • Use the ◀◀ and ▶▶ buttons on the remote control unit to select a different file. 	29

Hard disk inspection and repairs

Depending on the type of problem, DENON may check the data you have stored on your hard disk during inspection or maintenance. Note that DENON will not copy or store this data.

Note that if the hard disk must be formatted during repairs, DENON will do so at its discretion. When the hard disk is formatted, all the data on it is lost. Please back up the data beforehand (☞ page 34).

Specifications

Audio performance (LINE OUT 1)

No. channels:	2 channels
Frequency response:	2 Hz ~ 20 kHz
Dynamic range:	100 dB
S/N:	108 dB
Harmonic distortion:	0.004 % (1 kHz)
Separation:	100 dB
Wow & flutter:	Below measurable limits (± 0.001 % W. peak)
Analog audio output:	Output level : 2.0 Vrms (LINE OUT)

Usable discs:

Diameter:	Compact Disc (CD / CD-R / CD-RW) 120 mm / 80 mm
Playback format:	CD-DA / WMA / MP3

Signal format

Sampling frequency:	44.1 kHz
Quantization bit:	16-bit linear/channel
Transfer bit rate:	4.3218 Mbps

Digital output signal format

Format:	Digital audio interface
Optical output:	-15 ~ -21 dBm
Emission wavelength:	660 nm

Pickup

Type:	Objective lens drive type pickup
Objective lens drive type:	Secondary parallel drive
Light source:	Semiconductor laser
Wavelength:	780 nm

HDD section

Playback format:	WMA (.WMA) / AAC (.M4A) / MP3 (.MP3) / LPCM ※ Depending on the type of file, some AAC files may not play properly.
Sampling frequency:	32 kHz / 44.1 kHz / 48 kHz
Bit rate:	WMA: 64 ~ 192 kbps AAC: 16 ~ 320 kbps MP3: 32 ~ 320 kbps
Recording format:	WMA / LPCM
Bit rate (WMA):	128 kbps (Normal) / 192 kbps (HQ)
No. recordable WMA files:	Approx. 10,000 (Normal) Approx. 7,000 (HQ)
LPCM:	Approx. 900

General

Power supply:	AC 230 V, 50 Hz
Power consumption:	22 W Standby : 0.1 W or less
Maximum external dimensions:	250 (W) x 101 (H) x 250 (D) mm (Not including protruding parts) 250 (W) x 110 (H) x 268 (D) mm (Including protruding parts)
Mass:	3.9 kg

Remote control unit (RC-1042)

Remote control type:	Infrared pulse
Batteries:	R6P/AA Type (two batteries)
External dimensions:	52 (W) x 233 (H) x 21 (D) mm
Mass:	173 g (included batteries)

* For purposes of improvement, specifications and design are subject to change without notice.

DENON

TOKYO, JAPAN
www.denon.com

Denon Brand Company, D&M Holdings Inc.
Printed in China 00D 511 4478 206

Free Manuals Download Website

<http://myh66.com>

<http://usermanuals.us>

<http://www.somanuals.com>

<http://www.4manuals.cc>

<http://www.manual-lib.com>

<http://www.404manual.com>

<http://www.luxmanual.com>

<http://aubethermostatmanual.com>

Golf course search by state

<http://golfingnear.com>

Email search by domain

<http://emailbydomain.com>

Auto manuals search

<http://auto.somanuals.com>

TV manuals search

<http://tv.somanuals.com>