

INSTALLATION AND OPERATING INSTRUCTIONS

VENTILATION FAN / LIGHT

READ AND SAVE THESE INSTRUCTIONS

GENERAL SAFETY INFORMATION

1. Make sure that the electric service supply voltage is AC 120V, 60Hz.
2. Follow all local electrical and safety codes, as well as the Nation Electrical Code (NEC) and the Occupation Safety and Healthy Act (OSHA).
3. Always disconnect the power source before working on or near the ventilating fan, motor or junction box.
4. Protect the power cord from sharp edges, oil, grease, hot surfaces, chemicals or other objects.
5. Do not kink the power cord.
6. Do not install the unit where ducts are configured as shown in Fig. A.
7. Provide suction parts with proper ventilation.
8. This unit is UL listed for use over a bathtub or shower when installed in a GFCI protected branch circuit.
9. These ventilating fans are intended for residential usage only.

WARNING

TO REDUCE THE RISK OF FIRE, ELECTRIC SHOCK, OR INJURY TO PERSONS, OBSERVE THE FOLLOWING:

1. Use this unit only in the manner intended by the manufacturer. If you have any questions, contact the manufacturer.
2. Before servicing or cleaning unit, switch power off at service panel and lock the service disconnecting means to prevent power from being switched on accidentally. When the service disconnecting means cannot be locked, securely fasten a prominent warning device, such as a tag, to the service panel.
3. Installation work and electrical wiring must be done by qualified person(s) in accordance with all applicable codes and standards, including fire-rated construction.
4. Sufficient air is needed for proper combustion and exhausting of gases through the flue (chimney) of fuel burning equipment to prevent back drafting. Follow the heating equipment manufacturer's guideline and safety standards such as those published by the National Fire Protection Association (NFPA), and the American Society for Heating Refrigeration and Air Conditioning Engineers (ASHRAE) and local code authorities.
5. When cutting or drilling into wall or ceiling, do not damage electrical wiring and other hidden utilities.
6. Ducted ventilating fan must always be vented to the outdoors.
7. Do not install this ventilating fan where air temperature may exceed 40°C (104°F).
8. If this unit is to be installed over a tub or shower, it must be marked as appropriate for the application and be connected to a GFCI (Ground Fault Circuit Interrupter) – protected branch circuit.
9. These models are UL listed for tub and shower enclosures.
10. Do not use this unit with any other solid-state control device. Solid-state controls may cause harmonic distortion, which can cause motor humming noise.

11. Before servicing or cleaning unit, switch power off at service panel and lock the service disconnecting means to prevent power from being switched on accidentally. When the service disconnecting means cannot be locked, securely fasten a prominent warning device, such as a tag, to the service panel.
12. NEVER place a switch where it can be reached from a tub or shower.
13. Not to be installed in a ceiling thermally insulated to a value greater than R40. (This is required for installation in Canada only)

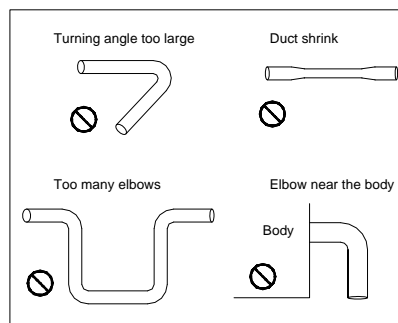

Fig. A

CAUTION

1. For general ventilating use only. Do not use to exhaust hazardous or explosive materials and vapors.
2. Not for use in cooking area. (Fig. B)
3. This product must be properly grounded.

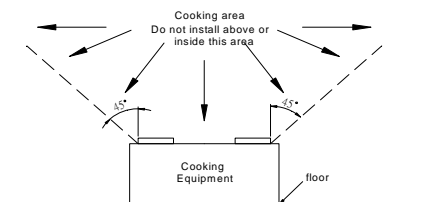

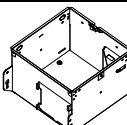

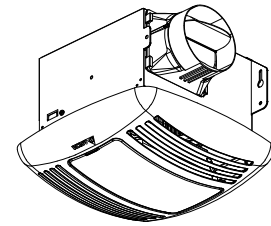
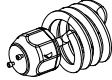

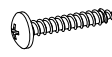





Fig. B

SUPPLIED ACCESSORIES

Part name	Appearance	Quantity
Grille		1
Fan		1
Housing		1
Duct (4")		1



GU24 base bulb lamp (26W)		1
Lamp module bracket		1
Long Screw (φ 4x25)		4
Screw (M4x6)		1
Screw (#8-32x30)		1
Screw (M3x10)		1

1. INSTALLATIONS

MOUNT HOUSING WITH FLANGE:

- 1-1. To bend the housing tabs out to 90 degree and make housing tabs contact the bottom of the joist.

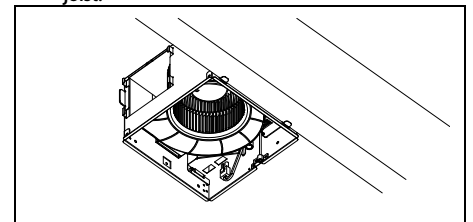

- 1-2. The housing mounts with 4 screws (φ 4x25). Screw housing to joist through lowest holes in each mounting flange, then through the other holes.

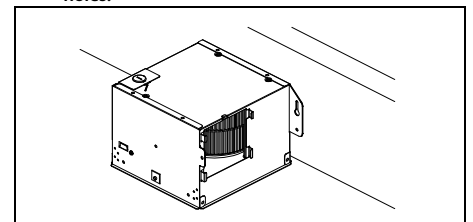

2. DUCT CONNECTION

- 2-1. Insert the duct into the duct connector and tape all ductworks connection to make them secure and air tight.
- 2-2. Install the duct with a gradient 1°~2° to the outside.

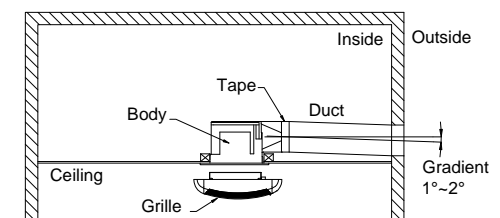

3. CONNECT WIRING

- 3-1. Follow all local electrical and safety codes.
- 3-2. NEVER place a switch where it can be reached from a tub or shower.
- 3-3. Connect wires as shown in wiring diagrams.

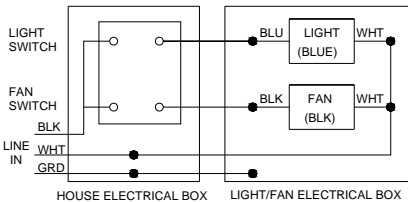

- 3-4. Using wire nuts(not provided), connect house power cable to ventilating fan.
- 3-5. 14 AWG (2.1 mm²) is the smallest conductor that shall be used for branch-circuit wiring.

4. TEST RUN & GRILLE ATTACHMENT

- 4-1. When the power on, check for abnormal vibration or sound.
- 4-2. Mount the grille to the grille bracket by mount screw (#8-32x30-1 PCS)
- 4-3. Insert the grille bracket module(4-2-1) into the main body, and lock screw(M4x6) to fixed the grille bracket.

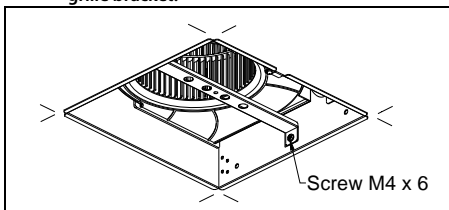

- 4-4. Mount the grille into main body by location screw.
- 4-5. Should be fix the grille on the main body by screw and nut respectively.

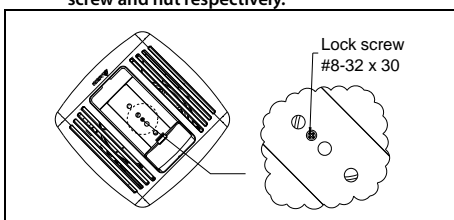

- 4-6. Install light bulbs and attach the cover.

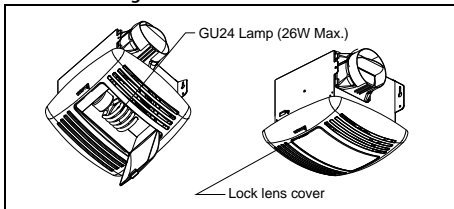

5. OPERATION

- 5-1. Single Speed Model: VFB080C4L1
Turn on the power switch to operate ON or OFF, and LED indicator is amber. Turn on the power to operate main light on/off.
- 5-2. Single Speed Model: VFB050C4L1
Turn on the power switch to operate ON or OFF, and LED indicator is green. Turn on the power to operate main light on/off.

6. MAINTENANCE

WARNING:

Disconnect power source before working on unit. Routine maintenance must be done every year.

CAUTION:

1. Never use gasoline, benzene, thinner or any other such chemicals for cleaning the ventilating fan.
2. Do not allow water to enter motor.
3. Do not soak resin parts in water over 60°C.

CLEANING :

1. Open lens cover. Remove the light bulbs carefully. Disassemble the lock screw, lock nut and light power connections to remove grille.
2. Wash and clean grille. CAUTION: Do not let water into the lamp base. (Use non-abrasive kitchen detergent, wipe dry with a new cloth.)
3. Remove dust and dirt from ventilating fan using a vacuum cleaner.
4. Using a cloth dampened with kitchen detergent, remove any dirt from ventilating fan. Wipe dry with new cloth.
5. Replace grille.

DIMENSIONS

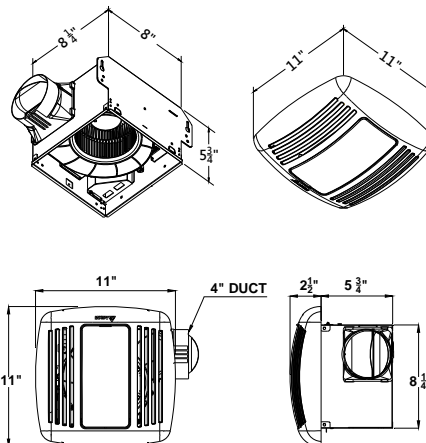

SPECIFICATIONS

Model No.	Voltage (V)	Frequency (Hz)	Power (W)	Air Flow @ 0.15SP (CFM)	Weight (lb.)	Note
VFB080C4L1	120	60	35	80	6.4	Light
VFB050C4L1	120	60	31	50	6.4	Light

Note: Design and specifications subject to change without notice.

WARRANTY

DELTA ELECTRONICS THREE YEAR LIMITED WARRANTY

Delta Electronics Inc. ("Delta Electronics") warrants to the original consumer purchaser in the USA that the Breez ventilation fan products will be free from defects in material or workmanship. This warranty is limited to three (3) years from the original date of purchase.

Limitations and Exclusions

1. During the warranty period, a replacement for any defective product will be supplied free of charge for installation by the consumer. The warranty provided herein does not cover charges for labor or other costs incurred in the troubleshooting, repair, removal, and installation service.
2. All returns of defective parts or products must include the product model number, and must be made through an authorized Delta Electronics distributor. Authorized returns must be shipped prepaid. Repaired or replacement products will be shipped by Delta Electronics F.O.B. shipping point.
3. Delta Electronics shall not be liable for any indirect, incidental, consequential, punitive, or special damages arising out of or in connection with products use or performance, regardless of the form of action whether in contract, tort (including negligence), strict product liability or otherwise.
4. This warranty does not extend to fluorescent lamp starters and tubes.
5. The warranty does not cover if user does not comply with manufacture's installation manual.
6. To qualify for warranty service, you must notify Delta Electronics at the address or telephone number below.
7. Delta Electronics shall have no liability to the original owner-user with respect to any defect caused by abuse, misuse, neglect, improper transportation or storage, improper testing, improper installation, improper operation, improper use, improper maintenance, improper repair, improper alteration, improper modification, tampering or accident of products or parts thereof, or unusual deterioration or degradation of products or parts thereof due to a physical environment beyond the requirements of products' specifications.

Address: 4405 Cushing Parkway, Fremont, CA 94538
US Toll Free Number: 1-888-979-9889

Free Manuals Download Website

<http://myh66.com>

<http://usermanuals.us>

<http://www.somanuals.com>

<http://www.4manuals.cc>

<http://www.manual-lib.com>

<http://www.404manual.com>

<http://www.luxmanual.com>

<http://aubethermostatmanual.com>

Golf course search by state

<http://golfingnear.com>

Email search by domain

<http://emailbydomain.com>

Auto manuals search

<http://auto.somanuals.com>

TV manuals search

<http://tv.somanuals.com>