

VE

VFD-VE

User Manual

High Performance Field Oriented Control AC Motor Drives



Power Range:

3-phase 230V series: 0.75~37kW(1.0~50HP)

3-phase 460V series: 0.75~75kW(1.0~100HP)



DELTA ELECTRONICS, INC.

www.delta.com.tw/industrialautomation

ASIA

Delta Electronics, Inc.

Taoyuan¹

31-1, Xingbang Road, Guishan Industrial Zone,
Taoyuan County 33370, Taiwan, R.O.C.
TEL: 886-3-362-6301 / FAX: 886-3-362-7267

Delta Electronics (Jiang Su) Ltd.

Wujiang Plant3

1688 Jiangxing East Road,
Wujiang Economy Development Zone,
Wujiang City, Jiang Su Province,
People's Republic of China (Post code: 215200)
TEL: 86-512-6340-3008 / FAX: 86-769-6340-7290

Delta Electronics (Japan), Inc.

Tokyo Office

Delta Shibadaimon Building, 2-1-14 Shibadaimon,
Minato-Ku, Tokyo, 105-0012, Japan
TEL: 81-3-5733-1111 / FAX: 81-3-5733-1211

Delta Electronics (Korea), Inc.

234-9, Duck Soo BD 7F, Nonhyun-dong,
Kangnam-ku, Seoul, Korea
Post code : 135-010
TEL: 82-2-515-5303/5 / FAX: 82-2-515-5302

Delta Electronics (Singapore) Pte. Ltd.

8 Kaki Bukit Road 2, #04-18 Ruby Warehouse Complex,
Singapore 417841
TEL: 65-6747-5155 / FAX: 65-6744-9228

Delta Energy Systems (India) Pvt. Ltd.

Plot No. 27 & 31, Sector-34, EHTP,
Gurgaon-122001 Haryana, India
TEL: 91-124-4169040 / FAX: 91-124-4036045

AMERICA

Delta Products Corporation (USA)

Raleigh Office

P.O. Box 12173, 5101 Davis Drive,
Research Triangle Park, NC 27709, U.S.A.
TEL: 1-919-767-3813 / FAX: 1-919-767-3969

EUROPE

Deltronics (Netherlands) B.V.

Eindhoven Office

De Witbogt 15, 5652 AG Eindhoven, The Netherlands
TEL: 31-40-259-28-50 / FAX: 31-40-259-28-51

5011653103
200808-01



03VE

*We reserve the right to change the information in this manual without prior notice



VFD-VE

User Manual

High Performance Field Oriented Control AC Motor Drives

Preface

Thank you for choosing DELTA's high-performance VFD-VE Series. The VFD-VE Series is manufactured with high-quality components and materials and incorporates the latest microprocessor technology available.

This manual is to be used for the installation, parameter setting, troubleshooting, and daily maintenance of the AC motor drive. To guarantee safe operation of the equipment, read the following safety guidelines before connecting power to the AC motor drive. Keep this operating manual at hand and distribute to all users for reference.

To ensure the safety of operators and equipment, only qualified personnel familiar with AC motor drive are to do installation, start-up and maintenance. Always read this manual thoroughly before using VFD-VE series AC Motor Drive, especially the WARNING, DANGER and CAUTION notes. Failure to comply may result in personal injury and equipment damage. If you have any questions, please contact your dealer.

PLEASE READ PRIOR TO INSTALLATION FOR SAFETY.



DANGER!

-
1. AC input power must be disconnected before any wiring to the AC motor drive is made.
 2. A charge may still remain in the DC-link capacitors with hazardous voltages, even if the power has been turned off. To prevent personal injury, please ensure that power has turned off before opening the AC motor drive and wait ten minutes for the capacitors to discharge to safe voltage levels.
 3. Never reassemble internal components or wiring.
 4. The AC motor drive may be destroyed beyond repair if incorrect cables are connected to the input/output terminals. Never connect the AC motor drive output terminals U/T1, V/T2, and W/T3 directly to the AC mains circuit power supply.
 5. Ground the VFD-VE using the ground terminal. The grounding method must comply with the laws of the country where the AC motor drive is to be installed. Refer to the Basic Wiring Diagram.
 6. VFD-VE series is used only to control variable speed of 3-phase induction motors, NOT for 1-phase motors or other purpose.
 7. VFD-VE series shall NOT be used for life support equipment or any life safety situation.

**WARNING!**

1. DO NOT use Hi-pot test for internal components. The semi-conductor used in AC motor drive easily damage by high-voltage.
2. There are highly sensitive MOS components on the printed circuit boards. These components are especially sensitive to static electricity. To prevent damage to these components, do not touch these components or the circuit boards with metal objects or your bare hands.
3. Only qualified persons are allowed to install, wire and maintain AC motor drives.

**CAUTION!**

1. Some parameters settings can cause the motor to run immediately after applying power.
2. DO NOT install the AC motor drive in a place subjected to high temperature, direct sunlight, high humidity, excessive vibration, corrosive gases or liquids, or airborne dust or metallic particles.
3. Only use AC motor drives within specification. Failure to comply may result in fire, explosion or electric shock.
4. To prevent personal injury, please keep children and unqualified people away from the equipment.
5. When the motor cable between AC motor drive and motor is too long, the layer insulation of the motor may be damaged. Please use a frequency inverter duty motor or add an AC output reactor to prevent damage to the motor. Refer to appendix B Reactor for details.
6. The rated voltage for AC motor drive must be $\leq 240V$ ($\leq 480V$ for 460V models) and the mains supply current capacity must be $\leq 5000A$ RMS ($\leq 10000A$ RMS for the $\geq 40hp$ (30kW) models).

Table of Contents

Preface	i
Table of Contents	iii
Chapter 1 Introduction	1-1
1.1 Receiving and Inspection	1-2
1.1.1 Nameplate Information	1-2
1.1.2 Model Explanation	1-2
1.1.3 Series Number Explanation	1-3
1.1.4 Drive Frames and Appearances	1-3
1.2 Preparation for Installation and Wiring	1-4
1.2.1 Ambient Conditions	1-4
1.2.2 Remove Keypad	1-6
1.2.3 Remove Front Cover	1-7
1.2.4 Lifting	1-8
1.3 Dimensions	1-9
Chapter 2 Installation and Wiring	2-1
2.1 Wiring	2-2
2.2 External Wiring	2-4
2.3 Main Circuit	2-5
2.3.1 Main Circuit Connection	2-5
2.3.2 Main Circuit Terminals	2-9

2.4 Control Terminals	2-10
Chapter 3 Digital Keypad Operation and Start Up	3-1
3.1 Digital Keypad KPV-CE01	3-1
3.1.1 Description of the Digital Keypad KPV-CE01	3-1
3.1.2 How to Operate the Digital Keypad KPV-CE01	3-3
3.1.3 Dimension of the Digital Keypad	3-5
3.1.4 Reference Table for the LCD Display of the Digital Keypad	3-5
3.1.5 Operation Method.....	3-6
3.2 Start-up	3-6
3.2.1 Preparations before Start-up	3-6
3.2.2 Trial Run.....	3-8
Chapter 4 Parameters.....	4-1
4.1 Summary of Parameter Settings.....	4-2
4.2 Version Differences	4-26
4.2.1 Version 2.02	4-26
4.2.2 Version 2.04	4-26
4.3 Description of Parameter Settings	4-38
Chapter 5 Troubleshooting	5-1
5.1 Over Current (OC)	5-1
5.2 Ground Fault.....	5-2
5.3 Over Voltage (OV)	5-2
5.4 Low Voltage (Lv).....	5-3
5.5 Over Heat (oH1, oH2, oH3)	5-4
5.6 Overload	5-4
5.7 Display of KPV-CE01 is Abnormal.....	5-5

5.8 Phase Loss (PHL)	5-5
5.9 Motor cannot Run	5-6
5.10 Motor Speed cannot be Changed	5-7
5.11 Motor Stalls during Acceleration	5-8
5.12 The Motor does not Run as Expected	5-8
5.13 Electromagnetic/Induction Noise	5-9
5.14 Environmental Condition	5-9
5.15 Affecting Other Machines	5-10
Chapter 6 Fault Code Information and Maintenance	6-1
6.1 Fault Code Information	6-1
6.1.1 Common Problems and Solutions	6-1
6.1.2 Reset	6-6
6.2 Maintenance and Inspections	6-7
Appendix A Specifications	A-1
Appendix B Accessories	B-1
B.1 All Brake Resistors & Brake Units Used in AC Motor Drives	B-1
B.1.1 Dimensions and Weights for Brake Resistors	B-4
B.1.2 Specifications for Brake Unit	B-6
B.1.3 Dimensions for Brake Unit	B-7
B.2 No-fuse Circuit Breaker Chart	B-9
B.3 Fuse Specification Chart	B-10
B.4 AC Reactor	B-11
B.4.1 AC Input Reactor Recommended Value	B-11
B.4.2 AC Output Reactor Recommended Value	B-11

B.4.3 Applications for AC Reactor	B-13
B.5 Zero Phase Reactor (RF220X00A)	B-15
B.6 DC Choke Recommended Values.....	B-16
B.7 Remote Controller RC-01	B-17
B.8 PG Card (for Encoder)	B-18
B.8.1 EMV-PG01X	B-18
B.8.2 EMV-PG01O	B-21
B.8.3 EMV-PG01L.....	B-25
B.9 AMD-EMI Filter Cross Reference	B-29
B.9.1 Dimensions	B-33
B.10 Multi-function I/O Extension Card	B-40
B.10.1 Functions	B-40
B.10.2 Dimensions	B-42
B.10.3 Wiring.....	B-42
Appendix C How to Select the Right AC Motor Drive	C-1
C.1 Capacity Formulas	C-1
C.2 General Precaution	C-3
C.3 How to Choose a Suitable Motor.....	C-5

Chapter 1 Introduction

The AC motor drive should be kept in the shipping carton or crate before installation. In order to retain the warranty coverage, the AC motor drive should be stored properly when it is not to be used for an extended period of time. Storage conditions are:



CAUTION!

-
1. Store in a clean and dry location free from direct sunlight or corrosive fumes.
 2. Store within an ambient temperature range of -10°C to $+40^{\circ}\text{C}$.
 3. Store within a relative humidity range of 0% to 90% and non-condensing environment.
 4. Store within an air pressure range of 86 kPA to 106kPA.
 5. DO NOT place on the ground directly. It should be stored properly. Moreover, if the surrounding environment is humid, you should put exsiccator in the package.
 6. DO NOT store in an area with rapid changes in temperature. It may cause condensation and frost.
 7. If the AC motor drive is stored for more than 3 months, the temperature should not be higher than 30°C . Storage longer than one year is not recommended, it could result in the degradation of the electrolytic capacitors.
 8. When the AC motor drive is not used for longer time after installation on building sites or places with humidity and dust, it's best to move the AC motor drive to an environment as stated above.

1.1 Receiving and Inspection

This VFD-VE AC motor drive has gone through rigorous quality control tests at the factory before shipment. After receiving the AC motor drive, please check for the following:

- Check to make sure that the package includes an AC motor drive, the User Manual/Quick Start and CD.
- Inspect the unit to assure it was not damaged during shipment.
- Make sure that the part number indicated on the nameplate corresponds with the part number of your order.

1.1.1 Nameplate Information

Example for 5HP/3.7kW 3-phase 230V AC motor drive

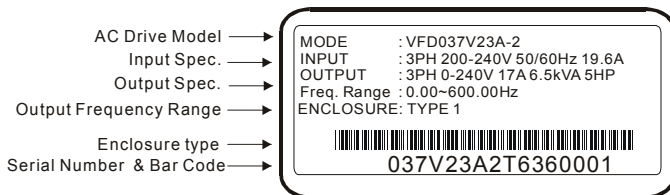

1.1.2 Model Explanation

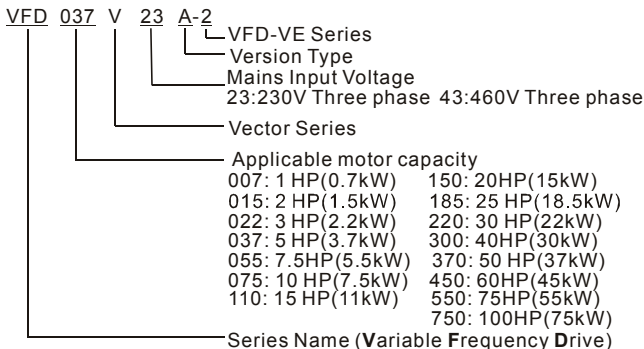

1.1.3 Series Number Explanation

037V23A2 T 7 36 0001

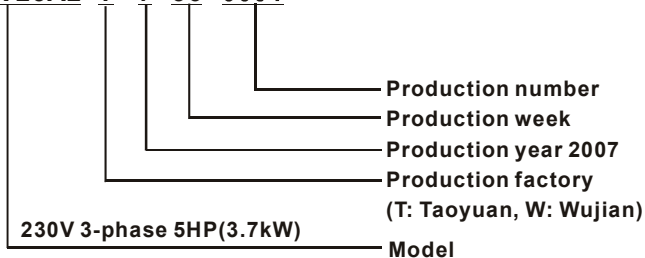

If the nameplate information does not correspond to your purchase order or if there are any problems, please contact your distributor.

1.1.4 Drive Frames and Appearances

1-5HP/0.75-3.7kW (Frame B)

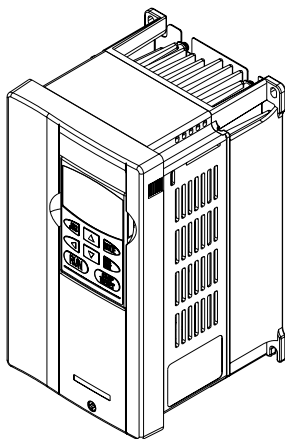

7.5-15HP/5.5-11kW (Frame C)

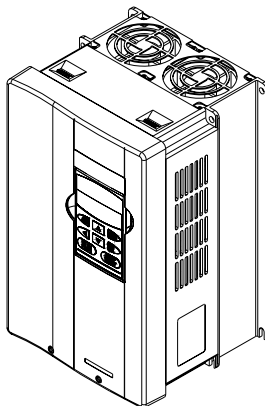

15-30HP/11-22kW (Frame D)

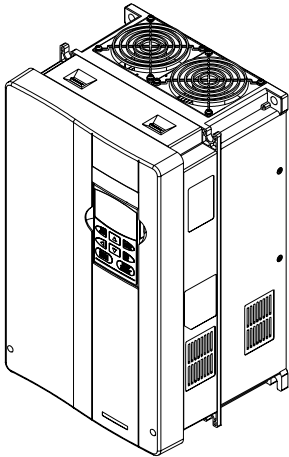

40-100HP/30-75kW (Frame E)

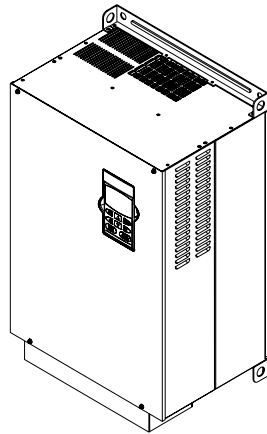

Frame	Power range	Models
B (B1)	1-3hp (0.75-2.2kW)	VFD007V23A/43A-2, VFD015V23A/43A-2, VFD022V23A/43A-2
B (B2)	5hp (3.7kW)	VFD037V23A/43A-2
C	7.5-15hp (5.5-11kW)	VFD055V23A/43A-2, VFD075V23A/43A-2, VFD110V43B-2
D	15-30hp (11-22kW)	VFD110V23A/43A-2, VFD150V23A/43A-2, VFD185V23A/43A-2, VFD220V23A/43A-2
E (E1)	40-60hp (30-45kW)	VFD300V43A-2, VFD370V43A-2, VFD450V43A-2
E (E2)	40-100hp (30-75kW)	VFD300V23A-2, VFD370V23A-2, VFD550V43C-2, VFD750V43C-2

Please refer to Chapter 1.3 for exact dimensions.

1.2 Preparation for Installation and Wiring

1.2.1 Ambient Conditions

Install the AC motor drive in an environment with the following conditions:

Operation	Air Temperature:	-10 ~ +40°C (14 ~ 122°F)
	Relative Humidity:	<90%, no condensation allowed
	Atmosphere pressure:	86 ~ 106 kPa
	Installation Site Altitude:	<1000m
	Vibration:	<20Hz: 9.80 m/s ² (1G) max 20 ~ 50Hz: 5.88 m/s ² (0.6G) max
Storage Transportation	Temperature:	-20°C ~ +60°C (-4°F ~ 140°F)
	Relative Humidity:	<90%, no condensation allowed
	Atmosphere pressure:	86 ~ 106 kPa
	Vibration:	<20Hz: 9.80 m/s ² (1G) max 20 ~ 50Hz: 5.88 m/s ² (0.6G) max
Pollution Degree	2: good for a factory type environment.	

Minimum Mounting Clearances

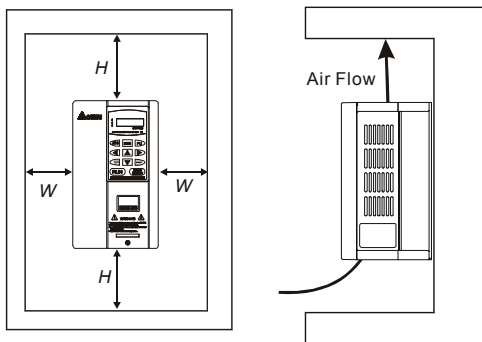

HP	W mm (inch)	H mm (inch)
1-5HP	50 (2)	150 (6)
7.5-20HP	75 (3)	175 (7)
25-75HP	75 (3)	200 (8)
100HP and above	75 (3)	250 (10)

**CAUTION!**

1. Operating, storing or transporting the AC motor drive outside these conditions may cause damage to the AC motor drive.
2. Failure to observe these precautions may void the warranty!
3. Mount the AC motor drive vertically on a flat vertical surface object by screws. Other directions are not allowed.
4. The AC motor drive will generate heat during operation. Allow sufficient space around the unit for heat dissipation.
5. The heat sink temperature may rise to 90°C when running. The material on which the AC motor drive is mounted must be noncombustible and be able to withstand this high temperature.
6. When AC motor drive is installed in a confined space (e.g. cabinet), the surrounding temperature must be within -10 ~ 40°C with good ventilation. DO NOT install the AC motor drive in a space with bad ventilation.
7. When installing multiple AC more drives in the same cabinet, they should be adjacent in a row with enough space in-between. When installing one AC motor drive below another one, use a metal separation between the AC motor drives to prevent mutual heating.
8. Prevent fiber particles, scraps of paper, saw dust, metal particles, etc. from adhering to the heatsink.

1.2.2 Remove Keypad

1-5HP/0.75-3.7kW (Frame B)

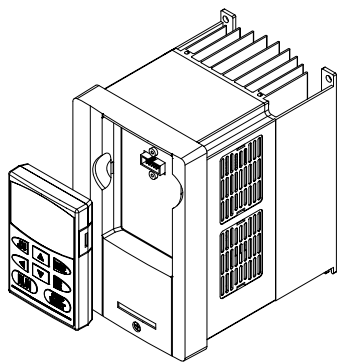

7.5-15HP/5.5-11kW (Frame C)

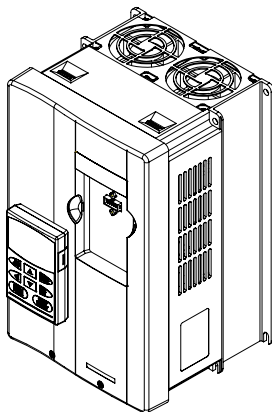

15-30HP/11-22kW (Frame D)

40-100HP/30-75kW (Frame E)

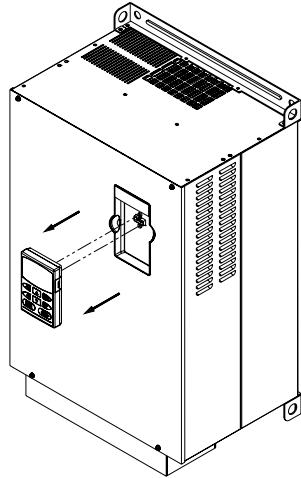
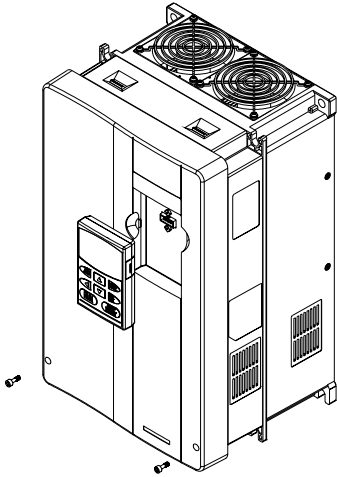

1.2.3 Remove Front Cover

1-5HP/0.75-3.7kW (Frame B)

7.5-15HP/5.5-11kW (Frame C)

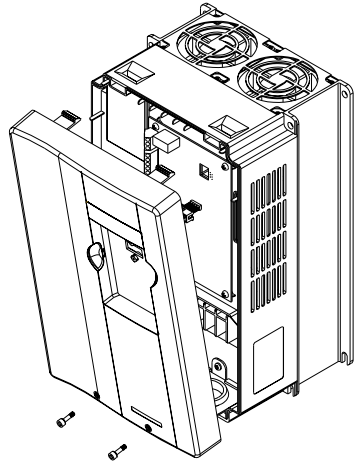
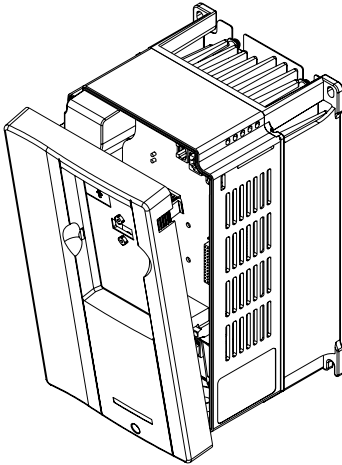

15-30HP/11-22kW (Frame D)

40-100HP/30-75kW (Frame E)

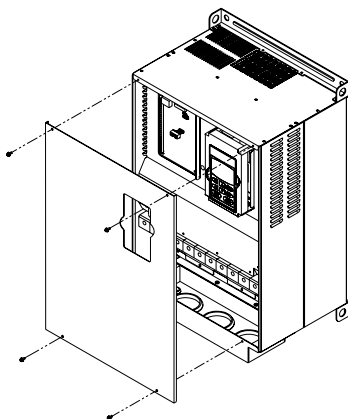
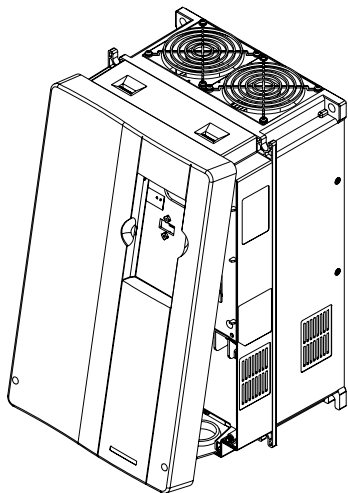

1.2.4 Lifting

Please carry only fully assembled AC motor drives as shown in the following.

For 40-100HP (Frame E and E1)

Step 1

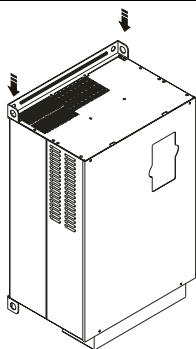

Step 2

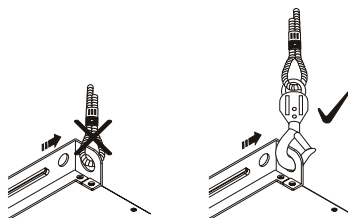

Step 3

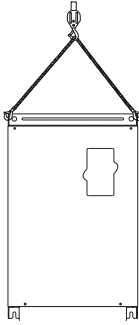

Step 4

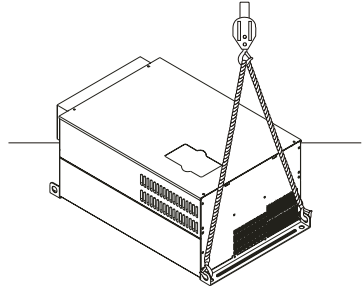

1.3 Dimensions

Frame B

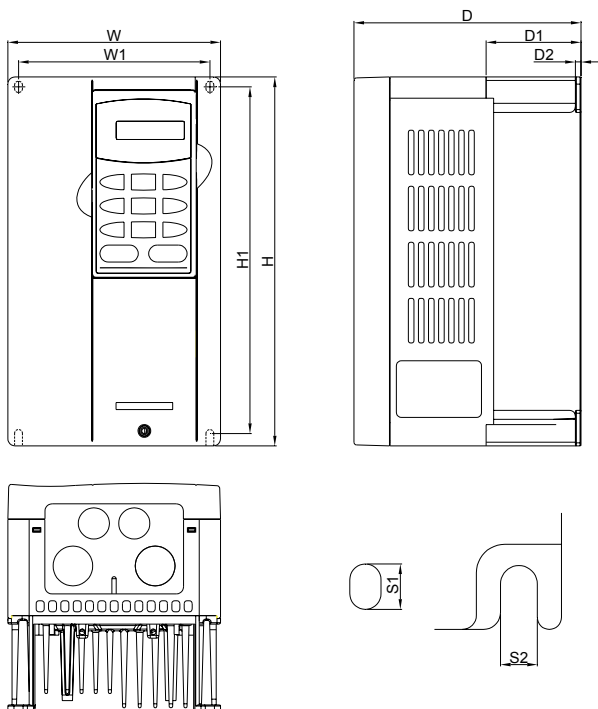

Unit: mm[inch]

Frame	W	W1	H	H1	D	D1	D2	S1	S2
B1	150.0 [5.91]	135.0 [5.32]	260.0 [10.24]	244.3 [9.63]	160.2 [6.31]	67.0 [2.64]	4.0 [0.16]	8.0 [0.32]	6.5 [0.26]
B2	150.0 [5.91]	135.0 [5.32]	272.1 [10.72]	244.3 [9.63]	183.7 [7.24]	67.0 [2.64]	4.0 [0.16]	8.0 [0.32]	6.5 [0.26]

 **NOTE**

Frame B1: VFD007V23A/43A-2, VFD015V23A/43A-2, VFD022V23A/43A-2

Frame B2: VFD037V23A/43A-2

Frame C

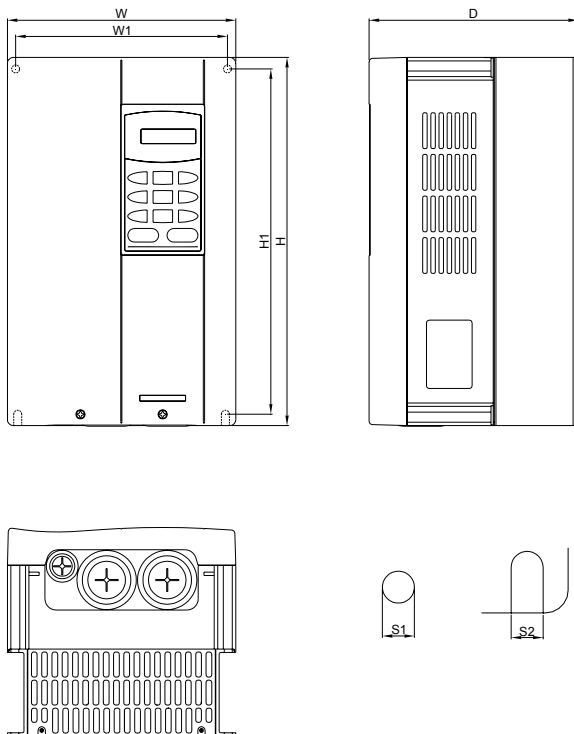

Unit: mm[inch]

Frame	W	W1	H	H1	D	-	-	S1	S2
C	200.0 [7.88]	185.6 [7.31]	323.0 [12.73]	244.3 [9.63]	160.2 [6.31]	-	-	7.0 [0.28]	7.0 [0.28]



Frame C: VFD055V23A/43A-2, VFD075V23A/43A-2, VFD110V43B-2

Frame D

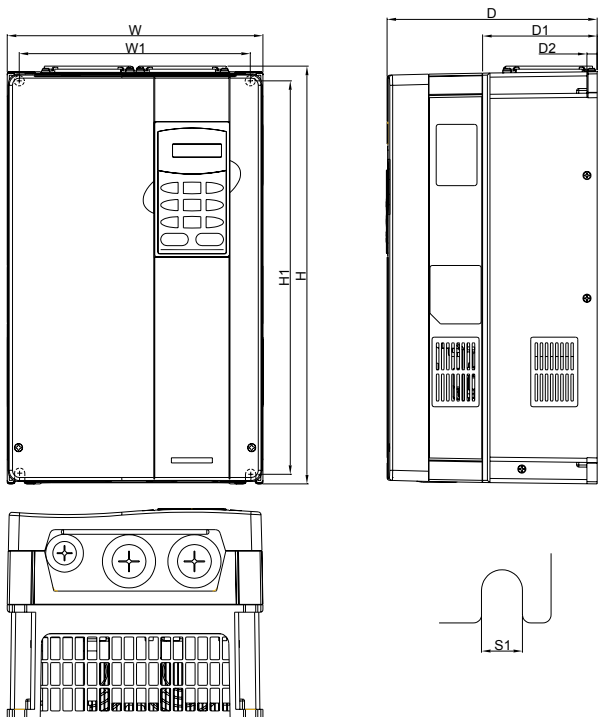

Unit: mm[inch]

Frame	W	W1	H	H1	D	D1	D2	S1	-
D	250.0 [9.85]	226.0 [8.90]	408.2 [16.07]	384.0 [15.13]	205.4 [8.08]	110.0 [4.33]	10.0 [0.39]	10.0 [0.39]	-



Frame D: VFD110V23A/43A-2, VFD150V23A/43A-2, VFD185V23A/43A-2, VFD220V23A/43A-2

Frame E

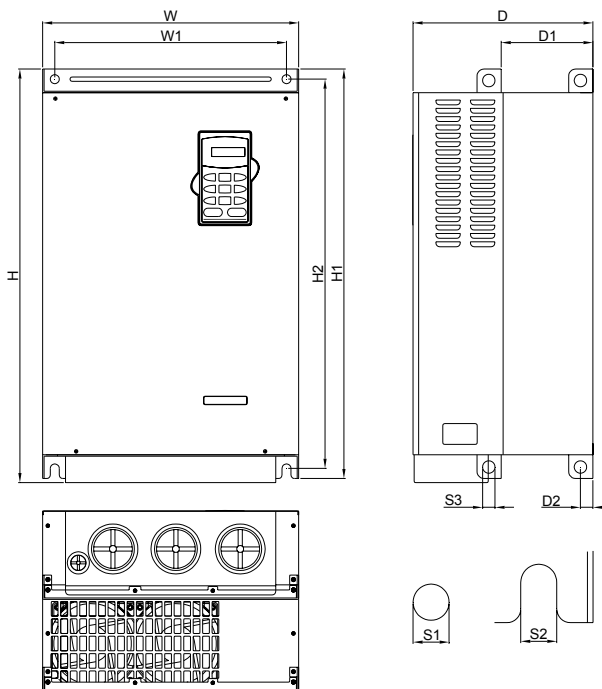

Unit: mm[inch]

Frame	W	W1	H	H1	H2	D	D1	D2	S1	S2	S3
E1	370.0 [14.57]	335.0 [13.19]	-	589.0 [23.19]	560.0 [22.05]	260.0 [10.24]	132.5 [5.22]	18.0 [0.71]	13.0 [0.51]	13.0 [0.51]	18.0 [0.71]
E2	370.0 [14.57]	335.0 [13.19]	595.0 [23.43]	589.0 [23.19]	560.0 [22.05]	260.0 [10.24]	132.5 [5.22]	18.0 [0.71]	13.0 [0.51]	13.0 [0.51]	18.0 [0.71]

**NOTE**

Frame E1: VFD300V43A-2, VFD370V43A-2, VFD450V43A-2

Frame E2: VFD300V23A-2, VFD370V23A-2, VFD550V43C-2, VFD750V43C-2

This page intentionally left blank

Chapter 2 Installation and Wiring

After removing the front cover (see chapter 1.2.3 for details), check if the power and control terminals are clear. Be sure to observe the following precautions when wiring.

■ General Wiring Information

Applicable Codes

All VFD-VE series are Underwriters Laboratories, Inc. (UL) and Canadian Underwriters Laboratories (cUL) listed, and therefore comply with the requirements of the National Electrical Code (NEC) and the Canadian Electrical Code (CEC).

Installation intended to meet the UL and cUL requirements must follow the instructions provided in "Wiring Notes" as a minimum standard. Follow all local codes that exceed UL and cUL requirements. Refer to the technical data label affixed to the AC motor drive and the motor nameplate for electrical data.

The "Line Fuse Specification" in Appendix B, lists the recommended fuse part number for each VFD-VE Series part number. These fuses (or equivalent) must be used on all installations where compliance with U.L. standards is a required.



CAUTION!

-
1. Make sure that power is only applied to the R/L1, S/L2, T/L3 terminals. Failure to comply may result in damage to the equipment. The voltage and current should lie within the range as indicated on the nameplate.
 2. Check following items after finishing the wiring:
 - A. Are all connections correct?
 - B. No loose wires?
 - C. No short-circuits between terminals or to ground?



DANGER!

-
1. A charge may still remain in the DC bus capacitors with hazardous voltages even if the power has been turned off. To prevent personal injury, please ensure that the power is turned off and wait ten minutes for the capacitors to discharge to safe voltage levels before opening the AC motor drive.
 2. All the units must be grounded directly to a common ground terminal to prevent lightning strike or electric shock.
 3. Only qualified personnel familiar with AC motor drives is allowed to perform installation, wiring and commissioning.
 4. Make sure that the power is off before doing any wiring to prevent electric shock.

2.1 Wiring

Users must connect wires according to the circuit diagrams on the following pages. Do not plug a modem or telephone line to the RS-485 communication port or permanent damage may result. The pins 1 & 2 are the power supply for the optional copy keypad KPV-CE01 only and should not be used for RS-485 communication.

Figure 1 for models of VFD-VE Series (15 HP/11kW and below)
 VFD007V23A/43A-2, VFD015V23A/43A-2, VFD022V23A/43A-2, VFD037V23A/43A-2,
 VFD055V23A/43A-2, VFD075V23A/43A-2, VFD110V43B-2, VFD110V23A/43A-2

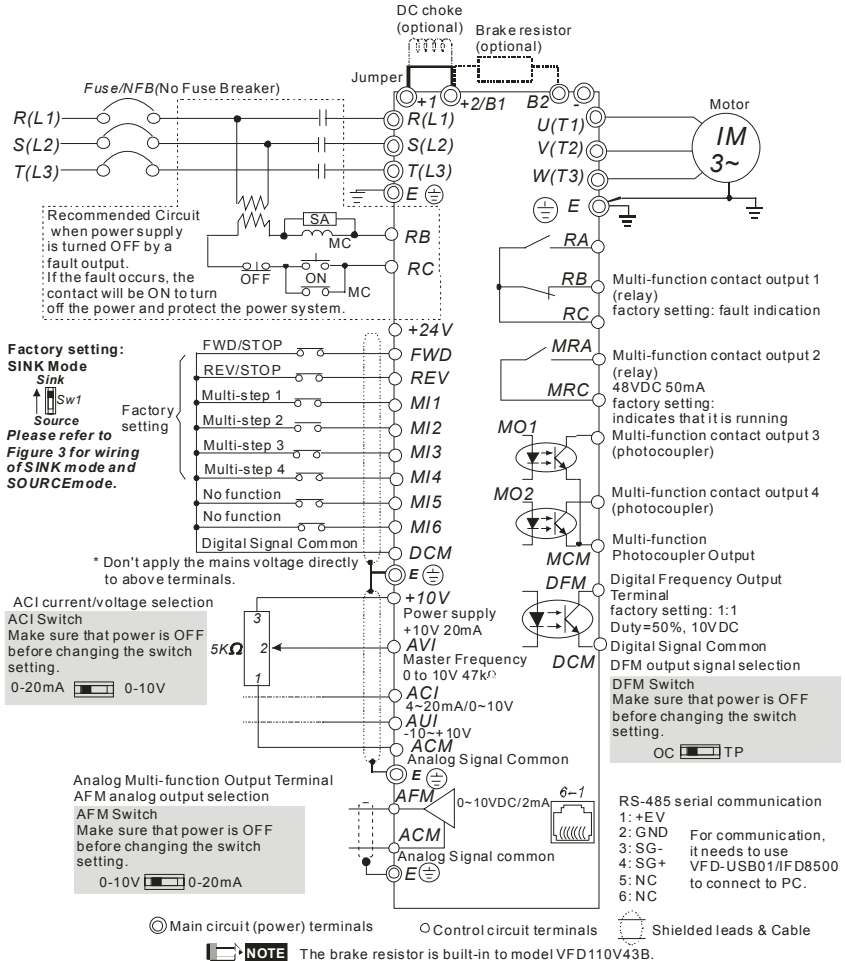

Figure 2 for models of VFD-VE Series (20HP/15kW and above)
 VFD150V23A/43A-2, VFD185V23A/43A-2, VFD220V23A/43A-2, VFD300V43A-2, VFD370V43A-2,
 VFD450V43A-2, VFD300V23A-2, VFD370V23A-2, VFD550V43C-2, VFD750V43C-2

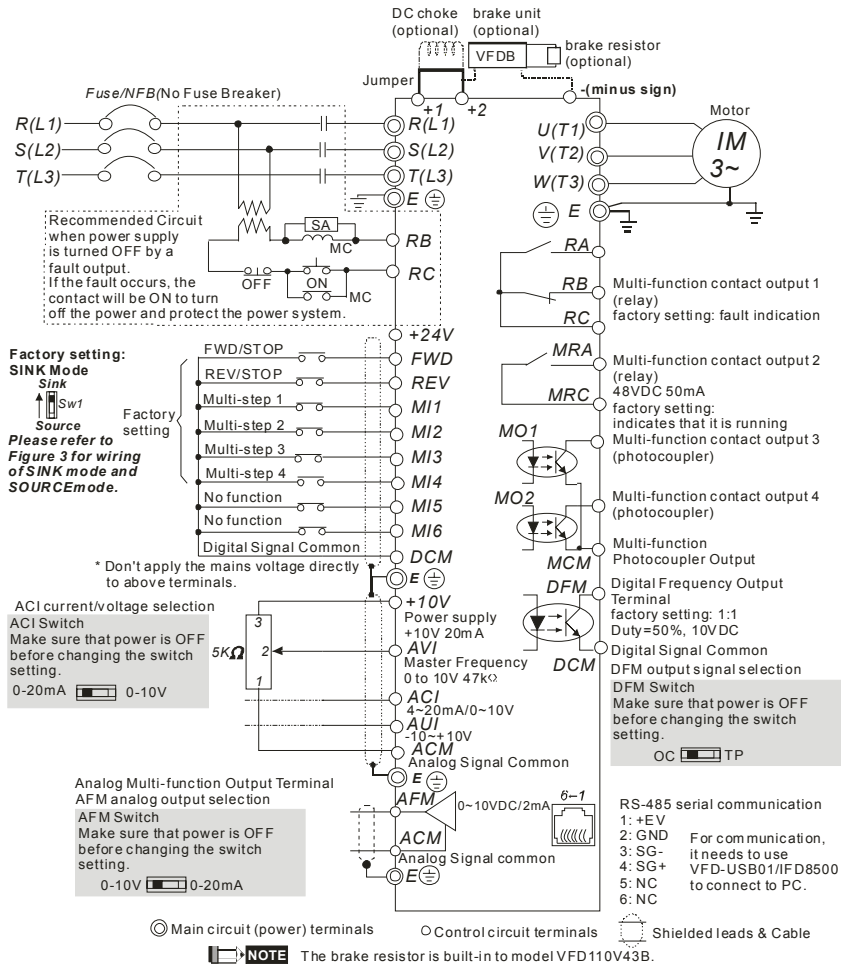
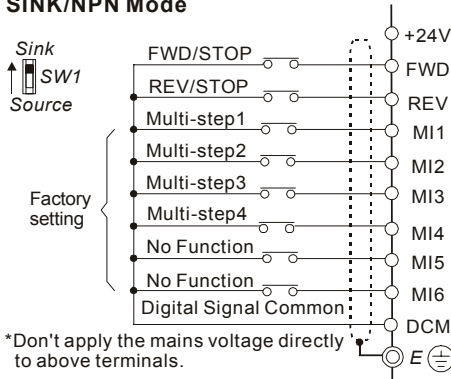
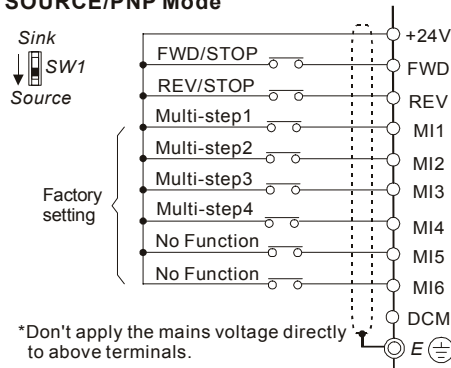

Figure 3 Wiring for SINK(NPN) mode and SOURCE(PNP) mode

SINK/NPN Mode



SOURCE/PNP Mode



CAUTION!

1. The wiring of main circuit and control circuit should be separated to prevent erroneous actions.
2. Please use shield wire for the control wiring and not to expose the peeled-off net in front of the terminal.
3. Please use the shield wire or tube for the power wiring and ground the two ends of the shield wire or tube.

2.2 External Wiring

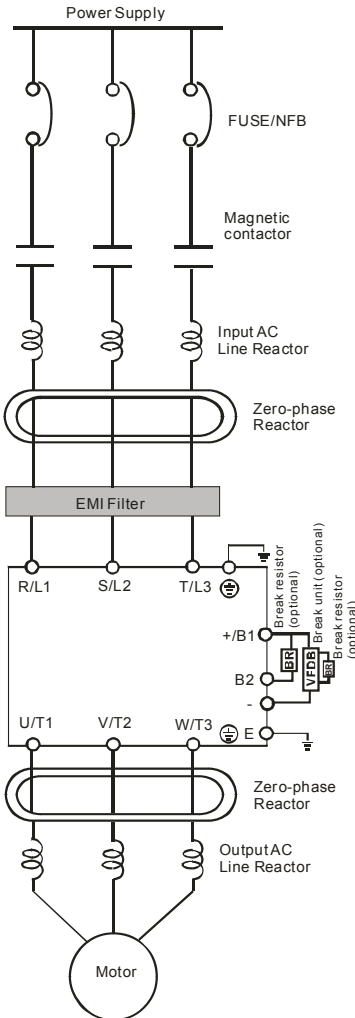

Items	Explanations
Power supply	Please follow the specific power supply requirements shown in Appendix A.
Fuse/NFB (Optional)	There may be an inrush current during power up. Please check the chart of Appendix B and select the correct fuse with rated current. Use of an NFB is optional.
Magnetic contactor (Optional)	Please do not use a Magnetic contactor as the I/O switch of the AC motor drive, as it will reduce the operating life cycle of the AC drive.
Input AC Line Reactor (Optional)	Used to improve the input power factor, to reduce harmonics and provide protection from AC line disturbances (surges, switching spikes, short interruptions, etc.). AC line reactor should be installed when the power supply capacity is 500kVA or more or advanced capacity is activated. The wiring distance should be ≤ 10m. Refer to appendix B for details.
Zero-phase Reactor (Ferrite Core Common Choke) (Optional)	Zero phase reactors are used to reduce radio noise especially when audio equipment is installed near the inverter. Effective for noise reduction on both the input and output sides. Attenuation quality is good for a wide range from AM band to 10MHz. Appendix B specifies the zero phase reactor. (RF220X00A)
EMI filter (Optional)	To reduce electromagnetic interference, please refer to Appendix B for more details.
Brake Resistor (Optional)	Used to reduce the deceleration time of the motor. Please refer to the chart in Appendix B for specific Brake Resistors.
Output AC Line Reactor (Optional)	Motor surge voltage amplitude depends on motor cable length. For applications with long motor cable (>20m), it is necessary to install a

2.3 Main Circuit

2.3.1 Main Circuit Connection

Figure 1 for the main terminals

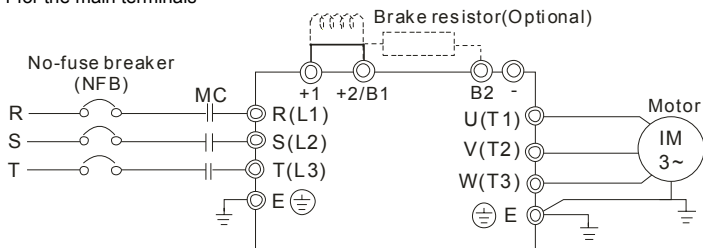
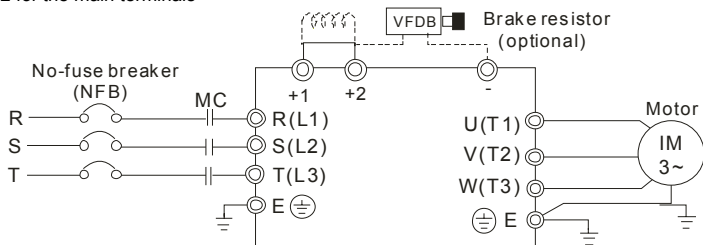

Figure 2 for the main terminals



Terminal Symbol	Explanation of Terminal Function
R/L1, S/L2, T/L3	AC line input terminals (1-phase/3-phase)
U/T1, V/T2, W/T3	AC drive output terminals for connecting 3-phase induction motor
+1, +2	Connections for DC Choke (optional)
+2/B1, B2	Connections for Brake Resistor (optional)
+2~(-), +2/B1~(-)	Connections for External Brake Unit (VFDB series)
	Earth connection, please comply with local regulations.

Mains power terminals (R/L1, S/L2, T/L3)

- Connect these terminals (R/L1, S/L2, T/L3) via a no-fuse breaker or earth leakage breaker to 3-phase AC power (some models to 1-phase AC power) for circuit protection. It is unnecessary to consider phase-sequence.
- It is recommended to add a magnetic contactor (MC) in the power input wiring to cut off power quickly and reduce malfunction when activating the protection function of AC motor drives. Both ends of the MC should have an R-C surge absorber.
- Please make sure to fasten the screw of the main circuit terminals to prevent sparks which is made by the loose screws due to vibration.
- Please use voltage and current within the regulation shown in Appendix A.
- When using leakage-current breaker to prevent leakage current,
- Do NOT run/stop AC motor drives by turning the power ON/OFF. Run/stop AC motor drives by RUN/STOP command via control terminals or keypad. If you still need to run/stop AC drives by turning power ON/OFF, it is recommended to do so only ONCE per hour.
- Do NOT connect 3-phase models to a 1-phase power source.

Output terminals for main circuit (U, V, W)

- When the AC drive output terminals U/T1, V/T2, and W/T3 are connected to the motor terminals U/T1, V/T2, and W/T3, respectively, the motor will rotate counterclockwise (as viewed on the shaft end of the motor) when a forward operation command is received. To permanently reverse the direction of motor rotation, switch over any of the two motor leads.

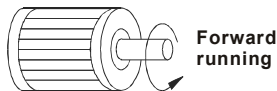

- DO NOT connect phase-compensation capacitors or surge absorbers at the output terminals of AC motor drives.
- With long motor cables, high capacitive switching current peaks can cause over-current, high leakage current or lower current readout accuracy. To prevent this, the motor cable should be less than 20m for 3.7kW models and below. And the cable should be less than 50m for 5.5kW models and above. For longer motor cables use an AC output reactor.
- Use well-insulated motor, suitable for inverter operation.

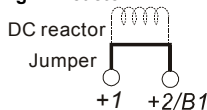
Terminals [+1, +2] for connecting DC reactor

- To improve power factor and reduce harmonics connect a DC reactor between terminals [+1, +2]. Please remove the jumper before connecting the DC reactor.



NOTE

Models of 15kW and above have a built-in DC reactor.

Terminals [+2/B1, B2] for connecting brake resistor and terminals [+1, +2/B1] for connecting external brake unit

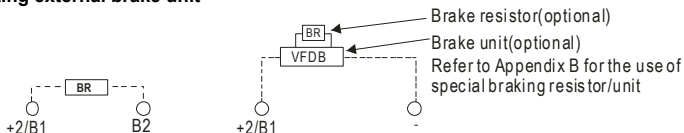

- Connect a brake resistor or brake unit in applications with frequent deceleration ramps, short deceleration time, too low brake torque or requiring increased brake torque.
- If the AC motor drive has a built-in brake chopper (all models of 11kW and below), connect the external brake resistor to the terminals [+2/B1, B2].
- Models of 15kW and above don't have a built-in brake chopper. Please connect an external optional brake unit (VFDB-series) and brake resistor. Refer to VFDB series user manual for details.
- Connect the terminals [(P), -(N)] of the brake unit to the AC motor drive terminals [+2(+2/B1), (-)]. The length of wiring should be less than 5m with twisted cable.
- When not used, please leave the terminals [+2/B1, -] open.



WARNING!

1. Short-circuiting [B2] or [-] to [+2/B1] can damage the AC motor drive.

Grounding terminals (⊕)

- Make sure that the leads are connected correctly and the AC drive is properly grounded. (Ground resistance should not exceed 0.1Ω.)
- Use ground leads that comply with local regulations and keep them as short as possible.
- Multiple VFD-VE units can be installed in one location. All the units should be grounded directly to a common ground terminal, as shown in the figure below. **Ensure there are no ground loops.**

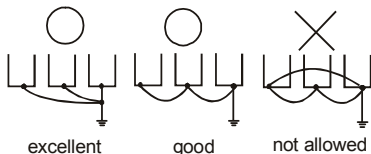

2.3.2 Main Circuit Terminals

Frame B

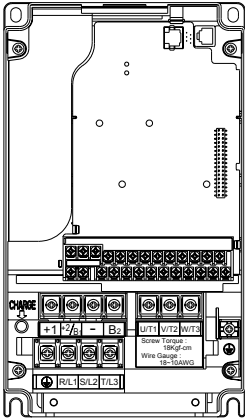

Main circuit terminals

R/L1, S/L2, T/L3, U/T1, V/T2, W/T3, \oplus , +1, +2/B1, -, B2

Models	Wire	Torque	Wire Type
VFD007V23A-2	14-10 AWG (2.1-5.3mm ²)	18kgf-cm (15.6in-lbf)	Stranded copper only, 75°C
VFD007V43A-2			
VFD015V23A-2			
VFD015V43A-2			
VFD022V23A-2			
VFD022V43A-2			
VFD037V23A-2			
VFD037V43A-2			

Frame C

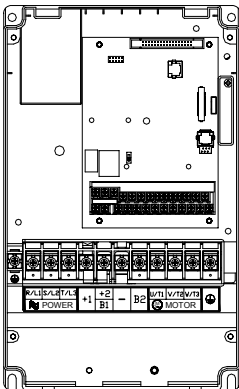

Main circuit terminals

R/L1, S/L2, T/L3, U/T1, V/T2, W/T3, \oplus , +1, +2/B1, -, B2

Models	Wire	Torque	Wire Type
VFD055V23A-2	12-8 AWG (3.3-8.4mm ²)	30kgf-cm (26in-lbf)	Stranded copper only, 75°C
VFD075V23A-2			
VFD110V43B-2			
VFD055V43A-2			
VFD075V43A-2			

Frame D

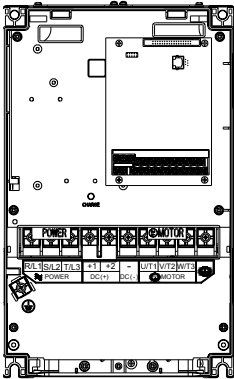

Main circuit terminals

R/L1, S/L2, T/L3, U/T1, V/T2, W/T3, \oplus , +1, +2, -

Models	Wire	Torque	Wire Type
VFD110V23A-2	8-2 AWG (8.4-33.6mm ²)	30kgf-cm (26in-lbf)	Stranded copper only, 75 °C
VFD110V43A-2			
VFD150V43A-2			
VFD150V23A-2			
VFD185V23A-2			
VFD185V43A-2			
VFD220V43A-2			
VFD220V23A-2			

Frame E

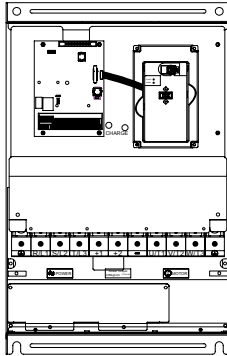

Main circuit terminals

R/L1, S/L2, T/L3, U/T1, V/T2, W/T3, \oplus , +1, +2, -

Models	Wire	Torque	Wire Type
VFD300V43A-2	4-2 AWG (21.2-33.6mm ²)	57kgf-cm (49in-lbf)	Stranded copper only, 75 °C
VFD370V43A-2			
VFD450V43A-2		200kgf-cm (173in-lbf)	
VFD300V23A-2			
VFD370V23A-2			
VFD550V43C-2			
VFD750V43C-2			

NOTE

To connect 6 AWG (13.3 mm²) wires, use Recognized Ring Terminals

2.4 Control Terminals

Circuit diagram for digital inputs (SINK current 16mA.)

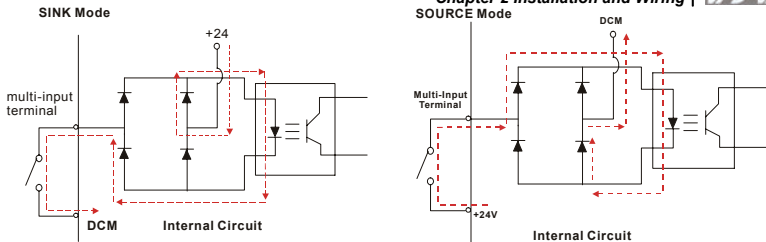

The Position of the Control Terminals

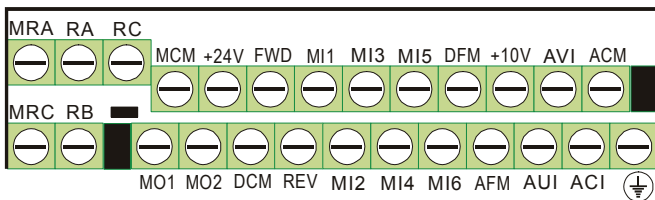

Terminal symbols and functions

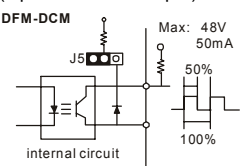
Terminal Symbol	Terminal Function	Factory Settings (SINK) ON: Connect to DCM
FWD	Forward-Stop Command	ON: Run in FWD direction OFF: Stop acc. to Stop Method
REV	Reverse-Stop Command	ON: Run in REV direction OFF: Stop acc. to Stop Method
+24V	DC Voltage Source	+24VDC, 80mA, used for SOURCE mode.
MI1	Multi-function Input 1	Refer to Pr.02-01 to Pr.02-06 for programming the Multi-function Inputs. ON: the activation current is 6.5mA. OFF: leakage current tolerance is 10 μ A.
MI2	Multi-function Input 2	
MI3	Multi-function Input 3	
MI4	Multi-function Input 4	
MI5	Multi-function Input 5	
MI6	Multi-function Input 6	
DFM	Digital Frequency Meter (Open Collector Output)  DFM-DCM	Pulse voltage output monitor signal, proportional to output frequency Duty-cycle: 50% Ratio: Pr.02-18 Min. load: 4.7k Ω Max. current: 50mA Max. voltage: 48Vdc Jumper: DFM jumper, factory setting is OC
DCM	Digital Signal Common	Common for digital inputs and used for SINK mode.
RA	Multi-function Relay Output 1 (N.O.) a	Resistive Load: 5A(N.O.)/3A(N.C.) 240VAC 5A(N.O.)/3A(N.C.) 24VDC Inductive Load: 1.5A(N.O.)/0.5A(N.C.) 240VAC 1.5A(N.O.)/0.5A(N.C.) 24VDC To output monitor signal, including in operation, frequency arrival, overload and etc. Refer to Pr.02-11~02-12 for programming
RB	Multi-function Relay Output 1 (N.C.) b	
RC	Multi-function Relay Common	
MRA	Multi-function Relay Output 2 (N.O.) a	
MRC	Multi-function Relay Common	

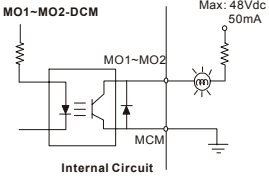
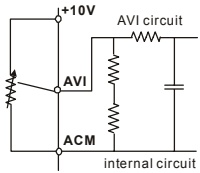
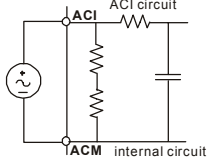
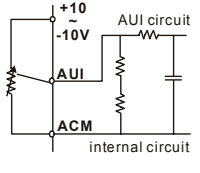
Terminal Symbol	Terminal Function	Factory Settings (SINK) ON: Connect to DCM
+10V	Potentiometer Power Supply	+10VDC 20mA (variable resistor 3-5kohm)
MCM	Multi-function Output Common (Photocoupler)	Max. 48VDC 50mA
MO1	Multi-function Output 1 (Photocoupler)	Maximum 48VDC, 50mA Refer to Pr.02-13 to Pr.02-14 for programming
MO2	Multi-function Output 2 (Photocoupler)	
AVI	Analog voltage Input 	Impedance: 200kΩ Resolution: 12 bits Range: 0 ~ 10VDC = 0 ~ Max. Output Frequency (Pr.01-00) Set-up: Pr.03-00 ~ Pr.03-02
ACI	Analog current Input 	Impedance: 250Ω Resolution: 12 bits Range: 4 ~ 20mA/0~10V = 0 ~ Max. Output Frequency (Pr.01-00) Set-up: Pr.03-00 ~ Pr.03-02 Jumper: ACI jumper, factory setting is 4-20mA
AUI	Auxiliary analog voltage input 	Impedance: 200kΩ Resolution: 12 bits Range: -10 ~ +10VDC = 0 ~ Max. Output Frequency (Pr.01-00) Set-up: Pr.03-00 ~ Pr.03-02

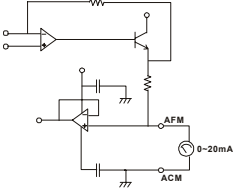
Terminal Symbol	Terminal Function	Factory Settings (SINK) ON: Connect to DCM
AFM	Analog output meter 	Impedance: 18.5k Ω (voltage output) 1.1m Ω (current output) Output current: 20mA max Resolution: max. frequency corresponds to 0-10V Range: 0 ~ 10V/0 ~ 20mA Function: Pr.03-18 Switch: AFM switch, factory setting is 0-10V
ACM	Analog control signal (common)	Common for AVI, ACI, AUI, AFM

*Control signal wiring size: 18 AWG (0.75 mm²) with shielded wire.

Analog input terminals (AVI, ACI, AUI, ACM)

- Analog input signals are easily affected by external noise. Use shielded wiring and keep it as short as possible (<20m) with proper grounding. If the noise is inductive, connecting the shield to terminal ACM can bring improvement.
- If the analog input signals are affected by noise from the AC motor drive, please connect a capacitor and ferrite core as indicated in the following diagrams:

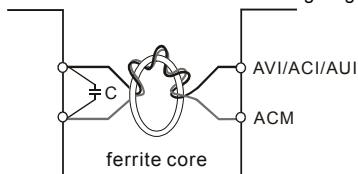

wind each wires 3 times or more around the core

Digital inputs (FWD, REV, MI1~MI6, DCM)

- When using contacts or switches to control the digital inputs, please use high quality components to avoid contact bounce.

Digital outputs (MO1, MO2, MCM)

- Make sure to connect the digital outputs to the right polarity, see wiring diagrams.
- When connecting a relay to the digital outputs, connect a surge absorber or fly-back diode across the coil and check the polarity.

General

- Keep control wiring as far as possible from the power wiring and in separate conduits to avoid interference. If necessary let them cross only at 90° angle.
- The AC motor drive control wiring should be properly installed and not touch any live power wiring or terminals.

NOTE

- If a filter is required for reducing EMI (Electro Magnetic Interference), install it as close as possible to AC drive. EMI can also be reduced by lowering the Carrier Frequency.
- When using a GFCI (Ground Fault Circuit Interrupter), select a current sensor with sensitivity of 200mA, and not less than 0.1-second detection time to avoid nuisance tripping.

**DANGER!**

Damaged insulation of wiring may cause personal injury or damage to circuits/equipment if it comes in contact with high voltage.

The specification for the control terminals

The Position of the Control Terminals

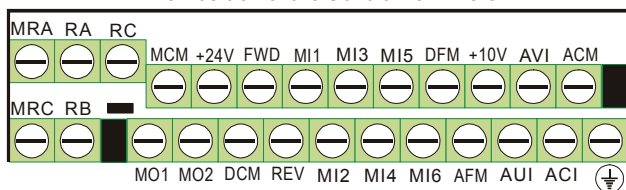

Frame	Torque	Wire
B, C, D, E, E1	8 kgf-cm (6.9 in-lbf)	22-14 AWG (0.3-2.1mm ²)

NOTE

Frame B: VFD007V23A/43A-2, VFD015V23A/43A-2, VFD022V23A/43A-2, VFD037V23A/43A-2;

Frame C: VFD055V23A/43A-2, VFD075V23A/43A-2, VFD110V43B-2,

Frame D: VFD110V23A/43A-2, VFD150V23A/43A-2, VFD185V23A/43A-2, VFD220V23A/43A-2

Frame E: VFD300V43A-2, VFD370V43A-2, VFD450V43A-2

Frame E1: VFD300V23A-2, VFD370V23A-2, VFD550V43C-2, VFD750V43C-2







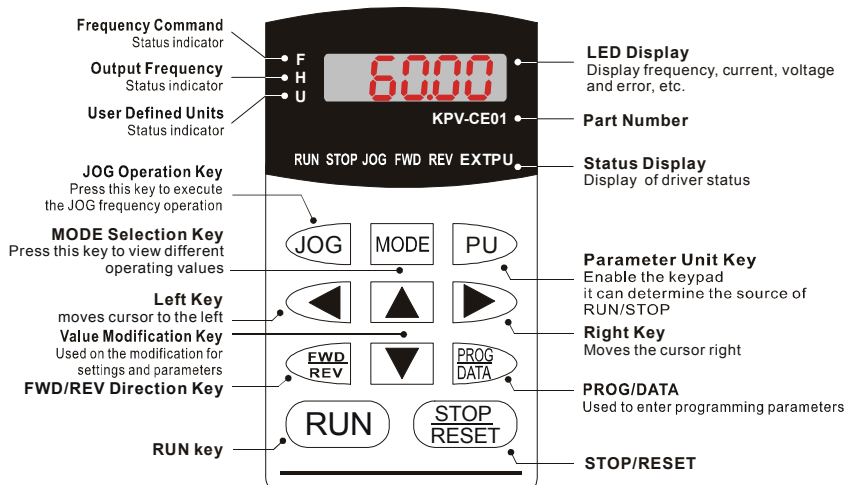

Chapter 3 Digital Keypad Operation and Start Up

3.1 Digital Keypad KPV-CE01

3.1.1 Description of the Digital Keypad KPV-CE01



Display Message	Descriptions
	Displays the AC drive Master Frequency.
	Displays the actual output frequency present at terminals U/T1, V/T2, and W/T3.
	User defined unit (where $U = F \times Pr.00-05$)
	Displays the output current present at terminals U/T1, V/T2, and W/T3.
	The counter value (C).

Display Message	Descriptions
	Displays the selected parameter.
	Displays the actual stored value of the selected parameter.
	External Fault.
	Display "End" for approximately 1 second if input has been accepted by pressing  key. After a parameter value has been set, the new value is automatically stored in memory. To modify an entry, use the  ,  and  keys.
	Display "Err", if the input is invalid.

3.1.2 How to Operate the Digital Keypad KPV-CE01

Selection mode

START



NOTE: In the selection mode, press to set the parameters.

To set parameters

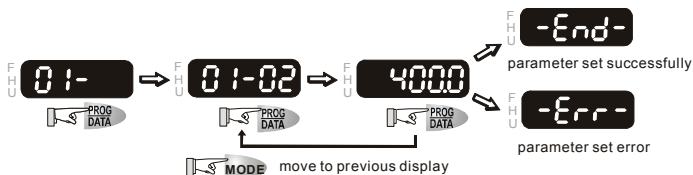

NOTE: In the parameter setting mode, you can press to return to the selection mode.

To shift cursor

START



To modify data

START



To switch display mode

START

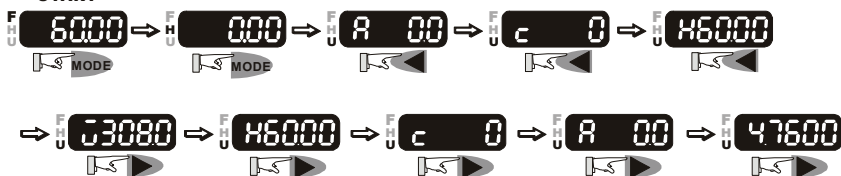

To copy parameters 1

Copy parameters from the AC Motor Drive to the KPV-CE01

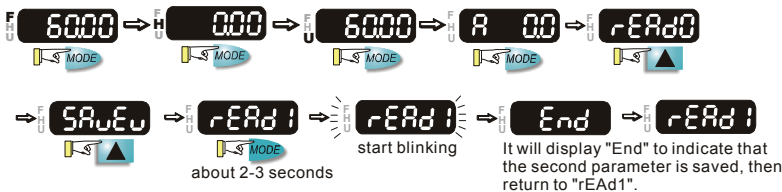
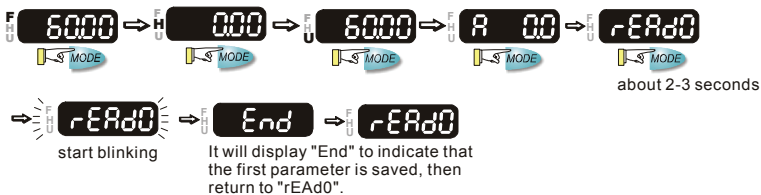

To copy parameters 2

Copy parameters from the KPV-CE01 to the AC Motor Drive

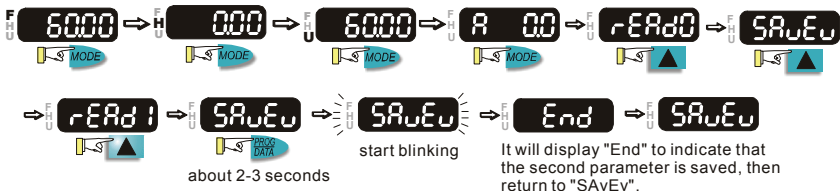
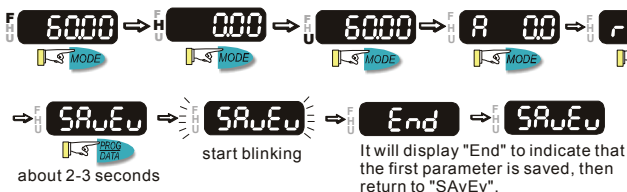

3.1.3 Dimension of the Digital Keypad

Unit: mm [inch]

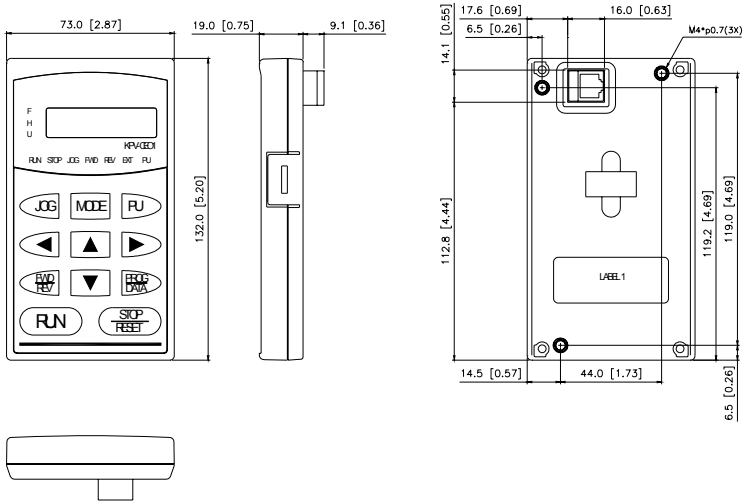

3.1.4 Reference Table for the LCD Display of the Digital Keypad

Digital	0	1	2	3	4	5	6	7	8	9
LCD	0	1	2	3	4	5	6	7	8	9







English alphabet	A	b	Cc	d	E	F	G	Hh	I	Jj
LCD	A	b	Cc	d	E	F	G	Hh	I	Jj

English alphabet	K	L	n	Oo	P	q	r	S	Tt	U
LCD	K	L	n	Oo	P	q	r	S	Tt	U

English alphabet	v	Y	Z							
LCD	v	Y	Z							

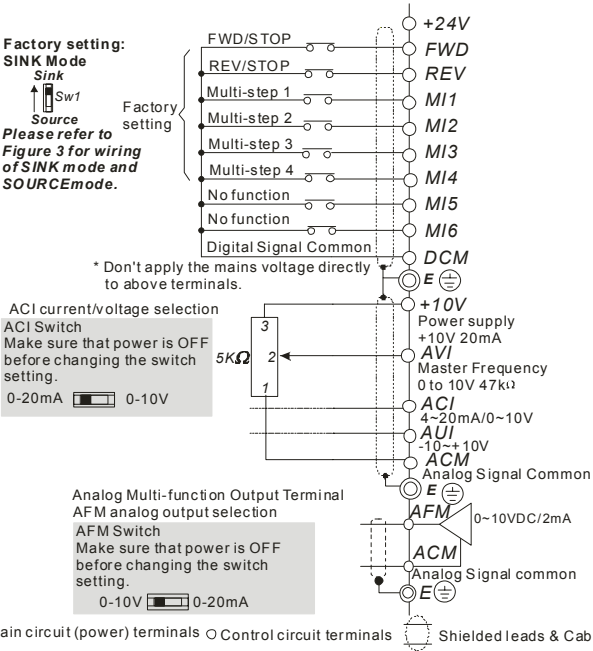
3.1.5 Operation Method

Refer to 3.1.2 How to operate the digital keypad KPV-CE01 and chapter 4 parameters for setting. Please choose a suitable method depending on application and operation rule. The operation is usually used as shown in the following table.

Operation Method	Frequency Source	Operation Command Source
KPV-CE01 keypad		
Operate from external signal	<p>Factory setting: SINK Mode Sink Source Sw1</p> <p>Please refer to Figure 3 for wiring of SINK mode and SOURCE mode.</p>  <p>* Don't apply the mains voltage directly to above terminals.</p> <p>ACI current/voltage selection ACI Switch Make sure that power is OFF before changing the switch setting. 0-20mA  0-10V</p> <p>Analog Multi-function Output Terminal AFM analog output selection AFM Switch Make sure that power is OFF before changing the switch setting. 0-10V  0-20mA</p> <p>Legend: ● Main circuit (power) terminals ○ Control circuit terminals  Shielded leads & Cable </p>	
Operate from communication	Please refer to the communication address 2000H and 2119H settings in the communication address definition.	

3.2 Start-up

3.2.1 Preparations before Start-up

Carefully check the following items before proceeding.



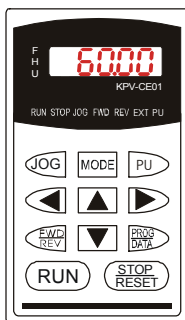

- Make sure that the wiring is correct. In particular, check that the output terminals U, V, W. are NOT connected to power and that the drive is well grounded.
- Verify that there are no short-circuits between terminals and from terminals to ground or mains power.
- Check for loose terminals, connectors or screws.
- Verify that no other equipment is connected to the AC motor
- Make sure that all switches are OFF before applying power to ensure that the AC motor drive doesn't start running and there is no abnormal operation after applying power.
- Make sure that the front cover is well installed before applying power.
- Do NOT operate the AC motor drive with humid hands.
- The keypad shows briefly "Delta" and then should light up as follows (normal status with no error)



- If the drive has built-in fan (2hp/1.5kW and above) it should run. The factory setting of Fan Control Pr.07-19=00 (Fan always on).

3.2.2 Trial Run

After finishing checking the items in “3.2.1 preparation before start-up”, you can perform a trial run. The factory setting of operation source is from keypad (Pr.00-20=0).

- After applying power, verify that LED “F” is on and the display shows 60.00Hz.
- Setting frequency to about 5Hz by using  key.
- Pressing  key for forward running. And if you want to change to reverse running, you should press  key. The LED will display the status. And if you want to decelerate to stop, please press  key.
- Check following items:
 - Check if the motor direction of rotation is correct.
 - Check if the motor runs steadily without abnormal noise and vibration.
 - Check if acceleration and deceleration are smooth.

If the results of trial run are normal, please start formal run.

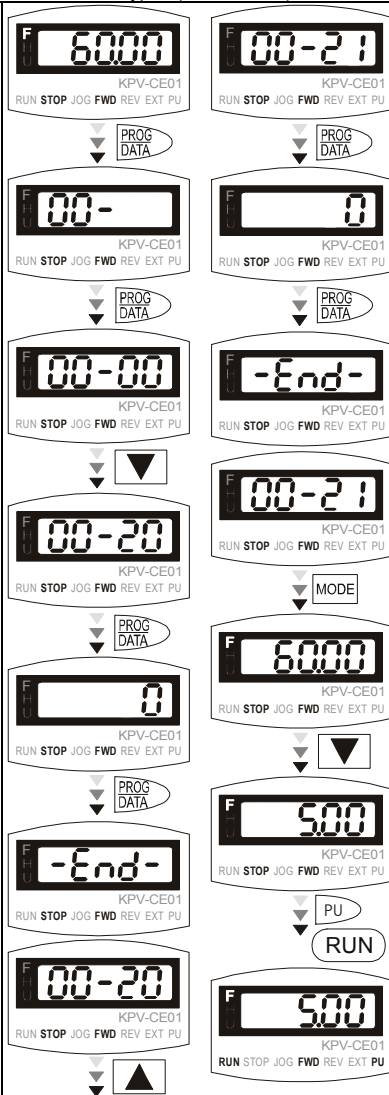

**NOTE**

1. Please stop running immediately if any fault occurs and refer to troubleshooting for solving the problem.
2. Please do NOT touch output terminals U, V, W when power is still applied to L1/R, L2/S, L3/T even when the AC motor drive has stopped. The DC-link capacitors may still be charged to hazardous voltage levels, even if the power has been turned off.
3. To avoid damage to components, do not touch them or the circuit boards with metal objects or your bare hands.

This page intentionally left blank.

Chapter 4 Parameters

The VFD-VE parameters are divided into 12 groups by property for easy setting. In most applications, the user can finish all parameter settings before start-up without the need for re-adjustment during operation.

The 12 groups are as follows:

- Group 0: System Parameters
- Group 1: Basic Parameters
- Group 2: Digital Input/Output Parameters
- Group 3: Analog Input/Output Parameters
- Group 4: Multi-Step Speed Parameters
- Group 5: Motor Parameters
- Group 6: Protection Parameters
- Group 7: Special Parameters
- Group 8: High-function PID Parameters
- Group 9: Communication Parameters
- Group 10: Speed Feedback Control Parameters
- Group 11: Advanced Parameters

4.1 Summary of Parameter Settings

↗: The parameter can be set during operation.

Group 0 System Parameters

Pr.	Explanation	Settings	Factory Setting	VF	VFPG	SVC	FOCPG	TQRPG
00-00	Identity Code of the AC motor drive	Read-only	0	○	○	○	○	○
00-01	Rated Current Display of the AC motor drive	Read-only	0	○	○	○	○	○
00-02	Parameter Reset	0: No function 1: Read only 2: Enable group 11 parameters setting 8: Keypad lock 9: All parameters are reset to factory settings (50Hz, 220V/380V) 10: All parameters are reset to factory settings (60Hz, 220V/440V)	0	○	○	○	○	○
↗00-03	Start-up Display Selection	0: Display the frequency command value (LED F) 1: Display the actual output frequency (LED H) 2: Multifunction display, see Pr.00-04 (LED U) 3: Display the output current (A)	0	○	○	○	○	○
↗00-04	Content of Multi Function Display	0: Display output current (A) 1: Display counter value (C) 2: Display output frequency (H) 3: Display DC-BUS voltage (↗) 4: Display output voltage (E) 5: Output power factor angle (n) 6: Display output power (kW) 7: Display actual motor speed (HU) 8: Display estimate output torque (kg-m) 9: Display PG position (G) (refer to Pr.10-00 and Pr.10-01) 10: Display PID feedback 11: Display AVI (%) 12: Display ACI (%) 13: Display AUI (%) 14: Display the temperature of heat sink (°C) 15: Display the temperature of IGBT (°C) 16: The status of digital input (ON/OFF) 17: The status of digital output (ON/OFF) 18: Multi-step speed 19: The corresponding CPU pin status of digital input 20: The corresponding CPU pin status of digital output 21: Number of actual motor revolution (PG1 of PG card) 22: Pulse input frequency (PG2 of PG card) 23: Pulse input position (PG2 of PG card)	0	○	○	○	○	○
↗00-05	User-Defined Coefficient K	Digit 4: decimal point number (0 to 3) Digit 0-3: 40 to 9999	0	○	○	○	○	○
00-06	Software Version	Read-only	##	○	○	○	○	○
↗00-07	Password Input	1 to 9998 and 10000 to 65535 0 to 2: times of wrong password	0	○	○	○	○	○
↗00-08	Password Set	1 to 9998 and 10000 to 65535 0: No password set or successful input in Pr.00-07 1: Password has been set	0	○	○	○	○	○
↗00-09	Energy Saving Gain	10~1000 %	100%				○	
00-10	Control Method	0: V/f Control 1: V/f Control + Encoder (VFPG) 2: Sensorless vector control (SVC) 3: FOC vector control + Encoder (FOCPG) 4: Torque control + Encoder (TQRPG)	0	○	○	○	○	○
00-11	V/f Curve Selection	0: V/f curve determined by group 01 1: 1.5 power curve 2: Square curve	0	○	○			
↗00-12	Constant/Variable Torque Selection	0: Constant Torque (100%) 1: Variable Torque (125%)	0	○	○	○	○	
↗00-13	Optimal Acceleration/Deceleration Setting	0: Linear accel./decel. I 1: Auto accel., linear decel. 2: Linear accel., auto decel. 3: Auto accel./decel.	0	○	○	○	○	

Pr.	Explanation	Settings	Factory Setting	VF	VFP	SVC	FOCPG	TQRP
		4: Stall prevention by auto accel./decel. (limited by 01-12 to 01-21)						
00-14	Time Unit for Acceleration/Deceleration and S Curve	0: Unit: 0.01 second 1: Unit: 0.1 second	0	○	○	○	○	
00-15	Reserved							
00-16	Reserved							
≠00-17	Carrier Frequency	1~15KHz	10	○	○	○	○	○
≠00-18	Auto Voltage Regulation (AVR) Function	0: Enable AVR 1: Disable AVR 2: Disable AVR when deceleration stop	0	○	○	○	○	○
≠00-19	Auto Energy-saving Operation	0: Disable 1: Enable	0	○	○	○	○	
≠00-20	Source of the Master Frequency Command	0: Digital keypad (KPV-CE01) 1: RS-485 serial communication 2: External analog input (Pr. 03-00) 3: External UP/DOWN terminal 4: Pulse input without direction command (Pr.10-15 without direction) 5: Pulse input with direction command (Pr.10-15)	0	○	○	○	○	
≠00-21	Source of the Operation Command	0: Digital keypad (KPV-CE01) 1: External terminals. Keypad STOP disabled. 2: RS-485 serial communication (RJ-11). Keypad STOP disabled.	0	○	○	○	○	○
≠00-22	Stop Method	0: Ramp to stop 1: Coast to stop	0	○	○	○	○	○
≠00-23	Reverse Operation	0: Enable reverse 1: Disable reverse 2: Disable forward	0	○	○	○	○	○

Group 1 Basic Parameters

Pr.	Explanation	Settings	Factory Setting	VF	VFPG	SVC	FOCPG	TQRPG
01-00	Maximum Output Frequency	50.00~600.00Hz	60.00/ 50.00	○	○	○	○	○
01-01	1st Output Frequency Setting 1	0.00~600.00Hz	60.00/ 50.00	○	○	○	○	○
01-02	1st Output Voltage Setting 1	230V: 0.1V~255.0V 460V: 0.1V~510.0V	220.0 440.0	○	○	○	○	○
01-03	2nd Output Frequency Setting 1	0.00~600.00Hz	0.50	○	○			
01-04	2nd Output Voltage Setting 1	230V: 0.1V~255.0V 460V: 0.1V~510.0V	5.0 10.0	○	○			
01-05	3rd Output Frequency Setting 1	0.00~600.00Hz	0.50	○	○			
01-06	3rd Output Voltage Setting 1	230V: 0.1V~255.0V 460V: 0.1V~510.0V	5.0 10.0	○	○			
01-07	4th Output Frequency Setting 1	0.00~600.00Hz	0.00	○	○	○	○	
01-08	4th Output Voltage Setting 1	230V: 0.1V~255.0V 460V: 0.1V~510.0V	0.0 0.0	○	○	○	○	
01-09	Start Frequency	0.00~600.00Hz	0.50	○	○	○	○	
01-10	Output Frequency Upper Limit	0.00~600.00Hz	600.00	○	○	○	○	
01-11	Output Frequency Lower Limit	0.00~600.00Hz	0.00	○	○	○	○	
01-12	Accel Time 1	0.00~600.00 sec/0.00~6000.0 sec	10.00/ 10.0	○	○	○	○	
01-13	Decel Time 1	0.00~600.00 sec/0.00~6000.0 sec	10.00/ 10.0	○	○	○	○	
01-14	Accel Time 2	0.00~600.00 sec/0.00~6000.0 sec	10.00/ 10.0	○	○	○	○	
01-15	Decel Time 2	0.00~600.00 sec/0.00~6000.0 sec	10.00/ 10.0	○	○	○	○	
01-16	Accel Time 3	0.00~600.00 sec/0.00~6000.0 sec	10.00/ 10.0	○	○	○	○	
01-17	Decel Time 3	0.00~600.00 sec/0.00~6000.0 sec	10.00/ 10.0	○	○	○	○	
01-18	Accel Time 4	0.00~600.00 sec/0.00~6000.0 sec	10.00/ 10.0	○	○	○	○	
01-19	Decel Time 4	0.00~600.00 sec/0.00~6000.0 sec	10.00/ 10.0	○	○	○	○	
01-20	JOG Acceleration Time	0.00~600.00 sec/0.00~6000.0 sec	1.00/ 1.0	○	○	○	○	
01-21	JOG Deceleration Time	0.00~600.00 sec/0.00~6000.0 sec	1.00/ 1.0	○	○	○	○	
01-22	JOG Frequency	0.00~600.00Hz	6.00	○	○	○	○	○
01-23	1st/4th Accel/decel Frequency	0.00~600.00Hz	0.00	○	○	○	○	
01-24	S-curve for Acceleration Departure Time 1	0.00~25.00 sec/0.00~250.0 sec	0.2/0.0	○	○	○	○	
01-25	S-curve for Acceleration Arrival Time 2	0.00~25.00 sec /0.00~250.0 sec	0.2/0.0	○	○	○	○	
01-26	S-curve for Deceleration Departure Time 1	0.00~25.00 sec /0.00~250.0 sec	0.2/0.0	○	○	○	○	
01-27	S-curve for Deceleration Arrival Time 2	0.00~25.00 sec /0.00~250.0 sec	0.2/0.0	○	○	○	○	
01-28	Skip Frequency 1 (upper limit)	0.00~600.00Hz	0.00	○	○	○	○	
01-29	Skip Frequency 1 (lower limit)	0.00~600.00Hz	0.00	○	○	○	○	
01-30	Skip Frequency 2 (upper limit)	0.00~600.00Hz	0.00	○	○	○	○	
01-31	Skip Frequency 2 (lower limit)	0.00~600.00Hz	0.00	○	○	○	○	
01-32	Skip Frequency 3 (upper limit)	0.00~600.00Hz	0.00	○	○	○	○	
01-33	Skip Frequency 3 (lower limit)	0.00~600.00Hz	0.00	○	○	○	○	
01-34	Mode Selection when Frequency < Fmin	0: Output Waiting 1: Zero-speed operation 2: Fmin (4th output frequency setting)	0	○	○	○	○	
01-35	1st Output Frequency	0.00~600.00Hz	60.00/	○	○	○	○	○

Pr.	Explanation	Settings	Factory Setting	VF	VFPG	SVC	FOCPG	TQRPg
	Setting 2		50.00					
01-36	1st Output Voltage	230V: 0.1V~255.0V	220.0	<input type="radio"/>	<input type="radio"/>	<input type="radio"/>	<input type="radio"/>	<input type="radio"/>
	Setting 2	460V: 0.1V~510.0V	440.0					
01-37	2nd Output Frequency	0.00~600.00Hz	0.50	<input type="radio"/>	<input type="radio"/>			
	Setting 2							
/01-38	2nd Output Voltage	230V: 0.1V~255.0V	5.0/	<input type="radio"/>	<input type="radio"/>			
	Setting 2	460V: 0.1V~510.0V	10.0					
01-39	3rd Output Frequency	0.00~600.00Hz	0.50	<input type="radio"/>	<input type="radio"/>			
	Setting 2							
/01-40	3rd Output Voltage	230V: 0.1V~255.0V	5.0/	<input type="radio"/>	<input type="radio"/>			
	Setting 2	460V: 0.1V~510.0V	10.0					
01-41	4th Output Frequency	0.00~600.00Hz	0.00	<input type="radio"/>	<input type="radio"/>	<input type="radio"/>	<input type="radio"/>	<input type="radio"/>
	Setting 2							
/01-42	4th Output Voltage	230V: 0.1V~255.0V	0.0/	<input type="radio"/>	<input type="radio"/>			
	Setting 2	460V: 0.1V~510.0V	0.0					

Group 2 Digital Input/Output Parameters

Pr.	Explanation	Settings	Factory Setting	VF	VFPG	SVC	FOCPG	TQRPg
02-00	2-wire/3-wire Operation Control	0: FWD/STOP, REV/STOP 1: FWD/STOP, REV/STOP (Line Start Lockout) 2: RUN/STOP, REV/FWD 3: RUN/STOP, REV/FWD (Line Start Lockout) 4: 3-wire (momentary push button) 5: 3-wire (momentary push button and Line Start Lockout)	0	<input type="checkbox"/>	<input type="checkbox"/>	<input type="checkbox"/>	<input type="checkbox"/>	<input type="checkbox"/>
02-01	Multi-Function Input Command 1 (MI1) (it is Stop terminal for 3-wire operation)	0: no function	1	<input type="checkbox"/>	<input type="checkbox"/>	<input type="checkbox"/>	<input type="checkbox"/>	<input type="checkbox"/>
		1: multi-step speed command 1/multi-step position command 1		<input type="checkbox"/>	<input type="checkbox"/>	<input type="checkbox"/>	<input type="checkbox"/>	
02-02	Multi-Function Input Command 2 (MI2)	2: multi-step speed command 2/ multi-step position command 2	2	<input type="checkbox"/>	<input type="checkbox"/>	<input type="checkbox"/>	<input type="checkbox"/>	
		3: multi-step speed command 3/ multi-step position command 3		<input type="checkbox"/>	<input type="checkbox"/>	<input type="checkbox"/>	<input type="checkbox"/>	
02-03	Multi-Function Input Command 3 (MI3)	4: multi-step speed command 4/ multi-step position command 4	3	<input type="checkbox"/>	<input type="checkbox"/>	<input type="checkbox"/>	<input type="checkbox"/>	<input type="checkbox"/>
		5: Reset		<input type="checkbox"/>	<input type="checkbox"/>	<input type="checkbox"/>	<input type="checkbox"/>	
02-04	Multi-Function Input Command 4 (MI4)	6: JOG command	4	<input type="checkbox"/>	<input type="checkbox"/>	<input type="checkbox"/>	<input type="checkbox"/>	
		7: acceleration/deceleration speed inhibit		<input type="checkbox"/>	<input type="checkbox"/>	<input type="checkbox"/>	<input type="checkbox"/>	
02-05	Multi-Function Input Command 5 (MI5)	8: the 1st, 2nd acceleration/deceleration time selection	0	<input type="checkbox"/>	<input type="checkbox"/>	<input type="checkbox"/>	<input type="checkbox"/>	
		9: the 3rd, 4th acceleration/deceleration time selection		<input type="checkbox"/>	<input type="checkbox"/>	<input type="checkbox"/>	<input type="checkbox"/>	
02-06	Multi-Function Input Command 6 (MI6) (specific terminal for TRG)	10: EF input (07-36)	0	<input type="checkbox"/>	<input type="checkbox"/>	<input type="checkbox"/>	<input type="checkbox"/>	<input type="checkbox"/>
		11: B.B. input		<input type="checkbox"/>	<input type="checkbox"/>	<input type="checkbox"/>	<input type="checkbox"/>	<input type="checkbox"/>
02-23	Multi-Function Input Command 7	12: Output stop	0	<input type="checkbox"/>	<input type="checkbox"/>	<input type="checkbox"/>	<input type="checkbox"/>	<input type="checkbox"/>
02-24	Multi-Function Input Command 8	13: cancel the setting of the optimal acceleration/deceleration time	0	<input type="checkbox"/>	<input type="checkbox"/>	<input type="checkbox"/>	<input type="checkbox"/>	
02-25	Multi-Function Input Command 9	14: switch between drive settings 1 and 2	0	<input type="checkbox"/>	<input type="checkbox"/>	<input type="checkbox"/>	<input type="checkbox"/>	
02-26	Multi-Function Input Command 10	15: operation speed command form AVI	0	<input type="checkbox"/>	<input type="checkbox"/>	<input type="checkbox"/>	<input type="checkbox"/>	
02-27	Multi-Function Input Command 11	16: operation speed command form ACI	0	<input type="checkbox"/>	<input type="checkbox"/>	<input type="checkbox"/>	<input type="checkbox"/>	
02-28	Multi-Function Input Command 12	17: operation speed command form AUI	0	<input type="checkbox"/>	<input type="checkbox"/>	<input type="checkbox"/>	<input type="checkbox"/>	
02-29	Multi-Function Input Command 13	18: Emergency Stop (07-36)	0	<input type="checkbox"/>	<input type="checkbox"/>	<input type="checkbox"/>	<input type="checkbox"/>	<input type="checkbox"/>
02-30	Multi-Function Input Command 14	19: Digital Up command	0	<input type="checkbox"/>	<input type="checkbox"/>	<input type="checkbox"/>	<input type="checkbox"/>	
		20: Digital Down command		<input type="checkbox"/>	<input type="checkbox"/>	<input type="checkbox"/>	<input type="checkbox"/>	
		21: PID function disabled		<input type="checkbox"/>	<input type="checkbox"/>	<input type="checkbox"/>	<input type="checkbox"/>	
		22: clear counter		<input type="checkbox"/>	<input type="checkbox"/>	<input type="checkbox"/>	<input type="checkbox"/>	<input type="checkbox"/>
		23: input the counter value (multi-function input command 6)		<input type="checkbox"/>	<input type="checkbox"/>	<input type="checkbox"/>	<input type="checkbox"/>	<input type="checkbox"/>
		24: FWD JOG command		<input type="checkbox"/>	<input type="checkbox"/>	<input type="checkbox"/>	<input type="checkbox"/>	
		25: REV JOG command		<input type="checkbox"/>	<input type="checkbox"/>	<input type="checkbox"/>	<input type="checkbox"/>	
		26: TQC+PG/FOC+PG model selection		<input type="checkbox"/>	<input type="checkbox"/>	<input type="checkbox"/>	<input type="checkbox"/>	<input type="checkbox"/>
		27: ASR1/ASR2 selection		<input type="checkbox"/>	<input type="checkbox"/>	<input type="checkbox"/>	<input type="checkbox"/>	
		28: Emergency stop (EF1)		<input type="checkbox"/>	<input type="checkbox"/>	<input type="checkbox"/>	<input type="checkbox"/>	<input type="checkbox"/>
		29: Signal confirmation for Y-connection		<input type="checkbox"/>	<input type="checkbox"/>	<input type="checkbox"/>	<input type="checkbox"/>	<input type="checkbox"/>
		30: Signal confirmation for Δ-connection		<input type="checkbox"/>	<input type="checkbox"/>	<input type="checkbox"/>	<input type="checkbox"/>	<input type="checkbox"/>
		31: High torque bias (by Pr.07-29)		<input type="checkbox"/>	<input type="checkbox"/>	<input type="checkbox"/>	<input type="checkbox"/>	<input type="checkbox"/>
		32: Middle torque bias (by Pr.07-30)		<input type="checkbox"/>	<input type="checkbox"/>	<input type="checkbox"/>	<input type="checkbox"/>	<input type="checkbox"/>
		33: Low torque bias (by Pr.07-31)		<input type="checkbox"/>	<input type="checkbox"/>	<input type="checkbox"/>	<input type="checkbox"/>	<input type="checkbox"/>
		34: Enable multi-step position control		<input type="checkbox"/>	<input type="checkbox"/>	<input type="checkbox"/>	<input type="checkbox"/>	
		35: Enable position control		<input type="checkbox"/>	<input type="checkbox"/>	<input type="checkbox"/>	<input type="checkbox"/>	
		36: Enable position learning function (valid at stop)		<input type="checkbox"/>	<input type="checkbox"/>	<input type="checkbox"/>	<input type="checkbox"/>	
		37: Enable pulse position input command		<input type="checkbox"/>	<input type="checkbox"/>	<input type="checkbox"/>	<input type="checkbox"/>	
		38: Disable write EEPROM function		<input type="checkbox"/>	<input type="checkbox"/>	<input type="checkbox"/>	<input type="checkbox"/>	<input type="checkbox"/>
39: Torque command direction	<input type="checkbox"/>	<input type="checkbox"/>	<input type="checkbox"/>	<input type="checkbox"/>	<input type="checkbox"/>			
40: Force stop	<input type="checkbox"/>	<input type="checkbox"/>	<input type="checkbox"/>	<input type="checkbox"/>	<input type="checkbox"/>			
41: Serial position clock	<input type="checkbox"/>	<input type="checkbox"/>	<input type="checkbox"/>	<input type="checkbox"/>	<input type="checkbox"/>			
42: Serial position input	<input type="checkbox"/>	<input type="checkbox"/>	<input type="checkbox"/>	<input type="checkbox"/>	<input type="checkbox"/>			
43: Analog input resolution selection	<input type="checkbox"/>	<input type="checkbox"/>	<input type="checkbox"/>	<input type="checkbox"/>	<input type="checkbox"/>			

Pr.	Explanation	Settings	Factory Setting	VF	VFPF	SVC	FOCPG	TQRP
		44: Reset initial reel diameter		○	○	○	○	○
		45: Reset initial reel diameter 0		○	○	○	○	○
		46: Reset initial reel diameter 1		○	○	○	○	○
		47: Reset PID control integration of tension		○	○	○	○	○
		48: Mechanical gear ratio switch		○			○	○
		49: Reserved						
		50: Reserved						
↗02-07	UP/DOWN Key Mode	0: up/down by the accel/decel time 1: up/down constant speed (Pr.02-08)	0	○	○	○	○	○
↗02-08	The Acceleration/Deceleration Speed of the UP/DOWN Key with Constant Speed	0.01 ~ 1.00Hz/ms	0.01	○	○	○	○	○
↗02-09	Digital Input Response Time	0.001~ 30.000 sec	0.005	○	○	○	○	○
↗02-10	Digital Input Operation Direction	0 ~ 65535	0	○	○	○	○	○
↗02-11	Multi-function Output 1 RA, RB, RC(Relay1)	0: No function 1: Operation indication	11	○	○	○	○	○
↗02-12	Multi-function Output 2 MRA, MRC (Relay2)	2: Operation speed attained 3: Desired frequency attained 1 (Pr.02-19)	1	○	○	○	○	○
↗02-13	Multi-function Output 3 (MO1)	4: Desired frequency attained 2 (Pr.02-21) 5: Zero speed (frequency command) 6: Zero speed with stop (frequency command) 7: Over torque (OT1) (Pr.06-06-06-08) 8: Over torque (OT2) (Pr.06-09-06-11)	0	○	○	○	○	○
↗02-14	Multi-function Output 4 (MO2)	9: Drive ready 10: User-defined Low-voltage Detection 11: Malfunction indication	0	○	○	○	○	○
↗02-35	Multi-function Output 5 (MO3)	12: Mechanical brake release (Pr.02-31) 13: Overheat 14: Software brake signal		○	○	○	○	○
↗02-36	Multi-function Output 6 (MO4)	15: PID feedback error 16: Slip error (gSL) 17: Terminal count value attained (Pr.02-16)		○	○	○	○	○
↗02-37	Multi-function Output 7 (MO5)	18: Preliminary count value attained (Pr.02-17) 19: Baseblock (B.B.) Indication 20: Warning output		○	○	○	○	○
↗02-38	Multi-function Output 8 (MO6)	21: Over voltage warning 22: Over-current stall prevention warning 23: Over-voltage stall prevention warning		○	○	○	○	○
↗02-39	Multi-function Output 9 (MO7)	24: Operation mode indication 25: Forward command 26: Reverse command		○	○	○	○	○
↗02-40	Multi-function Output 10 (MO8)	27: Output when current >= Pr.02-32 28: Output when current < Pr.02-32 29: Output when frequency >= Pr.02-33		○	○	○	○	○
↗02-41	Multi-function Output 11 (MO9)	30: Output when frequency < Pr.02-33 31: Y-connection for the motor coil 32: Δ connection for the motor coil		○	○	○	○	○
↗02-42	Multi-function Output 12 (MOA)	33: Zero speed (actual output frequency) 34: Zero speed with Stop (actual output frequency) 35: Error output selection 1 (Pr.06-23) 36: Error output selection 2 (Pr.06-24) 37: Error output selection 3 (Pr.06-25) 38: Error output selection 4 (Pr.06-26) 39: Position attained (Pr.10-19) 40: Speed attained (including zero speed) 41: Multi-position attained 42: Crane function		○	○	○	○	○
		43: Motor zero-speed output (Pr.02-43)		○	○	○	○	○

Pr.	Explanation	Settings	Factory Setting	VF	VFP	SVC	FOCPG	TQRP
		44: Max. reel diameter attained		<input type="radio"/>	<input type="radio"/>	<input type="radio"/>	<input type="radio"/>	<input type="radio"/>
		45: Empty reel diameter attained		<input type="radio"/>	<input type="radio"/>	<input type="radio"/>	<input type="radio"/>	<input type="radio"/>
		46: Broken belt detection		<input type="radio"/>	<input type="radio"/>	<input type="radio"/>	<input type="radio"/>	<input type="radio"/>
		47: Break release at stop		<input type="radio"/>	<input type="radio"/>	<input type="radio"/>	<input type="radio"/>	<input type="radio"/>
		48: Error PID feedback of tension		<input type="radio"/>	<input type="radio"/>	<input type="radio"/>	<input type="radio"/>	<input type="radio"/>
		49: Reserved						
		50: Reserved						
↗02-15	Multi-output Direction	0 ~ 65535	0	<input type="radio"/>	<input type="radio"/>	<input type="radio"/>	<input type="radio"/>	<input type="radio"/>
↗02-16	Terminal Count Value	0 ~ 65535	0	<input type="radio"/>	<input type="radio"/>	<input type="radio"/>	<input type="radio"/>	<input type="radio"/>
↗02-17	Preliminary Counter Value	0 ~ 65535	0	<input type="radio"/>	<input type="radio"/>	<input type="radio"/>	<input type="radio"/>	<input type="radio"/>
↗02-18	Digital Output Gain	1 ~ 40	1	<input type="radio"/>	<input type="radio"/>	<input type="radio"/>	<input type="radio"/>	<input type="radio"/>
↗02-19	Desired Frequency Attained 1	0.00 ~ 600.00Hz	60.00/ 50.00	<input type="radio"/>	<input type="radio"/>	<input type="radio"/>	<input type="radio"/>	<input type="radio"/>
↗02-20	The Width of the Desired Frequency Attained 1	0.00 ~ 600.00Hz	2.00	<input type="radio"/>	<input type="radio"/>	<input type="radio"/>	<input type="radio"/>	<input type="radio"/>
↗02-21	Desired Frequency Attained 2	0.00 ~ 600.00Hz	60.00/ 50.00	<input type="radio"/>	<input type="radio"/>	<input type="radio"/>	<input type="radio"/>	<input type="radio"/>
↗02-22	The Width of the Desired Frequency Attained 2	0.00 ~ 600.00Hz	2.00	<input type="radio"/>	<input type="radio"/>	<input type="radio"/>	<input type="radio"/>	<input type="radio"/>
02-31	Brake Delay Time	0.000~65.000 Sec	0.000	<input type="radio"/>	<input type="radio"/>	<input type="radio"/>	<input type="radio"/>	<input type="radio"/>
↗02-32	Output Current Level Setting for External Terminals	0~100%	0	<input type="radio"/>	<input type="radio"/>	<input type="radio"/>	<input type="radio"/>	<input type="radio"/>
↗02-33	Output Boundary for External Terminals	0.00~+/-60.00Hz (it is motor speed when using PG)	0.00	<input type="radio"/>	<input type="radio"/>	<input type="radio"/>	<input type="radio"/>	<input type="radio"/>
↗02-34	External Operation Control Selection after Reset	0: Disable 1: Drive runs if run command exists after reset	0	<input type="radio"/>	<input type="radio"/>	<input type="radio"/>	<input type="radio"/>	<input type="radio"/>
↗02-43	Zero-speed Level of Motor	0~65535 rpm	0	<input type="radio"/>	<input type="radio"/>	<input type="radio"/>	<input type="radio"/>	<input type="radio"/>

Group 3 Analog Input/Output Parameters

Pr.	Explanation	Settings	Factory Setting	VF	VFPG	SVC	FOCPG	TQRPG
↗03-00	Analog Input 1 (AVI)	0: No function	1	<input type="radio"/>	<input type="radio"/>	<input type="radio"/>	<input type="radio"/>	<input type="radio"/>
↗03-01	Analog Input 2 (ACI)	1: Frequency command (torque limit under TQR control mode)	0	<input type="radio"/>	<input type="radio"/>	<input type="radio"/>	<input type="radio"/>	<input type="radio"/>
↗03-02	Analog Input 3 (AUI)	2: torque command (torque limit under speed mode)	0	<input type="radio"/>	<input type="radio"/>	<input type="radio"/>	<input type="radio"/>	<input type="radio"/>
		3: Torque compensation command		<input type="radio"/>	<input type="radio"/>	<input type="radio"/>	<input type="radio"/>	<input type="radio"/>
		4: PID target value (refer to group 8)		<input type="radio"/>	<input type="radio"/>	<input type="radio"/>	<input type="radio"/>	<input type="radio"/>
		5: PID feedback signal (refer to group 8)		<input type="radio"/>	<input type="radio"/>	<input type="radio"/>	<input type="radio"/>	<input type="radio"/>
		6: P.T.C. thermistor input value		<input type="radio"/>	<input type="radio"/>	<input type="radio"/>	<input type="radio"/>	<input type="radio"/>
		7: Positive torque limit		<input type="radio"/>	<input type="radio"/>	<input type="radio"/>	<input type="radio"/>	<input type="radio"/>
		8: Negative torque limit		<input type="radio"/>	<input type="radio"/>	<input type="radio"/>	<input type="radio"/>	<input type="radio"/>
		9: Regenerative torque limit		<input type="radio"/>	<input type="radio"/>	<input type="radio"/>	<input type="radio"/>	<input type="radio"/>
		10: Positive/negative torque limit		<input type="radio"/>	<input type="radio"/>	<input type="radio"/>	<input type="radio"/>	<input type="radio"/>
		11: PID feedback signal of tension		<input type="radio"/>	<input type="radio"/>	<input type="radio"/>	<input type="radio"/>	<input type="radio"/>
		12: Line speed		<input type="radio"/>	<input type="radio"/>	<input type="radio"/>	<input type="radio"/>	<input type="radio"/>
		13: Reel diameter		<input type="radio"/>	<input type="radio"/>	<input type="radio"/>	<input type="radio"/>	<input type="radio"/>
		14: PID target value of tension (tension closed-loop)		<input type="radio"/>	<input type="radio"/>	<input type="radio"/>	<input type="radio"/>	<input type="radio"/>
		15: Tension setting (tension open-loop)		<input type="radio"/>	<input type="radio"/>	<input type="radio"/>	<input type="radio"/>	<input type="radio"/>
		16: Zero-speed tension		<input type="radio"/>	<input type="radio"/>	<input type="radio"/>	<input type="radio"/>	<input type="radio"/>
		17: Tension taper		<input type="radio"/>	<input type="radio"/>	<input type="radio"/>	<input type="radio"/>	<input type="radio"/>
		↗03-03		Analog Input Bias 1 (AVI)	-100.0~100.0%	0	<input type="radio"/>	<input type="radio"/>
↗03-04	Analog Input Bias 2 (ACI)	-100.0~100.0%	0	<input type="radio"/>	<input type="radio"/>	<input type="radio"/>	<input type="radio"/>	<input type="radio"/>
↗03-05	Analog Input Bias 3 (AUI)	-100.0~100.0%	0	<input type="radio"/>	<input type="radio"/>	<input type="radio"/>	<input type="radio"/>	<input type="radio"/>
↗03-06	Positive/negative Bias Mode (AVI)	0: Zero bias	0	<input type="radio"/>	<input type="radio"/>	<input type="radio"/>	<input type="radio"/>	<input type="radio"/>
		1: Lower than bias=bias		<input type="radio"/>	<input type="radio"/>	<input type="radio"/>	<input type="radio"/>	
↗03-07	Positive/negative Bias Mode (ACI)	2: Greater than bias=bias	0	<input type="radio"/>	<input type="radio"/>	<input type="radio"/>	<input type="radio"/>	<input type="radio"/>
		3: The absolute value of the bias voltage while serving as the center		<input type="radio"/>	<input type="radio"/>	<input type="radio"/>	<input type="radio"/>	
↗03-08	Positive/negative Bias Mode (AUI)	4: Serve bias as the center	0	<input type="radio"/>	<input type="radio"/>	<input type="radio"/>	<input type="radio"/>	<input type="radio"/>
↗03-09	Analog Input Gain 1 (AVI)	-500.0~500.0%	100.0	<input type="radio"/>	<input type="radio"/>	<input type="radio"/>	<input type="radio"/>	<input type="radio"/>
↗03-10	Analog Input Gain 2 (ACI)	-500.0~500.0%	100.0	<input type="radio"/>	<input type="radio"/>	<input type="radio"/>	<input type="radio"/>	<input type="radio"/>
↗03-11	Analog Input Gain 3 (AUI)	-500.0~500.0%	100.0	<input type="radio"/>	<input type="radio"/>	<input type="radio"/>	<input type="radio"/>	<input type="radio"/>
↗03-12	ACI/AVI2 Selection	0: ACI 1: AVI 2	0	<input type="radio"/>	<input type="radio"/>	<input type="radio"/>	<input type="radio"/>	<input type="radio"/>
↗03-13	Analog Input Delay Time (AVI)	0.00~2.00 sec	0.01	<input type="radio"/>	<input type="radio"/>	<input type="radio"/>	<input type="radio"/>	<input type="radio"/>
↗03-14	Analog Input Delay Time (ACI)	0.00~2.00 sec	0.01	<input type="radio"/>	<input type="radio"/>	<input type="radio"/>	<input type="radio"/>	<input type="radio"/>
↗03-15	Analog Input Delay Time (AUI)	0.00~2.00 sec	0.01	<input type="radio"/>	<input type="radio"/>	<input type="radio"/>	<input type="radio"/>	<input type="radio"/>
↗03-16	Addition Function of the Analog Input	0: Disable (AVI, ACI, AUI)	0	<input type="radio"/>	<input type="radio"/>	<input type="radio"/>	<input type="radio"/>	<input type="radio"/>
		1: Enable		<input type="radio"/>	<input type="radio"/>	<input type="radio"/>	<input type="radio"/>	
↗03-17	Loss of the ACI Signal	0: Disable	0	<input type="radio"/>	<input type="radio"/>	<input type="radio"/>	<input type="radio"/>	<input type="radio"/>
		1: Continue operation at the last frequency		<input type="radio"/>	<input type="radio"/>	<input type="radio"/>	<input type="radio"/>	
		2: Decelerate to stop 3: Stop immediately and display E.F.		<input type="radio"/>	<input type="radio"/>	<input type="radio"/>	<input type="radio"/>	
↗03-18	Analog Output Selection 1	0: Output frequency (Hz)	0	<input type="radio"/>	<input type="radio"/>	<input type="radio"/>	<input type="radio"/>	<input type="radio"/>
		1: Frequency command (Hz)		<input type="radio"/>	<input type="radio"/>	<input type="radio"/>	<input type="radio"/>	
↗03-21	Analog Output Selection 2	2: Motor speed (Hz)	0	<input type="radio"/>	<input type="radio"/>	<input type="radio"/>	<input type="radio"/>	<input type="radio"/>
		3: Output current (rms)		<input type="radio"/>	<input type="radio"/>	<input type="radio"/>	<input type="radio"/>	
		4: Output voltage		<input type="radio"/>	<input type="radio"/>	<input type="radio"/>	<input type="radio"/>	
↗03-24	Analog Output Selection 3	5: DC Bus Voltage	0	<input type="radio"/>	<input type="radio"/>	<input type="radio"/>	<input type="radio"/>	<input type="radio"/>
		6: Power factor		<input type="radio"/>	<input type="radio"/>	<input type="radio"/>	<input type="radio"/>	
		7: Power		<input type="radio"/>	<input type="radio"/>	<input type="radio"/>	<input type="radio"/>	
		8: Output torque		<input type="radio"/>	<input type="radio"/>	<input type="radio"/>	<input type="radio"/>	

Pr.	Explanation	Settings	Factory Setting	VF	VFPG	SVC	FOCPG	TQRPg
		9: AVI		<input type="checkbox"/>	<input type="checkbox"/>	<input type="checkbox"/>	<input type="checkbox"/>	<input type="checkbox"/>
		10: ACI		<input type="checkbox"/>	<input type="checkbox"/>	<input type="checkbox"/>	<input type="checkbox"/>	<input type="checkbox"/>
		11: AUI		<input type="checkbox"/>	<input type="checkbox"/>	<input type="checkbox"/>	<input type="checkbox"/>	<input type="checkbox"/>
		12: q-axis current		<input type="checkbox"/>	<input type="checkbox"/>	<input type="checkbox"/>	<input type="checkbox"/>	<input type="checkbox"/>
		13: q-axis feedback value		<input type="checkbox"/>	<input type="checkbox"/>	<input type="checkbox"/>	<input type="checkbox"/>	<input type="checkbox"/>
		14: d-axis current		<input type="checkbox"/>	<input type="checkbox"/>	<input type="checkbox"/>	<input type="checkbox"/>	<input type="checkbox"/>
		15: d-axis feedback value		<input type="checkbox"/>	<input type="checkbox"/>	<input type="checkbox"/>	<input type="checkbox"/>	<input type="checkbox"/>
		16: q-axis voltage		<input type="checkbox"/>	<input type="checkbox"/>	<input type="checkbox"/>	<input type="checkbox"/>	<input type="checkbox"/>
		17: d-axis voltage		<input type="checkbox"/>	<input type="checkbox"/>	<input type="checkbox"/>	<input type="checkbox"/>	<input type="checkbox"/>
		18: Torque command		<input type="checkbox"/>	<input type="checkbox"/>	<input type="checkbox"/>	<input type="checkbox"/>	<input type="checkbox"/>
		19: Pulse frequency command		<input type="checkbox"/>	<input type="checkbox"/>	<input type="checkbox"/>	<input type="checkbox"/>	<input type="checkbox"/>
↗03-19	Analog Output Gain 1	0~200.0%	100.0	<input type="checkbox"/>	<input type="checkbox"/>	<input type="checkbox"/>	<input type="checkbox"/>	<input type="checkbox"/>
↗03-20	Analog Output Value in REV Direction 1	0: Absolute value in REV direction 1: Output 0V in REV direction 2: Enable output voltage in REV direction	0	<input type="checkbox"/>	<input type="checkbox"/>	<input type="checkbox"/>	<input type="checkbox"/>	<input type="checkbox"/>
↗03-22	Analog Output Gain 2	0~200.0%	100.0	<input type="checkbox"/>	<input type="checkbox"/>	<input type="checkbox"/>	<input type="checkbox"/>	<input type="checkbox"/>
↗03-23	Analog Output Value in REV Direction 2	0: Absolute value in REV direction 1: Output 0V in REV direction 2: Enable output voltage in REV direction	0	<input type="checkbox"/>	<input type="checkbox"/>	<input type="checkbox"/>	<input type="checkbox"/>	<input type="checkbox"/>
↗03-25	Analog Output Gain 3	0~200.0%	100.0	<input type="checkbox"/>	<input type="checkbox"/>	<input type="checkbox"/>	<input type="checkbox"/>	<input type="checkbox"/>
↗03-26	Analog Output Value in REV Direction 3	0: Absolute value in REV direction 1: Output 0V in REV direction 2: Enable output voltage in REV direction	0	<input type="checkbox"/>	<input type="checkbox"/>	<input type="checkbox"/>	<input type="checkbox"/>	<input type="checkbox"/>

Group 4 Multi-Step Speed Parameters

Pr.	Explanation	Settings	Factory Setting	VF	VFPG	SVC	FOCPG	TQRPg
↗04-00	1st Step Speed Frequency	0.00~600.00Hz	0.00	<input type="radio"/>	<input type="radio"/>	<input type="radio"/>	<input type="radio"/>	
↗04-01	2nd Step Speed Frequency	0.00~600.00Hz	0.00	<input type="radio"/>	<input type="radio"/>	<input type="radio"/>	<input type="radio"/>	
↗04-02	3rd Step Speed Frequency	0.00~600.00Hz	0.00	<input type="radio"/>	<input type="radio"/>	<input type="radio"/>	<input type="radio"/>	
↗04-03	4th Step Speed Frequency	0.00~600.00Hz	0.00	<input type="radio"/>	<input type="radio"/>	<input type="radio"/>	<input type="radio"/>	
↗04-04	5th Step Speed Frequency	0.00~600.00Hz	0.00	<input type="radio"/>	<input type="radio"/>	<input type="radio"/>	<input type="radio"/>	
↗04-05	6th Step Speed Frequency	0.00~600.00Hz	0.00	<input type="radio"/>	<input type="radio"/>	<input type="radio"/>	<input type="radio"/>	
↗04-06	7th Step Speed Frequency	0.00~600.00Hz	0.00	<input type="radio"/>	<input type="radio"/>	<input type="radio"/>	<input type="radio"/>	
↗04-07	8th Step Speed Frequency	0.00~600.00Hz	0.00	<input type="radio"/>	<input type="radio"/>	<input type="radio"/>	<input type="radio"/>	
↗04-08	9th Step Speed Frequency	0.00~600.00Hz	0.00	<input type="radio"/>	<input type="radio"/>	<input type="radio"/>	<input type="radio"/>	
↗04-09	10th Step Speed Frequency	0.00~600.00Hz	0.00	<input type="radio"/>	<input type="radio"/>	<input type="radio"/>	<input type="radio"/>	
↗04-10	11th Step Speed Frequency	0.00~600.00Hz	0.00	<input type="radio"/>	<input type="radio"/>	<input type="radio"/>	<input type="radio"/>	
↗04-11	12th Step Speed Frequency	0.00~600.00Hz	0.00	<input type="radio"/>	<input type="radio"/>	<input type="radio"/>	<input type="radio"/>	
↗04-12	13th Step Speed Frequency	0.00~600.00Hz	0.00	<input type="radio"/>	<input type="radio"/>	<input type="radio"/>	<input type="radio"/>	
↗04-13	14th Step Speed Frequency	0.00~600.00Hz	0.00	<input type="radio"/>	<input type="radio"/>	<input type="radio"/>	<input type="radio"/>	
↗04-14	15th Step Speed Frequency	0.00~600.00Hz	0.00	<input type="radio"/>	<input type="radio"/>	<input type="radio"/>	<input type="radio"/>	
↗04-15	Multi-position 1	0~65535	0		<input type="radio"/>		<input type="radio"/>	
↗04-16	Multi-position 2	0~65535	0		<input type="radio"/>		<input type="radio"/>	
↗04-17	Multi-position 3	0~65535	0		<input type="radio"/>		<input type="radio"/>	
↗04-18	Multi-position 4	0~65535	0		<input type="radio"/>		<input type="radio"/>	
↗04-19	Multi-position 5	0~65535	0		<input type="radio"/>		<input type="radio"/>	
↗04-20	Multi-position 6	0~65535	0		<input type="radio"/>		<input type="radio"/>	
↗04-21	Multi-position 7	0~65535	0		<input type="radio"/>		<input type="radio"/>	
↗04-22	Multi-position 8	0~65535	0		<input type="radio"/>		<input type="radio"/>	
↗04-23	Multi-position 9	0~65535	0		<input type="radio"/>		<input type="radio"/>	
↗04-24	Multi-position 10	0~65535	0		<input type="radio"/>		<input type="radio"/>	
↗04-25	Multi-position 11	0~65535	0		<input type="radio"/>		<input type="radio"/>	
↗04-26	Multi-position 12	0~65535	0		<input type="radio"/>		<input type="radio"/>	
↗04-27	Multi-position 13	0~65535	0		<input type="radio"/>		<input type="radio"/>	
↗04-28	Multi-position 14	0~65535	0		<input type="radio"/>		<input type="radio"/>	
↗04-29	Multi-position 15	0~65535	0		<input type="radio"/>		<input type="radio"/>	

Group 5 Motor Parameters

Pr.	Explanation	Settings	Factory Setting	VF	VFPG	SVC	FOCPG	TQRPg
05-00	Motor Auto Tuning	0: No function 1: Rolling test 2: Static Test 3: Reserved	0			○	○	○
05-01	Full-load Current of Motor 1	40-100%	###	○	○	○	○	○
↗05-02	Rated power of Motor 1	0-655.35	###			○	○	○
↗05-03	Rated speed of Motor 1 (rpm)	0-65535 1710 (60Hz, 4 poles), 1410 (50Hz, 4 poles)	1710		○	○	○	○
05-04	Number of Motor Poles 1	2-20	4	○	○	○	○	○
05-05	No-load Current of Motor 1	0-factory setting of Pr.05-01	###		○	○	○	○
05-06	Rotor Resistance R1 of Motor 1	0-65.535Ω	#####			○	○	○
05-07	Rr of Motor 1	0-65.535Ω	#####			○	○	○
05-08	Lm of Motor 1	0-6553.5mH	##			○	○	○
05-09	Lx of Motor 1	0-6553.5mH	##			○	○	○
05-10	Motor 1/Motor 2 Selection	1: Motor 1 2: Motor 2	1	○	○	○	○	○
↗05-11	Frequency for Y-connection/ Δ-connection Switch	0.00-600.00Hz	60.00	○	○	○	○	
05-12	Y-connection /Δ-connection Switch	0: Disable 1: Enable	0	○	○	○	○	
05-13	Full-load Current of Motor 2	40-100%	###	○	○	○	○	○
↗05-14	Rated Power of Motor 2	0-655.35	###			○	○	○
↗05-15	Rated Speed of Motor 2 (rpm)	0-65535	1710		○	○	○	○
05-16	Number of Motor Poles 2	2-20	4	○	○	○	○	○
05-17	No-load Current of Motor 2	0-factory setting of Pr.05-01	###		○	○	○	○
05-18	Rs of Motor 2	0-65.535Ω	#####			○	○	○
05-19	Rr of Motor 2	0-65.535Ω	#####			○	○	○
05-20	Lm of Motor 2	0-6553.5mH	##			○	○	○
05-21	Lx of Motor 2	0-6553.5mH	##			○	○	○
↗05-22	Torque Compensation Time Constant	0.001-10.000sec	0.020	○	○	○		
↗05-23	Slip Compensation Time Constant	0.001-10.000sec	0.100		○	○		
↗05-24	Torque Compensation Gain	0-10	0	○	○			
↗05-25	Slip Compensation Gain	0.00-10.00	0.00	○		○		
↗05-26	Slip Deviation Level	0-1000% (0: disable)	0		○	○	○	
↗05-27	Detection Time of Slip Deviation	0.0-10.0 sec	1.0		○	○	○	
↗05-28	Over Slip Treatment	0: Warn and keep operation 1: Warn and ramp to stop 2: Warn and coast to stop	0		○	○	○	
↗05-29	Hunting Gain	0-10000 (0: disable)	2000	○	○	○		
↗05-30	Delay Time for Y-connection/ Δ-connection	0-60.000 sec	0.200	○	○	○	○	
05-31	Accumulative Motor Operation Time (Min.)	00-1439	0	○	○	○	○	○
05-32	Accumulative Motor Operation Time (day)	00-65535	0	○	○	○	○	○

Group 6 Protection Parameters

Pr.	Explanation	Settings	Factory Setting	VF	VFPG	SVC	FOCPG	TQRPg
06-00	Low Voltage Level	160.0~220.0Vdc	180.0	○	○	○	○	○
		320.0~440.0Vdc	360.0	○	○	○	○	○
06-01	Over-voltage Stall Prevention	0.0: Disable						
		350.0~450.0Vdc	380.0	○	○	○	○	○
		700.0~900.0Vdc	760.0	○	○	○	○	○
06-02	Phase-loss Protection	0: Warn and keep operation 1: Warn and ramp to stop 2: Warn and coast to stop	0	○	○	○	○	○
06-03	Over-current Stall Prevention during Acceleration	00~250%	170	○	○	○		
06-04	Over-current Stall Prevention during Operation	00~250%	170	○	○	○		
06-05	Accel./Decel. Time Selection of Stall Prevention at constant speed	0: by current accel/decel time 1: by the 1st accel/decel time 2: by the 2nd accel/decel time 3: by the 3rd accel/decel time 4: by the 4th accel/decel time 5: by auto accel/decel time	0	○	○	○		
06-06	Over-torque Detection Selection (OT1)	0: disable 1: over-torque detection during constant speed operation, continue to operate after detection 2: over-torque detection during constant speed operation, stop operation after detection 3: over-torque detection during operation, continue to operate after detection 4: over-torque detection during operation, stop operation after detection	0	○	○	○	○	○
06-07	Over-torque Detection Level (OT1)	10~250%	150	○	○	○	○	○
06-08	Over-torque Detection Time (OT1)	0.0~60.0 sec	0.1	○	○	○	○	○
06-09	Over-torque Detection Selection (OT2)	0: disable 1: over-torque detection during constant speed operation, continue to operate after detection 2: over-torque detection during constant speed operation, stop operation after detection 3: over-torque detection during operation, continue to operate after detection 4: over-torque detection during operation, stop operation after detection	0	○	○	○	○	○
06-10	Over-torque Detection Level (OT2)	10~250%	150	○	○	○	○	○
06-11	Over-torque Detection Time (OT2)	0.0~60.0 sec	0.1	○	○	○	○	○
06-12	Current Limit	0~250%	150				○	○
06-13	Electronic Thermal Relay Selection (Motor 1)	0: Inverter motor 1: Standard motor 2: Disable	2	○	○	○	○	○
06-14	Electronic Thermal Characteristic for Motor 1	30.0~600.0 sec	60.0	○	○	○	○	○
06-15	Heat Sink Over-heat (OH) Warning	0.0~110.0 °C	85.0	○	○	○	○	○
06-16	Stall Prevention Limit Level	0~100% (refer to Pr.06-03, Pr.06-04)	50	○	○	○		
06-17	Present Fault Record	0: No fault	0	○	○	○	○	○
		1: Over-current during acceleration (ocA)		○	○	○	○	○
06-18	Second Most Recent Fault Record	2: Over-current during deceleration (ocd)	0	○	○	○	○	○
		3: Over-current during constant speed (ocn)		○	○	○	○	○
		4: Ground fault (GFF)		○	○	○	○	○
		5: IGBT short-circuit (occ)	0	○	○	○	○	○
06-19	Third Most Recent Fault Record	6: Over-current at stop (ocS)		○	○	○	○	○
		7: Over-voltage during acceleration (ovA)		○	○	○	○	○
		8: Over-voltage during deceleration (ovd)	0	○	○	○	○	○
06-20	Fourth Most Recent Fault Record	9: Over-voltage during constant speed (ovn)		○	○	○	○	○
		10: Over-voltage at stop (ovS)		○	○	○	○	○
				○	○	○	○	○

Pr.	Explanation	Settings	Factory Setting	VF	VFPG	SVC	FOCPG	TQRPG
06-21	Fifth Most Recent Fault Record	11: Low-voltage during acceleration (LvA)	0	<input type="checkbox"/>	<input type="checkbox"/>	<input type="checkbox"/>	<input type="checkbox"/>	<input type="checkbox"/>
		12: Low-voltage during deceleration (Lvd)		<input type="checkbox"/>	<input type="checkbox"/>	<input type="checkbox"/>	<input type="checkbox"/>	<input type="checkbox"/>
		13: Low-voltage during constant speed (Lvn)		<input type="checkbox"/>	<input type="checkbox"/>	<input type="checkbox"/>	<input type="checkbox"/>	<input type="checkbox"/>
		14: Low-voltage at stop (LvS)		<input type="checkbox"/>	<input type="checkbox"/>	<input type="checkbox"/>	<input type="checkbox"/>	<input type="checkbox"/>
		15: Phase loss (PHL)		<input type="checkbox"/>	<input type="checkbox"/>	<input type="checkbox"/>	<input type="checkbox"/>	<input type="checkbox"/>
		16: IGBT heat sink over-heat (oH1)		<input type="checkbox"/>	<input type="checkbox"/>	<input type="checkbox"/>	<input type="checkbox"/>	<input type="checkbox"/>
06-22	Sixth Most Recent Fault Record	17: Heat sink over-heat (oH2)(for 40HP above)	0	<input type="checkbox"/>	<input type="checkbox"/>	<input type="checkbox"/>	<input type="checkbox"/>	<input type="checkbox"/>
		18: TH1 open loop error (tH1o)		<input type="checkbox"/>	<input type="checkbox"/>	<input type="checkbox"/>	<input type="checkbox"/>	<input type="checkbox"/>
		19: TH2 open loop error (tH2o)		<input type="checkbox"/>	<input type="checkbox"/>	<input type="checkbox"/>	<input type="checkbox"/>	<input type="checkbox"/>
		20: Fan error signal output		<input type="checkbox"/>	<input type="checkbox"/>	<input type="checkbox"/>	<input type="checkbox"/>	<input type="checkbox"/>
		21: over-load (oL) (150% 1Min)		<input type="checkbox"/>	<input type="checkbox"/>	<input type="checkbox"/>	<input type="checkbox"/>	<input type="checkbox"/>
		22: Motor 1 over-load (EoL1)		<input type="checkbox"/>	<input type="checkbox"/>	<input type="checkbox"/>	<input type="checkbox"/>	<input type="checkbox"/>
		23: Motor 2 over-load (EoL2)		<input type="checkbox"/>	<input type="checkbox"/>	<input type="checkbox"/>	<input type="checkbox"/>	<input type="checkbox"/>
		24: Motor PTC overheat (oH3)		<input type="checkbox"/>	<input type="checkbox"/>	<input type="checkbox"/>	<input type="checkbox"/>	<input type="checkbox"/>
		25: Fuse error (FuSE)		<input type="checkbox"/>	<input type="checkbox"/>	<input type="checkbox"/>	<input type="checkbox"/>	<input type="checkbox"/>
		26: over-torque 1 (ot1)		<input type="checkbox"/>	<input type="checkbox"/>	<input type="checkbox"/>	<input type="checkbox"/>	<input type="checkbox"/>
		27: over-torque 1 (ot2)		<input type="checkbox"/>	<input type="checkbox"/>	<input type="checkbox"/>	<input type="checkbox"/>	<input type="checkbox"/>
		28: Reserved						
		29: Reserved						
		30: Memory write-in error (cF1)		<input type="checkbox"/>	<input type="checkbox"/>	<input type="checkbox"/>	<input type="checkbox"/>	<input type="checkbox"/>
		31: Memory read-out error (cF2)		<input type="checkbox"/>	<input type="checkbox"/>	<input type="checkbox"/>	<input type="checkbox"/>	<input type="checkbox"/>
		32: Isum current detection error (cd0)		<input type="checkbox"/>	<input type="checkbox"/>	<input type="checkbox"/>	<input type="checkbox"/>	<input type="checkbox"/>
		33: U-phase current detection error (cd1)		<input type="checkbox"/>	<input type="checkbox"/>	<input type="checkbox"/>	<input type="checkbox"/>	<input type="checkbox"/>
		34: V-phase current detection error (cd2)		<input type="checkbox"/>	<input type="checkbox"/>	<input type="checkbox"/>	<input type="checkbox"/>	<input type="checkbox"/>
		35: W-phase current detection error (cd3)		<input type="checkbox"/>	<input type="checkbox"/>	<input type="checkbox"/>	<input type="checkbox"/>	<input type="checkbox"/>
		36: Clamp current detection error (Hd0)		<input type="checkbox"/>	<input type="checkbox"/>	<input type="checkbox"/>	<input type="checkbox"/>	<input type="checkbox"/>
		37: Over-current detection error (Hd1)		<input type="checkbox"/>	<input type="checkbox"/>	<input type="checkbox"/>	<input type="checkbox"/>	<input type="checkbox"/>
		38: Over-voltage detection error (Hd2)		<input type="checkbox"/>	<input type="checkbox"/>	<input type="checkbox"/>	<input type="checkbox"/>	<input type="checkbox"/>
		39: Ground current detection error (Hd3)		<input type="checkbox"/>	<input type="checkbox"/>	<input type="checkbox"/>	<input type="checkbox"/>	<input type="checkbox"/>
		40: Auto tuning error (AuE)				<input type="checkbox"/>	<input type="checkbox"/>	<input type="checkbox"/>
		41: PID feedback loss (AFE)		<input type="checkbox"/>	<input type="checkbox"/>	<input type="checkbox"/>	<input type="checkbox"/>	<input type="checkbox"/>
		42: PG feedback error (PGF1)		<input type="checkbox"/>	<input type="checkbox"/>	<input type="checkbox"/>	<input type="checkbox"/>	<input type="checkbox"/>
		43: PG feedback loss (PGF2)				<input type="checkbox"/>	<input type="checkbox"/>	<input type="checkbox"/>
		44: PG feedback stall (PGF3)				<input type="checkbox"/>	<input type="checkbox"/>	<input type="checkbox"/>
		45: PG slip error (PGF4)				<input type="checkbox"/>	<input type="checkbox"/>	<input type="checkbox"/>
		46: PG ref input error (PGr1)		<input type="checkbox"/>	<input type="checkbox"/>	<input type="checkbox"/>	<input type="checkbox"/>	<input type="checkbox"/>
		47: PG ref loss (PGr2)		<input type="checkbox"/>	<input type="checkbox"/>	<input type="checkbox"/>	<input type="checkbox"/>	<input type="checkbox"/>
		48: Analog current input loss (ACE)		<input type="checkbox"/>	<input type="checkbox"/>	<input type="checkbox"/>	<input type="checkbox"/>	<input type="checkbox"/>
		49: External fault input (EF)		<input type="checkbox"/>	<input type="checkbox"/>	<input type="checkbox"/>	<input type="checkbox"/>	<input type="checkbox"/>
		50: Emergency stop (EF1)		<input type="checkbox"/>	<input type="checkbox"/>	<input type="checkbox"/>	<input type="checkbox"/>	<input type="checkbox"/>
		51: External Base Block (B.B.)		<input type="checkbox"/>	<input type="checkbox"/>	<input type="checkbox"/>	<input type="checkbox"/>	<input type="checkbox"/>
52: Password error (PcodE)	<input type="checkbox"/>	<input type="checkbox"/>	<input type="checkbox"/>	<input type="checkbox"/>	<input type="checkbox"/>			
53: Reserved								
54: Communication error (cE1)	<input type="checkbox"/>	<input type="checkbox"/>	<input type="checkbox"/>	<input type="checkbox"/>	<input type="checkbox"/>			
55: Communication error (cE2)	<input type="checkbox"/>	<input type="checkbox"/>	<input type="checkbox"/>	<input type="checkbox"/>	<input type="checkbox"/>			
56: Communication error (cE3)	<input type="checkbox"/>	<input type="checkbox"/>	<input type="checkbox"/>	<input type="checkbox"/>	<input type="checkbox"/>			
57: Communication error (cE4)	<input type="checkbox"/>	<input type="checkbox"/>	<input type="checkbox"/>	<input type="checkbox"/>	<input type="checkbox"/>			
58: Communication Time-out (cE10)	<input type="checkbox"/>	<input type="checkbox"/>	<input type="checkbox"/>	<input type="checkbox"/>	<input type="checkbox"/>			
59: PU time-out (cP10)	<input type="checkbox"/>	<input type="checkbox"/>	<input type="checkbox"/>	<input type="checkbox"/>	<input type="checkbox"/>			
60: Brake transistor error (bF)	<input type="checkbox"/>	<input type="checkbox"/>	<input type="checkbox"/>	<input type="checkbox"/>	<input type="checkbox"/>			
61: Y-connection/ Δ -connection switch error (ydc)	<input type="checkbox"/>	<input type="checkbox"/>	<input type="checkbox"/>	<input type="checkbox"/>	<input type="checkbox"/>			
62: Decel. Energy Backup Error (dEb)	<input type="checkbox"/>	<input type="checkbox"/>	<input type="checkbox"/>	<input type="checkbox"/>	<input type="checkbox"/>			
63: Slip error (oSL)	<input type="checkbox"/>	<input type="checkbox"/>	<input type="checkbox"/>	<input type="checkbox"/>	<input type="checkbox"/>			
64: Broken belt error (bEb)	<input type="checkbox"/>	<input type="checkbox"/>	<input type="checkbox"/>	<input type="checkbox"/>	<input type="checkbox"/>			
65: Error PID feedback signal of tension (tdEv)	<input type="checkbox"/>	<input type="checkbox"/>	<input type="checkbox"/>	<input type="checkbox"/>	<input type="checkbox"/>			
✓ 06-23	Fault Output Option 1	0-65535 (refer to bit table for fault code)	0	<input type="checkbox"/>	<input type="checkbox"/>	<input type="checkbox"/>	<input type="checkbox"/>	<input type="checkbox"/>
✓ 06-24	Fault Output Option 2	0-65535 (refer to bit table for fault code)	0	<input type="checkbox"/>	<input type="checkbox"/>	<input type="checkbox"/>	<input type="checkbox"/>	<input type="checkbox"/>
✓ 06-25	Fault Output Option 3	0-65535 (refer to bit table for fault code)	0	<input type="checkbox"/>	<input type="checkbox"/>	<input type="checkbox"/>	<input type="checkbox"/>	<input type="checkbox"/>
✓ 06-26	Fault Output Option 4	0-65535 (refer to bit table for fault code)	0	<input type="checkbox"/>	<input type="checkbox"/>	<input type="checkbox"/>	<input type="checkbox"/>	<input type="checkbox"/>
✓ 06-27	Electronic Thermal Relay Selection (Motor 2)	0: Inverter motor 1: Standard motor 2: Disable	2	<input type="checkbox"/>	<input type="checkbox"/>	<input type="checkbox"/>	<input type="checkbox"/>	<input type="checkbox"/>

Pr.	Explanation	Settings	Factory Setting	VF	VFG	SVC	FOCPG	TQRP
↗06-28	Electronic Thermal Characteristic for Motor 2	30.0~600.0 sec	60.0	<input type="radio"/>	<input type="radio"/>	<input type="radio"/>	<input type="radio"/>	<input type="radio"/>
↗06-29	PTC (Positive Temperature Coefficient) Detection Selection	0: Warn and keep operation 1: Warn and ramp to stop 2: Warn and coast to stop	0	<input type="radio"/>	<input type="radio"/>	<input type="radio"/>	<input type="radio"/>	<input type="radio"/>
↗06-30	PTC Level	0.0~100.0%	50.0	<input type="radio"/>	<input type="radio"/>	<input type="radio"/>	<input type="radio"/>	<input type="radio"/>
↗06-31	Filter Time for PTC Detection	0.00~10.00sec	0.20	<input type="radio"/>	<input type="radio"/>	<input type="radio"/>	<input type="radio"/>	<input type="radio"/>
06-32	Output Frequency for Malfunction	0.00~655.35 Hz	0.00	<input type="radio"/>	<input type="radio"/>	<input type="radio"/>	<input type="radio"/>	<input type="radio"/>
06-33	Output AC Voltage for Malfunction	0.0~6553.5 V	0.0	<input type="radio"/>	<input type="radio"/>	<input type="radio"/>	<input type="radio"/>	<input type="radio"/>
06-34	DC Voltage for Malfunction	0.0~6553.5 V	0.0	<input type="radio"/>	<input type="radio"/>	<input type="radio"/>	<input type="radio"/>	<input type="radio"/>
06-35	Current Value for Malfunction	0.00~655.35 Amp	0.00	<input type="radio"/>	<input type="radio"/>	<input type="radio"/>	<input type="radio"/>	<input type="radio"/>
06-36	IGBT Temperature for Malfunction	0.0~6553.5 °C	0.0	<input type="radio"/>	<input type="radio"/>	<input type="radio"/>	<input type="radio"/>	<input type="radio"/>

Group 7 Special Parameters

Pr.	Explanation	Settings	Factory Setting	VF	VFP	SVC	FOCPG	TQRP
↗07-00	Software Brake Level	230V: 350.0~450.0Vdc 460V: 700.0~900.0Vdc	380.0 760.0	<input type="checkbox"/>	<input type="checkbox"/>	<input type="checkbox"/>	<input type="checkbox"/>	<input type="checkbox"/>
↗07-01	DC Brake Current Level	0~100%	0				<input type="checkbox"/>	<input type="checkbox"/>
↗07-02	DC Brake Time during Start-up	0.0~60.0 sec	0.0					<input type="checkbox"/>
↗07-03	DC Brake Time during Stopping	0.0~60.0 sec	0.0				<input type="checkbox"/>	<input type="checkbox"/>
↗07-04	Start-point for DC Brake	0.00~600.00Hz	0.00	<input type="checkbox"/>	<input type="checkbox"/>	<input type="checkbox"/>		
07-05	DC Brake Voltage Gain	1~500	50	<input type="checkbox"/>	<input type="checkbox"/>	<input type="checkbox"/>		
↗07-06	Momentary Power Loss Operation Selection	0: Operation stop after momentary power loss 1: Operation continues after momentary power loss, speed search starts with the Master Frequency reference value 2: Operation continues after momentary power loss, speed search starts with the minimum frequency	0	<input type="checkbox"/>	<input type="checkbox"/>	<input type="checkbox"/>	<input type="checkbox"/>	<input type="checkbox"/>
↗07-07	Maximum Allowable Power Loss Time	0.1~5.0 sec	2.0	<input type="checkbox"/>	<input type="checkbox"/>	<input type="checkbox"/>	<input type="checkbox"/>	<input type="checkbox"/>
↗07-08	B.B. Time for Speed Search	0.1~5.0 sec	0.5	<input type="checkbox"/>	<input type="checkbox"/>	<input type="checkbox"/>	<input type="checkbox"/>	<input type="checkbox"/>
↗07-09	Current Limit for Speed Search	20~200%	150	<input type="checkbox"/>	<input type="checkbox"/>	<input type="checkbox"/>	<input type="checkbox"/>	<input type="checkbox"/>
↗07-10	Base-block Speed Search	0: Stop operation 1: Speed search starts with last frequency command 2: Speed search starts with minimum output frequency	0	<input type="checkbox"/>	<input type="checkbox"/>	<input type="checkbox"/>	<input type="checkbox"/>	<input type="checkbox"/>
↗07-11	Auto Restart after Fault	0~10	0	<input type="checkbox"/>	<input type="checkbox"/>	<input type="checkbox"/>	<input type="checkbox"/>	<input type="checkbox"/>
↗07-12	Speed Search during Start-up	0: Disable 1: Speed search from maximum frequency 2: Speed search from start-up frequency 3: Speed search from minimum frequency	0	<input type="checkbox"/>	<input type="checkbox"/>	<input type="checkbox"/>		
↗07-13	Decel. Time Selection for Momentary Power Loss	0: Disable 1: 1 st decel. time 2: 2 nd decel. time 3: 3 rd decel. time 4: 4 th decel. time 5: Current decel. time 6: Auto decel. Time	0	<input type="checkbox"/>	<input type="checkbox"/>	<input type="checkbox"/>	<input type="checkbox"/>	<input type="checkbox"/>
↗07-14	DEB Return Time	0.0~25.0 sec	0.0	<input type="checkbox"/>	<input type="checkbox"/>	<input type="checkbox"/>	<input type="checkbox"/>	
↗07-15	Dwell Time at Accel.	0.00~600.00sec	0.00	<input type="checkbox"/>	<input type="checkbox"/>	<input type="checkbox"/>	<input type="checkbox"/>	
↗07-16	Dwell Frequency at Accel.	0.00~600.00Hz	0.00	<input type="checkbox"/>	<input type="checkbox"/>	<input type="checkbox"/>	<input type="checkbox"/>	
↗07-17	Dwell Time at Decel.	0.00~600.00sec	0.00	<input type="checkbox"/>	<input type="checkbox"/>	<input type="checkbox"/>	<input type="checkbox"/>	
↗07-18	Dwell Frequency at Decel.	0.00~600.00Hz	0.00	<input type="checkbox"/>	<input type="checkbox"/>	<input type="checkbox"/>	<input type="checkbox"/>	
↗07-19	Fan Control	0: Fan always ON 1: 1 minute after AC motor drive stops, fan will be OFF 2: AC motor drive runs and fan ON, AC motor drive stops and fan OFF 3: Fan ON to run when preliminary heat sink temperature attained 4: Fan always OFF	0	<input type="checkbox"/>	<input type="checkbox"/>	<input type="checkbox"/>	<input type="checkbox"/>	<input type="checkbox"/>
↗07-20	Torque Command	-100.0~100.0% (Pr. 07-22 setting=100%)	0.0					<input type="checkbox"/>
↗07-21	Torque Command Source	0: Digital keypad 1: RS485 serial communication (RJ-11) 2: Analog signal (Pr.03-00)	0					<input type="checkbox"/>
↗07-22	Maximum Torque Command	0~500%	100					<input type="checkbox"/>
↗07-23	Filter Time of Torque Command	0.000~1.000 sec	0.000					<input type="checkbox"/>
07-24	Speed Limit Selection	0: By Pr.07-25 and Pr.07-26 1: Frequency command source (Pr.00-20)	0					<input type="checkbox"/>
↗07-25	Torque Mode +Speed Limit	0~120%	10					<input type="checkbox"/>
↗07-26	Torque Mode-Speed Limit	0~120%	10					<input type="checkbox"/>

Pr.	Explanation	Settings	Factory Setting	VF	VFP	SVC	FOCPG	TQRP
↗07-27	Source of Torque Offset	0: Disable 1: Analog input (Pr.03-00) 2: Torque offset setting 3: Control by external terminal (by Pr.07-29 to Pr.07-31)	0			<input type="radio"/>	<input type="radio"/>	<input type="radio"/>
↗07-28	Torque Offset Setting	0.0~100.0%	0.0			<input type="radio"/>	<input type="radio"/>	<input type="radio"/>
↗07-29	High Torque Offset	0.0~100.0%	30.0			<input type="radio"/>	<input type="radio"/>	<input type="radio"/>
↗07-30	Middle Torque Offset	0.0~100.0%	20.0			<input type="radio"/>	<input type="radio"/>	<input type="radio"/>
↗07-31	Low Torque Offset	0.0~100.0%	10.0			<input type="radio"/>	<input type="radio"/>	<input type="radio"/>
↗07-32	Forward Motor Torque Limit	0~500%	200				<input type="radio"/>	<input type="radio"/>
↗07-33	Forward Regenerative Torque Limit	0~500%	200				<input type="radio"/>	<input type="radio"/>
↗07-34	Reverse Motor Torque Limit	0~500%	200				<input type="radio"/>	<input type="radio"/>
↗07-35	Reverse Regenerative Torque Limit	0~500%	200				<input type="radio"/>	<input type="radio"/>
↗07-36	Emergency Stop (EF) & Forced Stop Selection	0: Coast stop 1: By deceleration Time 1 2: By deceleration Time 2 3: By deceleration Time 3 4: By deceleration Time 4 5: System Deceleration 6: Automatic Deceleration	0	<input type="radio"/>	<input type="radio"/>	<input type="radio"/>	<input type="radio"/>	<input type="radio"/>

Group 8 High-function PID Parameters

Pr.	Explanation	Settings	Factory Setting	VF	VFPG	SVC	FOCPG	TQRP
↗08-00	Input Terminal for PID Feedback	0: No function 1: Negative PID feedback from external terminal AVI (Pr.03-00) 2: Negative PID feedback from PG card (Pr.10-15, skip direction) 3: Negative PID feedback from PG card (Pr.10-15) 4: Positive PID feedback from external terminal AVI (Pr.03-00) 5: Positive PID feedback from PG card (Pr.10-15, skip direction) 6: Positive PID feedback from PG card (Pr.10-15)	0	<input type="radio"/>	<input type="radio"/>	<input type="radio"/>	<input type="radio"/>	
↗08-01	Proportional Gain (P)	0.0~500.0%	80.0	<input type="radio"/>	<input type="radio"/>	<input type="radio"/>	<input type="radio"/>	
↗08-02	Integral Gain (I)	0.00~100.00 sec	1.00	<input type="radio"/>	<input type="radio"/>	<input type="radio"/>	<input type="radio"/>	
↗08-03	Derivative Control (D)	0.00~1.00 sec	0.00	<input type="radio"/>	<input type="radio"/>	<input type="radio"/>	<input type="radio"/>	
↗08-04	Upper limit for Integral Control	0.0~100.0%	100.0	<input type="radio"/>	<input type="radio"/>	<input type="radio"/>	<input type="radio"/>	
↗08-05	PID Output Frequency Limit	0.0~110.0%	100.0	<input type="radio"/>	<input type="radio"/>	<input type="radio"/>	<input type="radio"/>	
↗08-06	PID Offset	-100.0~+100.0%	0.0	<input type="radio"/>	<input type="radio"/>	<input type="radio"/>	<input type="radio"/>	
↗08-07	PID Delay Time	0.0~2.5 sec	0.0	<input type="radio"/>	<input type="radio"/>	<input type="radio"/>	<input type="radio"/>	
↗08-08	Feedback Signal Detection Time	0.0~3600.0 sec	0.0	<input type="radio"/>	<input type="radio"/>	<input type="radio"/>	<input type="radio"/>	
↗08-09	Feedback Fault Treatment	0: Warn and keep operating 1: Warn and ramp to stop 2: Warn and coast to stop 3: Warn and keep at last frequency	0	<input type="radio"/>	<input type="radio"/>	<input type="radio"/>	<input type="radio"/>	
↗08-10	Sleep Frequency	0.00~600.00Hz	0.00	<input type="radio"/>	<input type="radio"/>	<input type="radio"/>	<input type="radio"/>	
↗08-11	Wake-up Frequency	0.00~600.00Hz	0.00	<input type="radio"/>	<input type="radio"/>	<input type="radio"/>	<input type="radio"/>	
↗08-12	Sleep Time	0.0~6000.0 sec	0.0	<input type="radio"/>	<input type="radio"/>	<input type="radio"/>	<input type="radio"/>	
↗08-13	PID Deviation Level	1.0~50.0%	10.0	<input type="radio"/>	<input type="radio"/>	<input type="radio"/>	<input type="radio"/>	
↗08-14	PID Deviation Time	0.1~300.0 sec	5.0	<input type="radio"/>	<input type="radio"/>	<input type="radio"/>	<input type="radio"/>	
↗08-15	Filter Time for PID Feedback	0.1~300.0 sec	5.0	<input type="radio"/>	<input type="radio"/>	<input type="radio"/>	<input type="radio"/>	
08-16 08-20	Reserved							
08-21	Tension Control Selection	0: Disable 1: Closed-loop, speed mode 2: Line speed, speed mode 3: Reserved 4: Open-loop, torque mode	0	<input type="radio"/>	<input type="radio"/>	<input type="radio"/>	<input type="radio"/>	<input type="radio"/>
08-22	Wind Mode	0: Rewind 1: Unwind	0	<input type="radio"/>	<input type="radio"/>	<input type="radio"/>	<input type="radio"/>	<input type="radio"/>
08-23	Mechanical Gear Ratio A	1-65535	100	<input type="radio"/>	<input type="radio"/>	<input type="radio"/>	<input type="radio"/>	<input type="radio"/>
08-24	Mechanical Gear Ratio B	1-65535	100	<input type="radio"/>	<input type="radio"/>	<input type="radio"/>	<input type="radio"/>	<input type="radio"/>
08-25	Source of the Tension Command/Line Speed	0: Parameter setting (Pr.08-26) 1: RS-485 communication setting (Pr.08-26) 2: Analog input (Pr. 03-00~03-02 is set to 14 PID target value of tension, 03-00~03-02 is set to 12 line speed)	0	<input type="radio"/>	<input type="radio"/>	<input type="radio"/>	<input type="radio"/>	<input type="radio"/>
↗08-26	PID Target Value of Tension/Line Speed	0.0~100.0%	50.0	<input type="radio"/>	<input type="radio"/>	<input type="radio"/>	<input type="radio"/>	<input type="radio"/>
08-27	Source of Tension/Line Speed PID Feedback	0: Analog input (Pr. 03-00~03-02 is set to 11 PID feedback of tension) 1: Pulse input (Pr.08-40)	0	<input type="radio"/>	<input type="radio"/>	<input type="radio"/>	<input type="radio"/>	<input type="radio"/>
08-28	Auto-tuning Tension PID	0: Disable 1: Reel diameter (08-29~08-31 corresponds to 08-44, 08-32~08-34 corresponds to 08-43) 2: Frequency (08-29~08-31 corresponds to 01-07, 08-32~08-34 corresponds to 01-00)		<input type="radio"/>	<input type="radio"/>	<input type="radio"/>	<input type="radio"/>	<input type="radio"/>
↗08-29	Tension PID P1	0.0~1000.0	50.0	<input type="radio"/>	<input type="radio"/>	<input type="radio"/>	<input type="radio"/>	<input type="radio"/>
↗08-30	Tension PID I1	0.00~500.00 sec	1.00	<input type="radio"/>	<input type="radio"/>	<input type="radio"/>	<input type="radio"/>	<input type="radio"/>
08-31	Reserved							

Pr.	Explanation	Settings	Factory Setting	VF	VFP	SVC	FOCPG	TQPRG
08-32	Tension PID P2	0.0~1000.0	50.0	<input type="checkbox"/>	<input type="checkbox"/>	<input type="checkbox"/>	<input type="checkbox"/>	<input type="checkbox"/>
08-33	Tension PID I2	0.00~500.00 sec	1.00	<input type="checkbox"/>	<input type="checkbox"/>	<input type="checkbox"/>	<input type="checkbox"/>	<input type="checkbox"/>
08-34	Reserved							
08-35	PID/Line Speed Output Status	0: Positive output 1: Negative output	0	<input type="checkbox"/>	<input type="checkbox"/>	<input type="checkbox"/>	<input type="checkbox"/>	<input type="checkbox"/>
08-36	Tension/Line Speed PID Output Limit	0~100.00% (according to Pr.01-00)	20.00	<input type="checkbox"/>	<input type="checkbox"/>	<input type="checkbox"/>	<input type="checkbox"/>	<input type="checkbox"/>
08-37	Source of Line Speed Input Command	0: Disable 1: Analog input (Pr. 03-00~03-02 is set to 12 line speed) 2: RS-485 communication setting (Pr.08-41) 3: Pulse input (Pr.08-40) 4: DFM-DCM pulse input (Pr.02-18)	0	<input type="checkbox"/>	<input type="checkbox"/>	<input type="checkbox"/>	<input type="checkbox"/>	<input type="checkbox"/>
08-38	Max. Line Speed	0.0~3000.0m/min	1000.0	<input type="checkbox"/>	<input type="checkbox"/>	<input type="checkbox"/>	<input type="checkbox"/>	<input type="checkbox"/>
08-39	Min. Line Speed	0.0~3000.0m/min	0.0	<input type="checkbox"/>	<input type="checkbox"/>	<input type="checkbox"/>	<input type="checkbox"/>	<input type="checkbox"/>
08-40	Pulse Number for Each Meter	0.0~6000.0	0.0	<input type="checkbox"/>	<input type="checkbox"/>	<input type="checkbox"/>	<input type="checkbox"/>	<input type="checkbox"/>
08-41	Current Line Speed	0.0~3000.0m/min	0.0	<input type="checkbox"/>	<input type="checkbox"/>	<input type="checkbox"/>	<input type="checkbox"/>	<input type="checkbox"/>
08-42	Source of Reel Diameter	0: Calculated by line speed 1: Calculated by integrating thickness (encoder is on reel shaft)(Pr.08-49~51, Pr.10-15) 2: Calculated by integrating thickness (encoder is on motor)(Pr.08-23~08-24, 08-50~08-51, 10-00~10-01) 3: Calculated by analog input (Pr.03-00~03-02 is set to 13)	0	<input type="checkbox"/>	<input type="checkbox"/>	<input type="checkbox"/>	<input type="checkbox"/>	<input type="checkbox"/>
08-43	Max. Reel Diameter	1.0~6000.0mm	6000.0	<input type="checkbox"/>	<input type="checkbox"/>	<input type="checkbox"/>	<input type="checkbox"/>	<input type="checkbox"/>
08-44	Empty Reel Diameter	1.0~6000.0mm	1.0	<input type="checkbox"/>	<input type="checkbox"/>	<input type="checkbox"/>	<input type="checkbox"/>	<input type="checkbox"/>
08-45	Source of Initial Reel Diameter	0: RS-485 communication setting (Pr.08-46) 1: Analog input (Pr.03-00-Pr.03-02 is set to 13)	0	<input type="checkbox"/>	<input type="checkbox"/>	<input type="checkbox"/>	<input type="checkbox"/>	<input type="checkbox"/>
08-46	Initial Reel Diameter	1.0~6000.0mm	1.0	<input type="checkbox"/>	<input type="checkbox"/>	<input type="checkbox"/>	<input type="checkbox"/>	<input type="checkbox"/>
08-47	Initial Reel Diameter 1	1.0~6000.0mm	1.0	<input type="checkbox"/>	<input type="checkbox"/>	<input type="checkbox"/>	<input type="checkbox"/>	<input type="checkbox"/>
08-48	Initial Reel Diameter 2	1.0~6000.0mm	1.0	<input type="checkbox"/>	<input type="checkbox"/>	<input type="checkbox"/>	<input type="checkbox"/>	<input type="checkbox"/>
08-49	Number of Pulse per Revolution	1~10000ppr	1	<input type="checkbox"/>	<input type="checkbox"/>	<input type="checkbox"/>	<input type="checkbox"/>	<input type="checkbox"/>
08-50	Coil Number for Each Layer	0.001~60.000mm	1.000	<input type="checkbox"/>	<input type="checkbox"/>	<input type="checkbox"/>	<input type="checkbox"/>	<input type="checkbox"/>
08-51	Material Thickness	0.001~60.000mm	1.000	<input type="checkbox"/>	<input type="checkbox"/>	<input type="checkbox"/>	<input type="checkbox"/>	<input type="checkbox"/>
08-52	Filter Time of Reel Diameter	0.00 to 100.00 seconds	1.00	<input type="checkbox"/>	<input type="checkbox"/>	<input type="checkbox"/>	<input type="checkbox"/>	<input type="checkbox"/>
08-53	Auto Compensation of Reel Diameter	0: Disable 1: Enable	1.00	<input type="checkbox"/>	<input type="checkbox"/>	<input type="checkbox"/>	<input type="checkbox"/>	<input type="checkbox"/>
08-54	Current Reel Diameter	1.0~6000.0mm	1.0	<input type="checkbox"/>	<input type="checkbox"/>	<input type="checkbox"/>	<input type="checkbox"/>	<input type="checkbox"/>
08-55	Smart Start	0: Disable 1: Enable 2: In unwind mode, rewind in reverse direction	1	<input type="checkbox"/>	<input type="checkbox"/>	<input type="checkbox"/>	<input type="checkbox"/>	<input type="checkbox"/>
08-56	Switch Level for Smart Start and PID function	0.0~100.0% (according to Pr.08-26)	15.0	<input type="checkbox"/>	<input type="checkbox"/>	<input type="checkbox"/>	<input type="checkbox"/>	<input type="checkbox"/>
08-57	Frequency for Smart Start	0.00~600.00Hz	2.00	<input type="checkbox"/>	<input type="checkbox"/>	<input type="checkbox"/>	<input type="checkbox"/>	<input type="checkbox"/>
08-58	Accel. Time for Smart Start	0.01~600.00 seconds	3.00	<input type="checkbox"/>	<input type="checkbox"/>	<input type="checkbox"/>	<input type="checkbox"/>	<input type="checkbox"/>
08-59	Broken Belt Detection	0: Disable 1: Enable	0	<input type="checkbox"/>	<input type="checkbox"/>	<input type="checkbox"/>	<input type="checkbox"/>	<input type="checkbox"/>
08-60	Min. Line Speed of Broken Belt Detection	0.0~3000.0m/min	0.0	<input type="checkbox"/>	<input type="checkbox"/>	<input type="checkbox"/>	<input type="checkbox"/>	<input type="checkbox"/>
08-61	Allowance Error of Line Speed of Broken Belt Detection	1.0~6000.0mm	100.0	<input type="checkbox"/>	<input type="checkbox"/>	<input type="checkbox"/>	<input type="checkbox"/>	<input type="checkbox"/>
08-62	Detection Time of Broken Belt	0.00~100.00 sec	1.00	<input type="checkbox"/>	<input type="checkbox"/>	<input type="checkbox"/>	<input type="checkbox"/>	<input type="checkbox"/>
08-63	Allowance Error Level of Tension/Line Speed PID Feedback	0~100%	100	<input type="checkbox"/>	<input type="checkbox"/>	<input type="checkbox"/>	<input type="checkbox"/>	<input type="checkbox"/>
08-64	Allowance Error Detection Time of Tension PID Feedback	0.0~10.0 sec	0.5	<input type="checkbox"/>	<input type="checkbox"/>	<input type="checkbox"/>	<input type="checkbox"/>	<input type="checkbox"/>

Chapter 4 Parameters | VFD-VE

Pr.	Explanation	Settings	Factory Setting	VF	VFPG	SVC	FOCPG	TQRPg
08-65	Error Treatment of Tension PID Feedback	0: Warn and keep operation 1: Warn and coast to stop 2: Warn and ramp to stop	0	<input type="radio"/>	<input type="radio"/>	<input type="radio"/>	<input type="radio"/>	<input type="radio"/>
08-66	Upper Limit of Tension PID Feedback	0.0~100.0%	100.0	<input type="radio"/>	<input type="radio"/>	<input type="radio"/>	<input type="radio"/>	<input type="radio"/>
08-67	Lower Limit of Tension PID Feedback	0.0~100.0%	0.0	<input type="radio"/>	<input type="radio"/>	<input type="radio"/>	<input type="radio"/>	<input type="radio"/>
08-68	Reserved							
08-69	DFM Selection	0: Output frequency 1: Frequency command	0	<input type="radio"/>	<input type="radio"/>	<input type="radio"/>	<input type="radio"/>	<input type="radio"/>
08-70	Low-pass Filter Time of Line Speed	0.00~100.00 sec	0.00	<input type="radio"/>	<input type="radio"/>	<input type="radio"/>	<input type="radio"/>	<input type="radio"/>
08-71 08-75	Reserved							
08-76	Source of Tension Setting	0: Communication RS-485 (Pr.08-78) 1: Analog input (Pr. 03-00~03-02 is set to 15 tension setting) (Pr.08-78)	0	<input type="radio"/>	<input type="radio"/>	<input type="radio"/>	<input type="radio"/>	<input type="radio"/>
08-77	Max. Tension	0~30000 N	0	<input type="radio"/>	<input type="radio"/>	<input type="radio"/>	<input type="radio"/>	<input type="radio"/>
08-78	Tension Setting	0~30000 N	0	<input type="radio"/>	<input type="radio"/>	<input type="radio"/>	<input type="radio"/>	<input type="radio"/>
08-79	Source of Zero-speed Tension Setting	0: Disable 1: Communication RS-485 (Pr.08-80) 2: Analog input (Pr. 03-00~03-02 is set to 16 zero-speed tension) (Pr.08-80)	0	<input type="radio"/>	<input type="radio"/>	<input type="radio"/>	<input type="radio"/>	<input type="radio"/>
08-80	Setting of Zero-speed Tension	0~30000 N	0	<input type="radio"/>	<input type="radio"/>	<input type="radio"/>	<input type="radio"/>	<input type="radio"/>
08-81	Source of Tension Taper	0: Communication RS-485 (Pr.08-82) 1: Analog input (Pr. 03-00~03-02 is set to 17 tension taper)(Pr.08-82)	0	<input type="radio"/>	<input type="radio"/>	<input type="radio"/>	<input type="radio"/>	<input type="radio"/>
08-82	Tension Taper	0~100%	0	<input type="radio"/>	<input type="radio"/>	<input type="radio"/>	<input type="radio"/>	<input type="radio"/>
08-83	Friction Compensation	0.0~100.0%	0.0	<input type="radio"/>	<input type="radio"/>	<input type="radio"/>	<input type="radio"/>	<input type="radio"/>
08-84	Compensation Coefficient of Material Inertial	0~30000	0	<input type="radio"/>	<input type="radio"/>	<input type="radio"/>	<input type="radio"/>	<input type="radio"/>
08-85	Torque Feedforward Gain	0.0~100.0%	50.0	<input type="radio"/>	<input type="radio"/>	<input type="radio"/>	<input type="radio"/>	<input type="radio"/>
08-86	Low Pass Filter Time of Torque Feedforward	0.00~100.00	5.00	<input type="radio"/>	<input type="radio"/>	<input type="radio"/>	<input type="radio"/>	<input type="radio"/>
08-87 08-99	Reserved							

Group 9 Communication Parameters

Pr.	Explanation	Settings	Factory Setting	VF	VFPF	SVC	FOCPG	TQRP
↗09-00	Communication Address	1~254	1	<input type="radio"/>	<input type="radio"/>	<input type="radio"/>	<input type="radio"/>	<input type="radio"/>
↗09-01	COM1 Transmission Speed	4.8~115.2Kbps	9.6	<input type="radio"/>	<input type="radio"/>	<input type="radio"/>	<input type="radio"/>	<input type="radio"/>
↗09-02	COM1 Transmission Fault Treatment	0: Warn and keep operation 1: Warn and ramp to stop 2: Warn and coast to stop 3: No warning and keep operation	3	<input type="radio"/>	<input type="radio"/>	<input type="radio"/>	<input type="radio"/>	<input type="radio"/>
↗09-03	COM1 Time-out Detection	0.0~100.0 sec	0.0	<input type="radio"/>	<input type="radio"/>	<input type="radio"/>	<input type="radio"/>	<input type="radio"/>
↗09-04	COM1 Communication Protocol	0: 7N1 (ASCII) 1: 7N2 (ASCII) 2: 7E1 (ASCII) 3: 7O1 (ASCII) 4: 7E2 (ASCII) 5: 7O2 (ASCII) 6: 8N1 (ASCII) 7: 8N2 (ASCII) 8: 8E1 (ASCII) 9: 8O1 (ASCII) 10: 8E2 (ASCII) 11: 8O2 (ASCII) 12: 8N1 (RTU) 13: 8N2 (RTU) 14: 8E1 (RTU) 15: 8O1 (RTU) 16: 8E2 (RTU) 17: 8O2 (RTU)	1	<input type="radio"/>	<input type="radio"/>	<input type="radio"/>	<input type="radio"/>	<input type="radio"/>
↗09-05	COM2 Transmission Speed (Keypad)	4.8~115.2Kbps	9.6	<input type="radio"/>	<input type="radio"/>	<input type="radio"/>	<input type="radio"/>	<input type="radio"/>
↗09-06	COM2 Transmission Fault Treatment (Keypad)	0: Warn and keep operation 1: Warn and ramp to stop 2: Warn and coast to stop 3: No warning and keep operation	3	<input type="radio"/>	<input type="radio"/>	<input type="radio"/>	<input type="radio"/>	<input type="radio"/>
↗09-07	COM2 Time-out Detection (Keypad)	0.0~100.0 sec	0.0	<input type="radio"/>	<input type="radio"/>	<input type="radio"/>	<input type="radio"/>	<input type="radio"/>
↗09-08	COM2 Communication Protocol (Keypad)	0: 7N1 (ASCII) 1: 7N2 (ASCII) 2: 7E1 (ASCII) 3: 7O1 (ASCII) 4: 7E2 (ASCII) 5: 7O2 (ASCII) 6: 8N1 (ASCII) 7: 8N2 (ASCII) 8: 8E1 (ASCII) 9: 8O1 (ASCII) 10: 8E2 (ASCII) 11: 8O2 (ASCII) 12: 8N1 (RTU) 13: 8N2 (RTU) 14: 8E1 (RTU) 15: 8O1 (RTU) 16: 8E2 (RTU) 17: 8O2 (RTU)	13	<input type="radio"/>	<input type="radio"/>	<input type="radio"/>	<input type="radio"/>	<input type="radio"/>
↗09-09	Response Delay Time	0.0~200.0ms	2.0	<input type="radio"/>	<input type="radio"/>	<input type="radio"/>	<input type="radio"/>	<input type="radio"/>
↗09-10	Transmission Master Frequency	0.00~600.00Hz	60.00	<input type="radio"/>	<input type="radio"/>	<input type="radio"/>	<input type="radio"/>	<input type="radio"/>
↗09-11	Block Transfer 1	0~65535	0	<input type="radio"/>	<input type="radio"/>	<input type="radio"/>	<input type="radio"/>	<input type="radio"/>
↗09-12	Block Transfer 2	0~65535	0	<input type="radio"/>	<input type="radio"/>	<input type="radio"/>	<input type="radio"/>	<input type="radio"/>
↗09-13	Block Transfer 3	0~65535	0	<input type="radio"/>	<input type="radio"/>	<input type="radio"/>	<input type="radio"/>	<input type="radio"/>
↗09-14	Block Transfer 4	0~65535	0	<input type="radio"/>	<input type="radio"/>	<input type="radio"/>	<input type="radio"/>	<input type="radio"/>
↗09-15	Block Transfer 5	0~65535	0	<input type="radio"/>	<input type="radio"/>	<input type="radio"/>	<input type="radio"/>	<input type="radio"/>
↗09-16	Block Transfer 6	0~65535	0	<input type="radio"/>	<input type="radio"/>	<input type="radio"/>	<input type="radio"/>	<input type="radio"/>
↗09-17	Block Transfer 7	0~65535	0	<input type="radio"/>	<input type="radio"/>	<input type="radio"/>	<input type="radio"/>	<input type="radio"/>
↗09-18	Block Transfer 8	0~65535	0	<input type="radio"/>	<input type="radio"/>	<input type="radio"/>	<input type="radio"/>	<input type="radio"/>
↗09-19	Block Transfer 9	0~65535	0	<input type="radio"/>	<input type="radio"/>	<input type="radio"/>	<input type="radio"/>	<input type="radio"/>

Chapter 4 Parameters | **VFD-VE**

Pr.	Explanation	Settings	Factory Setting	VF	VFPG	SVC	FOCPG	TQRPg
↗09-20	Block Transfer 10	0-65535	0	<input type="radio"/>	<input type="radio"/>	<input type="radio"/>	<input type="radio"/>	<input type="radio"/>
↗09-21	Multi-function Output Status	0-65535	Read-only	<input type="radio"/>	<input type="radio"/>	<input type="radio"/>	<input type="radio"/>	<input type="radio"/>
↗09-22	AFM2 Status	0-4095	Read-only	<input type="radio"/>	<input type="radio"/>	<input type="radio"/>	<input type="radio"/>	<input type="radio"/>
↗09-23	AFM3 Status	0-4095	Read-only	<input type="radio"/>	<input type="radio"/>	<input type="radio"/>	<input type="radio"/>	<input type="radio"/>

Group 10 Speed Feedback Control Parameters

Pr.	Explanation	Settings	Factory Setting	VF	VFPG	SVC	FOCPG	TQRPg
10-00	Encoder Pulse	1~20000	600		○		○	○
10-01	Encoder Input Type Setting	0: Disable 1: Phase A leads in a forward run command and phase B leads in a reverse run command 2: Phase B leads in a forward run command and phase A leads in a reverse run command 3: Phase A is a pulse input and phase B is a direction input. (low input=reverse direction, high input=forward direction) 4: Phase A is a pulse input and phase B is a direction input. (low input=forward direction, high input=reverse direction) 5: Single-phase input	0		○		○	○
↗10-02	PG Feedback Fault Treatment	0: Warn and keep operation 1: Warn and ramp to stop 2: Warn and coast to stop	2		○		○	○
↗10-03	Detection Time for PG Feedback Fault	0.00~10.0 sec	1.0		○		○	○
↗10-04	ASR (Auto Speed Regulation) Control (P) 1	0~40	10		○		○	
↗10-05	ASR (Auto Speed Regulation) Control (I) 1	0.000~10.000 sec	0.100		○		○	
↗10-06	ASR (Auto Speed Regulation) Control (P) 2	0~40	10		○		○	
↗10-07	ASR (Auto Speed Regulation) Control (I) 2	0.000~10.000 sec	0.100		○		○	
↗10-08	ASR 1/ASR2 Switch Frequency	5.00~600.00Hz	7.00		○		○	
↗10-09	ASR Primary Low Pass Filter Gain	0.000~0.350 sec	0.008				○	
↗10-10	PG Stall Level	0~120% (0: disable)	115		○		○	
↗10-11	PG Stall Detection Time	0.0~2.0 sec	0.1		○		○	
↗10-12	PG Slip Range	0~50% (0: disable)	50		○		○	
↗10-13	PG Slip Detection Time	0.0~10.0 sec	0.5		○		○	
↗10-14	PG Stall and Slip Error Treatment	0: Warn and keep operation 1: Warn and ramp to stop 2: Warn and coast to stop	2		○		○	
↗10-15	Pulse Input Type Setting	0: Disable 1: Phase A leads in a forward run command and phase B leads in a reverse run command 2: Phase B leads in a forward run command and phase A leads in a reverse run command 3: Phase A is a pulse input and phase B is a direction input. (low input=reverse direction, high input=forward direction) 4: Phase A is a pulse input and phase B is a direction input. (low input=forward direction, high input=reverse direction)	0	○	○	○	○	○
↗10-16	Output Setting for Frequency Division (denominator)	1~255	1		○		○	○
↗10-17	PG Electrical Gear A (Channel 1 of PG card)	1~5000	100		○		○	
↗10-18	PG Electrical Gear B (Channel 2 of PG card)	1~5000	100		○		○	
↗10-19	PG Position Control Point (Home)	0~20000	0		○		○	
↗10-20	Range for PG Position Attained (Home range)	0~20000	10		○		○	

Chapter 4 Parameters | **VFD-VE**

Pr.	Explanation	Settings	Factory Setting	VF	VFPG	SVC	FOCPG	TQRP
↯10-21	P Gain of Zero Speed	0~40	10		○		○	
↯10-22	I Gain of Zero Speed	0.000~10.000 sec	0.100	○	○		○	○
↯10-23	Feed Forward Gain of APR	0~100	30		○		○	
↯10-24	Decelerate Time of Position	0.00~600.00 sec/00~6000.0 sec	3.00 3.0		○		○	
↯10-25	Max. Frequency for Resolution Switch	50.00~600.00Hz	50.00	○	○	○	○	○
10-26	Reserved							
↯10-27	PG Mechanical Gear A1	1~65535	100		○		○	○
↯10-28	PG Mechanical Gear B1	1~65535	100		○		○	○
↯10-29	PG Mechanical Gear A2	1~65535	100		○		○	○
↯10-30	PG Mechanical Gear B2	1~65535	100		○		○	○

Group 11 Advanced Parameters

Pr.	Explanation	Settings	Factory Setting	VF	VFPG	SVC	FOCPG	TQRPG
↗11-00	System Control	bit 0: ASR Auto tuning bit 1: Inertia estimate (only for FOCPG mode) bit 2: Zero Servo bit 3: Reserved bit 4: Enable gain adjustment of position loop KP	0				○	
↗11-01	Per Unit of System Inertia	1~65535 (256=1PU)	400				○	○
↗11-02	Low-speed Bandwidth	0~40Hz	10		○		○	○
↗11-03	High-speed Bandwidth	0~40Hz	10		○		○	○
↗11-04	PDFF Gain Value	0~200%	30				○	
↗11-05	Gain Value of Flux Weakening Curve for Motor 1	0~200%	90				○	○
↗11-06	Gain Value of Flux Weakening Curve for Motor 2	0~200%	90				○	○
↗11-07	Detection Time for Phase-loss	0.01~600.00 sec	0.20	○	○	○	○	○
11-08	Reserved							
↗11-09	Level of Phase-loss	0~320.0	60.0	○	○	○	○	○
11-10	Speed Feed Forward Gain	0~100%	0				○	
↗11-11	Zero-speed Bandwidth	0~40Hz	10		○		○	○
↗11-12	Speed Response of Flux Weakening Area	0: Disable 0~150%	65				○	
↗11-13	Notch Filter Depth	0~20db	0				○	
↗11-14	Notch Filter Frequency	0.00~200.00	0.00				○	
↗11-15	Gain Value of Slip Compensation	0.00~1.00	1.00			○		
↗11-16	Low-pass Filter Time of Keypad Display	0.001~65.535sec	0.100	○	○	○	○	○
↗11-17	Low-pass Filter Time of PG2 Pulse Input	0.000~65.535sec	0.100	○	○	○	○	
↗11-18	APR Gain	0.00~40.00	10.00				○	
↗11-19	APR Curve Time	0.00~655.35 sec	3.00				○	
11-20 11-28	Reserved							
11-29	Accumulative Operation Time of Phase-loss	0~65535 (hour)	0	○	○	○	○	○
11-30 11-40	Reserved							

4.2 Version Differences

4.2.1 Version 2.02

New or update parameter groups are:
 Group 2: Digital Input/Output Parameters
 Group 3: Analog Input/Output Parameters
 Group 6: Protection Parameters
 Group 8: High-function PID Parameters
 Group 10: Speed Feedback Control Parameters

4.2.2 Version 2.04

New or update parameter groups are:
 Group 0 System Parameters
 Group 2: Digital Input/Output Parameters
 Group 3: Analog Input/Output Parameters
 Group 5: Motor Parameters
 Group 6: Protection Parameters
 Group 8: High-function PID Parameters
 Group 10: Speed Feedback Control Parameters

Version 2.02

Group 2 Digital Input/Output Parameters

New settings are marked in bold. In version 2.02, the parameters are from Pr.02-00 to Pr.02-34.

Pr.	Explanation	Settings	Factory Setting	VF	VFPG	SVC	FOCPG	TQRP
02-01	Multi-Function Input Command 1 (MI1) (it is Stop terminal for 3-wire operation)	27: ASR1/ASR2 selection			○		○	
02-02	Multi-Function Input Command 2 (MI2)	28: Emergency stop (EF1)		○	○	○	○	○
02-03	Multi-Function Input Command 3 (MI3)	29: Signal confirmation for Y-connection		○	○	○	○	
02-04	Multi-Function Input Command 4 (MI4)	30: Signal confirmation for Δ-connection		○	○	○	○	
02-05	Multi-Function Input Command 5 (MI5)	31: High torque bias (by Pr.07-29)		○	○	○	○	○
02-06	Multi-Function Input Command 6 (MI6) (specific terminal for TRG)	32: Middle torque bias (by Pr.07-30)		○	○	○	○	○
02-23	Multi-Function Input Command 7	33: Low torque bias (by Pr.07-31)		○	○	○	○	○
02-24	Multi-Function Input Command 8	34: Enable multi-step position control			○		○	
02-25	Multi-Function Input Command 9	35: Enable position control			○			
02-26	Multi-Function Input Command 10	36: Enable position learning function (valid at stop)			○		○	
02-27	Multi-Function Input Command 11	37: Enable pulse position input command			○			
02-28	Multi-Function Input Command 12	38: Disable write EEPROM function		○	○	○	○	○
02-29	Multi-Function Input Command 13	39: Torque command direction						○
02-30	Multi-Function Input Command 14	40: Force stop		○	○	○	○	○
		41: Serial position clock					○	○
		42: Serial position input					○	○
		43: Analog input resolution selection					○	
↗02-11	Multi-function Output 1 RA, RB, RC(Relay1)	29: Output when frequency >= Pr.02-33		○	○	○	○	○
↗02-12	Multi-function Output 2 MRA, MRC (Relay2)	30: Output when frequency < Pr.02-33		○	○	○	○	○
↗02-13	Multi-function Output 3 (MO1)	31: Y-connection for the motor coil		○	○	○	○	
↗02-14	Multi-function Output 4 (MO2)	32: Δ connection for the motor coil		○	○	○	○	

Pr.	Explanation	Settings	Factory Setting	VF	VFPG	SVC	FOCPG	TQRPg
↗02-35	Multi-function Output 5 (MO3)	33: Zero speed (actual output frequency)		<input type="checkbox"/>	<input type="checkbox"/>	<input type="checkbox"/>	<input type="checkbox"/>	<input type="checkbox"/>
↗02-36	Multi-function Output 6 (MO4)	34: Zero speed with Stop (actual output frequency)		<input type="checkbox"/>	<input type="checkbox"/>	<input type="checkbox"/>	<input type="checkbox"/>	<input type="checkbox"/>
↗02-37	Multi-function Output 7 (MO5)	35: Error output selection 1 (Pr.06-23)		<input type="checkbox"/>	<input type="checkbox"/>	<input type="checkbox"/>	<input type="checkbox"/>	<input type="checkbox"/>
↗02-38	Multi-function Output 8 (MO6)	36: Error output selection 2 (Pr.06-24)		<input type="checkbox"/>	<input type="checkbox"/>	<input type="checkbox"/>	<input type="checkbox"/>	<input type="checkbox"/>
↗02-39	Multi-function Output 9 (MO7)	37: Error output selection 3 (Pr.06-25)		<input type="checkbox"/>	<input type="checkbox"/>	<input type="checkbox"/>	<input type="checkbox"/>	<input type="checkbox"/>
↗02-40	Multi-function Output 10 (MO8)	38: Error output selection 4 (Pr.06-26)		<input type="checkbox"/>	<input type="checkbox"/>	<input type="checkbox"/>	<input type="checkbox"/>	<input type="checkbox"/>
↗02-41	Multi-function Output 11 (MO9)	39: Position attained (Pr.10-19)		<input type="checkbox"/>	<input type="checkbox"/>	<input type="checkbox"/>	<input type="checkbox"/>	<input type="checkbox"/>
↗02-42	Multi-function Output 12 (MOA)	40: Speed attained (including zero speed)		<input type="checkbox"/>	<input type="checkbox"/>	<input type="checkbox"/>	<input type="checkbox"/>	<input type="checkbox"/>
		41: Multi-position attained		<input type="checkbox"/>	<input type="checkbox"/>	<input type="checkbox"/>	<input type="checkbox"/>	<input type="checkbox"/>
		42: Crane function		<input type="checkbox"/>	<input type="checkbox"/>	<input type="checkbox"/>	<input type="checkbox"/>	<input type="checkbox"/>

Group 3 Analog Input/Output Parameters

In version 2.02, the parameters are from Pr.03-00 to Pr.03-20. The settings for Pr.03-00 to Pr.03-02 are from 0 to 10

Pr.	Explanation	Settings	Factory Setting	VF	VFPG	SVC	FOCPG	TQRPg
↗03-00	Analog Input 1 (AVI)	2: torque command (torque limit under speed mode)	0	<input type="checkbox"/>	<input type="checkbox"/>	<input type="checkbox"/>	<input type="checkbox"/>	<input type="checkbox"/>
		3: Torque compensation command		<input type="checkbox"/>	<input type="checkbox"/>	<input type="checkbox"/>	<input type="checkbox"/>	<input type="checkbox"/>
↗03-01	Analog Input 2 (ACI)	4: PID target value (refer to group 8)		<input type="checkbox"/>	<input type="checkbox"/>	<input type="checkbox"/>	<input type="checkbox"/>	<input type="checkbox"/>
		5: PID feedback signal (refer to group 8)		<input type="checkbox"/>	<input type="checkbox"/>	<input type="checkbox"/>	<input type="checkbox"/>	<input type="checkbox"/>
↗03-02	Analog Input 3 (AUI)	6: P.T.C. thermistor input value		<input type="checkbox"/>	<input type="checkbox"/>	<input type="checkbox"/>	<input type="checkbox"/>	<input type="checkbox"/>
		7: Positive torque limit		<input type="checkbox"/>	<input type="checkbox"/>	<input type="checkbox"/>	<input type="checkbox"/>	<input type="checkbox"/>
		8: Negative torque limit		<input type="checkbox"/>	<input type="checkbox"/>	<input type="checkbox"/>	<input type="checkbox"/>	<input type="checkbox"/>
		9: Regenerative torque limit		<input type="checkbox"/>	<input type="checkbox"/>	<input type="checkbox"/>	<input type="checkbox"/>	<input type="checkbox"/>
		10: Positive/negative torque limit		<input type="checkbox"/>	<input type="checkbox"/>	<input type="checkbox"/>	<input type="checkbox"/>	<input type="checkbox"/>
↗03-20	Analog Output Value in REV Direction	0: Absolute value in REV direction 1: Output 0V in REV direction 2: Enable output voltage in REV direction		0	<input type="checkbox"/>	<input type="checkbox"/>	<input type="checkbox"/>	<input type="checkbox"/>

Group 6 Protection Parameters

In version 2.02, the parameters are from Pr.06-00 to Pr.06-31. The settings of Pr.06-01 are shown as follows. The settings for Pr.06-17 to Pr.06-22 are from 0 to 62.

Pr.	Explanation	Settings	Factory Setting	VF	VFPG	SVC	FOCPG	TQRPg
↗06-01	Over-voltage Stall Prevention	0.0: Disable 350.0~450.0Vdc 700.0~900.0Vdc	380.0 760.0	<input type="checkbox"/>	<input type="checkbox"/>	<input type="checkbox"/>	<input type="checkbox"/>	<input type="checkbox"/>
06-17	Present Fault Record	0: No fault	0	<input type="checkbox"/>	<input type="checkbox"/>	<input type="checkbox"/>	<input type="checkbox"/>	<input type="checkbox"/>
06-18	Second Most Recent Fault Record	1: Over-current during acceleration (ocA)	0	<input type="checkbox"/>	<input type="checkbox"/>	<input type="checkbox"/>	<input type="checkbox"/>	<input type="checkbox"/>
06-19	Third Most Recent Fault Record	2: Over-current during deceleration (ocd)	0	<input type="checkbox"/>	<input type="checkbox"/>	<input type="checkbox"/>	<input type="checkbox"/>	<input type="checkbox"/>
06-20	Fourth Most Recent Fault Record	3: Over-current during constant speed (ocn)	0	<input type="checkbox"/>	<input type="checkbox"/>	<input type="checkbox"/>	<input type="checkbox"/>	<input type="checkbox"/>
06-21	Fifth Most Recent Fault Record		0	<input type="checkbox"/>	<input type="checkbox"/>	<input type="checkbox"/>	<input type="checkbox"/>	<input type="checkbox"/>
06-22	Sixth Most Recent Fault Record		0	<input type="checkbox"/>	<input type="checkbox"/>	<input type="checkbox"/>	<input type="checkbox"/>	<input type="checkbox"/>

Pr.	Explanation	Settings	Factory Setting	VF	VFP	SVC	FOCPG	TQRP
		4: Ground fault (GFF) 5: IGBT short-circuit (occ) 6: Over-current at stop (ocS) 7: Over-voltage during acceleration (ovA) 8: Over-voltage during deceleration (ovd) 9: Over-voltage during constant speed (ovn) 10: Over-voltage at stop (ovS) 11: Low-voltage during acceleration (LvA) 12: Low-voltage during deceleration (Lvd) 13: Low-voltage during constant speed (Lvn) 14: Low-voltage at stop (LvS) 15: Phase loss (PHL) 16: IGBT heat sink over-heat (oH1) 17: Heat sink over-heat (oH2)(for 40HP above) 18: TH1 open loop error (tH1o) 19: TH2 open loop error (tH2o) 20: Fan error signal output 21: over-load (oL) (150% 1Min) 22: Motor 1 over-load (EoL1) 23: Motor 2 over-load (EoL2) 24: Motor PTC overheat (oH3) 25: Fuse error (FuSE) 26: over-torque 1 (ot1) 27: over-torque 1 (ot2) 28: Insufficient torque 1 29: Insufficient torque 2 30: Memory write-in error (cF1) 31: Memory read-out error (cF2) 32: Isum current detection error (cd0) 33: U-phase current detection error (cd1) 34: V-phase current detection error (cd2) 35: W-phase current detection error (cd3) 36: Clamp current detection error (Hd0) 37: Over-current detection error (Hd1) 38: Over-voltage detection error (Hd2) 39: Ground current detection error (Hd3) 40: Auto tuning error (AuE) 41: PID feedback loss (AFE) 42: PG feedback error (PGF1) 43: PG feedback loss (PGF2) 44: PG feedback stall (PGF3) 45: PG slip error (PGF4) 46: PG ref input error (PGr1) 47: PG ref loss (PGr2) 48: Analog current input loss (ACE) 49: External fault input (EF) 50: Emergency stop (EF1) 51: External Base Block (B.B.) 52: Password error (PcodE) 53: Software error (ccodE) 54: Communication error (cE1) 55: Communication error (cE2) 56: Communication error (cE3) 57: Communication error (cE4) 58: Communication Time-out (cE10) 59: PU time-out (cP10) 60: Brake transistor error (bF) 61: Y-connection/Δ-connection switch error (ydc) 62: Decel. Energy Backup Error (dEb)						
∕06-31	Filter Time for PTC Detection	0.00~10.00sec	0.20	○	○	○	○	○

Group 8 High-function PID Parameters

In version 2.02, the parameters are from Pr.08-00 to Pr.08-15.

Pr.	Explanation	Settings	Factory Setting	VF	VFPG	SVC	FOCPG	TQRPg
↗08-15	Filter Time for PID Feedback	0.1~300.0 sec	5.0	<input type="radio"/>	<input type="radio"/>	<input type="radio"/>	<input type="radio"/>	

Group 10 Speed Feedback Control Parameters

In version 2.02, the parameters are from Pr.10-00 to Pr.10-28.

Pr.	Explanation	Settings	Factory Setting	VF	VFPG	SVC	FOCPG	TQRPg
↗10-28	PG Mechanical Gear B1	1~5000	100		<input type="radio"/>		<input type="radio"/>	<input type="radio"/>

Group 11 Advanced Parameters

In version 2.02, the parameters are from Pr.11-00 to Pr.11-30.

Pr.	Explanation	Settings	Factory Setting	VF	VFPG	SVC	FOCPG	TQRPg
↗11-09	Level of Phase-loss	0.0~320.0	60.0	<input type="radio"/>	<input type="radio"/>	<input type="radio"/>	<input type="radio"/>	<input type="radio"/>
11-10	Reserved							
11-18 11-28	Reserved							
11-29	Accumulative Operation Time of Phase-loss	0~65535 (hour)	0	<input type="radio"/>	<input type="radio"/>	<input type="radio"/>	<input type="radio"/>	<input type="radio"/>
↗11-30	APR Curve Time	0.00~655.35 sec	3.00				<input type="radio"/>	

Version 2.04

Group 0 System Parameters

Pr.	Explanation	Settings	Factory Setting	VF	VFPG	SVC	FOCPG	TQRPg
↗00-03	Start-up Display Selection	0: Display the frequency command value (LED F) 1: Display the actual output frequency (LED H) 2: Multifunction display, see Pr.00-04 (LED U) 3: Display the output current (A)	0	<input type="radio"/>	<input type="radio"/>	<input type="radio"/>	<input type="radio"/>	<input type="radio"/>
↗00-04	Content of Multi Function Display	0: Display output current (A) 1: Display counter value (C) 2: Display output frequency (H) 3: Display DC-BUS voltage (U) 4: Display output voltage (E) 5: Output power factor angle (n) 6: Display output power (kW) 7: Display actual motor speed (HU) 8: Display estimate output torque (kg-m) 9: Display PG position (G) (refer to Pr.10-00 and Pr.10-01) 10: Display PID feedback 11: Display AVI (%) 12: Display ACI (%) 13: Display AUI (%) 14: Display the temperature of heat sink (°C) 15: Display the temperature of IGBT (°C) 16: The status of digital input (ON/OFF) 17: The status of digital output (ON/OFF) 18: Multi-step speed 19: The corresponding CPU pin status of digital input 20: The corresponding CPU pin status of digital output 21: Number of actual motor revolution (PG1 of PG card) 22: Pulse input frequency (PG2 of PG card) 23: Pulse input position (PG2 of PG card)	0	<input type="radio"/>	<input type="radio"/>	<input type="radio"/>	<input type="radio"/>	<input type="radio"/>

Group 2 Digital Input/Output Parameters

New settings 44~50 for Pr.02-00~Pr.02-06 and new parameter 02-43.

Pr.	Explanation	Settings	Factory Setting	VF	VFP	SVC	FOCPG	TQRP
02-00	2-wire/3-wire Operation Control	0: FWD/STOP, REV/STOP 1: FWD/STOP, REV/STOP (Line Start Lockout) 2: RUN/STOP, REV/FWD 3: RUN/STOP, REV/FWD (Line Start Lockout) 4: 3-wire (momentary push button) 5: 3-wire (momentary push button and Line Start Lockout)	0	<input type="radio"/>	<input type="radio"/>	<input type="radio"/>	<input type="radio"/>	<input type="radio"/>
02-01	Multi-Function Input Command 1 (MI1) (it is Stop terminal for 3-wire operation)	0: no function 1: multi-step speed command 1/multi-step position command 1 2: multi-step speed command 2/ multi-step position command 2	1	<input type="radio"/>	<input type="radio"/>	<input type="radio"/>	<input type="radio"/>	<input type="radio"/>
02-02	Multi-Function Input Command 2 (MI2)	3: multi-step speed command 3/ multi-step position command 3 4: multi-step speed command 4/ multi-step position command 4	2	<input type="radio"/>	<input type="radio"/>	<input type="radio"/>	<input type="radio"/>	<input type="radio"/>
02-03	Multi-Function Input Command 3 (MI3)	5: Reset 6: JOG command	3	<input type="radio"/>	<input type="radio"/>	<input type="radio"/>	<input type="radio"/>	<input type="radio"/>
02-04	Multi-Function Input Command 4 (MI4)	7: acceleration/deceleration speed inhibit 8: the 1st, 2nd acceleration/deceleration time selection	4	<input type="radio"/>	<input type="radio"/>	<input type="radio"/>	<input type="radio"/>	<input type="radio"/>
02-05	Multi-Function Input Command 5 (MI5)	9: the 3rd, 4th acceleration/deceleration time selection 10: EF input (07-36)	0	<input type="radio"/>	<input type="radio"/>	<input type="radio"/>	<input type="radio"/>	<input type="radio"/>
02-06	Multi-Function Input Command 6 (MI6) (specific terminal for TRG)	11: B.B. input 12: Output stop	0	<input type="radio"/>	<input type="radio"/>	<input type="radio"/>	<input type="radio"/>	<input type="radio"/>
02-23	Multi-Function Input Command 7	13: cancel the setting of the optimal acceleration/deceleration time	0	<input type="radio"/>	<input type="radio"/>	<input type="radio"/>	<input type="radio"/>	<input type="radio"/>
02-24	Multi-Function Input Command 8	14: switch between drive settings 1 and 2	0	<input type="radio"/>	<input type="radio"/>	<input type="radio"/>	<input type="radio"/>	<input type="radio"/>
02-25	Multi-Function Input Command 9	15: operation speed command form AVI	0	<input type="radio"/>	<input type="radio"/>	<input type="radio"/>	<input type="radio"/>	<input type="radio"/>
02-26	Multi-Function Input Command 10	16: operation speed command form ACI	0	<input type="radio"/>	<input type="radio"/>	<input type="radio"/>	<input type="radio"/>	<input type="radio"/>
02-27	Multi-Function Input Command 11	17: operation speed command form AUI	0	<input type="radio"/>	<input type="radio"/>	<input type="radio"/>	<input type="radio"/>	<input type="radio"/>
02-28	Multi-Function Input Command 12	18: Emergency Stop (07-36)	0	<input type="radio"/>	<input type="radio"/>	<input type="radio"/>	<input type="radio"/>	<input type="radio"/>
02-29	Multi-Function Input Command 13	19: Digital Up command	0	<input type="radio"/>	<input type="radio"/>	<input type="radio"/>	<input type="radio"/>	<input type="radio"/>
02-30	Multi-Function Input Command 14	20: Digital Down command	0	<input type="radio"/>	<input type="radio"/>	<input type="radio"/>	<input type="radio"/>	<input type="radio"/>
		21: PID function disabled		<input type="radio"/>	<input type="radio"/>	<input type="radio"/>	<input type="radio"/>	<input type="radio"/>
		22: clear counter		<input type="radio"/>	<input type="radio"/>	<input type="radio"/>	<input type="radio"/>	<input type="radio"/>
		23: input the counter value (multi-function input command 6)		<input type="radio"/>	<input type="radio"/>	<input type="radio"/>	<input type="radio"/>	<input type="radio"/>
		24: FWD JOG command		<input type="radio"/>	<input type="radio"/>	<input type="radio"/>	<input type="radio"/>	<input type="radio"/>
		25: REV JOG command		<input type="radio"/>	<input type="radio"/>	<input type="radio"/>	<input type="radio"/>	<input type="radio"/>
		26: TQC+PG/FOC+PG model selection		<input type="radio"/>	<input type="radio"/>	<input type="radio"/>	<input type="radio"/>	<input type="radio"/>
		27: ASR1/ASR2 selection		<input type="radio"/>	<input type="radio"/>	<input type="radio"/>	<input type="radio"/>	<input type="radio"/>
		28: Emergency stop (EF1)		<input type="radio"/>	<input type="radio"/>	<input type="radio"/>	<input type="radio"/>	<input type="radio"/>
		29: Signal confirmation for Y-connection		<input type="radio"/>	<input type="radio"/>	<input type="radio"/>	<input type="radio"/>	<input type="radio"/>
		30: Signal confirmation for Δ-connection		<input type="radio"/>	<input type="radio"/>	<input type="radio"/>	<input type="radio"/>	<input type="radio"/>
		31: High torque bias (by Pr.07-29)		<input type="radio"/>	<input type="radio"/>	<input type="radio"/>	<input type="radio"/>	<input type="radio"/>
		32: Middle torque bias (by Pr.07-30)		<input type="radio"/>	<input type="radio"/>	<input type="radio"/>	<input type="radio"/>	<input type="radio"/>
		33: Low torque bias (by Pr.07-31)		<input type="radio"/>	<input type="radio"/>	<input type="radio"/>	<input type="radio"/>	<input type="radio"/>
		34: Enable multi-step position control		<input type="radio"/>	<input type="radio"/>	<input type="radio"/>	<input type="radio"/>	<input type="radio"/>
		35: Enable position control		<input type="radio"/>	<input type="radio"/>	<input type="radio"/>	<input type="radio"/>	<input type="radio"/>
		36: Enable position learning function (valid at stop)		<input type="radio"/>	<input type="radio"/>	<input type="radio"/>	<input type="radio"/>	<input type="radio"/>
		37: Enable pulse position input command		<input type="radio"/>	<input type="radio"/>	<input type="radio"/>	<input type="radio"/>	<input type="radio"/>
		38: Disable write EEPROM function		<input type="radio"/>	<input type="radio"/>	<input type="radio"/>	<input type="radio"/>	<input type="radio"/>
		39: Torque command direction		<input type="radio"/>	<input type="radio"/>	<input type="radio"/>	<input type="radio"/>	<input type="radio"/>
		40: Force stop		<input type="radio"/>	<input type="radio"/>	<input type="radio"/>	<input type="radio"/>	<input type="radio"/>
		41: Serial position clock		<input type="radio"/>	<input type="radio"/>	<input type="radio"/>	<input type="radio"/>	<input type="radio"/>
		42: Serial position input		<input type="radio"/>	<input type="radio"/>	<input type="radio"/>	<input type="radio"/>	<input type="radio"/>
		43: Analog input resolution selection		<input type="radio"/>	<input type="radio"/>	<input type="radio"/>	<input type="radio"/>	<input type="radio"/>

Pr.	Explanation	Settings	Factory Setting	VF	VFP	SVC	FOCPG	TQRP
		44: Reset initial reel diameter		○	○	○	○	○
		45: Reset initial reel diameter 0		○	○	○	○	○
		46: Reset initial reel diameter 1		○	○	○	○	○
		47: Reset PID control integration of tension		○	○	○	○	○
		48: Mechanical gear ratio switch			○		○	○
		49: Reserved						
		50: Reserved						
↗02-11	Multi-function Output 1 RA, RB, RC(Relay1)	0: No function 1: Operation indication	11	○	○	○	○	○
↗02-12	Multi-function Output 2 MRA, MRC (Relay2)	2: Operation speed attained 3: Desired frequency attained 1 (Pr.02-19)	1	○	○	○	○	○
↗02-13	Multi-function Output 3 (MO1)	4: Desired frequency attained 2 (Pr.02-21) 5: Zero speed (frequency command) 6: Zero speed with stop (frequency command) 7: Over torque (OT1) (Pr.06-06-06-08) 8: Over torque (OT2) (Pr.06-09-06-11)	0	○	○	○	○	○
↗02-14	Multi-function Output 4 (MO2)	9: Drive ready 10: User-defined Low-voltage Detection 11: Malfunction indication	0	○	○	○	○	○
↗02-35	Multi-function Output 5 (MO3)	12: Mechanical brake release (Pr.02-31) 13: Overheat 14: Software brake signal		○	○	○	○	○
↗02-36	Multi-function Output 6 (MO4)	15: PID feedback error 16: Slip error (oS _L) 17: Terminal count value attained (Pr.02-16)		○	○	○	○	○
↗02-37	Multi-function Output 7 (MO5)	18: Preliminary count value attained (Pr.02-17) 19: Baseblock (B.B.) Indication		○	○	○	○	○
↗02-38	Multi-function Output 8 (MO6)	20: Warning output 21: Over voltage warning 22: Over-current stall prevention warning 23: Over-voltage stall prevention warning		○	○	○	○	○
↗02-39	Multi-function Output 9 (MO7)	24: Operation mode indication 25: Forward command 26: Reverse command		○	○	○	○	○
↗02-40	Multi-function Output 10 (MO8)	27: Output when current >= Pr.02-32 28: Output when current < Pr.02-32 29: Output when frequency >= Pr.02-33		○	○	○	○	○
↗02-41	Multi-function Output 11 (MO9)	30: Output when frequency < Pr.02-33 31: Y-connection for the motor coil 32: A connection for the motor coil		○	○	○	○	○
↗02-42	Multi-function Output 12 (MOA)	33: Zero speed (actual output frequency) 34: Zero speed with Stop (actual output frequency) 35: Error output selection 1 (Pr.06-23) 36: Error output selection 2 (Pr.06-24) 37: Error output selection 3 (Pr.06-25) 38: Error output selection 4 (Pr.06-26) 39: Position attained (Pr.10-19) 40: Speed attained (including zero speed) 41: Multi-position attained 42: Crane function 43: Motor zero-speed output (Pr.02-43) 44: Max. reel diameter attained 45: Empty reel diameter attained 46: Broken belt detection 47: Break release at stop 48: Error PID feedback of tension 49: Reserved		○	○	○	○	○

Pr.	Explanation	Settings	Factory Setting	VF	VFPG	SVC	FOCPG	TQRPg
		50: Reserved						
№02-43	Zero-speed Level of Motor	0-65535 rpm	0	○	○	○	○	○

Group 3 Analog Input/Output Parameters

New settings 11~16 for Pr.03-00~Pr.03-02 and new parameters 03-21~03-26.

Pr.	Explanation	Settings	Factory Setting	VF	VFPG	SVC	FOCPG	TQRPg
№03-00	Analog Input 1 (AVI)	0: No function	1	○	○	○	○	○
№03-01	Analog Input 2 (ACI)	1: Frequency command (torque limit under TQR control mode)	0	○	○	○	○	○
№03-02	Analog Input 3 (AUI)	2: torque command (torque limit under speed mode)	0					○
		3: Torque compensation command		○	○	○	○	○
		4: PID target value (refer to group 8)		○	○	○	○	
		5: PID feedback signal (refer to group 8)		○	○	○	○	
		6: P.T.C. thermistor input value		○	○	○	○	
		7: Positive torque limit					○	
		8: Negative torque limit					○	
		9: Regenerative torque limit					○	
		10: Positive/negative torque limit					○	
		11: PID feedback signal of tension		○	○	○	○	○
		12: Line speed		○	○	○	○	○
		13: Reel diameter		○	○	○	○	○
		14: PID target value of tension (tension closed-loop)		○	○	○	○	○
		15: Tension setting (tension open-loop)						○
		16: Zero-speed tension						○
		17: Tension taper						○
№03-18	Analog Output Selection	0: Output frequency (Hz)	0	○	○	○	○	○
		1: Frequency command (Hz)		○	○	○	○	○
№03-21	Analog Output Selection 2	2: Motor speed (Hz)		○	○	○	○	○
		3: Output current (rms)		○	○	○	○	○
№03-24	Analog Output Selection 3	4: Output voltage		○	○	○	○	○
		5: DC Bus Voltage		○	○	○	○	○
		6: Power factor		○	○	○	○	○
		7: Power		○	○	○	○	○
		8: Output torque		○	○	○	○	○
		9: AVI		○	○	○	○	○
		10: ACI		○	○	○	○	○
		11: AUI		○	○	○	○	○
		12: q-axis current		○	○	○	○	○
		13: q-axis feedback value		○	○	○	○	○
		14: d-axis current		○	○	○	○	○
		15: d-axis feedback value		○	○	○	○	○
		16: q-axis voltage		○	○	○	○	○
		17: d-axis voltage		○	○	○	○	○
		18: Torque command		○	○	○	○	○
		19: Pulse frequency command		○	○	○	○	○
№03-22	Analog Output Gain 2	0-200.0%	100.0	○	○	○	○	○
№03-23	Analog Output Value in REV Direction 2	0: Absolute value in REV direction 1: Output 0V in REV direction 2: Enable output voltage in REV direction	0	○	○	○	○	○
№03-25	Analog Output Gain 3	0-200.0%	100.0	○	○	○	○	○
№03-26	Analog Output Value in REV Direction 3	0: Absolute value in REV direction 1: Output 0V in REV direction 2: Enable output voltage in REV direction	0	○	○	○	○	○

Group 5 Motor Parameters

Pr.	Explanation	Settings	Factory Setting	VF	VFPG	SVC	FOCPG	TQRPg
05-00	Motor Auto Tuning	0: No function 1: Rolling test 2: Static Test 3: Reserved	0			○	○	○
05-01	Full-load Current of Motor 1	40-100%	###	○	○	○	○	○
05-02	Rated power of Motor 1	0-655.35	###			○	○	○
05-03	Rated speed of Motor 1 (rpm)	0-65535 1710 (60Hz, 4 poles), 1410 (50Hz, 4 poles)	1710		○	○	○	○

Group 6 Protection Parameters

New setting 0 for Pr.06-01, new settings 64~65 for Pr.06-17~Pr.06-22 and new parameters 06-32~06-36.

Pr.	Explanation	Settings	Factory Setting	VF	VFPG	SVC	FOCPG	TQRPg
06-01	Over-voltage Stall Prevention	0.0: Disable						
		350.0~450.0Vdc	380.0	○	○	○	○	○
		700.0~900.0Vdc	760.0	○	○	○	○	○
06-17	Present Fault Record	0: No fault 1: Over-current during acceleration (oCA) 2: Over-current during deceleration (ocd) 3: Over-current during constant speed (ocn)	0	○	○	○	○	○
06-18	Second Most Recent Fault Record	4: Ground fault (GFF) 5: IGBT short-circuit (occ) 6: Over-current at stop (ocS) 7: Over-voltage during acceleration (ovA)	0	○	○	○	○	○
06-19	Third Most Recent Fault Record	8: Over-voltage during deceleration (ovd) 9: Over-voltage during constant speed (ovn) 10: Over-voltage at stop (ovS) 11: Low-voltage during acceleration (LvA)	0	○	○	○	○	○
06-20	Fourth Most Recent Fault Record	12: Low-voltage during deceleration (Lvd) 13: Low-voltage during constant speed (Lvn) 14: Low-voltage at stop (LvS) 15: Phase loss (PHL) 16: IGBT heat sink over-heat (oH1)	0	○	○	○	○	○
06-21	Fifth Most Recent Fault Record	17: Heat sink over-heat (oH2)(for 40HP above) 18: TH1 open loop error (th1o) 19: TH2 open loop error (th2o) 20: Fan error signal output 21: over-load (oL) (150% 1Min) 22: Motor 1 over-load (EoL1) 23: Motor 2 over-load (EoL2) 24: Motor PTC overheat (oH3) 25: Fuse error (FuSE) 26: over-torque 1 (ot1) 27: over-torque 2 (ot2) 28: Reserved 29: Reserved 30: Memory write-in error (cF1) 31: Memory read-out error (cF2) 32: Isum current detection error (cd0) 33: U-phase current detection error (cd1) 34: V-phase current detection error (cd2) 35: W-phase current detection error (cd3) 36: Clamp current detection error (Hd0) 37: Over-current detection error (Hd1) 38: Over-voltage detection error (Hd2)	0	○	○	○	○	○
06-22	Sixth Most Recent Fault Record							

Pr.	Explanation	Settings	Factory Setting	VF	VFPG	SVC	FOCPG	TQPRG
		39: Ground current detection error (Hd3)		<input type="checkbox"/>	<input type="checkbox"/>	<input type="checkbox"/>	<input type="checkbox"/>	<input type="checkbox"/>
		40: Auto tuning error (AuE)		<input type="checkbox"/>	<input type="checkbox"/>	<input type="checkbox"/>	<input type="checkbox"/>	<input type="checkbox"/>
		41: PID feedback loss (AFE)		<input type="checkbox"/>	<input type="checkbox"/>	<input type="checkbox"/>	<input type="checkbox"/>	<input type="checkbox"/>
		42: PG feedback error (PGF1)		<input type="checkbox"/>	<input type="checkbox"/>	<input type="checkbox"/>	<input type="checkbox"/>	<input type="checkbox"/>
		43: PG feedback loss (PGF2)		<input type="checkbox"/>	<input type="checkbox"/>	<input type="checkbox"/>	<input type="checkbox"/>	<input type="checkbox"/>
		44: PG feedback stall (PGF3)		<input type="checkbox"/>	<input type="checkbox"/>	<input type="checkbox"/>	<input type="checkbox"/>	<input type="checkbox"/>
		45: PG slip error (PGF4)		<input type="checkbox"/>	<input type="checkbox"/>	<input type="checkbox"/>	<input type="checkbox"/>	<input type="checkbox"/>
		46: PG ref input error (PGr1)		<input type="checkbox"/>	<input type="checkbox"/>	<input type="checkbox"/>	<input type="checkbox"/>	<input type="checkbox"/>
		47: PG ref loss (PGr2)		<input type="checkbox"/>	<input type="checkbox"/>	<input type="checkbox"/>	<input type="checkbox"/>	<input type="checkbox"/>
		48: Analog current input loss (ACE)		<input type="checkbox"/>	<input type="checkbox"/>	<input type="checkbox"/>	<input type="checkbox"/>	<input type="checkbox"/>
		49: External fault input (EF)		<input type="checkbox"/>	<input type="checkbox"/>	<input type="checkbox"/>	<input type="checkbox"/>	<input type="checkbox"/>
		50: Emergency stop (EF1)		<input type="checkbox"/>	<input type="checkbox"/>	<input type="checkbox"/>	<input type="checkbox"/>	<input type="checkbox"/>
		51: External Base Block (B.B.)		<input type="checkbox"/>	<input type="checkbox"/>	<input type="checkbox"/>	<input type="checkbox"/>	<input type="checkbox"/>
		52: Password error (PcodE)		<input type="checkbox"/>	<input type="checkbox"/>	<input type="checkbox"/>	<input type="checkbox"/>	<input type="checkbox"/>
		53: Reserved		<input type="checkbox"/>	<input type="checkbox"/>	<input type="checkbox"/>	<input type="checkbox"/>	<input type="checkbox"/>
		54: Communication error (cE1)		<input type="checkbox"/>	<input type="checkbox"/>	<input type="checkbox"/>	<input type="checkbox"/>	<input type="checkbox"/>
		55: Communication error (cE2)		<input type="checkbox"/>	<input type="checkbox"/>	<input type="checkbox"/>	<input type="checkbox"/>	<input type="checkbox"/>
		56: Communication error (cE3)		<input type="checkbox"/>	<input type="checkbox"/>	<input type="checkbox"/>	<input type="checkbox"/>	<input type="checkbox"/>
		57: Communication error (cE4)		<input type="checkbox"/>	<input type="checkbox"/>	<input type="checkbox"/>	<input type="checkbox"/>	<input type="checkbox"/>
		58: Communication Time-out (cE10)		<input type="checkbox"/>	<input type="checkbox"/>	<input type="checkbox"/>	<input type="checkbox"/>	<input type="checkbox"/>
		59: PU time-out (cP10)		<input type="checkbox"/>	<input type="checkbox"/>	<input type="checkbox"/>	<input type="checkbox"/>	<input type="checkbox"/>
		60: Brake transistor error (bF)		<input type="checkbox"/>	<input type="checkbox"/>	<input type="checkbox"/>	<input type="checkbox"/>	<input type="checkbox"/>
		61: Y-connection/ Δ -connection switch error (ydc)		<input type="checkbox"/>	<input type="checkbox"/>	<input type="checkbox"/>	<input type="checkbox"/>	<input type="checkbox"/>
		62: Decel. Energy Backup Error (dEb)		<input type="checkbox"/>	<input type="checkbox"/>	<input type="checkbox"/>	<input type="checkbox"/>	<input type="checkbox"/>
		63: Slip error (oSL)		<input type="checkbox"/>	<input type="checkbox"/>	<input type="checkbox"/>	<input type="checkbox"/>	<input type="checkbox"/>
		64: Broken belt error (bEb)		<input type="checkbox"/>	<input type="checkbox"/>	<input type="checkbox"/>	<input type="checkbox"/>	<input type="checkbox"/>
		65: Error PID feedback signal of tension (tdEv)		<input type="checkbox"/>	<input type="checkbox"/>	<input type="checkbox"/>	<input type="checkbox"/>	<input type="checkbox"/>
06-32	Output Frequency for Malfunction	0.00~655.35 Hz	0.00	<input type="checkbox"/>	<input type="checkbox"/>	<input type="checkbox"/>	<input type="checkbox"/>	<input type="checkbox"/>
06-33	Output AC Voltage for Malfunction	0.0~6553.5 V	0.0	<input type="checkbox"/>	<input type="checkbox"/>	<input type="checkbox"/>	<input type="checkbox"/>	<input type="checkbox"/>
06-34	DC Voltage for Malfunction	0.0~6553.5 V	0.0	<input type="checkbox"/>	<input type="checkbox"/>	<input type="checkbox"/>	<input type="checkbox"/>	<input type="checkbox"/>
06-35	Current Value for Malfunction	0.00~655.35 Amp	0.00	<input type="checkbox"/>	<input type="checkbox"/>	<input type="checkbox"/>	<input type="checkbox"/>	<input type="checkbox"/>
06-36	IGBT Temperature for Malfunction	0.0~6553.5 °C	0.0	<input type="checkbox"/>	<input type="checkbox"/>	<input type="checkbox"/>	<input type="checkbox"/>	<input type="checkbox"/>

Group 8 High-function PID Parameters

New parameters 08-21~08-99

Pr.	Explanation	Settings	Factory Setting	VF	VFPG	SVC	FOCPG	TQPRG
↗08-00	Input Terminal for PID Feedback	0: No function 1: Negative PID feedback from external terminal AVI (Pr.03-00) 2: Negative PID feedback from PG card (Pr.10-15, skip direction) 3: Negative PID feedback from PG card (Pr.10-15) 4: Positive PID feedback from external terminal AVI (Pr.03-00) 5: Positive PID feedback from PG card (Pr.10-15, skip direction) 6: Positive PID feedback from PG card (Pr.10-15)	0	<input type="checkbox"/>	<input type="checkbox"/>	<input type="checkbox"/>	<input type="checkbox"/>	
↗08-01	Proportional Gain (P)	0.0~500.0%	80.0	<input type="checkbox"/>	<input type="checkbox"/>	<input type="checkbox"/>	<input type="checkbox"/>	
08-21	Tension Control Selection	0: Disable 1: Closed-loop, speed mode 2: Line speed, speed mode 3: Reserved 4: Open-loop, torque mode	0	<input type="checkbox"/>	<input type="checkbox"/>	<input type="checkbox"/>	<input type="checkbox"/>	<input type="checkbox"/>

Pr.	Explanation	Settings	Factory Setting	VF	VFP	SVC	FOCPG	TQRPG
08-22	Wind Mode	0: Rewind 1: Unwind	0	○	○	○	○	○
08-23	Mechanical Gear Ratio A	1-65535	100	○	○	○	○	○
08-24	Mechanical Gear Ratio B	1-65535	100	○	○	○	○	○
08-25	Source of the Tension Command/Line Speed	0: Parameter setting (Pr.08-26) 1: RS-485 communication setting (Pr.08-26) 2: Analog input (Pr. 03-00-03-02 is set to 14 PID target value of tension, 03-00-03-02 is set to 12 line speed)	0	○	○	○	○	○
08-26	PID Target Value of Tension/Line Speed	0.0~100.0%	50.0	○	○	○	○	○
08-27	Source of Tension/Line Speed PID Feedback	0: Analog input (Pr. 03-00-03-02 is set to 11 PID feedback of tension) 1: Pulse input (Pr.08-40)	0	○	○	○	○	○
08-28	Auto-tuning Tension PID	0: Disable 1: Reel diameter (08-29~08-31 corresponds to 08-44, 08-32~08-34 corresponds to 08-43) 2: Frequency (08-29~08-31 corresponds to 01-07, 08-32~08-34 corresponds to 01-00)		○	○	○	○	○
08-29	Tension PID P1	0.0~1000.0	50.0	○	○	○	○	○
08-30	Tension PID I1	0.00~500.00 sec	1.00	○	○	○	○	○
08-31	Reserved							
08-32	Tension PID P2	0.0~1000.0	50.0	○	○	○	○	○
08-33	Tension PID I2	0.00~500.00 sec	1.00	○	○	○	○	○
08-34	Reserved							
08-35	PID/Line Speed Output Status	0: Positive output 1: Negative output	0	○	○	○	○	○
08-36	Tension/Line Speed PID Output Limit	0~100.00% (according to Pr.01-00)	20.00	○	○	○	○	○
08-37	Source of Line Speed Input Command	0: Disable 1: Analog input (Pr. 03-00-03-02 is set to 12 line speed) 2: RS-485 communication setting (Pr.08-41) 3: Pulse input (Pr.08-40) 4: DFM-DCM pulse input (Pr.02-18)	0	○	○	○	○	○
08-38	Max. Line Speed	0.0~3000.0m/min	1000.0	○	○	○	○	○
08-39	Min. Line Speed	0.0~3000.0m/min	0.0	○	○	○	○	○
08-40	Pulse Number for Each Meter	0.0~6000.0	0.0	○	○	○	○	○
08-41	Current Line Speed	0.0~3000.0m/min	0.0	○	○	○	○	○
08-42	Source of Reel Diameter	0: Calculated by line speed 1: Calculated by integrating thickness (encoder is on reel shaft)(Pr.08-49~51, Pr.10-15) 2: Calculated by integrating thickness (encoder is on motor)(Pr.08-23~08-24, 08-50~08-51, 10-00~10-01) 3: Calculated by analog input (Pr.03-00-03-02 is set to 13)	0	○	○	○	○	○
08-43	Max. Reel Diameter	1.0~6000.0mm	6000.0	○	○	○	○	○
08-44	Empty Reel Diameter	1.0~6000.0mm	1.0	○	○	○	○	○
08-45	Source of Initial Reel Diameter	0: RS-485 communication setting (Pr.08-46) 1: Analog input (Pr.03-00-Pr.03-02 is set to 13)	0	○	○	○	○	○
08-46	Initial Reel Diameter	1.0~6000.0mm	1.0	○	○	○	○	○
08-47	Initial Reel Diameter 1	1.0~6000.0mm	1.0	○	○	○	○	○
08-48	Initial Reel Diameter 2	1.0~6000.0mm	1.0	○	○	○	○	○
08-49	Number of Pulse per Revolution	1~1000ppr	1	○	○	○	○	○
08-50	Coil Number for Each Layer	0.001~60.000mm	1.000	○	○	○	○	○
08-51	Material Thickness	0.001~60.000mm	1.000	○	○	○	○	○
08-52	Filter Time of Reel Diameter	0.00 to 100.00 seconds	1.00	○	○	○	○	○
08-53	Auto Compensation of	0: Disable	1.00	○	○	○	○	○

Chapter 4 Parameters | VFD-VE

Pr.	Explanation	Settings	Factory Setting	VF	VFPG	SVC	FOCPG	TQRP
	Reel Diameter	1: Enable						
∕08-54	Current Reel Diameter	1.0~6000.0mm	1.0	○	○	○	○	○
08-55	Smart Start	0: Disable 1: Enable 2: In unwind mode, rewind in reverse direction	1	○	○	○	○	○
08-56	Switch Level for Smart Start and PID function	0.0~100.0% (according to Pr.08-26)	15.0	○	○	○	○	○
08-57	Frequency for Smart Start	0.00~600.00Hz	2.00	○	○	○	○	○
∕08-58	Accel. Time for Smart Start	0.01~600.00 seconds	3.00	○	○	○	○	
08-59	Broken Belt Detection	0: Disable 1: Enable	0	○	○	○	○	
08-60	Min. Line Speed of Broken Belt Detection	0.0~3000.0m/min	0.0	○	○	○	○	
08-61	Allowance Error of Line Speed of Broken Belt Detection	1.0~6000.0mm	100.0	○	○	○	○	
08-62	Detection Time of Broken Belt	0.00~100.00 sec	1.00	○	○	○	○	
08-63	Allowance Error Level of Tension/Line Speed PID Feedback	0~100%	100	○	○	○	○	
08-64	Allowance Error Detection Time of Tension PID Feedback	0.0~10.0 sec	0.5	○	○	○	○	
08-65	Error Treatment of Tension PID Feedback	0: Warn and keep operation 1: Warn and coast to stop 2: Warn and ramp to stop	0	○	○	○	○	
08-66	Upper Limit of Tension PID Feedback	0.0~100.0%	100.0	○	○	○	○	○
08-67	Lower Limit of Tension PID Feedback	0.0~100.0%	0.0	○	○	○	○	○
08-68	Reserved							
08-69	DFM Selection	0: Output frequency 1: Frequency command	0	○	○	○	○	○
08-70	Low-pass Filter Time of Line Speed	0.00~100.00 sec	0.00	○	○	○	○	○
08-71 08-75	Reserved							
08-76	Source of Tension Setting	0: Communication RS-485 (Pr.08-78) 1: Analog input (Pr. 03-00~03-02 is set to 15 tension setting) (Pr.08-78)	0					○
08-77	Max. Tension	0~30000 N	0					○
08-78	Tension Setting	0~30000 N	0					○
08-79	Source of Zero-speed Tension Setting	0: Disable 1: Communication RS-485 (Pr.08-80) 2: Analog input (Pr. 03-00~03-02 is set to 16 zero-speed tension) (Pr.08-80)	0					○
08-80	Setting of Zero-speed Tension	0~30000 N	0					○
08-81	Source of Tension Taper	0: Communication RS-485 (Pr.08-82) 1: Analog input (Pr. 03-00~03-02 is set to 17 tension taper) (Pr.08-82)	0					○
08-82	Tension Taper	0~100%	0					○
08-83	Friction Compensation	0.0~100.0%	0.0					○
08-84	Compensation Coefficient of Material Inertial	0~30000	0					○
08-85	Torque Feed Forward Gain	0.0~100.0%	50.0					○
08-86	Low Pass Filter Time of Torque Feed Forward	0.00~100.00	5.00					○
08-87 08-99	Reserved							

Group 9 Communication Parameters

Pr.	Explanation	Settings	Factory Setting	VF	VFPG	SVC	FOCPG	TQRPG
✓09-21	Multi-function Output Status	0~65535	Read-only	○	○	○	○	○
✓09-22	AFM2 Status	0~4095	Read-only	○	○	○	○	○
✓09-23	AFM3 Status	0~4095	Read-only	○	○	○	○	○

Group 10 Speed Feedback Control Parameters

New parameters 10-29~10-30

Pr.	Explanation	Settings	Factory Setting	VF	VFPG	SVC	FOCPG	TQRPG
✓10-04	ASR (Auto Speed Regulation) Control (P) 1	0~40	10		○		○	
✓10-06	ASR (Auto Speed Regulation) Control (P) 2	0~40	10		○		○	
✓10-21	P Gain of Zero Speed	0~40	10		○		○	
✓10-29	PG Mechanical Gear A2	1~5000	100		○		○	○
✓10-30	PG Mechanical Gear B2	1~5000	100		○		○	○

Group 11 Advanced Parameters



Updated parameters 11-00 and 11-09~11-10 and new parameters 11-18~11-40.

Pr.	Explanation	Settings	Factory Setting	VF	VFPG	SVC	FOCPG	TQRPG
✓11-00	System Control	bit 0: ASR Auto tuning bit 1: Inertia estimate bit 2: Zero Servo bit 3: Reserved bit 4: Enable gain adjustment of position loop KP	0				○	
✓11-07	Detection Time for Phase-loss	0.01~600.00 sec	0.20	○	○	○	○	○
11-08	Reserved							
✓11-09	Level of Phase-loss	0.0~320.0	60.0	○	○	○	○	○
11-10	Speed Feed Forward Gain	0~100%	0				○	
✓11-11	Zero-speed Bandwidth	0~40Hz	10		○		○	○
✓11-12	Speed Response of Flux Weakening Area	0: Disable 0~150%	65				○	
✓11-13	Notch Filter Depth	0~20db	0				○	
✓11-14	Notch Filter Frequency	0.00~200.00	0.00				○	
✓11-15	Gain Value of Slip Compensation	0.00~1.00	1.00			○		
✓11-16	Low-pass Filter Time of Keypad Display	0.001~65.535sec	0.100	○	○	○	○	○
✓11-17	Low-pass Filter Time of PG2 Pulse Input	0.000~65.535sec	0.100	○	○	○	○	
✓11-18	APR Gain	0.00~40.00	10.00				○	
✓11-19	APR Curve Time	0.00~655.35 sec	3.00				○	
11-20 11-28	Reserved							
11-29	Accumulative Operation Time of Phase-loss	0~65535 (hour)	0	○	○	○	○	○
11-30 11-40	Reserved							

4.3 Description of Parameter Settings

Group 0 User Parameters **↗**: This parameter can be set during operation.

00-00	Identity Code of the AC Motor Drive												
Control mode	VF	VFPG	SVC	FOCPG	TQRPQ								Factory setting: ##
Settings													Read Only
00-01	Rated Current Display of the AC Motor Drive												
Control mode	VF	VFPG	SVC	FOCPG	TQRPQ								Factory setting: ##
Settings													Read Only

-  Pr. 00-00 displays the identity code of the AC motor drive. The capacity, rated current, rated voltage and the max. carrier frequency relate to the identity code. Users can use the following table to check how the rated current, rated voltage and max. carrier frequency of the AC motor drive correspond to the identity code.
-  Pr.00-01 displays the rated current of the AC motor drive. By reading this parameter the user can check if the AC motor drive is correct.
-  The factory setting is rated current for the constant torque and can be set in Pr.00-12.

230V Series												
kW	0.75	1.5	2.2	3.7	5.5	7.5	11	15	18.5	22	30	37
HP	1.0	2.0	3.0	5.0	7.5	10	15	20	25	30	40	50
Pr.00-00	4	6	8	10	12	14	16	18	20	22	24	26
Rated Current for Constant Torque (A)	5	7.5	11	17	25	33	49	65	75	90	120	146
Rated Current for Variable Torque (A)	6.3	9.4	13.8	21.3	31.3	41.3	61.3	81.3	93.8	113	150	183
Max. Carrier Frequency	15kHz									9kHz		

460V Series															
kW	0.75	1.5	2.2	3.7	5.5	7.5	11	15	18.5	22	30	37	45	55	75
HP	1.0	2.0	3.0	5.0	7.5	10	15	20	25	30	40	50	60	75	100
Pr.00-00	5	7	9	11	13	15	17	19	21	23	25	27	29	31	33
Rated Current for Constant Torque (A)	3	4.2	6	8.5	13	18	24	32	38	45	60	73	91	110	150
Rated Current for Variable Torque (A)	3.8	5.3	7.5	10.6	16.3	22.5	30	40	47.5	56.3	75	91.3	113.8	138	188
Max. Carrier Frequency	15kHz							9kHz				6kHz			

00-02 Parameter Reset

Control mode	VF	VFPG	SVC	FOCPG	TQRPG	Factory setting: 0
Settings	0	No Function				
	1	Read Only				
	2	Enable Group 11 Parameters Setting				
	8	Keypad Lock				
	9	All parameters are reset to factory settings (50Hz, 220V/380V)				
	10	All parameters are reset to factory settings (60Hz, 220V/440V)				

 When it is set to 1, all parameters are read only except Pr.00-00~00-07 and it can be used with password setting for password protection.

 This parameter allows the user to reset all parameters to the factory settings except the fault records (Pr.06-17 ~ Pr.06-22).

50Hz: Pr.01-01 is set to 50Hz and Pr.01-02 is set to 230V or 400V.

60Hz: Pr.01-01 is set to 60Hz and Pr.01-02 is set to 230V or 460V.

 When Pr.00-02=08, the KPV-CE01 keypad is locked and only Pr.00-02 can be set. To unlock the keypad, set Pr.00-02=00.

 When Pr.00-02 is set to 1 or 8, Pr.00-02 setting should be set to 0 before setting to other setting.

 After setting Pr.00-02 to 2, it can display group 11 to re-connect the keypad after disconnection or re-power on after the power off.

00-03  Start-up Display Selection





















Control mode	VF	VFPG	SVC	FOCPG	TQRPG	Factory setting: 0
Settings	0	Display the frequency command value. (LED F)				
	1	Display the actual output frequency (LED H)				
	2	Multifunction display, see Pr.00-04 (LED U)				
	3	Display the output current (A)				

 This parameter determines the start-up display page after power is applied to the drive.



00-04  Content of Multi-Function function Display



Control mode	VF	VFPG	SVC	FOCPG	TQRPG	Factory setting: 0
--------------	----	------	-----	-------	-------	--------------------

00-04 Content of Multi-Function function Display

Settings	0	Display the output current in A supplied to the motor	
	1	Display the counter value which counts the number of pulses on TRG terminal	
	2	Display actual output frequency (Hz)	
	3	Display the actual DC BUS voltage in VDC of the AC motor drive	
	4	Display the output voltage in VAC of terminals U, V, W to the motor.	
	5	Display the power factor angle in ° of terminals U, V, W to the motor.	
	6	Display the output power in kW of terminals U, V and W to the motor.	
	7	Display the actual motor speed in rpm (enabled when using with PG card).	
	8	Display the estimated value of torque in Nm as it relates to current.	
	9	Display PG position. When Pr.10-01 is set to 1 or 2, it means that motor angle is 0~4XPr.10-00.	
	10	Display analog feedback signal value in %.	
	11	Display the signal of AVI analog input terminal in %. Range 0~10V corresponds to 0~100%. (1.)	
	12	Display the signal of ACI analog input terminal in %. Range 4~20mA/0~10V corresponds to 0~100%. (2.)	
	13	Display the signal of AUI analog input terminal in %. Range -10V~10V corresponds to 0~100%. (3.)	
	14	Display the temperature of heat sink in °C.	
	15	Display the temperature of IGBT in °C.	
	16	Display digital input status ON/OFF (i)	
	17	Display digital output status ON/OFF (o)	
	18	Display multi-step speed	
	19	The corresponding CPU pin status of digital input (i.)	
	20	The corresponding CPU pin status of digital output (o.)	

00-04 Content of Multi-Function function Display

- 21 Number of actual motor revolution (PG1 of PG card) (Z) 
- 22 Pulse input frequency (PG2 of PG card) (4) 
- 23 Pulse input position (PG2 of PG card) (4.) 

-  This parameter sets the display when Pr. 00-03 is set to 2.
-  It is used to display the content when LED U is ON. It is helpful for getting the AC motor drive's status by this parameter.

Terminal	MI14	MI13	MI12	MI11	MI10	MI9	MI8	MI7	MI6	MI5	MI4	MI3	MI2	MI1	REV	FWD
Status	0	0	0	0	0	0	0	0	1	0	0	0	0	1	1	0

0: OFF, 1: ON

MI1: Pr.02-01 is set to 1 (multi-step speed command 1/multi-step position command 1)

MI6: Pr.02-06 is set to 8 (the 1st, 2nd acceleration/deceleration time selection)

If REV, MI1 and MI6 are ON, the value is 0000 0000 1000 01102 in binary and 0086H in HEX.

At the meanwhile, if Pr.00-04 is set to "16" or "19", it will display "0086" with LED U is ON on the keypad KPV-CE01. The setting 16 is the status of digital input and the setting 19 is the corresponding CPU pin status of digital input. User can set to 16 to monitor digital input status and then set to 19 to check if the wire is normal.

Terminal	Reserved				Reserved				Reserved				MO2	MO1	RA	MRA	
Status	0	0	0	0	0	0	0	0	0	1	0	0	0	0	1	1	0

MRA: Pr.02-11 is set to 9 (Drive ready).

After applying the power to the AC motor drive, if there is no other abnormal status, the contact will be ON. At the meanwhile, if Pr.00-04 is set to 17 or 20, it will display 0001 with LED U is ON on the keypad. The setting 17 is the status of digital output and the setting 20 is the corresponding CPU pin status of digital output. User can set 17 to monitor the digital output status and then set to 20 to check if the wire if normal.

00-05 User Defined Coefficient K

Control mode	VF	VFPG	SVC	FOCPG	TQRPg	Factory setting: 0
Settings	Digit 4: decimal point number (0 to 3) Digit 0-3: 40 to 9999					

It is used digital setting method

Digital 4: decimal point number (0: no decimal point, 1: 1 decimal point and so on.)

Digit 0-3: 40 to 9999 (the corresponding value for the max. frequency).

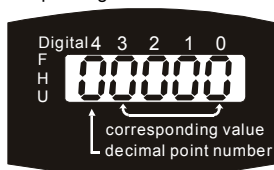

For example, if use rpm to display the motor speed and the corresponding value to the 4-pole motor 60Hz is 1800. This parameter can be set to 01800 to indicate that the corresponding value for 60Hz is 1800rpm. If the unit is rps, it can be set 10300 to indicate the corresponding value for 60Hz is 30.0 (a decimal point).

00-06 Software Version

Control mode	VF	VFPG	SVC	FOCPG	TQRPg	Factory setting: Read Only
Settings	Read Only					
Display	#.##					

00-07 Password Input

Unit: 1

Control mode	VF	VFPG	SVC	FOCPG	TQRPg	Factory setting: 00
Settings	1 to 9998 and 10000 to 65535					
Display	00~02 (times of wrong password)					

The function of this parameter is to input the password that is set in Pr.00-08. Input the correct password here to enable changing parameters. You are limited to a maximum of 3 attempts. After 3 consecutive failed attempts, a blinking "PcodE" will show up to force the user to restart the AC motor drive in order to try again to input the correct password.

When forgetting password, you can decode by setting 9999 and press button  twice.

Please note that all the settings will be set to factory setting.

00-08 Password Set

Unit: 1

Control mode	VF	VFPG	SVC	FOCPG	TQRPG
Settings			1 to 9998 and 10000 to 65535		
Display		00		No password set or successful input in Pr. 00-07	
		01		Password has been set	

📖 To set a password to protect your parameter settings.
 If the display shows 00, no password is set or password has been correctly entered in Pr.00-07. All parameters can then be changed, including Pr.00-08.
 The first time you can set a password directly. After successful setting of password the display will show 01.

Be sure to record the password for later use.

To cancel the parameter lock, set the parameter to 00 after inputting correct password into Pr. 00-07.

The password consists of min. 2 digits and max. 5 digits.

📖 How to make the password valid again after decoding by Pr.00-07:

Method 1: Re-input original password into Pr.00-08 (Or you can enter a new password if you want to use a changed or new one).

Method 2: After rebooting, password function will be recovered.

Password Decode Flow Chart

Password Setting

Decoding Flow Chart

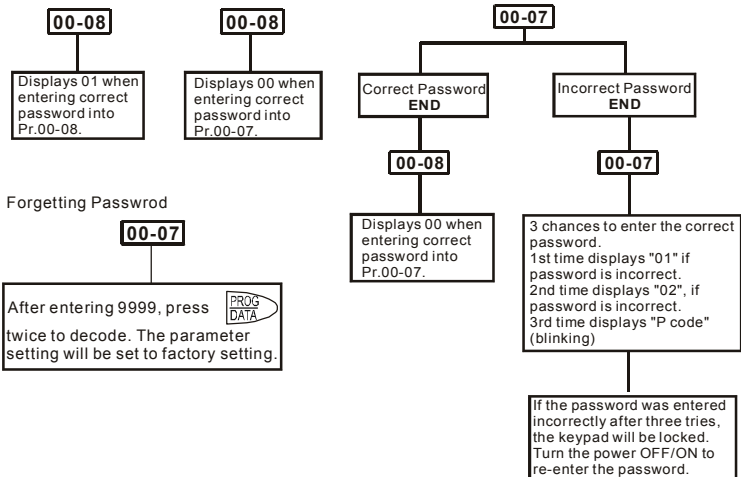

00-09 ✓Energy Saving Gain

Unit: 1

Control mode	FOCPG	Factory setting: 100%
Settings	10~1000 %	

 When Pr.00-19 is set to 1, this parameter can be used for energy saving. The setting should be decreased when the energy saving is not well. When the motor is vibrated, the setting should be increased.

00-10 Control Method

Control mode	VF	VFPG	SVC	FOCPG	TQRPG	Factory setting: 0
Settings		0	V/f control			
		1	V/f + Encoder (VFPG)			
		2	Sensorless vector control (SVC)			
		3	FOC vector control + Encoder (FOCPG)			
		4	Torque control + Encoder (TQRPG)			

 This parameter determines the control method of the AC motor drive:

Setting 0: user can design V/f ratio by requirement and control multiple motors simultaneously.

Setting 1: User can use PG card with Encoder to do close-loop speed control.

Setting 2: To have optimal control characteristic by auto-tuning.

Setting 3: To increase torque and control speed precisely. (1:1000)

Setting 4: To increase accuracy for torque control.

00-11 V/f Curve Selection

Control mode	VF	VFPG	Factory setting: 0
Settings	0	V/f curve determined by group 01	
	1	1.5 power curve	
	2	Square curve	

 When it is set to 0, the V/f curve setting for the motor 1 is according to Pr.01-01~Pr.01-08 and Pr. 01-35~01-42 are for the motor 2.

 When setting to 1 or 2, the settings of the 2nd voltage/frequency and the 3rd voltage/frequency are invalid.

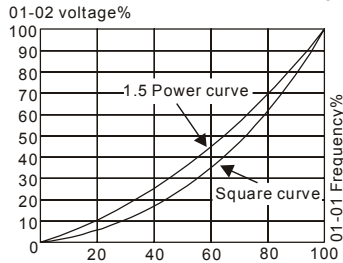
**00-12** / Constant/Variable Torque Selection

Control mode	VF	VFPG	SVC	FOCPG	Factory setting: 0
Settings		0	Constant Torque (100%)		
		1	Variable Torque (125%)		

When "1" is selected, the oL level is 125% of rated drive current. All other overload ratings will not change, example: 150% of rated drive current for 60 seconds.

00-13 / Optimal Acceleration/Deceleration Setting

Control mode	VF	VFPG	SVC	FOCPG	Factory setting: 0
Settings		0	Linear accel./decel. I		
		1	Auto accel., linear decel.		
		2	Linear accel., auto decel.		
		3	Auto accel./decel. I		
		4	Stall prevention by auto accel./decel. (limited by 01-12 to 01-21)		

It can decrease the drive's vibration during load starts and stops by setting this parameter. Also it will speed up to the setting frequency with the fastest and smoothest start-up current when it detects small torque. At deceleration, it will auto stop the drive with the fastest and the smoothest deceleration time when the regenerated voltage of the load is detected.

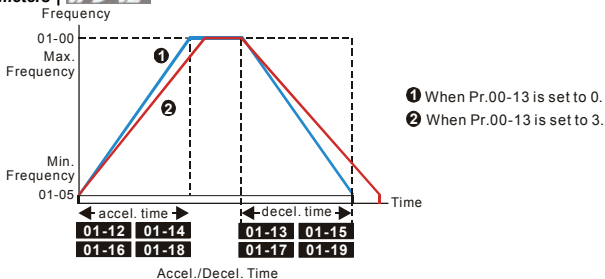

00-14 Time Unit for Acceleration/Deceleration and S Curve

Control mode	VF	VFPG	SVC	FOCPG	Factory setting: 0
Settings	0	Unit: 0.01 second			
	1	Unit: 0.1 second			

This parameter determines the time unit for the Acceleration/Deceleration setting. Refer to Pr.01-12 ~ Pr.01-19 (accel./decel. Time 1 to 4), Pr. 01-20~Pr.01-21 (JOG accel./decel. Time) and Pr. 01-24~Pr.01-27 (S curve accel./decel. Time).

00-15 Reserved

00-16 Reserved

00-17 Carrier Frequency

Unit: 1

Control mode	VF	VFPG	SVC	FOCPG	TQRPQ	Factory setting: 10
Settings	1~15kHz					

This parameter determines the PWM carrier frequency of the AC motor drive.

230V/460V Series				
Models	1-5HP 0.75-3.7kW	7.5-25HP 5.5-18.5kW	30-60HP 22-45kW	75-100HP 55-75Kw
Setting Range	01~15kHz	01~15kHz	01~09kHz	01~06kHz
Factory Setting	10kHz	9kHz	6kHz	6kHz

Carrier Frequency	Acoustic Noise	Electromagnetic Noise or Leakage Current	Heat Dissipation	Current Wave
1kHz	Significant ↑ ↓ Minimal	Minimal ↑ ↓ Significant	Minimal ↑ ↓ Significant	
8kHz				
15kHz				

- From the table, we see that the PWM carrier frequency has a significant influence on the electromagnetic noise, AC motor drive heat dissipation, and motor acoustic noise.

00-18 / Auto Voltage Regulation (AVR) Function

Control mode	VF	VFPG	SVC	FOCPG	TQRPG	Factory setting: 0
Settings		0	Enable AVR			
		1	Disable AVR			
		2	Disable AVR when deceleration stop			

- It is used to select the AVR mode. AVR is used to regulate the output voltage to the motor. For example, if V/f curve is set to AC200V/50Hz and the input voltage is from 200 to 264VAC, the output voltage won't excess AC200V/50Hz. If the input voltage is from 180 to 200V, the output voltage to the motor and the input voltage will be in direct proportion.
- When setting Pr.00-18 to 1 during ramp to stop and used with auto accel./decel. function, the acceleration will be smoother and faster.

00-19 / Auto Energy-saving Operation

Control mode	VF	VFPG	SVC	FOCPG	Factory setting: 0
Settings		0	Disable		
		1	Enable		

- When the Auto Energy-saving function is enabled, the drive will operate with full voltage during acceleration and deceleration. At constant speed, the AC drive will calculate the optimal output voltage value for the load. It is possible for the output voltage to be 25% below Maximum Output Voltage during auto energy-saving operation. This function should not be used with variable loads or continuous rated output loads.
- When output frequency is constant, i.e. constant operation, the output voltage will be auto decreased with load reduction. To make the AC motor drive runs under the energy-saving with the minimum value of the product of voltage and current.

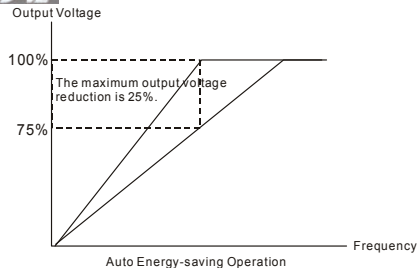
**00-20** ✓ Source of the Master Frequency Command

Control mode	VF	VFPG	SVC	FOCPG	Factory setting: 0
Settings	0			Digital keypad (KPV-CE01)	
		1		RS-485 serial communication	
		2		External analog input (Pr. 03-00)	
		3		External UP/DOWN terminal	
		4		Pulse input without direction command (Pr.10-15 without direction)	
		5		Pulse input with direction command (Pr.10-15)	

This parameter determines the drive's master frequency source.

00-21 ✓ Source of the Operation Command

Control mode	VF	VFPG	SVC	FOCPG	TQRPG	Factory setting: 0
Settings	0				Digital keypad (KPV-CE01)	
		1			External terminals. Keypad STOP disabled.	
		2			RS-485 serial communication (RJ-11). Keypad STOP disabled.	

When Pr.00-21 is set to 1, it also needs to set Pr.00-20 and Pr.00-21 to 0. After pressing PU key to make LED PU to be light, RUN, JOG and STOP key are valid now.

00-22 ✓ Stop Method

Control mode	VF	VFPG	SVC	FOCPG	TQRPG	Factory setting: 0
Settings	0				Ramp to stop	
		1			Coast to stop	

The parameter determines how the motor is stopped when the AC motor drive receives a valid stop command.

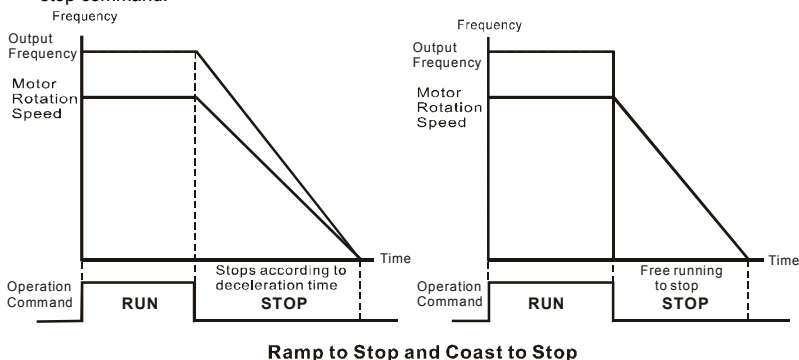

Ramp to stop: the AC motor drive decelerates from the maximum output frequency (Pr. 01-00) to minimum output frequency (Pr. 01-09) according to the deceleration time and then stop.

Coast to stop: the AC motor drive stops the output instantly upon a STOP command and the motor free runs until it comes to a complete standstill.

(1) It is recommended to use “ramp to stop” for safety of personnel or to prevent material from being wasted in applications where the motor has to stop after the drive is stopped. The deceleration time has to be set accordingly.

(2) If the motor free running is allowed or the load inertia is large, it is recommended to select “coast to stop”. For example, blowers, punching machines and pumps.

The stop method of the torque control is also set by Pr.00-22.

00-23 Reverse Operation

Control mode	VF	VFP	SVC	FOCPG	TQRP	Factory setting: 0
Settings	0	Enable reverse				
	1	Disable reverse				
	2	Disable forward				

This parameter enables the AC motor drives to run in the Reverse Direction. It may be used to prevent a motor from running in a direction that would consequently injure humans or damage the equipment.

Group 1 Basic Parameters

01-00	Maximum Output Frequency					Unit: 0.01
Control mode	VF	VFPG	SVC	FOCPG	TQRPG	Factory setting: 60.00/50.00
	Settings		50.0 to 600.00Hz			

 This parameter determines the AC motor drive's Maximum Output Frequency. All the AC motor drive frequency command sources (analog inputs 0 to +10V, 4 to 20mA and -10V to +10V) are scaled to correspond to the output frequency range.

01-01	1st Output Frequency Setting 1					
01-35	1st Output Frequency Setting 2					Unit: 0.01
Control mode	VF	VFPG	SVC	FOCPG	TQRPG	Factory setting: 60.00/50.00
	Settings		0.00~600.00Hz			

 These are for the base frequency and motor rated frequency.

 This value should be set according to the rated frequency of the motor as indicated on the motor nameplate. If the motor is 60Hz, the setting should be 60Hz. If the motor is 50Hz, it should be set to 50Hz.

 Pr.01-35 is used for the application occasion that uses double base motor.

01-02	1st Output Voltage Setting 1					
01-36	1st Output Voltage Setting 2					Unit: 0.1
Control mode	VF	VFPG	SVC	FOCPG	TQRPG	
	Settings	230V series	0.1 to 255.0V			Factory Setting: 220.0
		460V series	0.1 to 510.0V			Factory Setting: 440.0

 These are for the base frequency and motor rated frequency.

 This value should be set according to the rated voltage of the motor as indicated on the motor nameplate. If the motor is 220V, the setting should be 220.0. If the motor is 200V, it should be set to 200.0.

 There are many motor types in the market and the power system for each country is also difference. The economic and convenience method to solve this problem is to install the AC motor drive. There is no problem to use with the different voltage and frequency and also can amplify the original characteristic and life of the motor.

01-03	2nd Output Frequency Setting 1					Unit: 0.01
--------------	--------------------------------	--	--	--	--	------------

Control mode	VF	VFPG	SVC	Factory setting: 0.50
	Settings	0.00~600.00Hz		
01-04	↗2nd Output Voltage Setting 1			Unit: 0.1
Control mode	VF	VFPG	SVC	Factory setting: 0.50
	Settings	230V series	0.1 to 255.0V	Factory Setting: 5.0
		460V series	0.1 to 510.0V	Factory Setting: 10.0
01-37	2nd Output Frequency Setting 2			Unit: 0.01
Control mode	VF	VFPG	SVC	Factory setting: 0.50
	Settings	0.00~600.00Hz		
01-38	↗2nd Output Voltage Setting 2			Unit: 0.1
Control mode	VF	VFPG	SVC	Factory Setting: 5.0
	Settings	230V series	0.1 to 255.0V	Factory Setting: 10.0
		460V series	0.1 to 510.0V	
01-05	3rd Output Frequency Setting 1			Unit: 0.01
Control mode	VF	VFPG	SVC	Factory Setting: 0.50
	Settings	0.00~600.00Hz		
01-06	↗3rd Output Voltage Setting 1			Unit: 0.1
Control mode	VF	VFPG	SVC	Factory Setting: 5.0
	Settings	230V series	0.1 to 255.0V	Factory Setting: 10.0
		460V series	0.1 to 510.0V	
01-39	3rd Output Frequency Setting 2			Unit: 0.01
Control mode	VF	VFPG	SVC	Factory Setting: 0.50
	Settings	0.00~600.00Hz		
01-40	↗3rd Output Voltage Setting 2			Unit: 0.1
Control mode	VF	VFPG	SVC	Factory Setting: 5.0
	Settings	230V series	0.1 to 255.0V	Factory Setting: 10.0
		460V series	0.1 to 510.0V	
01-07	4th Output Frequency Setting 1			Unit: 0.01
Control mode	VF	VFPG	SVC	Factory Setting: 0.00
	Settings	0.00~600.00Hz		
01-08	↗4th Output Voltage Setting 1			Unit: 0.1



Control mode	VF	VFPG	SVC	
	Settings	230V series	0.1 to 255.0V	Factory Setting: 0.0
		460V series	0.1 to 510.0V	Factory Setting: 0.0

01-41 4th Output Frequency Setting 2 Unit: 0.01

Control mode	VF	VFPG	SVC	FOCPG	TQRPQ	
	Settings	0.00~600.00Hz				Factory Setting: 0.00



01-42 4th Output Voltage Setting 2 Unit: 0.1

Control mode	VF	VFPG	SVC	
	Settings	230V series	0.1 to 255.0V	Factory Setting: 0.0
		460V series	0.1 to 510.0V	Factory Setting: 0.0

-  V/f curve setting is usually set by the motor's allowable loading characteristics. Pay special attention to the motor's heat dissipation, dynamic balance, and bearing lubricity, if the loading characteristics exceed the loading limit of the motor.
-  For the V/f curve setting, it should be Pr.01-01 ≥ Pr.01-03 ≥ Pr.01-05 ≥ Pr.01-07. There is no limit for the voltage setting, but a high voltage at the low frequency may cause motor damage, overheat, stall prevention or over-current protection. Therefore, please use the low voltage at the low frequency to prevent motor damage.
-  Pr.01-35 to Pr.01-42 is the V/f curve for the motor 2. When multi-function input terminals Pr.02-01 to Pr.02-14 is set to 14 and enabled or switch to the Δ-connection, the AC motor drive will act as the 2nd V/f curve.

01-09 Start Frequency Unit: 0.01

Control mode	VF	VFPG	SVC	FOCPG	
	Settings	0.00~600.00Hz			Factory Setting: 0.50

-  When start frequency is higher than the min. output frequency, drives' output will be from start frequency to the setting frequency. Please refer to the following diagram for details.
-  Fcmd=frequency command,
 Fstart=start frequency (Pr.01-09),
 fstart=actual start frequency of drive,
 Fmin=4th output frequency setting (Pr.01-07/Pr.01-41),
 Flow=output frequency lower limit (Pr.01-11)

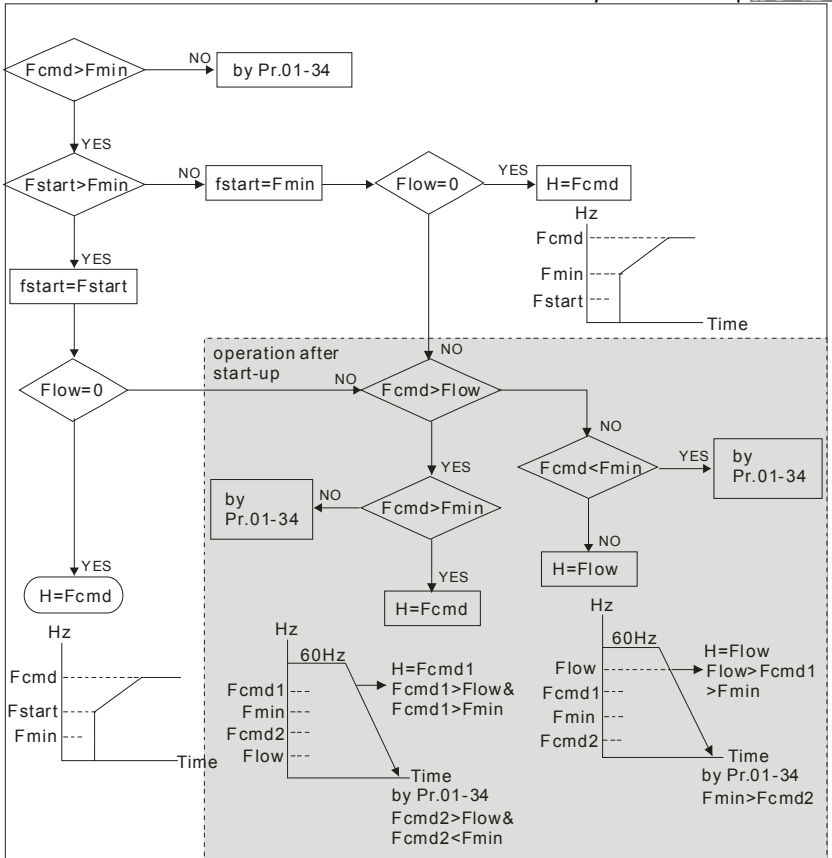

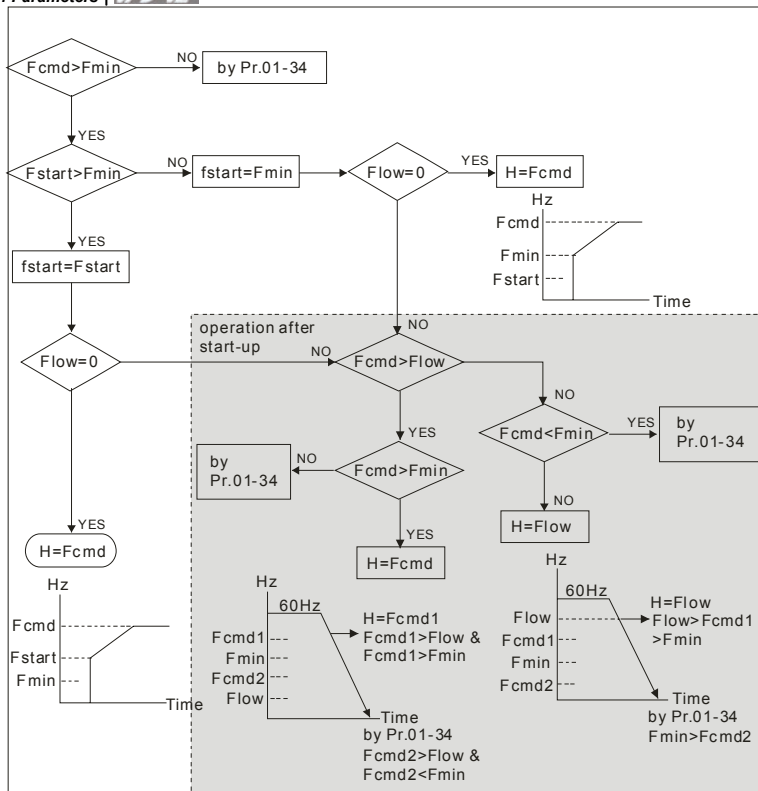
**01-10** Output Frequency Upper Limit

Unit: 0.01

Control mode VF VFPG SVC FOC PG

Factory Setting: 600.00

Settings 0.00~600.00Hz

01-11 Output Frequency Lower Limit

Unit: 0.01

Control mode VF VFPG SVC FOC PG

Factory Setting: 0.00

Settings 0.00~600.00Hz

The upper/lower output frequency setting is used to limit the actual output frequency. If the frequency setting is higher than the upper limit, it will run with the upper limit frequency. If output frequency lower than output frequency lower limit and frequency setting is higher than

min. frequency, it will run with lower limit frequency. The upper limit frequency should be set to be higher than the lower limit frequency.

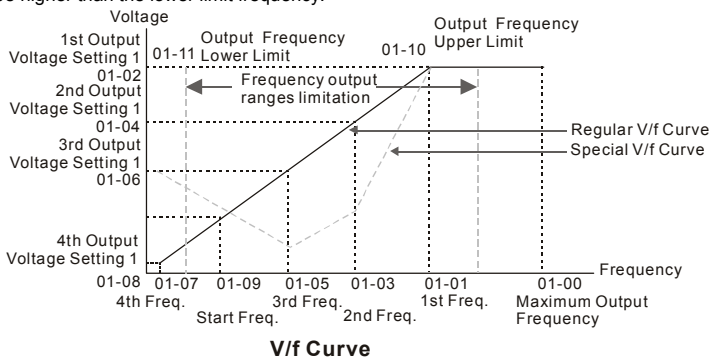

01-12	✓ Accel. Time 1	Unit: 0.1/0.01
01-13	✓ Decel. Time 1	Unit: 0.1/0.01
01-14	✓ Accel. Time 2	Unit: 0.1/0.01
01-15	✓ Decel. Time 2	Unit: 0.1/0.01
01-16	✓ Accel. Time 3	Unit: 0.1/0.01
01-17	✓ Decel. Time 3	Unit: 0.1/0.01
01-18	✓ Accel. Time 4	Unit: 0.1/0.01
01-19	✓ Decel. Time 4	Unit: 0.1/0.01

Control mode	VF	VFPG	SVC	FOCPG	Factory Setting: 10.00/10.0
Settings	0.00~600.00 sec/0.00~6000.0 sec				

01-20	✓ JOG Acceleration Time	Unit: 0.1/0.01
01-21	✓ JOG Deceleration Time	Unit: 0.1/0.01

Control mode	VF	VFPG	SVC	FOCPG	Factory Setting: 1.00/1.0
Settings	0.00~600.00 sec/0.00~6000.0 sec				

- 📖 The Acceleration Time is used to determine the time required for the AC motor drive to ramp from 0Hz to Maximum Output Frequency (Pr.01-00).
- 📖 The Deceleration Time is used to determine the time require for the AC motor drive to decelerate from the Maximum Output Frequency (Pr.01-00) down to 0Hz.
- 📖 The Acceleration/Deceleration Time is invalid when using Pr.00-13 Optimal Acceleration/Deceleration Setting.

- 📖 The Acceleration/Deceleration Time 1, 2, 3, 4 are selected according to the Multi-function Input Terminals settings. See Pr.02-01 to Pr.02-30 for details.
- 📖 When enabling torque limit and stall prevention function, actual accel./decel. time will longer than the above action time.

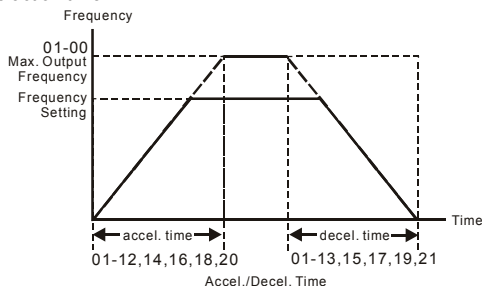

01-22 ⚡ JOG Frequency Unit: 0.01

Control mode	VF	VFPG	SVC	FOCPG	TQRP	TQPG	Factory Setting: 6.00
--------------	----	------	-----	-------	------	------	-----------------------

Settings 0.00~600.00Hz

- 📖 Both external terminal JOG and key “JOG” on the keypad can be used. When the jog command is ON, the AC motor drive will accelerate from 0Hz to jog frequency (Pr.01-22). When the jog command is OFF, the AC motor drive will decelerate from Jog Frequency to zero. The used Accel./Decel. time is set by the Jog Accel./Decel. time (Pr.01-20, Pr.01-21).

01-23 ⚡ 1st/4th Accel./decel. Frequency Unit: 0.01

Control mode	VF	VFPG	SVC	FOCPG	Factory Setting: 0.00
--------------	----	------	-----	-------	-----------------------

Settings 0.00~600.00Hz

- 📖 This parameter selects the frequency point for transition from acceleration/deceleration time 1 to acceleration/deceleration time 4.
- 📖 The transition from acceleration/deceleration time 1 to acceleration/deceleration time 4, may also be enabled by the external terminals (Pr. 02-01 to 02-08). The external terminal has priority over Pr. 01-23.

01-24 ⚡ S-curve for Acceleration Departure Time 1 Unit: 0.1/0.01

01-25 ⚡ S-curve for Acceleration Arrival Time 2 Unit: 0.1/0.01

01-26 ⚡ S-curve for Deceleration Departure Time 1 Unit: 0.1/0.01

01-27 S-curve for Deceleration Arrival Time 2

Unit: 0.1/0.01

Control mode	VF	VFPG	SVC	FOCPG
--------------	----	------	-----	-------

Factory Setting: 0.2/0.0

Settings	0.00~25.00 sec /0.00~250.0 sec
----------	--------------------------------

It is used to give the smoothest transition between speed changes. The accel./decel. curve can adjust the S-curve of the accel./decel. When it is enabled, the drive will have different accel./decel. curve by the accel./decel. time.

The S-curve function is disabled when Pr.00-13 is set to 0.

The Actual Accel. Time = selected accel. Time + (Pr.01-24 + Pr.01-25)/2

The Actual Decel. Time = selected decel. Time + (Pr.01-26 + Pr.01-27)/2

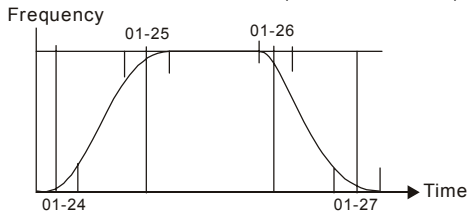
**01-28** Skip Frequency 1 (upper limit)

Unit: 0.01

01-29 Skip Frequency 1 (lower limit)

Unit: 0.01

01-30 Skip Frequency 2 (upper limit)

Unit: 0.01

01-31 Skip Frequency 2 (lower limit)

Unit: 0.01

01-32 Skip Frequency 3 (upper limit)

Unit: 0.01

01-33 Skip Frequency 3 (lower limit)

Unit: 0.01

Control mode	VF	VFPG	SVC	FOCPG
--------------	----	------	-----	-------

Factory Setting: 0.00

Settings	0.00~600.00Hz
----------	---------------

These parameters are used to set the skip frequency of the AC drive. The skip frequencies are useful when a motor has vibration at a specific frequency bandwidth. By skipping this frequency, the vibration will be avoided.

01-34 Mode Selection when Frequency < Fmin

Control mode	VF	VFPG	SVC	FOCPG
--------------	----	------	-----	-------

Factory Setting: 0

Settings	0	Output Waiting
----------	---	----------------

1	Zero-speed operation
---	----------------------

2 Fmin (4th output frequency setting)

- 📖 When the frequency is less than Fmin (Pr.01-07 or Pr.01-41), it will operate by this parameter.
- 📖 When it is set to 0, the AC motor drive will be in waiting mode without voltage output from terminals U/V/W.
- 📖 When setting 1, it will execute DC brake by Vmin(Pr.01-08 and Pr.01-42) in V/f, VFPG and SVC modes.
- 📖 When it is set to 2, the AC motor drive will run by Fmin (Pr.01-07, Pr.01-41) and Vmin (Pr.01-08, Pr.01-42) in V/f, VFPG, SVC and FOCPG modes.
- 📖 In V/f, VFPG and SVC modes

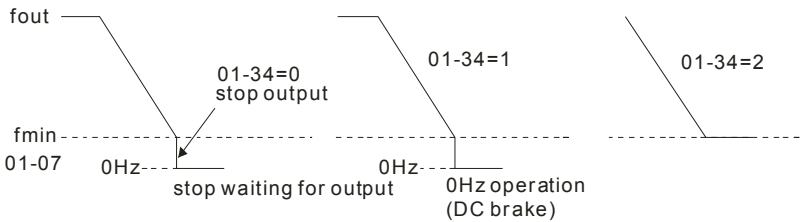

- 📖 In FOCPG mode, when Pr.01-34 is set to 2, it will act according Pr.01-34 setting.

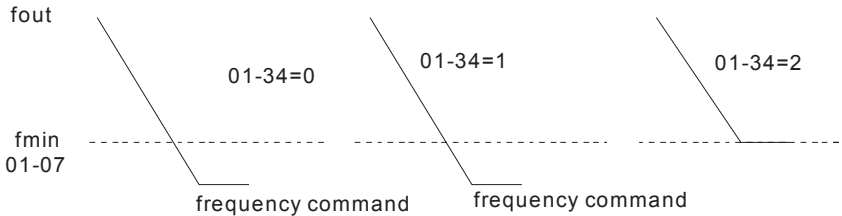

Group 2 Digital Input/Output Parameters

02-00 2-wire/3-wire Operation Control

Control mode	VF	VFPG	SVC	FOCPG	TQRPG	Factory setting: 0
Settings	0		FWD/STOP, REV/STOP			
	1		FWD/STOP, REV/STOP (Line Start Lockout)			
	2		RUN/STOP, REV/FWD			
	3		RUN/STOP, REV/FWD (Line Start Lockout)			
	4		3-wire (momentary push button)			
	5		3-wire (momentary push button and Line Start Lockout)			



Three of the six methods include a "Line Start Lockout" feature. When line start lockout is enabled, the drive will not run once applying the power. The Line Start Lockout feature doesn't guarantee the motor will never start under this condition. It is possible the motor may be set in motion by a malfunctioning switch.

02-00	Control Circuits of the External Terminal
0, 1 2-wire operation control (1) FWD/STOP REV/STOP	
2, 3 2-wire operation control (2) RUN/STOP REV/FWD	
4, 5 3-wire operation control	

02-01 Multi-Function Input Command 1 (MI1)

Factory Setting: 1

02-02 Multi-Function Input Command 2 (MI2)

Factory Setting: 2





02-03 Multi-Function Input Command 3 (MI3)

Factory Setting: 3

02-04	Multi-Function Input Command 4 (MI4)	Factory Setting: 4
02-05	Multi-Function Input Command 5 (MI5)	Factory Setting: 0
02-06	Multi-Function Input Command 6 (MI6)	Factory Setting: 0
02-23	Multi-Function Input Command 7 (MI7)	Factory Setting: 0
02-24	Multi-Function Input Command 8 (MI8)	Factory Setting: 0
02-25	Multi-Function Input Command 9 (MI9)	Factory Setting: 0
02-26	Multi-Function Input Command 10 (MIA)	Factory Setting: 0
02-27	Multi-Function Input Command 11 (MIB)	Factory Setting: 0
02-28	Multi-Function Input Command 12	Factory Setting: 0
02-29	Multi-Function Input Command 13	Factory Setting: 0
02-30	Multi-Function Input Command 14	Factory Setting: 0
Settings	0-50	

Settings	Control Mode				
	VF	VFPG	SVC	FOCPG	TQRP
0: no function	<input type="radio"/>	<input type="radio"/>	<input type="radio"/>	<input type="radio"/>	<input type="radio"/>
1: multi-step speed command 1/multi-step position command 1	<input type="radio"/>	<input type="radio"/>	<input type="radio"/>	<input type="radio"/>	
2: multi-step speed command 2/ multi-step position command 2	<input type="radio"/>	<input type="radio"/>	<input type="radio"/>	<input type="radio"/>	
3: multi-step speed command 3/ multi-step position command 3	<input type="radio"/>	<input type="radio"/>	<input type="radio"/>	<input type="radio"/>	
4: multi-step speed command 4/ multi-step position command 4	<input type="radio"/>	<input type="radio"/>	<input type="radio"/>	<input type="radio"/>	
5: Reset	<input type="radio"/>	<input type="radio"/>	<input type="radio"/>	<input type="radio"/>	<input type="radio"/>
6: JOG command	<input type="radio"/>	<input type="radio"/>	<input type="radio"/>	<input type="radio"/>	
7: acceleration/deceleration speed inhibit	<input type="radio"/>	<input type="radio"/>	<input type="radio"/>	<input type="radio"/>	
8: the 1st, 2nd acceleration/deceleration time selection	<input type="radio"/>	<input type="radio"/>	<input type="radio"/>	<input type="radio"/>	
9: the 3rd, 4th acceleration/deceleration time selection	<input type="radio"/>	<input type="radio"/>	<input type="radio"/>	<input type="radio"/>	
10: EF input (07-36)	<input type="radio"/>	<input type="radio"/>	<input type="radio"/>	<input type="radio"/>	<input type="radio"/>
11: B.B. input	<input type="radio"/>	<input type="radio"/>	<input type="radio"/>	<input type="radio"/>	<input type="radio"/>
12: Output stop	<input type="radio"/>	<input type="radio"/>	<input type="radio"/>	<input type="radio"/>	<input type="radio"/>

Settings	Control Mode				
	VF	VFPG	SVC	FOCPG	TQRP
13: cancel the setting of the optimal acceleration/deceleration time	<input type="checkbox"/>	<input type="checkbox"/>	<input type="checkbox"/>	<input type="checkbox"/>	
14: switch between drive settings 1 and 2	<input type="checkbox"/>	<input type="checkbox"/>	<input type="checkbox"/>	<input type="checkbox"/>	
15: operation speed command form AVI	<input type="checkbox"/>	<input type="checkbox"/>	<input type="checkbox"/>	<input type="checkbox"/>	
16: operation speed command form ACI	<input type="checkbox"/>	<input type="checkbox"/>	<input type="checkbox"/>	<input type="checkbox"/>	
17: operation speed command form AUI	<input type="checkbox"/>	<input type="checkbox"/>	<input type="checkbox"/>	<input type="checkbox"/>	
18: Emergency Stop (07-36)	<input type="checkbox"/>	<input type="checkbox"/>	<input type="checkbox"/>	<input type="checkbox"/>	<input type="checkbox"/>
19: Digital Up command	<input type="checkbox"/>	<input type="checkbox"/>	<input type="checkbox"/>	<input type="checkbox"/>	
20: Digital Down command	<input type="checkbox"/>	<input type="checkbox"/>	<input type="checkbox"/>	<input type="checkbox"/>	
21: PID function disabled	<input type="checkbox"/>	<input type="checkbox"/>	<input type="checkbox"/>	<input type="checkbox"/>	
22: clear counter	<input type="checkbox"/>	<input type="checkbox"/>	<input type="checkbox"/>	<input type="checkbox"/>	<input type="checkbox"/>
23: input the counter value (multi-function input command 6)	<input type="checkbox"/>	<input type="checkbox"/>	<input type="checkbox"/>	<input type="checkbox"/>	<input type="checkbox"/>
24: FWD JOG command	<input type="checkbox"/>	<input type="checkbox"/>	<input type="checkbox"/>	<input type="checkbox"/>	
25: REV JOG command	<input type="checkbox"/>	<input type="checkbox"/>	<input type="checkbox"/>	<input type="checkbox"/>	
26: TQC+PG/FOC+PG model selection	<input type="checkbox"/>	<input type="checkbox"/>	<input type="checkbox"/>	<input type="checkbox"/>	<input type="checkbox"/>
27: ASR1/ASR2 selection	<input type="checkbox"/>	<input type="checkbox"/>	<input type="checkbox"/>	<input type="checkbox"/>	
28: Emergency stop (EF1)	<input type="checkbox"/>	<input type="checkbox"/>	<input type="checkbox"/>	<input type="checkbox"/>	<input type="checkbox"/>
29: Signal confirmation for Y-connection	<input type="checkbox"/>	<input type="checkbox"/>	<input type="checkbox"/>	<input type="checkbox"/>	
30: Signal confirmation for connection	<input type="checkbox"/>	<input type="checkbox"/>	<input type="checkbox"/>	<input type="checkbox"/>	
31: High torque bias (by Pr.07-29)	<input type="checkbox"/>	<input type="checkbox"/>	<input type="checkbox"/>	<input type="checkbox"/>	<input type="checkbox"/>
32: Middle torque bias (by Pr.07-30)	<input type="checkbox"/>	<input type="checkbox"/>	<input type="checkbox"/>	<input type="checkbox"/>	<input type="checkbox"/>
33: Low torque bias (by Pr.07-31)	<input type="checkbox"/>	<input type="checkbox"/>	<input type="checkbox"/>	<input type="checkbox"/>	<input type="checkbox"/>
34: Enable multi-step position control		<input type="checkbox"/>		<input type="checkbox"/>	
35: Enable position control	<input type="checkbox"/>	<input type="checkbox"/>	<input type="checkbox"/>	<input type="checkbox"/>	
36: Enable position learning function (valid at stop)	<input type="checkbox"/>			<input type="checkbox"/>	
37: Enable pulse position input command	<input type="checkbox"/>	<input type="checkbox"/>	<input type="checkbox"/>	<input type="checkbox"/>	
38: Disable write EEPROM function	<input type="checkbox"/>	<input type="checkbox"/>	<input type="checkbox"/>	<input type="checkbox"/>	<input type="checkbox"/>
39: Torque command direction					<input type="checkbox"/>
40: Force stop	<input type="checkbox"/>	<input type="checkbox"/>	<input type="checkbox"/>	<input type="checkbox"/>	<input type="checkbox"/>
41: Serial position clock				<input type="checkbox"/>	
42: Serial position input				<input type="checkbox"/>	
43: Analog input resolution selection				<input type="checkbox"/>	
44: Reset initial reel diameter	<input type="checkbox"/>	<input type="checkbox"/>	<input type="checkbox"/>	<input type="checkbox"/>	<input type="checkbox"/>
45: Reset initial reel diameter 0	<input type="checkbox"/>	<input type="checkbox"/>	<input type="checkbox"/>	<input type="checkbox"/>	<input type="checkbox"/>
46: Reset initial reel diameter 1	<input type="checkbox"/>	<input type="checkbox"/>	<input type="checkbox"/>	<input type="checkbox"/>	<input type="checkbox"/>
47: Reset PID control integration of tension	<input type="checkbox"/>	<input type="checkbox"/>	<input type="checkbox"/>	<input type="checkbox"/>	<input type="checkbox"/>
48: Mechanical Gear Ratio Switch		<input type="checkbox"/>		<input type="checkbox"/>	<input type="checkbox"/>
49: Reserved					
50: Reserved					

-  This parameter selects the functions for each multi-function terminal.
-  The terminals of Pr.02-23~Pr.02-27 are virtual and set as MI7~MI10 when using with optional card EMV-APP01
-  If Pr.02-00 is set to 3-wire operation control. Terminal MI1 is needed for the 3rd wire position. Therefore, MI1 is not allowed for any other operation.
-  Multi-function input commands 7-14 are the extension terminals of Pr.02-01 to Pr.02-06. There are 14 terminals but the terminals 7-14 are virtual terminals and you can set the status of bit 8-15 of Pr.02-10 to ON or OFF by KPV-CE01 or communication.

Settings	Functions	Descriptions
0	No Function	
1	Multi-step speed command 1/multi-step position command 1	15 step speeds could be conducted through the digital statuses of the 4 terminals, and 17 in total if the master speed and JOG are included. (Refer to Pr. 04-00-04-29)
2	Multi-step speed command 2/ multi-step position command 2	
3	Multi-step speed command 3/ multi-step position command 3	
4	Multi-step speed command 4/ multi-step position command 4	
5	Reset	After the error of the drive is eliminated, use this terminal to reset the drive.
6	JOG Command	JOG operation
7	Acceleration/deceleration Speed Inhibit	When this function is enabled, acceleration and deceleration is stopped and the AC motor drive start to accel./decel. from the inhibit point.
8	The 1 st , 2 nd acceleration or deceleration time selection	The acceleration/deceleration time of the drive could be selected from this function or the digital statuses of the terminals; there are 4 acceleration/deceleration speeds in total for selection.
9	The 3 rd , 4 th acceleration or deceleration time selection	
10	EF Input	External fault input terminal
11	B.B. Input	If the ON/OFF function of the terminal is pre-determined, output of the drive will be cut off immediately, and the motor will then be of the B.B. status. And once the ON/OFF function is restored, the drive will then trace from the bottom upward to catch up with its mutual rotation speed with the same frequency before B.B., then speed up to the pre-set frequency. Even if the motor is of a complete stop after B.B., as long as the ON/OFF status is restored, the speed-tracing function could still be operated.
12	Output Stop	If the ON/OFF function of the terminal is pre-determined, output of the drive will be cut off immediately, and the motor will then be free run. And once the ON/OFF function is restored, the drive will accelerate to the setting frequency.
13	Cancel the setting of the	Before using this function, Pr.00-13 should be set to

Settings	Functions	Descriptions
	optimal accel./decel. time	01/02/03/04 first. When this function is enabled, OFF is for auto mode and ON is for linear accel./decel.
14	Switch between drive settings 1 and 2	When this function is enabled, the drive will start to use motor 2 parameters.
15	Operation speed command form AVI	When this function is enabled, the source of the frequency will force to be AVI.
16	Operation speed command form ACI	When this function is enabled, the source of the frequency will force to be ACI.
17	Operation speed command form AUI	When this function is enabled, the source of the frequency will force to be AUI.
18	Emergency Stop (07-36)	When this function is enabled, the drive will ramp to stop by Pr.07-36 setting.
19	Digital Up command	When this function is enabled, the frequency will be increased and decreased. If this function keeps ON, the frequency will be increased/decreased by Pr.02-07/Pr.02-08. This function is the same as the ▲ ▼ key on the keypad.
20	Digital Down command	
21	PID function disabled	When this function is ON, the PID function is disabled.
22	Clear counter	When this function is enabled, it will clear current counter value and display "0". Only when this function is disabled, it will keep counting upward.
23	Input the counter value (multi-function input command 6)	When this function is enabled, the counter value will increase 1.
24	FWD JOG command	When this function is enabled, the drive will execute forward Jog command.
25	REV JOG command	When this function is enabled, the drive will execute reverse Jog command.
26	TQC+PG/FOC+PG model selection	OFF: FOC+PG speed control mode. ON: TQR+PG torque control mode.
27	ASR1/ASR2 selection	ON: speed will be adjusted by ASR 2 setting. OFF: speed will be adjusted by ASR 1 setting.
28	Emergency stop (EF1)	When it is ON, the drive will execute emergency stop. (it will have fault code record)
29	Signal confirmation for Y-connection	When it is ON, the drive will operate by 1st V/f.
30	Signal confirmation for Δ-connection	When it is ON, the drive will operate by 2nd V/f.
31	High torque bias (by Pr.07-29)	The high torque bias is according to the Pr.07-29 setting.

Settings	Functions	Descriptions																																																																											
32	Middle torque bias (by Pr.07-30)	The middle torque bias is according to the Pr.07-30 setting.																																																																											
33	Low torque bias (by Pr.07-31)	The low torque bias is according to the Pr.07-31 setting.																																																																											
34	Enable multi-step position control	<p>When this function is enabled, the corresponding 15-step speed for the multi-function inputs 1-4 will be 15 positions. (Refer to Pr.04-15 to Pr.04-29)</p> <p>The diagram illustrates the timing of multi-step position control. It shows the state of various multi-function inputs (MI) and the resulting speed frequency (主速) during three different multi-position events. The events are labeled as 10-19 position (Home), 04-27 multi-position 13, and 04-26 multi-position 12. The speed frequency is shown as a series of pulses corresponding to these positions.</p> <p>Event 1: 10-19 position (Home)</p> <table border="1"> <thead> <tr> <th>MI</th> <th>1</th> <th>2</th> <th>3</th> <th>4</th> </tr> </thead> <tbody> <tr> <td>MI=d1</td> <td>1</td> <td>1</td> <td>0</td> <td>0</td> </tr> <tr> <td>MI=d2</td> <td>0</td> <td>0</td> <td>0</td> <td>0</td> </tr> <tr> <td>MI=d3</td> <td>1</td> <td>1</td> <td>1</td> <td>1</td> </tr> <tr> <td>MI=d4</td> <td>1</td> <td>1</td> <td>1</td> <td>1</td> </tr> </tbody> </table> <p>Event 2: 04-27 multi-position 13</p> <table border="1"> <thead> <tr> <th>MI</th> <th>1</th> <th>2</th> <th>3</th> <th>4</th> </tr> </thead> <tbody> <tr> <td>MI=d1</td> <td>1</td> <td>1</td> <td>1</td> <td>0</td> </tr> <tr> <td>MI=d2</td> <td>0</td> <td>0</td> <td>0</td> <td>0</td> </tr> <tr> <td>MI=d3</td> <td>1</td> <td>1</td> <td>1</td> <td>1</td> </tr> <tr> <td>MI=4</td> <td>1</td> <td>1</td> <td>1</td> <td>1</td> </tr> </tbody> </table> <p>Event 3: 04-26 multi-position 12</p> <table border="1"> <thead> <tr> <th>MI</th> <th>1</th> <th>2</th> <th>3</th> <th>4</th> </tr> </thead> <tbody> <tr> <td>MI=d1</td> <td>1</td> <td>1</td> <td>1</td> <td>0</td> </tr> <tr> <td>MI=d2</td> <td>0</td> <td>0</td> <td>0</td> <td>0</td> </tr> <tr> <td>MI=d3</td> <td>1</td> <td>1</td> <td>1</td> <td>1</td> </tr> <tr> <td>MI=4</td> <td>1</td> <td>1</td> <td>1</td> <td>1</td> </tr> </tbody> </table>	MI	1	2	3	4	MI=d1	1	1	0	0	MI=d2	0	0	0	0	MI=d3	1	1	1	1	MI=d4	1	1	1	1	MI	1	2	3	4	MI=d1	1	1	1	0	MI=d2	0	0	0	0	MI=d3	1	1	1	1	MI=4	1	1	1	1	MI	1	2	3	4	MI=d1	1	1	1	0	MI=d2	0	0	0	0	MI=d3	1	1	1	1	MI=4	1	1	1	1
MI	1	2	3	4																																																																									
MI=d1	1	1	0	0																																																																									
MI=d2	0	0	0	0																																																																									
MI=d3	1	1	1	1																																																																									
MI=d4	1	1	1	1																																																																									
MI	1	2	3	4																																																																									
MI=d1	1	1	1	0																																																																									
MI=d2	0	0	0	0																																																																									
MI=d3	1	1	1	1																																																																									
MI=4	1	1	1	1																																																																									
MI	1	2	3	4																																																																									
MI=d1	1	1	1	0																																																																									
MI=d2	0	0	0	0																																																																									
MI=d3	1	1	1	1																																																																									
MI=4	1	1	1	1																																																																									

Settings	Functions	Descriptions
35	Enable position control	<p>When this function is enabled, the AC motor drive will start to execute position control.</p> <p>The diagrams illustrate the motor's behavior during position control. The top diagram shows a smooth deceleration of the motor frequency to zero, with the PG feedback signal (10-00) following a decaying sine wave pattern. The bottom diagram shows a similar deceleration but with a small overshoot in the motor frequency and a corresponding overshoot in the PG feedback signal (10-00). Both diagrams include signals for RUN, MI=d35, and MO=d39 over time.</p>
36	Enable position learning function (valid at stop)	<p>When this function is enabled, it will select the corresponding multi-position by the ON/OFF status of multi-function inputs 1-4 and written the current motor position into the corresponding multi-position.</p>

Settings	Functions	Descriptions
		<p>Run/Stop</p> <p> $1011_2=11$ corresponds to Pr.04-25 $1010_2=10$ corresponds to Pr.04-24 </p> <p>MI=d1</p> <p>MI=d2</p> <p>MI=d3</p> <p>MI=d4</p> <p>MI=d36</p> <p>The motor position is from encoder feedback and written into the corresponding multi-position of ON/OFF status of MI1 to MI4 (Pr.04-25)</p> <p>The motor position is from encoder feedback and written into the corresponding multi-position of ON/OFF status of MI1 to MI4 (Pr.04-24)</p>
37	Enable pulse position input command	<p>When this function is enabled, the pulse of PG card will change from speed command to position command. It is recommended to set Pr.10-23 to 0.</p> <p>Example: When it is controlled by pulse (Pr.00-20 is set to 5), please refer to the following diagram for returning home.</p> <p>RUN</p> <p>MI=d35</p> <p>MO=d5</p> <p>MI=d37</p> <p>Time</p>
38	Disable write EEPROM function	When this function is enabled, you can't write into EEPROM.
39	Torque command direction	When the torque command source is AVI or ACI, it can change torque direction by enabling this function.
40	Force stop	When this function is enabled, the drive will free run to stop.
41	Serial position clock	The position method of the main shaft:

Settings	Functions	Descriptions																																																																																																																
42	Serial position input	<p>When using setting 41 and setting 42, it needs to use with 2 input terminals for multi-position control.</p> <p>transmission start</p> <p>OSS Clock</p> <p>OSS Data</p> <p>PG position control point Pr.10-19</p> <p>main shaft VFD-VE</p> <p>Ready for transmission</p> <p>test example</p> <table border="1"> <thead> <tr> <th>angle</th> <th>Encoder</th> <th>b11</th> <th>b10</th> <th>b9</th> <th>b8</th> <th>b7</th> <th>b6</th> <th>b5</th> <th>b4</th> <th>b3</th> <th>b2</th> <th>b1</th> <th>b0</th> </tr> </thead> <tbody> <tr> <td>36.0</td> <td>4096</td> <td>0</td> <td>0</td> <td>0</td> <td>0</td> <td>0</td> <td>0</td> <td>0</td> <td>0</td> <td>0</td> <td>0</td> <td>0</td> <td>0</td> </tr> <tr> <td>18.0</td> <td>2048</td> <td>1</td> <td>1</td> <td>1</td> <td>1</td> <td>1</td> <td>1</td> <td>1</td> <td>1</td> <td>1</td> <td>1</td> <td>1</td> <td>1</td> </tr> <tr> <td>9.0</td> <td>1024</td> <td>0</td> <td>1</td> <td>0</td> <td>0</td> <td>0</td> <td>0</td> <td>0</td> <td>0</td> <td>0</td> <td>0</td> <td>0</td> <td>0</td> </tr> <tr> <td>4.5</td> <td>512</td> <td>0</td> <td>0</td> <td>1</td> <td>0</td> <td>0</td> <td>0</td> <td>0</td> <td>0</td> <td>0</td> <td>0</td> <td>0</td> <td>0</td> </tr> <tr> <td>13.7</td> <td>1538</td> <td>0</td> <td>1</td> <td>1</td> <td>0</td> <td>0</td> <td>0</td> <td>0</td> <td>1</td> <td>0</td> <td>1</td> <td>1</td> <td>0</td> </tr> <tr> <td>30.8</td> <td>3504</td> <td>1</td> <td>1</td> <td>0</td> <td>1</td> <td>1</td> <td>0</td> <td>1</td> <td>1</td> <td>0</td> <td>0</td> <td>0</td> <td>0</td> </tr> <tr> <td></td> <td>3687</td> <td>1</td> <td>1</td> <td>1</td> <td>0</td> <td>0</td> <td>1</td> <td>1</td> <td>0</td> <td>0</td> <td>1</td> <td>1</td> <td>1</td> </tr> </tbody> </table>	angle	Encoder	b11	b10	b9	b8	b7	b6	b5	b4	b3	b2	b1	b0	36.0	4096	0	0	0	0	0	0	0	0	0	0	0	0	18.0	2048	1	1	1	1	1	1	1	1	1	1	1	1	9.0	1024	0	1	0	0	0	0	0	0	0	0	0	0	4.5	512	0	0	1	0	0	0	0	0	0	0	0	0	13.7	1538	0	1	1	0	0	0	0	1	0	1	1	0	30.8	3504	1	1	0	1	1	0	1	1	0	0	0	0		3687	1	1	1	0	0	1	1	0	0	1	1	1
angle	Encoder	b11	b10	b9	b8	b7	b6	b5	b4	b3	b2	b1	b0																																																																																																					
36.0	4096	0	0	0	0	0	0	0	0	0	0	0	0																																																																																																					
18.0	2048	1	1	1	1	1	1	1	1	1	1	1	1																																																																																																					
9.0	1024	0	1	0	0	0	0	0	0	0	0	0	0																																																																																																					
4.5	512	0	0	1	0	0	0	0	0	0	0	0	0																																																																																																					
13.7	1538	0	1	1	0	0	0	0	1	0	1	1	0																																																																																																					
30.8	3504	1	1	0	1	1	0	1	1	0	0	0	0																																																																																																					
	3687	1	1	1	0	0	1	1	0	0	1	1	1																																																																																																					
43	Analog input resolution selection	Refer to Pr.10-25.																																																																																																																
44	Reset initial reel diameter	When this function is enabled, the initial reel diameter is reset.																																																																																																																
45	Reset initial reel diameter 0	When this function is enabled, Pr.08-46~08-48 is valid.																																																																																																																
46	Reset initial reel diameter 1																																																																																																																	
47	Reset PID control integration of tension	When this function is enabled, the PID control integration of tension is reset.																																																																																																																
48	Mechanical Gear Ratio Switch	When this function is enabled, the mechanical gear ratio switch will be the second group A2/B2 (refer to Pr.10-29 and Pr.10-30).																																																																																																																
49 50	Reserved																																																																																																																	

02-07 ✓ UP/DOWN Key Mode

Control mode	VF	VFG	SVC	FOCPG	Factory setting: 0
Settings	0				Up/down by the accel/decel time
		1			Up/down constant speed (Pr.02-08)

02-08 ⚡ The Acceleration/Deceleration Speed of the UP/DOWN Key with Constant Speed Unit: 0.01

Control mode	VF	VFPG	SVC	FOCPG	Factory setting: 0.01
Settings	0.01 ~ 1.00Hz/ms				

📖 These settings are used when multi-function input terminals are set to 19/20.

02-09 Digital Input Response Time Unit: 0.001

Control mode	VF	VFPG	SVC	FOCPG	TQRPG	Factory setting: 0.005
Settings	0.001~ 30.000 sec					

📖 This parameter is used for digital input terminal signal delay and confirmation. The delay time is confirmation time to prevent some uncertain interferences that would result in error (except for the counter input) in the input of the digital terminals (FWD, REV and MI1~6). Under this condition, confirmation for this parameter could be improved effectively, but the response time will be somewhat delayed.

02-10 ⚡ Digital Input Operation Direction Unit: 1

Control mode	VF	VFPG	SVC	FOCPG	TQRPG	Factory setting: 0
Settings	0 ~ 65535					

📖 This parameter is used to set the input signal level and it won't be affected by the SINK/SOURCE status.

📖 Bit0 is for FWD terminal, bit1 is for REV terminal and bit2 to bit15 is for MI1 to MI14.

📖 User can change terminal status by communicating.

For example, MI1 is set to 1 (multi-step speed command 1), MI2 is set to 2 (multi-step speed command 2). Then the forward + 2nd step speed command=1001(binary)=9 (Decimal). Only need to set Pr.02-10=9 by communication and it can forward with 2nd step speed. It doesn't need to wire any multi-function terminal.

bit15	bit14	bit13	bit12	bit11	bit10	bit9	bit8	bit7	bit6	bit5	bit4	bit3	bit2	bit1	bit0
MI14	MI13	MI12	MI11	MI10	MI9	MI8	MI7	MI6	MI5	MI4	MI3	MI2	MI1	REV	FWD

02-11 ⚡ Multi-function Output 1 RA, RB, RC (Relay1)

Factory Setting: 11

02-12 ⚡ Multi-function Output 2 MRA, MRC (Relay2)

Factory Setting: 1

02-13 ✎ Multi-function Output 3 (MO1)

Factory Setting: 0

02-14 ✎ Multi-function Output 4 (MO2)

Factory Setting: 0

02-35 ✎ Multi-function Output 5 (MO3) (need to use with EMV-APP01)

Factory Setting: 0

02-36 ✎ Multi-function Output 5 6 (MO4) (need to use with EMV-APP01)

Factory Setting: 0

02-37 ✎ Multi-function Output 5 7 (MO3MO5) (need to use with EMV-APP01)

Factory Setting: 0

02-38 ✎ Multi-function Output 8 (MO6) (need to use with EMV-APP01)

Factory Setting: 0

02-39 ✎ Multi-function Output 9 (MO7) (need to use with EMV-APP01)

Factory Setting: 0

02-40 ✎ Multi-function Output 10 (MO8) (need to use with EMV-APP01)

Factory Setting: 0

02-41 ✎ Multi-function Output 11 (MO9) (need to use with EMV-APP01)

Factory Setting: 0

02-42 ✎ Multi-function Output 12 (MOA) (need to use with EMV-APP01)

Factory Setting: 0

Settings 0-50

Settings	Control Mode				
	VF	VFG	SVC	FOCPG	TQRP
0: No function					
1: Operation indication	<input type="radio"/>	<input type="radio"/>	<input type="radio"/>	<input type="radio"/>	<input type="radio"/>
2: Operation speed attained	<input type="radio"/>	<input type="radio"/>	<input type="radio"/>	<input type="radio"/>	<input type="radio"/>
3: Desired frequency attained 1 (Pr.02-19)	<input type="radio"/>	<input type="radio"/>	<input type="radio"/>	<input type="radio"/>	<input type="radio"/>
4: Desired frequency attained 2 (Pr.02-21)	<input type="radio"/>	<input type="radio"/>	<input type="radio"/>	<input type="radio"/>	<input type="radio"/>
5: Zero speed (frequency command)	<input type="radio"/>	<input type="radio"/>	<input type="radio"/>	<input type="radio"/>	<input type="radio"/>
6: Zero speed with stop (frequency command)	<input type="radio"/>	<input type="radio"/>	<input type="radio"/>	<input type="radio"/>	<input type="radio"/>
7: Over torque (OT1) (Pr.06-06~06-08)	<input type="radio"/>	<input type="radio"/>	<input type="radio"/>	<input type="radio"/>	<input type="radio"/>
8: Over torque (OT2) (Pr.06-09~06-11)	<input type="radio"/>	<input type="radio"/>	<input type="radio"/>	<input type="radio"/>	<input type="radio"/>
9: Drive ready	<input type="radio"/>	<input type="radio"/>	<input type="radio"/>	<input type="radio"/>	<input type="radio"/>
10: User-defined Low-voltage Detection	<input type="radio"/>	<input type="radio"/>	<input type="radio"/>	<input type="radio"/>	<input type="radio"/>
11: Malfunction indication	<input type="radio"/>	<input type="radio"/>	<input type="radio"/>	<input type="radio"/>	<input type="radio"/>

Settings	Control Mode				
	VF	VFPG	SVC	FOCPG	TQRP
12: Mechanical brake release (Pr.02-31)	<input type="checkbox"/>	<input type="checkbox"/>	<input type="checkbox"/>	<input type="checkbox"/>	<input type="checkbox"/>
13: Overheat	<input type="checkbox"/>	<input type="checkbox"/>	<input type="checkbox"/>	<input type="checkbox"/>	<input type="checkbox"/>
14: Software brake signal	<input type="checkbox"/>	<input type="checkbox"/>	<input type="checkbox"/>	<input type="checkbox"/>	<input type="checkbox"/>
15: PID feedback error	<input type="checkbox"/>	<input type="checkbox"/>	<input type="checkbox"/>	<input type="checkbox"/>	<input type="checkbox"/>
16: Slip error (oSL)	<input type="checkbox"/>	<input type="checkbox"/>	<input type="checkbox"/>	<input type="checkbox"/>	<input type="checkbox"/>
17: Terminal count value attained (Pr.02-16)	<input type="checkbox"/>	<input type="checkbox"/>	<input type="checkbox"/>	<input type="checkbox"/>	<input type="checkbox"/>
18: Preliminary count value attained (Pr.02-17)	<input type="checkbox"/>	<input type="checkbox"/>	<input type="checkbox"/>	<input type="checkbox"/>	<input type="checkbox"/>
19: Baseblock (B.B.) Indication	<input type="checkbox"/>	<input type="checkbox"/>	<input type="checkbox"/>	<input type="checkbox"/>	<input type="checkbox"/>
20: Warning output	<input type="checkbox"/>	<input type="checkbox"/>	<input type="checkbox"/>	<input type="checkbox"/>	<input type="checkbox"/>
21: Over voltage warning	<input type="checkbox"/>	<input type="checkbox"/>	<input type="checkbox"/>	<input type="checkbox"/>	<input type="checkbox"/>
22: Over-current stall prevention warning	<input type="checkbox"/>	<input type="checkbox"/>	<input type="checkbox"/>	<input type="checkbox"/>	<input type="checkbox"/>
23: Over-voltage stall prevention warning	<input type="checkbox"/>	<input type="checkbox"/>	<input type="checkbox"/>	<input type="checkbox"/>	<input type="checkbox"/>
24: Operation mode indication	<input type="checkbox"/>	<input type="checkbox"/>	<input type="checkbox"/>	<input type="checkbox"/>	<input type="checkbox"/>
25: Forward command	<input type="checkbox"/>	<input type="checkbox"/>	<input type="checkbox"/>	<input type="checkbox"/>	<input type="checkbox"/>
26: Reverse command	<input type="checkbox"/>	<input type="checkbox"/>	<input type="checkbox"/>	<input type="checkbox"/>	<input type="checkbox"/>
27: Output when current >= Pr.02-32	<input type="checkbox"/>	<input type="checkbox"/>	<input type="checkbox"/>	<input type="checkbox"/>	<input type="checkbox"/>
28: Output when current < Pr.02-32	<input type="checkbox"/>	<input type="checkbox"/>	<input type="checkbox"/>	<input type="checkbox"/>	<input type="checkbox"/>
29: Output when frequency >= Pr.02-33	<input type="checkbox"/>	<input type="checkbox"/>	<input type="checkbox"/>	<input type="checkbox"/>	<input type="checkbox"/>
30: Output when frequency < Pr.02-33	<input type="checkbox"/>	<input type="checkbox"/>	<input type="checkbox"/>	<input type="checkbox"/>	<input type="checkbox"/>
31: Y-connection for the motor coil	<input type="checkbox"/>	<input type="checkbox"/>	<input type="checkbox"/>	<input type="checkbox"/>	<input type="checkbox"/>
32: Δ connection for the motor coil	<input type="checkbox"/>	<input type="checkbox"/>	<input type="checkbox"/>	<input type="checkbox"/>	<input type="checkbox"/>
33: Zero speed (actual output frequency)	<input type="checkbox"/>	<input type="checkbox"/>	<input type="checkbox"/>	<input type="checkbox"/>	<input type="checkbox"/>
34: Zero speed with Stop (actual output frequency)	<input type="checkbox"/>	<input type="checkbox"/>	<input type="checkbox"/>	<input type="checkbox"/>	<input type="checkbox"/>
35: Error output selection 1 (Pr.06-23)	<input type="checkbox"/>	<input type="checkbox"/>	<input type="checkbox"/>	<input type="checkbox"/>	<input type="checkbox"/>
36: Error output selection 2 (Pr.06-24)	<input type="checkbox"/>	<input type="checkbox"/>	<input type="checkbox"/>	<input type="checkbox"/>	<input type="checkbox"/>
37: Error output selection 3 (Pr.06-25)	<input type="checkbox"/>	<input type="checkbox"/>	<input type="checkbox"/>	<input type="checkbox"/>	<input type="checkbox"/>
38: Error output selection 4 (Pr.06-26)	<input type="checkbox"/>	<input type="checkbox"/>	<input type="checkbox"/>	<input type="checkbox"/>	<input type="checkbox"/>
39: Position attained (Pr.10-19)	<input type="checkbox"/>	<input type="checkbox"/>	<input type="checkbox"/>	<input type="checkbox"/>	<input type="checkbox"/>
40: Speed attained (including zero speed)	<input type="checkbox"/>	<input type="checkbox"/>	<input type="checkbox"/>	<input type="checkbox"/>	<input type="checkbox"/>
41: Multi-position attained	<input type="checkbox"/>	<input type="checkbox"/>	<input type="checkbox"/>	<input type="checkbox"/>	<input type="checkbox"/>
42: Crane function	<input type="checkbox"/>	<input type="checkbox"/>	<input type="checkbox"/>	<input type="checkbox"/>	<input type="checkbox"/>
43: Motor zero-speed output (Pr.02-43)	<input type="checkbox"/>	<input type="checkbox"/>	<input type="checkbox"/>	<input type="checkbox"/>	<input type="checkbox"/>
44: Max. reel diameter attained	<input type="checkbox"/>	<input type="checkbox"/>	<input type="checkbox"/>	<input type="checkbox"/>	<input type="checkbox"/>
45: Empty reel diameter attained	<input type="checkbox"/>	<input type="checkbox"/>	<input type="checkbox"/>	<input type="checkbox"/>	<input type="checkbox"/>
46: Broken belt detection	<input type="checkbox"/>	<input type="checkbox"/>	<input type="checkbox"/>	<input type="checkbox"/>	<input type="checkbox"/>
47: Break release at stop	<input type="checkbox"/>	<input type="checkbox"/>	<input type="checkbox"/>	<input type="checkbox"/>	<input type="checkbox"/>
48: Error PID feedback of tension	<input type="checkbox"/>	<input type="checkbox"/>	<input type="checkbox"/>	<input type="checkbox"/>	<input type="checkbox"/>
49: Reserved					
50: Reserved					

Settings	Functions	Descriptions
0	No Function	
1	Operation Indication	Active when the drive is not at STOP.
2	Master Frequency Attained	Active when the AC motor drive reaches the output frequency setting.
3	Desired Frequency Attained 1 (Pr.02-19)	Active when the desired frequency (Pr.02-19) is attained.

Settings	Functions	Descriptions
4	Desired Frequency Attained 2 (Pr.02-21)	Active when the desired frequency (Pr.02-21) is attained.
5	Zero Speed (frequency command)	Active when frequency command =0. (the drive should be at RUN mode)
6	Zero Speed with Stop (frequency command)	Active when frequency command =0 or stop.
7	Over Torque (OT1) (Pr.06-06~06-08)	Active when detecting over-torque. Refer to Pr.06-06 (over-torque detection selection-OT1), Pr.06-07 (over-torque detection level-OT1) and Pr.06-08 (over-torque detection time-OT1).
8	Over Torque (OT2) (Pr.06-09~06-11)	Active when detecting over-torque. Refer to Pr.06-09 (over-torque detection selection-OT2), Pr.06-10 (over-torque detection level-OT2) and Pr.06-11 (over-torque detection time-OT2).
9	Drive Ready	Active when the drive is ON and no abnormality detected.
10	User-defined Low-voltage Detection	Active when the DC Bus voltage is too low. (refer to Pr.06-00 low voltage level)
11	Malfunction Indication	Active when fault occurs (except Lv stop).
12	Mechanical Brake Release (Pr.02-31)	When drive runs after Pr.02-31, it will be ON. This function should be used with DC brake and it is recommended to use contact "b"(N.C).
13	Overheat	Active when IGBT or heat sink overheats to prevent OH turn off the drive. (refer to Pr.06-05)
14	Software Brake Signal	This function is used in conjunction with a VFDB Brake Unit. The output will be activated when the drive needs help braking the load. A smooth deceleration is achieved by using this function. (refer to Pr.07-00)
15	PID Feedback Error	Active when the feedback signal is abnormal.
16	Slip Error (oSL)	Active when the slip error is detected.
17	Terminal Count Value Attained	Active when the counter reaches Terminal Counter Value (Pr.02-16).
18	Preliminary Counter Value Attained	Active when the counter reaches Preliminary Counter Value (Pr.02-17).
19	Baseblock (B.B.) Indication	Active when the output of the AC motor drive is shut off during baseblock.
20	Warning Output	Active when the warning is detected.

Settings	Functions	Descriptions
21	Over-voltage Warning	Active when the over-voltage is detected.
22	Over-current Stall Prevention Warning	Active when the over-current stall prevention is detected.
23	Over-voltage Stall prevention Warning	Active when the over-voltage stall prevention is detected.
24	Operation Mode Indication	Active when the operation command is controlled by external terminal.
25	Forward Command	Active when the operation direction is forward.
26	Reverse Command	Active when the operation direction is reverse.
27	Output when Current \geq Pr.02-32	Active when current is \geq Pr.02-32.
28	Output when Current $<$ Pr.02-32	Active when current is $<$ Pr.02-32.
29	Output when frequency \geq Pr.02-33	Active when frequency is \geq Pr.02-33.
30	Output when Frequency $<$ Pr.02-33	Active when frequency is $<$ Pr.02-33.
31	Y-connection for the Motor Coil	Active when PR.05-12 is less than PR.05-11 and time is more than Pr.05-30.
32	Δ -connection for the Motor Coil	Active when PR.05-12 is higher than PR.05-11 and time is more than Pr.05-30.
33	Zero Speed (actual output frequency)	Active when the actual output frequency is 0. (the drive should be at RUN mode)
34	Zero Speed with Stop (actual output frequency)	Active when the actual output frequency is 0 or Stop.
35	Error Output Selection 1 (Pr.06-23)	Active when Pr.06-23 is ON.
36	Error Output Selection 2 (Pr.06-24)	Active when Pr.06-24 is ON.
37	Error Output Selection 3 (Pr.06-25)	Active when Pr.06-25 is ON.
38	Error Output Selection 4 (Pr.06-26)	Active when Pr.06-26 is ON.
39	Position Attained (Pr.10-19)	Active when the PG position control point reaches Pr.10-19.

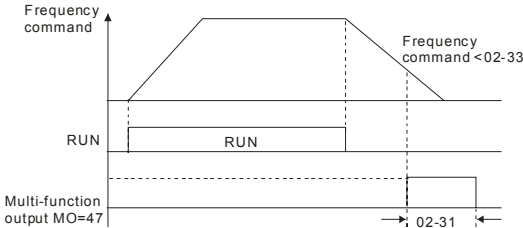
Settings	Functions	Descriptions
40	Speed Attained (including zero speed)	Active when the output frequency reaches frequency setting or stop.
41	Multi-position Attained	User can set any three multi-function input terminals to 41. The current position action status of these three terminals will be outputted. Example: if setting Pr.02-11, Pr.02-12 and Pr.02-13 to 41 and only the multi-position of the second point has been done. Therefore, current status are RA (OFF), MRA (ON) and MO1 (OFF). In this way, their status is 010.
42	Crane Function	This function should be used with Pr.02-31, Pr.02-32 and Pr.02-33. Active when setting Pr.07-16=Pr.02-33 and Fcmd > Pr.02-33 and output current > Pr.02-32 and Time > Pr.02-31. The example of the crane application is in the following for your reference.
43	Motor Zero-speed Output (Pr.02-43)	Active when motor actual speed is less than Pr.02-43.
44	Max. Reel Diameter Attained	Active when the reel diameter is equal to Pr.08-43.
45	Empty Reel Diameter Attained	Active when the reel diameter is equal to Pr.08-44.
46	Broken Belt Detection	The broken belt occurs when 1. line speed is higher than Pr.08-61, 2. the error of reel diameter exceeds Pr.08-61, 3. detection time exceeds Pr.08-62
47	Break Release at Stop	When drive stops, the corresponding multi-function terminal will be ON if the frequency is less than Pr.02-33. After it is ON, it will be OFF when brake delay time exceeds Pr.02-31.  <p>The diagram illustrates the timing of the Break Release at Stop function. It consists of three vertically aligned graphs sharing a common time axis. The top graph shows the 'Frequency command' (Hz) as a trapezoidal wave, starting at a low frequency, increasing to a peak, and then decreasing. The middle graph shows the 'RUN' status, which is ON during the acceleration and deceleration phases of the frequency command. The bottom graph shows the 'Multi-function output MO=47'. This output is ON when the frequency command is below a threshold value (Pr.02-33) and OFF after a delay time (Pr.02-31) following the end of the RUN phase.</p>
48	Error PID Feedback of Tension	When the error between PID target value and PID feedback exceeds Pr.08-63 and allowance error detection time of tension PID feedback exceeds Pr.08-64, please refer to Pr. 08-64 for error treatment of tension PID feedback.
49	Reserved	

Settings	Functions	Descriptions
50	Reserved	

Example of crane function

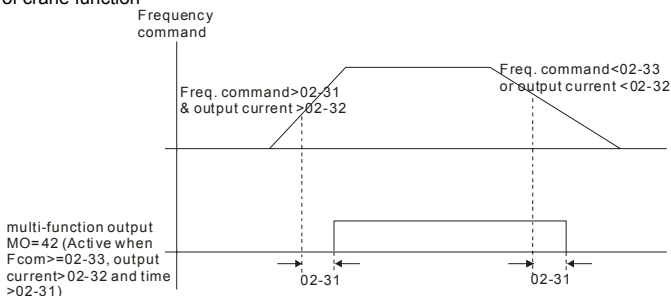

It is recommended to be used with Dwell function (Pr.07-15 to Pr.07-18) as shown in the following:

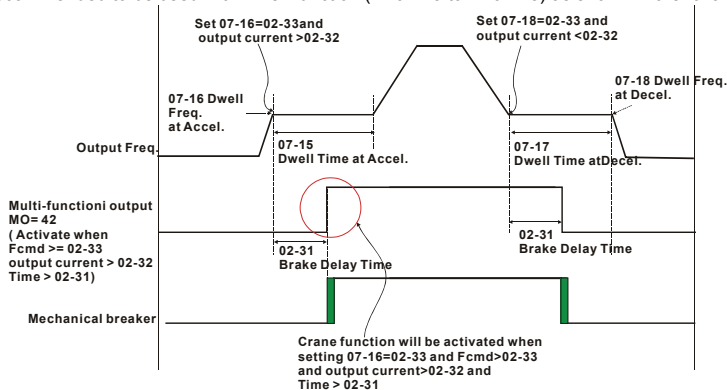

02-15 Multi-output Direction

Unit:1

Control mode VF VFPG SVC FOC PG TQRPG

Factory setting: 0

Settings 0 ~ 65535

This parameter is set via bit setting. If a bit is 1, the corresponding output acts in the opposite way.

Example:

If Pr02-11=1 and Pr02-15=0, Relay 1 RA-RC is closed when the drive runs and is open when the drive is stopped.

If Pr02-11=1 and Pr02-15=1, Relay 1 RA-RC is open when the drive runs and is closed when the drive is stopped.



Bit setting

bit3 MO2	bit2 MO1	bit1 RA	bit0 MRA	Pr02-15
0	0	0	0	0
0	0	0	1	1
0	0	1	0	2
0	0	1	1	3
0	1	0	0	4
0	1	0	1	5
0	1	1	0	6
0	1	1	1	7
1	0	0	0	8
1	0	0	1	9
1	0	1	0	10
1	0	1	1	11
1	1	0	0	12
1	1	0	1	13
1	1	1	0	14
1	1	1	1	15

02-16 Terminal Count Value

Unit:1

Control mode	VF	VFPG	SVC	FOCPG	TQRP

Factory setting: 0

Settings 0 ~ 65535



The counter trigger can be set by the multi-function terminal MI6 (set Pr.02-06 to 23). Upon completion of counting, the specified output terminal will be activated (Pr.02-11 to Pr.02-14 is set to 17).

02-17 Preliminary Count Value

Unit:1

Control mode	VF	VFPG	SVC	FOCPG	TQRP

Factory setting: 0

Settings 0 ~ 65535



When the counter value reaches this value, the corresponding multi-function output terminal will be activated, provided one of Pr. 02-11 to 02-14 set to 18 (Preliminary Count Value Setting). This parameter can be used for the end of the counting to make the drive runs from the low speed to stop.

Chapter 4 Parameters | VFD-VE

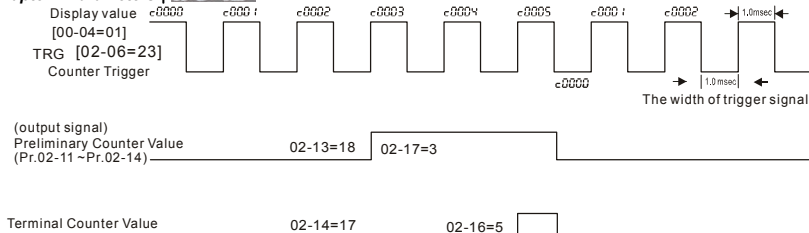

02-18 Digital Output Gain

Unit: 1

Control mode	VF	VFPG	SVC	FOCPG	TQRPG	Factory setting: 1
Settings			1 ~ 40			

It is used to set the signal for the digital output terminals (DFM-DCM) and digital frequency output (pulse X work period=50%). Output pulse per second = output frequency X Pr.02-18.

02-19 Desired Frequency Attained 1

Unit: 0.01

Control mode	VF	VFPG	SVC	FOCPG	Factory setting: 60.00/50.00
--------------	----	------	-----	-------	------------------------------

02-20 The Width of the Desired Frequency Attained 1

Unit: 0.01

Control mode	VF	VFPG	SVC	FOCPG	Factory setting: 2.00
--------------	----	------	-----	-------	-----------------------

02-21 Desired Frequency Attained 2

Unit: 0.01

Control mode	VF	VFPG	SVC	FOCPG	Factory setting: 60.00/50.00
--------------	----	------	-----	-------	------------------------------

02-22 The Width of the Desired Frequency Attained 2

Unit: 0.01

Control mode	VF	VFPG	SVC	FOCPG	Factory setting: 2.00
--------------	----	------	-----	-------	-----------------------

Settings 0.00 ~ 600.00Hz

Once output frequency reaches desired frequency and the corresponding multi-function output terminal is set to 3 or 4 (Pr.02-11~Pr.02-14), this multi-function output terminal will be ON.

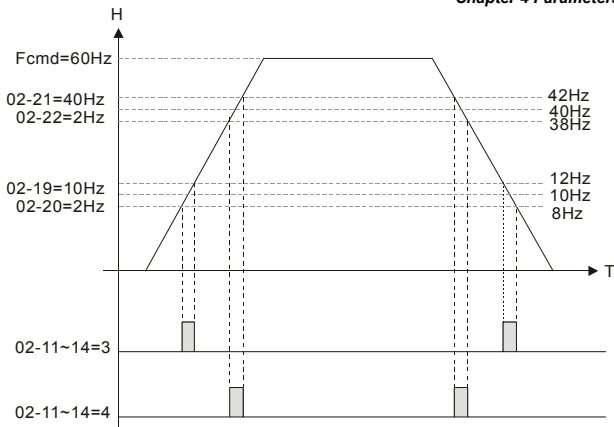
**02-31** Brake Delay Time

Unit:0.001

Control mode

VF

VFP

SVC

FOCPG

TQRP

Factory setting: 0.000

Settings 0.000~65.000 Sec

When the AC motor drive runs after Pr.02-31 delay time, the corresponding multi-function output terminal (12: mechanical brake release) will be ON. This function should be used with DC brake.

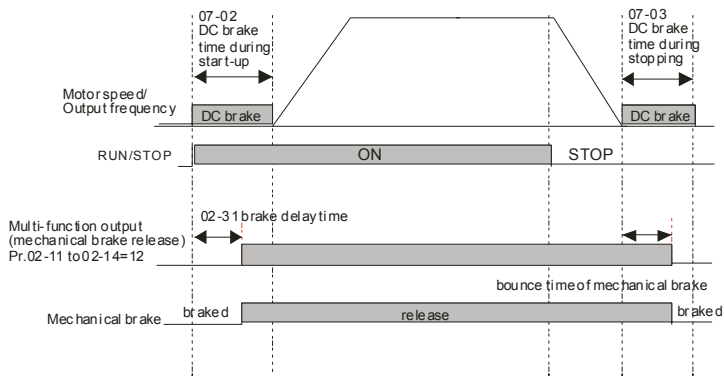
**02-32** Output Current Level Setting for External Terminals

Unit:1

Control mode

VF

VFP



SVC

FOCPG

TQRP

Factory setting: 0



Settings 0~100%

-  When output current is higher than Pr.02-32, it will activate multi-function output terminal (Pr.02-11 to Pr.02-14 is set to 27).
-  When output current is lower than Pr.02-32, it will activate multi-function output terminal (Pr.02-11 to Pr.02-14 is set to 28).

02-33  Output Boundary for External Terminals Unit:0.01

Control mode	VF	VFPG	SVC	FOCPG	TQRP	Factory setting: 0.00
---------------------	-----------	-------------	------------	--------------	-------------	-----------------------

Settings 0.00~+60.00Hz

-  When output frequency is higher than Pr.02-33, it will activate the multi-function terminal (Pr.02-11 to Pr.02-14 is set to 29).
-  When output frequency is lower than Pr.02-33, it will activate the multi-function terminal (Pr.02-11 to Pr.02-14 is set to 30).

02-34  External Operation Control Selection after Reset Unit:1

Control mode	VF	VFPG	SVC			Factory setting: 0
---------------------	-----------	-------------	------------	--	--	--------------------

Settings 0: Disable

1: Drive runs if run command exists after reset

-  After clearing fault once a fault is detected and the external terminal for RUN keeps ON, the drive can run after pressing RESET key.

02-43  Zero-speed Level of Motor Unit: 1

Control mode	VF	VFPG	SVC	FOCPG	TQRP	Factory setting: 0
---------------------	-----------	-------------	------------	--------------	-------------	--------------------

Settings 0~65535rpm

Group 3 Analog Input/Output Parameters**03-00**  Analog Input 1 (AVI)

Factory Setting: 1



03-01  Analog Input 2 (ACI)

Factory Setting: 0

03-02  Analog Input 3 (AUI)

Factory Setting: 0

Settings	Control Mode				
	VF	VFPG	SVC	FOCPG	TQRPG
0: No function	<input type="radio"/>	<input type="radio"/>	<input type="radio"/>	<input type="radio"/>	<input type="radio"/>
1: Frequency command (torque limit under TQR control mode)	<input type="radio"/>	<input type="radio"/>	<input type="radio"/>	<input type="radio"/>	<input type="radio"/>
2: torque command (torque limit under speed mode)					<input type="radio"/>
3: Torque compensation command	<input type="radio"/>	<input type="radio"/>	<input type="radio"/>	<input type="radio"/>	<input type="radio"/>
4: PID target value (refer to group 8)	<input type="radio"/>	<input type="radio"/>	<input type="radio"/>	<input type="radio"/>	
5: PID feedback signal (refer to group 8)	<input type="radio"/>	<input type="radio"/>	<input type="radio"/>	<input type="radio"/>	
6: P.T.C. thermistor input value	<input type="radio"/>	<input type="radio"/>	<input type="radio"/>	<input type="radio"/>	<input type="radio"/>
7: Positive torque limit				<input type="radio"/>	
8: Negative torque limit				<input type="radio"/>	
9: Regenerative torque limit				<input type="radio"/>	
10: Positive/negative torque limit				<input type="radio"/>	
11: PID feedback signal of tension	<input type="radio"/>	<input type="radio"/>	<input type="radio"/>	<input type="radio"/>	<input type="radio"/>
12: Line speed	<input type="radio"/>	<input type="radio"/>	<input type="radio"/>	<input type="radio"/>	<input type="radio"/>
13: Reel diameter	<input type="radio"/>	<input type="radio"/>	<input type="radio"/>	<input type="radio"/>	<input type="radio"/>
14: PID target value of tension (tension closed-loop)	<input type="radio"/>	<input type="radio"/>	<input type="radio"/>	<input type="radio"/>	<input type="radio"/>
15: Tension setting (tension open-loop)					<input type="radio"/>
16: Zero-speed tension					<input type="radio"/>
17: Tension taper					<input type="radio"/>

-  When it is frequency command or TQR speed limit, the corresponding value for 0~±10V/4~20mA is 0 – max. output frequency(Pr.01-00)
-  When it is torque command or torque limit, the corresponding value for 0~±10V/4~20mA is 0 – max. output torque (Pr.07-22).
-  When it is torque compensation, the corresponding value for 0~±10V/4~20mA is 0 – rated torque.

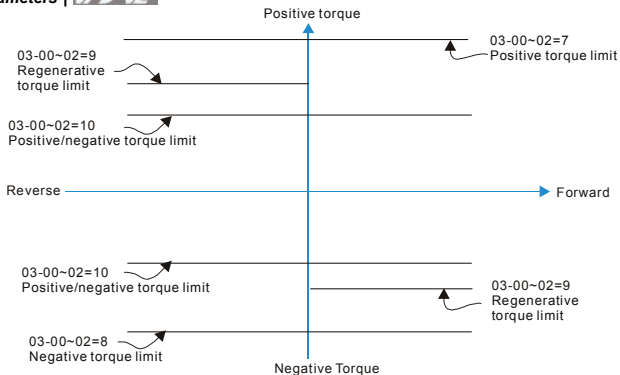
**03-03** **↗ Analog Input Bias 1 (AVI)**

Unit: 0.1

Control mode	VF	VFPG	SVC	FOCPG	TQRPG
--------------	----	------	-----	-------	-------

Factory setting: 0

Settings -100.0~100.0%

It is used to set the corresponding AVI voltage of the external analog input 0.

03-04 **↗ Analog Input Bias 1 (ACI)**

Unit: 0.1

Control mode	VF	VFPG	SVC	FOCPG	TQRPG
--------------	----	------	-----	-------	-------

Factory setting: 0

Settings -100.0~100.0%

It is used to set the corresponding ACI voltage of the external analog input 0.

03-05 **↗ Analog Input Bias 1 (AUI)**

Unit: 0.1

Control mode	VF	VFPG	SVC	FOCPG	TQRPG
--------------	----	------	-----	-------	-------

Factory setting: 0

Settings -100.0~100.0%

It is used to set the corresponding AUI voltage of the external analog input 0.

03-06 **↗ Positive/negative Bias Mode (AVI)****03-07** **↗ Positive/negative Bias Mode (ACI)****03-08** **↗ Positive/negative Bias Mode (AUI)**

Factory setting: 0

Control mode	VF	VFPG	SVC	FOCPG	TQRPG
Settings		0	Zero bias		
		1	Lower than bias=bias		
		2	Greater than bias=bias		
		3	The absolute value of the bias voltage while serving as the center		
		4	Serve bias as the center		

 In a noisy environment, it is advantageous to use negative bias to provide a noise margin. It is recommended NOT to use less than 1V to set the operation frequency.

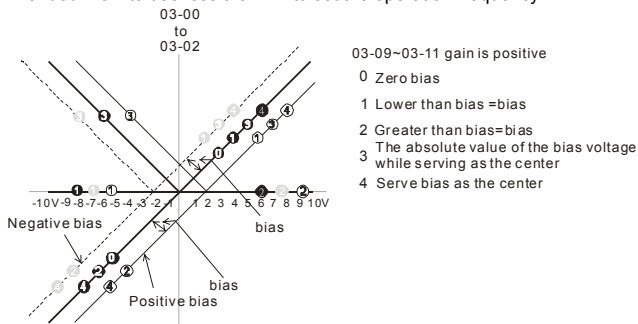

03-09	✓ Analog Input Gain 1 (AVI)	Unit: 1
03-10	✓ Analog Input Gain 1 (ACI)	Unit: 1
03-11	✓ Analog Input Gain 1 (AUI)	Unit: 1

Control mode	VF	VFPG	SVC	FOCPG	TQRPG
Settings			-500.0~500.0%		

 Parameters 03-03 to 03-11 are used when the source of frequency command is the analog voltage/current signal.

03-12	✓ ACI/AVI2 Selection	
--------------	----------------------	--

Control mode	VF	VFPG	SVC	FOCPG	TQRPG
Settings		0	ACI		
		1	AVI 2		

 There are two AVI analog inputs can be used when this parameter is set to 1 and the SW2 on the control board is set to AVI2. At this moment, ACI is for voltage input.

03-13	✓ Analog Input Delay Time (AVI)	Unit: 0.01
--------------	---------------------------------	------------

03-14	⚡ Analog Input Delay Time (ACI)					Unit: 0.01
03-15	⚡ Analog Input Delay Time (AUI)					Unit: 0.01
Control mode	VF	VFPG	SVC	FOCPG	TQRPG	Factory setting: 0.01
Settings	0.00 to 2.00 sec					

📖 These input delays can be used to filter noisy analog signal.

03-16	⚡ Addition Function of the Analog Input					Factory setting: 0
Control mode	VF	VFPG	SVC	FOCPG	TQRPG	
Settings	0 Disable (AVI, ACI, AUI)					
	1 Enable					

📖 When Pr.03-16 is set to 0 and the analog input setting is the same, the priority for AVI, ACI and AUI are AVI>ACI>AUI.

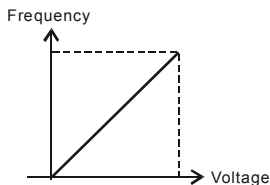

$$F_{\text{command}} = [(ay + \text{bias}) * \text{gain}] * \frac{F_{\text{max}}(01-00)}{10V \text{ or } 16mA}$$

F_{command}: the corresponding frequency for 10V or 20mA

ay : 10 or 16mA

bias : Pr.03-03, Pr. 03-04, Pr.03-05

gain : Pr.03-09, Pr.03-10, Pr.03-11

03-17	⚡ Loss of the ACI Signal					Factory setting: 0
Control mode	VF	VFPG	SVC	FOCPG	TQRPG	
Settings	0 Disable					
	1 Continue operation at the last frequency					
	2 Decelerate to stop					
	3 Stop immediately and display E.F.					

📖 This parameter determines the behavior when ACI is lost.

03-18	⚡ Analog Output Selection 1					Unit: 1
03-21	⚡ Analog Output Selection 2 (need to be used with EMV-APP01)					Unit: 1
03-24	⚡ Analog Output Selection 3 (need to be used with EMV-APP01)					Unit: 1
Control mode	VF	VFPG	SVC	FOCPG	TQRPG	Factory setting: 0

Settings 0 to 19

Settings	Functions	Descriptions
0	Output frequency (Hz)	Max. frequency Pr.01-00 is regarded as 100%.
1	Frequency command (Hz)	Max. frequency Pr.01-00 is regarded as 100%.
2	Motor speed (Hz)	600Hz is regarded as 100%
3	Output current (rms)	2.5 X rated current is regarded as 100%
4	Output voltage	2 X rated voltage is regarded as 100%
5	DC Bus Voltage	450V (900V)=100%
6	Power factor	-1.000~1.000=100%
7	Power	Rated power is regarded as 100%
8	Output torque	Full-load torque is regarded as 100%
9	AVI	0~10V=0~100%
10	ACI	0~20mA=0~100%
11	AUI	-10~10V=0~100%
12	q-axis current	(2.5 X rated current) is regarded as 100%
13	q-axis feedback value	(2.5 X rated current) is regarded as 100%
14	d-axis current	(2.5 X rated current) is regarded as 100%
15	d-axis feedback value	(2.5 X rated current) is regarded as 100%
16	q-axis voltage	250V (500V) =100%
17	d-axis voltage	250V (500V) =100%
18	Torque command	Rated torque is regarded as 100%

Settings	Functions	Descriptions
19	Pulse frequency command	Max. frequency Pr.01-00 is regarded as 100%.

03-19	↗ Analog Output Gain 1	Unit: 0.1
03-22	↗ Analog Output Gain 2 (need to be used with EMV-APP01)	Unit: 0.1
03-25	↗ Analog Output Gain 3 (need to be used with EMV-APP01)	Unit: 0.1
Control mode	VF VFPG SVC FOCPG TQRPG	Factory setting: 100.0
	Settings 0 to 200.0%	

It is used to adjust the analog voltage level that terminal AFM outputs.

This parameter is set the corresponding voltage of the analog output 0.

03-20	↗ Analog Output Value in REV Direction 1	
03-23	↗ Analog Output Value in REV Direction 2	
03-26	↗ Analog Output Value in REV Direction 3	
Control mode	VF VFPG SVC FOCPG TQRPG	Factory setting: 0
Settings	0 Absolute value in REV direction	
	1 Output 0V in REV direction	
	2 Enable output voltage in REV direction	

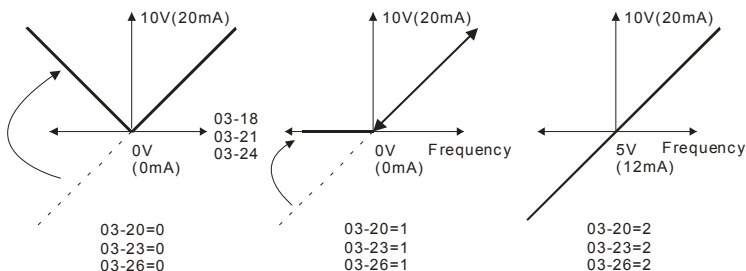

Selections for the analog output direction

Group 4 Multi-Step Speed Parameters

04-00	↗ 1st Step Speed Frequency	Unit: 0.01
04-01	↗ 2nd Step Speed Frequency	Unit: 0.01
04-02	↗ 3rd Step Speed Frequency	Unit: 0.01
04-03	↗ 4th Step Speed Frequency	Unit: 0.01
04-04	↗ 5th Step Speed Frequency	Unit: 0.01
04-05	↗ 6th Step Speed Frequency	Unit: 0.01
04-06	↗ 7th Step Speed Frequency	Unit: 0.01
04-07	↗ 8th Step Speed Frequency	Unit: 0.01
04-08	↗ 9th Step Speed Frequency	Unit: 0.01
04-09	↗ 10th Step Speed Frequency	Unit: 0.01
04-10	↗ 11th Step Speed Frequency	Unit: 0.01
04-11	↗ 12th Step Speed Frequency	Unit: 0.01
04-12	↗ 13th Step Speed Frequency	Unit: 0.01
04-13	↗ 14th Step Speed Frequency	Unit: 0.01
04-14	↗ 15th Step Speed Frequency	Unit: 0.01

Control mode	VF	VFPG	SVC	FOCPG	Factory setting: 0.00
	Settings				0.00 to 600.00 Hz

04-15	↗ Multi-position 1	Unit: 1
04-16	↗ Multi-position 2	Unit: 1
04-17	↗ Multi-position 3	Unit: 1
04-18	↗ Multi-position 4	Unit: 1
04-19	↗ Multi-position 5	Unit: 1
04-20	↗ Multi-position 6	Unit: 1
04-21	↗ Multi-position 7	Unit: 1
04-22	↗ Multi-position 8	Unit: 1
04-23	↗ Multi-position 9	Unit: 1
04-24	↗ Multi-position 10	Unit: 1
04-25	↗ Multi-position 11	Unit: 1
04-26	↗ Multi-position 12	Unit: 1
04-27	↗ Multi-position 13	Unit: 1
04-28	↗ Multi-position 14	Unit: 1
04-29	↗ Multi-position 15	Unit: 1

Control mode	VFPG	FOCPG	Factory setting: 0
---------------------	------	-------	--------------------

 Please refer to the explanation of Pr.02-00 to Pr.02-06.

	MI4	MI3	MI2	MI1	
Pr.10-19 setting	0	0	0	0	Master frequency
04-15 multi-position 1	0	0	0	1	04-00 1 st step speed frequency
04-16 multi-position 2	0	0	1	0	04-01 2 nd step speed frequency
04-17 multi-position 3	0	0	1	1	04-02 3 rd step speed frequency
04-18 multi-position 4	0	1	0	0	04-03 4 th step speed frequency
04-19 multi-position 5	0	1	0	1	04-04 5 th step speed frequency
04-20 multi-position 6	0	1	1	0	04-05 6 th step speed frequency
04-21 multi-position 7	0	1	1	1	04-06 7 th step speed frequency
04-22 multi-position 8	1	0	0	0	04-07 8 th step speed frequency
04-23 multi-position 9	1	0	0	1	04-08 9 th step speed frequency
04-24 multi-position 10	1	0	1	0	04-09 10 th step speed frequency
04-25 multi-position 11	1	0	1	1	04-10 11 th step speed frequency
04-26 multi-position 12	1	1	0	0	04-11 12 th step speed frequency
04-27 multi-position 13	1	1	0	1	04-12 13 th step speed frequency
04-28 multi-position 14	1	1	1	0	04-13 14 th step speed frequency
04-29 multi-position 15	1	1	1	1	04-14 15 th step speed frequency

Group 5 Motor Parameters**05-00** Motor Auto Tuning

Control mode	SVC	FOCPG	TQRPG	Factory setting: 0
	Settings	0	No function	
		1	Rolling test	
		2	Static Test	
		3	Reserved	

 Starting auto tuning by pressing RUN key and it will write the measure value into Pr.05-05 to Pr.05-09 for motor 1 and Pr.05-17 to Pr.05-21 for motor 2.

 The steps to AUTO-Tuning are: (when setting to 1)

1. Make sure that all the parameters are set to factory settings and the motor wiring is correct.
2. Make sure the motor has no-load before executing auto-tuning and the shaft is not connected to any belt or gear motor. It is recommended to set to 2 or 3 if the motor can't separate from the load.
3. Motor 1: fill in Pr.01-02, Pr.01-01, Pr.05-01, Pr.05-02, Pr.05-03 and Pr.05-04 with correct values. Refer to motor capacity to set accel./decel. time.
Motor 2: fill in Pr.01-36, Pr.01-35, Pr.05-13, Pr.05-14, Pr.05-15 and Pr.05-16 with correct values. Refer to motor capacity to set accel./decel. time.
4. When Pr.05-00 is set to 1, the AC motor drive will execute auto-tuning immediately after receiving a "RUN" command. (NOTE: the motor will run!)
5. After executing, please check if there are values filled in Pr.05-05 to Pr.05-09 for motor 1 and Pr.05-17 to Pr.05-21 for motor 2.

 If Pr.05-00 is set to 2, it needs to input Pr.05-05 for motor 1/Pr.05-17 for motor 2.

**NOTE**

1. In torque/vector control mode, it is not recommended to have motors run in parallel.
2. It is not recommended to use torque/vector control mode if motor rated power exceeds the rated power of the AC motor drive.
3. When tuning 2 motors, it needs to set multi-function input terminals or change Pr.05-10 for motor 1/motor 2 selection.
4. The no-load current is usually 20~50% X rated current.
5. The rated speed can't be larger or equal to 120f/p.

05-01 Full-load Current of Motor 1

Control mode	VF	VFPG	SVC	FOCPG	TQRPG	Factory setting: ###
Settings	40 to 100%					

 This value should be set according to the rated frequency of the motor as indicated on the motor nameplate. The factory setting is 90% X rated current.

Example: The rated current for 7.5HP (5.5kW) is 25 and factory setting is 22.5A. The range for setting will be 10~30A. ($25 \times 40\% = 10$ and $25 \times 120\% = 30$)

05-02  Rated Power of Motor 1

Unit: 0.01

Control mode	SVC	FOCPG	TQRPG	Factory setting: ###
Settings	0 to 655.35 kW			

 It is used to set rated power of the motor 1. The factory setting is the power of the drive.

05-03  Rated Speed of Motor 1 (rpm)

Unit: 1

Control mode	VFPG	SVC	FOCPG	TQRPG	Factory setting: 1710 (60Hz, 4 poles) 1410 (50Hz, 4 poles)
Settings	0 to 65535				

 It is used to set the rated speed of the motor and need to set according to the value indicated on the motor nameplate.

05-04 Number of Motor Poles 1

Control mode	VF	VFPG	SVC	FOCPG	TQRPG	Factory setting: 4
Settings	2 to 20					

 It is used to set the number of motor poles (must be an even number).

05-05 No-load Current of Motor 1

Unit: Amp

Control mode	VFPG	SVC	FOCPG	TQRPG	Factory setting: ###
Settings	0 to factory setting of Pr.05-01				

 The factory setting is 40% X rated current.

05-06	Rotor Resistance R1 of Motor 1	Unit: 0.001
05-07	Rr of Motor 1	Unit: 0.001
Control mode	SVC FOC PG TQRPG	Factory setting: #####
	Settings 0~65.535Ω	

05-08	Lm of Motor 1	Unit: 0.1
05-09	Lx of Motor 1	Unit: 0.1
Control mode	SVC FOC PG TQRPG	Factory setting: ##
	Settings 0~6553.5mH	

05-10	Motor 1/Motor 2 Selection	
Control mode	VF VFPG SVC FOC PG TQRPG	Factory setting: 1
	Settings 1 Motor 1	
	2 Motor 2	

 It is used to set the motor that driven by the AC motor drive.

05-11	<input checked="" type="checkbox"/> Frequency for Y-connection/ Δ-connection Switch	Unit: 0.01
Control mode	VF VFPG SVC FOC PG TQRPG	Factory setting: 60.00
	Settings 0.00 to 600.00Hz	

05-12	Y-connection /Δ-connection Switch	
Control mode	VF VFPG SVC FOC PG TQRPG	Factory setting: 0
	Settings 0 Disable	
	1 Enable	

05-30	<input checked="" type="checkbox"/> Delay Time for Y-connection/Δ-connection	Unit: 0.001
Control mode	VF VFPG SVC FOC PG	Factory setting: 0.200
	Settings 0 to 60.000	

 Pr.05-12 is used to enable/disable Y-connection/ Δ-connection Switch.

 When Pr.05-12 is set to 1, the drive will select by Pr.05-11 setting and current motor frequency to switch motor to Y-connection or Δ-connection. AT the same time, it will also affect motor parameters (Pr.05-01 to 05-10/Pr.05-13 to Pr.05-21).

 Pr.05-30 is used to set the switch delay time of Y-connection/Δ-connection.

When output frequency reaches Y-connection/ Δ -connection switch frequency, drive will delay by Pr.05-30 before multi-function output terminals are active.

Y- Δ connection switch: can be used for wide range motor
 Y connection for low speed: higher torque can be used for rigid tapping
 Δ connection for high speed: higher torque can be used for high-speed drilling

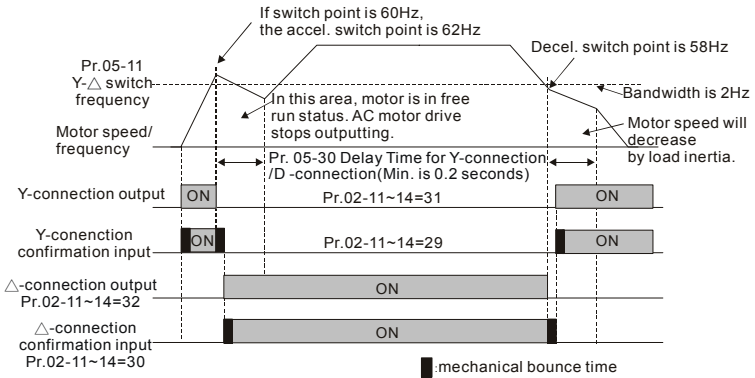
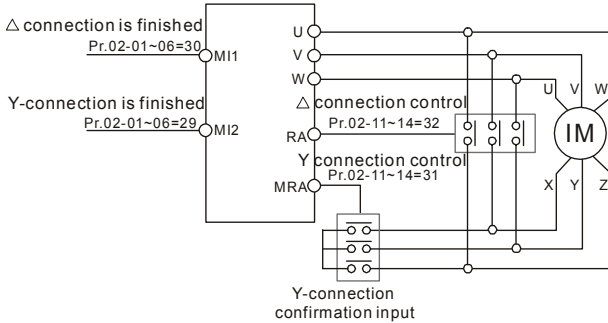

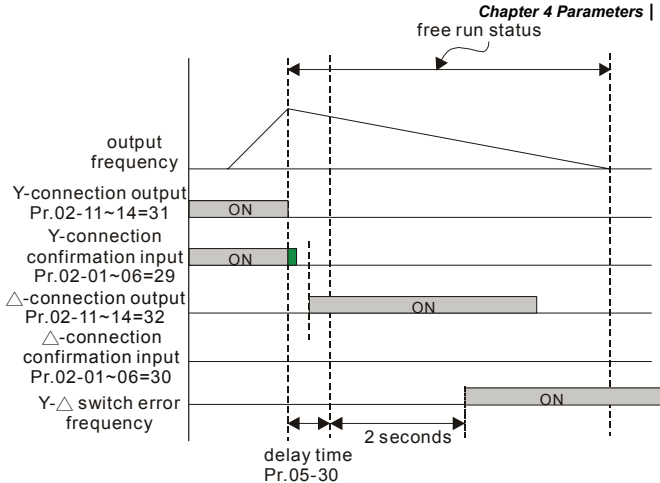
**05-13** Full-load Current of Motor 2

Unit: 1%

Control mode	VF	VFPG	SVC	FOCPG	TQRPG	Factory setting: ###
Settings			40 to 100%			

This value should be set according to the rated frequency of the motor as indicated on the motor nameplate. The factory setting is 90% X rated current.

Example: The rated current for 7.5HP (5.5kW) is 25 and factory setting is 22.5A. The range for setting will be 10~30A. ($25 \times 40\% = 10$ and $25 \times 120\% = 30$)

05-14 Rated Power of Motor 2

Unit: 0.01

Control mode	SVC	FOCPG	TQRPG	Factory setting: ###
Settings		0 to 655.35		

It is used to set rated power of the motor 2. The factory setting is the power of the drive.

05-15 Rated Speed of Motor 2 (rpm)

Unit: 1

Control mode	VFPG	SVC	FOCPG	TQRPG	Factory setting: 1710
Settings		0 to 65535			

It is used to set the rated speed of the motor and need to set according to the value indicated on the motor nameplate.

05-16 Number of Motor Poles 2

Control mode	VF	VFPG	SVC	FOCPG	TQRPG	Factory setting: 4
Settings	2 to 20					

 It is used to set the number of motor poles (must be an even number).

05-17 No-load Current of Motor 2

Unit: Amp

Control mode	VFPG	SVC	FOCPG	TQRPG	Factory setting: ###
Settings	0 to factory setting of Pr.05-01				

 The factory setting is 40% X rated current.

05-18 Rotor Resistance R1 of Motor 2

Unit: 0.001

05-19 Rr of Motor 2

Unit: 0.001

Control mode	SVC	FOCPG	TQRPG	Factory setting: ###
Settings	0~65.535Ω			

05-20 Lm of Motor 2

Unit: 0.1

05-21 Lx of Motor 2

Unit: 0.1

Control mode	SVC	FOCPG	TQRPG	Factory setting: ##
Settings	0~6553.5mH			

 It will have different setting by the rated current.

05-22  Torque Compensation Time Constant

Unit: 0.001

Control mode	VF	VFPG	SVC	Factory setting: 0.020
Settings	0.001 to 10.000 sec			

05-23  Slip Compensation Time Constant

Unit: 0.001

Control mode	VFPG	SVC	Factory setting: 0.100
Settings	0.001 to 10.000 sec		

 Setting Pr.05-22 and Pr.05-23 change the response time for the compensation.

 When Pr.05-22 and Pr.05-23 are set to 10.00 seconds, its response time for the compensation will be the longest. But if the settings are too short, unstable system may occur.

05-24	↗ Torque Compensation Gain	Unit: 1
Control mode	VF VFPG	Factory setting: 0
	Settings 0 to10	

 This parameter may be set so that the AC motor drive will increase its voltage output to obtain a higher torque. Only to be used for SVC control mode.

 Too high torque compensation can overheat the motor.

05-25	↗ Slip Compensation Gain	Unit: 0.01
Control mode	VF SVC	Factory setting: 0.00
	Settings 0.00 to10.00	

 When the asynchronous motor is driven by the drive, the load and slip will be increased. This parameter can be used to correct frequency and lower the slip to make the motor can run near the synchronous speed under rated current. When the output current is larger than the motor no-load current, the drive will compensate the frequency by Pr.05-25 setting. If the actual speed is slower than expectation, please increase the setting and vice versa.

 It is only valid in SVC/VF mode.

 The factory settings are:

A. In SVC mode, the factory setting is 1.00.

B. In VF mode, the factory setting is 0.00.

05-26	↗ Slip Deviation Level	Unit: 1
Control mode	VFPG SVC FOCPG	Factory setting: 0
	Settings 0 to 1000% (0: disable)	

05-27	↗ Detection time of Slip Deviation	Unit: 0.1
Control mode	VFPG SVC FOCPG	Factory setting: 1.0
	Settings 0.0 to 10.0 sec	

05-28	↗ Over Slip Treatment	Factory setting: 0
Control mode	VFPG SVC FOCPG	
	Settings 0 Warn and keep operation	
	1 Warn and ramp to stop	
	2 Warn and coast to stop	

-  Pr.05-26 to Pr.05-28 are used to set allowable slip level/time and over slip treatment when the drive is running.

05-29	Hunting Gain				Unit: 1
Control mode	VF	VFPG	SVC		Factory setting: 2000
	Settings	0 to 10000 (0: disable)			

-  The motor will have current wave motion in some specific area. It can improve this situation by setting this parameter. (When it is high frequency or run with PG, Pr.05-29 can be set to 0. when the current wave motion happens in the low frequency, please increase Pr.05-29.)

05-31	Accumulative Motor Operation Time (Min.)					Unit: 1
Control mode	VF	VFPG	SVC	FOCPG	TQRPG	Factory setting: 00
	Settings	00 to 1439				

05-32	Accumulative Motor Operation Time (Day)					Unit: 1
Control mode	VF	VFPG	SVC	FOCPG	TQRPG	Factory setting: 00
	Settings	00 to 65535				

-  Pr. 05-31 and Pr.05-32 are used to record the motor operation time. They can be cleared by setting to 00 and time won't be recorded when it is less than 60 seconds.

Group 6 Protection Parameters**06-00** ✓ Low Voltage Level

Unit: 0.1

Control mode	VF	VFPG	SVC	FOCPG	TQRPG	
Settings	230V series	160.0~220.0Vdc				Factory Setting: 180.0
	460V series	320.0~440.0Vdc				Factory Setting: 360.0

 It is used to set the Lv level.

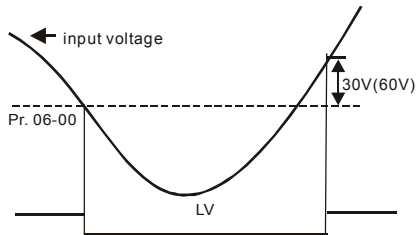
**06-01** ✓ Over-Voltage Stall Prevention

Unit: 0.1

Control mode	VF	VFPG	SVC	FOCPG	TQRPG	
Settings	230V series	350.0~450.0Vdc				Factory Setting: 380.0
	460V series	700.0~900.0Vdc				Factory Setting: 760.0
		0.0: disable (when brake resistor used)				

 During deceleration, the DC bus voltage may exceed its Maximum Allowable Value due to motor regeneration. When this function is enabled, the AC motor drive will not decelerate further and keep the output frequency constant until the voltage drops below the preset value again.

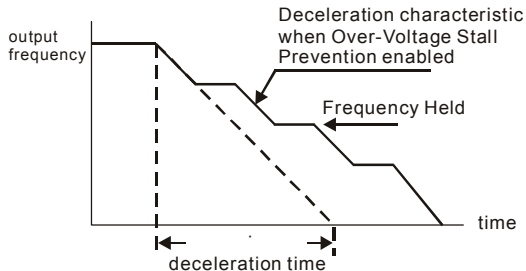

06-02 / Phase-loss Protection

Control mode	VF	VFPG	SVC	FOCPG	TQRPG	Factory Setting: 0
Settings		0	Warn and keep operation			
		1	Warn and ramp to stop			
		2	Warn and coast to stop			

It is used to set the phase-loss treatment. The phase-loss will effect driver's control characteristic and life.

06-03 / Over-Current Stall Prevention during Acceleration

Unit: 1

Control mode	VF	VFPG	SVC	Factory Setting: 170
Settings		00~250%		

During acceleration, the AC drive output current may increase abruptly and exceed the value specified by Pr.06-03 due to rapid acceleration or excessive load on the motor. When this function is enabled, the AC drive will stop accelerating and keep the output frequency constant until the current drops below the maximum value.

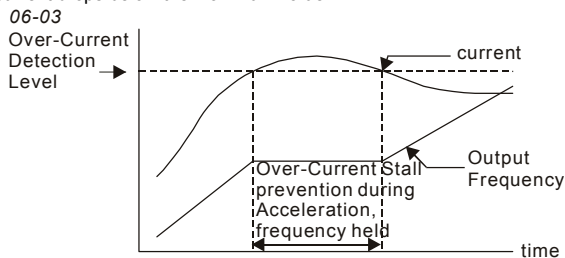

actual acceleration time when over-current stall prevention is enabled

06-04 / Over-current Stall Prevention during Operation

Unit: 1

Control mode	VF	VFPG	SVC	Factory Setting: 170
Settings		00 to 250%		

If the output current exceeds the setting specified in Pr.06-04 when the drive is operating, the drive will decrease its output frequency to prevent the motor stall. If the output current is lower than the setting specified in Pr.06-04, the drive will accelerate again to catch up with the set frequency command value.

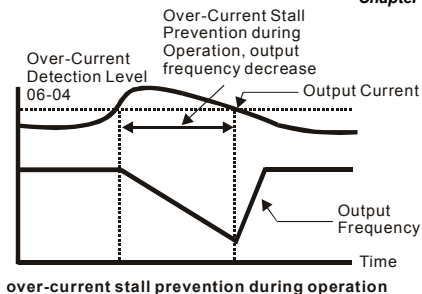
**06-05** / Accel./Decel. Time Selection of Stall Prevention at Constant Speed

Control mode	VF	VFPG	SVC	Factory Setting: 0
Settings		0	by current accel/decel. time	
		1	by the 1 st accel/decel. time	
		2	by the 2 nd accel/decel. time	
		3	by the 3 rd accel/decel. time	
		4	by the 4 th accel/decel. time	
		5	by auto accel/decel. time	

It is used to set the accel./decel. Time selection when stall prevention occurs at constant speed.

06-06 / Over-torque Detection Selection (OT1)

Control mode	VF	VFPG	SVC	FOCPG	TQRPG	Factory Setting: 0
Settings		0	Over-Torque detection disabled.			
		1	Over-torque detection during constant speed operation, continue to operate after detection			
		2	Over-torque detection during constant speed operation, stop operation after detection			
		3	Over-torque detection during operation, continue to operate after detection			
		4	Over-torque detection during operation, stop operation after detection			

06-07 / Over-torque Detection Level (OT1)

Unit: 1

Control mode	VF	VFPG	SVC	FOCPG	TQRPG	Factory Setting: 150
--------------	----	------	-----	-------	-------	----------------------

Settings 10 to 250%

06-08  Over-torque Detection Time (OT1) Unit: 0.1

Control mode	VF	VFPG	SVC	FOCPG	TQRPG	Factory Setting: 0.1
--------------	----	------	-----	-------	-------	----------------------

Settings 0.0 to 60.0 sec

06-09  Over-torque Detection Selection (OT2)

Control mode	VF	VFPG	SVC	FOCPG	TQRPG	Factory Setting: 0
--------------	----	------	-----	-------	-------	--------------------

Settings	0	Over-Torque detection disabled.				
	1	Over-torque detection during constant speed operation, continue to operate after detection				
	2	Over-torque detection during constant speed operation, stop operation after detection				
	3	Over-torque detection during operation, continue to operate after detection				
	4	Over-torque detection during operation, stop operation after detection				

06-10  Over-torque Detection Level (OT2) Unit: 1

Control mode	VF	VFPG	SVC	FOCPG	TQRPG	Factory Setting: 150
--------------	----	------	-----	-------	-------	----------------------

Settings 10 to 250%

06-11  Over-torque Detection Time (OT2) Unit: 0.1

Control mode	VF	VFPG	SVC	FOCPG	TQRPG	Factory Setting: 0.1
--------------	----	------	-----	-------	-------	----------------------

Settings 0.0 to 60.0 sec

 Pr.06-06 and Pr.06-09 determine the operation mode of the drive after the over-torque is detected via the following method: if the output current exceeds the over-torque detection level (Pr.06-19) and also exceeds the Pr.06-08 Over-Torque Detection Time, the fault code "OT1/OT2" is displayed. If a Multi-Functional Output Terminal is to over-torque detection, the output is on. Please refer to Pr.02-11~02-14 for details.

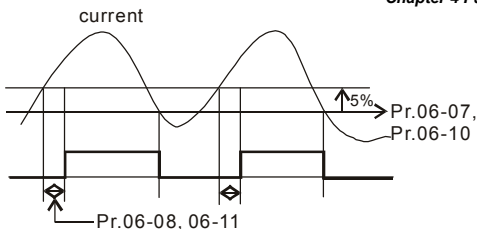

06-12	✓ Current Limit	Unit: 1
Control mode	FOCPG TQRPG	Factory Setting: 150
Settings	0 to 250%	

It is used to set the current limit.

06-13	✓ Electronic Thermal Relay Selection (Motor 1)	Factory Setting: 2
Control mode	VF VFGP SVC FOCPG TQRPG	
Settings	0 Operate with a Inverter Motor (forced external cooling)	
	1 Operate with a Standard Motor (self-cooled by fan)	
	2 Disabled	

06-27	✓ Electronic Thermal Relay Selection (Motor 2)	Factory Setting: 2
Control mode	VF VFGP SVC FOCPG TQRPG	
Settings	0 Operate with a Inverter Motor (forced external cooling)	
	1 Operate with a Standard Motor (self-cooled by fan)	
	2 Disabled	

It is used to prevent self-cooled motor overheats under low speed. User can use electrical thermal relay to limit driver's output power.

06-14	✓ Electronic Thermal Characteristic for Motor 1	Unit: 0.1
Control mode	VF VFGP SVC FOCPG TQRPG	Factory Setting: 60.0
Settings	30.0 to 600.0 sec	

06-28	✓ Electronic Thermal Characteristic for Motor 2	Unit: 0.1
Control mode	VF VFGP SVC FOCPG TQRPG	Factory Setting: 60.0
Settings	30.0 to 600.0 sec	

The parameter is set by the output frequency, current and operation time of the drive for activating the I²t electronic thermal protection function. The function will be activated for the 150% * setting current for the setting of Pr.06-14/Pr.06-28.

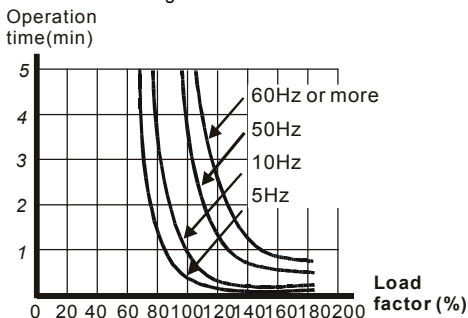

06-15	✓ Heat Sink Over-heat (OH) Warning	Unit: 0.1
Control mode	VF VFPG SVC FOC PG TQR PG	Factory Setting: 85.0
Settings	0.0 to 110.0 °C	

06-16	✓ Stall Prevention Limit Level	Unit: 1
Control mode	VF VFPG SVC	Factory Setting: 50
Settings	0 to 100% (refer to Pr.06-03, Pr.06-04)	



When operation frequency is larger than Pr.01-01, Pr06-03=150%, Pr. 06-04=100% and Pr. 06-28=80%:
 Stall Prevention Level during acceleration = 06-03x06-28=150x80%=120%.
 Stall Prevention Level at constant speed= 06-03x06-28=100x80%=80%.

06-17	Present Fault Record
06-18	Second Most Recent Fault Record
06-19	Third Most Recent Fault Record
06-20	Fourth Recent Fault Record
06-21	Fifth Most Recent Fault Record
06-22	Sixth Most Recent Fault Record
Settings	0 to 65
	Factory Setting: 0

Settings	Control Mode				
	VF	VFPG	SVC	FOCPG	TQRPG

Settings	Control Mode				
	VF	VFPG	SVC	FOCPG	TQRPg
0: No fault	<input type="checkbox"/>	<input type="checkbox"/>	<input type="checkbox"/>	<input type="checkbox"/>	<input type="checkbox"/>
1: Over-current during acceleration (ocA)	<input type="checkbox"/>	<input type="checkbox"/>	<input type="checkbox"/>	<input type="checkbox"/>	<input type="checkbox"/>
2: Over-current during deceleration (ocd)	<input type="checkbox"/>	<input type="checkbox"/>	<input type="checkbox"/>	<input type="checkbox"/>	<input type="checkbox"/>
3: Over-current during constant speed (ocn)	<input type="checkbox"/>	<input type="checkbox"/>	<input type="checkbox"/>	<input type="checkbox"/>	<input type="checkbox"/>
4: Ground fault (GFF)	<input type="checkbox"/>	<input type="checkbox"/>	<input type="checkbox"/>	<input type="checkbox"/>	<input type="checkbox"/>
5: IGBT short-circuit (occ)	<input type="checkbox"/>	<input type="checkbox"/>	<input type="checkbox"/>	<input type="checkbox"/>	<input type="checkbox"/>
6: Over-current at stop (ocS)	<input type="checkbox"/>	<input type="checkbox"/>	<input type="checkbox"/>	<input type="checkbox"/>	<input type="checkbox"/>
7: Over-voltage during acceleration (ovA)	<input type="checkbox"/>	<input type="checkbox"/>	<input type="checkbox"/>	<input type="checkbox"/>	<input type="checkbox"/>
8: Over-voltage during deceleration (ovd)	<input type="checkbox"/>	<input type="checkbox"/>	<input type="checkbox"/>	<input type="checkbox"/>	<input type="checkbox"/>
9: Over-voltage during constant speed (ovn)	<input type="checkbox"/>	<input type="checkbox"/>	<input type="checkbox"/>	<input type="checkbox"/>	<input type="checkbox"/>
10: Over-voltage at stop (ovS)	<input type="checkbox"/>	<input type="checkbox"/>	<input type="checkbox"/>	<input type="checkbox"/>	<input type="checkbox"/>
11: Low-voltage during acceleration (LvA)	<input type="checkbox"/>	<input type="checkbox"/>	<input type="checkbox"/>	<input type="checkbox"/>	<input type="checkbox"/>
12: Low-voltage during deceleration (Lvd)	<input type="checkbox"/>	<input type="checkbox"/>	<input type="checkbox"/>	<input type="checkbox"/>	<input type="checkbox"/>
13: Low-voltage during constant speed (Lvn)	<input type="checkbox"/>	<input type="checkbox"/>	<input type="checkbox"/>	<input type="checkbox"/>	<input type="checkbox"/>
14: Low-voltage at stop (LvS)	<input type="checkbox"/>	<input type="checkbox"/>	<input type="checkbox"/>	<input type="checkbox"/>	<input type="checkbox"/>
15: Phase loss (PHL)	<input type="checkbox"/>	<input type="checkbox"/>	<input type="checkbox"/>	<input type="checkbox"/>	<input type="checkbox"/>
16: IGBT heat sink over-heat (oH1)	<input type="checkbox"/>	<input type="checkbox"/>	<input type="checkbox"/>	<input type="checkbox"/>	<input type="checkbox"/>
17: Heat sink over-heat (oH2)(for 40HP above)	<input type="checkbox"/>	<input type="checkbox"/>	<input type="checkbox"/>	<input type="checkbox"/>	<input type="checkbox"/>
18: TH1 open loop error (tH1o)	<input type="checkbox"/>	<input type="checkbox"/>	<input type="checkbox"/>	<input type="checkbox"/>	<input type="checkbox"/>
19: TH2 open loop error (tH2o)	<input type="checkbox"/>	<input type="checkbox"/>	<input type="checkbox"/>	<input type="checkbox"/>	<input type="checkbox"/>
20: Fan error signal output	<input type="checkbox"/>	<input type="checkbox"/>	<input type="checkbox"/>	<input type="checkbox"/>	<input type="checkbox"/>
21: over-load (oL) (150% 1min)	<input type="checkbox"/>	<input type="checkbox"/>	<input type="checkbox"/>	<input type="checkbox"/>	<input type="checkbox"/>
22: Motor 1 over-load (EoL1)	<input type="checkbox"/>	<input type="checkbox"/>	<input type="checkbox"/>	<input type="checkbox"/>	<input type="checkbox"/>
23: Motor 2 over-load (EoL2)	<input type="checkbox"/>	<input type="checkbox"/>	<input type="checkbox"/>	<input type="checkbox"/>	<input type="checkbox"/>
24: Motor PTC overheat (oH3)	<input type="checkbox"/>	<input type="checkbox"/>	<input type="checkbox"/>	<input type="checkbox"/>	<input type="checkbox"/>
25: Fuse error (FuSE)	<input type="checkbox"/>	<input type="checkbox"/>	<input type="checkbox"/>	<input type="checkbox"/>	<input type="checkbox"/>
26: over-torque 1 (ot1)	<input type="checkbox"/>	<input type="checkbox"/>	<input type="checkbox"/>	<input type="checkbox"/>	<input type="checkbox"/>
27: over-torque 1 (ot2)	<input type="checkbox"/>	<input type="checkbox"/>	<input type="checkbox"/>	<input type="checkbox"/>	<input type="checkbox"/>
28: Reserved					
29: Reserved					
30: Memory write-in error (cF1)	<input type="checkbox"/>	<input type="checkbox"/>	<input type="checkbox"/>	<input type="checkbox"/>	<input type="checkbox"/>
31: Memory read-out error (cF2)	<input type="checkbox"/>	<input type="checkbox"/>	<input type="checkbox"/>	<input type="checkbox"/>	<input type="checkbox"/>
32: Isum current detection error (cd0)	<input type="checkbox"/>	<input type="checkbox"/>	<input type="checkbox"/>	<input type="checkbox"/>	<input type="checkbox"/>
33: U-phase current detection error (cd1)	<input type="checkbox"/>	<input type="checkbox"/>	<input type="checkbox"/>	<input type="checkbox"/>	<input type="checkbox"/>
34: V-phase current detection error (cd2)	<input type="checkbox"/>	<input type="checkbox"/>	<input type="checkbox"/>	<input type="checkbox"/>	<input type="checkbox"/>
35: W-phase current detection error (cd3)	<input type="checkbox"/>	<input type="checkbox"/>	<input type="checkbox"/>	<input type="checkbox"/>	<input type="checkbox"/>
36: Clamp current detection error (Hd0)	<input type="checkbox"/>	<input type="checkbox"/>	<input type="checkbox"/>	<input type="checkbox"/>	<input type="checkbox"/>
37: Over-current detection error (Hd1)	<input type="checkbox"/>	<input type="checkbox"/>	<input type="checkbox"/>	<input type="checkbox"/>	<input type="checkbox"/>
38: Over-voltage detection error (Hd2)	<input type="checkbox"/>	<input type="checkbox"/>	<input type="checkbox"/>	<input type="checkbox"/>	<input type="checkbox"/>
39: Ground current detection error (Hd3)	<input type="checkbox"/>	<input type="checkbox"/>	<input type="checkbox"/>	<input type="checkbox"/>	<input type="checkbox"/>
40: Auto tuning error (AuE)			<input type="checkbox"/>	<input type="checkbox"/>	<input type="checkbox"/>
41: PID feedback loss (AFE)	<input type="checkbox"/>	<input type="checkbox"/>	<input type="checkbox"/>	<input type="checkbox"/>	<input type="checkbox"/>
42: PG feedback error (PGF1)		<input type="checkbox"/>	<input type="checkbox"/>	<input type="checkbox"/>	<input type="checkbox"/>
43: PG feedback loss (PGF2)		<input type="checkbox"/>	<input type="checkbox"/>	<input type="checkbox"/>	<input type="checkbox"/>
44: PG feedback stall (PGF3)		<input type="checkbox"/>	<input type="checkbox"/>	<input type="checkbox"/>	<input type="checkbox"/>
45: PG slip error (PGF4)		<input type="checkbox"/>	<input type="checkbox"/>	<input type="checkbox"/>	<input type="checkbox"/>
46: PG ref input error (PGr1)	<input type="checkbox"/>	<input type="checkbox"/>	<input type="checkbox"/>	<input type="checkbox"/>	<input type="checkbox"/>
47: PG ref loss (PGr2)	<input type="checkbox"/>	<input type="checkbox"/>	<input type="checkbox"/>	<input type="checkbox"/>	<input type="checkbox"/>
48: Analog current input loss (ACE)	<input type="checkbox"/>	<input type="checkbox"/>	<input type="checkbox"/>	<input type="checkbox"/>	<input type="checkbox"/>
49: External fault input (EF)	<input type="checkbox"/>	<input type="checkbox"/>	<input type="checkbox"/>	<input type="checkbox"/>	<input type="checkbox"/>
50: Emergency stop (EF1)	<input type="checkbox"/>	<input type="checkbox"/>	<input type="checkbox"/>	<input type="checkbox"/>	<input type="checkbox"/>
51: External Base Block (B.B.)	<input type="checkbox"/>	<input type="checkbox"/>	<input type="checkbox"/>	<input type="checkbox"/>	<input type="checkbox"/>

Settings	Control Mode				
	VF	VFPG	SVC	FOCPG	TQRPG
52: Password error (PcodE)	<input type="checkbox"/>	<input type="checkbox"/>	<input type="checkbox"/>	<input type="checkbox"/>	<input type="checkbox"/>
53: Reserved					
54: Communication error (cE1)	<input type="checkbox"/>	<input type="checkbox"/>	<input type="checkbox"/>	<input type="checkbox"/>	<input type="checkbox"/>
55: Communication error (cE2)	<input type="checkbox"/>	<input type="checkbox"/>	<input type="checkbox"/>	<input type="checkbox"/>	<input type="checkbox"/>
56: Communication error (cE3)	<input type="checkbox"/>	<input type="checkbox"/>	<input type="checkbox"/>	<input type="checkbox"/>	<input type="checkbox"/>
57: Communication error (cE4)	<input type="checkbox"/>	<input type="checkbox"/>	<input type="checkbox"/>	<input type="checkbox"/>	<input type="checkbox"/>
58: Communication Time-out (cE10)	<input type="checkbox"/>	<input type="checkbox"/>	<input type="checkbox"/>	<input type="checkbox"/>	<input type="checkbox"/>
59: PU time-out (cP10)	<input type="checkbox"/>	<input type="checkbox"/>	<input type="checkbox"/>	<input type="checkbox"/>	<input type="checkbox"/>
60: Brake transistor error (bF)	<input type="checkbox"/>	<input type="checkbox"/>	<input type="checkbox"/>	<input type="checkbox"/>	<input type="checkbox"/>
61: Y-connection/ Δ -connection switch error (ydc)	<input type="checkbox"/>	<input type="checkbox"/>	<input type="checkbox"/>	<input type="checkbox"/>	<input type="checkbox"/>
62: Decel. Energy Backup Error (dEb)	<input type="checkbox"/>	<input type="checkbox"/>	<input type="checkbox"/>	<input type="checkbox"/>	<input type="checkbox"/>
63: Slip error (oS _L)	<input type="checkbox"/>	<input type="checkbox"/>	<input type="checkbox"/>	<input type="checkbox"/>	<input type="checkbox"/>
64: Broken belt error (bEb)	<input type="checkbox"/>	<input type="checkbox"/>	<input type="checkbox"/>	<input type="checkbox"/>	<input type="checkbox"/>
65: Error PID feedback signal of tension (tdEv)	<input type="checkbox"/>	<input type="checkbox"/>	<input type="checkbox"/>	<input type="checkbox"/>	<input type="checkbox"/>

-  It will record when the fault occurs and force stopping. For the Lv, it will record when it is operation, or it will warn without record.
-  Setting 62: when DEB function is enabled, the drive will execute DEB and record to the Pr.06-17 to Pr.06-22 simultaneously.

06-23	↗ Fault Output Option 1	Unit: 1
06-24	↗ Fault Output Option 2	Unit: 1
06-25	↗ Fault Output Option 3	Unit: 1
06-26	↗ Fault Output Option 4	Unit: 1

Control mode	VF	VFPG	SVC	FOCPG	TQRPG	Factory Setting: 0
Settings	0 to 65535 sec (refer to bit table for fault code)					

-  These parameters can be used with multi-function output (set Pr.02-11 to Pr.02-14 to 35-38) for the specific requirement. When the fault occurs, the corresponding terminals will be activated (It needs to convert binary value to decimal value to fill in Pr.06-23 to Pr.06-26).

Fault code	Bit0	Bit1	Bit2	Bit3	Bit4	Bit5	Bit6
	current	Volt.	OL	SYS	FBK	EXI	CE
0: No fault							
1: Over-current during acceleration (ocA)	●						
2: Over-current during deceleration (ocd)	●						
3: Over-current during constant speed (ocn)	●						

Fault code	Bit0	Bit1	Bit2	Bit3	Bit4	Bit5	Bit6
	current	Volt.	OL	SYS	FBK	EXI	CE
4: Ground fault (GFF)						●	
5: IGBT short-circuit (occ)	●						
6: Over-current at stop (ocS)	●						
7: Over-voltage during acceleration (ovA)		●					
8: Over-voltage during deceleration (ovd)		●					
9: Over-voltage during constant speed (ovn)		●					
10: Over-voltage at stop (ovS)		●					
11: Low-voltage during acceleration (LvA)		●					
12: Low-voltage during deceleration (Lvd)		●					
13: Low-voltage during constant speed (Lvn)		●					
14: Low-voltage at stop (LvS)		●					
15: Phase loss (PHL)						●	
16: IGBT heat sink over-heat (oH1)			●				
17: Heat sink over-heat (oH2)(for 40HP above)			●				
18: TH1 open loop error (tH1o)			●				
19: TH2 open loop error (tH2o)			●				
20: Fan error signal output						●	
21: over-load (oL) (150% 1Min)			●				
22: Motor 1 over-load (EoL1)			●				
23: Motor 2 over-load (EoL2)			●				
24: Motor PTC overheat (oH3)			●				
25: Fuse error (FuSE)						●	
26: over-torque 1 (ot1)			●				

Fault code	Bit0	Bit1	Bit2	Bit3	Bit4	Bit5	Bit6
	current	Volt.	OL	SYS	FBK	EXI	CE
27: over-torque 1 (ot2)			●				
28: Reserved							
29: Reserved							
30: Memory write-in error (cF1)				●			
31: Memory read-out error (cF2)				●			
32: Isum current detection error (cd0)				●			
33: U-phase current detection error (cd1)				●			
34: V-phase current detection error (cd2)				●			
35: W-phase current detection error (cd3)				●			
36: Clamp current detection error (Hd0)				●			
37: Over-current detection error (Hd1)				●			
38: Over-voltage detection error (Hd2)				●			
39: Ground current detection error (Hd3)				●			
40: Auto tuning error (AuE)				●			
41: PID feedback loss (AFE)					●		
42: PG feedback error (PGF1)					●		
43: PG feedback loss (PGF2)					●		
44: PG feedback stall (PGF3)					●		
45: PG slip error (PGF4)					●		
46: PG ref input error (PGr1)					●		
47: PG ref loss (PGr2)					●		
48: Analog current input loss (ACE)					●		
49: External fault input (EF)						●	

Fault code	Bit0	Bit1	Bit2	Bit3	Bit4	Bit5	Bit6
	current	Volt.	OL	SYS	FBK	EXI	CE
50: Emergency stop (EF1)						●	
51: External Base Block (B.B.)						●	
52: Password error (PcodE)				●			
53: Reserved							
54: Communication error (cE1)							●
55: Communication error (cE2)							●
56: Communication error (cE3)							●
57: Communication error (cE4)							●
58: Communication Time-out (cE10)							●
59: PU time-out (cP10)							●
60: Brake transistor error (bF)						●	
61: Y-connection/ Δ -connection switch error (ydc)						●	
62: Decel. Energy Backup Error (dEb)		●					
63: Slip error (oSL)						●	
64: Broken belt error (bEb)						●	
65: Error PID feedback signal of tension (tdEv)						●	

06-29 ✓ PTC (Positive Temperature Coefficient) Detection Selection

Control mode	VF	VFPG	SVC	FOCPG	TQRPG	Factory Setting: 0
Settings		0	Warn and keep operating			
		1	Warn and ramp to stop			
		2	Warn and coast to stop			

 It is used to set the treatment after detecting PTC.

06-30 ✓ PTC Level

Unit: 0.1

Control mode	VF	VFPG	SVC	FOCPG	TQRPG	Factory Setting: 50.0
--------------	----	------	-----	-------	-------	-----------------------

Settings	0.0 to 100.0%
----------	---------------

 It is used to set the PTC level, and the corresponding value for 100% is max. analog input value.

06-31	 Filter Time for PTC Detection	Unit: 0.01
--------------	---	------------

Control mode	VF	VFPG	SVC	FOCPG	TQRPG	Factory Setting: 0.20
---------------------	-----------	-------------	------------	--------------	--------------	-----------------------

Settings	0.00 to 10.00 sec
----------	-------------------

06-32	Output Frequency for Malfunction	Unit: 0.01
--------------	----------------------------------	------------

Control mode	VF	VFPG	SVC	FOCPG	TQRPG	Factory Setting: 0.00
---------------------	-----------	-------------	------------	--------------	--------------	-----------------------

Settings	0.00 to 655.35 Hz
----------	-------------------

06-33	Output AC Voltage for Malfunction	Unit: 0.1
--------------	-----------------------------------	-----------

Control mode	VF	VFPG	SVC	FOCPG	TQRPG	Factory Setting: 0.0
---------------------	-----------	-------------	------------	--------------	--------------	----------------------

Settings	0.0~6553.5 V
----------	--------------

06-34	DC Voltage for Malfunction	Unit: 0.1
--------------	----------------------------	-----------

Control mode	VF	VFPG	SVC	FOCPG	TQRPG	Factory Setting: 0.0
---------------------	-----------	-------------	------------	--------------	--------------	----------------------

Settings	0.0~6553.5 V
----------	--------------

06-35	Current Value for Malfunction	Unit: 0.01
--------------	-------------------------------	------------

Control mode	VF	VFPG	SVC	FOCPG	TQRPG	Factory Setting: 0.00
---------------------	-----------	-------------	------------	--------------	--------------	-----------------------

Settings	0.00~655.35 Amp
----------	-----------------

06-36	IGBT Temperature for Malfunction	Unit: 0.1
--------------	----------------------------------	-----------

Control mode	VF	VFPG	SVC	FOCPG	TQRPG	Factory Setting: 0.0
---------------------	-----------	-------------	------------	--------------	--------------	----------------------

Settings	0.0~6553.5 °C
----------	---------------

Group 7 Special Parameters

07-00	✓ Software Brake Level	Unit: 0.1
--------------	------------------------	-----------

Control mode	VF	VFPG	SVC	FOCPG	TQRPG	
Settings	230V series		350.0~450.0Vdc			Factory Setting: 380.0
	460V series		700.0~900.0Vdc			Factory Setting: 760.0

 This parameter sets the DC-bus voltage at which the brake chopper is activated.

07-01	✓ DC Brake Current Level	Unit: 1
--------------	--------------------------	---------

Control mode	VF	VFPG	SVC	FOCPG	TQRPG	Factory Setting: 0
Settings	0 to 100%					

 This parameter sets the level of DC Brake Current output to the motor during start-up and stopping. When setting DC Brake Current, the Rated Current (Pr.00-01) is regarded as 100%. It is recommended to start with a low DC Brake Current Level and then increase until proper holding torque has been attained.

 When it is in FOCPG/TQRPG mode, it can enable DC brake function by setting to any value.

07-02	✓ DC Brake Time during Start-up	Unit: 0.1
--------------	---------------------------------	-----------

Control mode	VF	VFPG	SVC	FOCPG	TQRPG	Factory Setting: 0.0
Settings	0.0 to 60.0 sec					

 This parameter determines the duration of the DC Brake current after a RUN command. When the time has elapsed, the AC motor drive will start accelerating from the Minimum Frequency (Pr.01-05).

07-03	✓ DC Brake Time during Stopping	Unit: 0.01
--------------	---------------------------------	------------

Control mode	VF	VFPG	SVC	FOCPG	TQRPG	Factory Setting: 0.00
Settings	0.00 to 60.00 sec					

 This parameter determines the duration of the DC Brake current during stopping.

07-04	✓ Start-Point for DC Brake	Unit: 0.01
--------------	----------------------------	------------

Control mode	VF	VFPG	SVC	TQRPG	Factory Setting: 0.00
Settings	0.00 to 600.00Hz				

 This parameter determines the frequency when DC Brake will begin during deceleration.

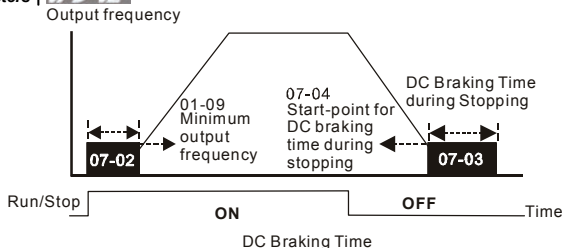

DC Brake during Start-up is used for loads that may move before the AC drive starts, such as fans and pumps. Under such circumstances, DC Brake can be used to hold the load in position before setting it in motion.

DC Brake during stopping is used to shorten the stopping time and also to hold a stopped load in position. For high inertia loads, a dynamic brake resistor may also be needed for fast decelerations.

07-05 DC Brake Proportional Gain

Unit: 1

Control mode	VF	VFPG	SVC	Factory Setting: 50
Settings		1 to 500Hz		

It is used to set the output voltage gain when DC brake.

07-06 Momentary Power Loss Operation Selection

Factory Setting: 0

Control mode	VF	VFPG	SVC	FOCPG	TQRPG	Factory Setting: 0
Settings		0	Operation stops after momentary power loss.			
		1	Operation continues after momentary power loss, speed search starts with the Master Frequency reference value.			
		2	Operation continues after momentary power loss, speed search starts with the minimum frequency.			

This parameter determines the operation mode when the AC motor drive restarts from a momentary power loss.

In PG control mode, the AC motor drive will execute the speed search function automatically by the PG speed when this setting isn't set to 0.

07-07 Maximum Allowable Power Loss Time

Unit: 0.1

Control mode	VF	VFPG	SVC	FOCPG	TQRPG	Factory Setting: 2.0

Settings 0.1 to 5.0 sec

- ☞ If the duration of a power loss is less than this parameter setting, the AC motor drive will resume operation. If it exceeds the Maximum Allowable Power Loss Time, the AC motor drive output is then turned off (coast stop).
- ☞ The selected operation after power loss in Pr.07-06 is only executed when the maximum allowable power loss time is ≤ 5 seconds and the AC motor drive displays "Lu".
- But if the AC motor drive is powered off due to overload, even if the maximum allowable power loss time is ≤ 5 seconds, the operation mode as set in Pr.07-06 is not executed. In that case it starts up normally.

07-08 Baseblock Time for Speed Search (BB)

Unit: 0.1

Control mode

VF VFPG SVC FOCPG TQRPG

Factory Setting: 0.5

Settings 0.1 to 5.0 sec

- ☞ When momentary power loss is detected, the AC drive will block its output and then wait for a specified period of time (determined by Pr.07-08, called Base-Block Time) before resuming operation. This parameter should be set at a value to ensure that any residual regeneration voltage from the motor on the output has disappeared before the drive is activated again.

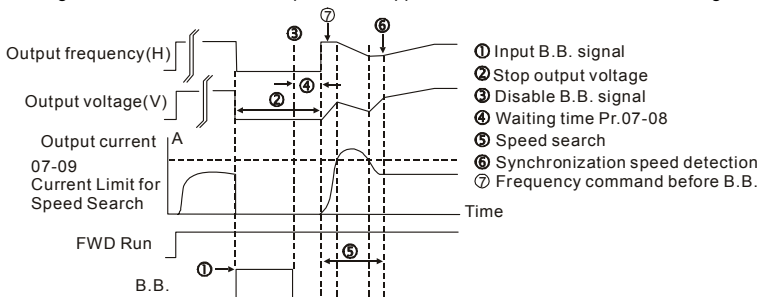

B.B. Search with last output frequency downward timing chart

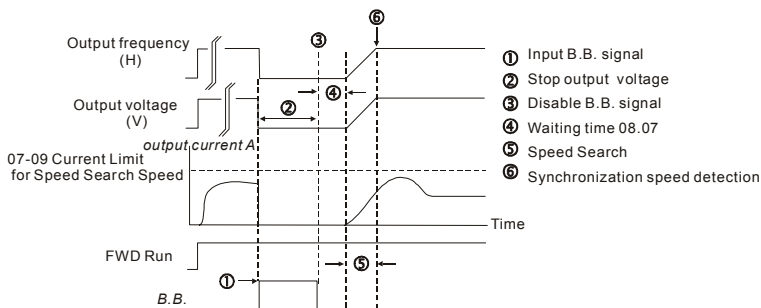

B.B. Search with minimum output frequency upward timing chart

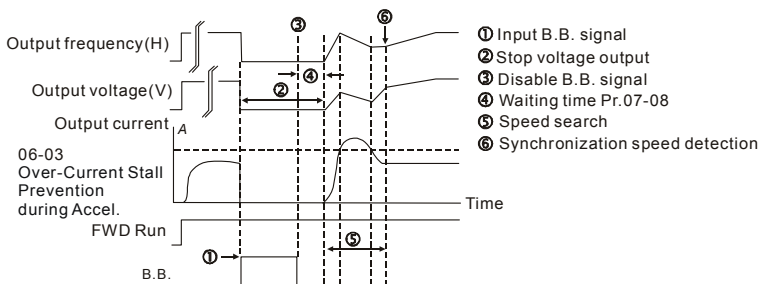

B.B. Search with minimum output frequency upward timing chart

07-09 Current Limit for Speed Search

Unit: 1

Control mode	VF	VFPG	SVC	FOCPG	TQRPG	Factory Setting: 150
Settings			20 to 200%			

Following a momentary power loss, the AC motor drive will start its speed search operation only if the output current is greater than the value set by Pr.8-07. When the output current is less than the value of Pr.8-07, the AC motor drive output frequency is at "speed synchronization point". The drive will start to accelerate or decelerate back to the operating frequency at which it was running prior to the power loss.

When executing speed search, the V/f curve is operated by group 1 setting. The maximum current for the optimum accel./decel. and start speed search is set by Pr.07-09.

07-10 ✓ Base Block Speed Search

Control mode	VF	VFPG	SVC	FOCPG	TQRPG	Factory Setting: 0
Settings		0			Stop operation	
		1			Speed search starts with last frequency command	
		2			Speed search starts with minimum output frequency	

 This parameter determines the AC motor drive restart method after External Base Block is enabled.

 In PG control mode, the AC motor drive will execute the speed search function automatically by the PG speed when this setting isn't set to 0.

07-11 ✓ Auto Restart After Fault

Unit: 1

Control mode	VF	VFPG	SVC	FOCPG	TQRPG	Factory Setting: 0
Settings		0 to 10				

 Only after an over-current OC or over-voltage OV fault occurs, the AC motor drive can be reset/restarted automatically up to 10 times.

 Setting this parameter to 0 will disable the reset/restart operation after any fault has occurred. When enabled, the AC motor drive will restart with speed search, which starts at the frequency before the fault. To set the waiting time before restart after a fault, please set Pr. 07-08 Base Block Time for Speed Search.

07-12 ✓ Speed Search during Start-up

Control mode	VF	VFPG	SVC	FOCPG	TQRPG	Factory Setting: 0
Settings		0			Disable	
		1			Speed search from maximum frequency	
		2			Speed search from start-up frequency	
		3			Speed search from minimum frequency	

 This parameter is used for starting and stopping a motor with high inertia. A motor with high inertia will take a long time to stop completely. By setting this parameter, the user does not need to wait for the motor to come to a complete stop before restarting the AC motor drive. If a PG card and encoder is used on the drive and motor, then the speed search will start from the speed that is detected by the encoder and accelerate quickly to the commanded frequency. The output current is set by the Pr.07-09.

-  In PG control mode, the AC motor drive will execute the speed search function automatically by the PG speed when this setting isn't set to 0.

07-13  Decel. Time Selection for Momentary Power Loss (DEB function)



Control mode	VF	VFPG	SVC	FOCPG	TQRPG	Factory Setting: 0
Settings		0	Disable			
		1	1st decel. time			
		2	2nd decel. time			
		3	3rd decel. time			
		4	4th decel. time			
		5	Current decel. time			
		6	Auto decel. time			

-  This parameter is used for the decel. time selection for momentary power loss.

07-14  DEB Return Time

Unit: 0.1

Control mode	VF	VFPG	SVC	FOCPG	Factory Setting: 0.0
Settings		0.0 to 25.0 sec			

-  The DEB (Deceleration Energy Backup) function is the AC motor drive decelerates to stop after momentary power loss. When the momentary power loss occurs, this function can be used for the motor to decelerate to 0 speed with deceleration stop method. When the power is on again, motor will run again after DEB return time.
-  Status 1: Insufficient power supply due to momentary power-loss/unstable power (due to low voltage)/sudden heavy-load

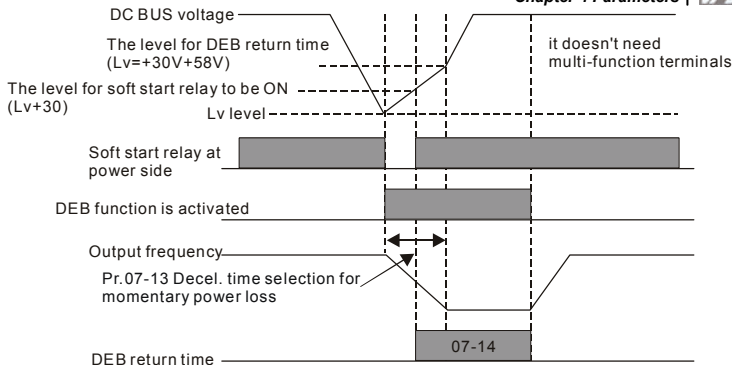

NOTE

When Pr.07-14 is set to 0, the AC motor drive will be stopped and won't re-start at the power-on again.

Status 2: unexpected power off, such as momentary power loss

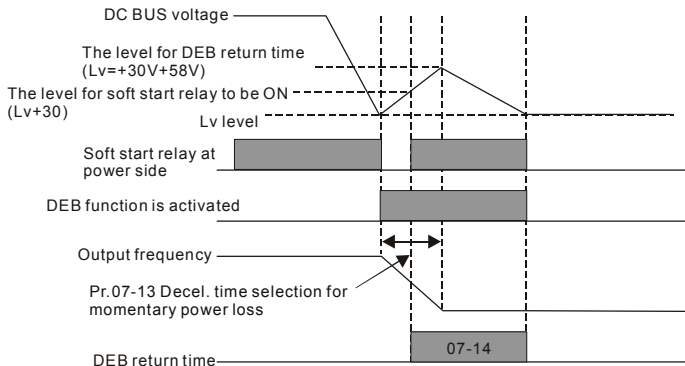

NOTE

For example, in textile machinery, you will hope that all the machines can be decelerated to stop to prevent broken stitching when power loss. In this case, the host controller will send a message to the AC motor drive to use DEB function with deceleration time via EF.

07-15	↗ Dwell Time at Accel.				Unit: 0.01
Control mode	VF	VFPG	SVC	FOCPG	Factory Setting: 0.00
Settings	0.00 to 600.00 sec				
07-16	↗ Dwell Frequency at Accel.				Unit: 0.01
Control mode	VF	VFPG	SVC	FOCPG	Factory Setting: 0.00
Settings	0.00 to 600.00 Hz				
07-17	↗ Dwell Time at Decel.				Unit: 0.01
Control mode	VF	VFPG	SVC	FOCPG	Factory Setting: 0.00
Settings	0.00 to 600.00 sec				
07-18	↗ Dwell Frequency at Decel.				Unit: 0.01
Control mode	VF	VFPG	SVC	FOCPG	Factory Setting: 0.00
Settings	0.00 to 600.00 Hz				

In the heavy load situation, Dwell can make stable output frequency temporarily.

Pr.07-15 to Pr.07-18 is for heavy load to prevent OV or OC occurs.

Frequency

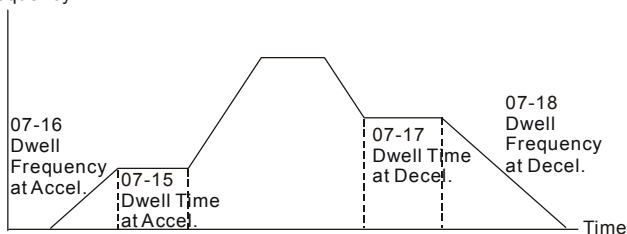

Dwell at accel./decel.

07-19	↗ Fan Control					Factory Setting: 0
Control mode	VF	VFPG	SVC	FOCPG	TQRPG	
Settings	0	Fan always ON				
	1	1 minute after AC motor drive stops, fan will be OFF				
	2	AC motor drive runs and fan ON, AC motor drive stops and fan OFF				
	3	Fan ON to run when preliminary heat sink temperature attained				
	4	Fan always OFF				

This parameter is used for the fan control.

07-20 / Torque Command Unit: 0.1

Control mode **TQRPG** Factory Setting: 0.0

Settings -100.0 to 100.0%
(Pr. 07-22 setting=100%)

 This parameter is torque command. When Pr.07-22 is 250% and Pr.07-20 is 100%, the actual torque command = 250%X100% X motor rated torque.

07-21 / Torque Command Source

Control mode **TQRPG** Factory Setting: 0

Settings 0 Digital keypad

 1 RS485 serial communication (RJ-11)

 2 Analog signal (Pr.03-00)

 This parameter is torque command source and the torque command is in Pr.07-20.

07-22 / Maximum Torque Command Unit: 1

Control mode **TQRPG** Factory Setting: 100

Settings 0 to 500%

 This parameter is for the max. torque command (motor rated torque is 100%).

07-23 / Filter Time of Torque Command Unit: 0.001

Control mode **TQRPG** Factory Setting: 0.000

Settings 0.000 to 1.000 sec

 When the setting is too long, the control will be stable but the control response will be delay.
When the setting is too short, the response will be quickly but the control maybe unstable.
User can adjust the setting by the control and response situation.

07-24 Speed Limit Selection

Control mode **TQRPG** Factory Setting: 0

Settings 0 By Pr.07-25 and Pr.07-26

 1 Frequency command source (Pr.00-20)



07-26 07-25
Pr.07-24=0
Running/opposite running direction are limited by Pr.07-25 and Pr.07-26.

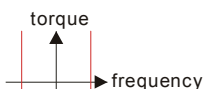

07-26 00-20
07-24=1
When it is forward running, running direction is limited by Pr.00-20 opposite running direction is limited by Pr.07-26.

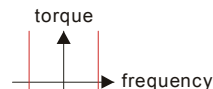

00-20 07-25
07-24=1
When it is reverse running, running direction is limited by Pr.07-25 opposite running direction is limited by Pr.00-20.

07-25	↗ Torque Mode +Speed Limit	Unit: 1
07-26	↗ Torque Mode-Speed Limit	Unit: 1
Control mode	TQRPG	Factory Setting: 10
Settings	0 to 120%	

These parameters are used in the torque mode to limit the running direction and opposite direction. (Pr.01-00 max. output frequency=100%)

07-27	↗ Source of Torque Offset			Factory Setting: 0
Control mode	SVC	FOCPG	TQRPG	
Settings	0	Disable		
	1	Analog input (Pr.03-00)		
	2	Torque offset setting		
	3	Control by external terminal (by Pr.07-29 to Pr.07-31)		

This parameter is the source of torque offset.

When it is set to 3, the source of torque offset will decide to Pr.07-29, Pr.07-30 and Pr.07-31 by the multi-function input terminals setting (31, 32 or 33).

02-01~02-06 is set to 31	02-01~02-06 is set to 32	02-01~02-06 is set to 33	Torque offset
OFF	OFF	OFF	None
OFF	OFF	ON	07-33
OFF	ON	OFF	07-32
OFF	ON	ON	07-33+07-32
ON	OFF	OFF	07-31
ON	OFF	ON	07-31+07-33
ON	ON	OFF	07-31+07-32
ON	ON	ON	07-31+07-32+07-33

07-28	✕ Torque Offset Setting	Unit: 0.1
Control mode	SVC FOC PG TQR PG	Factory Setting: 0.0
	Settings 0.0 to 100.0%	

 This parameter is torque offset. The motor rated torque is 100%.

07-29	✕ High Torque Offset	Unit: 0.1
Control mode	SVC FOC PG TQR PG	Factory Setting: 30.0
	Settings 0.0 to 100.0%	

07-30	✕ Middle Torque Offset	Unit: 0.1
Control mode	SVC FOC PG TQR PG	Factory Setting: 20.0
	Settings 0.0 to 100.0%	

07-31	✕ Low Torque Offset	Unit: 0.1
Control mode	SVC FOC PG TQR PG	Factory Setting: 10.0
	Settings 0.0 to 100.0%	

 When it is set to 3, the source of torque offset will decide to Pr.07-29, Pr.07-30 and Pr.07-31 by the multi-function input terminals setting (31, 32 or 33). The motor rated torque is 100%.

07-32	✕ Forward Motor Torque Limit	Unit: 1
07-33	✕ Forward Regenerative Torque Limit	Unit: 1
07-34	✕ Reverse Motor Torque Limit	Unit: 1
07-35	✕ Reverse Regenerative Torque Limit	Unit: 1
Control mode	FOCPG TQRPG	Factory Setting: 200
	Settings 0 to 500%	

 The motor rated torque is 100%. The settings for Pr.07-32 to Pr.07-35 will compare with Pr.03-00=7, 8, 9, 10. The minimum of the comparison result will be torque limit as shown in the following figure.

 According to the formula of motor rated torque: $T(N.M) = \frac{P(\omega)}{W(rad/s)}$, where $P(\omega)$ is Pr.05-

$$02 \text{ and } W(rad/s) \text{ is Pr.05-03. } \frac{RPM}{60 \times 2\pi} = rad/s$$

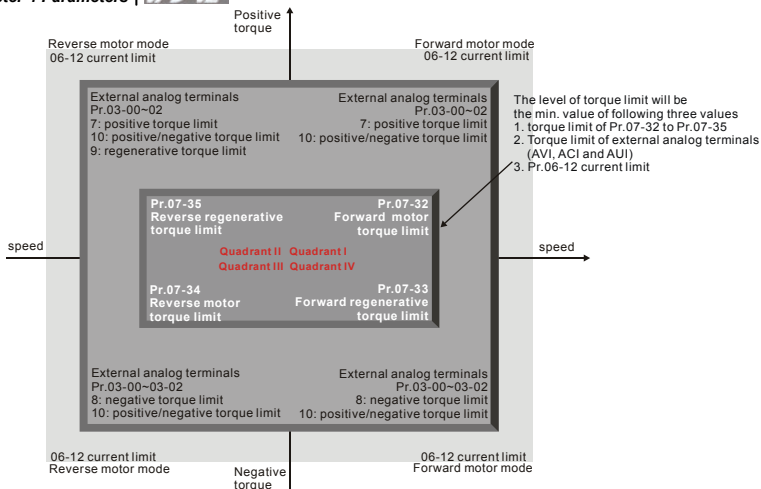

07-36 Emergency Stop (EF) & Forced Stop Selection

Control mode	VF	VFPG	SVC	FOCPG	TQRPG	Factory Setting: 0
Settings			0 Coast stop			
			1 By deceleration Time 1			
			2 By deceleration Time 2			
			3 By deceleration Time 3			
			4 By deceleration Time 4			
			5 System Deceleration			
			6 Automatic Deceleration			

When the multi-function input terminal is set to 10 or 18 and it is ON, the AC motor drive will be operated by Pr.07-36.

Group 8 High-function PID Parameters**08-00**  Input Terminal for PID Feedback

Control mode	VF	VFPG	SVC	FOCPG	Factory Setting: 0
Settings			0	No function	
			1	Negative PID feedback from external terminal AVI (Pr.03-00)	
			2	Negative PID feedback from PG card (Pr.10-15, skip direction)	
			3	Negative PID feedback from PG card (Pr.10-15)	
			4	Positive PID feedback from external terminal AVI (Pr.03-00)	
			5	Positive PID feedback from PG card (Pr.10-15, skip direction)	
			6	Positive PID feedback from PG card (Pr.10-15)	

 Negative feedback means: +target value – feedback. It is used for the detection value will be increased by increasing the output frequency.

 Positive feedback means: -target value + feedback. It is used for the detection value will be decreased by increasing the output frequency.

08-01  Proportional Gain (P)

Unit: 0.1

Control mode	VF	VFPG	SVC	FOCPG	Factory Setting: 80.0
Settings			0.0 to 500.0%		

 This parameter determinates the gain of the feedback loop. If the gain is large, the response will be strong and immediate (if the gain is too large, vibration may occur). If the gain is small, the response will weak and slow.

08-02  Integral Gain (I)

Unit: 0.01

Control mode	VF	VFPG	SVC	FOCPG	Factory Setting: 1.00
Settings			0.00 to 100.00 sec		

 This parameter determines the speed of response for the PID feedback loop. If the integral time is long, the response will be slow. If the integral time is short, the response will be quick. Be careful not to set(I) too small, since a rapid response may cause oscillation in the PID loop.

 If the integral time is set as 0.00, Pr.08-02 will be disabled.

08-03	↗ Derivative Control (D)				Unit: 0.01
Control mode	VF	VFPG	SVC	FOCPG	Factory Setting: 0.00
Settings	0.00 to 1.00 sec				

 This parameter determines the damping effect for the PID feedback loop. If the differential time is long, any oscillation will quickly subside. If the differential time is short, the oscillation will subside slowly.

08-04	↗ Upper limit for Integral Control				Unit: 0.1
Control mode	VF	VFPG	SVC	FOCPG	Factory Setting: 100.0
Settings	0.0 to 100.0%				

 This parameter defines an upper bound or limit for the integral gain (I) and therefore limits the Master Frequency.

The formula is: Integral upper bound = Maximum Output Frequency (Pr.01-00) x (Pr.08-04).

08-05	↗ PID Output Frequency Limit				Unit: 0.1
Control mode	VF	VFPG	SVC	FOCPG	Factory Setting: 100.0
Settings	0.0 to 110.0%				

 This parameter defines the percentage of output frequency limit during the PID control. The formula is Output Frequency Limit = Maximum Output Frequency (Pr.01-00) X Pr.08-05 %.

This parameter will limit the Maximum Output Frequency.

08-06	↗ PID Offset				Unit: 0.1
Control mode	VF	VFPG	SVC	FOCPG	Factory Setting: 0.0
Settings	-100.0 to 100.0%				

08-07	↗ PID Delay Time				Unit: 0.1
Control mode	VF	VFPG	SVC	FOCPG	Factory Setting: 0.0
Settings	0.0 to 2.5 sec				

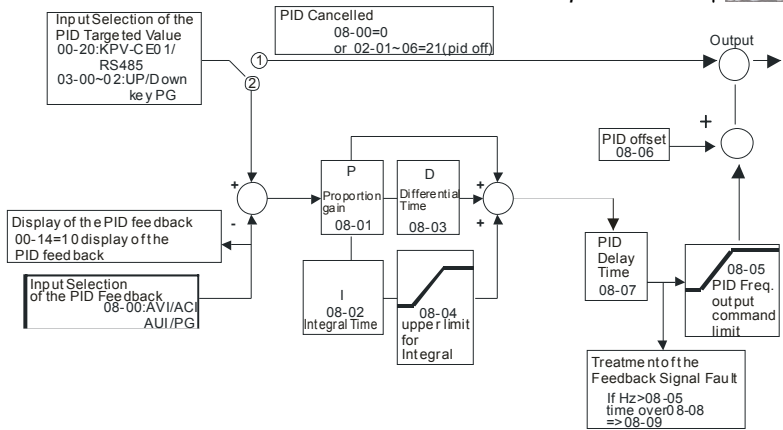

- PI Control:** controlled by the P action only, and thus, the deviation cannot be eliminated entirely. To eliminate residual deviations, the P + I control will generally be utilized. And when the PI control is utilized, it could eliminate the deviation incurred by the targeted value changes and the constant external interferences. However, if the I action is excessively powerful, it will delay the responding toward the swift variation. The P action could be used solely on the loading system that possesses the integral components.
- PD Control:** when deviation occurred, the system will immediately generate some operation load that is greater than the load generated single handedly by the D action to restrain the increment of the deviation. If the deviation is small, the effectiveness of the P action will be decreasing as well. The control objects include occasions with integral component loads, which are controlled by the P action only, and sometimes, if the integral component is functioning, the whole system will be vibrating. On such occasions, in order to make the P action's vibration subsiding and the system stabilizing, the PD control could be utilized. In other words, this control is good for use with loadings with no brake functions over the processes.
- PID Control:** Utilize the I action to eliminate the deviation and the D action to restrain the vibration, thereafter, combine with the P action to construct the PID control. Use of the PID method could obtain a control process with no deviations, high accuracies and a stable system.

Control mode	VF	VFPG	SVC	FOCPG	Factory Setting: 0.0
Settings			0.0 to 3600.0 sec		

 This parameter defines the time during which the PID feedback must be abnormal before a warning is given. It also can be modified according to the system feedback signal time.

 If this parameter is set to 0.0, the system would not detect any abnormality signal.

08-09 Feedback Fault Treatment

Control mode	VF	VFPG	SVC	FOCPG	Factory Setting: 0
Settings			0	Warn and keep operating	
			1	Warn and RAMP to stop	
			2	Warn and COAST to stop	
			3	Warn and keep at last frequency	

 AC motor drive acts when the feedback signals (analog PID feedback or PG (encoder) feedback) are abnormal.

08-10 Sleep Frequency

Unit: 0.01

Control mode	VF	VFPG	SVC	FOCPG	Factory Setting: 0.00
Settings			0.00 to 600.00Hz		

08-11 Wake-up Frequency

Unit: 0.01

Control mode	VF	VFPG	SVC	FOCPG	Factory Setting: 0.00
Settings			0.00 to 600.00Hz		

08-12 Sleep Time

Unit: 0.1

Control mode	VF	VFPG	SVC	FOCPG	Factory Setting: 0.0
Settings			0.0 to 6000.0sec		

 These parameters determine sleep functions of the AC drive. If the command frequency falls below the sleep frequency, for the specified time in Pr. 08-12, then the drive will shut off the output and wait until the command frequency rises above Pr. 08-11. Please see the below diagram.

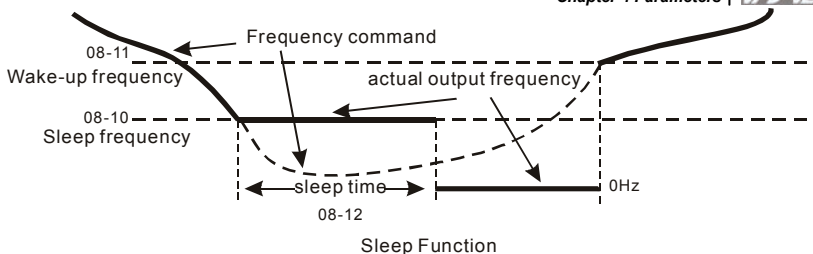

08-13	/ PID Deviation Level				Unit: 0.1
Control mode	VF	VFPG	SVC	FOCPG	Factory Setting: 10.0
Settings	1.0 to 50.0%				

08-14	/ PID Deviation Time				Unit: 0.1
Control mode	VF	VFPG	SVC	FOCPG	Factory Setting: 5.0
Settings	0.1 to 300.0 sec				

08-15	/ Filter Time for PID Feedback				Unit: 0.1
Control mode	VF	VFPG	SVC	FOCPG	Factory Setting: 5.0
Settings	0.1 to 300.0 sec				

08-16	Reserved
08-17	Reserved
08-18	Reserved
08-19	Reserved
08-20	Reserved

08-21	Tension Control Selection	Unit: 0.1
Settings	0 to 4	Factory Setting: 0

Settings	Control Mode				
	VF	VFPG	SVC	FOCPG	TQRPG
0: Disable					
1: Closed-loop, speed mode	○	○	○	○	
2: Line speed, speed mode	○	○	○	○	
3: Reserved					
4: Open-loop, torque mode					○

Closed-loop, speed mode

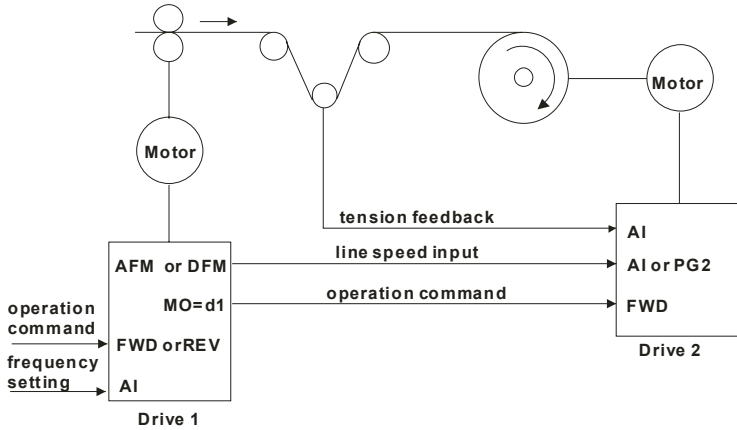
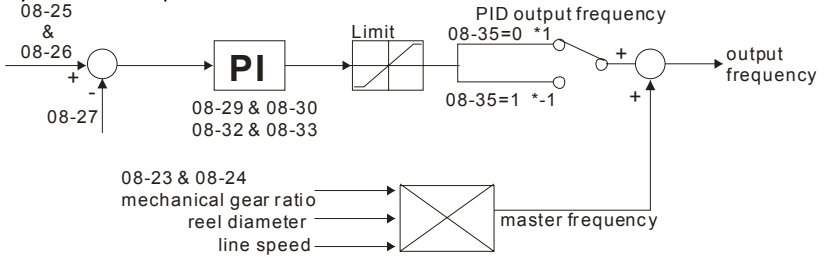

Line speed, speed mode

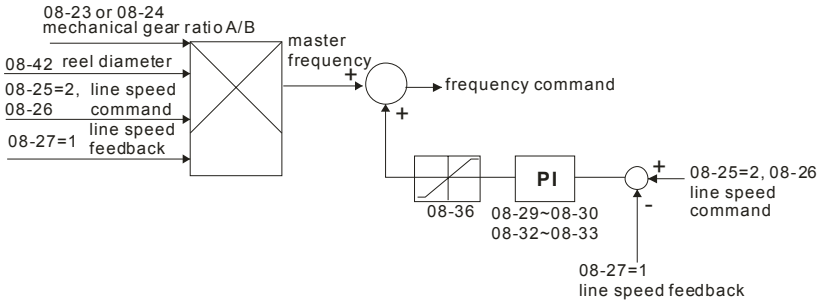

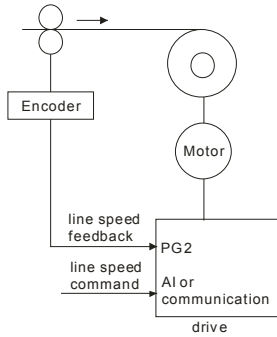

Open-loop, torque mode

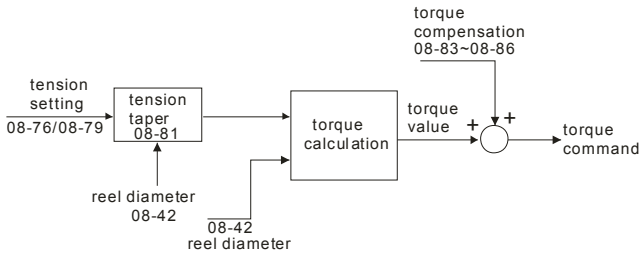
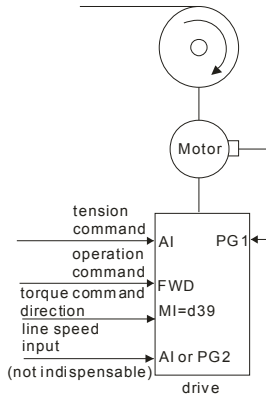

08-22 Wind Mode

Control mode	VF	VFPG	SVC	FOCPG	TQRPG	Factory Setting: 0
Settings		0	Rewind			
		1	Unwind			

08-23 ↗ Mechanical Gear Ratio A

Unit: 1

08-24 ↗ Mechanical Gear Ratio B

Unit: 1

Control mode	VF	VFPG	SVC	FOCPG	TQRPG	Factory Setting: 100
Settings			1 to 65535			

Application without Encoder

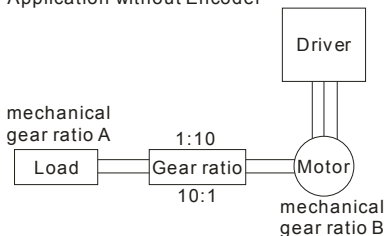
**08-25** Source of the Tension Command/Line Speed

Control mode	VF	VFPG	SVC	FOCPG	TQRPG	Factory Setting: 0
Settings		0	Parameter setting (Pr.08-26)			
		1	RS-485 communication setting (Pr.08-26)			
		2	Analog input (Pr. 03-00~03-02 is set to 14 PID target value of tension, 03-00~03-02 is set to 12 line speed)			

08-26 ↗ PID Target Value of Tension/Line Speed

Unit: 0.1

Control mode	VF	VFPG	SVC	FOCPG	TQRPG	Factory Setting: 50.0
Settings			0.0 to 100.0%			

- The setting range is from 0.0 to 100.0%. In tension mode, when Pr.08-21 is set to 1 (Closed-loop, speed mode), the corresponding value for 100% of dancer is 10V.
- In tension mode, when Pr.08-21 is set to 2 (Line speed, speed mode), the corresponding value for 100% of line speed is max. line speed (Pr.08-38).

08-27 Source of Tension/Line Speed PID Feedback

Factory Setting: 0

Control mode	VF	VFPG	SVC	FOCPG	TQRPG
Settings		0		Analog input (Pr. 03-00~03-02 is set to 11 PID feedback of tension)	
		1		Pulse input (Pr.08-40)	

08-28 Auto-tuning Tension PID

Factory Setting: 0

Control mode	VF	VFPG	SVC	FOCPG	TQRPG
Settings		0		Disable	
		1		Reel diameter (08-29~08-31 corresponds to 08-44, 08-32~08-34 corresponds to 08-43)	
		2		Frequency (08-29~08-31 corresponds to 01-07, 08-32~08-34 corresponds to 01-00)	

 When Pr.08-28 is set to 1:

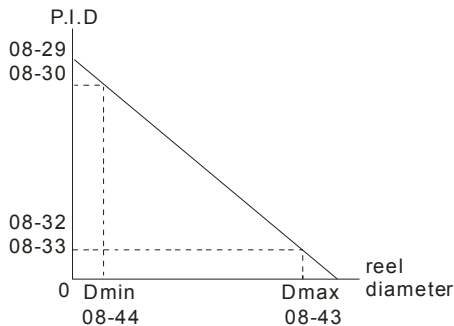

 When Pr.08-28 is set to 2:

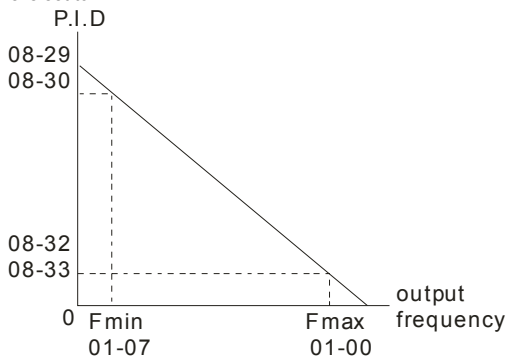
**08-29**  Tension PID P1

Unit: 0.1

Control mode	VF	VFPG	SVC	FOCPG	TQRPG	Factory Setting: 50.0
Settings			0.0 to 1000.0			

08-30	Tension PID I1					Unit: 0.01
Control mode	VF	VFPG	SVC	FOCPG	TQRPG	Factory Setting: 1.00
Settings			0.00 to 500.00 sec			

08-31	Reserved					
-------	----------	--	--	--	--	--

08-32	Tension PID P2					Unit: 0.1
Control mode	VF	VFPG	SVC	FOCPG	TQRPG	Factory Setting: 50.0
Settings			0.0 to 1000.0			

08-33	Tension PID I2					Unit: 0.01
Control mode	VF	VFPG	SVC	FOCPG	TQRPG	Factory Setting: 1.00
Settings			0.00 to 500.00 sec			





08-34	Reserved					
-------	----------	--	--	--	--	--

08-35	PID Output Status					
Control mode	VF	VFPG	SVC	FOCPG	TQRPG	Factory Setting: 0
Settings			0	Positive output		
			1	Negative output		

08-36	Tension/Line Speed PID Output Limit					Unit: 0.01
Control mode	VF	VFPG	SVC	FOCPG	TQRPG	Factory Setting: 20.00
Settings			0 to 100.00% (according to Pr.01-00)			

08-37	Source of Line Speed Input Command					
Control mode	VF	VFPG	SVC	FOCPG	TQRPG	Factory Setting: 0
Settings			0	Disable		
			1	Analog input (Pr. 03-00~03-02 is set to 12 line speed)		
			2	RS-485 communication setting (Pr.08-41)		

- 3 Pulse input (Pr.08-40)
- 4 DFM-DCM pulse input (Pr.02-18)

-  When it is set to 1, 3 or 4, the current line speed will be saved into Pr.08-41 via analog and pulse command. When it is set to 2, it can change the setting of Pr.08-41 (current line speed) via communication.
-  When it is set to 3 or 4, pulse signal needs to be connected to PG2 of the PG card and then set the PG type by Pr.10-15.
-  When it is set to 3, it needs to use with Pr.08-40.
-  When it is set to 4, Pr.02-18 setting needs to be set to the DFM output value of previous driver as shown in the following before setting Pr.08-38.

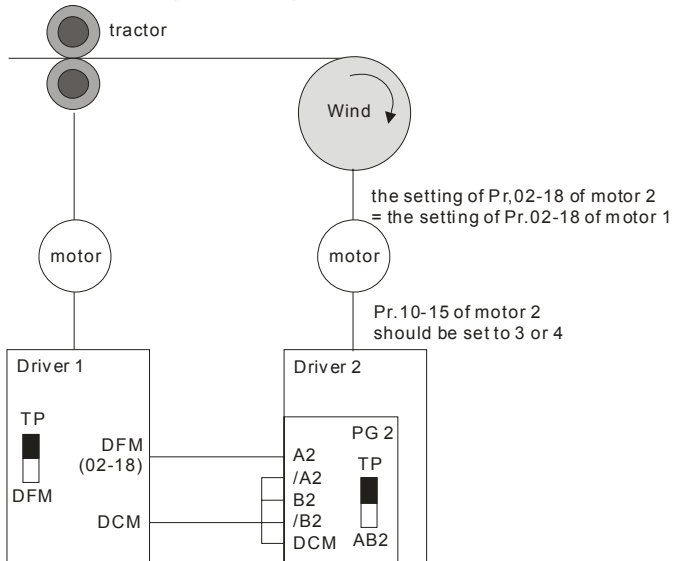

08-38	Max. Line Speed	Unit: 0.1
Control mode	VF VFPG SVC FOC/PG TQR/PG	Factory Setting: 1000.0
	Settings 0.0 to 3000.0 m/min	

08-39	Min. Line Speed	Unit: 0.1
--------------	-----------------	-----------



Control mode	VF	VFPG	SVC	FOCPG	TQRPG	Factory Setting: 0.0
Settings			0.0 to 3000.0 m/min			

08-40 Pulse Number for Each Meter Unit: 0.1

Control mode	VF	VFPG	SVC	FOCPG	TQRPG	Factory Setting: 0.0
Settings			0.0 to 6000.0			





08-41  Current Line Speed Unit: 0.1

Control mode	VF	VFPG	SVC	FOCPG	TQRPG	Factory Setting: 0.0
Settings			0.0 to 3000.0 m/min			

-  When Pr.08-37 is set to 1, 3, or 4, the current line speed will be saved into Pr.08-41 via analog and pulse command. At this time, Pr.08-41 will be read only.
-  When Pr.08-37 is set to 2, the setting of Pr.08-41(current line speed) can be changed by communication.

08-42 Source of Reel Diameter

Control mode	VF	VFPG	SVC	FOCPG	TQRPG	Factory Setting: 0
Settings			0	Calculated by line speed		
			1	Calculated by integrating thickness (encoder is on reel shaft)(Pr.08-49~51, Pr.10-15)		
			2	Calculated by integrating thickness (encoder is on motor)(Pr.08-23~08-24, 08-50~08-51, 10-00~10-01)		
			3	Calculated by analog input (Pr.03-00~03-02 is set to 13)		

-  When it is set to 1 or 2, it needs to be used with PG card.
-  When it is set to 1, the reel diameter can be got from the encoder on the reel shaft. At this time, the pulse signal needs to be connected to the PG2 of PG card and get the reel diameter from the settings of Pr.10-15, Pr.08-49, Pr.08-50 and Pr.08-51.
-  When it is set to 2, the reel diameter can be calculated from the motor encoder and gear ratio. At this time, the pulse signal should be connected to the PG1 of the PG card and get the reel diameter from the settings of Pr.08-23, Pr.08-24, Pr.10-01, Pr.10-00, Pr.08-50 and Pr.08-51.
-  When it is set to 3, the reel diameter can be calculated by analog input (Pr.03-00~03-02 is set to 13) and the corresponding value of 10V is Pr.08-43.

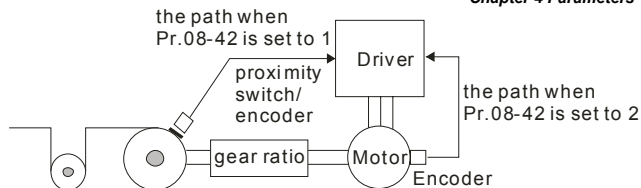

08-43 ✓ Max. Reel Diameter Unit: 0.1

Control mode	VF	VFP	SVC	FOCPG	TQRP	Factory Setting: 6000.0
Settings			1.0 to 6000.0mm			

08-44 ✓ Empty Reel Diameter Unit: 0.1

Control mode	VF	VFP	SVC	FOCPG	TQRP	Factory Setting: 1.0
Settings			1 to 6000.0mm			

08-45 Source of Reel Diameter Factory Setting: 0

Control mode	VF	VFP	SVC	FOCPG	TQRP	Factory Setting: 0
Settings			0	RS-485 communication setting (Pr.08-46)		
			1	Analog input (Pr.03-00-Pr.03-02 is set to 13)		

When it is set to 1, the corresponding value of 10V is Pr.08-43.

08-46 ✓ Initial Reel Diameter Unit: 0.1

Control mode	VF	VFP	SVC	FOCPG	TQRP	Factory Setting: 1.0
Settings			1.0 to 6000.0mm			

When Pr.08-45 is set to 1, Pr.08-46 will be read-only.

08-47 Initial Reel Diameter 1 Unit: 0.1

08-48 Initial Reel Diameter 2 Unit: 0.1

Control mode	VF	VFP	SVC	FOCPG	TQRP	Factory Setting: 1.0
Settings			1.0 to 6000.0mm			

Pr.08-46 needs to be used by setting 44~46 to Pr.02-01~02-06, Pr.02-23~Pr.02-30.

When you need to have many types of reel diameter, please set Pr.08-46 to 0.

08-49 Number of Pulse Per Revolution Unit: 1

Control mode	VF	VFPG	SVC	FOCPG	TQRPG	Factory Setting: 1
Settings			1 to 10000ppr			

08-50 Coil Number for Each Layer Unit: 1

Control mode	VF	VFPG	SVC	FOCPG	TQRPG	Factory Setting: 1
Settings			1 to 10000			

08-51 Material Thickness Unit: 0.001

Control mode	VF	VFPG	SVC	FOCPG	TQRPG	Factory Setting: 1.000
Settings			0.001 to 60.000mm			

08-52  Filter Time of Reel Diameter Unit: 0.01

Control mode	VF	VFPG	SVC	FOCPG	TQRPG	Factory Setting: 1.00
Settings			0.00 to 100.00 sec			

 This parameter can be used to improve unstable of the source of reel diameter(Pr.08-42).

08-53 Auto Compensation of Reel Diameter

Control mode	VF	VFPG	SVC	FOCPG	TQRPG	Factory Setting: 0
Settings			0 Disable			
			1 Enable			

08-54  Current Reel Diameter Unit: 0.1

Control mode	VF	VFPG	SVC	FOCPG	TQRPG	Factory Setting: 1.0
Settings			1.0 to 6000.0 mm			

 When the AC motor drive is not at STOP, this parameter is read-only.

08-55 Smart Start

Control mode	VF	VFPG	SVC	FOCPG	TQRPG	Factory Setting: 0
Settings			0 Disable			
			1 Enable			
			2 In unwind mode, rewind in reverse direction			

08-56 Switch Level for Smart Start and PID Function Unit: 1

Control mode	VF	VFPG	SVC	FOCPG	TQRPG	Factory Setting: 15.0
--------------	----	------	-----	-------	-------	-----------------------

Settings 0.0~100.0% (according to Pr.08-26)

08-57 Frequency for Smart Start Unit: 1

Control mode VF VFPG SVC FOC PG TQR PG Factory Setting: 2.00

Settings 0.00~600.00Hz

08-58  Accel. Time for Smart Start Unit: 0.01

Control mode VF VFPG SVC FOC PG Factory Setting: 3.00

Settings 0.01~600.00 sec

 When the speeds of wider/unwinder and tractor can't match at start-up, the situation can be improved by setting Pr.08-57 and Pr.08-58.

08-59 Broken Belt Detection

Control mode VF VFPG SVC FOC PG Factory Setting: 0

Settings 0 Disable
1 Enable

08-60 Min. Line Speed of Broken Belt Detection Unit: 0.1

Control mode VF VFPG SVC FOC PG Factory Setting: 0.0

Settings 0.0~3000.0 m/min

08-61 Allowance Error of Line Speed of Broken Belt Detection Unit: 0.1

Control mode VF VFPG SVC FOC PG Factory Setting: 100.0

Settings 1.0~6000.0 mm

08-62 Detection Time of Broken Belt Unit: 0.1

Control mode VF VFPG SVC FOC PG Factory Setting: 1.00

Settings 0.00~100.00 sec

 When the broken belt detection is enabled, line speed is higher than Pr.08-61, allowance error of line speed of broken belt detection exceeds Pr.08-61 and detection time of broken belt exceeds Pr.08-62, the broken belt occurs.

08-63 Allowance Error Level of Tension/Line Speed PID Feedback Unit: 1

Control mode	VF	VFPF	SVC	FOCPG	Factory Setting: 100
Settings			0~100%		

 The corresponding value for the 100% of dancer is 10V.

08-64 Allowance Error Detection Time of Tension PID Feedback Unit: 0.1

Control mode	VF	VFPF	SVC	FOCPG	Factory Setting: 0.5
Settings			0.0~10.0 sec		

08-65 Error Treatment of Tension PID Feedback

Control mode	VF	VFPF	SVC	FOCPG	Factory Setting: 0
Settings			0	Warn and keep operation	
			1	Warn and coast to stop	
			2	Warn and ramp to stop	

 When the error of tension PID target value and tension PID feedback exceeds Pr.08-63 and the allowance error detection time of tension PID exceeds Pr.08-64, tension PID feedback error occurs. Refer to Pr.08-65 for error treatment of tension PID feedback.

08-66 Upper Limit of Tension PID Feedback Unit: 0.1

Control mode	VF	VFPF	SVC	FOCPG	TQRPG	Factory Setting: 100.0
Settings			0.0~100.0%			

08-67 Lower Limit of Tension PID Feedback Unit: 0.1

Control mode	VF	VFPF	SVC	FOCPG	TQRPG	Factory Setting: 0.0
Settings			0.0~100.0%			

08-68 Reserved

08-69 DFM Selection

Control mode	VF	VFPF	SVC	FOCPG	TQRPG	Factory Setting: 0
Settings			0	Output frequency		
			1	Frequency command		

08-70  Low-pass Filter Time of Line Speed Unit: 0.01

Control mode	VF	VFPF	SVC	FOCPG	TQRPG	Factory Setting: 0.00
--------------	----	------	-----	-------	-------	-----------------------

Settings	0.00~100.00 sec
----------	-----------------

08-71	Reserved
08-75	

08-76 Source of Tension Setting

Control mode	TQRPG	Factory Setting: 0
---------------------	--------------	--------------------

Settings	0	Communication RS-485 (Pr.08-78)
	1	Analog input (Pr. 03-00~03-02 is set to 15 tension setting) (Pr.08-78)

08-77 Max. Tension Unit: 1

Control mode	TQRPG	Factory Setting: 0
---------------------	--------------	--------------------

Settings	0 ~30000 N
----------	------------

08-78 ✓ Tension Setting Unit: 1

Control mode	TQRPG	Factory Setting: 0
---------------------	--------------	--------------------

Settings	0 ~30000 N
----------	------------

08-79 Source of Zero-speed Tension Setting

Control mode	TQRPG	Factory Setting: 0
---------------------	--------------	--------------------

Settings	0	Disable
	1	Communication RS-485 (Pr.08-80)
	2	Analog input (Pr. 03-00~03-02 is set to 16 zero-speed tension) (Pr.08-80)

08-80 ✓ Setting of Zero-speed Tension Unit: 1

Control mode	TQRPG	Factory Setting: 0
---------------------	--------------	--------------------

Settings	0 ~30000 N
----------	------------

08-81 Source of Tension Taper

Control mode	TQRPG	Factory Setting: 0
---------------------	--------------	--------------------

Settings	0	Communication RS-485 (Pr.08-82)
	1	Analog input (Pr. 03-00~03-02 is set to 17 tension taper) (Pr.08-82)

08-82 ✓ Tension Taper Unit: 1

Control mode	TQRPG	Factory Setting: 0
Settings	0~100%	
08-83	↗ Friction Compensation	Unit: 1
Control mode	TQRPG	Factory Setting: 0.0
Settings	0.0~100.0%	
08-84	↗ Compensation Coefficient of Material Inertial	Unit: 1
Control mode	TQRPG	Factory Setting: 0
Settings	0~30000	
08-85	↗ Torque Feed Forward Gain	Unit: 0.1
Control mode	TQRPG	Factory Setting: 50.0
Settings	0.0~100.0%	
08-86	↗ Low Pass Filter Time of Torque Feed Forward	Unit: 0.01
Control mode	TQRPG	Factory Setting: 5.00
Settings	0.00~100.00	
08-87 08-99	Reserved	

Group 9: Communication Parameters

There is a built-in RS-485 serial interface, marked RJ-11 near to the control terminals. The pins are defined below:

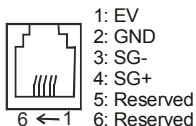

Each VFD-VE AC drive has a pre-assigned communication address specified by Pr.09-00. The RS485 master then controls each AC motor drive according to its communication address.

09-00		Communication Address					Factory Setting: 1
Control mode	VF	VFPG	SVC	FOCPG	TQRPG		
	Settings		1 to 254				

- If the AC motor drive is controlled by RS-485 serial communication, the communication address for this drive must be set via this parameter. And the communication address for each AC motor drive must be different and unique.

09-01		COM1 Transmission Speed					Factory Setting: 9.6
Control mode	VF	VFPG	SVC	FOCPG	TQRPG		
	Settings		4.8 to 115.2kbps				

- This parameter is used to set the transmission speed between the RS485 master (PLC, PC, etc.) and AC motor drive.

09-02		COM1 Transmission Fault Treatment					Factory Setting: 3
Control mode	VF	VFPG	SVC	FOCPG	TQRPG		
	Settings	0	Warn and keep operating				
		1	Warn and RAMP to stop				
		2	Warn and COAST to stop				
		3	No warning and keep operating				

- This parameter is set to how to react if transmission errors occur.

09-03 / COM1 Time-out Detection

Unit: 0.1

Control mode	VF	VFPG	SVC	FOCPG	TQRPG	Factory Setting: 0.0
Settings						0.0 ~ 100.0 sec (0.0 disable)

If Pr.09-03 is not set to 0.0, Pr.09-02=0~2, and there is no communication on the bus during the Time Out detection period (set by Pr.09-03), "cE10" will be shown on the keypad.

09-04 / COM1 Communication Protocol

Control mode	VF	VFPG	SVC	FOCPG	TQRPG	Factory Setting: 1
Settings						0 Modbus ASCII mode, protocol <7,N,1>
						1 Modbus ASCII mode, protocol <7,N,2>
						2 Modbus ASCII mode, protocol <7,E,1>
						3 Modbus ASCII mode, protocol <7,O,1>
						4 Modbus ASCII mode, protocol <7,E,2>
						5 Modbus ASCII mode, protocol <7,O,2>
						6 Modbus ASCII mode, protocol <8,N,1>
						7 Modbus ASCII mode, protocol <8,N,2>
						8 Modbus ASCII mode, protocol <8,E,1>
						9 Modbus ASCII mode, protocol <8,O,1>
						10 Modbus ASCII mode, protocol <8,E,2>
						11 Modbus ASCII mode, protocol <8,O,2>
						12 Modbus RTU mode, protocol <8,N,1>
						13 Modbus RTU mode, protocol <8,N,2>
						14 Modbus RTU mode, protocol <8,E,1>
						15 Modbus RTU mode, protocol <8,O,1>
						16 Modbus RTU mode, protocol <8,E,2>
						17 Modbus RTU mode, protocol <8,O,2>

1. Control by PC or PLC

★ A VFD-VE can be set up to communicate on Modbus networks using one of the following modes: ASCII (American Standard Code for Information Interchange) or RTU (Remote Terminal Unit).

Users can select the desired mode along with the serial port communication protocol in Pr.09-04.

★ Code Description:

ASCII mode:

Each 8-bit data is the combination of two ASCII characters. For example, a 1-byte data:

64 Hex, shown as '64' in ASCII, consists of '6' (36Hex) and '4' (34Hex).

Character	'0'	'1'	'2'	'3'	'4'	'5'	'6'	'7'
ASCII code	30H	31H	32H	33H	34H	35H	36H	37H

Character	'8'	'9'	'A'	'B'	'C'	'D'	'E'	'F'
ASCII code	38H	39H	41H	42H	43H	44H	45H	46H

RTU mode:

Each 8-bit data is the combination of two 4-bit hexadecimal characters. For example, 64 Hex.

 2. Data Format

10-bit character frame (For ASCII):

(7.N.2)

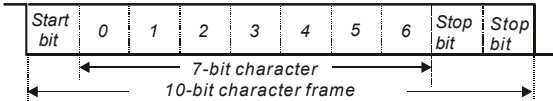

(7.E.1)

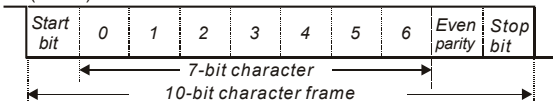

(7.O.1)

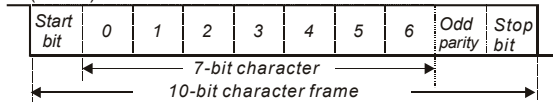

11-bit character frame (For RTU):

(8.N.2)

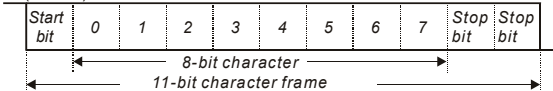

(8.E.1)

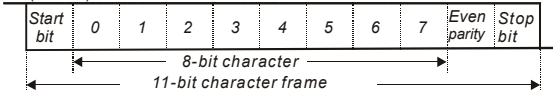

(8.O.1)

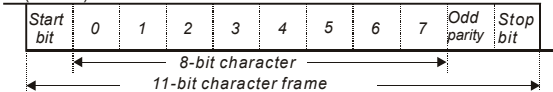

3. Communication Protocol

3.1 Communication Data Frame:

ASCII mode:

STX	Start character ':' (3AH)
Address Hi	Communication address:
Address Lo	8-bit address consists of 2 ASCII codes
Function Hi	Command code:
Function Lo	8-bit command consists of 2 ASCII codes

DATA (n-1) to DATA 0	Contents of data: Nx8-bit data consist of 2n ASCII codes n<=16, maximum of 32 ASCII codes
LRC CHK Hi	LRC check sum:
LRC CHK Lo	8-bit check sum consists of 2 ASCII codes
END Hi	End characters:
END Lo	END1= CR (0DH), END0= LF(0AH)

RTU mode:

START	A silent interval of more than 10 ms
Address	Communication address: 8-bit address
Function	Command code: 8-bit command
DATA (n-1) to DATA 0	Contents of data: n×8-bit data, n<=16
CRC CHK Low	CRC check sum:
CRC CHK High	16-bit check sum consists of 2 8-bit characters
END	A silent interval of more than 10 ms

3.2 Address (Communication Address)

Valid communication addresses are in the range of 0 to 254. A communication address equal to 0, means broadcast to all AC drives (AMD). In this case, the AMD will not reply any message to the master device.

00H: broadcast to all AC drives

01H: AC drive of address 01

0FH: AC drive of address 15

10H: AC drive of address 16

⋮

FEH: AC drive of address 254

For example, communication to AMD with address 16 decimal (10H):

ASCII mode: Address='1','0' => '1'=31H, '0'=30H

RTU mode: Address=10H

3.3 Function (Function code) and DATA (data characters)

The format of data characters depends on the function code.

03H: read data from register

06H: write single register

08H: loop detection

10H: write multiple registers

The available function codes and examples for VFD-VE are described as follows:

(1) 03H: multi read, read data from registers.

Example: reading continuous 2 data from register address 2102H, AMD address is 01H.

ASCII mode:

Command message:

STX	'.'
Address	'0'
	'1'
Function	'0'
	'3'
Starting data address	'2'
	'1'

Response message:

STX	'.'
Address	'0'
	'1'
Function	'0'
	'3'
Number of data (Count by byte)	'0'
	'4'

Command message:

	'0'
	'2'
Number of data (count by word)	'0'
	'0'
	'2'
	'2'
LRC Check	'D'
	'7'
END	CR
	LF

Response message:

Content of starting address 2102H	'1'
	'7'
	'7'
	'0'
Content of address 2103H	'0'
	'0'
	'0'
	'0'
LRC Check	'7'
	'1'
END	CR
	LF

RTU mode:

Command message:

Address	01H
Function	03H
Starting data address	21H 02H
Number of data (count by word)	00H 02H
CRC CHK Low	6FH
CRC CHK High	F7H

Response message:

Address	01H
Function	03H
Number of data (count by byte)	04H
Content of address 2102H	17H
	70H
Content of address 2103H	00H
	00H
CRC CHK Low	FEH
CRC CHK High	5CH

(2) 06H: single write, write single data to register.

Example: writing data 6000(1770H) to register 0100H. AMD address is 01H.

ASCII mode:

Command message:

STX	':'
Address	'0'
	'1'
Function	'0'
	'6'
Data address	'0'
	'1'
	'0'
	'0'
Data content	'1'
	'7'
	'7'
	'0'
LRC Check	'7'
	'1'
END	CR
	LF

Response message:

STX	':'
Address	'0'
	'1'
Function	'0'
	'6'
Data address	'0'
	'1'
	'0'
	'0'
Data content	'1'
	'7'
	'7'
	'0'
LRC Check	'7'
	'1'
END	CR
	LF

RTU mode:

Command message:

Address	01H
Function	06H
Data address	01H

Response message:

Address	01H
Function	06H
Data address	01H

	00H
Data content	17H
	70H
CRC CHK Low	86H
CRC CHK High	22H

	00H
Data content	17H
	70H
CRC CHK Low	86H
CRC CHK High	22H

(3) 10H: write multiple registers (write multiple data to registers)

Example: Set the multi-step speed,

Pr.05-00=50.00 (1388H), Pr.05-01=40.00 (0FA0H). AC drive address is 01H.

ASCII Mode:

Command message:

STX	':'
Address 1	'0'
Address 0	'1'
Function 1	'1'
Function 0	'0'
Starting data address	'0'
	'5'
	'0'
Number of data (count by word)	'0'
	'0'
	'2'
Number of data (count by byte)	'0'
	'4'
The first data content	'1'
	'3'
	'8'
	'8'
The second data content	'0'
	'F'
	'A'
LRC Check	'0'
	'9'
END	'A'
	CR
	LF

Response message:

STX	':'
Address 1	'0'
Address 0	'1'
Function 1	'1'
Function 0	'0'
Starting data address	'0'
	'5'
	'0'
Number of data (count by word)	'0'
	'0'
	'2'
LRC Check	'E'
	'8'
END	CR
	LF

RTU mode:

Command message:

Address	01H
Function	10H
Starting data address	05H
Starting data address	00H
Number of data (count by word)	00H
Number of data (count by word)	02H
Number of data (count by byte)	04
The first data content	13H
	88H
The second data	0FH

Response message:

Address	01H
Function	10H
Starting data address	05H
	00H
Number of data (count by word)	00H
Number of data (count by word)	02H
CRC Check Low	41H
CRC Check High	04H

content	A0H
CRC Check Low	'9'
CRC Check High	'A'

3.4 Check sum

ASCII mode:

LRC (Longitudinal Redundancy Check) is calculated by summing up, module 256, the values of the bytes from ADR1 to last data character then calculating the hexadecimal representation of the 2's-complement negation of the sum.

For example, reading 1 word from address 0401H of the AC drive with address 01H.

STX	':'
Address 1	'0'
Address 0	'1'
Function 1	'0'
Function 0	'3'
Starting data address	'0'
	'4'
	'0'
	'1'
Number of data	'0'
	'0'
	'0'
	'1'
LRC Check 1	'F'
LRC Check 0	'6'
END 1	CR
END 0	LF

$01H+03H+04H+01H+00H+01H=0AH$, the 2's-complement negation of 0AH is **F6H**.

RTU mode:

Address	01H
Function	03H
Starting data address	21H
	02H
Number of data (count by word)	00H
	02H
CRC CHK Low	6FH
CRC CHK High	F7H

CRC (Cyclical Redundancy Check) is calculated by the following steps:

Step 1: Load a 16-bit register (called CRC register) with FFFFH.

Step 2: Exclusive OR the first 8-bit byte of the command message with the low order byte of the 16-bit CRC register, putting the result in the CRC register.

Step 3: Examine the LSB of CRC register.

Step 4: If the LSB of CRC register is 0, shift the CRC register one bit to the right with MSB zero filling, then repeat step 3. If the LSB of CRC register is 1, shift the CRC register one bit to the right with MSB zero filling, Exclusive OR the CRC register with the polynomial value A001H, then repeat step 3.

Step 5: Repeat step 3 and 4 until eight shifts have been performed. When this is done, a complete 8-bit byte will have been processed.

Step 6: Repeat step 2 to 5 for the next 8-bit byte of the command message. Continue doing this until all bytes have been processed. The final contents of the CRC register are the CRC value. When

Chapter 4 Parameters | VFD-VE

transmitting the CRC value in the message, the upper and lower bytes of the CRC value must be swapped, i.e. the lower order byte will be transmitted first.

The following is an example of CRC generation using C language. The function takes two arguments:

Unsigned char* data ← a pointer to the message buffer

Unsigned char length ← the quantity of bytes in the message buffer

The function returns the CRC value as a type of unsigned integer.

```
Unsigned int crc_chk(unsigned char* data, unsigned char length){
int j;
unsigned int reg_crc=0xFFFF;
while(length--){
reg_crc ^= *data++;
for(j=0;j<8;j++){
if(reg_crc & 0x01){ /* LSB(b0)=1 */
reg_crc=(reg_crc>>1) ^ 0xA001;
}else{
reg_crc=reg_crc >>1;
}
}
}
return reg_crc;
}
```

3.5 Address list

The contents of available addresses are shown as below:

Content	Address	Function	
AC drive Parameters	GGnnH	GG means parameter group, nn means parameter number, for example, the address of Pr 4-01 is 0401H. Referencing to chapter 5 for the function of each parameter. When reading parameter by command code 03H, only one parameter can be read at one time.	
Command Write only	2000H	Bit 0-3	0: No function 1: Stop 2: Run 3: Jog + Run
Command Write only	2000H	Bit 4-5	00B: No function 01B: FWD 10B: REV 11B: Change direction
		Bit 6-7	00B: 1st accel/decel 01B: 2nd accel/decel 10B: 3rd accel/decel 11B: 4th accel/decel
		Bit 8-11	Represented 16 step speeds.
		Bit 12	0: No comm. multi step speed or accel/decel time 1: Comm. multi step speed or accel/decel time
		Bit 13~14	00B: No function
			01B: operated by digital keypad
	02B: operated by Pr.00-21 setting		
03B: change operation source			
2001H	Bit 15	Reserved	
	2001H	Frequency command	

Content	Address	Function	
	2002H	Bit 0	1: EF (external fault) on
		Bit 1	1: Reset
		Bit 2	1: B.B. ON
		Bit 3-15	Reserved
Status monitor Read only	2100H	Error code: refer to Pr.06-17 to Pr.06-22	
	2119H	Bit 0	1: FWD command
Bit 1		1: Operation status	
Bit 2		1: Jog command	
Bit 3		1: REV command	
		Bit 4	1: REV command
		Bit 8	1: Master frequency Controlled by communication interface
		Bit 9	1: Master frequency controlled by analog signal
		Bit 10	1: Operation command controlled by communication interface
		Bit 11	1: Parameters have been locked
		Bit 12	1: enable to copy parameter from keypad
		Bit 13-15	Reserved
		2102H	Frequency command (F)
	2103H	Output frequency (H)	
	2104H	Output current (A _{XXX.X})	
	2105H	DC-BUS Voltage (U _{XXX.X})	
	2106H	Output voltage (E _{XXX.X})	
	2107H	Current step number of Multi-Step Speed Operation	
	2109H	Counter value	
	2116H	Multi-function display (Pr.00-04)	
	211AH	Setting frequency (F)	
	211BH	Max. setting frequency	
211CH	Max. output frequency		
2200H	Feedback Signal (XXX.XX %)		
2203H	AVI analog input (XXX.XX %)		
2204H	ACI analog input (XXX.XX %)		
2205H	AUI analog input (XXX.XX %)		
2206H	Display temperature of IGBT (°C)		
2207H	Display temperature of heatsink (°C)		

3.6 Exception response:

The AC motor drive is expected to return a normal response after receiving command messages from the master device. The following depicts the conditions when no normal response is replied to the master device.

The AC motor drive does not receive the messages due to a communication error; thus, the AC motor drive has no response. The master device will eventually process a timeout condition.

The AC motor drive receives the messages without a communication error, but cannot handle them. An exception response will be returned to the master device and an error message "CE_{xx}" will be displayed on the keypad of AC motor drive. The xx of "CE_{xx}" is a decimal code equal to the exception code that is described below.

In the exception response, the most significant bit of the original command code is set to 1, and an exception code which explains the condition that caused the exception is returned.

Example of an exception response of command code 06H and exception code 02H:

ASCII mode:

RTU mode:

STX	':'
Address Low	'0'
Address High	'1'
Function Low	'8'
Function High	'6'
Exception code	'0'
	'2'
LRC CHK Low	'7'
LRC CHK High	'7'
END 1	CR
END 0	LF

Address	01H
Function	86H
Exception code	02H
CRC CHK Low	C3H
CRC CHK High	A1H

The explanation of exception codes:

Exception code	Explanation
01	Illegal function code: The function code received in the command message is not available for the AC motor drive.
02	Illegal data address: The data address received in the command message is not available for the AC motor drive.
03	Illegal data value: The data value received in the command message is not available for the AC drive.
04	Slave device failure: The AC motor drive is unable to perform the requested action.
10	Communication time-out: If Pr.09-03 is not equal to 0.0, Pr.09-02=0~2, and there is no communication on the bus during the Time Out detection period (set by Pr.09-03), "cE10" will be shown on the keypad.

3.7 Communication program of PC:

The following is a simple example of how to write a communication program for Modbus ASCII mode on a PC by C language.

```
#include<stdio.h>
#include<dos.h>
#include<conio.h>
#include<process.h>
#define PORT 0x03F8 /* the address of COM1 */
/* the address offset value relative to COM1 */
#define THR 0x0000
#define RDR 0x0000
#define BRDL 0x0000
#define IER 0x0001
#define BRDH 0x0001
#define LCR 0x0003
#define MCR 0x0004
#define LSR 0x0005
#define MSR 0x0006
unsigned char rdat[60];
/* read 2 data from address 2102H of AC drive with address 1 */
unsigned char tdat[60]={':', '0', '1', '0', '3', '2', '1', '0', '2', '0', '0', '0', '2', 'D', '7', '\r', '\n'};
void main(){
int i;
```

```

outputb(PORT+MCR,0x08);      /* interrupt enable */
outputb(PORT+IER,0x01);     /* interrupt as data in */
outputb(PORT+LCR,(inportb(PORT+LCR) | 0x80));
/* the BRDL/BRDH can be access as LCR.b7==1 */
outputb(PORT+BRDL,12);      /* set baudrate=9600, 12=115200/9600*/
outputb(PORT+BRDH,0x00);
outputb(PORT+LCR,0x06);     /* set protocol, <7,N,2>=06H, <7,E,1>=1AH, <7,O,1>=0AH,
<8,N,2>=07H, <8,E,1>=1BH, <8,O,1>=0BH */
for(i=0;i<=16;i++){
while(!(inportb(PORT+LSR) & 0x20)); /* wait until THR empty */
outputb(PORT+THR,tdata[i]); /* send data to THR */ }
i=0;
while(!kbhit()){
if(inportb(PORT+LSR) & 0x01){ /* b0==1, read data ready */
rdata[i++]=inportb(PORT+RDR); /* read data form RDR */
} } }

```

09-05	COM2 Transmission Speed (Keypad)	Unit: 0.1
--------------	----------------------------------	-----------

Control mode	VF	VFP	SVC	FOCPG	TQRP	
						Factory Setting: 9.6
Settings			4.8 to 115.2kpbs			

 This parameter is used to set the transmission speed between the RS485 master (PLC, PC, etc.) and AC motor drive.

09-06	COM2 Transmission Fault Treatment (Keypad)	
--------------	--	--

Control mode	VF	VFP	SVC	FOCPG	TQRP	
						Factory Setting: 3
Settings			0	Warn and keep operating		
			1	Warn and RAMP to stop		
			2	Warn and COAST to stop		
			3	No warning and keep operating		

 This parameter is set to how to react if transmission errors occur.

09-07	COM2 Time-out Detection (Keypad)	Unit: 0.1
--------------	----------------------------------	-----------

Control mode	VF	VFP	SVC	FOCPG	TQRP	
						Factory Setting: 0.0
Settings			0.0 ~ 100.0 sec			

 If Pr.09-03 is not equal to 0.0, Pr.09-02=0~2, and there is no communication on the bus during the Time Out detection period (set by Pr.09-03), "cE10" will be shown on the keypad.

09-08	COM2 Communication Protocol (Keypad)	
--------------	--------------------------------------	--

Control mode	VF	VFP	SVC	FOCPG	TQRP	
						Factory Setting: 13
Settings			0	Modbus ASCII mode, protocol <7,N,1>		
			1	Modbus ASCII mode, protocol <7,N,2>		

2	Modbus ASCII mode, protocol <7,E,1>
3	Modbus ASCII mode, protocol <7,O,1>
4	Modbus ASCII mode, protocol <7,E,2>
5	Modbus ASCII mode, protocol <7,O,2>
6	Modbus ASCII mode, protocol <8,N,1>
7	Modbus ASCII mode, protocol <8,N,2>
8	Modbus ASCII mode, protocol <8,E,1>
9	Modbus ASCII mode, protocol <8,O,1>
10	Modbus ASCII mode, protocol <8,E,2>
11	Modbus ASCII mode, protocol <8,O,2>
12	Modbus RTU mode, protocol <8,N,1>
13	Modbus RTU mode, protocol <8,N,2>
14	Modbus RTU mode, protocol <8,E,1>
15	Modbus RTU mode, protocol <8,O,1>
16	Modbus RTU mode, protocol <8,E,2>
17	Modbus RTU mode, protocol <8,O,2>

09-09 **Response Delay Time**

Unit: 0.1

Control mode	VF	VFPG	SVC	FOCPG	TQRPG
---------------------	-----------	-------------	------------	--------------	--------------

Factory Setting: 2.0

Settings 0.0 ~ 200.0 msec

 This parameter is the response delay time after AC drive receives communication command as shown in the following.

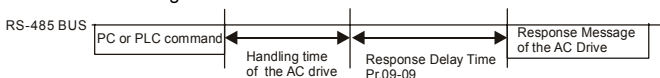
**09-10** **Transmission Master Frequency**

Unit: 0.01

Control mode	VF	VFPG	SVC	FOCPG	TQRPG
---------------------	-----------	-------------	------------	--------------	--------------

Factory Setting: 60.00

Settings 0.00 ~ 600.00 Hz

 When Pr.00-20 is set to 1 (RS485 communication). The AC motor drive will save the last frequency command into Pr.09-10 when abnormal turn-off or momentary power loss. After re-power on, it will with the frequency set in Pr.09-10 if there is no new frequency command.

09-11 **Block Transfer 1**

Unit: 1

09-12 **Block Transfer 2**

Unit: 1

09-13 **Block Transfer 3**

Unit: 1

09-14	✓ Block Transfer 4	Unit: 1
09-15	✓ Block Transfer 5	Unit: 1
09-16	✓ Block Transfer 6	Unit: 1
09-17	✓ Block Transfer 7	Unit: 1
09-18	✓ Block Transfer 8	Unit: 1
09-19	✓ Block Transfer 9	Unit: 1
09-20	✓ Block Transfer 10	Unit: 1

Control mode	VF	VFPG	SVC	FOCPG	TQRPG	Factory Setting: 0
	Settings	0 to 65535				

 There is a group of block transfer parameter available in the AC motor drive (Pr.09-11 to Pr.09-20). User can use them (Pr.09-11 to Pr.09-20) to save those parameters that you want to read.

09-21	✓ Multi-function Output Status					
Control mode	VF	VFPG	SVC	FOCPG	TQRPG	Factory Setting: Read-only
	Settings	0 to 65535				

09-22	✓ AFM2 Status					
Control mode	VF	VFPG	SVC	FOCPG	TQRPG	Factory Setting: Read-only
	Settings	0 to 4095				

09-23	✓ AFM3 Status					
Control mode	VF	VFPG	SVC	FOCPG	TQRPG	Factory Setting: Read-only
	Settings	0 to 4095				

Group 10 PID Control

10-00 Encoder Pulse

Unit: 1

Control mode VFPG FOC PG TQRPG

Factory Setting: 600

Settings 1 to 20000 (Max=20000 for 2-pole motor)

 A Pulse Generator (PG) or encoder is used as a sensor that provides a feedback signal of the motor speed. This parameter defines the number of pulses for each cycle of the PG control.

10-01 Encoder Input Type Setting

Control mode VFPG FOC PG TQRPG

Factory Setting: 0

Settings 0 Disable

Phase A leads in a forward run command and phase B leads in a reverse run command

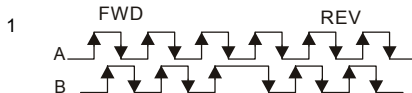

Phase B leads in a forward run command and phase A leads in a reverse run command

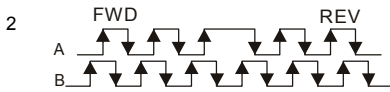

Phase A is a pulse input and phase B is a direction input. (low input=reverse direction, high input=forward direction)

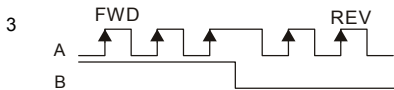

Phase A is a pulse input and phase B is a direction input. (low input=forward direction, high input=reverse direction)

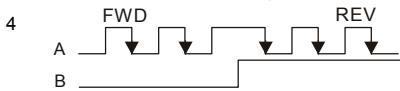

5 Single-phase input



 It is helpful for the stable control by inputting correct pulse type.

10-02	✎ PG Feedback Fault Treatment		Unit: 0.1
Control mode	VFPG FOCPG TQRPG	Factory Setting: 2	
Settings	0	Warn and keep operating	
	1	Warn and RAMP to stop	
	2	Warn and COAST to stop	

10-03	✎ Detection Time for PG Feedback Fault		Unit: 0.01
Control mode	VFPG FOCPG TQRPG	Factory Setting: 1.00	
Settings	0.00 to 10.00 sec		

 When PG loss, encoder signal error, pulse signal setting error or signal error, if time exceeds the detection time for PG feedback fault (Pr.10-03), the PG signal error will occur. Refer to the Pr.10-02 for PG feedback fault treatment.

10-04	✎ ASR (Auto Speed Regulation) control (P) 1		Unit: 0.1
Control mode	VFPG FOCPG	Factory Setting: 10	
Settings	0 to 40 Hz		

10-05	✎ ASR (Auto Speed Regulation) control (I) 1		Unit: 0.001
Control mode	VFPG FOCPG	Factory Setting: 0.100	
Settings	0.000 to 10.000 sec		

10-06	✎ ASR (Auto Speed Regulation) control (P) 2		Unit: 0.1
Control mode	VFPG FOCPG	Factory Setting: 10	
Settings	0 to 40Hz		

10-07	✎ ASR (Auto Speed Regulation) control (I) 2		Unit: 0.001
Control mode	VFPG FOCPG	Factory Setting: 0.100	
Settings	0.000 to 10.000 sec		

10-08	✎ ASR 1/ASR2 Switch Frequency		Unit: 0.01
Control mode	VFPG FOCPG	Factory Setting: 7.00	
Settings	5.00 o 600.00Hz		

 ASR P determines Proportional control and associated gain (P). ASR I determines integral control and associated gain (I).

- When integral time is set to 0, it is disabled. Pr.10-08 defines the switch frequency for the ASR1 (Pr.10-04, Pr.10-05) and ASR2 (Pr.10-06, Pr.10-07).

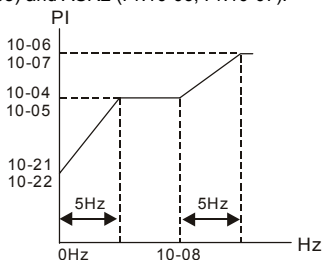

- When using multi-function input terminals to switch ASR1/ASR2, the diagram will be shown as follows.

Setting multi-function input terminal to 27
(ASR1/ASR2 switch)



10-09 ASR Primary Low Pass Filter Gain

Unit: 0.001

Control mode FOCPG

Factory Setting: 0.008

Settings 0.000 to 0.350 sec

- It defines the filter time of the ASR command.

10-10 PG Stall Level

Unit: 1

Control mode VFPG FOCPG

Factory Setting: 115

Settings 0 to 120% (0: disable)

- This parameter determines the maximum PG feedback signal allowed before a fault occurs. (max. output frequency Pr.01-00 =100%)

10-11 PG Stall Detection Time

Unit: 0.1

Control mode VFPG FOCPG

Factory Setting: 0.1

Settings 0.0 to 2.0 sec

10-12 PG Slip Range

Unit: 1

Control mode VFPG FOCPG

Factory Setting: 50

Settings 0 to 50% (0: disable)

10-13 ✓ PG Slip Detection Time Unit: 0.1

Control mode VFPG FOCPG Factory Setting: 0.5

Settings 0.0 to 10.0 sec

10-14 ✓ PG Stall and Slip Error Treatment

Control mode VFPG FOCPG Factory Setting: 2

Settings 0 Warn and keep operating
1 Warn and RAMP to stop
2 Warn and COAST to stop



When the value of (rotation speed – motor frequency) exceeds Pr.10-12 setting, detection time exceeds Pr.10-13 or motor frequency exceeds Pr.10-10 setting, it will start to accumulate time. If detection time exceeds Pr.10-11, the PG feedback signal error will occur. Refer to Pr.10-14 PG stall and slip error treatment.

10-15 ✓ Pulse Input Type Setting

Control mode VF VFPG SVC FOCPG TQRPG Factory Setting: 0

Settings 0 Disable

Phase A leads in a forward run command and phase B leads in a reverse run command

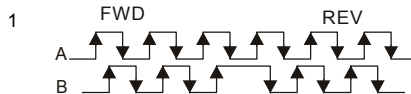

Phase B leads in a forward run command and phase A leads in a reverse run command

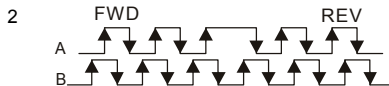

Phase A is a pulse input and phase B is a direction input. (low input=reverse direction, high input=forward direction)

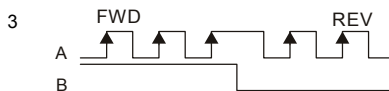

Phase A is a pulse input and phase B is a direction input. (low input=forward direction, high input=reverse direction)

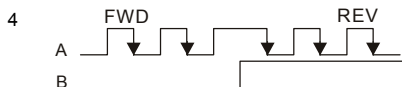

10-16 ✓ Output Setting for Frequency Division (denominator) Unit: 1

Control mode	VFPG FOC PG TQRPG	Factory Setting: 1
	Settings	1 to 255

This parameter is used to set the denominator for frequency division. For example, when it is set to 2 with feedback 1024ppr, PG output will be $1024/2=512$ ppr.

10-17 ✓ PG Electrical Gear A (Channel 1 of PG card) Unit: 1

Control mode	VFPG FOC PG	Factory Setting: 100
	Settings	1 to 5000

10-18 ✓ PG Electrical Gear B (Channel 2 of PG card) Unit: 1

Control mode	VFPG FOC PG	Factory Setting: 100
	Settings	1 to 5000

Rotation speed = pulse frequency/encoder pulse (Pr.10-00) * PG Electrical Gear A / PG Electrical Gear B.

10-19 ✓ PG Position Control Point (Home) Unit: 1

Control mode	VFPG FOC PG	Factory Setting: 0
	Settings	0 to 20000

This parameter determines the home position in the position control.

10-20	↗ Range for PG Position Attained (Home range)	Unit: 1
Control mode	VFPG FOCPG	Factory Setting: 10
	Settings 0 to 20000	

 This parameter determines the Home position attained in the position control mode.

10-21	↗ P Gain of Zero Speed	Unit: 1
Control mode	VFPG FOCPG	Factory Setting: 10
	Settings 0 to 40Hz	

10-22	↗ I Gain of Zero Speed	Unit: 0.001
Control mode	VFPG FOCPG	Factory Setting: 0.100
	Settings 0.000 to 10.000 sec	

 This parameter determines zero speed command gain in speed control.

10-23	↗ Feed Forward Gain of APR	Unit: 1
Control mode	VFPG FOCPG	Factory Setting: 30
	Settings 0 to 100	

10-24	↗ Decelerate Time of Position	Unit: 0.01/0.1
Control mode	VFPG FOCPG	Factory Setting: 3.00/3.0
	Settings 0.00 to 600.00 sec/0.0 to 6000.0 sec	

10-25	↗ Max. Frequency for Resolution Switch	Unit: 0.01
Control mode	VF VFPG SVC FOCPG TQRPG	Factory Setting: 50.00
	Settings 50.00 to 600.00Hz	

 This function is used to enhance the function of unstable speed/position due to insufficient resolution of analog simulation value. It needs to use with external input terminals (one of Pr.02-01 to Pr.02-06/Pr.02-23 to Pr.02-30 should be set to 43).

Chapter 4 Parameters | **VFD-VE**

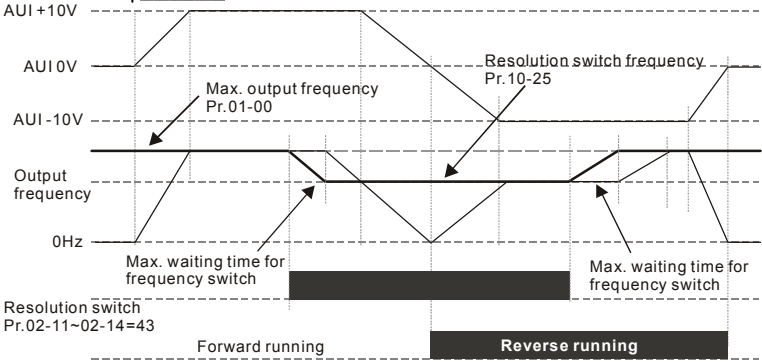

10-26	Reserved	
10-27	PG Mechanical Gear A1	Unit: 1
10-28	PG Mechanical Gear B1	Unit: 1
10-29	PG Mechanical Gear A2	Unit: 1
10-30	PG Mechanical Gear B2	Unit: 1
Control mode	VFPG FOC PG TQRPG	Factory Setting: 100
Settings	1 to 65535	

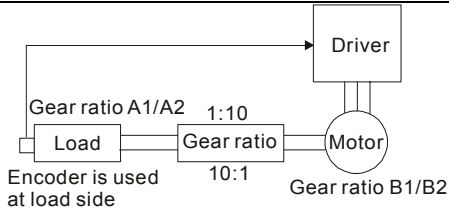

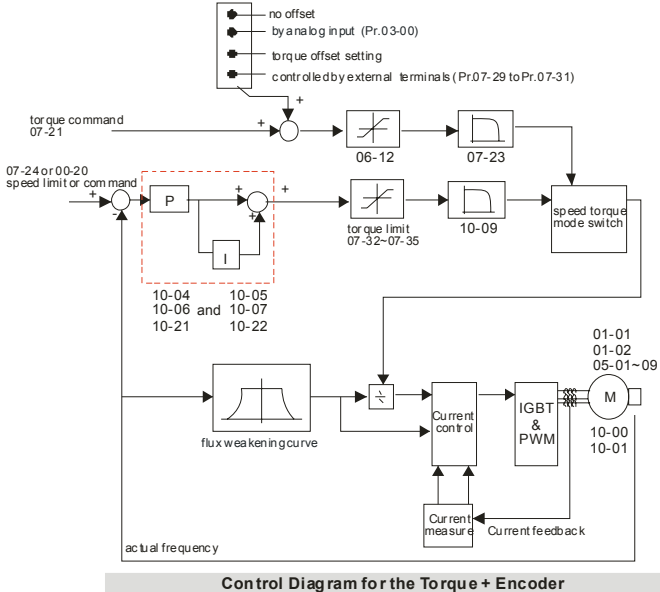
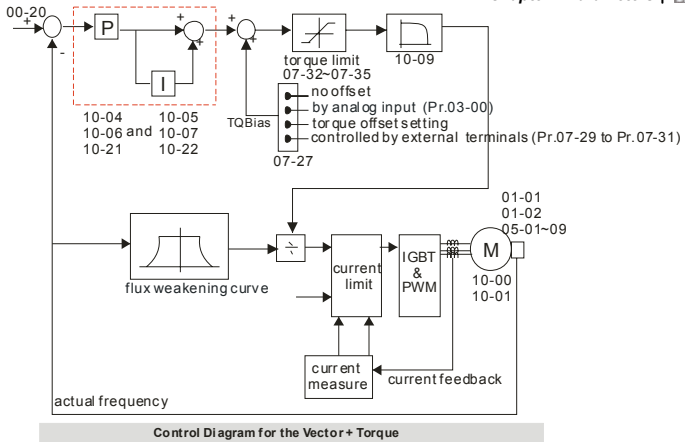

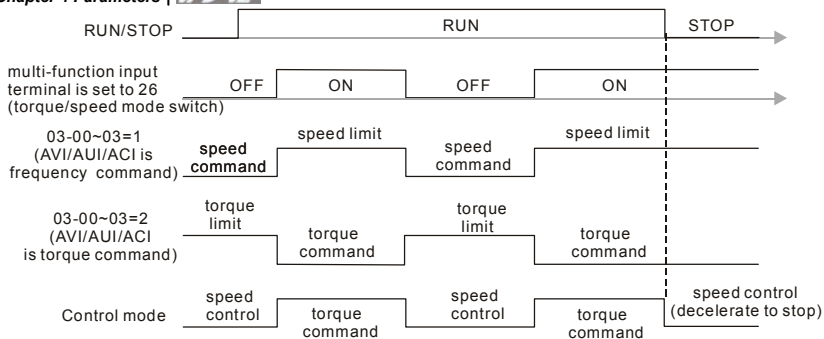

**Torque Control/Speed Control Switch Timing
(00-10=3/4, multi-function input terminal is set to 26)**

Group 11 Advanced Parameters

11-00 ✓ System Control

Control mode
FOCPG

Factory Setting: 0

Settings	Bit 0	ASR Auto tuning
	Bit 1	Inertia estimate (only in FOCPG mode)
	Bit 2	Zero Servo
	Bit 3	Reserved
	Bit 4	Enable gain adjustment of position loop KP

-  Bit 0=1: system will generate an ASR setting and Pr. 10-04~10-07, 10-21~10-22 will be invalid.
- Bit 1=1: Inertia estimate function is enabled.
- Bit 2=1: when frequency command is less than Fmin (Pr.01-07), it will use zero servo function.

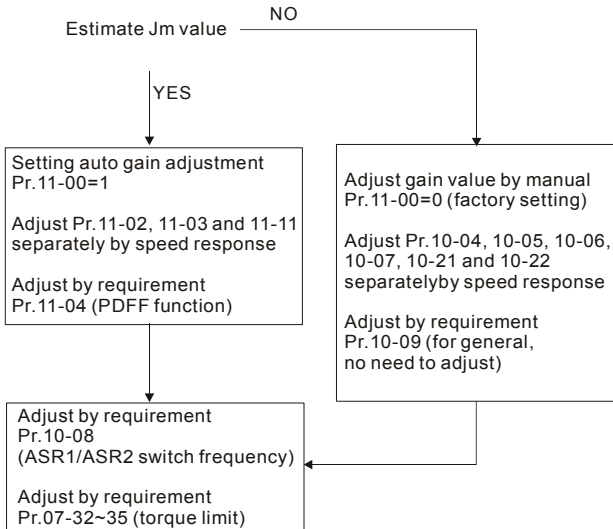

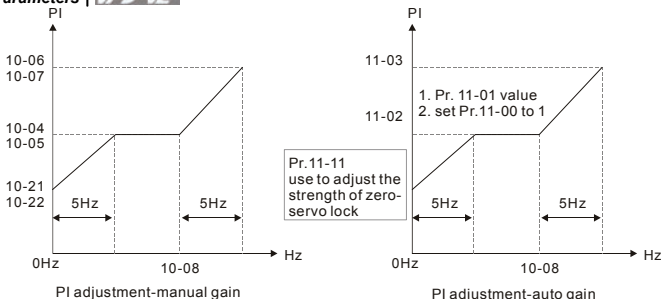
11-01 Per Unit of System Inertia

Unit: 1

Control mode FOCPG

Factory Setting: 400

Settings 1 to 65535 (256=1PU)

To get the system inertia from Pr. 11-01, user needs to set Pr. 11-00 to 2 and execute continuous forward/reverse running.

11-02 Low-speed Bandwidth

Unit: 1

Control mode FOCPG

Factory Setting: 10

Settings 0 to 40Hz

11-03 High-speed Bandwidth

Unit: 1

Control mode FOCPG

Factory Setting: 10

Settings 0 to 40Hz

11-11 Zero-speed Bandwidth

Unit: 1

Control mode VFPG FOCPG TQRPG

Factory Setting: 10

Settings 0 to 40Hz

After estimating inertia and set Pr. 11-00 to 1 (auto tuning), user can adjust parameters Pr. 11-02, 11-03 and 11-11 separately by speed response. The larger number you set, the faster response you will get. Pr. 10-08 is the switch frequency for low-speed/high-speed bandwidth.

11-04 PDFF Gain Value

Unit: 1

Control mode FOCPG

Factory Setting: 30

Settings 0 to 200%

After finishing estimating and set Pr.11-00=1 (auto tuning), using Pr.11-04 to reduce overshoot. Please adjust PDFF gain value by actual situation.

Besides traditional PI control, it also provides PDFF function to reduce overshoot for speed control.

1. Get Pr.11-01 value
2. Set Pr.11-00 to 1
3. Adjust Pr.11-04 (the larger number is set and the suppressed overshoot function will be better. But it needs to be used by the actual condition)

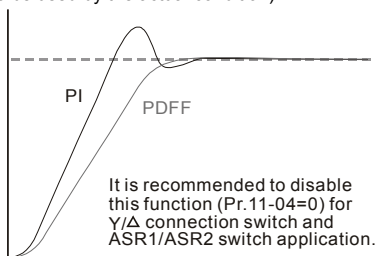

11-05 ✓ Gain Value of Flux Weakening Curve for Motor 1

Unit: 1

Control mode **FOCPG**

Factory Setting: 90

Settings 0 to 200%

It is used to adjust the output voltage of flux weakening curve.

For the spindle application, the adjustment method is

1. It is used to adjust the output voltage when exceeding rated frequency.
2. Monitor the output voltage
3. Adjust Pr.11-05 (motor 1) or Pr.11-06 (motor 2) setting to make the output voltage reach motor rated voltage.
4. The larger number it is set, the larger output voltage you will get.

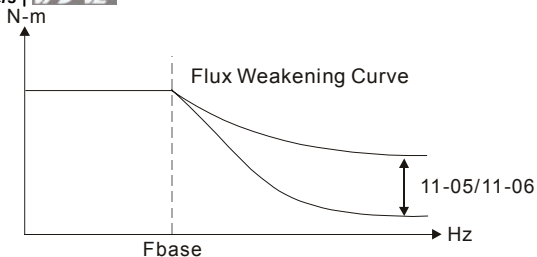

11-06 Gain Value of Flux Weakening Curve for Motor 2 Unit: 1

Control mode **FOCPG** Factory Setting: 90

Settings 0 to 200%

11-07 Detection Time for Phase-loss Unit: 0.01

Control mode **VF VFPG SVC FOCPG TQRPG** Factory Setting: 0.20

Settings 0.01 to 600.00 sec

- When the phase-loss occurs and exceeds this detection time, the fault code "PHL" will be displayed. The AC motor drive will record the operation time during phase-loss.
- When phase-loss occurs and Pr.11-07 is set to 0, it won't display PHL and won't execute Pr.06-02.
- When user sets this parameter to 0 or not factory setting, we won't promise that all characteristics will be the same as the 3-phase input.
- If it is set to 0 or a larger number, it will short the life of rectifier and capacitors in the AC motor drive.

11-08 Reserved

11-09 Level of Phase-loss Unit: 0.1

Control mode **VF VFPG SVC FOCPG TQRPG** Factory Setting: 60.0

Settings 0.0 to 320.0

11-10 Speed Feed Forward Gain Unit: 1

Control mode	FOCPG	Factory Setting: 0
Settings	0 to 100%	

11-12	✓ Speed Response of Flux Weakening Area	Unit: 1
Control mode	FOCPG	Factory Setting: 65
Settings	0 to 150% (0: disable)	

It is used to control the response speed for the flux weakening area. The larger number you set, the faster response you will get.

11-13	✓ Notch Filter Depth	Unit: 1
Control mode	FOCPG	Factory Setting: 0
Settings	0 to 20 db	

11-14	✓ Notch Filter Frequency	Unit: 0.01
Control mode	FOCPG	Factory Setting: 0.00
Settings	0.00 to 200.00	

This parameter is used to set resonance frequency of mechanical system. It can be used to suppress the resonance of mechanical system.

The larger number you set Pr.11-13, the better suppression resonance function you will get.

The notch filter frequency is the resonance of mechanical frequency.

11-15	✓ Gain Value of Slip Compensation	Unit: 0.01
Control mode	SVC	Factory Setting: 1.00
Settings	0.00 to 1.00	

It is only valid in SVC mode.

When the AC motor drive drives the asynchronous motor, slip will increase when the load is added. This parameter can be used to change frequency, lower slip and make the motor be synchronous when running under rated current. When the output current is higher than no-load current, the AC motor drive will adjust frequency by this parameter. If the actual speed is slower than expected, please increase the setting or decrease the setting.

11-16	✓ Low-pass Filter Time of Keypad Display	Unit: 0.001
Control mode	VF VFG SVC FOCPG TQRPG	Factory Setting: 0.100

 Settings 0.001 to 65.535 Sec

 It is used to lower the blinking frequency of LCD display.

11-17  Low-pass Filter Time of PG2 Pulse Input Unit: 0.001

 Control mode VF VFPG SVC FOCPG Factory Setting: 0.100

 Settings 0.000 to 65.535 Sec

11-18  APR Gain Unit: 0.01

 Control mode FOCPG Factory Setting: 10.00

 Settings 0.00 to 40.00

11-19  APR Curve Time Unit: 0.01

 Control mode FOCPG Factory Setting: 3.00

 Settings 0.00 to 655.35 sec

11-20
 | Reserved

11-28

11-29 Accumulative Operation Time of Phase-loss Unit: 1

 Control mode VF VFPG SVC FOCPG TQRPG Factory Setting: 0

 Settings 0 to 65535 (hour)

11-30
 | Reserved

11-40

This page intentionally left blank

Chapter 5 Troubleshooting

5.1 Over Current (OC)

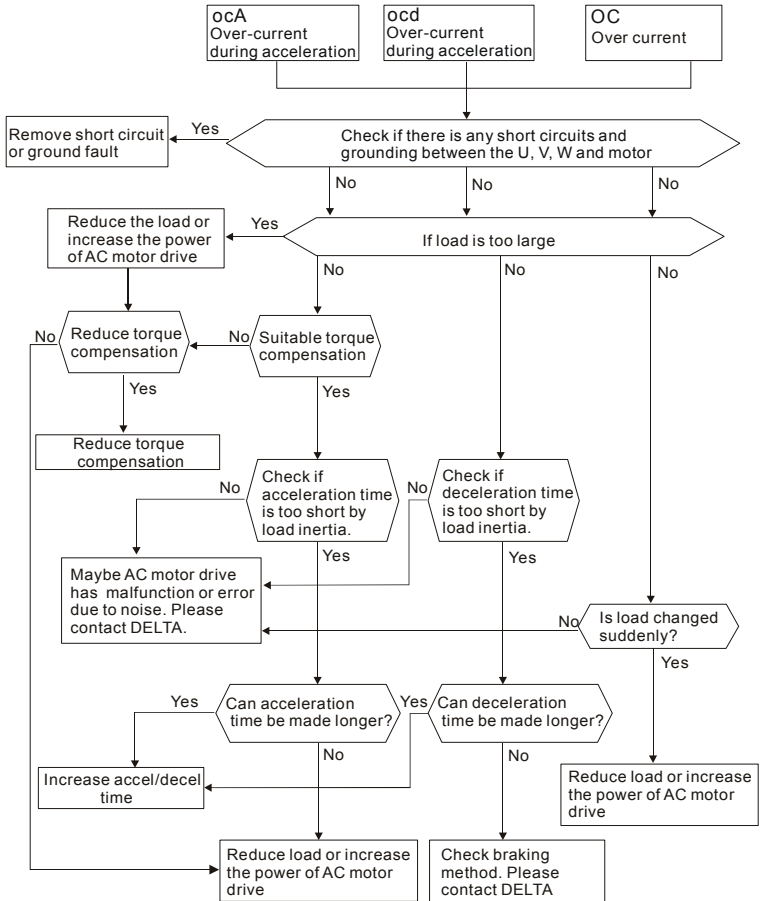

5.2 Ground Fault

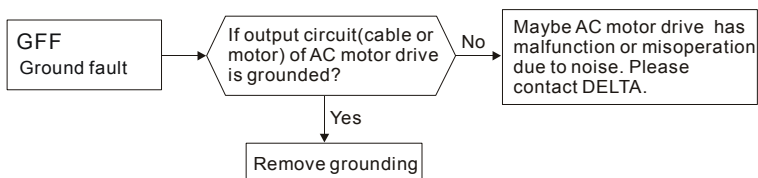

5.3 Over Voltage (OV)

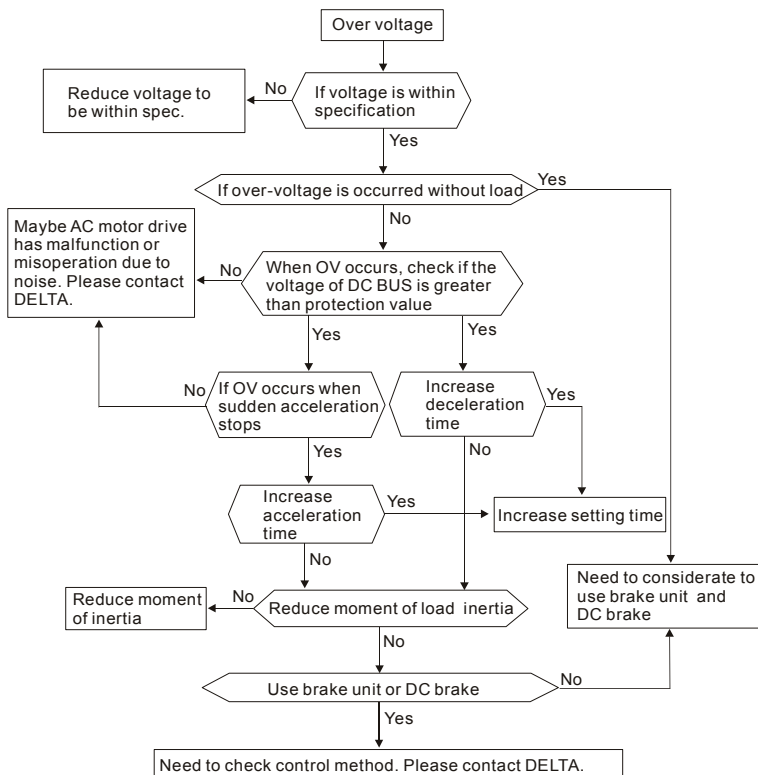

5.4 Low Voltage (Lv)

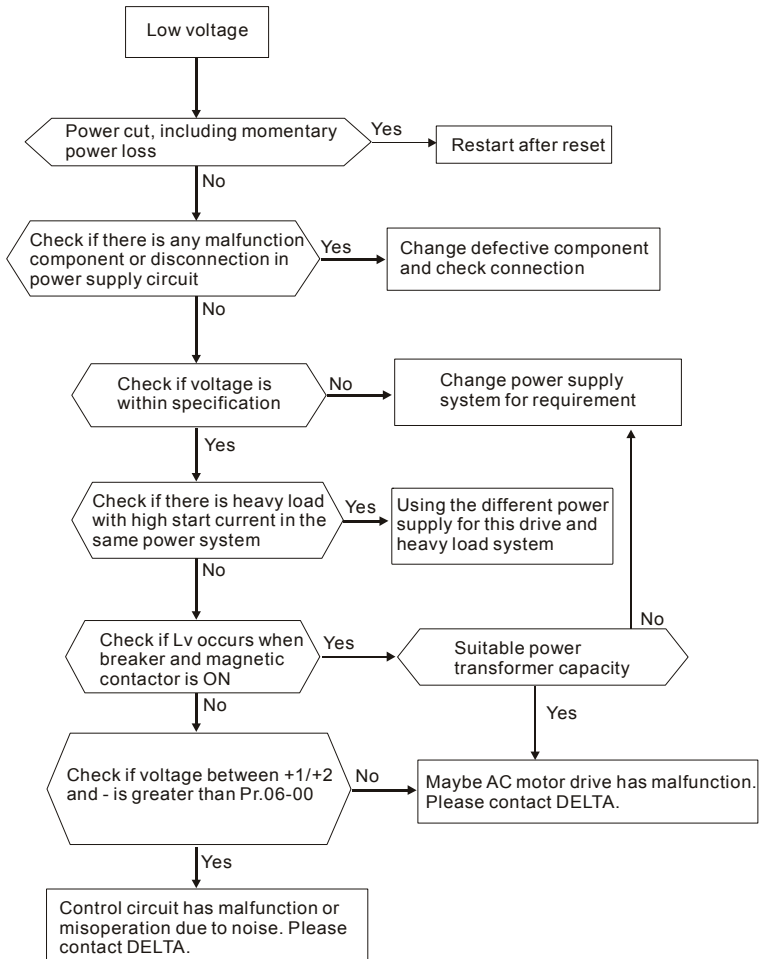

5.5 Over Heat (oH1, oH2, oH3)

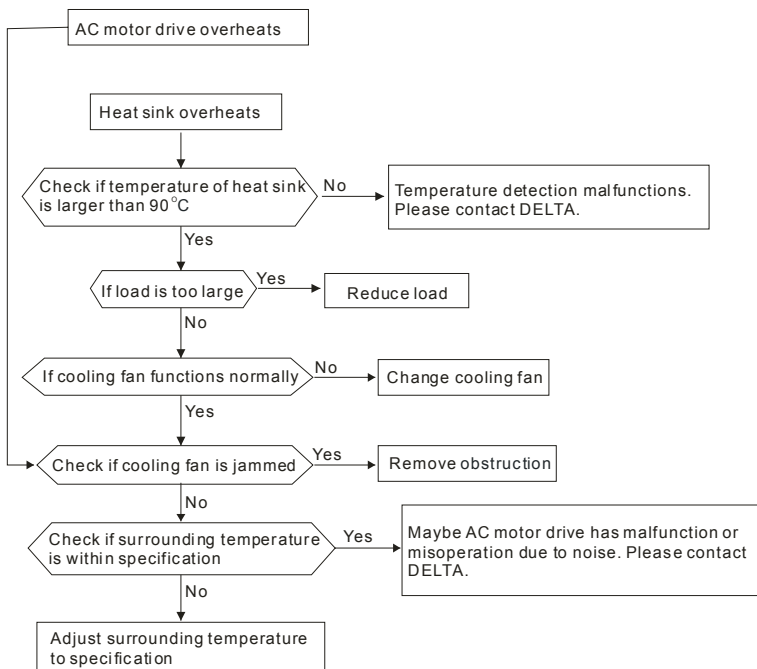

5.6 Overload

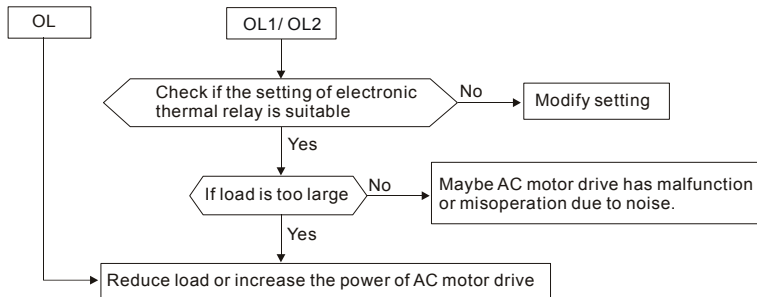

5.7 Display of KPV-CE01 is Abnormal

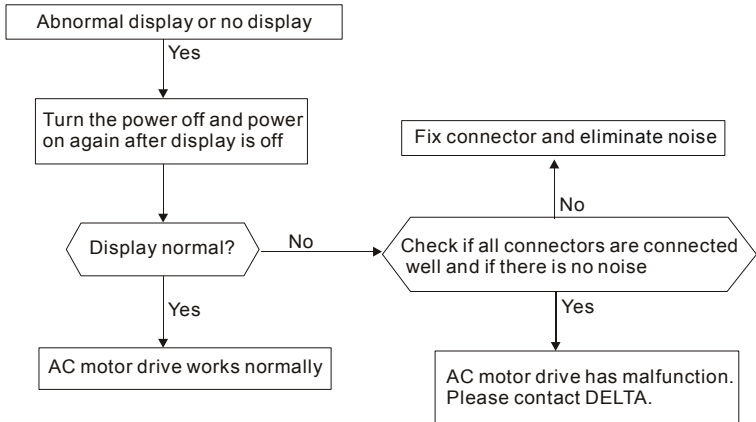

5.8 Phase Loss (PHL)

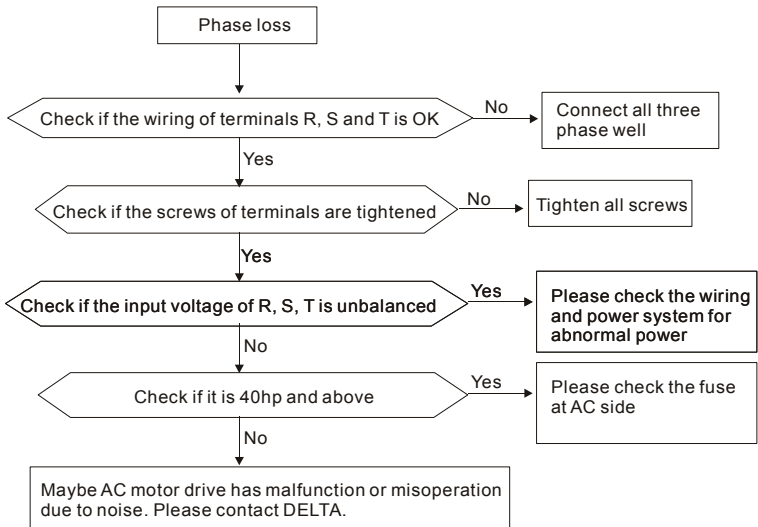

5.9 Motor cannot Run

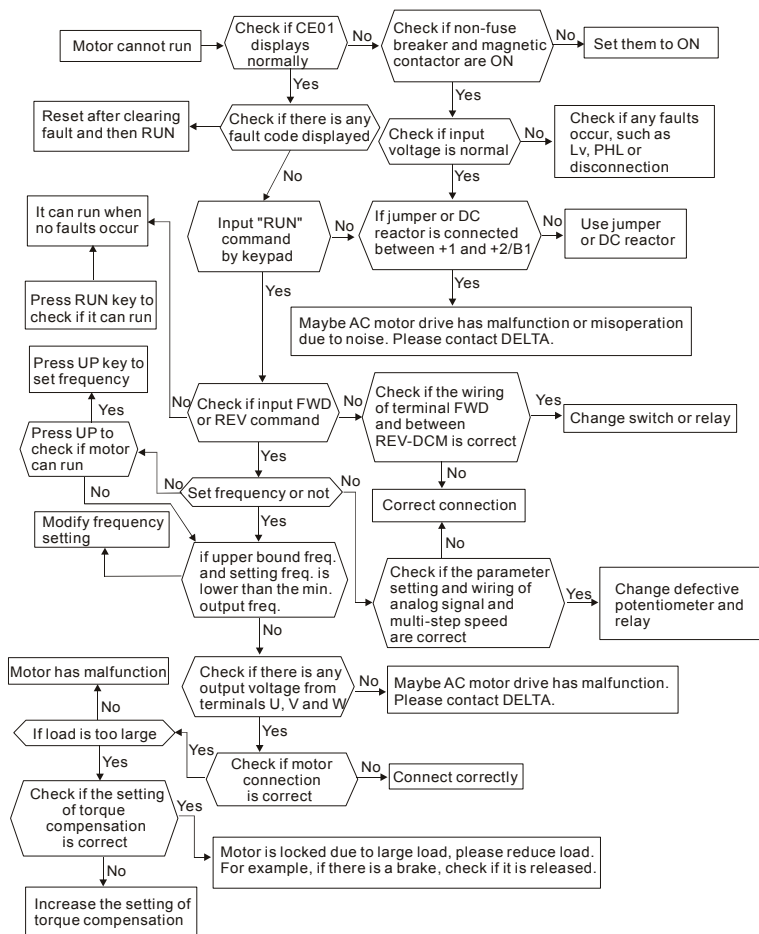

5.10 Motor Speed cannot be Changed

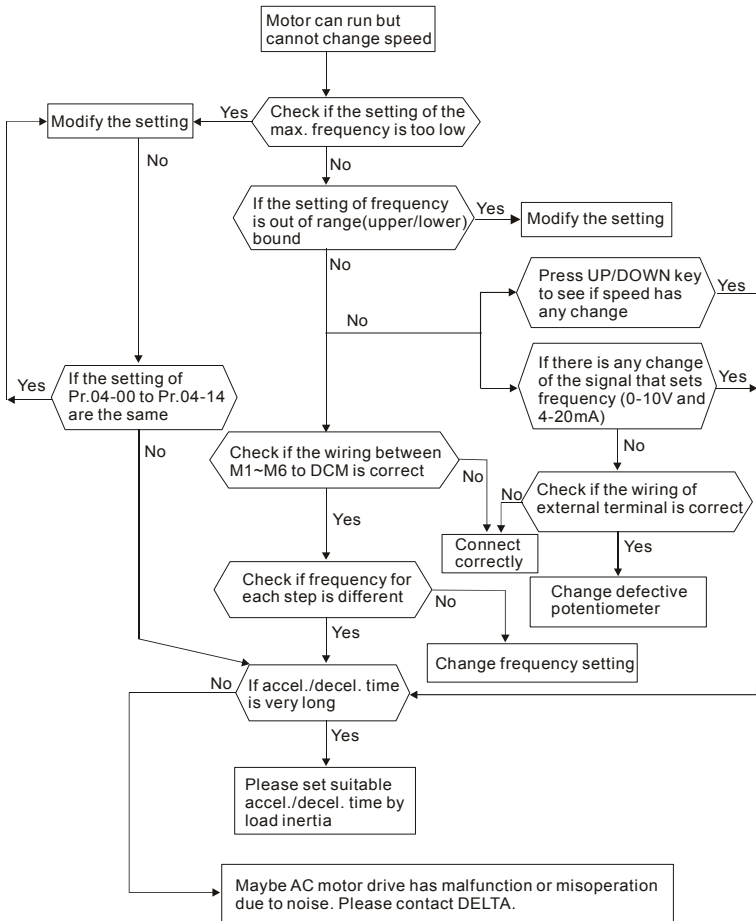

5.11 Motor Stalls during Acceleration

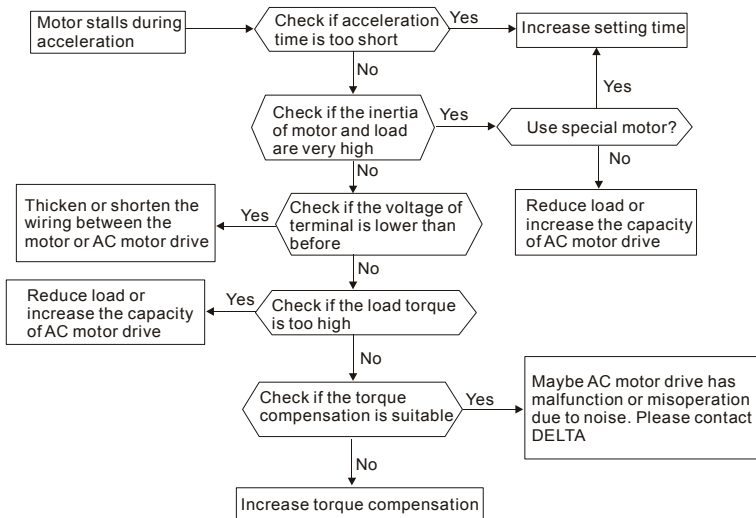

5.12 The Motor does not Run as Expected

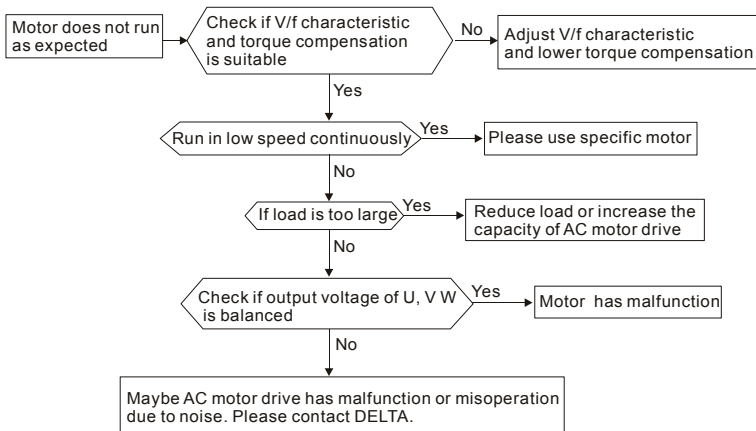

5.13 Electromagnetic/Induction Noise

There are many noises surround the AC motor drives and invade it by radiation or power circuit. It may cause the misoperation of control circuit and even damage the AC motor drive. Of course, that is a solution to increase the noise tolerance of AC motor drive. But it is not the best one due to the limit. Therefore, solve it from the outside as following will be the best.

1. Add surge killer on the relay or contact to suppress switching surge between ON/OFF.
2. Shorten the wiring length of the control circuit or serial circuit and separate from the main circuit wiring.
3. Comply with the wiring regulation for those shielded wire and use isolation amplifier for long wire.
4. The grounding terminal should comply with the local regulation and ground independently, i.e. not to have common ground with electric welding machine and power equipment.
5. Connect a noise filter at the input terminal of the AC motor drive to prevent noise from power circuit.

In a word, three-level solutions for electromagnetic noise are “no product”, “no spread” and “no receive”.

5.14 Environmental Condition

Since AC motor drive is an electronic device, you should comply with the environmental condition stated in the appendix A. Following are the remedial measures for necessary.

1. To prevent vibration, anti-vibration spacer is the last choice. The vibration tolerance must be within the specification. The vibration effect is equal to the mechanical stress and it cannot occur frequently, continuously or repeatedly to prevent damaging AC motor drive.
2. Store in a clean and dry location free from corrosive fumes/dust to prevent rustiness, poor contact. It also may cause short by low insulation in a humid location. The solution is to use both paint and dust-proof. For particular occasion, use the enclosure with whole-seal structure.
3. The surrounding temperature should be within the specification. Too high or low temperature will affect the lifetime and reliability. For semiconductor components, damage will occur once any specification is out of range. Therefore, it is necessary to clean and periodical check for the air cleaner and cooling fan besides having cooler and sunshade. In additional, the microcomputer may not work in extreme low temperature and needs to have heater.

4. Store within a relative humidity range of 0% to 90% and non-condensing environment. Do not turn off the air conditioner and have exsiccator for it.

5.15 Affecting Other Machines

AC motor drive may affect the operation of other machine due to many reasons. The solutions are as follows.

■ High Harmonic at Power Side

If there is high harmonic at power side during running, the improved methods are:

1. Separate power system: use transformer for AC motor drive.
2. Use reactor at the power input terminal of AC motor drive or decrease high harmonic by multiple circuit.
3. If there is phase lead capacitor, it should use serial reactor to prevent capacitor damage from high harmonic.

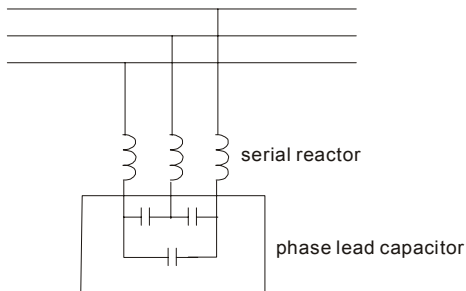

■ Motor Temperature Rises

When the motor is induction motor with ventilation-cooling-type used in variety speed operation, bad cooling will happen in the low speed. Therefore, it may overheat. Besides, high harmonic is in output waveform to increase copper loss and iron loss. Following measures should be used by load situation and operation range when necessary.

1. Use the motor with independent power ventilation or increase the horsepower.
2. Use inverter duty motor.
3. Do NOT run in the low speed

Chapter 6 Fault Code Information and Maintenance

6.1 Fault Code Information

The AC motor drive has a comprehensive fault diagnostic system that includes several different alarms and fault messages. Once a fault is detected, the corresponding protective functions will be activated. The following faults are displayed as shown on the AC motor drive digital keypad display. The six most recent faults can be read from the digital keypad or communication.



Wait 5 seconds after a fault has been cleared before performing reset via keypad or input terminal.

6.1.1 Common Problems and Solutions

Fault Name	Fault Descriptions	Corrective Actions
ocR	Over-current during acceleration (Output current exceeds triple rated current during acceleration.)	<ol style="list-style-type: none">1. Short-circuit at motor output: Check for possible poor insulation at the output lines.2. Acceleration Time too short: Increase the Acceleration Time.3. AC motor drive output power is too small: Replace the AC motor drive with the next higher power model.
ocD	Over-current during deceleration (Output current exceeds triple rated current during deceleration.)	<ol style="list-style-type: none">1. Short-circuit at motor output: Check for possible poor insulation at the output line.2. Deceleration Time too short: Increase the Deceleration Time.3. AC motor drive output power is too small: Replace the AC motor drive with the next higher power model.
ocN	Over-current during steady state operation (Output current exceeds triple rated current during constant speed.)	<ol style="list-style-type: none">1. Short-circuit at motor output: Check for possible poor insulation at the output line.2. Sudden increase in motor loading: Check for possible motor stall.3. AC motor drive output power is too small: Replace the AC motor drive with the next higher power model.
ocS	Hardware failure in current detection	Return to the factory

Fault Name	Fault Descriptions	Corrective Actions
OFF	Ground fault	<p>When (one of) the output terminal(s) is grounded, short circuit current is more than 50% of AC motor drive rated current, the AC motor drive power module may be damaged. NOTE: The short circuit protection is provided for AC motor drive protection, not for protection of the user.</p> <ol style="list-style-type: none"> 1. Check the wiring connections between the AC motor drive and motor for possible short circuits, also to ground. 2. Check whether the IGBT power module is damaged. 3. Check for possible poor insulation at the output line.
OC C	Short-circuit is detected between upper bridge and lower bridge of the IGBT module	Return to the factory
ouA	DC BUS over-voltage during acceleration (230V: DC 450V; 460V: DC 900V)	<ol style="list-style-type: none"> 1. Check if the input voltage falls within the rated AC motor drive input voltage range. 2. Check for possible voltage transients. 3. If DC BUS over-voltage due to regenerative voltage, please increase the Deceleration Time or add an optional brake resistor.
ou d	DC BUS over-voltage during deceleration (230V: DC 450V; 460V: DC 900V)	
ou n	DC BUS over-voltage in constant speed (230V: DC 450V; 460V: DC 900V)	
ou S	Hardware failure in voltage detection	Check if input voltage is within specification range and monitor if there is surge voltage.
LuA	DC BUS voltage is less than Pr.06-00 during acceleration	<ol style="list-style-type: none"> 1. Check if the input voltage is normal 2. Check for possible sudden load
Lu d	DC BUS voltage is less than Pr.06-00 during deceleration	
Lu n	DC BUS voltage is less than Pr.06-00 in constant speed	
Lu S	DC BUS voltage is less than Pr.06-00 at stop	
PHL	Phase Loss	Check Power Source Input if all 3 input phases are connected without loose contacts. For models 40hp and above, please check if the fuse for the AC input circuit is blown.

Fault Name	Fault Descriptions	Corrective Actions
OH1	IGBT overheating IGBT temperature exceeds protection level 1 to15HP: 90 °C 20 to 100HP: 100 °C	<ol style="list-style-type: none"> 1. Ensure that the ambient temperature falls within the specified temperature range. 2. Make sure that the ventilation holes are not obstructed. 3. Remove any foreign objects from the heatsinks and check for possible dirty heat sink fins. 4. Check the fan and clean it. 5. Provide enough spacing for adequate ventilation.
OH2	Heatsink overheating Heat sink temperature exceeds 90°C	<ol style="list-style-type: none"> 1. Ensure that the ambient temperature falls within the specified temperature range. 2. Make sure that the ventilation holes are not obstructed. 3. Remove any foreign objects from the heatsinks and check for possible dirty heat sink fins. 4. Check the fan and clean it. 5. Provide enough spacing for adequate ventilation.
OH3	Motor overheating The AC motor drive detects that the internal temperature exceeds Pr.06-30 (PTC level)	<ol style="list-style-type: none"> 1. Make sure that the motor is not obstructed. 2. Ensure that the ambient temperature falls within the specified temperature range. 3. Take the next higher power AC motor drive model.
EH10	OH1 hardware failure	Return to the factory
EH20	OH2 hardware failure	Return to the factory
FRn	Fan failure	<ol style="list-style-type: none"> 1. Make sure that the fan is not obstructed. 2. Return to the factory
OL	Overload The AC motor drive detects excessive drive output current. NOTE: The AC motor drive can withstand up to 150% of the rated current for a maximum of 60 seconds.	<ol style="list-style-type: none"> 1. Check whether the motor is overloaded. 2. Take the next higher power AC motor drive model.
EOL1	Motor 1 overload	<ol style="list-style-type: none"> 1. Check whether the motor 1 is overloaded. 2. Check whether the rated current of motor 1 (Pr.05-01) is suitable 3. Take the next higher power AC motor drive model.
EOL2	Motor 2 overload	<ol style="list-style-type: none"> 1. Check whether the motor 2 is overloaded. 2. Check whether the rated current of motor 2 (Pr.05-13) is suitable 3. Take the next higher power AC motor drive model.

Fault Name	Fault Descriptions	Corrective Actions
FUSE	Broken fuse The fuse at DC side is broken for 30hp and below	<ol style="list-style-type: none"> 1. Check whether the fuse of the transistor module is functioning well 2. Check whether the loading side is short-circuit
ot1	Electronic Thermal Relay 1/2 Protection These two fault codes will be displayed when output current exceeds the level of over-torque detection (Pr.06-08 or Pr.06-11) and it is set 2 or 4 in Pr.06-06 or Pr.06-09.	<ol style="list-style-type: none"> 1. Check whether the motor is overloaded. 2. Check whether motor rated current setting (Pr.05-01) is suitable 3. Check electronic thermal relay function 4. Take the next higher power AC motor drive model.
ot2		
cF1	Internal EEPROM can not be programmed.	<ol style="list-style-type: none"> 1. Press "RESET" key to the factory setting 2. Return to the factory.
cF2	Internal EEPROM can not be read.	<ol style="list-style-type: none"> 1. Press "RESET" key to the factory setting 2. Return to the factory.
cd0	Isum error	Re-power on to try it. If fault code is still displayed on the keypad please return to the factory
cd1	U-phase error	
cd2	V-phase error	
cd3	W-phase error	
Hd0	CC (current clamp)	Re-power on to try it. If fault code is still displayed on the keypad please return to the factory
Hd1	OC hardware error	
Hd2	OV hardware error	
Hd3	GFF hardware error	
RUÉ	Auto tuning error	<ol style="list-style-type: none"> 1. Check cabling between drive and motor 2. Retry again
RFÉ	PID loss (ACI)	<ol style="list-style-type: none"> 1. Check the wiring of the PID feedback 2. Check the PID parameters settings
PGF1	PG feedback error	Check if Pr.10-01 is set to 0 when it is PG feedback control
PGF2	PG feedback loss	Check the wiring of the PG feedback
PGF3	PG feedback stall	<ol style="list-style-type: none"> 1. Check the wiring of the PG feedback 2. Check if the setting of PI gain and deceleration is suitable 3. Return to the factory
PGF4	PG slip error	
PGr1	Pulse input error	<ol style="list-style-type: none"> 1. Check the pulse wiring
PGr2	Pulse input loss	<ol style="list-style-type: none"> 2. Return to the factory
RCÉ	ACI loss	<ol style="list-style-type: none"> 1. Check the ACI wiring 2. Check if the ACI signal is less than 4mA
EF	External Fault	<ol style="list-style-type: none"> 1. Input EF (N.O.) on external terminal is closed to GND. Output U, V, W will be turned off. 2. Give RESET command after fault has been cleared.

Fault Name	Fault Descriptions	Corrective Actions
E F 1	Emergency stop	<ol style="list-style-type: none"> When the multi-function input terminals MI1 to MI6 are set to emergency stop, the AC motor drive stops output U, V, W and the motor coasts to stop. Press RESET after fault has been cleared.
b b	External Base Block	<ol style="list-style-type: none"> When the external input terminal (B.B) is active, the AC motor drive output will be turned off. Deactivate the external input terminal (B.B) to operate the AC motor drive again.
P c o d e	Password is locked.	Keypad will be locked. Turn the power ON after power OFF to re-enter the correct password. See Pr.00-07 and 00-08.
c E 1	Illegal function code	Check if the function code is correct (function code must be 03, 06, 10, 63)
c E 2	Illegal data address (00H to 254H)	Check if the communication address is correct
c E 3	Illegal data value	Check if the data value exceeds max./min. value
c E 4	Data is written to read-only address	Check if the communication address is correct
c E 10	Communication time-out COM1: exceeds Pr.09-03 setting, COM2: exceeds Pr.09-07 setting	Check if the wiring for the communication is correct
c P 10	Keypad (KPV-CE01) communication time-out COM1: exceeds Pr.09-03 setting, COM2: exceeds Pr.09-07 setting	<ol style="list-style-type: none"> Check if the wiring for the communication is correct Check if there is any wrong with the keypad
b F	Brake resistor fault	If the fault code is still displayed on the keypad after pressing "RESET" key, please return to the factory.
Y d c	Y-connection/Δ-connection switch error	<ol style="list-style-type: none"> Check the wiring of the Y-connection/Δ-connection Check the parameters settings
d E b	When Pr.07-13 is not set to 0 and momentary power off or power cut, it will display dEb during accel./decel. stop.	<ol style="list-style-type: none"> Set Pr.07-13 to 0 Check if input power is stable

Fault Name	Fault Descriptions	Corrective Actions
oSL	It will be displayed when slip exceeds Pr.05-26 setting and time exceeds Pr.05-27 setting.	<ol style="list-style-type: none"> 1. Check if motor parameter is correct (please decrease the load if overload) 2. Check the settings of Pr.05-26 and Pr.05-27
bEb	It will be displayed when broken belt detection function is enabled(Pr.08-59), allowance error is higher than Pr.08-61 and detection time exceeds Pr.08-62.	<ol style="list-style-type: none"> 1. Check if the belt is broken 2. Check the settings of Pr.08-60, Pr.08-62 and Pr.08-63
tOEu	It will be displayed when the allowance error of tension PID feedback exceeds Pr.08-63 setting and allowance error detection time exceeds Pr.08-64 setting.	<ol style="list-style-type: none"> 1. Check if the PID feedback is correct 2. Check if the material is broken 3. Check the settings of Pr.08-63 and Pr.08-64

6.1.2 Reset

There are three methods to reset the AC motor drive after solving the fault:

1. Press  key on KPv-CE01.
2. Set external terminal to "RESET" (set one of Pr.02-01~Pr.02-06/ Pr.02-23~Pr.02-30 to 5) and then set to be ON.
3. Send "RESET" command by communication.

NOTE

Make sure that RUN command or signal is OFF before executing RESET to prevent damage or personal injury due to immediate operation.

6.2 Maintenance and Inspections

Modern AC motor drives are based on solid state electronics technology. Preventive maintenance is required to operate this AC motor drive in its optimal condition, and to ensure a long life. It is recommended to have a check-up of the AC motor drive performed by a qualified technician.

Daily Inspection:

Basic check-up items to detect if there were any abnormalities during operation are:

1. Whether the motors are operating as expected.
2. Whether the installation environment is abnormal.
3. Whether the cooling system is operating as expected.
4. Whether any irregular vibration or sound occurred during operation.
5. Whether the motors are overheating during operation.
6. Always check the input voltage of the AC drive with a Voltmeter.

Periodic Inspection:

Before the check-up, always turn off the AC input power and remove the cover. Wait at least 10 minutes after all display lamps have gone out, and then confirm that the capacitors have fully discharged by measuring the voltage between +1/+2 and -. The voltage between +1/+2 and - should be less than 25VDC.



DANGER!

-
1. Disconnect AC power before processing!
 2. Only qualified personnel can install, wire and maintain AC motor drives. Please take off any metal objects, such as watches and rings, before operation. And only insulated tools are allowed.
 3. Never reassemble internal components or wiring.
 4. Prevent static electricity.

Periodical Maintenance

■ Ambient environment

Check Items	Methods and Criterion	Maintenance Period		
		Daily	Half Year	One Year
Check the ambient temperature, humidity, vibration and see if there are any dust, gas, oil or water drops	Visual inspection and measurement with equipment with standard specification	○		
If there are any dangerous objects	Visual inspection	○		

■ Voltage

Check Items	Methods and Criterion	Maintenance Period		
		Daily	Half Year	One Year
Check if the voltage of main circuit and control circuit is correct	Measure with multimeter with standard specification	○		

■ Keypad

Check Items	Methods and Criterion	Maintenance Period		
		Daily	Half Year	One Year
Is the display clear for reading	Visual inspection	○		
Any missing characters	Visual inspection	○		

■ Mechanical parts

Check Items	Methods and Criterion	Maintenance Period		
		Daily	Half Year	One Year
If there is any abnormal sound or vibration	Visual and aural inspection		○	
If there are any loose screws	Tighten the screws		○	
If any part is deformed or damaged	Visual inspection		○	

Check Items	Methods and Criterion	Maintenance Period		
		Daily	Half Year	One Year
If there is any color change by overheating	Visual inspection		○	
If there is any dust or dirt	Visual inspection		○	

■ Main circuit

Check Items	Methods and Criterion	Maintenance Period		
		Daily	Half Year	One Year
If there are any loose or missing screws	Tighten or replace the screw		○	
If machine or insulator is deformed, cracked, damaged or with color change due to overheating or ageing	Visual inspection NOTE: Please ignore the color change of copper plate		○	
If there is any dust or dirt	Visual inspection		○	

■ Terminals and wiring of main circuit

Check Items	Methods and Criterion	Maintenance Period		
		Daily	Half Year	One Year
If the terminal or the plate is color change or deformation due to overheat	Visual inspection		○	
If the insulator of wiring is damaged or color change	Visual inspection		○	
If there is any damage	Visual inspection		○	

■ **DC capacity of main circuit**

Check Items	Methods and Criterion	Maintenance Period		
		Daily	Half Year	One Year
If there is any leak of liquid, color change, crack or deformation	Visual inspection	○		
Measure static capacity when required	Static capacity \geq initial value X 0.85		○	

■ **Resistor of main circuit**

Check Items	Methods and Criterion	Maintenance Period		
		Daily	Half Year	One Year
If there is any peculiar smell or insulator cracks due to overheat	Visual inspection, smell		○	
If there is any disconnection	Visual inspection or measure with multimeter after removing wiring between +1/+2 ~ - Resistor value should be within $\pm 10\%$		○	

■ **Transformer and reactor of main circuit**

Check Items	Methods and Criterion	Maintenance Period		
		Daily	Half Year	One Year
If there is any abnormal vibration or peculiar smell	Visual, aural inspection and smell		○	

■ **Magnetic contactor and relay of main circuit**

Check Items	Methods and Criterion	Maintenance Period		
		Daily	Half Year	One Year
If there are any loose screws	Visual and aural inspection	○		
If the contact works correctly	Visual inspection	○		

■ **Printed circuit board and connector of main circuit**

Check Items	Methods and Criterion	Maintenance Period		
		Daily	Half Year	One Year
If there are any loose screws and connectors	Tighten the screws and press the connectors firmly in place.		○	
If there is any peculiar smell and color change	Visual inspection		○	
If there is any crack, damage, deformation or corrosion	Visual inspection		○	
If there is any liquid is leaked or deformation in capacity	Visual inspection		○	

■ **Cooling fan of cooling system**

Check Items	Methods and Criterion	Maintenance Period		
		Daily	Half Year	One Year
If there is any abnormal sound or vibration	Visual, aural inspection and turn the fan with hand (turn off the power before operation) to see if it rotates smoothly			○
If there is any loose screw	Tighten the screw			○
If there is any color change due to overheat	Change fan			○

■ **Ventilation channel of cooling system**

Check Items	Methods and Criterion	Maintenance Period		
		Daily	Half Year	One Year
If there is any obstruction in the heat sink, air intake or air outlet	Visual inspection	○		

This page intentionally left blank

Appendix A Specifications

Voltage Class		230V Class											
Model Number VFD-XXXV		007	015	022	037	055	075	110	150	185	220	300	370
Max. Applicable Motor Output (kW)		0.75	1.5	2.2	3.7	5.5	7.5	11	15	18.5	22	30	37
Max. Applicable Motor Output (hp)		1.0	2.0	3.0	5.0	7.5	10	15	20	25	30	40	50
Output Rating	Rated Output Capacity (kVA)	1.9	2.7	4.2	6.5	9.5	13	19	25	29	34	46	55
	Rated Output Current for Constant Torque (A)	5.0	7.5	11	17	25	33	49	65	75	90	120	146
	Rated Output Current for Variable Torque (A)	6.25	9.4	13	21	31	41	61	81	93	112	150	182
	Maximum Output Voltage (V)	3-Phase Proportional to Input Voltage											
Output Frequency (Hz)		0.00-600.00 Hz											
Carrier Frequency (kHz)		15			9						6		
Input Rating	Rated Input Current (A)	6.4	9.9	15	21	25	33	52	63	68	79	106	126
	Rated Voltage/Frequency	3-phase 200-240V, 50/60Hz											
	Voltage Tolerance	± 10%(180-264 V)											
	Frequency Tolerance	± 5%(47-63 Hz)											
Cooling Method		Natural	Fan Cooled										
Weight (kg)		2.7	3.2	4.5	6.8	8	10	13	13	13	13	36	36

Voltage Class		460V Class														
Model Number VFD-XXXV		007	015	022	037	055	075	110	150	185	220	300	370	450	550	750
Max. Applicable Motor Output (kW)		0.75	1.5	2.2	3.7	5.5	7.5	11	15	18.5	22	30	37	45	55	75
Max. Applicable Motor Output (hp)		1.0	2.0	3.0	5.0	7.5	10	15	20	25	30	40	50	60	75	100
Output Rating	Rated Output Capacity (kVA)	2.3	3.2	4.2	6.3	9.9	14	18	24	29	34	46	56	69	80	100
	Rated Output Current for Constant Torque (A)	3.0	4.2	6.0	8.5	13	18	24	32	38	45	60	73	91	110	150
	Rated Output Current for Variable Torque (A)	3.8	5.3	7.5	10	16	22	30	40	47	56	75	91	113	138	188
	Maximum Output Voltage (V)	3-phase Proportional to Input Voltage														
Output Frequency (Hz)		0.00-600.00 Hz														
Carrier Frequency (kHz)		15			9						6					
Input Rating	Rated Input Current (A)	3-phase 380-480V														
	Rated Input Current (A)	4.0	5.8	7.4	9.9	12	17	25	27	35	42	56	67	87	101	122
	Rated Voltage	3-phase 380 to 480 V														
	Voltage Tolerance	± 10%(342-528 V)														
Frequency Tolerance		± 5%(47-63 Hz)														
Cooling Method		Natural	Fan Cooled													
Weight (kg)		2.7	3.2	4.5	6.8	8	10	13	13	13	13	36	36	36	50	50

Revision August 2008, 03VE, SW V2.04

General Specifications		
Control Characteristics	Control System	1 V/f curve; 2 V/f+PG; 3 SVC; 4 FOC+PG; 5 TQR+PG
	Start Torque	Starting torque is 150% at 0.5Hz and 0Hz with FOC + PG control mode
	Speed Control Range	1:100 Sensorless vector (up to 1:1000 when using PG card)
	Speed Control Resolution	$\pm 0.5\%$ Sensorless vector (up to $\pm 0.02\%$ when using PG card)
	Speed Response Ability	5Hz (up to 30Hz for vector control)
	Max. Output Frequency	0.00 to 600.00Hz
	Output Frequency Accuracy	Digital command $\pm 0.005\%$, analog command $\pm 0.5\%$
	Frequency Setting Resolution	Digital command $\pm 0.01\text{Hz}$, analog command: 1/4096(12-bit) of the max. output frequency
	Torque Limit	Max. is 200% torque current
	Torque Accuracy	$\pm 5\%$
	Accel/Decel Time	0.00 to 600.00/0.0 to 6000.0 seconds
	V/f Curve	Adjustable V/f curve using 4 independent points and square curve
	Protection Characteristics	Frequency Setting Signal
Brake Torque		About 20%
Motor Protection		Electronic thermal relay protection
Over-current Protection		The current forces 220% of the over-current protection and 300% of the rated current
Ground Leakage Current Protection		Higher than 50% X rated current
Overload Ability		Constant torque: 150% for 60 seconds, variable torque: 200% for 3 seconds
Over-voltage Protection		Over-voltage level: Vdc > 400/800V; low-voltage level: Vdc < 200/400V
Over-voltage Protection for the Input Power		Varistor (MOV)
Over-temperature Protection		Built-in temperature sensor
Compensation for the Momentary Power Loss		Up to 5 seconds for parameter setting
Environmental Conditions	Protection Level	NEMA 1/IP21
	Operation Temperature	-10°C to 40°C
	Storage Temperature	-20 °C to 60 °C
	Ambient Humidity	Below 90% RH (non-condensing)
	Vibration	9.80665m/s ² (1G) less than 20Hz, 5.88m/s ² (0.6G) at 20 to 50Hz
	Installation Location	Altitude 1,000 m or lower, keep from corrosive gasses, liquid and dust
Approvals		

Appendix B Accessories

B.1 All Brake Resistors & Brake Units Used in AC Motor Drives

Note: Please only use DELTA resistors and recommended values. Other resistors and values will void Delta's warranty. Please contact your nearest Delta representative for use of special resistors. For instance, in 460V series, 100hp/75kW, the AC motor drive needs 2 brake units with total of 16 brake resistors, so each brake unit uses 8 brake resistors. The brake unit should be at least 10 cm away from AC motor drive to avoid possible interference. Refer to the "Brake Unit Module User Manual" for further details.

Voltage	Applicable Motor		Full Load Torque Nm	Resistor value spec for each AC Motor Drive	Brake Unit Model VFDB No. of Units Used		Brake Resistors Model and No. of Units Used	Brake Torque 10%ED	Min. Equivalent Resistor Value for each AC Motor Drive	
	hp	kW								
230V Series	1	0.75	0.427	80W 200Ω			BR080W200	1	125	82Ω
	2	1.5	0.849	300W 100Ω			BR300W100	1	125	82Ω
	3	2.2	1.262	300W 100Ω			BR300W100	1	125	82Ω
	5	3.7	2.080	400W 40Ω			BR400W040	1	125	33Ω
	7.5	5.5	3.111	500W 30Ω			BR500W030	1	125	30Ω
	10	7.5	4.148	1000W 20Ω			BR1K0W020	1	125	20Ω
	15	11	6.186	2400W 13.6Ω	2015	1	BR1K2W6P8	2	125	13.6Ω
	20	15	8.248	3000W 10Ω	2015	1	BR1K5W005	2	125	10Ω
	25	18.5	10.281	4800W 8Ω	2022	1	BR1K2W008	4	125	8Ω
	30	22	12.338	4800W 6.8Ω	2022	1	BR1K2W6P8	4	125	6.8Ω
	40	30	16.497	6000W 5Ω	2015	2	BR1K5W005	4	125	5Ω
50	37	20.6	9600W 4Ω	2015	2	BR1K2W008	8	125	4Ω	
460V Series	1	0.75	0.427	80W 750Ω			BR080W750	1	125	160Ω
	2	1.5	0.849	300W 400Ω			BR300W400	1	125	160Ω
	3	2.2	1.262	300W 250Ω			BR300W250	1	125	160Ω
	5	3.7	2.080	400W 150Ω			BR400W150	1	125	130Ω
	7.5	5.5	3.111	500W 100Ω			BR500W100	1	125	91Ω
	10	7.5	4.148	1000W 75Ω			BR1K0W075	1	125	62Ω
	15	11	6.186	1000W 50Ω	4030	1	BR1K0W050	1	125	39Ω
	20	15	8.248	1500W 40Ω	4030	1	BR1K5W040	1	125	40Ω
	25	18.5	10.281	4800W 32Ω	4030	1	BR1K2W008	4	125	32Ω
	30	22	12.338	4800W 27.2Ω	4030	1	BR1K2W6P8	4	125	27.2Ω
	40	30	16.497	6000W 20Ω	4030	1	BR1K5W005	4	125	20Ω
	50	37	20.6	9600W 16Ω	4045	1	BR1K2W008	8	125	16Ω
	60	45	24.745	9600W 13.6Ω	4045	1	BR1K2W6P8	8	125	13.6Ω
75	55	31.11	12000W 10Ω	4030	2	BR1K5W005	8	125	10Ω	
100	75	42.7	19200W 6.8Ω	4045	2	BR1K2W6P8	16	125	6.8Ω	



Appendix B Accessories | VFD-VE

1. Please select the factory setting resistance value (Watt) and the duty-cycle value (ED%).
2. If damage to the drive or other equipment are due to the fact that the brake resistors and the brake modules in use are not provided by Delta, the warranty will be void.
3. Take into consideration the safety of the environment when installing the brake resistors.
4. If the minimum resistance value is to be utilized, consult local dealers for the calculation of the Watt figures.
5. Please select thermal relay trip contact to prevent resistor over load. Use the contact to switch power off to the AC motor drive!
6. When using more than 2 brake units, equivalent resistor value of parallel brake unit can't be less than the value in the column "Minimum Equivalent Resistor Value for Each AC Drive" (the right-most column in the table). An example of 575V 100HP, the min. equivalent resistor value for each AC motor drive is 12.5Ω with 2 brake units connection. Therefore, the equivalent resistor value for each brake unit should be 25Ω.
7. Please read the wiring information in the user manual of brake unit thoroughly prior to taking into operation.
8. Definition for Brake Usage ED%

Explanation: The definition of the brake usage ED(%) is for assurance of enough time for the brake unit and brake resistor to dissipate away heat generated by braking. When the brake resistor heats up, the resistance would increase with temperature, and brake torque would decrease accordingly. Suggested cycle time is one minute

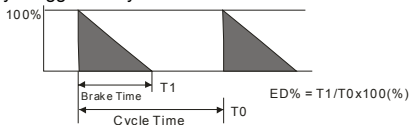

9. For safety consideration, install an overload relay between the brake unit and the brake resistor. In conjunction with the magnetic contactor (MC) prior to the drive, it can perform complete protection against abnormality. The purpose of installing the thermal overload relay is to protect the brake resistor from damage due to frequent brake, or due to brake unit keeping operating resulted from unusual high input voltage. Under such circumstance, just turn off the power to prevent damaging the brake resistor.

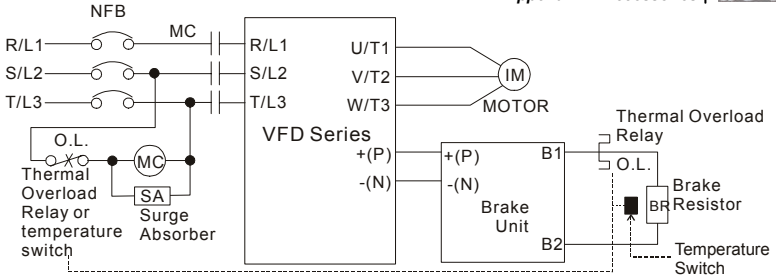

Note1: When using the AC drive with DC reactor, please refer to wiring diagram in the AC drive user manual for the wiring of terminal + (P) of Brake unit.

Note2: **Do NOT** wire terminal - (N) to the neutral point of power system.

10. For model VFD110V43B, the brake unit is built-in. To increase the brake function, it can add optional brake unit.

B.1.1 Dimensions and Weights for Brake Resistors

(Dimensions are in millimeter)

Order P/N: BR080W200, BR080W750, BR300W070, BR300W100, BR300W250, BR300W400, BR400W150, BR400W040

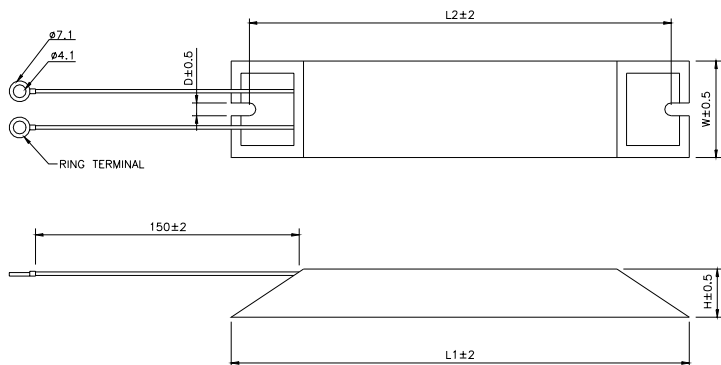

Model no.	L1	L2	H	D	W	Max. Weight (g)
BR080W200	140	125	20	5.3	60	160
BR080W750						
BR300W070	215	200	30	5.3	60	750
BR300W100						
BR300W250						
BR300W400						
BR400W150	265	250	30	5.3	60	930
BR400W040						

Order P/N: BR500W030, BR500W100, BR1KW020, BR1KW075

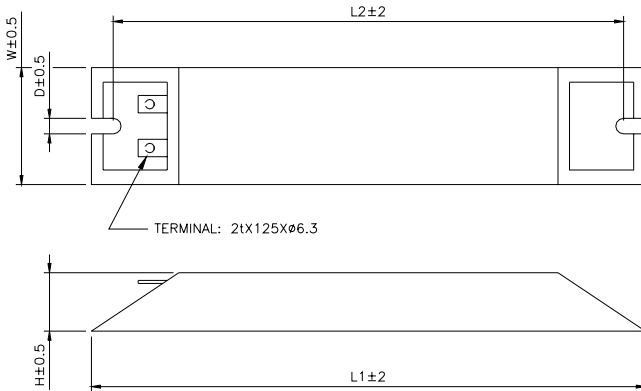

Model no.	L1	L2	H	D	W	Max. Weight (g)
BR500W030	335	320	30	5.3	60	1100
BR500W100						
BR1KW020	400	385	50	5.3	100	2800
BR1KW075						

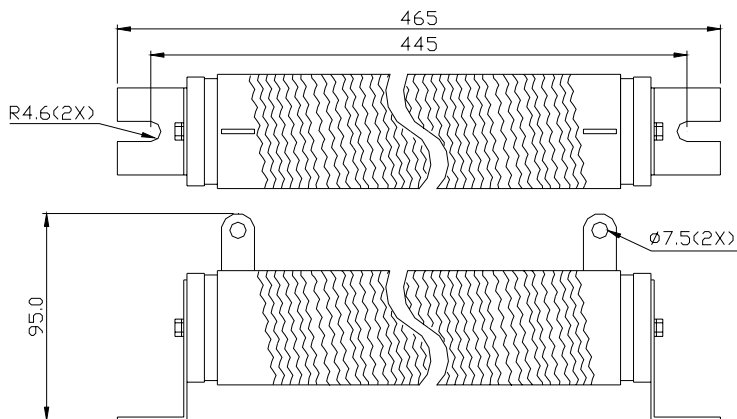

B.1.2 Specifications for Brake Unit

		230V Series		460V Series		
		2015	2022	4030	4045	4132
Max. Motor Power (kW)		15	22	30	45	132
Output Rating	Max. Peak Discharge Current (A) 10%ED	40	60	40	60	240
	Continuous Discharge Current (A)	15	20	15	18	75
	Brake Start-up Voltage (DC)	330/345/360/380/400/ 415±3V		660/690/720/760/800/83 0±6V		618/642/66 71690/725/ 750±6V
Input Rating	DC Voltage	200~400VDC		400~800VDC		
Protection	Heat Sink Overheat	Temperature over +95°C (203 °F)				
	Alarm Output	Relay contact 5A 120VAC/28VDC (RA, RB, RC)				
	Power Charge Display	Blackout until bus (+~) voltage is below 50VDC				
Environment	Installation Location	Indoor (no corrosive gases, metallic dust)				
	Operating Temperature	-10°C ~ +50°C (14°F to 122°F)				
	Storage Temperature	-20°C ~ +60°C (-4°F to 140°F)				
	Humidity	90% Non-condensing				
	Vibration	9.8m/s ² (1G) under 20Hz 2m/s ² (0.2G) at 20~50Hz				
Wall-mounted Enclosed Type		IP50			IP10	

B.1.3 Dimensions for Brake Unit

(Dimensions are in millimeter[inch])

Figure 1: VFDB2015, VFDB2022, VFDB4030, VFDB4045

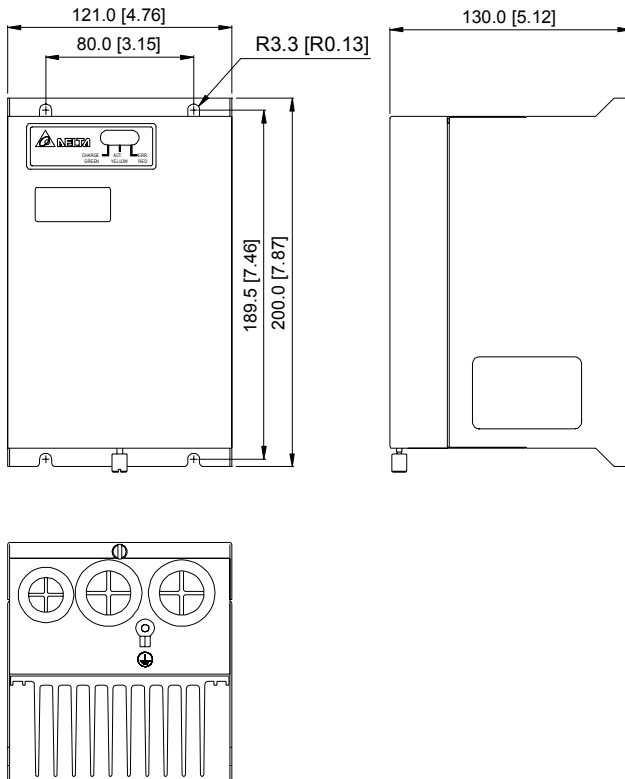
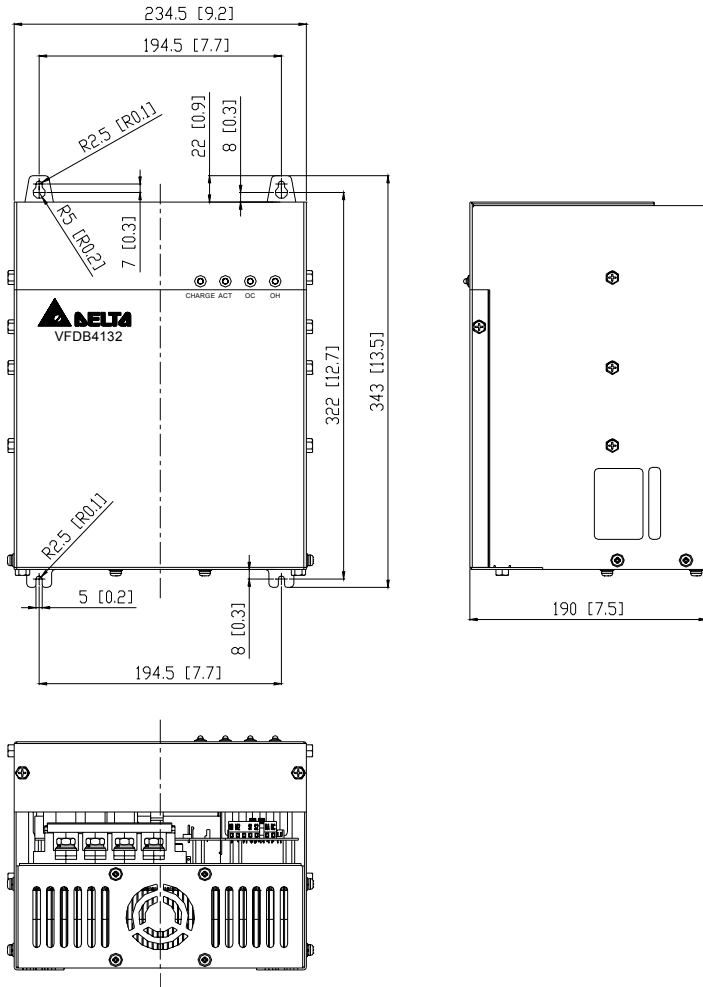

Figure 2: VFDB4132



B.2 No-fuse Circuit Breaker Chart

For 3-phase drives, the current rating of the breaker shall be within 2-4 times maximum input current rating.

(Refer to Appendix A for rated input current)

3-phase			
Model	Recommended no-fuse breaker (A)	Model	Recommended no-fuse breaker (A)
VFD007V23A-2	10	VFD110V43B-2	50
VFD007V43A-2	5	VFD150V23A-2	125
VFD015V23A-2	15	VFD150V43A-2	60
VFD015V43A-2	10	VFD185V23A-2	150
VFD022V23A-2	30	VFD185V43A-2	75
VFD022V43A-2	15	VFD220V23A-2	175
VFD037V23A-2	40	VFD220V43A-2	100
VFD037V43A-2	20	VFD300V23A-2	225
VFD055V23A-2	50	VFD300V43A-2	125
VFD055V43A-2	30	VFD370V23A-2	250
VFD075V23A-2	60	VFD370V43A-2	150
VFD075V43A-2	40	VFD450V43A-2	175
VFD110V23A-2	100	VFD550V43C-2	250
VFD110V43A-2	50	VFD750V43C-2	300

B.3 Fuse Specification Chart

Smaller fuses than those shown in the table are permitted.

Model	I (A) Input	I (A) Output	Line Fuse	
			I (A)	Bussmann P/N
VFD007V23A-2	5.7	5.0	10	JJN-10
VFD007V43A-2	3.2	2.7	5	JJN-6
VFD015V23A-2	7.6	7.0	15	JJN-15
VFD015V43A-2	4.3	4.2	10	JJN-10
VFD022V23A-2	15.5	11	30	JJN-30
VFD022V43A-2	5.9	5.5	15	JJN-15
VFD037V23A-2	20.6	17	40	JJN-40
VFD037V43A-2	11.2	8.5	20	JJN-20
VFD055V23A-2	26	25	50	JJN-50
VFD055V43A-2	14	13	30	JJN-30
VFD075V23A-2	34	33	60	JJN-60
VFD075V43A-2	19	18	40	JJN-40
VFD110V23A-2	50	49	100	JJN-100
VFD110V43A-2	25	24	50	JJN-50
VFD110V43B-2	25	24	50	JJN-50
VFD150V23A-2	60	65	125	JJN-125
VFD150V43A-2	32	32	60	JJN-60
VFD185V23A-2	75	75	150	JJN-150
VFD185V43A-2	39	38	75	JJN-70
VFD220V23A-2	90	90	175	JJN-175
VFD220V43A-2	49	45	100	JJN-100
VFD300V23A-2	110	120	225	JJN-225
VFD300V43A-2	60	60	125	JJN-125
VFD370V23A-2	142	145	250	JJN-250
VFD370V43A-2	63	73	150	JJN-150
VFD450V43A-2	90	91	175	JJN-175
VFD550V43C-2	130	110	250	JJN-250
VFD750V43C-2	160	150	300	JJN-300

B.4 AC Reactor

B.4.1 AC Input Reactor Recommended Value

460V, 50/60Hz, 3-Phase

kW	HP	Fundamental Amps	Max. continuous Amps	Inductance (mH)	
				3% impedance	5% impedance
0.75	1	4	6	9	12
1.5	2	4	6	6.5	9
2.2	3	8	12	5	7.5
3.7	5	8	12	3	5
5.5	7.5	12	18	2.5	4.2
7.5	10	18	27	1.5	2.5
11	15	25	37.5	1.2	2
15	20	35	52.5	0.8	1.2
18.5	25	35	52.5	0.8	1.2
22	30	45	67.5	0.7	1.2
30	40	55	82.5	0.5	0.85
37	50	80	120	0.4	0.7
45	60	80	120	0.4	0.7
55	75	100	150	0.3	0.45
75	100	130	195	0.2	0.3

B.4.2 AC Output Reactor Recommended Value

230V, 50/60Hz, 3-Phase

kW	HP	Fundamental Amps	Max. continuous Amps	Inductance (mH)	
				3% impedance	5% impedance
0.75	1	8	12	3	5
1.5	2	8	12	1.5	3
2.2	3	12	18	1.25	2.5
3.7	5	18	27	0.8	1.5
5.5	7.5	25	37.5	0.5	1.2
7.5	10	35	52.5	0.4	0.8
11	15	55	82.5	0.25	0.5
15	20	80	120	0.2	0.4

kW	HP	Fundamental Amps	Max. continuous Amps	Inductance (mH)	
				3% impedance	5% impedance
18.5	25	80	120	0.2	0.4
22	30	100	150	0.15	0.3
30	40	130	195	0.1	0.2
37	50	160	240	0.075	0.15

460V, 50/60Hz, 3-Phase

kW	HP	Fundamental Amps	Max. continuous Amps	Inductance (mH)	
				3% impedance	5% impedance
0.75	1	4	6	9	12
1.5	2	4	6	6.5	9
2.2	3	8	12	5	7.5
3.7	5	12	18	2.5	4.2
5.5	7.5	18	27	1.5	2.5
7.5	10	18	27	1.5	2.5
11	15	25	37.5	1.2	2
15	20	35	52.5	0.8	1.2
18.5	25	45	67.5	0.7	1.2
22	30	45	67.5	0.7	1.2
30	40	80	120	0.4	0.7
37	50	80	120	0.4	0.7
45	60	100	150	0.3	0.45
55	75	130	195	0.2	0.3
75	100	160	240	0.15	0.23

B.4.3 Applications for AC Reactor

Connected in input circuit

Application 1	Question
When more than one AC motor drive is connected to the same power, one of them is ON during operation.	When applying to one of the AC motor drive, the charge current of capacity may cause voltage ripple. The AC motor drive may damage when over current occurs during operation.

Correct wiring

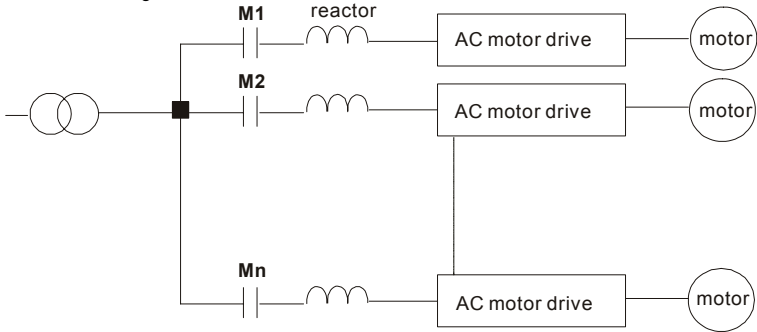

Application 2	Question
Silicon rectifier and AC motor drive is connected to the same power.	Surges will be generated at the instant of silicon rectifier switching on/off. These surges may damage the mains circuit.

Correct wiring

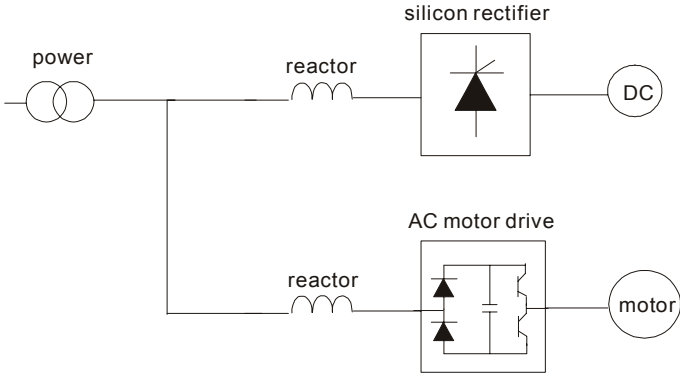

Application 3	Question
<p>Used to improve the input power factor, to reduce harmonics and provide protection from AC line disturbances (surges, switching spikes, short interruptions, etc.). AC line reactor should be installed when the power supply capacity is 500kVA or more and exceeds 6 times the inverter capacity, or the mains wiring distance $\leq 10\text{m}$.</p>	<p>When power capacity is too large, line impedance will be small and the charge current will be too large. That may damage AC motor drive due to higher rectifier temperature.</p>

Correct wiring

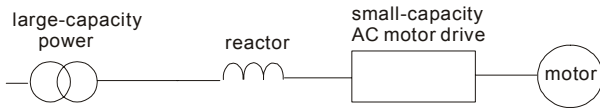

B.5 Zero Phase Reactor (RF220X00A)

Dimensions are in millimeter and (inch)

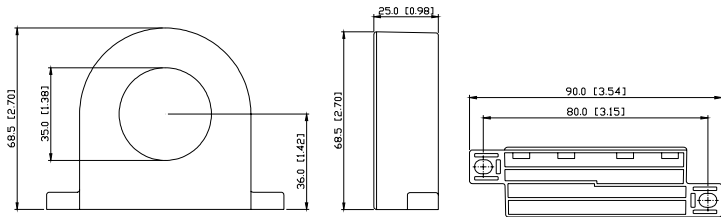

Cable type (Note)	Recommended Wire Size			Qty.	Wiring Method
	AWG	mm ²	Nominal (mm ²)		
Single-core	≤ 10	≤ 5.3	≤ 5.5	1	Diagram A
	≤ 2	≤ 33.6	≤ 38	4	Diagram B
Three-core	≤ 12	≤ 3.3	≤ 3.5	1	Diagram A
	≤ 1	≤ 42.4	≤ 50	4	Diagram B

Note: 600V Insulated unshielded Cable.

Diagram A

Please wind each wire 4 times around the core. The reactor must be put at inverter output as close as possible.

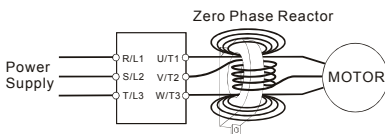
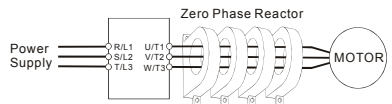

Diagram B

Please put all wires through 4 cores in series without winding.



Note 1: The table above gives approximate wire size for the zero phase reactors but the selection is ultimately governed by the type and diameter of cable fitted i.e. the cable must fit through the center hole of zero phase reactors.

Note 2: Only the phase conductors should pass through, not the earth core or screen.

Note 3: When long motor output cables are used an output zero phase reactor may be required to reduce radiated emissions from the cable.

B.6 DC Choke Recommended Values

230V DC Choke

Input voltage	kW	HP	DC Amps	Inductance (mh)
230Vac 50/60Hz 3-Phase	0.75	1	9	7.50
	1.5	2	12	4.00
	2.2	3	18	2.75
	3.7	5	25	1.75
	5.5	7.5	32	0.85
	7.5	10	40	0.75
	11	15	62	Built-in
	15	20	92	Built-in
	18.5	25	110	Built-in
	22	30	125	Built-in
	30	40	--	Built-in
	37	50	--	Built-in

460V DC Choke

Input voltage	kW	HP	DC Amps	Inductance (mh)
460Vac 50/60Hz 3-Phase	0.75	1	4	25.00
	1.5	2	9	11.50
	2.2	3	9	11.50
	3.7	5	12	6.00
	5.5	7.5	18	3.75
	7.5	10	25	4.00
	11	15	32	Built-in
	15	20	50	Built-in
	18.5	25	62	Built-in
	22	30	80	Built-in
	30	40	92	Built-in
	37	50	110	Built-in
	45	60	125	Built-in
	55	75	200	Built-in
	75	100	240	Built-in

B.7 Remote Controller RC-01

Dimensions are in millimeter

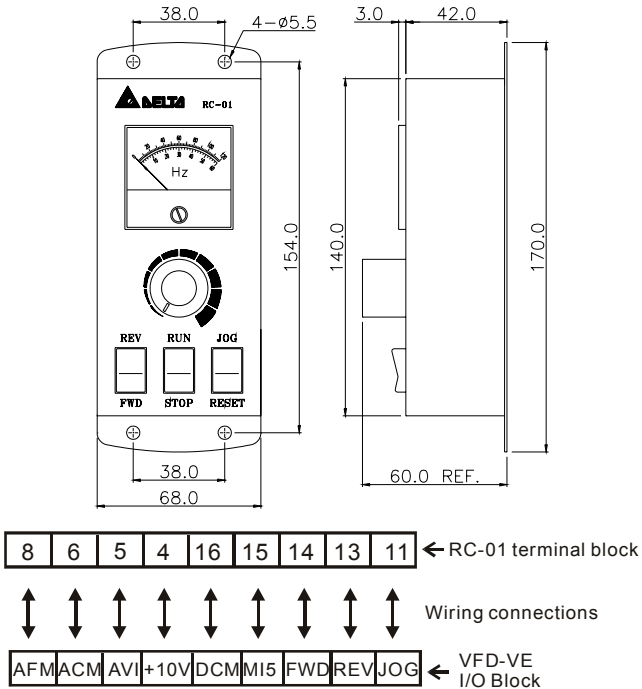

VFD-VE Programming:

Pr.00-20 set to 2

Pr.00-21 set to 1 (external controls)

Pr.02-00 set to 1 (setting Run/Stop and Fwd/Rev controls)

Pr.02-05 (MI5) set to 5 (External reset)

B.8 PG Card (for Encoder)

B.8.1 EMV-PG01X

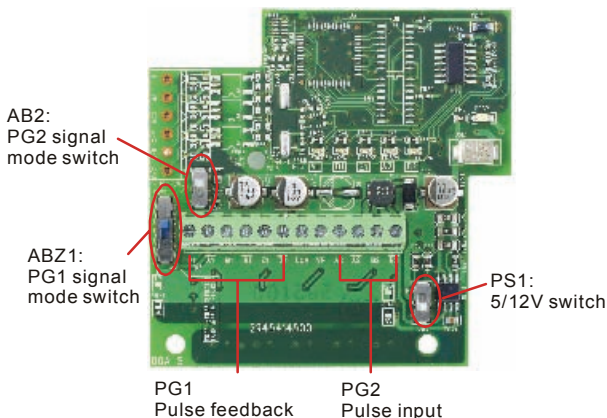

1. Terminals descriptions

Terminal Symbols	Descriptions
VP	Power source of EMV-PG01X (use PS1 to switch 12V/5V) Output Voltage: +5V/+12V±5% 200mA
DCM	Power source and input signal common
A1, $\overline{A1}$ B1, $\overline{B1}$ Z1, $\overline{Z1}$	Input signal. Input type is selected by ABZ1. It can be 1-phase or 2-phase input. Maximum 300kP/sec
A2, $\overline{A2}$ B2, $\overline{B2}$	Input signal. Input type is selected by AB2. It can be 1-phase or 2-phase input. Maximum 300kP/sec
\oplus	Grounding

2. Wiring Notes

- a. Please use a shielded cable to prevent interference. Do not run control wires parallel to any high voltage AC power line (200 V and above).
- b. Recommended wire size 0.21 to 0.81mm² (AWG24 to AWG18).

3. Wire length (wire length and signal frequency are in inverse proportion)

Types of Pulse Generators	Maximum Wire Length	Wire Gauge
Output Voltage	50m	1.25mm ² (AWG16) or above
Open Collector	50m	
Line Driver	300m	
Complementary	70m	

4. Basic Wiring Diagram

wiring 1

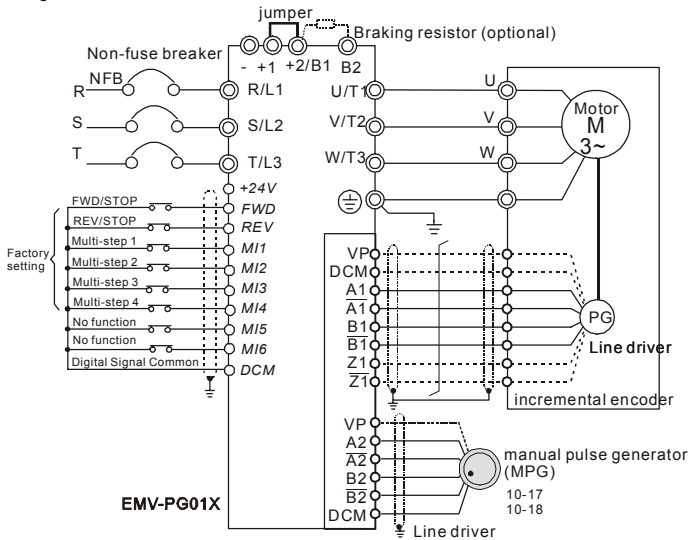



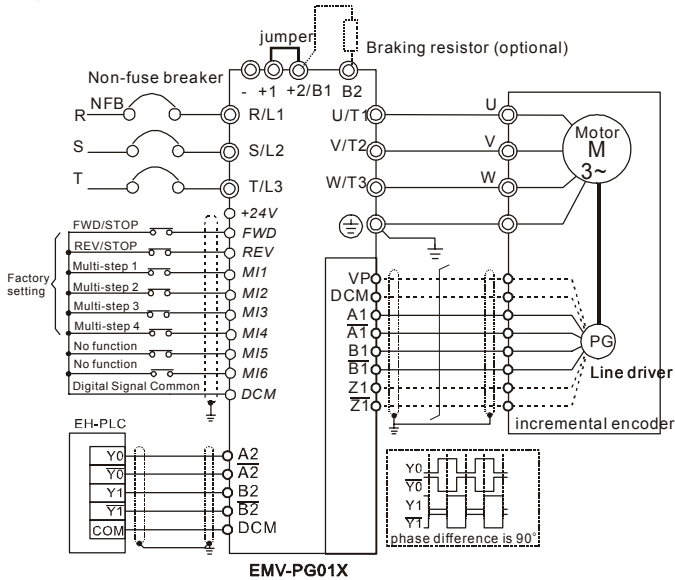



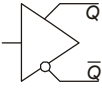

wiring 2

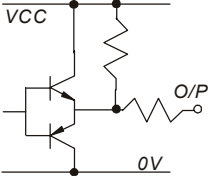

5. Types of Pulse Generators (Encoders)

Types of Pulse Generators	ABZ1+ PS1		AB2+PS1	
	5V	12V	5V	12V
<p>VOLTAGE</p>				
<p>Open collector</p>				

Types of Pulse Generators	ABZ1+ PS1		AB2+PS1	
	5V	12V	5V	12V
<p>Line driver</p> 				
<p>Complementary</p> 				

B.8.2 EMV-PG010

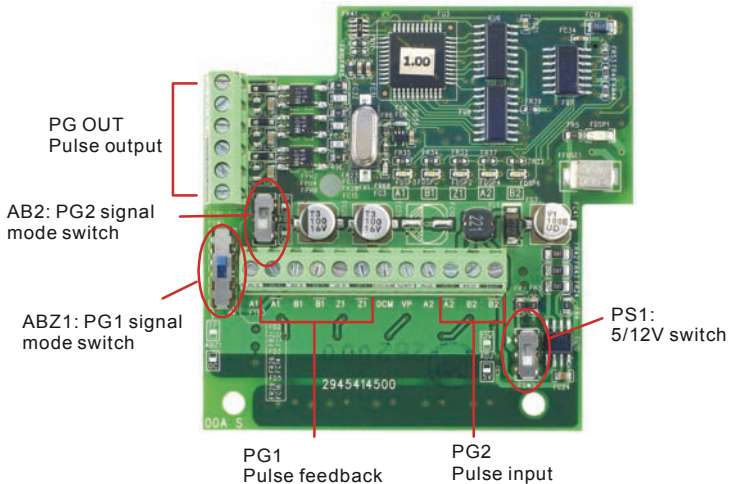

1. Terminals descriptions

Terminal Symbols	Descriptions
VP	Power source of EMV-PG010 (use PS1 to switch 12V/5V) Output Voltage: +5V/+12V±5% 200mA

Terminal Symbols	Descriptions
DCM	Power source and input signal common
A1, $\overline{A1}$ B1, $\overline{B1}$ Z1, $\overline{Z1}$	Input signal from encoder. Input type is selected by ABZ1. It can be 1-phase or 2-phase input. Maximum 300kP/sec
A2, $\overline{A2}$ B2, $\overline{B2}$	Input signal from encoder. Input type is selected by AB2. It can be 1-phase or 2-phase input. Maximum 300kP/sec
A/O, B/O, Z/O	Output signal. It has division frequency function (Pr.10-16), open collector: max. output DC20V 50mA
⊕	Grounding

2. Wiring Notes

- Please use a shielded cable to prevent interference. Do not run control wires parallel to any high voltage AC power line (200 V and above).
- Recommended wire size 0.21 to 0.81mm² (AWG24 to AWG18).

3. Wire length: (wire length and signal frequency are in inverse proportion)

Types of Pulse Generators	Maximum Wire Length	Wire Gauge
Output Voltage	50m	1.25mm ² (AWG16) or above
Open Collector	50m	
Line Driver	300m	
Complementary	70m	

4. Basic Wiring Diagram

wiring 1

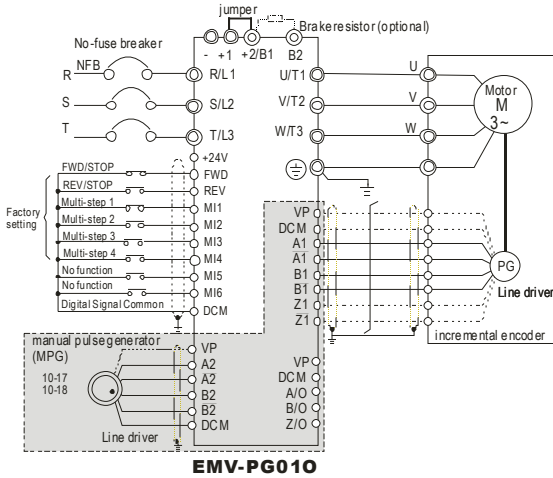

wiring 2

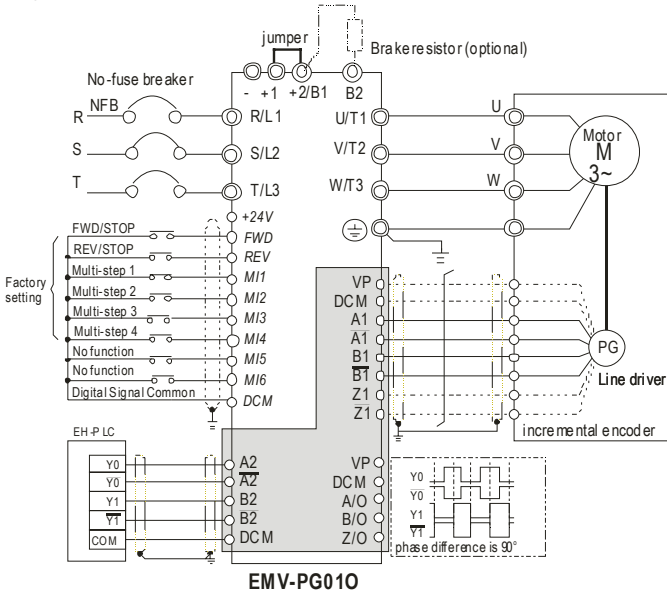

5. Types of Pulse Generators (Encoders)

Types of Pulse Generators	ABZ1+PS1		AB2+PS1	
	5V	12V	5V	12V
<p>VOLTAGE</p>				
<p>Open collector</p>				
<p>Line driver</p>				
<p>Complementary</p>				

B.8.3 EMV-PG01L

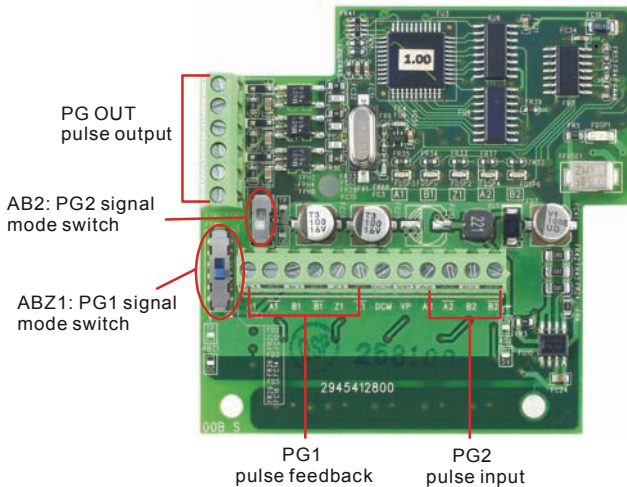

1. Terminals descriptions

Terminal Symbols	Descriptions
VP	Power source of EMV-PG01L Output Voltage: +5V±5% 200mA
DCM	Power source and input signal common
A1, $\overline{A1}$ B1, $\overline{B1}$ Z1, $\overline{Z1}$	Input signal. Input type is selected by ABZ1. It can be 1-phase or 2-phase input. Maximum 300kP/sec
A2, $\overline{A2}$ B2, $\overline{B2}$	Input signal. Input type is selected by AB2. It can be 1-phase or 2-phase input. Maximum 300kP/sec
A/O, B/O, Z/O	Output signal. It has division frequency function (Pr.10-16), Line driver: max. output DC5V 50mA
⊕	Grounding

2. Wiring Notes

- a. Please use a shielded cable to prevent interference. Do not run control wires parallel to any high voltage AC power line (200 V and above).

b. Recommended wire size 0.21 to 0.81mm² (AWG24 to AWG18).

3. Wire length: (wire length and signal frequency are in inverse proportion)

Types of Pulse Generators	Maximum Wire Length	Wire Gauge
Output Voltage	50m	1.25mm ² (AWG16) or above
Open Collector	50m	
Line Driver	300m	
Complementary	70m	

4. Basic Wiring Diagram

wiring 1

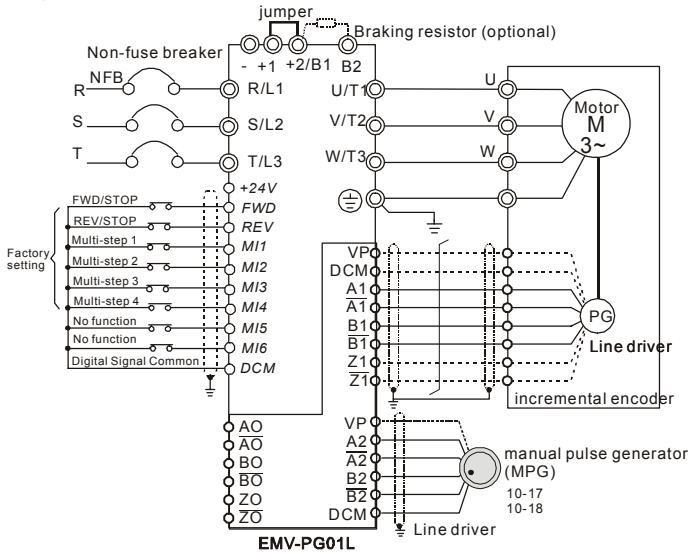



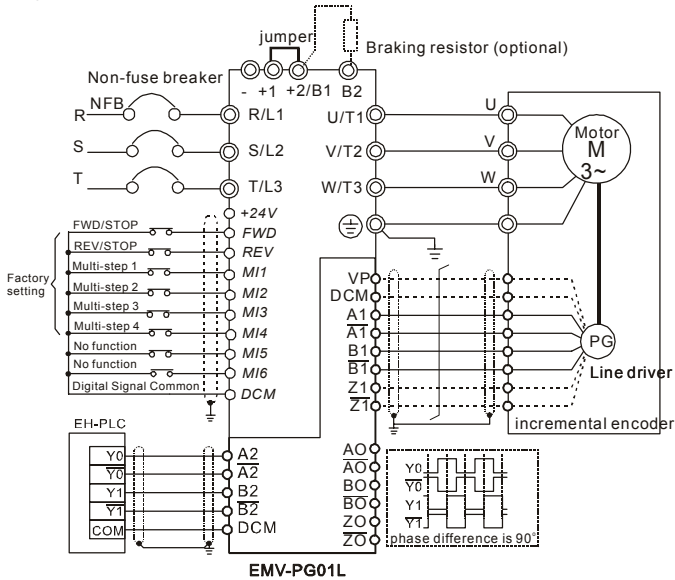

wiring 2

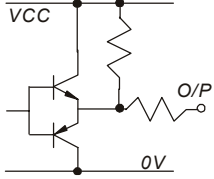

5. Types of Pulse Generators (Encoders)

Types of Pulse Generators	ABZ1	AB2
	5V	5V
<p>VOLTAGE</p>		
<p>Open collector</p>		

Types of Pulse Generators	ABZ1	AB2
	5V	5V
<p>Line driver</p> 		
<p>Complementary</p> 		

B.9 AMD-EMI Filter Cross Reference

AC Drives	Model Number	FootPrint
VFD007V43A-2, VFD015V43A-2, VFD022V43A-2	RF022B43AA	Y
VFD037V43A-2	RF037B43BA	Y
VFD055V43A-2, VFD075V43A-2, VFD110V43A-2, VFD110V43B-2	RF110B43CA	Y
VFD007V23A-2, VFD015V23A-2	10TDT1W4C	N
VFD022V23A-2, VFD037V23A-2	26TDT1W4C	N
VFD055V23A-2, VFD075V23A-2, VFD150V43A-2, VFD185V43A-2	50TDS4W4C	N
VFD110V23A-2, VFD150V23A-2, VFD220V43A-2, VFD300V43A-2, VFD370V43A-2	100TDS84C	N
VFD550V43A-2, VFD750V43A-2, VFD550V43C-2, VFD750V43C-2	200TDDS84C	N
VFD185V23A-2, VFD220V23A-2, VFD300V23A-2, VFD450V43A-2	150TDS84C	N
VFD370V23A-2	180TDS84C	N

Installation

All electrical equipment, including AC motor drives, will generate high-frequency/low-frequency noise and will interfere with peripheral equipment by radiation or conduction when in operation. By using an EMI filter with correct installation, much interference can be eliminated. It is recommended to use DELTA EMI filter to have the best interference elimination performance.

We assure that it can comply with following rules when AC motor drive and EMI filter are installed and wired according to user manual:

- **EN61000-6-4**
- **EN61800-3: 1996 + A11: 2000**
- **EN55011 (1991) Class A Group 1 (1st Environment, restricted distribution)**

General precaution

1. EMI filter and AC motor drive should be installed on the same metal plate.
2. Please install AC motor drive on footprint EMI filter or install EMI filter as close as possible to the AC motor drive.
3. Please wire as short as possible.
4. Metal plate should be grounded.

5. The cover of EMI filter and AC motor drive or grounding should be fixed on the metal plate and the contact area should be as large as possible.

Choose suitable motor cable and precautions

Improper installation and choice of motor cable will affect the performance of EMI filter. Be sure to observe the following precautions when selecting motor cable.

1. Use the cable with shielding (double shielding is the best).
2. The shielding on both ends of the motor cable should be grounded with the minimum length and maximum contact area.
3. Remove any paint on metal saddle for good ground contact with the plate and shielding.

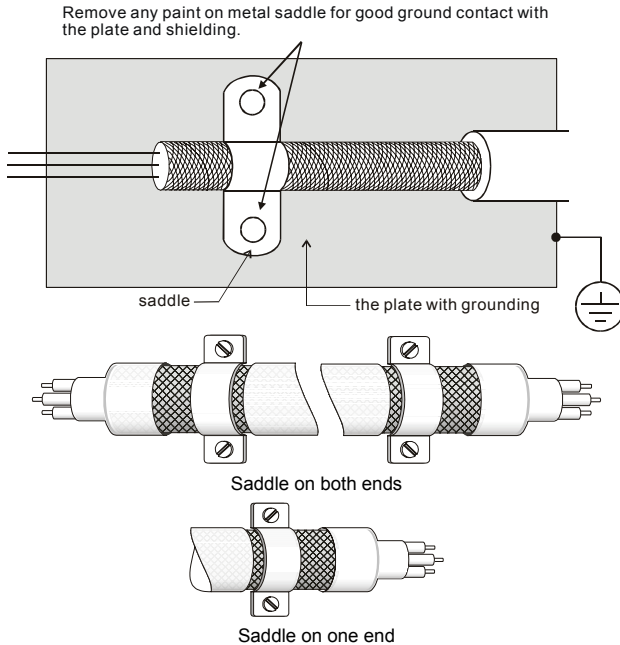

The length of motor cable

When motor is driven by an AC motor drive of PWM type, the motor terminals will experience surge voltages easily due to components conversion of AC motor drive and cable capacitance. When the motor cable is very long (especially for the 460V series), surge voltages may reduce insulation quality. To prevent this situation, please follow the rules below:

- Use a motor with enhanced insulation.
- Connect an output reactor (optional) to the output terminals of the AC motor drive
- The length of the cable between AC motor drive and motor should be as short as possible (10 to 20 m or less)
- For models 7.5hp/5.5kW and above:

Insulation level of motor	1000V	1300V	1600V
460VAC input voltage	66 ft (20m)	328 ft (100m)	1312 ft (400m)
230VAC input voltage	1312 ft (400m)	1312 ft (400m)	1312 ft (400m)

- For models 5hp/3.7kW and less:

Insulation level of motor	1000V	1300V	1600V
460VAC input voltage	66 ft (20m)	165 ft (50m)	165 ft (50m)
230VAC input voltage	328 ft (100m)	328 ft (100m)	328 ft (100m)

 **NOTE**

When a thermal O/L relay protected by motor is used between AC motor drive and motor, it may malfunction (especially for 460V series), even if the length of motor cable is only 165 ft (50m) or less. To prevent it, please use AC reactor and/or lower the carrier frequency (Pr. 00-17 PWM carrier frequency).

 **NOTE**

Never connect phase lead capacitors or surge absorbers to the output terminals of the AC motor drive.

- If the length is too long, the stray capacitance between cables will increase and may cause leakage current. It will activate the protection of over current, increase leakage current or not insure the correction of current display. The worst case is that AC motor drive may damage.
- If more than one motor is connected to the AC motor drive, the total wiring length is the sum of the wiring length from AC motor drive to each motor.

B.9.1 Dimensions

Dimensions are in millimeter and (inch)
Order P/N: RF015B21AA / RF022B43AA

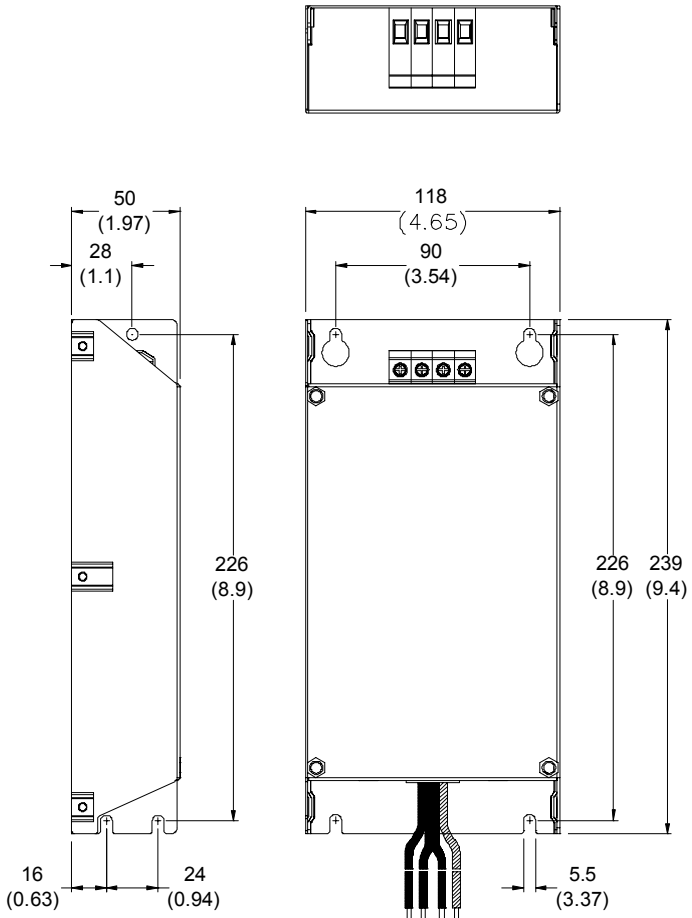

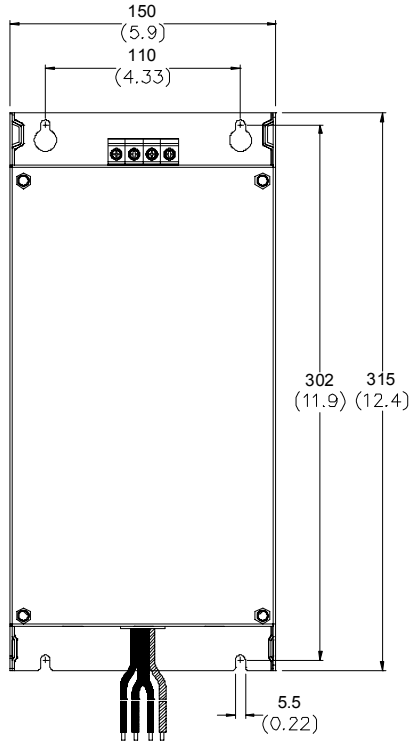
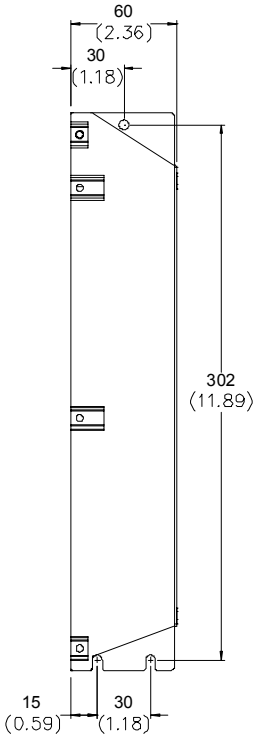
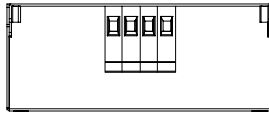

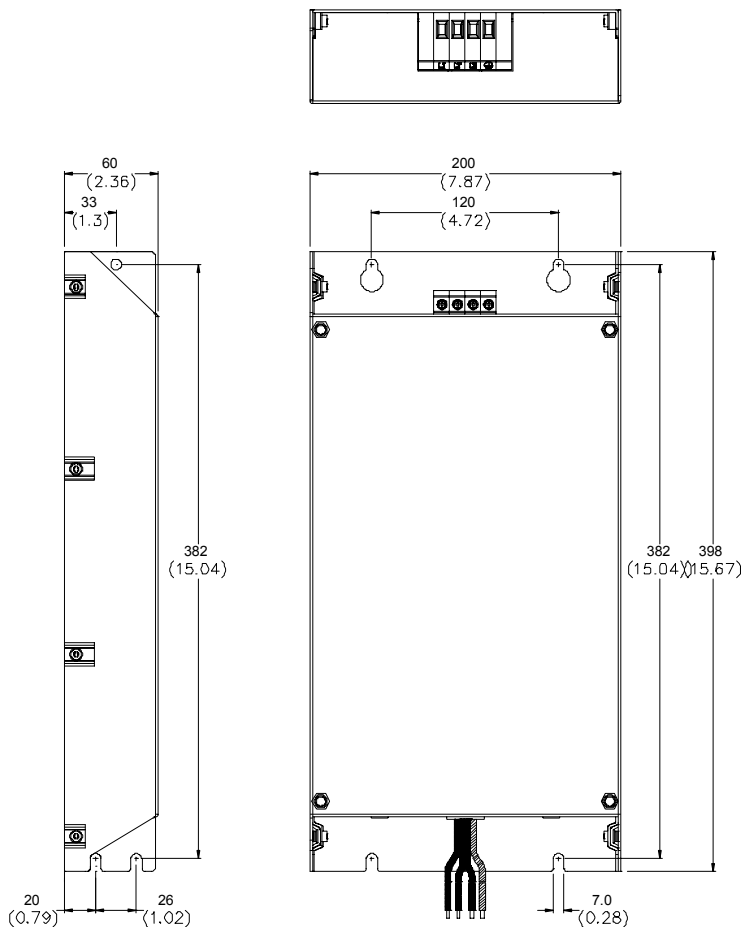

Order P/N: 10TDT1W4C

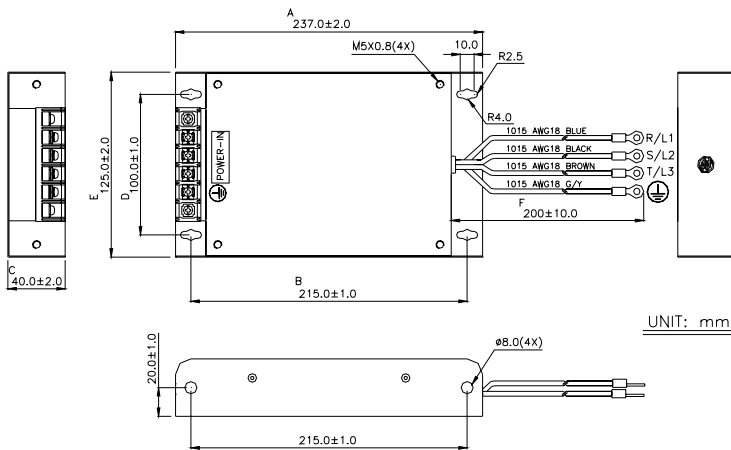

Order P/N: 26TDT1W4C

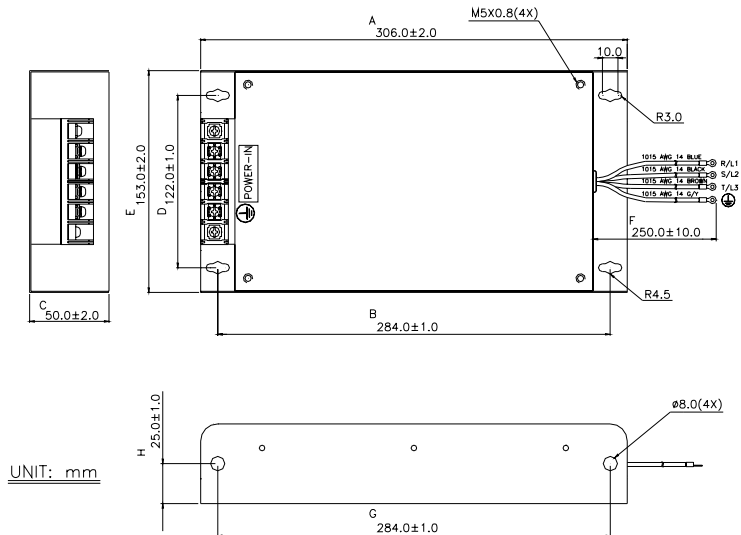

Order P/N: 50TDS4W4C

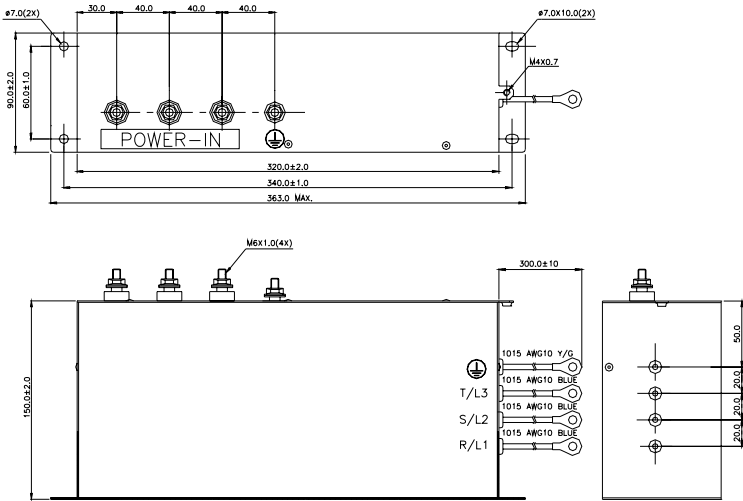

Order P/N: 100TDS84C

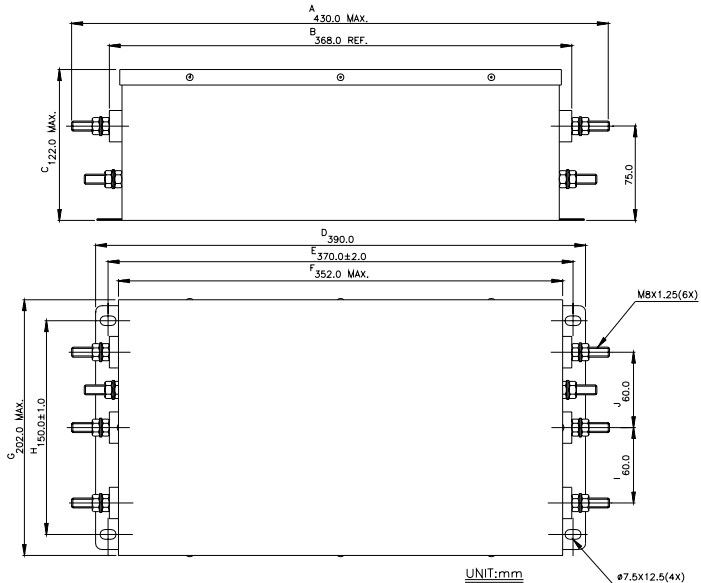

Order P/N: 200TDDS84C

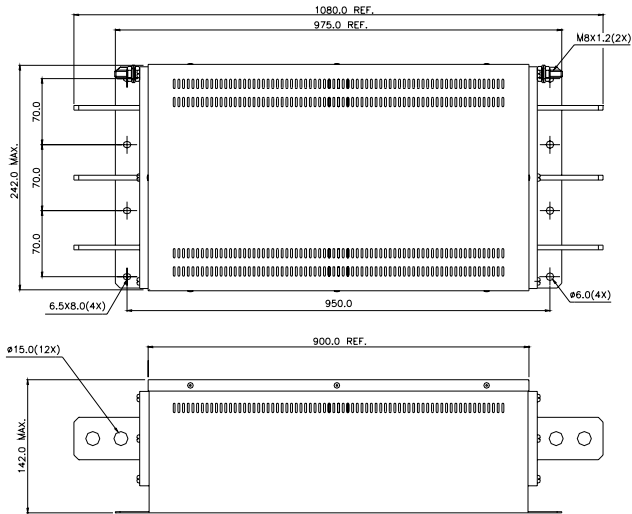

Order P/N: 150TDS84C

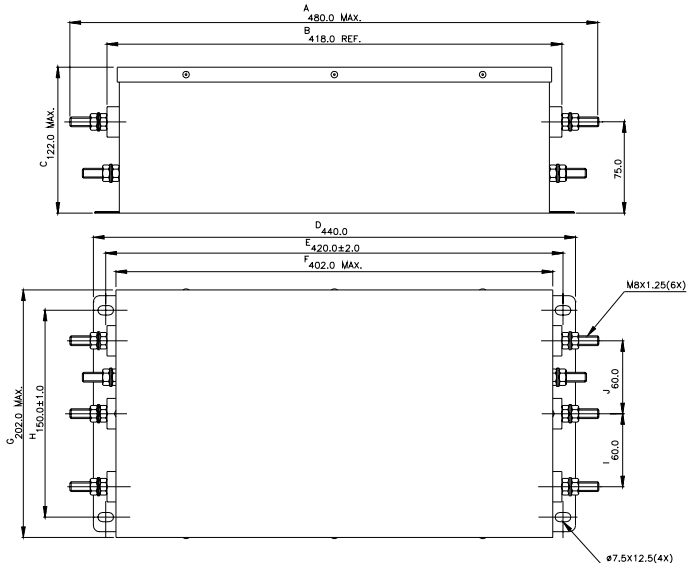

Order P/N: 180TDS84C

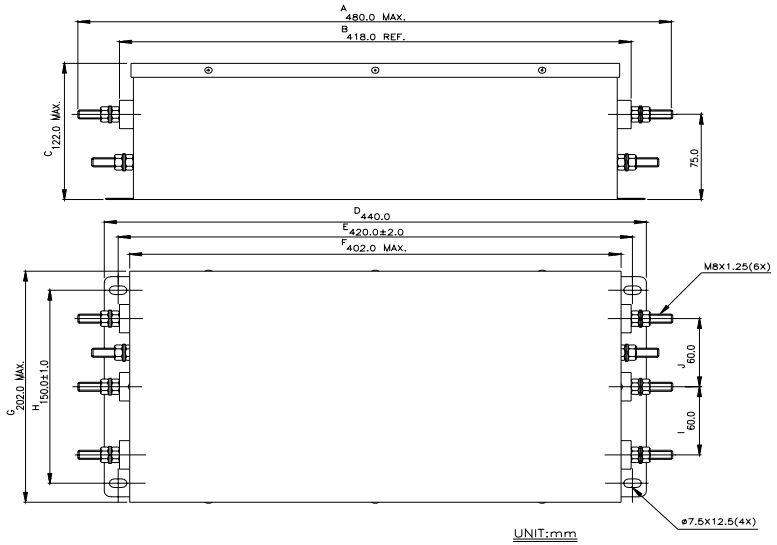

B.10 Multi-function I/O Extension Card

B.10.1 Functions

EMV-APP01 optional multi-function I/O extension card is exclusively designed for VFD-VE series and used with firmware version 2.04 and above. It communicates with the AC motor drive by RS-485 communication port (COM1). To make sure that the communication is normal, it needs to set the COM1 communication protocol to RTU mode (8, N, 1), i.e. set Pr.09-04 to 12 no matter what the baud rate switch is set.

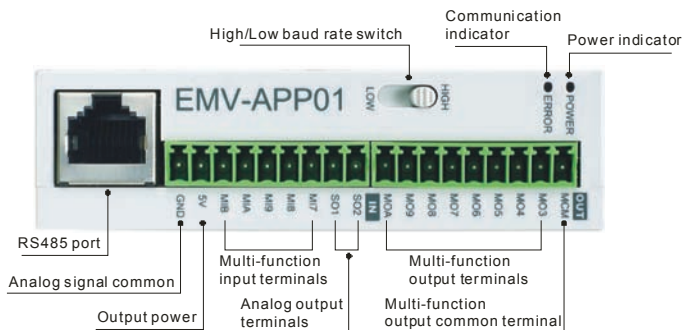



NOTE

Please operate by the following steps for switching the high/low baud rate,

1. make sure that RS-485 cable is disconnected before operation
2. switch the high/low baud rate
3. set Pr.09-01 to the corresponding baud rate to finish setting

If the RS-485 cable is connected before changing the high/low baud rate, the communication function will still be invalid even if the communication baud rate (Pr.09-01) is changed to the corresponding baud rate and the ERROR indicator is normal.

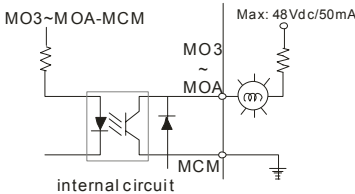
Terminals	Description
POWER	Power indicator. It will be ON when EMV-APP01 connects to the AC motor drive correctly.
ERROR	ERROR indicator. It will be ON when EMV-APP01 can communicate with the AC motor drive or it will blink.
HIGH/LOW	Baud rate switch for extension card: HIGH: set the baud rate to 115200 LOW: set the baud rate to 9600

Terminals	Description
5V	Output power 500mA Max
GND	<p>Analog signal common terminal</p>  NOTE This GND terminal is only used for 5V terminal on EMV-APP01. Please do NOT confuse with DCM terminal.
SO1-MCM	Multi-function analog voltage output terminal 0~10.0V (output current: 2mA Max.)
SO2-MCM	Analog output is set by Pr.03-21 and Pr.03-24.
MI7~MIB	<p>Multi-function input terminals</p> <p>Please refer to Pr.02-23 to Pr.02-27 for MI7-GND~MIB-GND function selection. Take terminals MI7-GND for example, ON: the activation current is 6.5mA and OFF: leakage current tolerance is 10μA.</p>
MO3~MOA	<p>Multi-function output terminals (photocoupler)</p> <p>The AC motor drive outputs each monitor signal, such as during operation, frequency attained and overload, by transistor with open collector. Please refer to Pr.03-35 to Pr.03-42 for details.</p> 
MCM	<p>Multi-function output common terminal. Max: 48Vdc/50mA</p>  NOTE This MCM terminal is only used with MO3~MOA on EMV-APP01. Please do NOT confuse with terminal MCM.

B.10.2 Dimensions

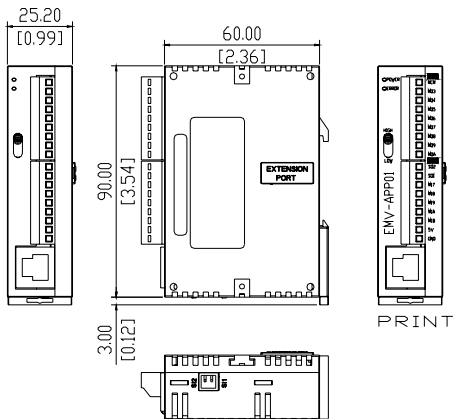

B.10.3 Wiring

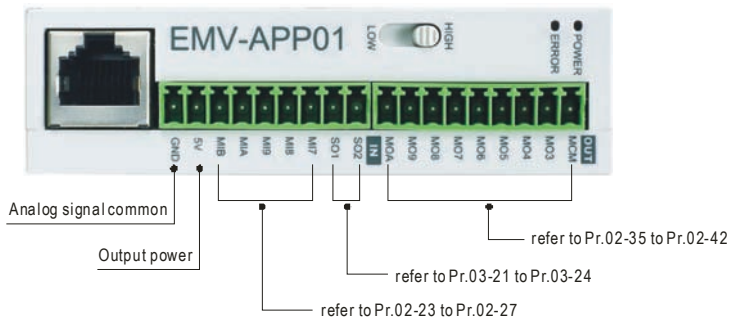

When wiring, please refer to the multi-function input/output function in parameters group 02 and group 03 of chapter 4 parameters to set by your applications.

This page intentionally left blank

Appendix C How to Select the Right AC Motor Drive

The choice of the right AC motor drive for the application is very important and has great influence on its lifetime. If the capacity of AC motor drive is too large, it cannot offer complete protection to the motor and motor maybe damaged. If the capacity of AC motor drive is too small, it cannot offer the required performance and the AC motor drive maybe damaged due to overloading.

But by simply selecting the AC motor drive of the same capacity as the motor, user application requirements cannot be met completely. Therefore, a designer should consider all the conditions, including load type, load speed, load characteristic, operation method, rated output, rated speed, power and the change of load capacity. The following table lists the factors you need to consider, depending on your requirements.

Item		Related Specification			
		Speed and torque characteristics	Time ratings	Overload capacity	Starting torque
Load type	Friction load and weight load				
	Liquid (viscous) load	●			●
	Inertia load				
	Load with power transmission				
Load speed and torque characteristics	Constant torque				
	Constant output	●	●		
	Decreasing torque				
	Decreasing output				
Load characteristics	Constant load				
	Shock load	●	●	●	●
	Repetitive load				
	High starting torque				
	Low starting torque				
Continuous operation, Short-time operation			●	●	
Long-time operation at medium/low speeds					
Maximum output current (instantaneous)		●		●	
Constant output current (continuous)					
Maximum frequency, Base frequency		●			
Power supply transformer capacity or percentage impedance					
Voltage fluctuations and unbalance				●	●
Number of phases, single phase protection					
Frequency					
Mechanical friction, losses in wiring				●	●
Duty cycle modification			●		

C.1 Capacity Formulas

1. When one AC motor drive operates one motor

The starting capacity should be less than 1.5x rated capacity of AC motor drive
The starting capacity=

$$\frac{k \times N}{973 \times \eta \times \cos \varphi} \left(T_L + \frac{GD^2}{375} \times \frac{N}{t_A} \right) \leq 1.5 \times \text{the_capacity_of_AC_motor_drive}(kVA)$$

2. When one AC motor drive operates more than one motor

2.1 The starting capacity should be less than the rated capacity of AC motor drive

- Acceleration time ≤ 60 seconds

The starting capacity=

$$\frac{k \times N}{\eta \times \cos \varphi} [n_r + n_s(k_s - 1)] = P_{Cl} \left[1 + \frac{n_r}{n_r} (k_s - 1) \right] \leq 1.5 \times \text{the_capacity_of_AC_motor_drive}(kVA)$$

- Acceleration time ≥ 60 seconds

The starting capacity=

$$\frac{k \times N}{\eta \times \cos \varphi} [n_r + n_s(k_s - 1)] = P_{Cl} \left[1 + \frac{n_r}{n_r} (k_s - 1) \right] \leq \text{the_capacity_of_AC_motor_drive}(kVA)$$

2.2 The current should be less than the rated current of AC motor drive(A)

- Acceleration time ≤ 60 seconds

$$n_r + I_M \left[1 + \frac{n_s}{n_r} (k_s - 1) \right] \leq 1.5 \times \text{the_rated_current_of_AC_motor_drive}(A)$$

- Acceleration time ≥ 60 seconds

$$n_r + I_M \left[1 + \frac{n_s}{n_r} (k_s - 1) \right] \leq \text{the_rated_current_of_AC_motor_drive}(A)$$

2.3 When it is running continuously

- The *requirement* of load capacity should be less than the capacity of AC motor drive(kVA)

The requirement of load capacity=

$$\frac{k \times P_M}{\eta \times \cos \varphi} \leq \text{the_capacity_of_AC_motor_drive(kVA)}$$

- *The motor capacity should be less than the capacity of AC motor drive*

$$k \times \sqrt{3} \times V_M \times I_M \times 10^{-3} \leq \text{the_capacity_of_AC_motor_drive(kVA)}$$

- *The current should be less than the rated current of AC motor drive(A)*

$$k \times I_M \leq \text{the_rated_current_of_AC_motor_drive(A)}$$

Symbol explanation

P_M	: Motor shaft output for load (kW)
η	: Motor efficiency (normally, approx. 0.85)
$\cos \varphi$: Motor power factor (normally, approx. 0.75)
V_M	: Motor rated voltage(V)
I_M	: Motor rated current(A), for commercial power
k	: Correction factor calculated from current distortion factor (1.05-1.1, depending on PWM method)
P_{C1}	: Continuous motor capacity (kVA)
k_S	: Starting current/rated current of motor
n_T	: Number of motors in parallel
n_S	: Number of simultaneously started motors
GD^2	: Total inertia (GD^2) calculated back to motor shaft (kg m^2)
T_L	: Load torque
t_A	: Motor acceleration time
N	: Motor speed

C.2 General Precaution

Selection Note

1. When the AC Motor Drive is connected directly to a large-capacity power transformer (600kVA or above) or when a phase lead capacitor is switched, excess peak currents may occur in the power input circuit and the converter section may be damaged. To avoid this, use an AC input reactor (optional) before AC Motor Drive mains input to reduce the current and improve the input power efficiency.
2. When a special motor is used or more than one motor is driven in parallel with a single AC Motor Drive, select the AC Motor Drive current $\geq 1.25 \times (\text{Sum of the motor rated currents})$.
3. The starting and accel./decel. characteristics of a motor are limited by the rated current and the overload protection of the AC Motor Drive. Compared to running the motor D.O.L. (Direct On-Line), a lower starting torque output with AC Motor Drive can be expected. If higher starting torque is required (such as for elevators, mixers, tooling machines, etc.) use an AC Motor Drive of higher capacity or increase the capacities for both the motor and the AC Motor Drive.
4. When an error occurs on the drive, a protective circuit will be activated and the AC Motor Drive output is turned off. Then the motor will coast to stop. For an emergency stop, an external mechanical brake is needed to quickly stop the motor.

Parameter Settings Note

1. The AC Motor Drive can be driven at an output frequency up to 400Hz (less for some models) with the digital keypad. Setting errors may create a dangerous situation. For safety, the use of the upper limit frequency function is strongly recommended.
2. High DC brake operating voltages and long operation time (at low frequencies) may cause overheating of the motor. In that case, forced external motor cooling is recommended.
3. Motor accel./decel. time is determined by motor rated torque, load torque, and load inertia.
4. If the stall prevention function is activated, the accel./decel. time is automatically extended to a length that the AC Motor Drive can handle. If the motor needs to decelerate within a certain time with high load inertia that can't be handled by the AC Motor Drive in the required time, either use an external brake resistor and/or brake unit, depending on the model, (to shorten deceleration time only) or increase the capacity for both the motor and the AC Motor Drive.

C.3 How to Choose a Suitable Motor

Standard motor

When using the AC Motor Drive to operate a standard 3-phase induction motor, take the following precautions:

1. The energy loss is greater than for an inverter duty motor.
2. Avoid running motor at low speed for a long time. Under this condition, the motor temperature may rise above the motor rating due to limited airflow produced by the motor's fan. Consider external forced motor cooling.
3. When the standard motor operates at low speed for long time, the output load must be decreased.
4. The load tolerance of a standard motor is as follows:

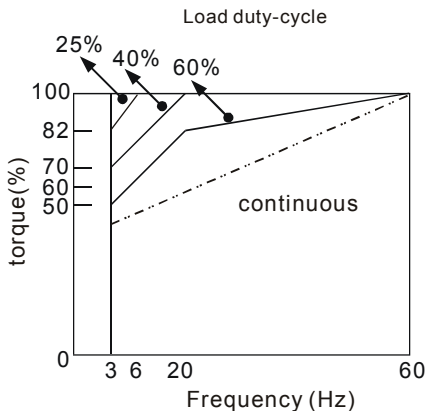

5. If 100% continuous torque is required at low speed, it may be necessary to use a special inverter duty motor.
6. Motor dynamic balance and rotor endurance should be considered once the operating speed exceeds the rated speed (60Hz) of a standard motor.
7. Motor torque characteristics vary when an AC Motor Drive instead of commercial power supply drives the motor. Check the load torque characteristics of the machine to be connected.
8. Because of the high carrier frequency PWM control of the VFD series, pay attention to the following motor vibration problems:

- *Resonant mechanical vibration: anti-vibration (damping) rubbers should be used to mount equipment that runs at varying speed.*
- *Motor imbalance: special care is required for operation at 50 or 60 Hz and higher frequency.*
- *To avoid resonances, use the Skip frequencies.*

9. The motor fan will be very noisy when the motor speed exceeds 50 or 60Hz.

Special motors:

1. Pole-changing (Dahlander) motor:

The rated current is differs from that of a standard motor. Please check before operation and select the capacity of the AC motor drive carefully. When changing the pole number the motor needs to be stopped first. If over current occurs during operation or regenerative voltage is too high, please let the motor free run to stop (coast).

2. Submersible motor:

The rated current is higher than that of a standard motor. Please check before operation and choose the capacity of the AC motor drive carefully. With long motor cable between AC motor drive and motor, available motor torque is reduced.

3. Explosion-proof (Ex) motor:

Needs to be installed in a safe place and the wiring should comply with the (Ex) requirements. Delta AC Motor Drives are not suitable for (Ex) areas with special precautions.

4. Gear reduction motor:

The lubricating method of reduction gearbox and speed range for continuous operation will be different and depending on brand. The lubricating function for operating long time at low speed and for high-speed operation needs to be considered carefully.

5. Synchronous motor:

The rated current and starting current are higher than for standard motors. Please check before operation and choose the capacity of the AC motor drive carefully. When the AC motor drive operates more than one motor, please pay attention to starting and changing the motor.

Power Transmission Mechanism

Pay attention to reduced lubrication when operating gear reduction motors, gearboxes, belts and chains, etc. over longer periods at low speeds. At high speeds of 50/60Hz and above, lifetime reducing noises and vibrations may occur.

Motor torque

The torque characteristics of a motor operated by an AC motor drive and commercial mains power are different.

Below you'll find the torque-speed characteristics of a standard motor (4-pole, 15kW):

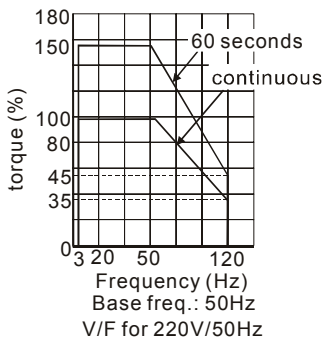
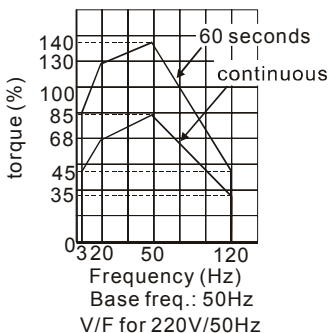
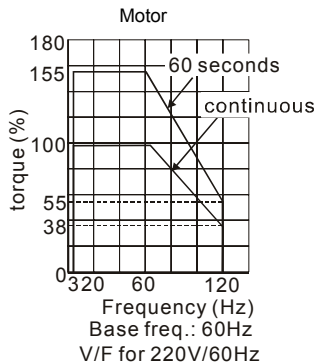
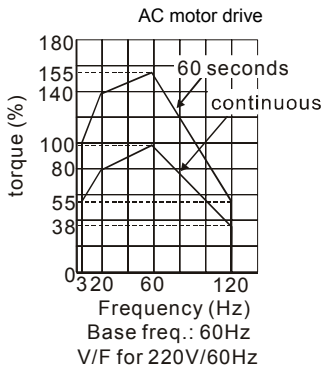

This page intentionally left blank.

Free Manuals Download Website

<http://myh66.com>

<http://usermanuals.us>

<http://www.somanuals.com>

<http://www.4manuals.cc>

<http://www.manual-lib.com>

<http://www.404manual.com>

<http://www.luxmanual.com>

<http://aubethermostatmanual.com>

Golf course search by state

<http://golfingnear.com>

Email search by domain

<http://emailbydomain.com>

Auto manuals search

<http://auto.somanuals.com>

TV manuals search

<http://tv.somanuals.com>