

INSPIRON™

SETUP GUIDE



YOURS IS HERE

INSPIRON™

SETUP GUIDE

Regulatory model: DCME and D06M

Regulatory type: D06M001

Notes, Cautions, and Warnings



NOTE: A NOTE indicates important information that helps you make better use of your computer.



CAUTION: A CAUTION indicates either potential damage to hardware or loss of data and tells you how to avoid the problem.



WARNING: A WARNING indicates a potential for property damage, personal injury, or death.

Information in this document is subject to change without notice.

© 2010 Dell Inc. All rights reserved.

Reproduction of these materials in any manner whatsoever without the written permission of Dell Inc. is strictly forbidden.

Trademarks used in this text: *Dell*, the *DELL* logo, *YOURS IS HERE*, *Inspiron*, *Solution Station*, and *DellConnect* are trademarks of Dell Inc.; *Intel*, *Celeron*, and *Pentium* are registered trademarks and *Core* is a trademark of Intel Corporation in the U.S. and other countries; *AMD*, *AMD Sempron*, *AMD Athlon*, *AMD Phenom*, and *ATI Radeon* are trademarks of Advanced Micro Devices, Inc.; *Microsoft*, *Windows*, *Windows Vista*, and the *Windows Vista* start button logo are either trademarks or registered trademarks of Microsoft Corporation in the United States and/or other countries; *Blu-ray Disc* is a trademark of the Blu-ray Disc Association; *Bluetooth* is a registered trademark owned by Bluetooth SIG, Inc. and is used by Dell under license.

Other trademarks and trade names may be used in this document to refer to either the entities claiming the marks and names or their products. Dell Inc. disclaims any proprietary interest in trademarks and trade names other than its own.

March 2010

P/N M1PTF

Rev. A00

Contents

Setting Up Your Inspiron Desktop	5	Software Features	22
Before Setting Up Your Computer	5	Dell Dock	23
Connect the Display.	6	Dell DataSafe Online Backup	24
Connect the Keyboard and Mouse.	8	Solving Problems	25
Connect the Network Cable (Optional)	9	Beep Codes	25
Connect the Power Cable	10	Network Problems	26
Press the Power Button	11	Power Problems.	27
Set Up Microsoft Windows.	12	Memory Problems	29
Create System Recovery Media (Recommended).	12	Lockups and Software Problems	30
Connect to the Internet (Optional)	13	Using Support Tools	32
Using Your Inspiron Desktop	16	Dell Support Center	32
Front View Features.	16	My Dell Downloads	33
Back View Features.	18	System Messages	33
Back Panel Connectors.	20	Hardware Troubleshooter	35
		Dell Diagnostics	36

Contents

Restoring Your Operating System	40	Finding More Information and Resources	56
System Restore	41	Basic Specifications	58
Dell DataSafe Local Backup	42	Appendix	62
System Recovery Media	44	Macrovision Product Notice	62
Dell Factory Image Restore	45	Information for NOM, or Official Mexican Standard (Only for Mexico)	63
Getting Help	48	Index	64
Technical Support and Customer Service	49		
DellConnect	49		
Online Services	50		
Automated Order-Status Service	51		
Product Information	51		
Returning Items for Repair Under Warranty or for Credit	52		
Before You Call	53		
Contacting Dell	55		

Setting Up Your Inspiron Desktop

This section provides information about setting up your Inspiron™ desktop.



WARNING: Before you begin any of the procedures in this section, read the safety information that shipped with your computer. For additional safety best practices information, see the Regulatory Compliance Homepage at www.dell.com/regulatory_compliance.

Before Setting Up Your Computer

When positioning your computer, ensure that you allow easy access to a power source, adequate ventilation, and a level surface to place your computer.

Restricting airflow around your computer may cause it to overheat. To prevent overheating ensure that you leave at least 10.2 cm (4 inches) at the back of the computer and a minimum of 5.1 cm (2 inches) on all other sides. You should never place your computer in an enclosed space, such as a cabinet or drawer when it is powered on.

Connect the Display









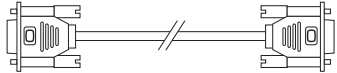
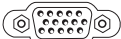

Your computer has integrated VGA and HDMI video connectors.

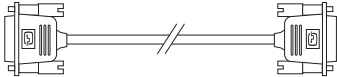
 **NOTE:** A DVI connector may be available if you purchased a discrete graphics card.

You can purchase the HDMI-to-DVI adapter and additional HDMI or DVI cables at www.dell.com.

Use the appropriate cable based on the connectors available on your computer and display. Refer to the following table to identify the connectors on your computer and display.

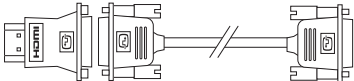
 **NOTE:** When connecting to a single display, connect the display to **ONLY ONE** of the connectors on your computer.

Connection Type	Computer	Cable	Display
VGA-to-VGA (VGA cable)			
DVI-to-DVI (DVI cable)			
HDMI-to-HDMI (HDMI cable)			
HDMI-to-DVI (HDMI-to-DVI adapter + DVI cable)			

Connect the Keyboard and Mouse

Connect the USB keyboard and mouse to the USB connectors on the back panel of your computer.

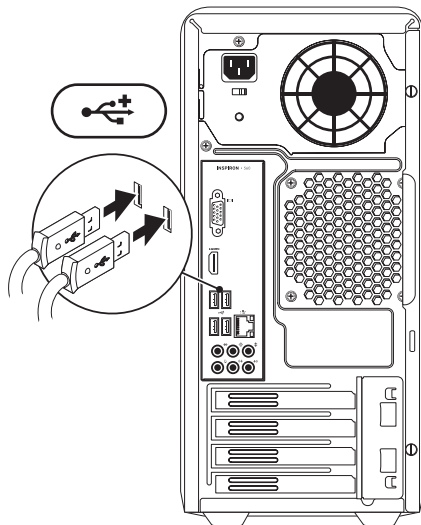

Connect the Network Cable (Optional)

A network connection is not required to complete your computer setup, but if you have an existing network or Internet connection that uses a cable connection (such as a broadband device or Ethernet jack), you can connect it now.

NOTE: Use only an Ethernet cable to connect to the network connector (RJ45 connector). Connect the telephone cable only to the modem connector (RJ11 connector) and not to the network connector (RJ45 connector).

To connect your computer to a network or a broadband device, connect one end of the network cable to the network port or the broadband device. Connect the other end of the network cable to the network connector (RJ45 connector) on the back panel of your computer. A click indicates that the network cable has been securely attached.

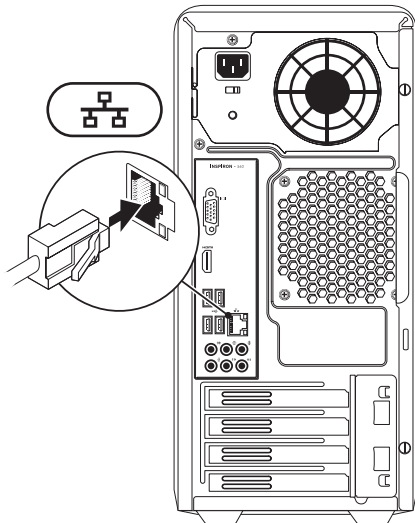

Connect the Power Cable

CAUTION: To help avoid damaging your computer, ensure that the voltage selector switch is set for the voltage that most closely matches the AC power available in your location.

To locate the voltage selector switch, see “Back View Features” on page 18.

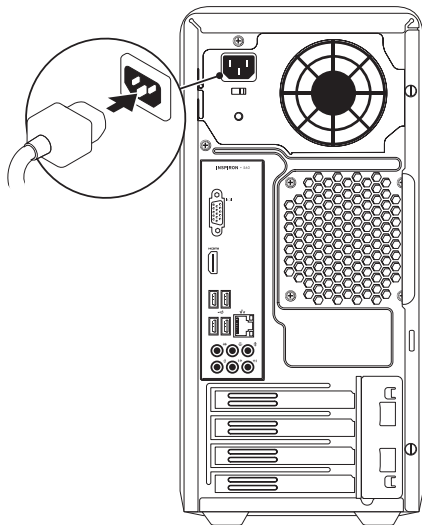

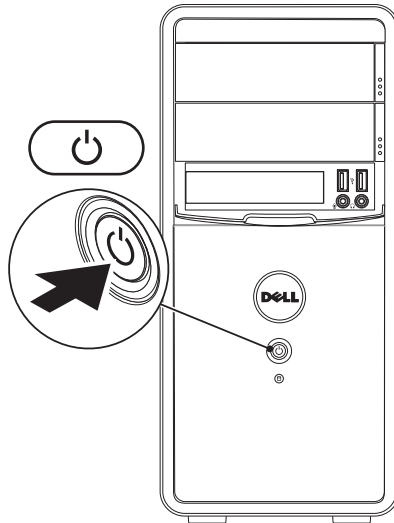

Press the Power Button



Set Up Microsoft Windows

Your Dell computer is preconfigured with Microsoft® Windows® operating system. To set up Windows for the first time, follow the instructions on the screen. These steps are mandatory and may take some time to complete. The Windows setup screens will take you through several procedures including accepting license agreements, setting preferences, and setting up an Internet connection.

 **CAUTION: Do not interrupt the operating system's setup process. Doing so may render your computer unusable and you will need to reinstall the operating system.**

 **NOTE:** For optimal performance of your computer, it is recommended that you download and install the latest BIOS and drivers for your computer available at support.dell.com.

 **NOTE:** For more information on the operating system and features, see support.dell.com/MyNewDell.

Create System Recovery Media (Recommended)

 **NOTE:** It is recommended that you create a system recovery media as soon as you set up Microsoft Windows.

The system recovery media can be used to restore your computer to the operating state it was in when you purchased the computer, while preserving data files (without the need of the *Operating System* disc). You can use the system recovery media if changes to the hardware, software, drivers, or other system settings have left the computer in an undesirable operating state.

You will require the following to create the system recovery media:

- Dell DataSafe Local Backup
- USB key with a minimum capacity of 8 GB or DVD-R/DVD+R/Blu-ray Disc™

 **NOTE:** Dell DataSafe Local Backup does not support rewritable discs.

To create a system recovery media:

1. Ensure that the power cable is connected and the computer is turned on.
2. Insert the disc or USB key in the computer.
3. Click **Start**  → **Programs** → **Dell DataSafe Local Backup**.
4. Click **Create Recovery Media**.
5. Follow the instructions on the screen.

 **NOTE:** For information on using the system recovery media, see “System Recovery Media” on page 44.

Connect to the Internet (Optional)

To connect to the Internet, you need an external modem or network connection and an Internet service provider (ISP).

If an external USB modem or WLAN adapter is not part of your original order, you can purchase one at www.dell.com.

Setting Up a Wired Connection

- If you are using a dial-up connection, connect the telephone cable to the optional modem and to the telephone wall jack before you set up your Internet connection.
- If you are using a DSL or cable/satellite modem connection, contact your ISP or cellular telephone service for setup instructions.

To complete setting up your wired Internet connection, follow the instructions in “Setting Up Your Internet Connection” on page 14.

Setting Up a Wireless Connection

 **NOTE:** To set up your wireless router, see the documentation that shipped with your router.

Before you can use your wireless Internet connection, you need to connect to your wireless router.

To set up your connection to a wireless router:

Windows Vista®

1. Save and close any open files, and exit any open programs.
2. Click **Start**  → **Connect To**.
3. Follow the instructions on the screen to complete the setup.

Windows® 7

1. Save and close any open files, and exit any open programs.
2. Click **Start**  → **Control Panel**.

3. In the search box, type `network`, and then click **Network and Sharing Center** → **Connect to a network**.
4. Follow the instructions on the screen to complete the setup.

Setting Up Your Internet Connection

ISPs and ISP offerings vary by country. Contact your ISP for offerings available in your country.

If you cannot connect to the Internet but have successfully connected in the past, the ISP might have a service outage. Contact your ISP to check the service status, or try connecting again later.

Have your ISP information ready. If you do not have an ISP, the **Connect to the Internet** wizard can help you get one.

To set up your Internet connection:

Windows Vista

1. Save and close any open files, and exit any open programs.
2. Click **Start**  → **Control Panel**.
3. In the search box, type `network`, and then click **Network and Sharing Center** → **Set up a connection or network** → **Connect to the Internet**.

The **Connect to the Internet** window appears.

-  **NOTE:** If you do not know which type of connection to select, click **Help me choose** or contact your ISP.
4. Follow the instructions on the screen and use the setup information provided by your ISP to complete the setup.

Windows 7

1. Save and close any open files, and exit any open programs.
2. Click **Start**  → **Control Panel**.
3. In the search box, type `network`, and then click **Network and Sharing Center** → **Set up a new connection or network** → **Connect to the Internet**.



The **Connect to the Internet** window appears.

-  **NOTE:** If you do not know which type of connection to select, click **Help me choose** or contact your ISP.
4. Follow the instructions on the screen and use the setup information provided by your ISP to complete the setup.

Using Your Inspiron Desktop





This section provides information about the features available on your Inspiron™ desktop.

Front View Features

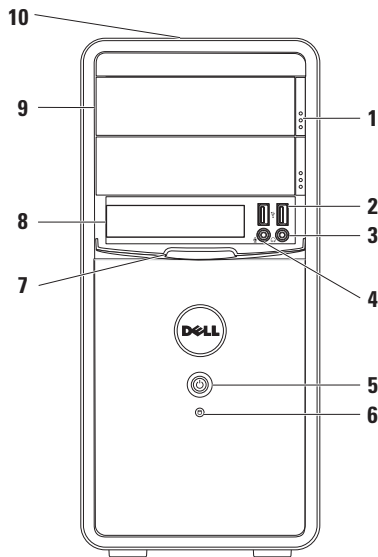
- 1 **Optical drive eject buttons (2)** — Eject the optical drive tray when pressed.
- 2  **USB 2.0 connectors (2)** — Connect to USB devices that are connected occasionally such as memory keys, digital cameras, and MP3 players.
- 3  **Headphone connector** — Connects to headphones.

NOTE: To connect to a powered speaker or sound system, use the audio connectors on the back of your computer.



- 4**  **Line-in or microphone connector** — Connects to a microphone for voice or to an audio cable for audio input.
- 5**  **Power button** — Turns the computer on or off when pressed. The light in the center of this button indicates the power state.
- NOTE:** For information on power problems, see “Power Problems” on page 27.
- 6**  **Hard-drive activity light** — Turns on when the computer reads or writes data. A blinking white light indicates hard-drive activity.
-  **CAUTION: To avoid loss of data, never turn off the computer while the hard-drive activity light is blinking.**
- 7** **FlexBay cover** — Covers the FlexBay slot.
- 8** **FlexBay slot** — Can support an optional Media Card Reader or an additional hard drive.
- 9** **Optical drives (2)** — Play or record CDs, DVDs, and Blu-ray Discs (optional). Ensure that the side with print or writing is facing up when placing the disc on the optical drive tray.
- 10** **Service Tag and Express Service Code (located on top of the chassis towards the back)** — Helps to identify your computer when you access the Dell Support website or call technical support.

Back View Features

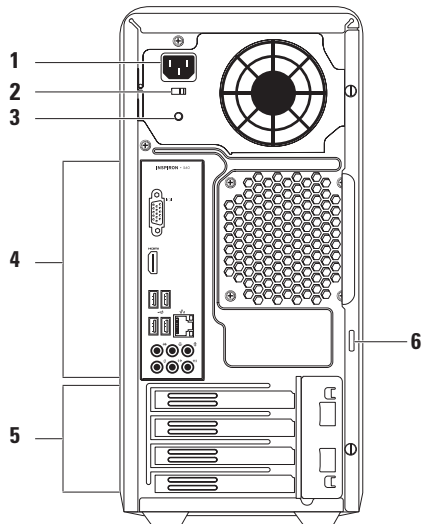

- 1 Power connector** — Connects to the power cable. Appearance of this connector may vary.
- 2 Voltage selector switch** — Allows to select the voltage rating appropriate for your region.
- 3 Power supply light** — Indicates power availability on the power supply unit.
NOTE: The power supply light may not be available on all computers.
- 4 Back panel connectors** — Connect USB, audio, and other devices into the appropriate connectors.
- 5 Expansion card slots** — Provide access to connectors on any installed PCI and PCI express cards.
- 6 Padlock rings** — Attaches to a standard padlock to prevent unauthorized access to the interior of your computer.

Back Panel Connectors

 **NOTE:** Depending on your computer model, the exact location of connectors may be different.

Inspiron 560

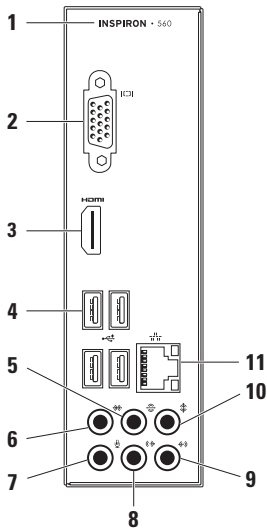

Inspiron 570

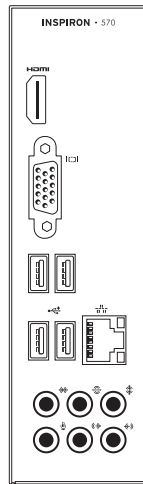



1 Your computer's model number.

2  **VGA connector** — Connects to the display.

3  **HDMI connector** — Connects to a TV for both 5.1 audio and video signals.

NOTE: When used with a monitor, only the video signal will be read.

4  **USB 2.0 connectors (4)** — Connect to USB devices, such as a mouse, printer, keyboard, external drive, or MP3 player.

5  **Rear L/R surround connector** — Connects to rear L/R surround speakers.

6  **Side L/R surround connector** — Connects to side L/R surround speakers.

7  **Microphone connector** — Connects to a microphone for voice or audio input into a sound or telephony program.

8  **Front L/R line-out connector** — Connects to front L/R speakers.

9  **Line-in connector** — Connects to recording or playback devices such as a microphone, cassette player, CD player, or VCR.

10  **Center/subwoofer connector** — Connects to a center speaker or subwoofer.

11  **Network connector and light** — Connects your computer to a network or broadband device if you are using a wired network. The two lights next to the connector indicate status and activity for wired network connection.

Software Features

 **NOTE:** For more information about the features described in this section, see the *Dell Technology Guide* available on your hard drive or at support.dell.com/manuals.

Productivity and Communication

You can use your computer to create presentations, brochures, greeting cards, fliers, and spreadsheets. You can also edit and view digital photographs and images. Check your purchase order for software installed on your computer.

After connecting to the Internet, you can access websites, setup an e-mail account, and upload or download files.

Entertainment and Multimedia

You can use your computer to watch videos, play games, create your own CDs, listen to music and radio stations.

You can download or copy pictures and video files from portable devices, such as digital cameras and cell phones. Optional software applications enable you to organize and create music and video files that can be recorded to a disc, saved on portable products such as MP3 players and handheld entertainment devices, or played and viewed directly on connected TVs, projectors, and home theater equipment.

Dell Dock

The Dell Dock is a group of icons that provides easy access to frequently-used applications, files, and folders. You can personalize the Dock by:

- Adding or removing icons
- Changing the color and location of the Dock
- Grouping related icons into categories
- Changing the behavior of the icons



Add a Category

1. Right-click the Dock, click **Add** → **Category**.
The **Add/Edit Category** window is displayed.
2. Enter a title for the category in the **Title** field.
3. Select an icon for the category from the **Select an image:** box.
4. Click **Save**.

Add an Icon

Drag and drop the icon to the Dock or a category.



Remove a Category or Icon

1. Right-click the category or icon on the Dock and click **Delete shortcut** or **Delete category**.
2. Follow the instructions on the screen.

Personalize the Dock

1. Right-click the Dock and click **Advanced Setting....**
2. Choose the desired option to personalize the Dock.

Dell DataSafe Online Backup

-  **NOTE:** Dell DataSafe Online may not be available in all regions.
-  **NOTE:** A broadband connection is recommended for fast upload or download speeds.

Dell DataSafe Online is an automated backup and recovery service that helps protect your data and other important files from catastrophic incidents like theft, fire, or natural disasters. You can access the service on your computer using a password-protected account.

For more information, go to **delldatasafe.com**.

To schedule backups:

1. Double-click the Dell DataSafe Online icon  on the taskbar.
2. Follow the instructions that appear on the screen.

Solving Problems

This section provides troubleshooting information for your computer. If you cannot solve your problem using the following guidelines, see “Using Support Tools” on page 32 or “Contacting Dell” on page 55.

Beep Codes

Your computer might emit a series of beeps during start-up if there are errors or problems. This series of beeps, called a beep code, identifies a problem. Write down the beep code and contact Dell (see “Contacting Dell” on page 55).

Beep Code	Possible Problem
One	Possible system board failure — BIOS ROM checksum failure
Two	No RAM detected NOTE: If you installed or replaced the memory module, ensure that the memory module is seated properly.
Three	Possible system board failure — Chipset error
Four	RAM read/write failure
Five	Real Time Clock failure
Six	Video card or chip failure
Seven	Processor failure

Network Problems

Wireless Connections

If the network connection is lost — The wireless router is offline or wireless has been disabled on the computer.

- Check your wireless router to ensure it is powered on and connected to your data source (cable modem or network hub).
- Re-establish your connection to the wireless router (see “Setting Up a Wireless Connection” on page 14).

Wired Connections

If the network connection is lost —

- Check the cable to ensure it is plugged in and not damaged.
- Check the status of the link integrity light.

The link integrity light on the integrated network connector lets you verify that your connection is working and provides information on the status:

- **Off** — A good connection exists between a 10-Mbps network and the computer, or the computer is not detecting a physical connection to the network.
If your network connection is not working, contact your network administrator.
- **Solid green** — A good connection exists between a 100-Mbps network and the computer.
- **Solid orange** — A good connection exists between a 1000-Mbps network and the computer.

 **NOTE:** The link integrity light on the network connector is only for the wired cable connection. The link integrity light does not provide status for wireless connections.

If the problem persists, contact your network administrator.

Power Problems

If the power light is off — The computer is in hibernate mode, turned off, or is not receiving power.

- Press the power button to resume normal operation.
- Reseat the power cable into both the power connector on the computer and the electrical outlet.
- If the computer is plugged into a power strip, ensure that the power strip is plugged into an electrical outlet and that the power strip is turned on. Also bypass power protection devices, power strips, and power extension cables to verify that the computer turns on properly.

- Ensure that the electrical outlet is working by testing it with another device, such as a lamp.
- Ensure that the power supply light on the back of the computer is on. If the light is off there may be a possible problem with the power supply or the power cable.
- If the problem persists, contact Dell (see “Contacting Dell” on page 55).

If the power light is solid white and the computer is not responding — The display may not be connected or powered on.

- Ensure that the display is properly connected and then turn it off, then back on.
- If the problem persists, contact Dell (see “Contacting Dell” on page 55).

Solving Problems

If the power light is solid amber —

- The computer is in sleep or standby state. Press a key on the keyboard, move the connected mouse, or press the power button to resume normal operation.
- There may be a problem with either the system board or the power supply. For assistance, contact Dell (see “Contacting Dell” on page 55).

If the power light is blinking amber — There may be a problem with the system board.

For assistance, contact Dell (see “Contacting Dell” on page 55).

If you encounter interference that hinders reception on your computer — An unwanted signal is creating interference by interrupting or blocking other signals. Some possible causes of interference are:

- Power, keyboard, and mouse extension cables.
- Too many devices connected to a power strip.
- Multiple power strips connected to the same electrical outlet.

Memory Problems

If you receive an insufficient memory message —

- Save and close any open files and exit any open programs you are not using to see if that resolves the problem.
- See the software documentation for minimum memory requirements. If necessary, install additional memory (see the *Service Manual* at support.dell.com/manuals).
- Reseat the memory module(s) into the connector(s) (see the *Service Manual* at support.dell.com/manuals).
- If the problem persists, contact Dell (see “Contacting Dell” on page 55).

If you experience other memory problems —

- Ensure that you are following the memory installation guidelines (see the *Service Manual* at support.dell.com/manuals).
- Check if the memory module is compatible with your computer. Your computer supports DDR3 memory. For more information about the type of memory supported by your computer, see “Basic Specifications” on page 58.
- Run the Dell Diagnostics (see “Dell Diagnostics” on page 36).
- If the problem persists, contact Dell (see “Contacting Dell” on page 55).

Lockups and Software Problems

If the computer does not start up — Ensure that the power cable is firmly connected to the computer and to the electrical outlet.

If a program stops responding — End the program:

1. Press <Ctrl><Shift><Esc> simultaneously.
2. Click **Applications**.
3. Select the program that is no longer responding
4. Click **End Task**.

If a program crashes repeatedly — Check the software documentation. If necessary, uninstall and then reinstall the program.

 **NOTE:** Software usually includes installation instructions in its documentation or on CD.

If the computer stops responding or a solid blue screen appears —

 **CAUTION:** You might lose data if you are unable to perform an operating system shutdown.

If you are unable to get a response by pressing a key on your keyboard or moving your mouse, press and hold the power button for at least 8 to 10 seconds until the computer turns off. Then restart your computer.

If a program is designed for an earlier Microsoft® Windows® operating system — Run the Program Compatibility Wizard. The Program Compatibility Wizard configures a program so that it runs in an environment similar to an earlier version of Microsoft® Windows® operating system environments.

Windows Vista®

1. Click **Start**  → **Control Panel** → **Programs** → **Use an older program with this version of Windows.**
2. In the welcome screen, click **Next**.
3. Follow the instructions on the screen.

Windows® 7

1. Click **Start**  → **Control Panel** → **Programs** → **Run programs made for previous versions of Windows.**
2. In the welcome screen, click **Next**.
3. Follow the instructions on the screen.

If you have other software problems —

- Back up your files immediately.
- Use a virus-scanning program to check the hard drive or CDs.
- Save and close any open files or programs and shut down your computer through the **Start**  menu.

- Check the software documentation or contact the software manufacturer for troubleshooting information:
 - Ensure that the program is compatible with the operating system installed on your computer.
 - Ensure that your computer meets the minimum hardware requirements needed to run the software. See the software documentation for information.
 - Ensure that the program is installed and configured properly.
 - Verify that the device drivers do not conflict with the program.
 - If necessary, uninstall and then reinstall the program.

Using Support Tools

Dell Support Center

The **Dell Support Center** helps you find the service, support, and system-specific information you need.

To launch the application, click the  icon in the taskbar.

The **Dell Support Center** home page displays your computer's model number, service tag, express service code, and service contact information.

The home page also provides links to access:

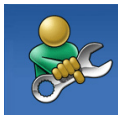

Self Help (Troubleshooting, Security, System Performance, Network/Internet, Backup/Recovery, and Windows operating system)



Alerts (technical support alerts relevant to your computer)



Assistance from Dell (Technical Support with DellConnect™, Customer Service, Training and Tutorials, How-To Help with Solution Station™, and Online Scan with PC CheckUp)



About Your System (System Documentation, Warranty Information, System Information, Upgrades & Accessories)

For more information about **Dell Support Center** and available support tools, click the **Services** tab on support.dell.com.

My Dell Downloads

 **NOTE:** My Dell Downloads may not be available in all regions.

Some of the software pre-installed on your new computer do not include a backup CD or DVD. This software is available at My Dell Downloads. From this website you can download available software for reinstallation or create your own backup media.

To register and use My Dell Downloads:

1. Go to **downloadstore.dell.com/media**.
2. Follow the instructions on the screen to register and download the software.

Reinstall or create backup media of the software for future use.

System Messages

If your computer has an issue or error, it may display a system message that will help you identify the cause and action needed to resolve the issue.

 **NOTE:** If the message you received is not listed in the following examples, see the documentation for either the operating system or the program that was running when the message appeared. Alternatively you could see the *Dell Technology Guide* on your hard drive or at **support.dell.com/manuals** or see “Contacting Dell” on page 55 for assistance.

Alert! Previous attempts at booting this system have failed at checkpoint [nnnn]. For help in resolving this problem, please note this checkpoint and contact Dell Technical Support — The computer failed to complete the boot routine three consecutive times for the same error. Contact Dell for assistance (see “Contacting Dell” on page 55).

Using Support Tools

CMOS checksum error — Possible system board failure or coin-cell battery low. Battery needs replacement. See the *Service Manual* at support.dell.com/manuals or contact Dell for assistance (see “Contacting Dell” on page 55).

CPU fan failure — CPU fan has failed. CPU fan needs replacement. See the *Service Manual* at support.dell.com/manuals.

Hard-disk drive failure — Possible hard drive failure during HDD POST. Contact Dell for assistance (see “Contacting Dell” on page 55).

Hard-disk drive read failure — Possible hard drive failure during HDD boot test. Contact Dell for assistance (see “Contacting Dell” on page 55).

Keyboard failure — Replace keyboard or check the cable for loose connection.

No boot device available — No bootable partition on hard drive, the hard drive cable is loose, or no bootable device exists.

- If the hard drive is your boot device, ensure that the cables are connected and that the drive is installed properly and partitioned as a boot device.
- Enter system setup and ensure that the boot sequence information is correct. See the *Service Manual* at support.dell.com/manuals.

No timer tick interrupt — A chip on the system board might be malfunctioning or there might be a system board failure. See the *Service Manual* at support.dell.com/manuals or contact Dell for assistance (see “Contacting Dell” on page 55).

USB over current error — Disconnect the USB device. Your USB device needs more power for it to function properly. Use an external power source to connect the USB device, or if your device has two USB cables, connect both of them.

NOTICE - Hard Drive SELF MONITORING SYSTEM has reported that a parameter has exceeded its normal operating range. Dell recommends that you back up your data regularly. A parameter out of range may or may not indicate a potential hard drive problem — S.M.A.R.T error, possible hard drive failure. Contact Dell for assistance (see “Contacting Dell” on page 55).

Hardware Troubleshooter

If a device is either not detected during the operating system setup or is detected but incorrectly configured, you can use the **Hardware Troubleshooter** to resolve the incompatibility.

To start the Hardware Troubleshooter:

1. Click **Start**  → **Help and Support**.
2. Type `hardware troubleshooter` in the search field and press <Enter> to start the search.
3. In the search results, select the option that best describes the problem and follow the remaining troubleshooting steps.

Dell Diagnostics

If you experience a problem with your computer, perform the checks in “Lockups and Software Problems” on page 30 and run the Dell Diagnostics before you contact Dell for technical assistance.

It is recommended that you print these procedures before you begin.

 **NOTE:** Dell Diagnostics works only on Dell computers.

 **NOTE:** The *Drivers and Utilities* disc is optional and may not ship with your computer.

Ensure that the device that you want to test displays in the system setup program and is active. Press <F2> during POST (Power On Self Test) to enter the System Setup (BIOS) utility.



Start the Dell Diagnostics from your hard drive or from the *Drivers and Utilities* disc.

Starting Dell Diagnostics From Your Hard Drive

The Dell Diagnostics is located on a hidden diagnostic utility partition on your hard drive.

 **NOTE:** If your computer cannot display a screen image, contact Dell (see “Contacting Dell” on page 55).

1. Ensure that the computer is connected to an electrical outlet that is known to be working properly.
2. Turn on (or restart) your computer.
3. When the DELL™ logo appears, press <F12> immediately. Select **Diagnostics** from the boot menu and press <Enter>. This may invoke the Pre-Boot System Assessment (PSA) on your computer.

-  **NOTE:** If you wait too long and the operating system logo appears, continue to wait until you see the Microsoft® Windows® desktop; then, shut down your computer and try again.
-  **NOTE:** If you see a message stating that no diagnostic utility partition has been found, run the Dell Diagnostics from the *Drivers and Utilities* disc.

If PSA is invoked:

- a. The PSA will start running the tests.
- b. If the PSA completes successfully, the following message is displayed: `"No problems have been found with this system so far. Do you want to run the remaining memory tests? This will take about 30 minutes or more. Do you want to continue? (Recommended)."`

- c. If you are experiencing memory issues press <y>, otherwise press <n>. The following message is displayed: `"Booting Dell Diagnostic Utility Partition. Press any key to continue."`
- d. Press any key to go to the **Choose An Option** window.

If PSA is not invoked:

Press any key to start the Dell Diagnostics from the diagnostics utility partition on your hard drive and go to the **Choose An Option** window.

4. Select the test you want to run.
5. If you encounter a problem during a test, a message with the error code and a description of the problem will appear on your screen. Write down the error code and problem description and contact Dell (see "Contacting Dell" on page 55).

Using Support Tools

- ✎ **NOTE:** The Service Tag for your computer is displayed at the top of each test screen. The Service Tag helps you identify your computer when you contact Dell.
- 6. When the tests complete, close the test screen to return to the **Choose An Option** window.
- 7. To exit the Dell Diagnostics and restart the computer, click **Exit**.

Starting Dell Diagnostics From the Drivers and Utilities Disc

- ✎ **NOTE:** The *Drivers and Utilities* disc may not ship with your computer.
- 1. Insert the *Drivers and Utilities* disc.
- 2. Shut down and restart the computer. When the DELL™ logo appears, press <F12> immediately.

- ✎ **NOTE:** If you wait too long and the operating system logo appears, continue to wait until you see the Microsoft® Windows® desktop; then, shut down your computer and try again.
- ✎ **NOTE:** The next steps change the boot sequence for one time only. On the next start-up, the computer boots according to the devices specified in the system setup program.
- 3. When the boot device list appears, highlight **CD/DVD/CD-RW** and press <Enter>.
- 4. Select the **Boot from CD-ROM** option from the menu that appears and press <Enter>.
- 5. Type 1 to start the CD menu and press <Enter> to proceed.

6. Select **Run the 32 Bit Dell Diagnostics** from the numbered list. If multiple versions are listed, select the version appropriate for your computer.
 7. Select the test you want to run.
 8. If you encounter a problem during a test, a message with the error code and a description of the problem will appear on your screen. Write down the error code and problem description and contact Dell (see “Contacting Dell” on page 55).
-  **NOTE:** The Service Tag for your computer is displayed at the top of each test screen. The Service Tag helps you identify your computer when you contact Dell.
9. When the tests complete, close the test screen to return to the **Choose An Option** window. To exit the Dell Diagnostics and restart the computer, click **Exit**.
 10. To exit the Dell Diagnostics and to restart the computer, click **Exit**.
 11. Remove the *Drivers and Utilities* disc.

Restoring Your Operating System

You can restore the operating system on your computer using any of the following options:

 **CAUTION:** Using Dell Factory Image Restore or the *Operating System* disc permanently deletes all data files on your computer. If possible, backup your data files before using these options.

Option	Use
System Restore	as the first solution
Dell DataSafe Local Backup	when System Restore does not resolve your problem
System recovery media	when operating system failure prevents the use of System Restore and DataSafe Local Backup when installing the factory image on a newly installed hard drive
Dell Factory Image Restore	to restore your computer to the operating state it was in when you received your computer
<i>Operating System</i> disc	to reinstall only the operating system on your computer



 **NOTE:** The *Operating System* disc may not ship with your computer.

System Restore

The Microsoft® Windows® operating systems provide a System Restore option which allows you to restore your computer to an earlier operating state (without affecting data files) if changes to the hardware, software, or other system settings have left the computer in an undesirable operating state. Any changes that System Restore makes to your computer are completely reversible.

 **CAUTION: Make regular backups of your data files. System Restore does not monitor your data files or recover them.**

Starting System Restore

1. Click **Start** .
2. In the search box, type `System Restore` and press <Enter>.
 **NOTE:** The **User Account Control** window may appear. If you are an administrator on the computer, click **Continue**; otherwise, contact your administrator to continue the desired action.
3. Click **Next** and follow the instructions on the screen.

In the event that System Restore did not resolve the issue, you may undo the last system restore.

Undoing the Last System Restore

 **NOTE:** Before you undo the last system restore, save and close all open files, and exit any open programs. Do not alter, open, or delete any files or programs until the system restoration is complete.

1. Click **Start** .
2. In the search box, type `System Restore` and press <Enter>.
3. Click **Undo my last restoration** and click **Next**.
4. Follow the instructions on the remaining screens.

Dell DataSafe Local Backup

 **CAUTION:** Using Dell DataSafe Local Backup permanently removes any programs or drivers installed after you received your computer. Prepare backup media of applications you need to install on your computer before using Dell DataSafe Local Backup. Use Dell DataSafe Local Backup only if System Restore did not resolve your operating system problem.

 **CAUTION:** Although Dell Datasafe Local Backup is designed to preserve the data files on your computer, it is recommended that you backup your data files before using the Dell DataSafe Local Backup.

 **NOTE:** Dell DataSafe Local Backup may not be available in all regions.

 **NOTE:** If Dell DataSafe Local Backup is not available on your computer, use Dell Factory Image Restore (see “Dell Factory Image Restore” on page 45) to restore your operating system.

You can use Dell DataSafe Local Backup to restore your hard drive to the operating state it was in when you purchased your computer, while preserving the data files.

Dell DataSafe Local Backup allows you to:

- Backup and restore your computer to an earlier operating state
- Create system recovery media

Dell DataSafe Local Backup Basic

To restore the factory image while preserving the data files:

1. Turn off your computer.
2. Disconnect all the devices (USB drive, printer, etc.) connected to the computer and remove any newly added internal hardware.
 **NOTE:** Do not disconnect the display, keyboard, mouse, or the power cable.
3. Turn on your computer.

4. When the DELL™ logo appears, press <F8> several times to access the **Advanced Boot Options** window.

 **NOTE:** If you wait too long and the operating system logo appears, continue to wait until you see the Microsoft® Windows® desktop; then, shut down your computer and try again.

5. Select **Repair Your Computer**.

6. Select **Dell DataSafe Restore and Emergency Backup** from the **System Recovery Options** menu and follow the instructions on the screen.

 **NOTE:** The restoration process may take an hour or more depending on the size of the data to be restored.

 **NOTE:** For more information, see the knowledge base article 353560 at support.dell.com.

Upgrading to Dell DataSafe Local Backup Professional

 **NOTE:** Dell DataSafe Local Backup Professional may be installed on your computer, if you ordered it at the time of purchase.

Dell DataSafe Local Backup Professional provides additional features that allow you to:

- Backup and restore your computer based on file types
- Backup files to a local storage device
- Schedule automated backups

To upgrade to Dell DataSafe Local Backup Professional:

1. Double-click the Dell DataSafe Local Backup icon  on the taskbar.
2. Click **UPGRADE NOW!**
3. Follow the instructions on the screen to complete the upgrade.

System Recovery Media

 **CAUTION:** Although the system recovery media is designed to preserve the data files on your computer, it is recommended that you backup your data files before using the system recovery media.

You can use the system recovery media, created using Dell DataSafe Local Backup, to return your hard drive to the operating state it was in when you purchased the computer while persevering the data files on your computer.

Use the system recovery media in case of:

- Operating system failure that prevents the use of recovery options that are installed on your computer.
- Hard drive failure that prevents data from being recovered.

To restore the factory image of your computer using the system recovery media:

1. Insert the system recovery disc or USB key and restart the computer.
2. When the DELL™ logo appears, press <F12> immediately.

 **NOTE:** If you wait too long and the operating system logo appears, continue to wait until you see the Microsoft® Windows® desktop; then, shut down your computer and try again.

3. Select the appropriate boot device from the list and press <Enter>.
4. Follow the instructions on the screen to complete the recovery process.

Dell Factory Image Restore

 **CAUTION:** Using Dell Factory Image Restore permanently deletes all data on the hard drive and removes any programs or drivers installed after you received your computer. If possible, back up the data before using this option. Use Dell Factory Image Restore only if System Restore did not resolve your operating system problem.

 **NOTE:** Dell Factory Image Restore may not be available in certain countries or on certain computers.

 **NOTE:** If Dell Factory Image Restore is not available on your computer, use Dell DataSafe Local Backup (see “Dell DataSafe Local Backup” on page 42) to restore your operating system.

Restoring Your Operating System

You can use Dell Factory Image Restore only as the last method to restore your operating system. This option restores your hard drive to the operating state it was in when you purchased the computer. Any programs or files added since you received your computer—including data files—are permanently deleted from the hard drive. Data files include documents, spreadsheets, e-mail messages, digital photos, music files, and so on. If possible, back up all data before using Dell Factory Image Restore.

Starting Dell Factory Image Restore

1. Turn on the computer.
2. When the DELL™ logo appears, press <F8> several times to access the **Advanced Boot Options** window.

 **NOTE:** If you wait too long and the operating system logo appears, continue to wait until you see the Microsoft® Windows® desktop; then, shut down your computer and try again.

3. Select **Repair Your Computer**.
The **System Recovery Options** window appears.
4. Select a keyboard layout and click **Next**.
5. To access the recovery options, log on as a local user. To access the command prompt, type `administrator` in the **User name** field, then click **OK**.

6. Click **Dell Factory Image Restore**. The **Dell Factory Image Restore** welcome screen appears.

 **NOTE:** Depending upon your configuration, you may need to select **Dell Factory Tools**, then **Dell Factory Image Restore**.

7. Click **Next**. The **Confirm Data Deletion** screen appears.

 **NOTE:** If you do not want to proceed with Dell Factory Image Restore, click **Cancel**.

8. Select the check box to confirm that you want to continue reformatting the hard drive and restoring the system software to the factory condition, then click **Next**.
The restore process begins and may take five or more minutes to complete. A message appears when the operating system and factory-installed applications have been restored to factory condition.

9. Click **Finish** to restart the computer.

Getting Help

If you experience a problem with your computer, you can complete the following steps to diagnose and troubleshoot the problem:

1. See “Solving Problems” on page 25 for information and procedures that pertain to the problem your computer is experiencing.
2. See “Dell Diagnostics” on page 36 for procedures on how to run Dell Diagnostics.
3. Fill out the “Diagnostic Checklist” on page 54.
4. Use Dell’s extensive suite of online services available at **support.dell.com** for help with installation and troubleshooting procedures. See “Online Services” on page 50 for a more extensive list of Dell Support online.
5. If the preceding steps have not resolved the problem, contact Dell (see “Contacting Dell” on page 55).

 **NOTE:** Call Dell Support from a telephone near or at the computer so that the support staff can assist you with any necessary procedures.

 **NOTE:** Dell’s Express Service Code system may not be available in all countries.

When prompted by Dell’s automated telephone system, enter your Express Service Code to route the call directly to the proper support personnel. If you do not have an Express Service Code, open the **Dell Accessories** folder, double-click the **Express Service Code** icon, and follow the directions.

 **NOTE:** Some of the following services are not always available in all locations outside the continental U.S. Call your local Dell representative for information on availability.

Technical Support and Customer Service

Dell's support service is available to answer your questions about Dell hardware. Our support staff uses computer-based diagnostics to provide fast, accurate answers.

To contact Dell's support service, see "Before You Call" on page 53 and then see the contact information for your region or go to **support.dell.com**.

DellConnect

DellConnect™ is a simple online access tool that allows a Dell service and support associate to access your computer through a broadband connection, diagnose your problem, and repair it all under your supervision. For more information, go to **support.dell.com/dellconnect**.

Online Services

You can learn about Dell products and services on the following websites:

- www.dell.com
- www.dell.com/ap (Asian/Pacific countries only)
- www.dell.com/jp (Japan only)
- www.euro.dell.com (Europe only)
- www.dell.com/la (Latin American and Caribbean countries)
- www.dell.ca (Canada only)

You can access Dell Support through the following websites and e-mail addresses:

Dell Support websites

- support.dell.com
- support.jp.dell.com (Japan only)
- support.euro.dell.com (Europe only)

Dell Support e-mail addresses

- mobile_support@us.dell.com
- support@us.dell.com
- la-techsupport@dell.com (Latin America and Caribbean countries only)
- apsupport@dell.com (Asian/Pacific countries only)

Dell Marketing and Sales e-mail addresses

- apmarketing@dell.com (Asian/Pacific countries only)
- sales_canada@dell.com (Canada only)

Anonymous file transfer protocol (FTP)

- [ftp.dell.com](ftp://ftp.dell.com)

Log in as user: `anonymous`, and use your e-mail address as your password.

Automated Order-Status Service

To check on the status of any Dell products that you have ordered, you can go to **support.dell.com**, or you can call the automated order-status service. A recording prompts you for the information needed to locate and report on your order.

If you have a problem with your order, such as missing parts, wrong parts, or incorrect billing, contact Dell for customer assistance. Have your invoice or packing slip handy when you call.

For the telephone number to call for your region, see “Contacting Dell” on page 55.

Product Information

If you need information about additional products available from Dell, or if you would like to place an order, visit **www.dell.com**. For the telephone number to call for your region or to speak to a sales specialist, see “Contacting Dell” on page 55.

Returning Items for Repair Under Warranty or for Credit

Prepare all items being returned, whether for repair or credit, as follows:

 **NOTE:** Before you return the product to Dell, make sure to back up any data on the hard drive and on any other storage device in the product. Remove any and all confidential, proprietary and personal information, as well as removable media, such as CDs. Dell is not responsible for any of your confidential, proprietary or personal information; lost or corrupted data; or damaged or lost removable media that may be included with your return.

1. Call Dell to obtain a Return Material Authorization Number, and write it clearly and prominently on the outside of the box. For the telephone number to call your region, see “Contacting Dell” on page 55.
2. Include a copy of the invoice and a letter describing the reason for the return.
3. Include a copy of the Diagnostics Checklist (see “Diagnostic Checklist” on page 54), indicating the tests that you have run and any error messages reported by the Dell Diagnostics (see “Dell Diagnostics” on page 36).
4. Include any accessories that belong with the item(s) being returned (power cables, software, guides, and so on) if the return is for credit.
5. Pack the equipment to be returned in the original (or equivalent) packing materials.

- **NOTE:** You are responsible for paying shipping expenses. You are also responsible for insuring any product returned, and you assume the risk of loss during shipment to Dell. Collect On Delivery (C.O.D.) packages are not accepted.
- **NOTE:** Returns that are missing any of the preceding requirements will be refused at Dell's receiving dock and returned to you.

Before You Call

- **NOTE:** Have your Express Service Code ready when you call. The code helps Dell's automated-support telephone system direct your call more efficiently. You may also be asked for your Service Tag.

Remember to fill out the following Diagnostic Checklist. If possible, turn on your computer before you call Dell for assistance and call from a telephone at or near the computer. You may be asked to type some commands at the keyboard, relay detailed information during operations, or try other troubleshooting steps possible only at the computer itself. Ensure that the computer documentation is available.

Diagnostic Checklist

- Name:
- Date:
- Address:
- Phone number:
- Service Tag and Express Service Code (located on a label on the top of the computer):
- Return Material Authorization Number (if provided by Dell support technician):
- Operating system and version:
- Devices:
- Expansion cards:
- Are you connected to a network? Yes/No
- Network, version, and network adapter:
- Programs and versions:

See your operating system documentation to determine the contents of the computer's start-up files. If the computer is connected to a printer, print each file. Otherwise, record the contents of each file before calling Dell.

- Error message, beep code, or diagnostic code:
- Description of problem and troubleshooting procedures you performed:

Contacting Dell

For customers in the United States, call 800-WWW-DELL (800-999-3355).

 **NOTE:** If you do not have an active Internet connection, you can find contact information on your purchase invoice, packing slip, bill, or Dell product catalog.

Dell provides several online and telephone-based support and service options. Availability varies by country and product, and some services may not be available in your area. To contact Dell for sales, technical support, or customer service issues:

1. Visit **www.dell.com/contactdell**.
2. Select your country or region.
3. Select the appropriate service or support link based on your need.
4. Choose the method of contacting Dell that is convenient for you.

Finding More Information and Resources

If you need to:**See:**

reinstall your operating system

“System Recovery Media” on page 44

run a diagnostic program for your computer

“Dell Diagnostics” on page 36

reinstall system software

“My Dell Downloads” on page 33

find more information about the Microsoft®
Windows® operating system and features

support.dell.com

upgrade your computer with new or additional
components like a new hard drive

the *Service Manual* at
support.dell.com/manuals

reinstall or replace a worn or defective part



NOTE: In some countries, opening and replacing parts of your computer may void your warranty. Check your warranty and return policies before working inside your computer.

If you need to:

find safety best practices information for your computer

review Warranty information, Terms and Conditions (U.S. only), Safety instructions, Regulatory information, Ergonomics information, and End User License Agreement

find your Service tag/Express Service Code — You must use the service tag to identify your computer on **support.dell.com** or to contact technical support

find drivers and downloads; readme files
 access technical support and product help
 check on your order status for new purchases
 find solutions and answers to common questions
 locate information for last-minute updates about technical changes to your computer or advanced technical-reference material for technicians or experienced users

See:



the safety and regulatory documents that shipped with your computer and also see the Regulatory Compliance Homepage at **www.dell.com/regulatory_compliance**

the bottom of your computer the **Dell Support Center**. To launch the **Dell Support Center**, click the  icon in the taskbar.

support.dell.com

Basic Specifications

This section provides information that you may need when setting up, updating drivers for, and upgrading your computer. For more detailed specifications, see the *Comprehensive Specifications* at support.dell.com/manuals.

 **NOTE:** Offerings may vary by region. For more information regarding the configuration of your computer, click **Start**  → **Help and Support** and select the option to view information about your computer.

Computer Model

Dell™ Inspiron™ 560

Dell Inspiron 570

Processor Types

Inspiron 560

Intel® Celeron®

Intel Pentium® Dual Core

Intel Core™2 Duo

Intel Core2 Quad

Inspiron 570

AMD® Sempron™

AMD Athlon™ II X2/X3/X4

AMD Phenom™ II X2/X3/X4

Drives

Externally accessible	two 5.25-inch bays for SATA DVD-ROM, SATA DVD+/-RW Super Multi Drive, or Blu-ray Disc™ combo drive
	one 3.5-inch FlexBay
Internally accessible	two 3.5-inch bays for SATA hard drives

Computer Information

System chipset	Intel G43 (Inspiron 560) AMD 785G (Inspiron 570)
----------------	---

Memory

Connectors	four internally-accessible DIMM sockets
Capacities	1 GB and 2 GB

Memory

Memory type	DDR3 DIMM; non-ECC memory only
Minimum	1 GB
Maximum	8 GB

 **NOTE:** For instructions on upgrading memory, see the *Service Manual* at support.dell.com/manuals.

Video

Integrated	Intel GMA X4500 (Inspiron 560) ATI Radeon™ HD 4200 (Inspiron 570)
Discrete	PCI Express x16 card (optional)

Basic Specifications

Audio

Type	integrated 7.1 channel, High Definition Audio
------	--

External Connectors

Network adapter	one RJ45 connector
USB	two front-panel and four back-panel USB 2.0-compliant connectors
Audio	front panel — headphone and microphone connectors back panel — six connectors for 7.1 channel support
Video	one 15-hole VGA connector and one 19-pin HDMI connector

Communications

Wireless (optional)	PCI Express Wi-Fi card supporting 802.11a/b/g/n
Modem (optional)	PCI modem

Power

Wattage	300 W
Voltage	115/230 VAC
Coin-cell battery	CR2032 lithium

Physical

Height	375.92 mm (14.80 inches)
Width	176.02 mm (6.93 inches)
Depth	442.98 mm (17.44 inches)
Weight (starting at)	7.9 kg (17.4 lb)

Computer Environment

Temperature ranges:

Operating 10°C to 35°C (50°F to 95°F)

Storage -40°C to 65°C (-40°F to 149°F)

Relative humidity (maximum): 20% to 80% (non-condensing)

Maximum vibration (using a random-vibration spectrum that simulates user environment):

Operating 0.25 GRMS

Non-Operating 2.2 GRMS

Computer Environment

Maximum shock (for operating — measured with Dell Diagnostics running on the hard drive and a 2-ms half-sine pulse; for non-operating — measured with hard drive in head-parked position and a 2-ms half-sine pulse):

Operating 40G for 2 ms with a change in velocity of 20 in/s (51 cm/s)

Non-Operating 50G for 26 ms with a change in velocity of 320 in/s (813 cm/s)

Altitude (maximum):

Operating -15.2 to 3,048 m (-50 to 10,000 ft)

Storage -15.2 to 10,668 m (-50 to 35,000 ft)

Airborne contaminant level G2 or lower as defined by ISA-S71.04-1985

Appendix

Macrovision Product Notice

This product incorporates copyright protection technology that is protected by method claims of certain U.S. patents and other intellectual property rights owned by Macrovision Corporation and other rights owners. Use of this copyright protection technology must be authorized by Macrovision Corporation, and is intended for home and other limited viewing uses only unless otherwise authorized by Macrovision Corporation. Reverse engineering or disassembly is prohibited.

Information for NOM, or Official Mexican Standard (Only for Mexico)

The following information is provided in the device(s) described in this document in accordance with the requirements of the Official Mexican Standard (NOM):

Importer:

Dell México S.A. de C.V.

Paseo de la Reforma 2620 - 11°

Col. Lomas Altas

11950 México, D.F.

Regulatory model number	Voltage	Frequency	Electricity consumption
DCME	115/230 VAC	50/60 Hz	7.0/4.0 A
D06M	115/230 VAC	50/60 Hz	7.0/4.0 A

For details, read the safety information that shipped with your computer.

For additional safety best practices information, see the Regulatory Compliance Homepage at www.dell.com/regulatory_compliance.

Index

C

calling Dell **53**

CDs, playing and creating **22**

chipset **59**

computer capabilities **22**

connect(ing)

 optional network cable **9**

Contacting Dell online **55**

customer service **49**

D

DellConnect **49**

Dell DataSafe Online Backup **24**

Dell Diagnostics **36**

Dell Factory Image Restore **45**

Diagnostic Checklist **54**

drivers and downloads **57**

E

eject button **16**

e-mail addresses

 for technical support **50**

F

front-view connectors **16**

FTP login, anonymous **50**

H

hard drive

 type **59**

hard-drive activity light **17**

hardware problems

diagnosing **35**

Hardware Troubleshooter **35**

headphone

front connector **16**

I

Internet connection **13**

ISP

Internet Service Provider **13**

M

memory problems

solving **29**

memory support **59**

N

network connection

fixing **26**

network connector

location **21**

O

order status **51**

P

power button **17**

power problems, solving **27**

problems, solving **25**

processor **58**

products

information and purchasing **51**

R

restoring factory image **45**

S

- shipping products
 - for return or repair **52**
- software features **22**
- software problems **30**
- solving problems **25**
- specifications **58**
- support e-mail addresses **50**
- support sites
 - worldwide **50**
- System Messages **33**
- System Restore **41**

T

- technical support **49**
- temperature
 - operating and storage ranges **61**

U

- USB 2.0
 - back connectors **21**
 - front connectors **16**

W

- warranty returns **52**
- Windows
 - Program Compatibility Wizard **30**
- wireless network connection **26**



Printed in the U.S.A.

www.dell.com | support.dell.com



0M1PTFA00

Free Manuals Download Website

<http://myh66.com>

<http://usermanuals.us>

<http://www.somanuals.com>

<http://www.4manuals.cc>

<http://www.manual-lib.com>

<http://www.404manual.com>

<http://www.luxmanual.com>

<http://aubethermostatmanual.com>

Golf course search by state

<http://golfingnear.com>

Email search by domain

<http://emailbydomain.com>

Auto manuals search

<http://auto.somanuals.com>

TV manuals search

<http://tv.somanuals.com>