

# Dell™ E1910H Flat Panel Monitor User's Guide

[About Your Monitor](#)

[Setting Up the Monitor](#)

[Operating the Monitor](#)

[Troubleshooting](#)

[Appendix](#)

---

## Notes, Notices, and Cautions



**NOTE:** A NOTE indicates important information that helps you make better use of your computer.



**NOTICE:** A NOTICE indicates either potential damage to hardware or loss of data and tells you how to avoid the problem.



**CAUTION:** A CAUTION indicates a potential for property damage, personal injury, or death.

---

Information in this document is subject to change without notice.  
© 2009 Dell Inc. All rights reserved.

Reproduction of these materials in any manner whatsoever without the written permission of Dell Inc. is strictly forbidden.

Trademarks used in this text: *Dell* and the *DELL* logo are trademarks of Dell Inc.; *Microsoft* and *Windows* are either trademarks or registered trademarks of Microsoft Corporation in the United States and/or other countries. *ENERGY STAR* is a registered trademark of the U.S. Environmental Protection Agency. As an ENERGY STAR partner, Dell Inc. has determined that this product meets the ENERGY STAR guidelines for energy efficiency.

Other trademarks and trade names may be used in this document to refer to either the entities claiming the marks and names or their products. Dell Inc. disclaims any proprietary interest in trademarks and trade names other than its own.

---

Model E1910Hc

March 2009 Rev. A00

[Back to Contents Page](#)

## About Your Monitor





### Dell™ E1910H Flat Panel Monitor User's Guide

- [Package Contents](#)
- [Product Features](#)
- [Identifying Parts and Controls](#)
- [Monitor Specifications](#)
- [Plug and Play Capability](#)
- [LCD Monitor Quality & Pixel Policy](#)
- [Maintenance Guidelines](#)

## Package Contents

Your monitor ships with all the components shown below. Ensure that you have received all the components and [Contact Dell™](#) if anything is missing.

 **NOTE:** Some items may be optional and may not ship with your monitor. Some features or media may not be available in certain countries.

	1 Monitor
	1 Stand
	1 Power Cable
	1 VGA Cable (attached to the monitor)
	1 <i>Drivers and Documentation</i> media 1 <i>Quick Setup Guide</i> 1 <i>Safety Information</i>

---

## Product Features

The **Dell™ E1910H** flat panel display has an active matrix, Thin-film Transistor, Liquid Crystal Display. The monitor's features include:

- Dell E1910H has a 18.5-inch (470.0 mm) viewable area display.
  - 1366 x 768 resolution, plus full-screen support for lower resolutions.
  - Wide viewing angle to allow viewing from a sitting or standing position, or while moving from side-to-side.
  - Tilt adjustment capability.
  - Removable pedestal and Video Electronics Standards Association (VESA) 100mm mounting holes for flexible mounting solutions.
  - Plug and play capability if supported by your system.
  - On-Screen Display (OSD) adjustments for ease of set-up and screen optimization.
  - Software and documentation media which includes an information file (INF), Image Color Matching File (ICM), and product documentation.
  - Energy Saver feature for ENERGY STAR® compliance.
  - Security lock slot.
  - Halogen reduced.
- 

## Identifying Parts and Controls

### Front View



1.	Function buttons (For more information, see <a href="#">Operating the Monitor</a> )
2.	Power On/Off button (with LED indicator)

---

### Back View

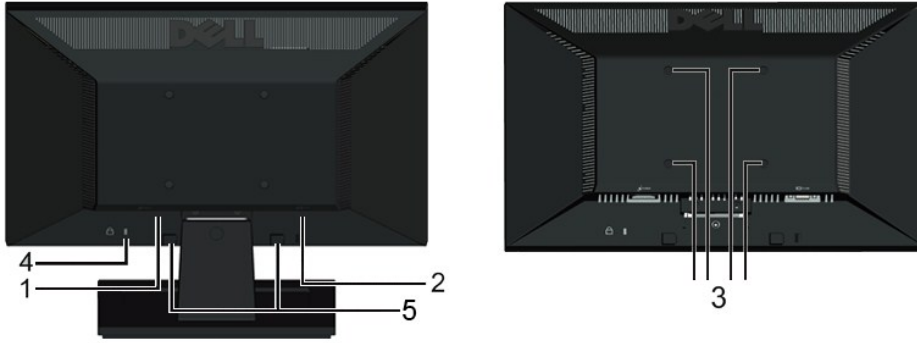

Label	Description	Use
1	Barcode serial number label	Refer to this label if you need to contact Dell for technical support.
2	Regulatory rating label	List the regulatory approvals.
3	VESA mounting holes (100mm)	To mount the monitor.
4	Security lock slot	Use a security lock with the slot to help secure your monitor.
5	Dell soundbar mounting brackets	To attach the optional Dell Soundbar.

## Side View

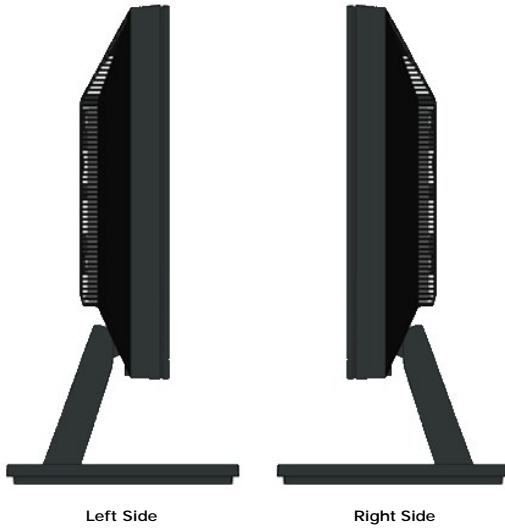

## Bottom View

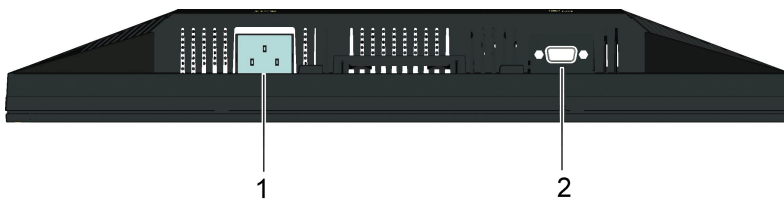

Label	Description	Use
1	AC power connector	To connect the monitor power cable.
2	VGA connector	To connect your computer to the monitor using a VGA cable.

## Monitor Specifications

The following sections give you information about the various power management modes and pin assignments for the various connectors of your monitor.

### Power Management Modes

If you have VESA's DPM compliance display card or software installed in your PC, the monitor automatically reduces its power consumption when not in use. This is referred to as *Power Save Mode*. If the computer detects input from keyboard, mouse, or other input devices, the monitor automatically resumes functioning. The following table shows the power consumption and signaling of this automatic power saving feature:

VESA Modes	Horizontal Sync	Vertical Sync	Video	Power Indicator	Power Consumption
Normal operation	Active	Active	Active	Blue	19 W(Typical) 23 W(Max)
Active-off mode	Inactive	Inactive	Blank	Amber	Less than 1 W
Switch off	-	-	-	Off	Less than 1 W

The OSD will only function in the *normal operation* mode. When any button except power button is pressed in Active-off mode, the following messages will be displayed:

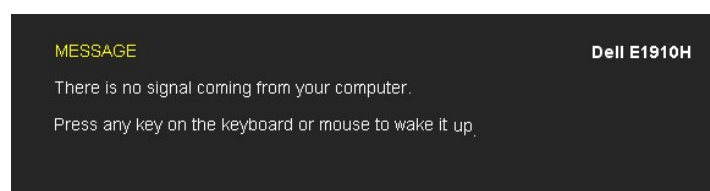

Activate the computer and monitor to gain access to the [OSD](#).

 **NOTE:** Dell E1910H Flat Panel monitor is TC003 and ENERGY STAR®-compliant.

Zero power consumption in OFF mode can only be achieved by disconnecting the main cable from the monitor.



## Pin Assignments

### 15-pin D-Sub connector

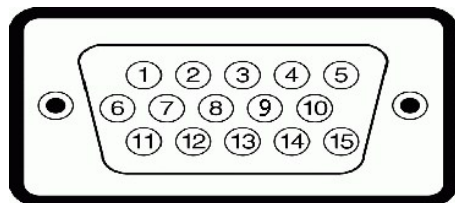

Pin Number	Monitor Side of the 15-pin Side Signal Cable
1	Video-Red
2	Video-Green
3	Video-Blue
4	GND
5	Self-test
6	GND-R
7	GND-G
8	GND-B
9	DDC +5V
10	GND-sync
11	GND
12	DDC data
13	H-sync
14	V-sync
15	DDC clock

---

## Plug and Play Capability

You can install the monitor in any Plug and Play-compatible system. The monitor automatically provides the computer with its Extended Display Identification Data (EDID) using Display Data Channel (DDC) protocols so that the system can configure itself and optimize the monitor settings. Most monitor installations are automatic. You can select different settings if required.

---

## Flat Panel Specifications

Model number	Dell E1910H Flat Panel Monitor
Screen type	Active matrix - TFT LCD
Panel Type	TN
Screen dimensions	18.5 inches (18.5-inch wide viewable image size)
Preset display area:	
Horizontal	409.8 mm (16.1 inches)
Vertical	230.4 mm (9.07 inches)
Pixel pitch	0.300 mm
Viewing angle:	
Horizontal	160° typical
Vertical	160° typical
Luminance output	250 CD/m <sup>2</sup> (typical)
Contrast ratio	1000 to 1 (typical)
Faceplate coating	Anti-glare
Backlight	2 CCFL edgelight system
Response Time	5ms typical
Color Gamut	83% (typical)*

\*Dell E1910H Flat Panel monitor color gamut (typical) is based on CIE 1976 (83%) and CIE1931 (72%) test standards.

---

## Resolution Specifications

Model number	Dell E1910H Flat Panel Monitor
Scan range	
Horizontal	30 kHz to 83 kHz (automatic)
Vertical	56 Hz to 75 Hz (automatic)
Maximum preset resolution	1366 x 768 at 60 Hz

---

## Electrical Specifications

Model number	Dell E1910H Flat Panel Monitor
Video input signals	Analog RGB: 0.7 Volts +/-5%, 75 ohm input impedance
Synchronization input signals	Separate horizontal and vertical synchronizations, polarity-free TTL level, SOG (Composite SYNC on green)
AC input voltage / frequency / current	100 to 240 VAC/50 or 60 Hz ± 3 Hz/1.6A (Max.)
Inrush current	120V: 30A (Max.) 240V: 60A (Max.)

---

## Preset Display Modes

The following table lists the preset modes for which Dell guarantees image size and centering:

Display Mode	Horizontal Frequency (kHz)	Vertical Frequency (Hz)	Pixel Clock (MHz)	Sync Polarity (Horizontal/Vertical)
VESA, 720 x 400	31.5	70.0	28.3	-/+
VESA, 640 x 480	31.5	60.0	25.2	-/-
VESA, 640 x 480	37.5	75.0	31.5	-/-
VESA, 800 x 600	37.9	60.0	40.0	+/+
VESA, 800 x 600	46.9	75.0	49.5	+/+
VESA, 1024 x 768	48.4	60.0	65.0	-/-
VESA, 1024 x 768	60.0	75.0	78.8	+/+
VESA, 1366 x 768	47.7	60.0	85.5	+/+

## Physical Characteristics

The following table lists the monitor physical characteristics:

Model Number	Dell E1910H Flat Panel Monitor
Connector type	15-pin D-subminiature, blue connector;
Signal cable type	Analog: Detachable, D-Sub, 15pins, shipped attached to the monitor
Dimensions: (with stand)	
Height	13.36 inches ( 339.3 mm)
Width	17.48 inches ( 444.0 mm)
Depth	6.13 inches ( 155.6 mm)
Dimensions: (without stand)	
Height	10.42 inches ( 264.6 mm)
Width	17.48 inches ( 444.0 mm)
Depth	2.52 inches ( 64.0 mm)
Stand dimensions:	
Height	4.91 inches ( 124.7 mm)
Width	9.84 inches ( 250.0 mm)
Depth	6.13 inches ( 155.6 mm)
Weight with packaging	12.10 lbs (5.50 kg)
Weight with stand assembly and cables	8.58 lbs ( 3.90 kg)
Weight without stand assembly (For wall mount or VESA mount considerations - no cables)	7.04 lbs ( 3.20 kg)
Weight of stand assembly	1.54 lbs ( 0.70 kg)

## Environmental Characteristics

The following table lists the environmental conditions for your monitor:

Model Number	Dell E1910H Flat Panel Monitor
Temperature	
Operating	0° to 40°C (32° to 104°F)

<ul style="list-style-type: none"> <li>1 Non-operating</li> </ul>	Storage: -20° to 60°C (-4° to 140°F) Shipping: -20° to 60°C(-4° to 140°F)
Humidity	
<ul style="list-style-type: none"> <li>1 Operating</li> </ul>	10% to 80% (non-condensing)
<ul style="list-style-type: none"> <li>1 Non-operating</li> </ul>	Storage: 5% to 90% (non-condensing) Shipping: 5% to 90%(non-condensing)
Altitude	
<ul style="list-style-type: none"> <li>1 Operating</li> </ul>	3,657.6m (12,000 ft) max
<ul style="list-style-type: none"> <li>1 Non-operating</li> </ul>	12,192m (40,000 ft) max
Thermal dissipation	71.82 BTU/hour (maximum) 64.98 BTU/hour (typical)

## LCD Monitor Quality & Pixel Policy

During the LCD Monitor manufacturing process, it is not uncommon for one or more pixels to become fixed in an unchanging state. The visible result is a fixed pixel that appears as an extremely tiny dark or bright discolored spot. When the pixel remains permanently lit, it is known as a "bright dot." When the pixel remains black, it is known as a "dark dot." In almost every case, these fixed pixels are hard to see and do not detract from display quality or usability. A display with 1 to 5 fixed pixels is considered normal and within competitive standards. For more information, see Dell Support site at: [support.dell.com](http://support.dell.com).

## Maintenance Guidelines

### Caring for Your Monitor

-  **CAUTION:** Read and follow the [safety instructions](#) before cleaning the monitor.
-  **CAUTION:** Before cleaning the monitor, unplug the monitor power cable from the electrical outlet.

For best practices, follow the instructions in the list below while unpacking, cleaning, or handling your monitor:

- 1 To clean your antistatic screen, slightly dampen a soft, clean cloth with water. If possible, use a special screen-cleaning tissue or solution suitable for the antistatic coating. Do not use benzene, thinner, ammonia, abrasive cleaners, or compressed air.
- 1 Use a slightly dampened, warm cloth to clean the plastics. Avoid using detergent of any kind as some detergents leave a milky film on the plastics.
- 1 If you notice a white powder when you unpack your monitor, wipe it off with a cloth. This white powder occurs during the shipping of the monitor.
- 1 Handle your monitor with care as a darker-colored monitor may scratch and show white scuff marks more than a lighter-colored monitor.
- 1 To help maintain the best image quality on your monitor, use a dynamically changing screen saver and power off your monitor when not in use.

[Back to Contents Page](#)



[Back to Contents Page](#)

## Appendix

Dell™ E1910H Flat Panel Monitor User's Guide

- [Safety Instructions](#)
- [FCC Notice \(U.S. Only\) and Other Regulatory Information](#)
- [Contacting Dell](#)



### CAUTION: Safety Instructions



**CAUTION:** Use of controls, adjustments, or procedures other than those specified in this documentation may result in exposure to shock, electrical hazards, and/or mechanical hazards.

For information on safety instructions, see the *Product Information Guide*.

---

## FCC Notices (U.S. Only) and Other Regulatory Information

For FCC notices and other regulatory information, see the regulatory compliance website located at [www.dell.com/regulatory\\_compliance](http://www.dell.com/regulatory_compliance).

**This device complies with Part 15 of the FCC Rules. Operation is subject to the following two conditions**

- (1) this device may not cause harmful interference, and
  - (2) this device must accept any interference received, including interference that may cause undesired operation
- 

## Contacting Dell

For customers in the United States, call 800-WWW-DELL (800-999-3355).



**NOTE:** If you do not have an active Internet connection, you can find contact information on your purchase invoice, packing slip, bill, or Dell product catalog.

Dell provides several online and telephone-based support and service options. Availability varies by country and product, and some services may not be available in your area. To contact Dell for sales, technical support, or customer service issues:

1. Visit [support.dell.com](http://support.dell.com).
  2. Verify your country or region in the **Choose A Country/Region** drop-down menu at the bottom of the page.
  3. Click **Contact Us** on the left side of the page.
  4. Select the appropriate service or support link based on your need.
  5. Choose the method of contacting Dell that is convenient for you.
- 

[Back to Contents Page](#)

[Back to Contents Page](#)

## Setting Up Your Monitor

### Dell™ E1910H Flat Panel Monitor

---

#### **If you have a Dell™ desktop or a Dell™ portable computer with internet access**

1. Go to <http://support.dell.com>, enter your service tag, and download the latest driver for your graphics card.
2. After installing the drivers for your Graphics Adapter, attempt to set the resolution to **1366x768** again.

 **NOTE:** If you are unable to set the resolution to 1366x768, please contact Dell™ to inquire about a Graphics Adapter that supports these resolutions.

---

[Back to Contents Page](#)

[Back to Contents Page](#)

## Setting Up Your Monitor

Dell™ E1910H Flat Panel Monitor

---

### If you have a non Dell™ desktop, portable computer, or graphics card

1. Right-click on the desktop and click **Properties**.
2. Select the **Settings** tab.
3. Select **Advanced**.
4. Identify your graphics controller supplier from the description at the top of the window (e.g. NVIDIA, ATI, Intel etc.).
5. Refer to the graphic card provider website for updated driver (for example, <http://www.ATI.com> OR <http://www.NVIDIA.com>).
6. After installing the drivers for your Graphics Adapter, attempt to set the resolution to **1366x768** again.

 **NOTE:** If you are unable to set the resolution to 1366x768, please contact the manufacturer of your computer or consider purchasing a graphics adapter that will support the video resolution of 1366x768.

---

[Back to Contents Page](#)

## Operating the Monitor

Dell™ E1910H Flat Panel Monitor User's Guide

- [Using the Front Panel Controls](#)
- [Using the On-Screen Display \(OSD\) Menu](#)
- [Setting the Maximum Resolution](#)
- [Using the Dell Soundbar \(Optional\)](#)
- [Using the Tilt](#)

---

### Power On the Monitor

Press the  button to turn on the monitor

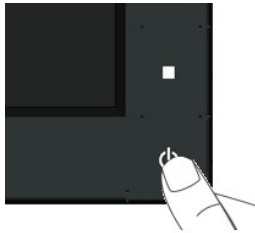



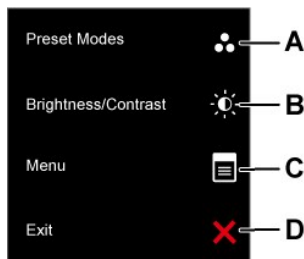

---

### Using the Front Panel Controls

Use the keys on the front of the monitor to adjust the image settings.







	Front panel Key	Description
A	 Preset modes	Use the Preset modes key to choose from a list of preset color modes. See <a href="#">Using the OSD Menu</a> .
B	 Brightness / Contrast	Use the Brightness / Contrast key to direct access to the "Brightness" and "Contrast" control menu.
C	 Menu	Use the Menu key to open the on-screen display(OSD).
D		

 Exit	Use the Exit key to exit on-screen display(OSD) from menu and sub-menus.
---	--

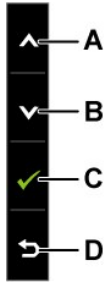
## Front panel Key

Use the [keys](#) on the front of the monitor to adjust the image settings.



Front panel Key		Description
A	 Up	Use the Up key to adjust (increase ranges) items in the OSD menu.
B	 Down	Use the Down key to adjust (decrease ranges) items in the OSD menu.
C	 OK	Use the OK key to confirm your selection.
D	 Back	Use the back key to back previous menu.

## Using the On-Screen Display (OSD) Menu

### Accessing the Menu System

 **NOTE:** If you change the settings and then either proceed to another menu or exit the OSD menu, the monitor automatically saves those changes. The changes are also saved if you change the settings and then wait for the OSD menu to disappear.

1. Press the  button to open the OSD menu and display the main menu.

Main Menu



2. Press the and buttons to toggle between options in the Menu. As you move from one icon to another, the option name is highlighted.
3. To select the highlighted item on the menu press the button again.
4. Press the and buttons to select the desired parameter.
5. Press the button to enter the slide bar and then use the or buttons, according to the indicators on the menu, to make your changes.
6. Select the to return to previous menu without accepting current settings or to accept and return to previous menu.

The table below provides a list of all the OSD menu options and their functions.

Icon	Menu and Submenus	Description
	BRIGHTNESS/CONTRAST	Use the Brightness and Contrast menu to adjust the Brightness/Contrast.
	Back	Press  to go back to the main menu.
	Brightness	Allows you to adjust the brightness or luminance of the backlight. Press the  key to increase brightness and press the  key to decrease brightness (min 0 ~ max 100).
	Contrast	Allows you to adjust the contrast or the degree of difference between darkness and lightness on the monitor screen. A contrast only if you need further adjustment. Press the  key to increase contrast and press the  key to decrease contrast (min 0 ~ max 100).
	Auto Adjust	Use this key to activate automatic setup and adjust menu. The following dialog appears on a black screen as the monit

## Auto Adjustment in Progress...

Auto Adjustment allows the monitor to self-adjust to the incoming video signal. After using Auto Adjustment, you can fine-tune the monitor's image quality using Pixel Clock (Coarse) and Phase (Fine) controls under Image Settings.

**NOTE:** Auto Adjust does not occur if you press the button while there are no active video input signals or attached cables.



### COLOR SETTINGS

Use the **Color Setting** menu to adjust the monitor's color settings.

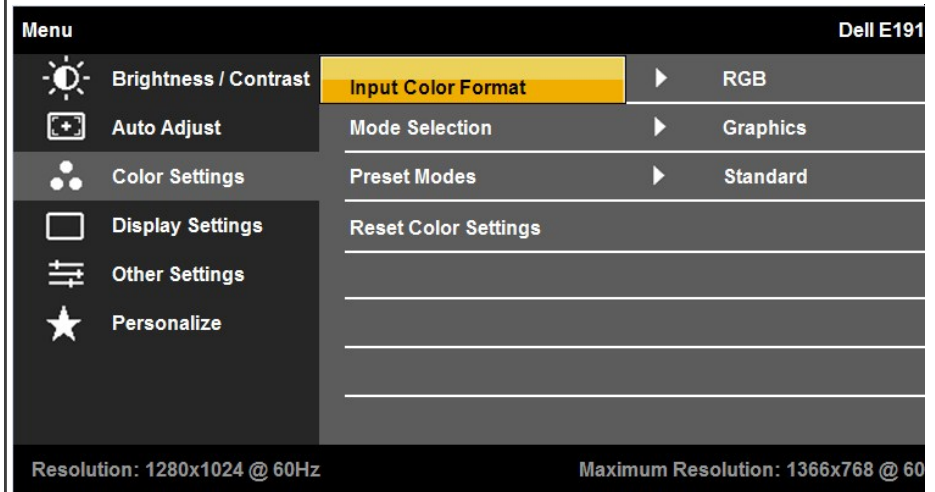

#### Back

Press  to go back to the main menu.

#### Input Color Format

Allows you to set the video input mode to:

- 1 **RGB:** Select this option if your monitor is connected to a computer or DVD player using the HDMI cable or the HDI
- 1 **YPbPr:** Select this option if your DVD player supports only YPbPr output.

#### Mode Selection

Allows you to set the display mode to:

- 1 **Graphics:** Select this mode if your monitor is connected to your computer.
- 1 **Video:** Select this mode if your monitor is connected to a DVD player.

**NOTE:** Depending upon the Display Mode you select the Preset Modes available for your monitor change.

#### Preset Mode

Allows you to choose from a list of preset color modes.

In the **Graphics** mode, you can set the color to the following preset values:

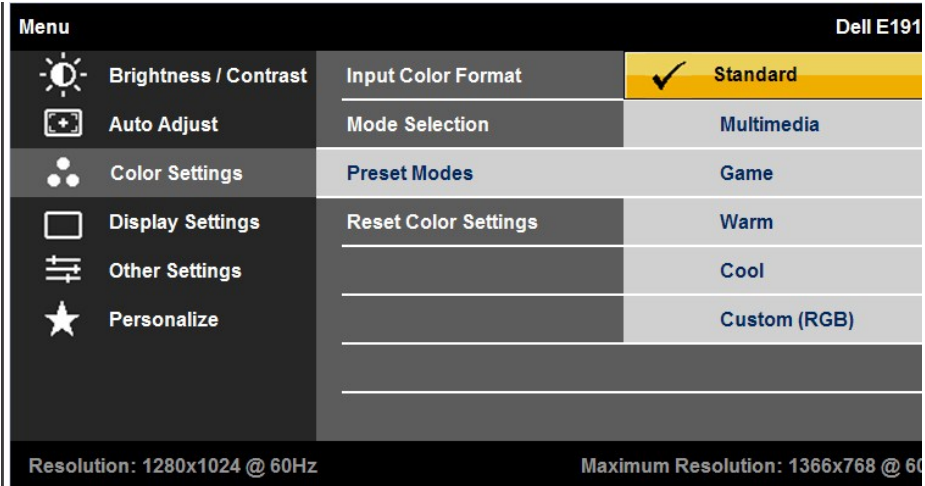

- 1 **Standard:** Loads the monitor's default color settings. This is the default preset mode.
- 1 **Multimedia:** Loads color settings ideal for multimedia applications.
- 1 **Game:** Loads color settings ideal for most gaming applications.
- 1 **Warm:** Increase the color temperature. The screen appears warmer with a red/yellow tint.
- 1 **Cool:** Decreases the color temperature. The screen appears cooler with a blue tint.
- 1 **Custom (RGB):** Allows you to manually adjust the color settings. press the and keys to adjust the Red, your own preset color mode.

In the **Video** mode, you can set the color to the following preset values:

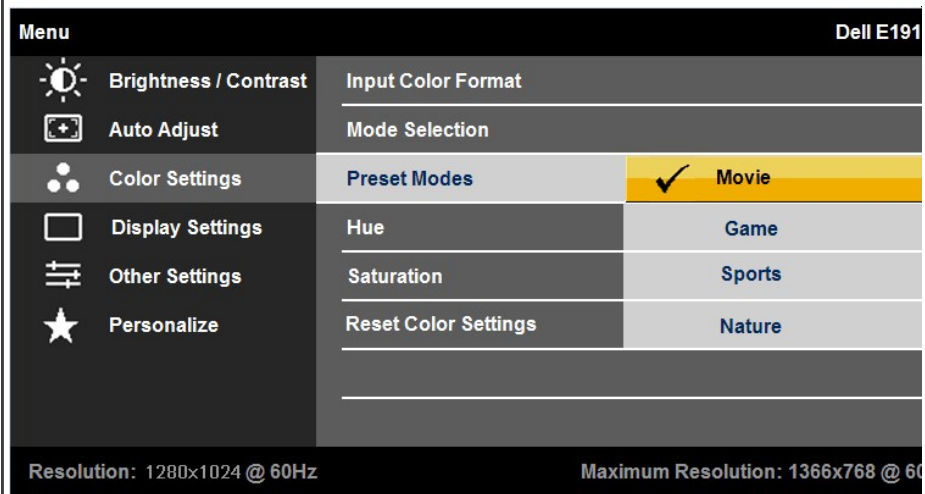

- 1 **Movie:** Loads color settings ideal for movies. This is the default preset mode.
- 1 **Game:** Loads color settings ideal for most gaming applications.
- 1 **Sports:** Loads color settings ideal for sports.
- 1 **Nature:** Loads color settings ideal for nature.

Hue

Allows you to adjust the skin tone of the image. Use or to adjust the hue from '0' to '100'.

Saturation

**NOTE:** Hue adjustment is available only in the **Video** mode.  
Allows you to adjust the color saturation of the image. Use or to adjust the saturation from '0' to '100'.

Reset Color Settings

**NOTE:** Saturation adjustment is available only in the **Video** mode.  
Resets your monitor's color settings to the factory defaults.



DISPLAY SETTINGS

Use the **Displays Settings** menu to adjust the monitor's display settings.



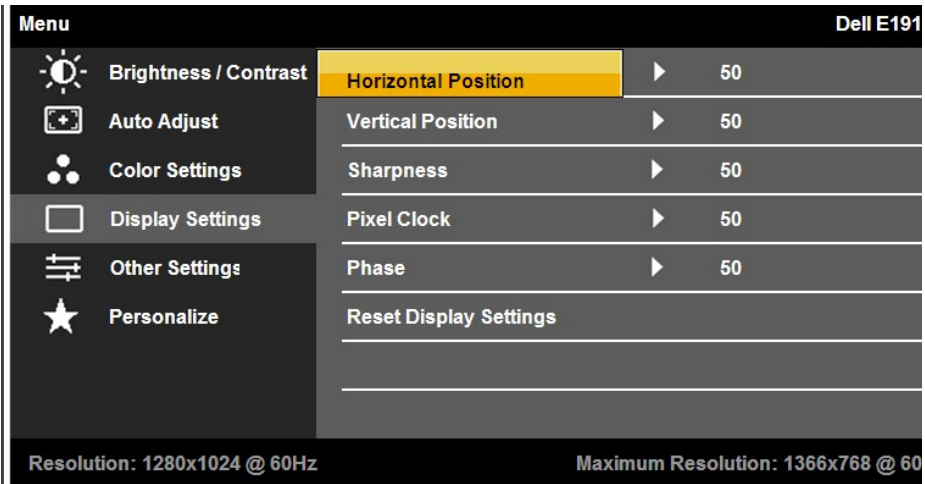

Back

Press to go back to the main menu.

Horizontal Position

Use the or buttons to adjust image left and right. Minimum is '0' (-). Maximum is '100' (+).

Vertical Position

Use the or buttons to adjust image up and down. Minimum is '0' (-). Maximum is '100' (+)

Sharpness

This feature can make the image look sharper or softer. Use or to adjust the sharpness from '0' to '100'

Pixel Clock

The Phase and Pixel Clock adjustments allow you to adjust your monitor to your preference. Use or buttons to

Phase

If satisfactory results are not obtained using the Phase adjustment, use the Pixel Clock (coarse) adjustment and then

Reset Display Settings

Select this option to restore default display settings.



OTHER SETTINGS

Select this option to adjust the settings of the OSD, such as, the languages of the OSD, the amount of time the menu r

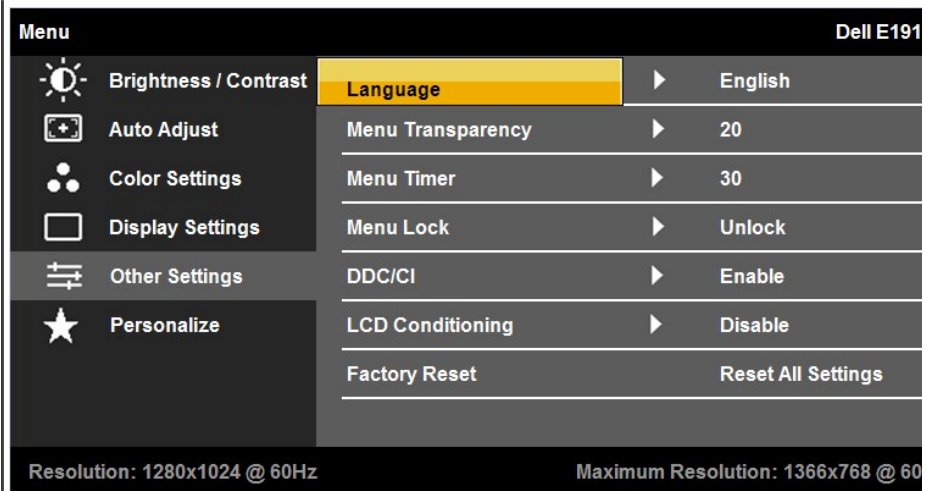





Back

Press to go back to the main menu.

Language

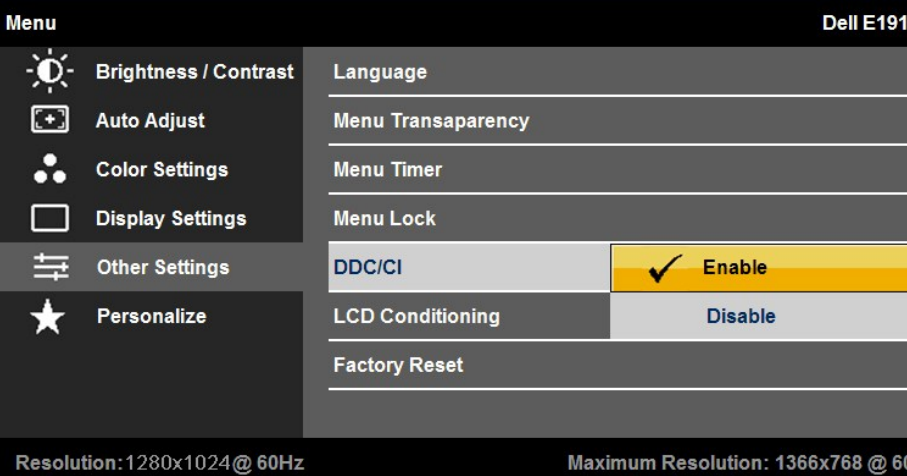
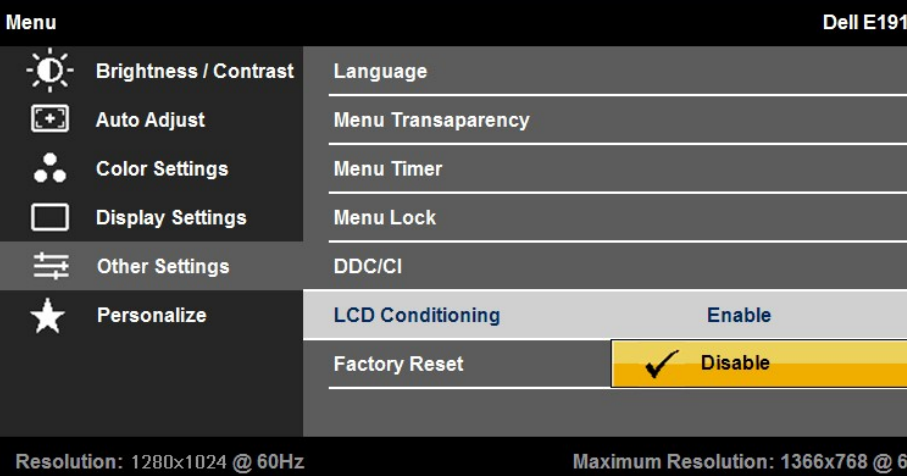
Allows you to set the OSD display to one of eight languages: English, Spanish, French, German, Japanese, Brazilian Por

Menu Transparency	Allows you to adjust the OSD background from opaque to transparent.
Menu Timer	Allows you to set the time for which the OSD remains active after you press a key on the monitor. Use the  and  keys to adjust the slider in 1 second increments, from 5 to 60 seconds.
Menu Lock	Controls user access to adjustments. When <b>Lock</b> is selected, no user adjustments are allowed. All keys are locked except the <b>Menu</b> key. <b>NOTE:</b> When the OSD is locked, pressing the menu key takes you directly to the OSD settings menu, with 'OSD Lock' present. hold  key for 15 seconds to unlock and allow user access to all applicable settings.
DDC/CI	DDC/CI (Display Data Channel/Command Interface) allows a software on your computer to adjust the monitor display settings such as brightness, contrast, color balance etc. <b>Enable</b> (Default): Optimizes the performance of your monitor and provides a better customer experience. <b>Disable:</b> Disables the DDC/CI option and the following message appears on the screen.  <p>The screenshot shows the OSD menu for a Dell E1915 monitor. The 'DDC/CI' option is highlighted in yellow and set to 'Enable'. Other options include 'Language', 'Menu Transparency', 'Menu Timer', 'Menu Lock', 'LCD Conditioning' (set to 'Disable'), and 'Factory Reset'. The bottom of the screen displays 'Resolution: 1280x1024 @ 60Hz' and 'Maximum Resolution: 1366x768 @ 60Hz'.</p>
LCD Conditioning	Helps reduce minor cases of image retention. Depending on the degree of image retention, the program may take some time to complete the feature by selecting "Enable".  <p>The screenshot shows the OSD menu for a Dell E1915 monitor. The 'LCD Conditioning' option is highlighted in yellow and set to 'Enable'. Other options include 'Language', 'Menu Transparency', 'Menu Timer', 'Menu Lock', 'DDC/CI', and 'Factory Reset' (set to 'Disable'). The bottom of the screen displays 'Resolution: 1280x1024 @ 60Hz' and 'Maximum Resolution: 1366x768 @ 60Hz'.</p>
Factory Reset	Resets all OSD settings to the factory preset values.
 Personalize	Allows you to adjust shortcut key for: 1. Preset modes, 2. Brightness / Contrast, 3. Auto Adjust.

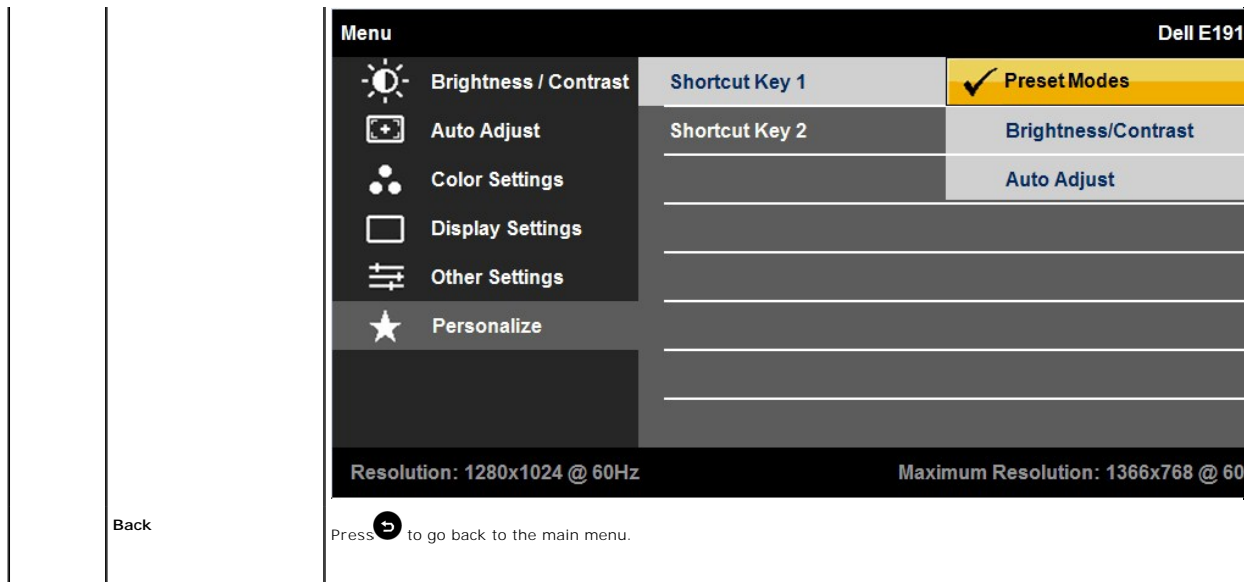

## OSD Warning Messages

When the monitor does not support a particular resolution mode you will see the following message:

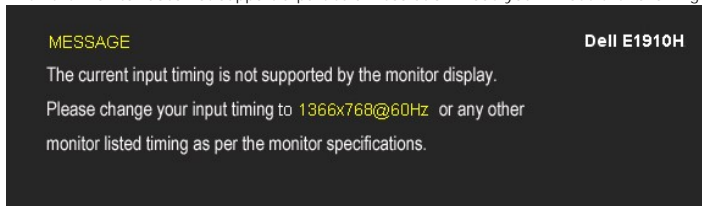

This means that the monitor cannot synchronize with the signal that it is receiving from the computer. See [Monitor Specifications](#) for the Horizontal and Vertical frequency ranges addressable by this monitor. Recommended mode is 1366 x 768.

You will see the following message before the DDC/CI function is disabled.

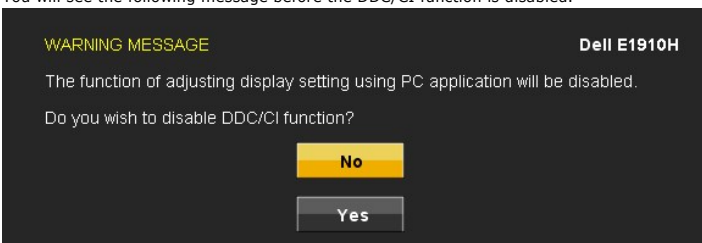

When the monitor enters the Power Save mode, the following message appears:



Activate the computer and wake up the monitor to gain access to the [OSD](#)

If you press any button other than the power button the following messages will appear depending on the selected input:

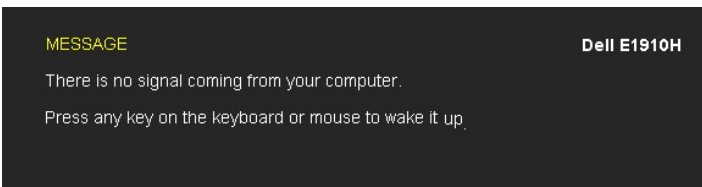

If VGA cable is not connected, a floating dialog box as shown below appears.

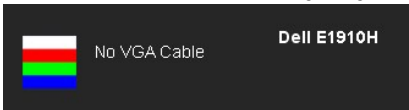

See [Solving Problems](#) for more information.

---

## Setting the Maximum Resolution

To set the Maximum resolution for the monitor:

1. Right-click on the desktop and select **Properties**.
2. Select the **Settings** tab.
3. Set the screen resolution to 1366 x 768.
4. Click **OK**.

If you do not see 1366 x 768 as an option, you may need to update your graphics driver. Depending on your computer, complete one of the following procedures:

1. If you have a Dell desktop or portable computer:
  - o Go to [support.dell.com](http://support.dell.com), enter your service tag, and download the latest driver for your graphics card.
1. If you are using a non-Dell computer (portable or desktop):
  - o Go to the support site for your computer and download the latest graphic drivers.
  - o Go to your graphics card website and download the latest graphic drivers.

---

## Using the Dell Soundbar (Optional)

The Dell Soundbar is a stereo two channel system, mountable on Dell Flat Panel Displays. The Soundbar has a rotary volume and on/off control to adjust the overall system level, a LED for power indication, and two audio headset jacks.



1.	Power/volume control
2.	Power indicator
3.	Headphone connectors

---

## Using the Tilt

### Tilt

With the built-in pedestal, you can tilt the monitor for the most comfortable viewing angle.

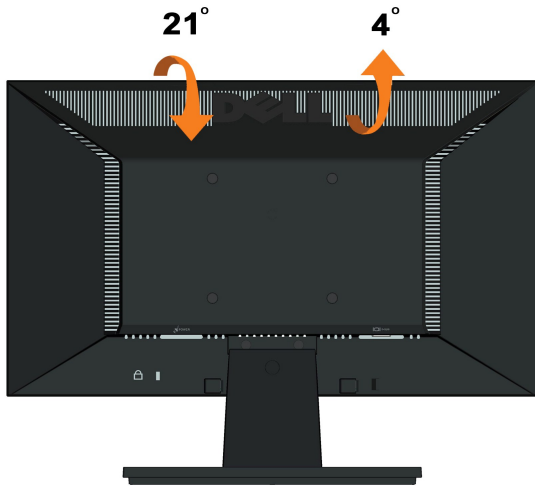

 **NOTE:** The stand is detached when the monitor is shipped from the factory.

---

[Back to Contents Page](#)

[Back to Contents Page](#)

## Setting Up Your Monitor

**Dell™ E1910H Flat Panel Monitor**

---

### Setting the display resolution to 1366X768 (Maximum)

For optimal display performance while using the Microsoft Windows operating systems, set the display resolution to 1366 x 768 pixels by performing the following steps:

1. Right-click on the desktop and click **Properties**.
2. Select the **Settings** tab.
3. Move the slider-bar to the right by pressing and holding left-mouse button and adjust the screen resolution to **1366 X 768**.
4. Click **OK**.

If you do not see **1366 X 768** as an option, you may need to update your graphics driver. Please choose the scenario below that best describes the computer system you are using, and follow the provided directions:

**1: [If you have a Dell™ desktop or a Dell™ portable computer with internet access.](#)**

**2: [If you have a non Dell™ desktop, portable computer, or graphics card.](#)**

---

[Back to Contents Page](#)

# Dell™ E1910H Flat Panel Monitor

[User Guide](#)

[Setting the display resolution to 1366x768\(Maximum\)](#)

---

Information in this document is subject to change without notice.

© 2009 Dell Inc. All rights reserved

Reproduction of these materials in any manner whatsoever without the written permission of Dell Inc. is strictly forbidden.

Trademarks used in this text: *Dell* and the *DELL* logo are trademarks of Dell Inc.; *Microsoft* and *Windows* are either registered trademarks or trademarks of Microsoft Corporation in the United States and/or other countries. *ENERGY STAR* is a registered trademark of the U.S. Environmental Protection Agency. As an ENERGY STAR partner, Dell Inc. has determined that this product meets the ENERGY STAR guidelines for energy efficiency.

Other trademarks and trade names may be used in this document to refer to either the entities claiming the marks and names or their products. Dell Inc. disclaims any proprietary interest in trademarks and trade names other than its own.

---

Model E1910Hc

March 2009 Rev. A00

[Back to Contents Page](#)

## Setting Up the Monitor

Dell™ E1910H Flat Panel Monitor User's Guide

- [Attaching the Stand](#)
- [Connecting Your Monitor](#)
- [Removing the Stand Base](#)
- [Attaching the Dell Soundbar \(Optional\)](#)
- [Removing the Stand for VESA wall mount](#)

---

### Attaching the Stand

 **NOTE:** The stand is detached when the monitor is shipped from the factory.

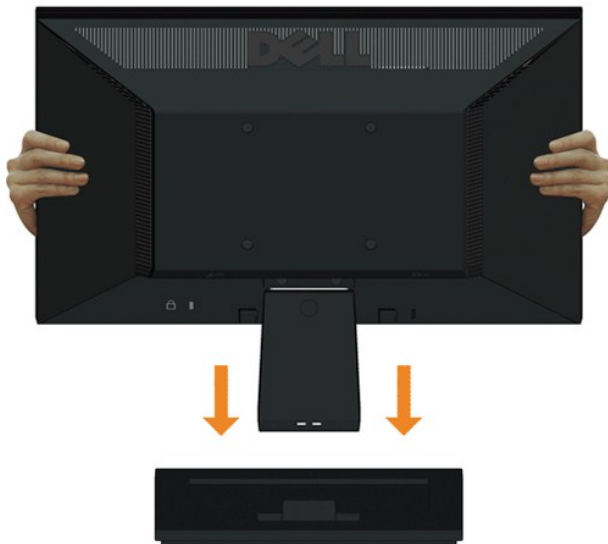

To attach the base of the stand to the monitor stand:

1. Place the monitor stand base on a stable table top.
2. Slide the monitor stand body in the correct direction down onto the back until it clicks into place.

---

### Connecting Your Monitor

 **CAUTION:** Before you begin any of the procedures in this section, follow the [Safety Instructions](#).

To connect your monitor to the computer:

1. Turn off your computer and disconnect the power cable.
2. Connect the blue display connector cable to the corresponding video port on the back of your computer.

### Connecting the Blue VGA Cable



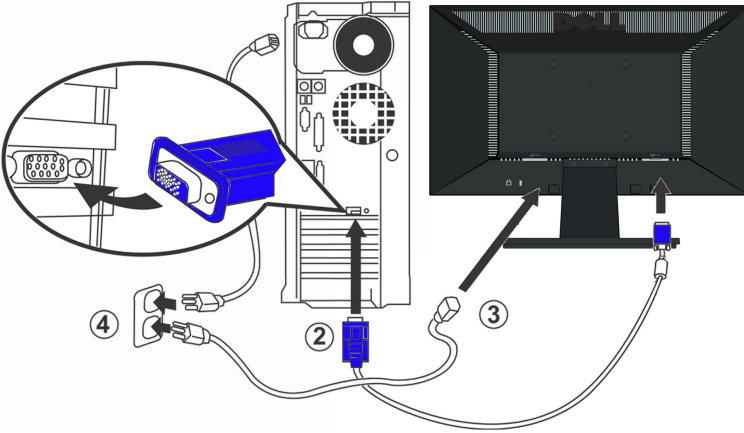

**CAUTION:** The Graphics are used for the purpose of illustration only. Appearance of the computer may vary.

### Removing the Stand Base

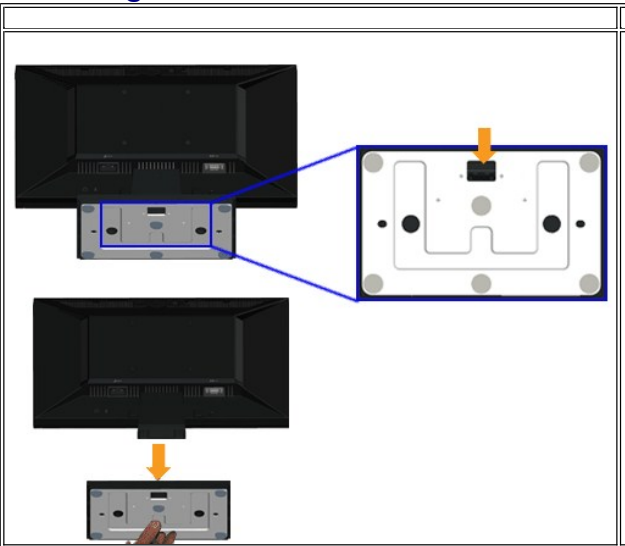

To remove the base of the stand from the monitor:

1. Place the monitor panel on soft cloth or cushion on a stable flat table.
2. Press and hold the release latch, while pulling the base of the stand away from the monitor.

### Attaching the Dell Soundbar (Optional)



**NOTICE:** Do not use with any device other than the Dell Soundbar.

To attach the soundbar:

1. Working from the back of the monitor, attach Soundbar by aligning the two slots with the two tabs along the bottom of the monitor.
2. Slide the Soundbar to the left until it snaps into place.
3. Connect the Soundbar with the DC power connector from the Soundbar Power Adaptor.
4. Insert the mini stereo plug from the back of the Soundbar into the computer's audio output jack.

## Removing the Stand for VESA Wall Mount

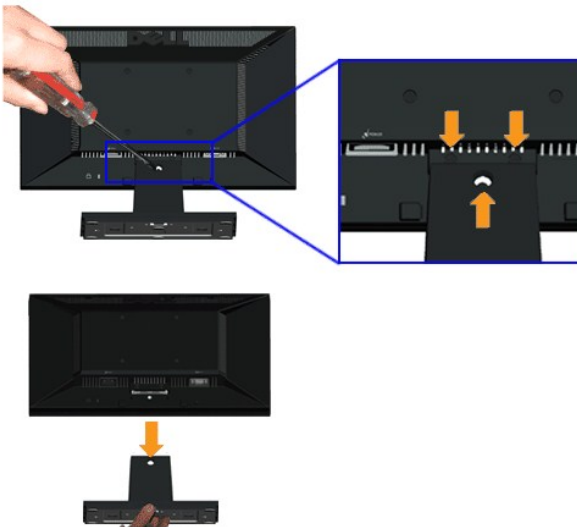

To remove the stand assembly from the monitor:

1. Place the monitor panel on soft cloth or cushion on a stable flat table.
2. Remove the three screws on the stand of the monitor as shown above.
3. Remove the stand assembly from the monitor.

[Back to Contents Page](#)

## Troubleshooting

### Dell™ E1910H Flat Panel Monitor

- [Self-Test](#)
- [Common Problems](#)
- [Product Specific Problems](#)

**⚠ CAUTION:** Before you begin any of the procedures in this section, follow the [Safety Instructions](#).

---

### Self-Test

Your monitor provides a self-test feature that allows you to check whether your monitor is functioning properly. If your monitor and computer are properly connected but the monitor screen remains dark, run the monitor self-test by performing the following steps:

1. Turn off both your computer and the monitor.
2. Unplug the video cable from the back of the computer. To ensure a proper Self-Test operation, remove the Analog (blue connector) cable from the back of computer.
3. Turn on the monitor.

The floating dialog box should appear on-screen (against a black background) if the monitor cannot sense a video signal and is working correctly. While in self-test mode, the power LED remains blue. Also, depending upon the selected input, the dialog shown below will continuously scroll through the screen.

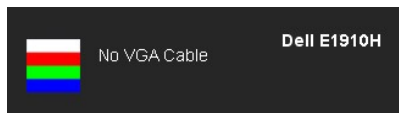

4. This box also appears during normal system operation, if the video cable becomes disconnected or damaged.
5. Turn off your monitor and reconnect the video cable; then turn on both your computer and the monitor.

If your monitor screen remains blank after you use the previous procedure, check your video controller and computer, because your monitor is functioning properly.

**🔧 NOTE:** Self-test feature check is not available for S-Video, Composite, and Component video modes.

---

### Built-in Diagnostics

Your monitor has a built-in diagnostic tool that helps you determine if the screen abnormality you are experiencing is an inherent problem with your monitor, or with your computer and video card.

**🔧 NOTE:** You can run the built-in diagnostics only when the video cable is unplugged and the monitor is in *self-test mode*.

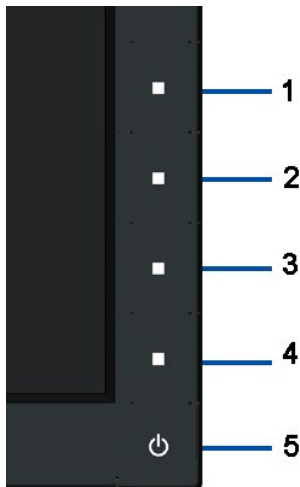

To run the built-in diagnostics:

1. Ensure that the screen is clean (no dust particles on the surface of the screen).
2. Unplug the video cable from the back of the computer or monitor. The monitor then goes into the self-test mode.
3. Press and hold the 1st and 4th buttons on the front panel, simultaneously for 2 seconds. A gray screen appears.
4. Carefully inspect the screen for abnormalities.
5. Press the 4th button on the front panel again. The color of the screen changes to red.
6. Inspect the display for any abnormalities.
7. Repeat steps 5 and 6 to inspect the display in green, blue, and white colored screens.

The test is complete when the white screen appears. To exit, press the 4th button again.

If you do not detect any screen abnormalities upon using the built-in diagnostic tool, the monitor is functioning properly. Check the video card and computer.

## Common Problems

The following table contains general information about common monitor problems you might encounter and the possible solutions.

Common Symptoms	What You Experience	Possible Solutions
No Video/Power LED off	No picture	<ul style="list-style-type: none"> <li>1 Ensure that the video cable connecting the monitor and the computer is properly connected and secure.</li> <li>1 Verify that the power outlet is functioning properly using any other electrical equipment.</li> <li>1 Ensure that the power button is depressed fully.</li> </ul>
No Video/Power LED on	No picture or no brightness	<ul style="list-style-type: none"> <li>1 Increase brightness &amp; contrast controls via OSD.</li> <li>1 Perform monitor self-test feature check.</li> <li>1 Check for bent or broken pins in the video cable connector.</li> <li>1 Run the built-in diagnostics.</li> </ul>
Poor Focus	Picture is fuzzy, blurry, or ghosting	<ul style="list-style-type: none"> <li>1 Perform Auto Adjust via OSD.</li> <li>1 Adjust the Phase and Pixel Clock controls via OSD.</li> <li>1 Eliminate video extension cables.</li> <li>1 Reset the monitor to Factory Settings.</li> <li>1 Change the video resolution to the correct aspect ration (16:9).</li> </ul>
Shaky/Jittery Video	Wavy picture or fine movement	<ul style="list-style-type: none"> <li>1 Perform Auto Adjust via OSD.</li> <li>1 Adjust the Phase and Pixel Clock controls via OSD.</li> <li>1 Reset the monitor to Factory Settings.</li> <li>1 Check environmental factors.</li> <li>1 Relocate the monitor and test in another room.</li> </ul>
Missing Pixels	LCD screen has spots	<ul style="list-style-type: none"> <li>1 Cycle power on-off.</li> <li>1 Pixel that is permanently off is a natural defect that can occur in LCD technology.</li> <li>1 Run the built-in diagnostics.</li> </ul>
Stuck-on Pixels	LCD screen has bright spots	<ul style="list-style-type: none"> <li>1 Cycle power on-off.</li> <li>1 Pixel that is permanently off is a natural defect that can occur in LCD technology.</li> <li>1 Run the built-in diagnostics.</li> </ul>
Brightness Problems	Picture too dim or too bright	<ul style="list-style-type: none"> <li>1 Reset the monitor to Factory Settings.</li> <li>1 Auto Adjust via OSD.</li> <li>1 Adjust brightness &amp; contrast controls via OSD.</li> </ul>
Geometric Distortion	Screen not centered correctly	<ul style="list-style-type: none"> <li>1 Reset the monitor to Factory Settings.</li> <li>1 Auto Adjust via OSD.</li> <li>1 Adjust brightness &amp; contrast controls via OSD.</li> </ul>
Horizontal/Vertical Lines	Screen has one or more lines	<ul style="list-style-type: none"> <li>1 Reset the monitor to Factory Settings.</li> <li>1 Perform Auto Adjust via OSD.</li> <li>1 Adjust Phase and Pixel Clock controls via OSD.</li> <li>1 Perform monitor self-test feature check and determine if these lines are also in self-test mode.</li> <li>1 Check for bent or broken pins in the video cable connector.</li> <li>1 Run the built-in diagnostics.</li> </ul>
Synchronization Problems	Screen is scrambled or appears torn	<ul style="list-style-type: none"> <li>1 Reset the monitor to Factory Settings.</li> <li>1 Perform Auto Adjust via OSD.</li> <li>1 Adjust Phase and Pixel Clock controls via OSD.</li> <li>1 Perform monitor self-test feature check to determine if the scrambled screen appears in self-test mode.</li> <li>1 Check for bent or broken pins in the video cable connector.</li> <li>1 Restart the computer in the <i>safe mode</i>.</li> </ul>
Safety Related Issues	Visible signs of smoke or sparks	<ul style="list-style-type: none"> <li>1 Do not perform any troubleshooting steps.</li> <li>1 Contact Dell immediately.</li> </ul>
Intermittent Problems	Monitor malfunctions on & off	<ul style="list-style-type: none"> <li>1 Ensure that the video cable connecting the monitor to the computer is connected properly and is secure.</li> <li>1 Reset the monitor to Factory Settings.</li> <li>1 Perform monitor self-test feature check to determine if the intermittent problem occurs in self-test mode.</li> </ul>
Missing Color	Picture missing color	<ul style="list-style-type: none"> <li>1 Perform monitor self-test feature check.</li> <li>1 Ensure that the video cable connecting the monitor to the computer is connected properly and is secure.</li> <li>1 Check for bent or broken pins in the video cable connector.</li> </ul>

Wrong Color	Picture color not good	<ul style="list-style-type: none"> <li>1 Change the Color Setting Mode in the Color Settings OSD to Graphics or Video depending on the application.</li> <li>1 Try different Color Preset Settings in Color Settings OSD. Adjust R/G/B value in Color Settings OSD if the Color Management is turned off.</li> <li>1 Change the Input Color Format to PC RGB or YPbPr in the Advance Setting OSD.</li> <li>1 Run the built-in diagnostics.</li> </ul>
Image retention from a static image left on the monitor for a long period of time	Faint shadow from the static image displayed appears on the screen	<ul style="list-style-type: none"> <li>1 Use the Power Management feature to turn off the monitor at all times when not in use (for more information, see <a href="#">Power Management Modes</a>).</li> <li>1 Alternatively, use a dynamically changing screensaver.</li> <li>1 In OSD Menu, under Reset to Factory Settings, select Enable LCD Conditioning. Using this option may take several hours before the image is eliminated.</li> <li>1 <b>NOTE:</b> Image Burn-in is not covered by your warranty.</li> </ul>

## Product Specific Problems

Specific Symptoms	What You Experience	Possible Solutions
Screen image is too small	Image is centered on screen, but does not fill entire viewing area	<ul style="list-style-type: none"> <li>1 Reset the monitor to Factory Settings.</li> </ul>
Cannot adjust the monitor with the buttons on the front panel	OSD does not appear on the screen	<ul style="list-style-type: none"> <li>1 Turn off the monitor, unplug the power cord, plug back, and then turn on the monitor.</li> </ul>
No Input Signal when user controls are pressed	No picture, the LED light is blue. When press "up", "down" or "Menu" key, the message "No input signal " will appear.	<ul style="list-style-type: none"> <li>1 Check the signal source. Ensure the Computer is not in the power saving mode by moving the mouse or pressing any key on the keyboard.</li> <li>1 <b>Check whether the signal cable is plugged in properly. Re-plug the signal cable if necessary.</b></li> <li>1 Reset the computer or video player.</li> </ul>
The picture does not fill the entire screen.	The picture cannot fill the height or width of the screen	<ul style="list-style-type: none"> <li>1 Due to different video formats (aspect ratio) of DVDs, the monitor may display in full screen.</li> <li>1 Run the built-in diagnostics.</li> </ul>

[Back to Contents Page](#)

## Free Manuals Download Website

<http://myh66.com>

<http://usermanuals.us>

<http://www.somanuals.com>

<http://www.4manuals.cc>

<http://www.manual-lib.com>

<http://www.404manual.com>

<http://www.luxmanual.com>

<http://aubethermostatmanual.com>

Golf course search by state

<http://golfingnear.com>

Email search by domain

<http://emailbydomain.com>

Auto manuals search

<http://auto.somanuals.com>

TV manuals search

<http://tv.somanuals.com>