



# **Citrix NetScaler Hardware Installation and Setup Guide**

**Citrix NetScaler 9.3**

## Copyright and Trademark Notice

Copyright © 2013 Citrix Systems, Inc. All rights reserved. NO PART OF THIS DOCUMENT MAY BE REPRODUCED OR TRANSMITTED IN ANY FORM OR BY ANY MEANS OR USED TO MAKE DERIVATIVE WORK (SUCH AS TRANSLATION, TRANSFORMATION, OR ADAPTATION) WITHOUT THE EXPRESS WRITTEN PERMISSION OF CITRIX SYSTEMS, INC.

ALTHOUGH THE MATERIAL PRESENTED IN THIS DOCUMENT IS BELIEVED TO BE ACCURATE, IT IS PRESENTED WITHOUT WARRANTY OF ANY KIND, EXPRESS OR IMPLIED. USERS MUST TAKE ALL RESPONSIBILITY FOR THE USE OR APPLICATION OF THE PRODUCT(S) DESCRIBED IN THIS MANUAL.

CITRIX SYSTEMS, INC. OR ITS SUPPLIERS DO NOT ASSUME ANY LIABILITY THAT MAY OCCUR DUE TO THE USE OR APPLICATION OF THE PRODUCT(S) DESCRIBED IN THIS DOCUMENT. INFORMATION IN THIS DOCUMENT IS SUBJECT TO CHANGE WITHOUT NOTICE. COMPANIES, NAMES, AND DATA USED IN EXAMPLES ARE FICTITIOUS UNLESS OTHERWISE NOTED.

This equipment has been tested and found to comply with the limits for a Class A digital device, pursuant to part 15 of the FCC Rules. These limits are designed to provide reasonable protection against harmful interference when the equipment is operated in a commercial environment. This equipment generates, uses, and can radiate radio-frequency energy and, if not installed and used in accordance with the instruction manual, may cause harmful interference to radio communications. Operation of this equipment in a residential area is likely to cause harmful interference in which case the user will be required to correct the interference at his or her own expense.

Pursuant to the rules and regulations of the Federal Communications Commission, changes or modifications to this product not expressly approved by Citrix Systems, Inc., could void your authority to operate the product. Note the FCC rules and regulations are not included for software products, such as virtual appliances.

AppCache, AppCompress, AppDNA, App-DNA, AppFlow, AppScaler, Apptitude, Citrix, Citrix Access Gateway, Citrix Application Firewall, Citrix Cloud Center, Citrix Systems, Citrix XenApp, CloudGateway, CloudBridge, CloudPortal, CloudStack, EdgeSight, Flex Tenancy, HDX, ICA, MPX, nCore, NetScaler, NetScaler App Delivery Controller, NetScaler Access Gateway, NetScaler App Firewall, NetScaler CloudConnector, NetScaler Gateway, NetScaler SDX, Netviewer, Network Link, SecureICA, VMLogix LabManager, VMLogix StageManager, VPX, Xen, Xen Source, XenApp, XenAppliance, XenCenter, XenClient, XenDesktop, XenEnterprise, XenServer, XenSource, Xen Data Center, and Zenprise are trademarks of Citrix Systems, Inc. and/or one of its subsidiaries, and may be registered in the U.S. and other countries. Other product and company names mentioned herein may be trademarks of their respective companies.

All rights reserved.

Last Updated: November 2013

Document code: December 26 2013 23:21:11

---

# Contents

<b>Preface</b> .....	<b>7</b>
Formatting Conventions for NetScaler Documentation .....	7
Documentation Available on the NetScaler Appliance .....	8
Getting Service and Support .....	9
NetScaler Documentation Feedback .....	9
<b>1 Introduction to the Hardware Platforms</b> .....	<b>11</b>
Common Hardware Components .....	12
LCD Display.....	12
Ports .....	16
RS232 Serial Port.....	17
Copper Ethernet Ports.....	17
Management Ports.....	17
1G SFP, 10G SFP+, and XFP Ports.....	17
1G Pluggable Media.....	18
10 GE Pluggable Media.....	20
LED Port-Status Indicators.....	23
Field Replaceable Units.....	26
Power Supply .....	26
CompactFlash Card.....	30
Solid-State Drive.....	33
Hard Disk Drive.....	35
Direct Attach Cable.....	36
Hardware Platforms .....	38
Citrix NetScaler 9010 FIPS.....	38
Citrix NetScaler 12000-10G.....	39
Citrix NetScaler MPX 5500.....	41
Citrix NetScaler MPX 5550 and MPX 5650.....	42
Citrix NetScaler MPX 7500 and MPX 9500.....	43
Citrix NetScaler MPX 8200, MPX 8400, MPX 8600, and MPX 8800.....	45
Citrix NetScaler MPX 9700, MPX 10500, MPX 12500, and MPX 15500 .....	47

Citrix NetScaler MPX 11500, MPX 13500, MPX 14500, MPX 16500, MPX 18500, and MPX 20500 .....	50
Citrix NetScaler MPX 15000.....	51
Citrix NetScaler MPX 17000.....	53
Citrix NetScaler MPX 17500, MPX 19500, and MPX 21500.....	54
Citrix NetScaler MPX 17550, MPX 19550, MPX 20550, and MPX 21550.....	56
Citrix NetScaler MPX 22040, MPX 22060, MPX 22080, MPX 22100, and MPX 22120.....	57
Summary of Hardware Specifications .....	59
<b>2 Preparing for Installation.....</b>	<b>69</b>
Unpacking the Appliance .....	70
Preparing the Site and Rack .....	71
Site Requirements.....	71
Rack Requirements.....	71
Cautions and Warnings.....	72
Electrical Safety Precautions.....	72
Appliance Precautions.....	73
Rack Precautions.....	74
<b>3 Installing the Hardware.....</b>	<b>75</b>
Rack Mounting the Appliance .....	76
To remove the inner rails from the rail assembly.....	77
To attach the inner rails to the appliance.....	77
To install the rack rails on the rack.....	78
To install the appliance in the rack.....	79
Installing and Removing 1G SFP Transceivers .....	80
To install a 1G SFP transceiver.....	81
To remove a 1G SFP transceiver.....	82
Installing and Removing XFP and 10G SFP+ Transceivers .....	82
To install an XFP/10G SFP+ transceiver.....	83
To remove an XFP/10G SFP+ transceiver.....	84
Connecting the Cables .....	85
Connecting the Ethernet Cables.....	85
To connect an Ethernet cable to a 10/100/1000BASE-T port or 1G SFP copper transceiver.....	85
To connect the Ethernet cable to a 1G SFP fiber, 10G SFP+, or XFP transceiver.....	86
Connecting the Console Cable.....	86
To connect the console cable to a computer or terminal.....	86

---

Connecting the Power Cable.....	86
To connect the appliance to the power source.....	87
Switching on the Appliance.....	87
To switch on the appliance.....	87
<b>4 Initial Configuration.....</b>	<b>89</b>
Using the LCD Keypad.....	90
Using the NetScaler Serial Console .....	91
To configure initial settings by using a serial console.....	91
Using the Setup Wizard .....	93
To configure initial settings by using the Setup Wizard.....	93
Using DHCP for Initial Access .....	94
Prerequisites.....	95
To configure a Linux/UNIX DHCP server for the NetScaler appliance.....	95
Sample DHCP configuration (dhcpd.conf).....	96
Implementing an Initial NetScaler Configuration from a Remote Computer.....	96
To find the SNIP address from the NetScaler console.....	97
To find the SNIP address from the DHCP server.....	97
Using DHCP When a Configuration File is Present.....	98
Accessing a NetScaler by Using SSH Keys and No Password.....	99
To generate the keys and connect to a remote NetScaler by using SSH keys.....	99
Changing the Administrative Password.....	101
To change the administrative password by using the configuration utility.....	101
To change the administrative password by using the command line interface.....	102
<b>5 Lights Out Management Port of the NetScaler Appliance.....</b>	<b>103</b>
Accessing the LOM Port by using a Web Browser.....	104
Configuring the LOM Port.....	104
To Configure the NetScaler LOM Port.....	104
Power Cycling the Appliance.....	105
To power cycle the appliance.....	105
Performing a Core Dump .....	105
To perform a core dump.....	105
Accessing the Appliance by using the Access Console.....	105
Obtaining Properties of the Host.....	106
Obtaining Health Monitoring Information.....	106
Obtaining the MAC Address and the Serial Number of the Appliance.....	106
Power Control Operations using the LOM Port.....	107
<b>6 Migrating the Configuration of an Existing NetScaler Appliance to Another Appliance.....</b>	<b>109</b>

## Contents

---

To migrate a configuration.....	110
---------------------------------	-----

---

# Preface

Learn about the Citrix® NetScaler® collection of documentation, including information about support options and ways to send us feedback.

## In This Preface:

- ◆ Formatting Conventions for NetScaler Documentation
- ◆ Documentation Available on the NetScaler Appliance
- ◆ Getting Service and Support
- ◆ NetScaler Documentation Feedback

For information about new features and enhancements for this release, see the *Citrix NetScaler 9.3 Release Notes* at <http://support.citrix.com/article/CTX128669>.

## Formatting Conventions for NetScaler Documentation

The NetScaler documentation uses the following formatting conventions.

**Table 1. Formatting Conventions**

Convention	Meaning
<b>Boldface</b>	In text paragraphs or steps in a procedure, information that you type exactly as shown (user input), or an element in the user interface.
Monospace	Text that appears in a command-line interface. Used for examples of command-line procedures. Also used to distinguish interface terms, such as names of directories and files, from ordinary text.
<angle brackets>	A term enclosed in angle brackets is a variable placeholder, to be replaced with an appropriate value. Do not enter the angle brackets.

Convention	Meaning
[ brackets ]	<p>Optional items in command statements. For example, in the following command, [ -range &lt;positiveInteger&gt; ] means that you have the option of entering a range, but it is not required:</p> <pre>add lb vserver &lt;name&gt; &lt;serviceType&gt; &lt;IPAddress&gt; &lt;port&gt; [ -range &lt;positiveInteger&gt;]</pre> <p>Do not type the brackets themselves.</p>
(vertical bar)	<p>A separator between options in braces or brackets in command statements. For example, the following indicates that you choose one of the following load balancing methods:</p> <pre>&lt;lbMethod&gt; = ( ROUNDROBIN   LEASTCONNECTION   LEASTRESPONSETIME   URLHASH   DOMAINHASH   DESTINATIONIPHASH   SOURCEIPHASH   SRCIPDESTIPHASH   LEASTBANDWIDTH   LEASTPACKETS   TOKEN   SRCIPSRCPORHASH   LRTM   CALLIDHASH   CUSTOMLOAD )</pre>
... (ellipsis)	<p>You can repeat the previous item or items in command statements. For example, /route:&lt;DeviceName&gt;[ ,...] means you can type additional &lt;DeviceNames&gt; separated by commas.</p>

## Documentation Available on the NetScaler Appliance

A complete set of Citrix® NetScaler® documentation is available on the **Documentation** tab of your NetScaler appliance and at <http://support.citrix.com/> (PDF version), and at <http://edocs.citrix.com> (HTML version). (The PDF version of the documents require Adobe Reader, available at [http://adobe.com/.](http://adobe.com/))

### To view the documentation

1. From a Web browser, log on to the NetScaler Appliance.
2. Click the **Documentation** tab.



3. To view a short description of each document, hover the mouse pointer over the title. To open a document, click the title.

## Getting Service and Support

Citrix® offers a variety of resources for support with your Citrix environment, including the following:

- ◆ The Knowledge Center is a self-service, Web-based technical support database that contains thousands of technical solutions, including access to the latest hotfixes, service packs, and security bulletins.
- ◆ Technical Support Programs for both software support and appliance maintenance are available at a variety of support levels.
- ◆ The Subscription Advantage program is a one-year membership that gives you an easy way to stay current with the latest product version upgrades and enhancements.
- ◆ Citrix Education provides official training and certification programs on virtually all Citrix products and technologies.

For more information about Citrix services and support, see the Citrix Systems Support Web site at <http://www.citrix.com/lang/English/support.asp>.

You can also participate in and follow technical discussions offered by the experts on various Citrix products at the following sites:

- ◆ <http://community.citrix.com>
- ◆ <http://twitter.com/citrixsupport>
- ◆ <http://forums.citrix.com/support>

## NetScaler Documentation Feedback

You are encouraged to provide feedback and suggestions so that we can enhance the documentation. You can send an email to [nsdocs\\_feedback@citrix.com](mailto:nsdocs_feedback@citrix.com). In the subject line, specify "Documentation Feedback." Please include the title of the guide and the page number in the email message.

You can also provide feedback through the Knowledge Center at <http://support.citrix.com/>.

**To provide feedback at the Knowledge Center home page**

1. Go to the Knowledge Center home page at <http://support.citrix.com/>.
2. On the Knowledge Center home page, under **Products**, expand **NetScaler**, and then click the NetScaler release for which you want to provide feedback.
3. On the **Documentation** tab, click the guide name, and then click **Article Feedback**.

4. On the **Documentation Feedback** page, complete the form, and then click **Submit**.

---

# Chapter 1

## Introduction to the Hardware Platforms

### Topics:

- [Common Hardware Components](#)
- [Hardware Platforms](#)
- [Summary of Hardware Specifications](#)

The NetScaler hardware platforms range from the single processor MPX 5500 platform to the high-capacity, MPX 22040/22060/22080/22100/22120 hardware platform. The various NetScaler hardware platforms are similar in that they use the same types of components, but different models provide different hardware capabilities. All NetScaler hardware platforms support the NetScaler software.

Some of the hardware platforms are available as dedicated application firewall appliances or secure application access appliances.

## Common Hardware Components

Each platform has front panel and back panel hardware components. The front panel has an LCD display and an RS232 serial console port. The number, type, and location of ports—copper Ethernet, copper and fiber 1G SFP, 10G SFP+, and XFP—vary by hardware platform. The back panel provides access to the fan and the field replaceable units (power supplies, CompactFlash card, and solid-state and hard-disk drives).

### LCD Display

The LCD display on the front of every appliance displays messages about the current operating status of the appliance. These messages communicate whether your appliance has started properly and is operating normally. If the appliance is not operating normally, the LCD displays troubleshooting messages.

The LCD displays real-time statistics, diagnostic information, and active alerts. The dimensions of the LCD limit the display to two lines of 16 characters each, causing the displayed information to flow through a sequence of screens. Each screen shows information about a specific function.

The LCD has a neon backlight. Normally, the backlight glows steadily. When there is an active alert, it blinks rapidly. If the alert information exceeds the LCD screen size, the backlight blinks at the beginning of each display screen. When the appliance shuts down, the backlight remains on for one minute and then automatically turns off.

There are nine types of display screens on the LCD display. The first two screens in the following list, the booting screen and the startup screen, appear when your appliance is starting up. The other screens, except the out-of-service screen, can appear while the appliance is operating. They show configuration information, alerts, HTTP information, network traffic information, CPU load information, and port information for your appliance.

#### Booting Screen.

The booting screen is displayed immediately after the appliance is turned on. The first line displays the hardware platform, as shown in the following figure.

**Figure 1-1. LCD Booting Screen**

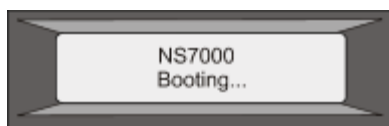

The newer MPX appliances display NSMPX followed by the platform number in the first line. For example, the MPX 7500/9500 appliances display NSMPX-7500. To view the model number, at the NetScaler command line, type **show license**. Scroll to the end of the command output to view the model number.

#### Startup Screen.

The startup screen is displayed for a few seconds after the appliance successfully begins operation. The first line displays the hardware platform, and the second line displays the software version and build number, as shown in the following figure.

**Figure 1-2. LCD Startup Screen**

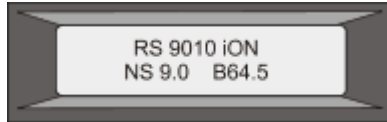

#### **Out-of-Service Screen.**

The out-of-service screen is displayed when the appliance has undergone a controlled shutdown, as shown in the following figure.

**Figure 1-3. LCD Out-of-service Screen**

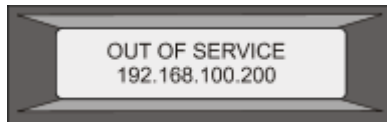

#### **Configuration Screen.**

The first line displays the appliance status (STA, PRI, or SEC) and uptime. STA indicates that the appliance is in standalone mode, PRI indicates that the appliance is a primary node in a high availability (HA) pair, and SEC indicates that the appliance is a secondary node in an HA pair. Appliance uptime is displayed in HH:MM format. The second line displays the IP address of the appliance, as shown in the following figure.

**Figure 1-4. LCD Configuration Screen**

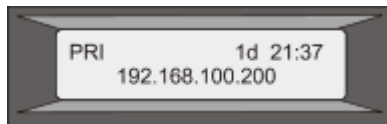

#### **Alert Screen.**

The first line displays the appliance status (STA, PRI, or SEC). STA indicates that the appliance is in standalone mode, PRI indicates that the appliance is a primary node in a high availability (HA) pair, and SEC indicates that the appliance is a secondary node in an HA pair. The second line displays the IP address of the appliance.

**Figure 1-5. LCD Known Alert Screen**

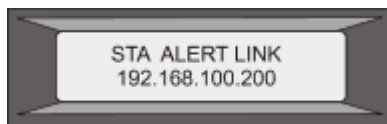

**HTTP Statistics Screen.**

The first line displays the rate of HTTP GETS per second. The second line displays the rate of HTTP POSTS per second, as shown in the following figure.

**Figure 1-6. LCD HTTP Statistics Screen**

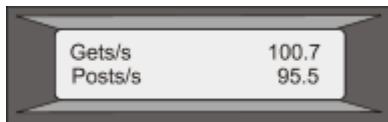

**Network Traffic Statistics Screen.**

The first line displays the rate at which data is received, in megabits per second. The second line displays the rate of data transmission, in megabits per second, as shown in the following figure.

**Figure 1-7. LCD Network Traffic Statistics Screen**

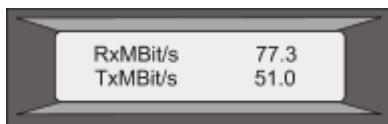

**CPU Load, Memory, and Connections Screen.**

The first line displays CPU utilization and memory utilization as percentages. The second line displays the ratio of the number of server connections to the number of client connections.

**Note:** If the number of server or client connections exceeds 99,999, the number is displayed in thousands, indicated by the letter K.

**Figure 1-8. LCD CPU Load, Memory, and Connections Screen**

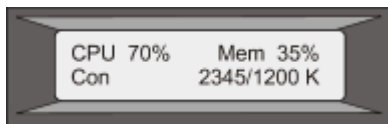

**Port Information Screen.**

The S row displays port speed, flow control, and duplex information. The R row displays megabits received per second on the interface. The first port in each row is the management port.

**Figure 1-9. Port Information for an 8-port Appliance**

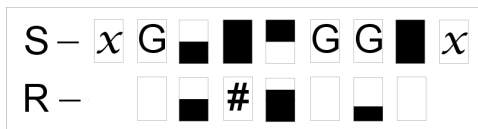

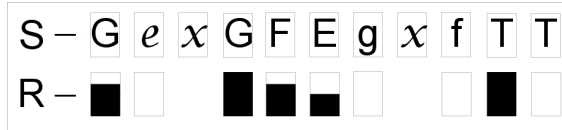

**Figure 1-10. Port Information for a 10-port Appliance**



The following table defines the various abbreviations and symbols that appear in the S row of the port information screen.





**Table 1-1. Port Abbreviations and Symbols for S Row**

S row abbreviation/symbol	Indicates
E	A rate of 10 megabits per second, full duplex mode, and flow control OFF.
F	A rate of 100 megabits per second, full duplex mode, and flow control OFF.
G	A rate of 1 gigabit per second, full duplex mode, and flow control OFF.
T	A rate of 10 gigabits per second, full duplex mode, and flow control OFF.
x	A disconnected port.  <b>Note:</b> The R row does not display an abbreviation or symbol for a disconnected port.
■	Receive flow control regardless of speed or duplex mode.
■ □	Transmit flow control regardless of speed or duplex mode.
■	Receive and transmit flow control regardless of speed or duplex mode.
e	A rate of 10 megabits per second, half duplex mode, and flow control OFF.

S row abbreviation/symbol	Indicates
	A rate of 100 megabits per second, half duplex mode, and flow control OFF.
	A rate of 1 gigabit per second, half duplex mode, and flow control OFF.

The following table defines the various abbreviations and symbols that appear in the R row of the port information screen.

**Table 1-2. Port Abbreviations and Symbols for R Row**

R row abbreviation/symbol	Indicates
	The port is disabled.
	Receive speed is about 10% of line speed.
	Receive speed is about 50% of line speed.
	Receive speed is about 75% of line speed.
	Receive speed is about 100% of line speed.

## Ports

Ports are used to connect the appliance to external devices. NetScaler appliances support RS232 serial ports, 10/100/1000Base-T copper Ethernet ports, 1-gigabit copper and fiber 1G SFP ports, and 10-gigabit fiber SFP+ and XFP ports. All NetScaler appliances have a combination of some or all of these ports. For details on the type and number of ports available on your appliance, see the section describing that platform.



## RS232 Serial Port

The RS232 serial console port on the front panel of each appliance provides a connection between the appliance and a computer, allowing direct access to the appliance for initial configuration or troubleshooting.

All hardware platforms ship with an appropriate serial cable used to connect your computer to the appliance. For instructions on connecting your computer to the appliance, see "[Installing the Hardware](#)."

## Copper Ethernet Ports

The copper Ethernet ports installed on many models of the appliance are standard RJ45 ports.

There are two types of copper Ethernet ports that may be installed on your appliance:

### 10/100BASE-T port

The 10/100BASE-T port has a maximum transmission speed of 100 megabits per second (Mbps). Most platforms have at least one 10/100BASE-T port.

### 10/100/1000BASE-T port

The 10/100/1000BASE-T port has a maximum transmission speed of 1 gigabit per second, ten times faster than the other type of copper Ethernet port. Most platforms have at least one 10/100/1000Base-T port.

To connect any of these ports to your network, you plug one end of a standard Ethernet cable into the port and plug the other end into the appropriate network connector.

## Management Ports

Management ports are standard copper Ethernet ports (RJ45), which are used for direct access to the appliance for system administration functions.

## 1G SFP, 10G SFP+, and XFP Ports

A 1G SFP port can operate at a speed of 1 Gbps. It accepts either a copper 1G SFP transceiver, for operation as a copper Ethernet port, or a fiber 1G SFP transceiver for operation as a fiber optic port.

The 10G SFP+ and XFP ports are high-speed ports that can operate at speeds of up to 10 Gbps. You need a fiber optic cable to connect to a 10G SFP+ or XFP port. If the other end of the fiber optic cable is attached to a 1G SFP port, the 10G SFP+ port automatically negotiates to match the speed of the 1G SFP port.

The following tables list the maximum distance specifications for NetScaler pluggable media (1G SFP, 10G SFP+, and XFP transceivers).

**Note:** The tables are categorized by 1G pluggable media and 10G pluggable media. The 10G SFP+ modules are dual-speed capable and support both 1G and 10G, depending on the peer switch that the model connects to. These are listed in both tables.

Both tables have the following columns:

- ◆ SKU: Citrix maintains multiple SKUs for the same part.
- ◆ Description: The price list description of the part.
- ◆ Transmit Wavelength: The nominal transmit wavelength.
- ◆ Cable/Fiber Type: Fiber characteristics affect the maximum transmit distance achievable. This is especially true with 10G on multi-mode fiber (MMF), where various dispersion components become dominant. For more information, see <http://www.thefoa.org/tech/ref/basic/fiber.html>.
- ◆ Typical Reach: Maximum transmit distance.
- ◆ Products: Some chassis are available with different media options. Use the appropriate data sheet to confirm that your particular chassis type supports the media.

## 1G Pluggable Media

The following table lists the maximum distance specifications for 1G transceivers.

**Table 1-3. Copper 1G SFP Distance Specifications**

SKU	Description	Transmitter Wavelength (nm)	Cable Type	Typical Reach (m)	Products
EW3A0000235, EW3B0000235, EW3C0000235, EW3D0000235, EW3E0000235, EW3F0000235, EW3P0000143, EW3X0000235, EW3Z0000087	Citrix NetScaler 1G SFP Ethernet Copper (100m) - 4 Pack	n/a	Category 5 (Cat-5) Copper Cable	100 m	MPX 7500/9500, MPX 8200/8400/8600/8800, MPX 9700/10500/12500/15500, 12000-10G, 9010 FIPS, MPX 22040/22060/22080/22100/22120

**Table 1-4. Short Reach Fiber 1G SFP Distance Specifications**

SKU	Description	Transmitter Wavelength (nm)	Fiber Type	Typical Reach (m)	Products
EW3A0000234, EW3B0000234,	Citrix NetScaler	850nm (nominal)	50/125um MMF,	550 m	MPX 7500/9500, MPX

EW3C0000234, EW3D0000234, EW3E0000234, EW3F0000234, EW3P0000142, EW3X0000234, EW3Z0000086	1G SFP Ethernet SX (300m) - 4 Pack		2000MHz- km (OM3)		8200/8400/8600/8 800, MPX 9700/10500/12500 /15500, 12000-10G, 9010 FIPS, MPX 22040/22060/2208 0/22100/22120
			50/125um MMF, 500MHz-km (OM2)	550 m	
			50/125um MMF, 400MHz-km	550 m	
			62.5/125u m MMF, 200MHz-km (OM1)	300 m	
			62.5/125u m MMF, 160MHz-km	300 m	

**Table 1-5. Short Reach Fiber 1G SFP Distance Specifications**

SKU	Description	Transmitt er Waveleng th (nm)	Fiber Type	Typi cal Reac h (m)	Products
EW3A0000710, EW3B0000710, EW3C0000710, EW3D0000710, EW3E0000710, EW3F0000710, EW3P0000557, EW3X0000710, EW3Z0000585	Citrix NetScaler 1G SFP Ethernet Short Range (300m) - Single	850nm (nominal)	50/125um MMF, 2000MHz- km (OM3)	550 m	MPX 8200/8400/8600/8 800, MPX 9700/10500/12500 /15500, MPX 17500/19500/2150 0, MPX 11500/13500/1450 0/16500/18500/20 500, MPX 22040/22060/2208 0/22100/22120
			50/125um MMF, 500MHz-km (OM2)	550 m	
			50/125um MMF, 400MHz-km	550 m	
			62.5/125u m MMF, 200MHz-km (OM1)	275 m	
			62.5/125u m MMF, 160MHz-km	220 m	

**Table 1-6. Long Reach Fiber 1G SFP Distance Specifications**

SKU	Description	Transmitter Wavelength (nm)	Fiber Type	Typical Reach (m)	Products
EW3A0000712, EW3B0000712, EW3C0000712, EW3D0000712, EW3E0000712, EW3F0000712, EW3P0000559, EW3X0000712, EW3Z0000587	Citrix NetScaler 1G SFP Ethernet LX - Single	1310nm (nominal)	9/125um SMF	10 km	MPX 7500/9500, MPX 8200/8400/8600/8800, MPX 9700/10500/12500/15500, 12000-10G, 9010 FIPS, MPX 22040/22060/22080/22100/22120

**Table 1-7. Long Reach Fiber 1G SFP Distance Specifications**

SKU	Description	Transmitter Wavelength (nm)	Fiber Type	Typical Reach (m)	Products
EW3A0000711, EW3B0000711, EW3C0000711, EW3D0000711, EW3E0000711, EW3F0000711, EW3P0000558, EW3X0000711, EW3Z0000586	Citrix NetScaler 1G SFP Ethernet Long Range (10km) - Single	1310nm (nominal)	9/125um SMF	10 km	MPX 8200/8400/8600/8800, MPX 9700/10500/12500/15500, MPX 17500/19500/21500, MPX 11500/13500/14500/16500/18500/20500, MPX 22040/22060/22080/22100/22120

## 10 GE Pluggable Media

The following table lists the maximum distance specifications for 10G transceivers.

**Table 1-8. Short Reach Fiber 10G SFP+ Distance Specifications**

SKU	Description	Transmitter Wavelength (nm)	Fiber Type	Typical Reach (m)	Products
-----	-------------	-----------------------------	------------	-------------------	----------

EW3A0000710, EW3B0000710, EW3C0000710, EW3D0000710, EW3E0000710, EW3F0000710, EW3P0000557, EW3X0000710, EW3Z0000585	Citrix NetScaler 10G SFP+ Ethernet Short Range (300m) - <b>Single</b>	850nm (nominal)	50/125um MMF, 200MHz- km (OM3)	300 m	MPX 8200/8400/8600/8 800, MPX 9700/10500/12500 /15500, MPX 17500/19500/2150 0, MPX 11500/13500/1450 0/16500/18500/20 500, MPX 17550/19550/2055 0/21550, MPX 22040/22060/2208 0/22100/22120
			50/125um MMF, 500MHz-km (OM2)	82 m	
			50/125um MMF, 400MHz-km	66 m	
			62.5/125u m MMF, 200MHz-km (OM1)	33 m	
			62.5/125u m MMF, 160MHz-km	26 m	

**Table 1-9. Short Reach XFP (10G) Distance Specifications**

SKU	Description	Transmitt er Waveleng th (nm)	Fiber Type	Typi cal Reac h (m)	Products
EW3A0000713, EW3B0000713, EW3C0000713, EW3D0000713, EW3E0000713, EW3F0000713, EW3P0000560, EW3X0000713, EW3Z0000588	Citrix NetScaler XFP Short Range 10 Gigabit Ethernet(30 0m) - <b>Single</b>	850nm (nominal)	50/125um MMF, 200MHz- km (OM3)	300 m	12000-10G, MPX 15000/17000
			50/125um MMF, 500MHz-km (OM2)	82 m	
			50/125um MMF, 400MHz-km	66 m	
			62.5/125u m MMF, 200MHz-km (OM1)	33 m	

			62.5/125um MMF, 160MHz-km	26 m	
--	--	--	------------------------------	------	--

**Table 1-10. Long Reach Fiber 10G SFP+ Distance Specifications**

SKU	Description	Transmitter Wavelength (nm)	Fiber Type	Typical Reach (m)	Products
EW3A0000711, EW3B0000711, EW3C0000711, EW3D0000711, EW3E0000711, EW3F0000711, EW3P0000558, EW3X0000711, EW3Z0000586	Citrix NetScaler 10G SFP+ Ethernet Long Range (10km) - <b>Single</b>	1310nm (nominal)	9/125um SMF	10 km	MPX 8200/8400/8600/8800, MPX 9700/10500/12500/15500, MPX 17500/19500/21500, MPX 11500/13500/14500/16500/18500/20500, MPX 17550/19550/20550/21550, MPX 22040/22060/22080/22100/22120

**Table 1-11. Long Reach Fiber XFP (10G) Distance Specifications**

SKU	Description	Transmitter Wavelength (nm)	Fiber Type	Typical Reach (m)	Products
EW3A0000714, EW3B0000714, EW3C0000714, EW3D0000714, EW3E0000714, EW3F0000714, EW3P0000561, EW3X0000714, EW3Z0000589	Citrix NetScaler XFP Long Range 10 Gigabit Ethernet(10 km) - <b>Single</b>	1310nm (nominal)	9/125um SMF	10 km	12000-10G, MPX 15000/17000

**Table 1-12. Citrix Direct Attached (DAC) Copper TwinAx 10G SFP+ Passive Cables Specifications**

SKU	Description	Products
3007776	Citrix NetScaler 1m DAC SFP+ Cable for up to 1m distance	MPX 8200/8400/8600/8800, MPX 17500/19500/21500, MPX 11500/13500/14500/16500/18500/20500, MPX 17550/19550/20550/21550, MPX 22040/22060/22080/22100/22120
3007777	Citrix NetScaler 3m DAC SFP+ Cable for up to 3m distance	MPX 8200/8400/8600/8800, MPX 17500/19500/21500, MPX 11500/13500/14500/16500/18500/20500, MPX 17550/19550/20550/21550, MPX 22040/22060/22080/22100/22120
3007778	Citrix NetScaler 5m DAC SFP+ Cable for up to 5m distance	MPX 8200/8400/8600/8800, MPX 17500/19500/21500, MPX 11500/13500/14500/16500/18500/20500, MPX 17550/19550/20550/21550, MPX 22040/22060/22080/22100/22120

**Table 1-13. Cisco DAC TwinAx Passive Cables Specifications**

Cisco Part Number	Description
SFP-H10Gb-CU1M	10GBASE-CU SFP+ Cable 1 Meter
SFP-H10Gb-CU3M	10GBASE-CU SFP+ Cable 3 Meter
SFP-H10Gb-CU5M	10GBASE-CU SFP+ Cable 5 Meter

**Note:** For more information, contact Cisco sales support.

## LED Port-Status Indicators

**Note:** This section applies to the MPX 5500, MPX 5550/5650, MPX 7500/9500, MPX 8200/8400/8600/8800, MPX 9700/10500/12500/15500, MPX 17500/19500/21500, MPX 11500/13500/14500/16500/18500/20500, MPX 17550/19550/20550/21550, and MPX 22040/22060/22080/22100/22120 appliances.

The port LEDs show whether a link is established and traffic is flowing through the port. The following table describes the LED indicators for each port. There are two LED indicators for each port type.

**Table 1-14. LED port-status indicators**

Port Type	LED Location	LED Function	LED Color	LED Indicates
10G SFP+ (10 Gbps)	Left	Link/ Activity	Off	No link.
			Solid green	Link is established but no traffic is passing through the port.
			Blinking green	Traffic is passing through the port.
	Right	Speed	Off	No connection.
			Solid green	Traffic rate of 10 gigabits per second.
1G SFP (1 Gbps)	Left	Link/ Activity	Off	No link.
			Solid green	Link is established but no traffic is passing through the port.
			Blinking green	Traffic is passing through the port.
	Right	Speed	Off	No connection.
			Yellow	Traffic rate of 1 gigabit per second.
Ethernet (RJ45)	Left	Speed	Off	No connection, or a traffic rate of 10



Port Type	LED Location	LED Function	LED Color	LED Indicates
				megabits per second (Mbps).
			Green	Traffic rate of 100 Mbps.
			Yellow	Traffic rate of 1 gigabit per second.
	Right	Link/ Activity	Off	No link.
			Solid green	Link is established but no traffic is passing through the port.
			Blinking green	Traffic is passing through the port.
Management (RJ45)	Left	Speed	Off	No connection, or a traffic rate of 10 megabits per second (Mbps).
			Green	Traffic rate of 100 Mbps.
			Amber	Traffic rate of 1 gigabit per second.
	Right	Link/ Activity	Off	No link.
			Solid yellow	Link is established but no traffic is passing through the port.
			Blinking yellow	Traffic is passing through the port.

## Field Replaceable Units

Citrix NetScaler field replaceable units (FRU) are NetScaler components that can be quickly and easily removed from the appliance and replaced by the user or a technician at the user's site. The FRUs in a NetScaler appliance can include a CompactFlash card, DC or AC power supplies, and solid-state or hard-disk drives, and a direct attach cable (DAC).

**Note:** The solid-state or hard-disk drive stores your configuration information, which has to be restored from a backup after replacing the unit.

### Power Supply

For appliances containing two power supplies, the second power supply acts as a backup. The MPX 22040/22060/22080/22100/22120 can accommodate four power supplies, and require two power supplies for proper operation. The third and fourth power supplies act as backup.

The appliance ships with a standard power cord that plugs into the appliance's power supply and an NEMA 5-15 plug on the other end for connecting to the power outlet on the rack or in the wall.

For power-supply specifications, see "[Hardware Platforms](#)," which describes the various platforms and includes a table summarizing the hardware specifications.

**Note:** If you suspect that a power-supply fan is not working, please see the description of your platform. On some platforms, what appears to be the fan does not turn, and the actual fan turns only when necessary.

For each power supply, a bicolor LED indicator shows the condition of the power supply. The LEDs of the AC power supplies for MPX 15000 and 17000 appliances are different from the LEDs of the other appliances.

**Table 1-15. LED Power Supply Indicators**

Power Supply Type	LED Color	LED Indicates
AC	OFF	No power to any power supply.
	Flashing RED	No power to this power supply.
	Flashing GREEN	Power supply is in standby mode.
	GREEN	Power supply is functional.
	RED	Power supply failure.

Power Supply Type	LED Color	LED Indicates
DC	OFF	No power to any power supply.
	Flashing RED	No power to this power supply.
	Flashing BLUE	Power supply is in standby mode.
	BLUE	Power supply is functional.
	RED	Power supply failure.
MPX 15000 and 17000	OFF	Power supply is not plugged in to a power source. If the LED is off when the power supply is plugged in, the power supply has a malfunction.
	AMBER	Power supply has been plugged in for less than a few seconds. If the LED does not turn GREEN, the power supply has a malfunction.
	GREEN	Power supply is functioning properly.
	BLINKING	Power supply has a malfunction

**Note:** The power supply on the NetScaler MPX 5500 and MPX 5550/5650 appliances is not field replaceable.

### Electrical Safety Precautions for Power Supply Replacement

- ◆ Make sure that the appliance has a direct physical connection to earth ground during normal use. When installing or repairing an appliance, always connect the ground circuit first and disconnect it last.
- ◆ Always unplug any appliance before performing repairs or upgrades.
- ◆ Never touch a power supply when the power cord is plugged in. As long as the power cord is plugged in, line voltages are present in the power supply even if the power switch is turned off.

## Replacing an AC Power Supply

Citrix NetScaler MPX platforms can accommodate two power supplies, except the MPX 22040/22060/22080/22100/22120 platform which can accommodate four power supplies. All NetScaler appliances function properly with a single power supply, except the MPX 22040/22060/22080/22100/22120 platform which needs two power supplies for proper operation. The other power supplies serves as a backup. All power supplies must be of the same type (AC or DC).

**Note:** If the appliance has only one power supply, you have to shut down the appliance before replacing the power supply. If the appliance has two power supplies, you can replace one power supply without shutting down the appliance, provided the other power supply is working, and if the appliance has four power supplies, you can replace one or two power supplies without shutting down the appliance, provided the other two power supplies are working.

### To install or replace an AC power supply on a Citrix NetScaler appliance

1. Align the semicircular handle perpendicular to the power supply. Loosen the thumbscrew and press the lever toward the handle and pull out the existing power supply, as shown in the following figure.

**Note:** The illustration in the following figures might not represent the actual NetScaler appliance.

**Figure 1-11. Removing the Existing AC Power Supply**

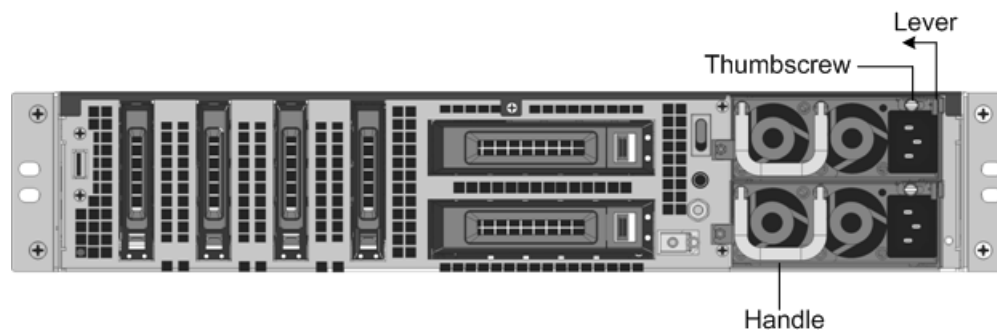

2. Carefully remove the new power supply from its box.
3. On the back of the appliance, align the power supply with the power supply slot.
4. Insert the power supply into the slot and press against the semicircular handle until you hear the power supply snap into place.

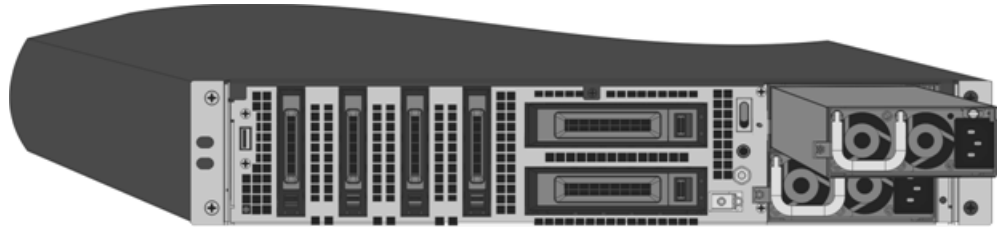
**Figure 1-12. Inserting the Replacement AC Power Supply**

5. Connect the power supply to a power source. If connecting all power supplies, plug separate power cords into the power supplies and connect them to separate wall sockets.

**Note:** NetScaler appliances emit a high-pitched alert if one power supply fails or if you connect only one power cable to an appliance in which two power supplies are installed. To silence the alarm, press the small red button on the back panel of the appliance. The disable alarm button is functional only when the appliance has two power supplies.

## Replacing a DC Power Supply

Citrix NetScaler MPX platforms can accommodate two power supplies, except the MPX 22040/22060/22080/22100/22120 platform which can accommodate four power supplies. All NetScaler appliances function properly with a single power supply, except the MPX 22040/22060/22080/22100/22120 platform which needs two power supplies for proper operation. The other power supplies serves as a backup. All power supplies must be of the same type (AC or DC).

**Note:** If the appliance has only one power supply, you have to shut down the appliance before replacing the power supply. If the appliance has two power supplies, you can replace one power supply without shutting down the appliance, provided the other power supply is working, and if the appliance has four power supplies, you can replace one or two power supplies without shutting down the appliance, provided the other two power supplies are working.

### To install or replace a DC power supply on a Citrix NetScaler appliance

1. Loosen the thumbscrew and press the lever towards the handle and pull out the existing power supply, as shown in the following figure.

**Note:** The illustration in the following figures might not represent the actual NetScaler appliance.

**Figure 1-13. Removing the Existing DC Power Supply**



2. Carefully remove the new power supply from its box.
3. On the back of the appliance, align the power supply with the power supply slot.
4. Insert the power supply into the slot while pressing the lever towards the handle. Apply firm pressure to insert the power supply firmly into the slot.

**Figure 1-14. Inserting the Replacement DC Power Supply**



5. When the power supply is completely inserted into its slot, release the lever.
6. Connect the power supply to a power source. If connecting all power supplies, plug separate power cords into the power supplies and connect them to separate wall sockets.

**Note:** NetScaler appliances emit a high-pitched alert if one power supply fails or if you connect only one power cable to an appliance in which two power supplies are installed. To silence the alarm, press the small red button on the back panel of the appliance. The disable alarm button is functional only when the appliance has two power supplies.

## CompactFlash Card

The NetScaler software is stored on either the solid-state drive or the CompactFlash card. The following MPX platforms store the NetScaler software on the CompactFlash card:

- ◆ Citrix NetScaler MPX 5500
- ◆ Citrix NetScaler MPX 7500 and MPX 9500
- ◆ Citrix NetScaler MPX 9700, MPX 10500, MPX 12500, and MPX 15500
- ◆ Citrix NetScaler MPX 15000

- ◆ Citrix NetScaler MPX 17000

**Note:** The CompactFlash card is mounted as `/flash` on the above platforms.

The CompactFlash card specifications vary by NetScaler hardware platform. A CompactFlash card from one platform does not necessarily work on a different platform.

## Replacing a CompactFlash Card

**Note:** These instructions apply to the Citrix® NetScaler® MPX 5500, MPX 7500/9500, MPX 9700/10500/12500/15500, MPX 15000, and MPX 17000 appliances only.

Replacement CompactFlash cards contain a preinstalled version of the NetScaler software and a generic configuration file (`ns.conf`), but they do not contain SSL-related certificates and keys, or custom boot settings. Configuration files and customized settings must be restored from a backup storage location at the customer site, if available. The files to be restored might include:

- ◆ `/flash/nsconfig/ns.conf`: The current configuration file.
- ◆ `/flash/nsconfig/ZebOS.conf`: The ZebOS configuration file.
- ◆ `/flash/nsconfig/license`: The licenses for the NetScaler features.
- ◆ `/flash/nsconfig/ssl`: The SSL certificates and keys required for encrypting data to clients or to backend servers.
- ◆ `/nsconfig/rc.netscaler`: Customer-specific boot operations (optional).

**Note:** Verify that the card you receive is the correct type for your NetScaler appliance.

## To replace a CompactFlash card

1. At the NetScaler command prompt, exit to the shell prompt. Type:  
**shell**
2. Shut down the NetScaler appliance by typing one of the following commands at the shell prompt.
  - On an MPX appliance, type:  
**shutdown -p now**
  - On a non-MPX appliance, type:  
**shutdown**
3. Locate the CompactFlash slot on the back panel of the appliance.
4. Disengage the CompactFlash by pushing the lever to the right of the CompactFlash slot. If necessary, use a pen or small screwdriver to push the lever in fully. Pull the existing flash card out of the slot.

**Note:** The illustration in the following figures might not represent the actual NetScaler appliance.

**Figure 1-15. Removing the Existing CompactFlash Card**

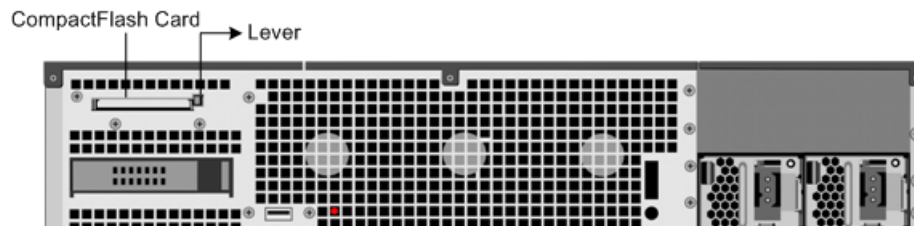

5. Insert the new flash card received from Citrix.

**Important:** When you insert the card, make sure that the arrow on top of the card is pointing toward the CompactFlash slot. Position the connector grid on the edge of the CompactFlash card to meet the matching connector pins inside the CompactFlash slot.

**Figure 1-16. Inserting the Replacement CompactFlash Card**

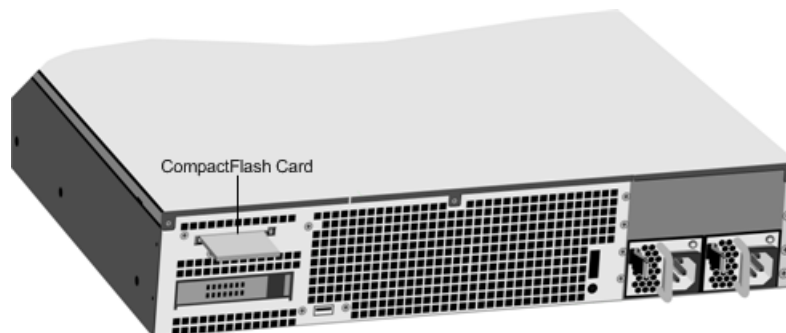

6. Turn on the NetScaler appliance.  
When the appliance starts, it no longer has the previous working configuration. Therefore, the appliance is reachable only through the default IP address of 192.168.100.1/16, or through the console port.
7. Log on to the default IP address by using a web browser, or connect to the serial console by using a console cable, to perform the initial configuration.
8. Upload a platform license and any optional feature licenses, including universal licenses, to the NetScaler appliance. For more information, see the licensing chapter of the "[Citrix NetScaler Getting Started Guide](#)."
9. Once the correct NetScaler software version is loaded, you can restore the working configuration. Copy a previous version of the ns.conf file to the /nsconfig directory by using an SCP utility or by pasting the previous configuration into the /nsconfig/ns.conf file from the NetScaler command prompt. To load the new ns.conf file, restart the NetScaler appliance by entering the **reboot** command at the NetScaler command prompt.



## Solid-State Drive

A solid-state drive (SSD) is a high-performance device that stores data in solid-state flash memory. The MPX solid-state drives contain the boot loader configuration file, configuration file (`ns.conf`), licenses, and for some models, the NetScaler software and the user data.

The NetScaler software is stored on either the SSD or the CompactFlash card. The following MPX platforms store the NetScaler software on the SSD. The SSD is mounted as `/flash`.

- ◆ Citrix NetScaler MPX 5550 and MPX 5650
- ◆ Citrix NetScaler MPX 8200, MPX 8400, MPX 8600, and MPX 8800
- ◆ Citrix NetScaler MPX 11500, MPX 13500, MPX 14500, MPX 16500, MPX 18500, and MPX 20500
- ◆ Citrix NetScaler MPX 17500, MPX 19500, and MPX 21500
- ◆ Citrix NetScaler MPX 17550, MPX 19550, MPX 20550, and MPX 21550
- ◆ Citrix NetScaler MPX 22040, MPX 22060, MPX 22080, MPX 22100, and MPX 22120

**Note:** On the MPX 5550/5650 and MPX 8200/8400/8600/8800 appliances, both `/flash` and `/var` are mounted from different partitions of the same SSD drive.

## Replacing a Solid-State Drive

**Note:** These instructions apply to the Citrix NetScaler MPX 5550/5650, MPX 8200/8400/8600/8800, MPX 11500/13500/14500/16500/18500/20500, MPX 17500/19500/21500, MPX 17550/19550/20550/21550, and MPX 22040/22060/22080/22100/22120 appliances.

Replacement solid-state drives (SSDs) contain a pre-installed version of the NetScaler software and a generic configuration file (`ns.conf`), but they do not contain SSL-related certificates and keys, or custom boot settings. Configuration files and customized settings must be restored to a replacement drive from a backup storage location at the customer site, if available. The files to be restored might include:

- ◆ `/flash/nsconfig/ns.conf`: The current configuration file.
- ◆ `/flash/nsconfig/ZebOS.conf`: The ZebOS configuration file.
- ◆ `/flash/nsconfig/license`: The licenses for the NetScaler features.
- ◆ `/flash/nsconfig/ssl`: The SSL certificates and keys required for encrypting data to clients or to backend servers.
- ◆ `/nsconfig/rc.netscaler`: Customer-specific boot operations (optional).

### To replace a solid-state drive

1. At the NetScaler command prompt, exit to the shell prompt. Type:  
**shell**

2. Shut down the NetScaler appliance by typing the following command at the shell prompt:

**shutdown -p now**

3. Locate the SSD on the back panel of the appliance. Push the safety latch of the drive cover to the right or down, depending on the platform, while pulling out on the drive handle to disengage. Pull out the faulty drive.

**Note:** The illustration in the following figures might not represent the actual NetScaler appliance.

**Figure 1-17. Removing the Existing Solid-State Drive**

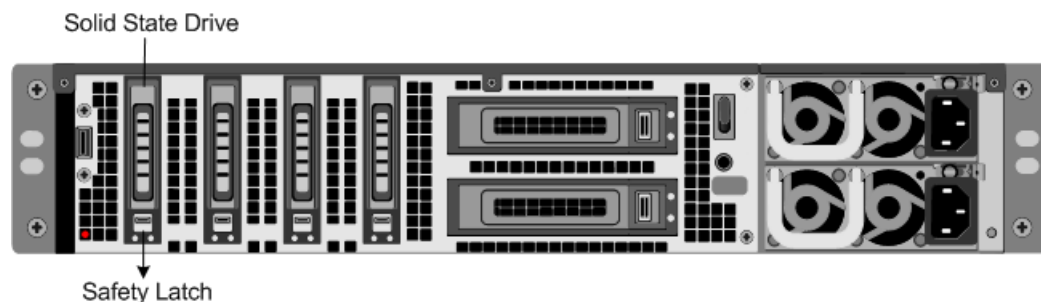

4. Verify that the replacement SSD is the correct type for the platform.
5. Pick up the new SSD, open the drive handle fully to the left or up, and insert the drive into the slot as far as possible. To seat the drive, close the handle flush with the rear of the appliance so that the drive locks securely into the slot.

**Important:** When you insert the drive, make sure that the Citrix product label is at the top if the drive is inserted horizontally or at the right if the drive is inserted vertically.

**Figure 1-18. Inserting the Replacement Solid-State Drive**



6. Turn on the NetScaler appliance. When the appliance starts, it no longer has the previous working configuration. Therefore, the appliance is reachable only through the default IP address of 192.168.100.1/16, or through the console port.
7. Log on to the default IP address by using a web browser, or connect to the serial console by using a console cable, to perform the initial configuration.

8. Upload a platform license and any optional feature licenses, including universal licenses, to the NetScaler appliance. For more information, see the licensing chapter of the "[Citrix NetScaler Getting Started Guide](#)."
9. Once the correct NetScaler software version is loaded, you can restore the working configuration. Copy a previous version of the ns.conf file to the /nsconfig directory by using an SCP utility or by pasting the previous configuration into the /nsconfig/ns.conf file from the NetScaler command prompt. To load the new ns.conf file, you must restart the NetScaler appliance by entering the **reboot** command at the NetScaler command prompt.

## Hard Disk Drive

A hard disk drive (HDD) stores logs and other data files. Files stored on the HDD include the newnslog files, dmesg and messages files, and any core/crash files. The HDD comes in various capacities, depending on the Citrix NetScaler platform. Hard drives are used for storing files required at runtime. An HDD is mounted as `/var`.

The following MPX platforms support HDD:

- ◆ Citrix NetScaler MPX 9700, MPX 10500, MPX 12500, and MPX 15500
- ◆ Citrix NetScaler MPX 11500, MPX 13500, MPX 14500, MPX 16500, MPX 18500, and MPX 20500
- ◆ Citrix NetScaler MPX 15000
- ◆ Citrix NetScaler MPX 17000
- ◆ Citrix NetScaler MPX 17500, MPX 19500, and MPX 21500
- ◆ Citrix NetScaler MPX 17550, MPX 19550, MPX 20550, and MPX 21550
- ◆ Citrix NetScaler MPX 22040, MPX 22060, MPX 22080, MPX 22100, and MPX 22120

## Replacing a Hard Disk Drive

A hard disk drive (HDD) stores log files and other user files. Collection of new log files begins upon boot-up with the new HDD. Product documentation can be downloaded from "[MyCitrix.com](#)" and reinstalled to the `/var/netscaler/doc` location.

### To install a hard disk drive

1. At the NetScaler command prompt, exit to the shell prompt. Type:  
**shell**
2. Shut down the NetScaler appliance by typing one of the following commands at the shell prompt.
  - On an MPX appliance, type:  
**shutdown -p now**
  - On a non-MPX appliance, type:  
**shutdown**
3. Locate the hard disk drive on the back panel of the appliance.

4. Verify that the replacement hard disk drive is the correct type for the NetScaler platform.
5. Disengage the hard disk drive by pushing the safety latch of the drive cover to the right or down, depending on the platform, while pulling out on the drive handle to disengage. Pull out the faulty drive.

**Note:** The illustration in the following figures might not represent the actual NetScaler appliance.

**Figure 1-19. Removing the Existing Hard Disk Drive**

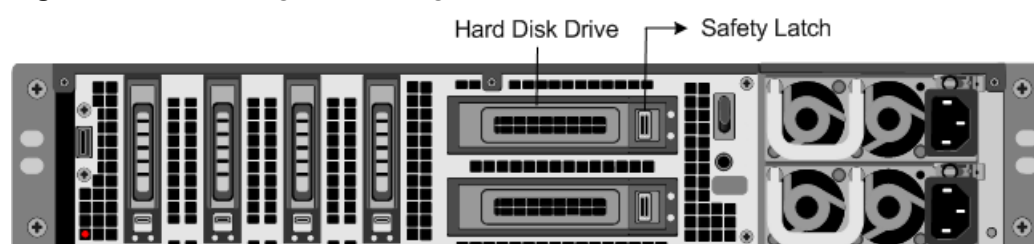

6. Pick up the new disk drive, open the drive handle fully to the left, and insert the new drive into the slot as far as possible. To seat the drive, close the handle flush with the rear of the appliance so that the hard drive locks securely into the slot.

**Important:** When you insert the drive, make sure that the Citrix product label is at the top.

**Figure 1-20. Inserting the Replacement Hard Disk Drive**

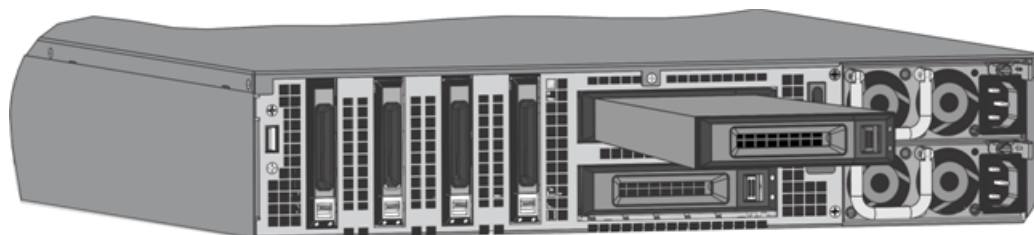

7. Turn on the NetScaler appliance. The appliance starts the NetScaler software and reads the configuration file from the CompactFlash card.

## Direct Attach Cable

A direct attach cable (DAC) assembly is a high performance integrated duplex data link for bi-directional communication. The cable is compliant with the IPF MSA (SFF-8432) for mechanical form factor and SFP+ MSA for direct attach cables. The cable, which can be up to 5 meters long, is data-rate agnostic. Supporting speeds in excess of 10 Gbps, it is a cost-effective alternative to optical links (SFP+ transceivers and fiber optic cables.) The transceiver with DAC is hot-swappable. You can insert and remove the transceiver with the attached cable without shutting down the appliance. The Citrix NetScaler appliance supports only passive DAC.

**Important:**

- ◆ DAC is supported only on 10G ports. Do not insert a DAC into a 1G port.
- ◆ Do not attempt to unplug the integrated copper cable from the transceiver and insert a fiber cable into the transceiver.

## Installing a Direct Attach Cable

**Note:** The illustrations in the following figures are only for reference and might not represent the actual NetScaler appliance.

### To install or remove a direct attach cable

1. To install the DAC, slide it into the 10G port on the appliance, as shown in the following figure. You will hear a click when the DAC properly fits into the port.

**Figure 1-21. Inserting a DAC into the 10G port**

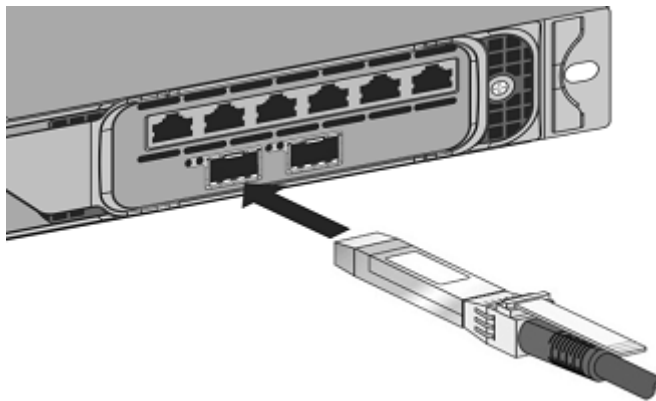

2. To remove the DAC, pull the tab on the top of the DAC, and then pull the DAC out of the port, as shown in the following figure.

**Figure 1-22. Removing a DAC from the 10G port**

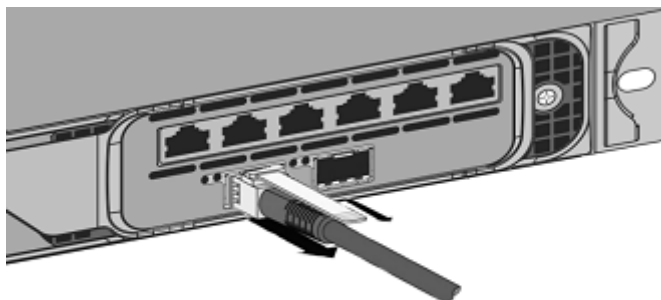

## Hardware Platforms

The various NetScaler hardware platforms offer a wide range of features, communication ports, and processing capacities. All the MPX platforms have multicore processors.

### Citrix NetScaler 9010 FIPS

The Citrix NetScaler 9010 Federal Information Processing Standards (FIPS) appliance is a 2U appliance, with 1 single-core processor, and 2 GB of memory.

**Note:** The NetScaler nCore build is not supported on this hardware platform.

The following figure shows the front panel of the 9010 FIPS appliance with copper Ethernet ports.

**Figure 1-23.** Citrix NetScaler 9010 FIPS front panel, with copper Ethernet ports

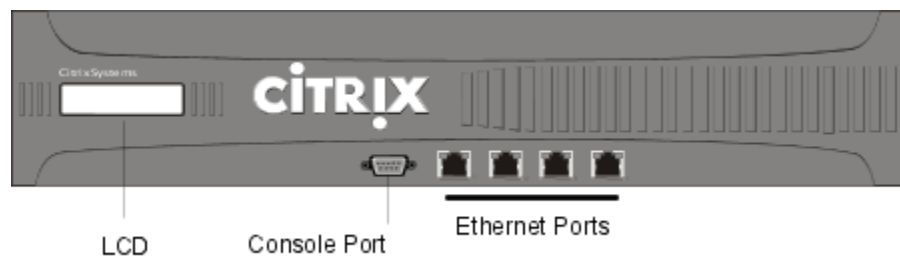

The following figure shows the front panel of the 9010 FIPS appliance with fiber 1G SFP ports.

**Figure 1-24.** Citrix NetScaler 9010 FIPS front panel, with 1G SFP ports

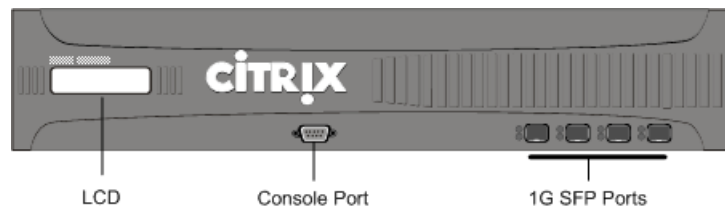

The following components are visible on the front panel of the 9010 appliance:

- ◆ RS232 serial console port.
- ◆ Four ports, numbered 1/1, 1/2, 1/3, and 1/4 from left to right.

**Note:** The network port numbers on all appliances consist of two numbers separated by a forward slash. The first number is the port adapter slot number. The second number is the interface port number. Ports on appliances are numbered sequentially starting with 1.

The following figure shows the back panel of the 9010 FIPS appliance.

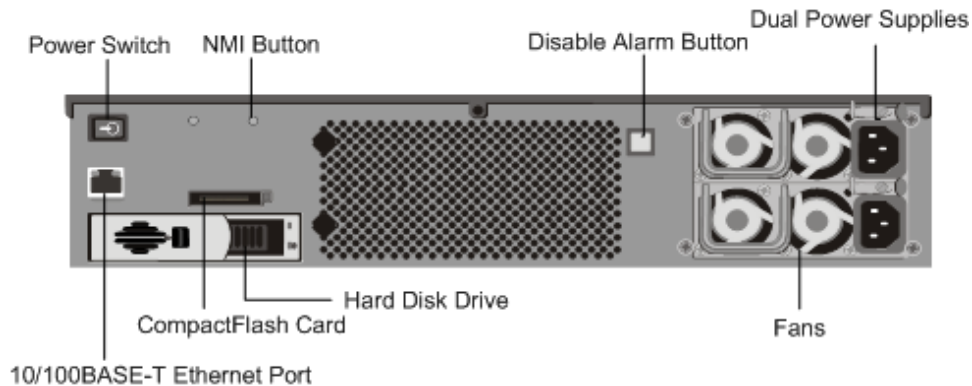
**Figure 1-25. Citrix NetScaler 9010 FIPS appliance, back panel**

The following components are visible on the back panel of the 9010 FIPS appliance:

- ◆ Power switch, which turns off power to the appliance, just as if you were to unplug both power supplies.
- ◆ Non-maskable interrupt (NMI) Button that is used at the request of Technical Support and produces a core dump on the appliance. You must use a pen, pencil, or other pointed object to press this red button, which is recessed to prevent unintentional activation.
- ◆ Disable alarm button, which silences the alarm that the appliance sounds when it is receiving power from only one of its power supplies. Press this button to prevent the power alarm from sounding when you have plugged the appliance into only one power outlet or when one power supply is malfunctioning and you wish to continue operating the appliance until it is repaired.
- ◆ Dual power supplies, each rated at 500 watts, 110-220 volts. You plug separate power cords into the power supplies and connect them to separate wall sockets. The appliance functions properly with a single power supply; the extra power supply serves as a backup.
- ◆ 10/100BASE-T copper Ethernet port, numbered 0/1.
- ◆ Removable CompactFlash card that is used to store the NetScaler software.
- ◆ Removable hard-disk drive that stores user data.

## Citrix NetScaler 12000-10G

The Citrix NetScaler 12000-10G appliance is a 2U appliance, with 2 single-core processors, and 4 GB of memory.

**Note:** The NetScaler nCore build is not supported on this hardware platform.

The following figure shows the front panel of the 12000-10G appliance.

**Figure 1-26. Citrix 12000-10G appliance, front panel**

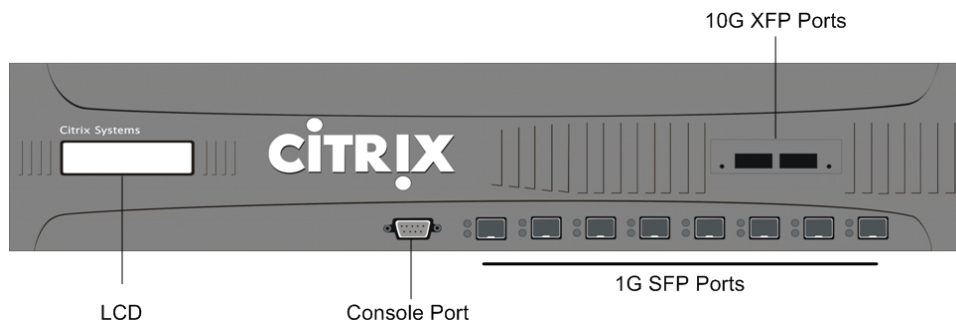

The following components are visible on the front panel of the 12000-10G appliance:

- ◆ RS232 serial console port.
- ◆ Eight 1G SFP ports, numbered 1/1, 1/2, 1/3, 1/4, 1/5, 1/6, 1/7, and 1/8 from left to right, and two XFP (10-Gigabit Small Form-Factor Pluggable) ports, numbered 1/9 and 1/10. When facing the bezel, the upper LEDs to the left of each optical 1G SFP port represent connectivity. They are lit and amber in color when active. The lower LEDs represent throughput. They are lit and green when active.

**Note:** The network port numbers on all appliances consist of two numbers separated by a forward slash. The first number is the port adapter slot number. The second number is the interface port number. Ports on appliances are numbered sequentially starting with 1.

The following figure shows the back panel of the 12000-10G appliance.

**Figure 1-27. Citrix NetScaler 12000-10G appliance, back panel**

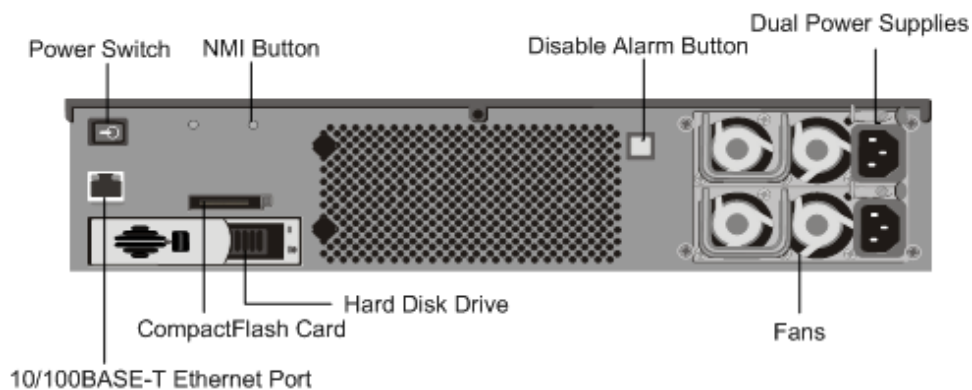

The following components are visible on the back panel of the 12000-10G appliance:

- ◆ Power switch, which turns off power to the appliance, just as if you were to unplug both power supplies.
- ◆ Non-maskable interrupt (NMI) button, which signals the appliance to perform an orderly shutdown after saving all files. You must use a pen, pencil, or other pointed object to press this button, which is located inside a small hole to prevent it being pressed accidentally.



- ◆ Disable alarm button, which silences the alarm that the appliance sounds when it is receiving power from only one of its power supplies. Press this button to prevent the power alarm from sounding when you have plugged the appliance into only one power outlet or when one power supply is malfunctioning and you wish to continue operating the appliance until it is repaired.
- ◆ Dual power supplies, each rated at 500 watts, 110-220 volts. You plug separate power cords into the power supplies and connect them to separate wall sockets. The appliance functions properly with a single power supply; the extra power supply serves as a backup.
- ◆ 10/100BASE-T copper Ethernet port, numbered 0/1.
- ◆ Removable CompactFlash card that is used to store the NetScaler software.
- ◆ Removable hard-disk drive that stores user data.

## Citrix NetScaler MPX 5500

The Citrix NetScaler MPX 5500 is a 1U appliance, with 1 dual-core processor, and 4 gigabytes (GB) of memory.

The following figure shows the front panel of the MPX 5500.

**Figure 1-28. Citrix NetScaler MPX 5500, front panel**

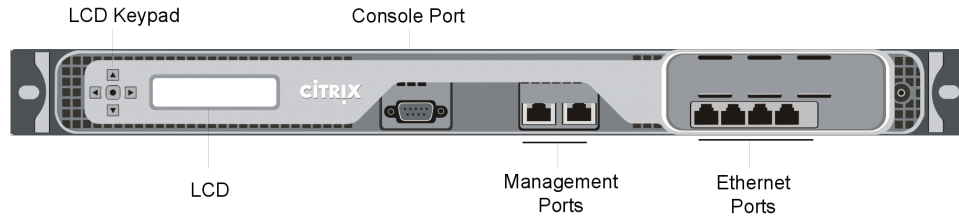

The MPX 5500 has the following ports:

- ◆ RS232 serial console port.
- ◆ Two 10/100/1000Base-T copper Ethernet management ports, numbered 0/1 and 0/2 from left to right. You can use these ports to connect directly to the appliance for system administration functions.
- ◆ Four 10/100/1000Base-T copper Ethernet ports numbered 1/1, 1/2, 1/3, and 1/4 from left to right.

**Note:** The network port numbers on all appliances consist of two numbers separated by a forward slash. The first number is the port adapter slot number. The second number is the interface port number. Ports on appliances are numbered sequentially starting with 1.

The following figure shows the back panel of the MPX 5500.

**Figure 1-29. Citrix NetScaler MPX 5500, back panel**

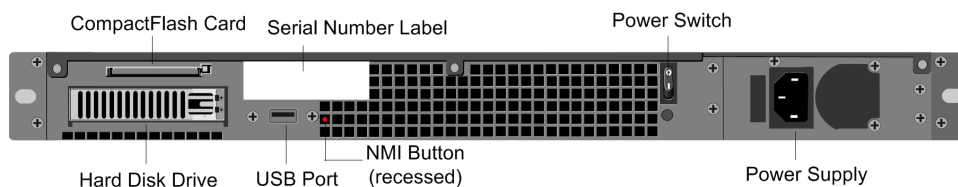

The following components are visible on the back panel of the MPX 5500:

- ◆ Four GB removable CompactFlash card that is used to store the NetScaler software.
- ◆ Power switch, which turns off power to the MPX 5500, just as if you were to unplug the power supply. Press the switch for five seconds to turn off the power.
- ◆ Removable hard-disk drive (HDD) that is used to store user data. Appliances shipped before February, 2012 store user data on a HDD. In appliances shipped after February, 2012, a solid-state drive replaces the HDD. Both types of drive have the same functionality and support the same software releases.
- ◆ USB port (reserved for a future release).
- ◆ Non-maskable interrupt (NMI) Button that is used at the request of Technical Support and produces a core dump on the NetScaler. You must use a pen, pencil, or other pointed object to press this red button, which is recessed to prevent unintentional activation.
- ◆ Power supply rated at 300 watts, 110-220 volts. The power-supply fan is designed to turn on only when the internal temperature of the power supply reaches a certain value. You cannot see the fan turning on the back panel. What you can see is the fixed part of the fan that holds the spinning motor.

## Citrix NetScaler MPX 5550 and MPX 5650

The Citrix NetScaler models MPX 5550 and MPX 5650 are 1U appliances. Each model has one quad-core processor and 8 gigabytes (GB) of memory.

The following figure shows the front panel of the MPX 5550/5650 appliance.

**Figure 1-30. Citrix NetScaler MPX 5550/5650, front panel**

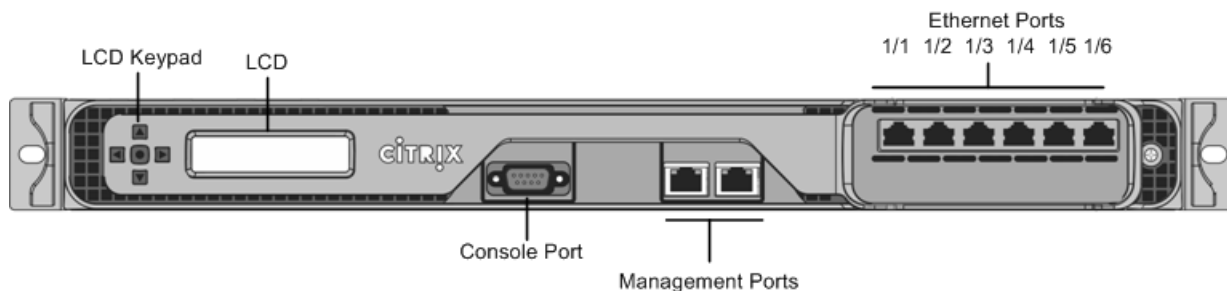

Depending on the model, the appliance has the following ports:

- ◆ RS232 serial console port.

- ◆ Two 10/100/1000Base-T copper Ethernet management ports (RJ45), numbered 0/1 and 0/2 from left to right. The management port is used to connect directly to the appliance for system administration functions.
- ◆ Six 10/100/1000Base-T copper Ethernet ports numbered 1/1, 1/2, 1/3, 1/4, 1/5, and 1/6 from left to right.

The following figure shows the back panel of the MPX 5550/5650 appliance.

**Figure 1-31. Citrix NetScaler MPX 5550/5650 appliance, back panel**

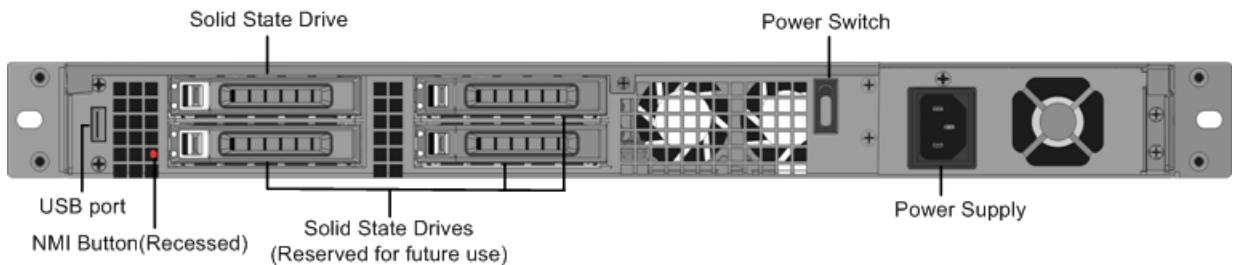

The following components are visible on the back panel of the MPX 5550/5650 appliance:

- ◆ 160 GB removable solid-state drive, which is used to store the NetScaler software and the user data.
- ◆ Power switch, which turns off power to the appliance, just as if you were to unplug the power supply. Press the switch for five seconds to turn off the power.
- ◆ USB port (reserved for a future release).
- ◆ Non-maskable interrupt (NMI) button, which is used at the request of Technical Support to produce a NetScaler core dump. You must use a pen, pencil, or other pointed object to press this red button, which is recessed to prevent unintentional activation.
- ◆ Single power supply, rated at 300 watts, 110-220 volts.

## Citrix NetScaler MPX 7500 and MPX 9500

The Citrix NetScaler MPX 7500/9500 are 1U appliances, each with 1 quad-core processor, and 8 gigabytes (GB) of memory. The MPX 7500/9500 appliances are available in two port configurations: 8x10/100/1000Base-T copper Ethernet ports and 4x1G SFP + 4x10/100/1000Base-T copper Ethernet ports.

The following figure shows the front panel of the MPX 7500/9500 (8x10/100/1000Base-T copper Ethernet ports) appliances.

**Figure 1-32. Citrix NetScaler MPX 7500/9500 (8x10/100/1000Base-T copper Ethernet ports), front panel**

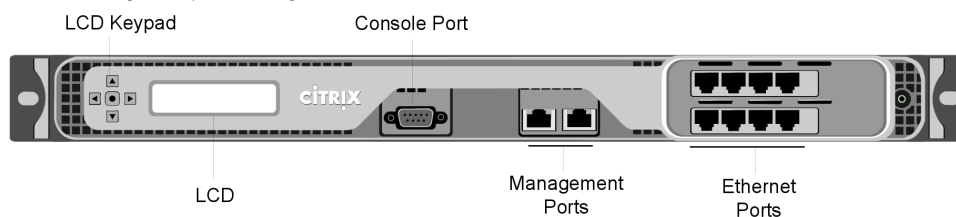

The following figure shows the front panel of the MPX 7500/9500 (4x1G SFP + 4x10/100/1000Base-T copper Ethernet ports) appliances.

**Figure 1-33. Citrix NetScaler MPX 7500/9500 (4x1G SFP + 4x10/100/1000Base-T copper Ethernet ports), front panel**

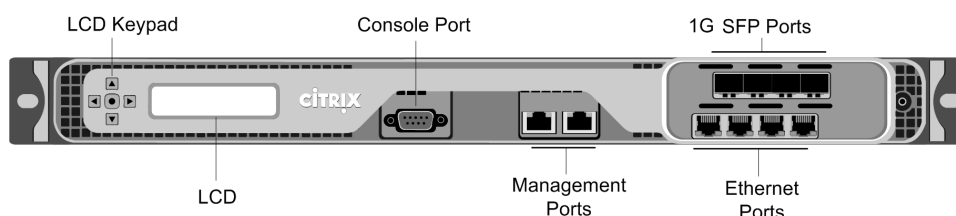

Depending on the model, the appliance has the following ports:

- ◆ RS232 serial console port.
- ◆ Two 10/100/1000Base-T copper Ethernet management ports, numbered 0/1 and 0/2 from left to right. These ports are used to connect directly to the appliance for system administration functions.
- ◆ Network Ports
  - MPX 7500/9500 (8x10/100/1000Base-T copper Ethernet ports). Eight 10/100/1000Base-T copper Ethernet ports numbered 1/1, 1/2, 1/3, and 1/4 on the top row from left to right, and 1/5, 1/6, 1/7, and 1/8 on the bottom row from left to right.
  - MPX 7500/9500 (4x1G SFP + 4x10/100/1000Base-T copper Ethernet ports). Four 1-gigabit copper or fiber 1G SFP ports numbered 1/1, 1/2, 1/3, and 1/4 on the top row from left to right, and four 10/100/1000BASE-T copper Ethernet ports (RJ45) numbered 1/5, 1/6, 1/7, and 1/8 on the bottom row from left to right.

The following figure shows the back panel of the MPX 7500/9500 appliance.

**Figure 1-34. Citrix NetScaler MPX 7500/9500, back panel**

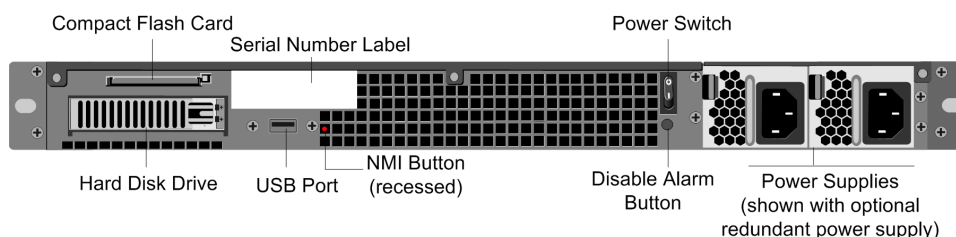

The following components are visible on the back panel of the MPX 7500/9500:

- ◆ Four-gigabyte removable CompactFlash card that is used to store the NetScaler software.
- ◆ Power switch, which turns off power to the MPX 7500/9500, just as if you were to unplug the power supply. Press the switch for five seconds to turn off the power.
- ◆ Removable hard-disk drive (HDD) that is used to store user data. Appliances shipped before February, 2012 store user data on a HDD. In appliances shipped after February, 2012, a solid-state drive replaces the HDD. Both types of drive have the same functionality and support the same software releases.
- ◆ USB port (reserved for a future release).
- ◆ Non-maskable interrupt (NMI) button that is used at the request of Technical Support and produces a core dump on the appliance. You must use a pen, pencil, or other pointed object to press this red button, which is recessed to prevent unintentional activation.
- ◆ Disable alarm button. This button is functional only when the appliance has two power supplies.

Press this button to stop the power alarm from sounding when you have plugged the MPX 7500/9500 into only one power outlet or when one power supply is malfunctioning and you want to continue operating the MPX 7500/9500 until it is repaired.

## Citrix NetScaler MPX 8200, MPX 8400, MPX 8600, and MPX 8800

The Citrix NetScaler models MPX 8200, MPX 8400, MPX 8600, and MPX 8800 are 1U appliances. Each model has one quad-core processor and 32 gigabytes (GB) of memory. The MPX 8200/8400/8600/8800 appliances are available in two port configurations:

- ◆ Six 10/100/1000Base-T copper Ethernet ports and six 1G SFP ports (6x10/100/1000Base-T copper Ethernet ports + 6x1G SFP)
- ◆ Six 10/100/1000Base-T copper Ethernet ports and two 10G SFP+ ports (6x10/100/1000Base-T copper Ethernet ports + 2x10G SFP+)

The following figure shows the front panel of the MPX 8200/8400/8600/8800 (6x10/100/1000Base-T copper Ethernet ports + 6x1G SFP) appliance.

**Figure 1-35. Citrix NetScaler MPX 8200/8400/8600/8800 (6x10/100/1000Base-T copper Ethernet ports + 6x1G SFP), front panel**

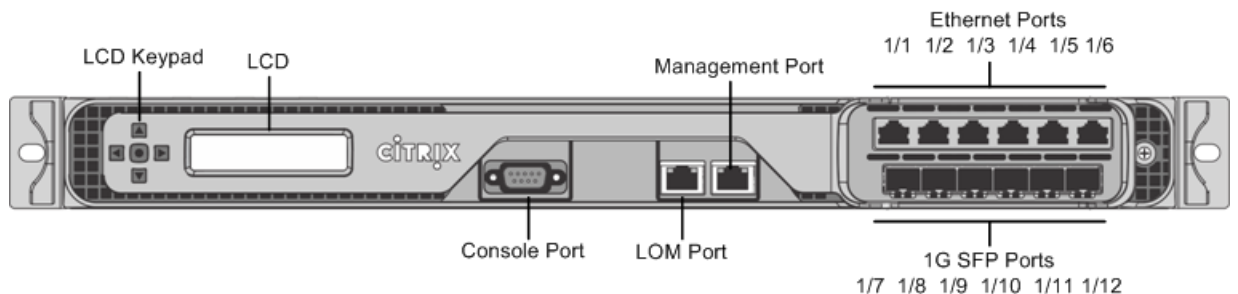

The following figure shows the front panel of the MPX 8200/8400/8600/8800 (6x10/100/1000Base-T copper Ethernet ports + 2x10G SFP+) appliance.

**Figure 1-36. Citrix NetScaler MPX 8200/8400/8600/8800 (6x10/100/1000Base-T copper Ethernet ports + 2x10G SFP+), front panel**

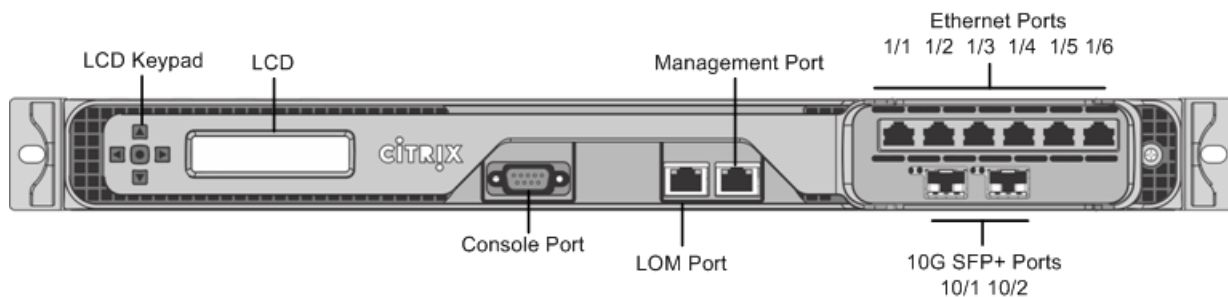

Depending on the model, the appliance has the following ports:

- ◆ RS232 serial console port.
- ◆ One 10/100Base-T copper Ethernet Port (RJ45), also called LOM port. You can use this port to remotely monitor and manage the appliance independently of the NetScaler software.
- ◆ One 10/100/1000Base-T copper Ethernet management port (RJ45), numbered 0/1. The management port is used to connect directly to the appliance for system administration functions.
- ◆ Network Ports
  - MPX 8200/8400/8600/8800 (6x10/100/1000Base-T copper Ethernet ports + 6x1G SFP). Six 10/100/1000BASE-T copper Ethernet ports (RJ45) numbered 1/1, 1/2, 1/3, 1/4, 1/5, and 1/6 on the top row from left to right, and six 1-gigabit copper or fiber 1G SFP ports numbered 1/7, 1/8, 1/9, 1/10, 1/11, and 1/12 on the bottom row from left to right.
  - MPX 8200/8400/8600/8800 (6x10/100/1000Base-T copper Ethernet ports + 2x10G SFP+). Six 10/100/1000BASE-T copper Ethernet ports (RJ45) numbered 1/1, 1/2, 1/3, 1/4, 1/5, and 1/6 on the top row from left to right and two 10-gigabit SFP+ ports numbered 10/1 and 10/2 on the bottom row from left to right.

The following figure shows the back panel of the MPX 8200/8400/8600/8800 appliance.

**Figure 1-37. Citrix NetScaler MPX 8200/8400/8600/8800 appliance, back panel**

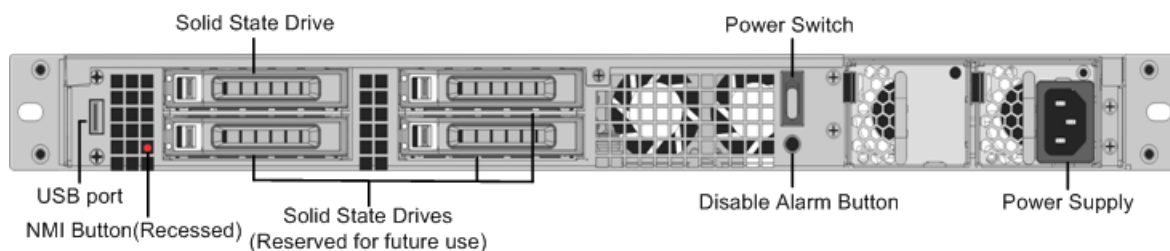

The following components are visible on the back panel of the MPX 8200/8400/8600/8800 appliance:

- ◆ 256 GB removable solid-state drive, which is used to store the NetScaler software and the user data.
- ◆ Power switch, which turns off power to the appliance, just as if you were to unplug the power supply. Press the switch for five seconds to turn off the power.
- ◆ USB port (reserved for a future release).
- ◆ Non-maskable interrupt (NMI) button, which is used at the request of Technical Support to produce a NetScaler core dump. You must use a pen, pencil, or other pointed object to press this red button, which is recessed to prevent unintentional activation.
- ◆ Disable alarm button, which is nonfunctional. This button is functional only if you install a second power supply.

Press this button to stop the power alarm from sounding when you have plugged the appliance into only one power outlet or when one power supply is malfunctioning and you want to continue operating the appliance until it is repaired.

- ◆ Single power supply, rated at 450 watts, 110-220 volts.

## Citrix NetScaler MPX 9700, MPX 10500, MPX 12500, and MPX 15500

The Citrix NetScaler MPX 9700/10500/12500/15500 are 2U appliances, each with 2 quad-core processors, and 16 gigabytes (GB) of memory. All these appliances are also available in a 10G model and a FIPS model.

The following figure shows the front panel of the MPX 9700/10500/12500/15500.

**Figure 1-38. Citrix NetScaler MPX 9700/10500/12500/15500, front panel**

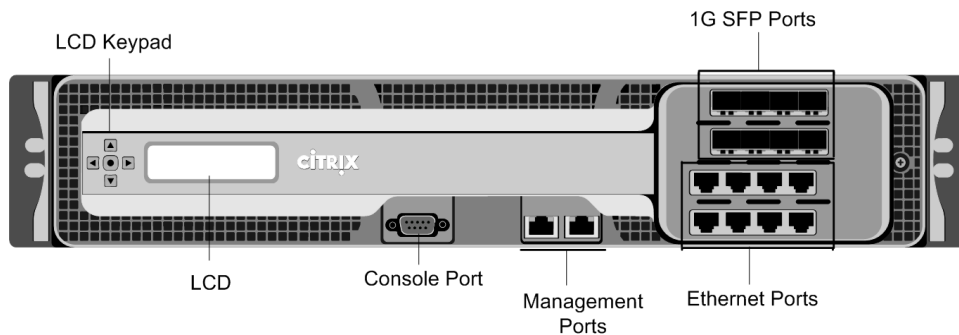

The following figure shows the front panel of the MPX 9700/10500/12500/15500 10G.

**Figure 1-39. Citrix NetScaler MPX 9700/10500/12500/15500 10G, front panel**

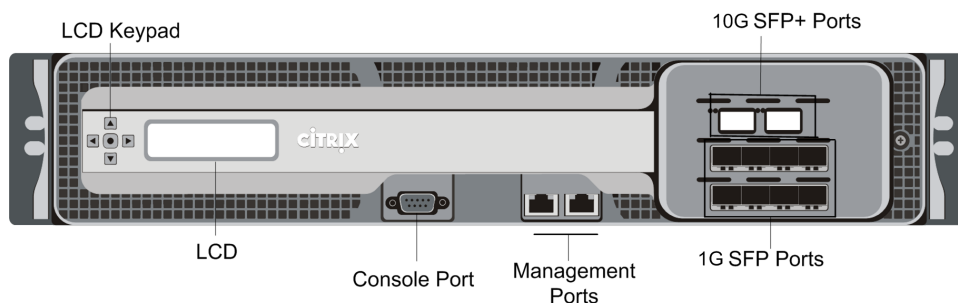

The following figure shows the front panel of the MPX 9700/10500/12500/15500 FIPS.

**Figure 1-40. Citrix NetScaler MPX 9700/10500/12500/15500 FIPS, front panel**

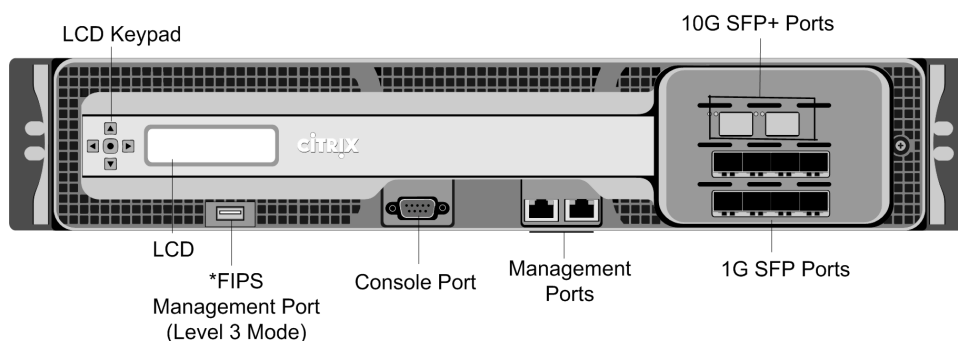

\*The FIPS Management Port (Level 3 Mode) is reserved for a future release.

**Caution:** Do not insert a USB device into the FIPS Management Port. This will cause the FIPS card to fail.

Depending on the model, the appliance has the following ports:

- ◆ FIPS Management Port (reserved for a future release).
- ◆ RS232 serial Console Port.
- ◆ Two 10/100/1000Base-T copper Ethernet Management Ports (RJ45), numbered 0/1 and 0/2 from left to right. These ports are used to connect directly to the appliance for system administration functions.
- ◆ Network Ports
  - MPX 9700/10500/12500/15500. Eight copper or fiber 1G SFP ports numbered 1/1, 1/2, 1/3, and 1/4 on the first row from left to right, and 1/5, 1/6, 1/7, and 1/8 on the second row from left to right. Eight 10/100/1000BASE-T copper Ethernet Ports (RJ45) numbered 1/9, 1/10, 1/11, and 1/12 on the third row from left to right, and 1/13, 1/14, 1/15, and 1/16 on the fourth row from left to right.
  - MPX 9700/10500/12500/15500 10G and MPX 9700/10500/12500/15000 FIPS. Two 10G SFP+ Ports numbered 10/1 and 10/2 on the top row, eight 1-gigabit copper or fiber 1G SFP Ports numbered 1/1, 1/2, 1/3, and 1/4 on the middle row from left to right, and 1/5, 1/6, 1/7, and 1/8 on the bottom row from left to right.



**Important:** The 10-gigabit ports on this appliance are labeled 10/1 and 10/2.

The following figure shows the back panel of the MPX 9700/10500/12500/15500 appliances, including the 10G model and FIPS model.

**Figure 1-41. Citrix NetScaler MPX 9700/10500/12500/15500, MPX 9700/10500/12500/15500 FIPS, and MPX 9700/10500/12500/15500 10G, back panel**

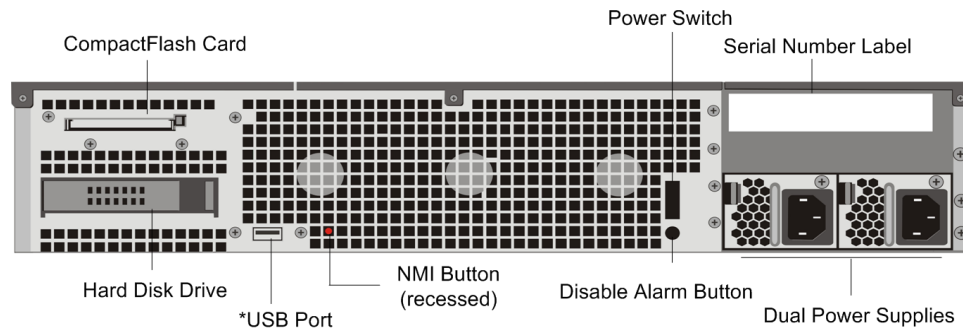

\*The USB Port is reserved for a future release.

The following components are visible on the back panel of the MPX 9700/10500/12500/15500, including the 10G model and FIPS model:

- ◆ Four GB removable CompactFlash Card that is used to store the NetScaler software.
- ◆ Power Switch, which turns off power to the appliance, just as if you were to unplug the power supply. Press the switch for five seconds to turn off the power.
- ◆ Removable Hard Disk Drive that is used to store user data.
- ◆ USB Port (reserved for a future release).
- ◆ Non-maskable interrupt (NMI) Button that is used at the request of Technical Support and produces a core dump on the NetScaler. You must use a pen, pencil, or other pointed object to press this red button, which is recessed to prevent unintentional activation.
- ◆ Disable Alarm Button. This button is functional only when the appliance has two power supplies.

Press this button to stop the power alarm from sounding when you have plugged the appliance into only one power outlet or when one power supply is malfunctioning and you want to continue operating the appliance until it is repaired.

- ◆ Dual Power Supplies, each rated at 450 watts, 110-220 volts.

## Citrix NetScaler MPX 11500, MPX 13500, MPX 14500, MPX 16500, MPX 18500, and MPX 20500

The Citrix NetScaler models MPX 11500/13500/14500/16500/18500/20500 are 2U appliances. Each model has two 6-core processors for a total of 12 physical cores (24 cores with hyper-threading), and 48 gigabytes (GB) of memory.

The following figure shows the front panel of the MPX 11500/13500/14500/16500/18500/20500 appliance.

**Figure 1-42. Citrix NetScaler MPX 11500/13500/14500/16500/18500/20500 appliance, front panel**

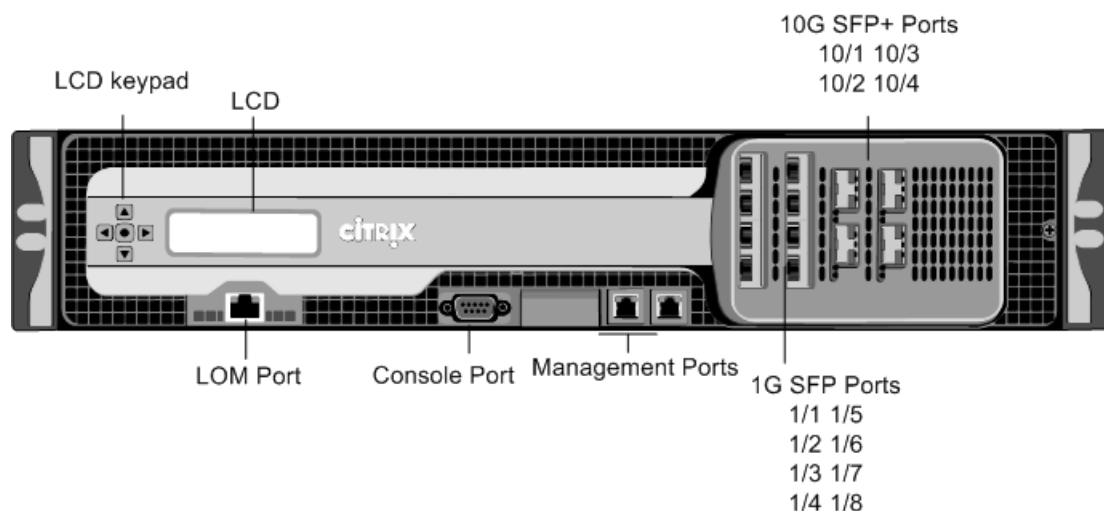

The MPX 11500/13500/14500/16500/18500/20500 appliances have the following ports:

- ◆ 10/100Base-T copper Ethernet Port (RJ45), also called LOM port. You can use this port to remotely monitor and manage the appliance independently of the NetScaler software.

**Note:** The LEDs on the LOM port are not operational by design.

- ◆ RS232 serial console port.
- ◆ Two 10/100/1000Base-T copper Ethernet management ports (RJ45), numbered 0/1 and 0/2 from left to right. These ports are used to connect directly to the appliance for system administration functions.
- ◆ Eight 1G SFP ports numbered 1/1, 1/2, 1/3, 1/4 from top to bottom in the first column, and 1/5, 1/6, 1/7, and 1/8 from top to bottom in the second column.
- ◆ Four 10G SFP+ ports numbered 10/1 and 10/2 from top to bottom in the first column, and 10/3 and 10/4 from top to bottom in the second column.

The following figure shows the back panel of the MPX 11500/13500/14500/16500/18500/20500 appliance.

**Figure 1-43. Citrix NetScaler MPX 11500/13500/14500/16500/18500/20500 appliance, back panel**

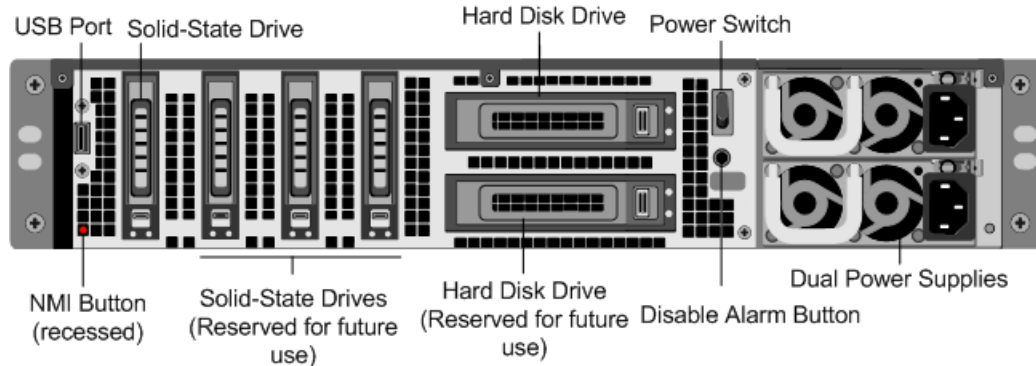

The following components are visible on the back panel of the MPX 11500/13500/14500/16500/18500/20500 appliance:

- ◆ 160 GB removable solid-state drive that is used to store the NetScaler software.
- ◆ USB port (reserved for a future release).
- ◆ Power switch, which turns off power to the appliance, just as if you were to unplug the power supply. Press the switch for five seconds to turn off the power.
- ◆ Non-maskable interrupt (NMI) Button that is used at the request of Technical Support and produces a core dump on the NetScaler. You must use a pen, pencil, or other pointed object to press this red button, which is recessed to prevent unintentional activation.
- ◆ Two removable hard-disk drives that are used to store user data.
- ◆ Disable alarm button. This button is functional only when the appliance has two power supplies.  
Press this button to stop the power alarm from sounding when you have plugged the appliance into only one power outlet or when one power supply is malfunctioning and you want to continue operating the appliance until it is repaired.
- ◆ Dual power supplies, each rated at 650 watts, 110-220 volts.

## Citrix NetScaler MPX 15000

The Citrix NetScaler MPX 15000 appliance is a 2U appliance, with 2 dual-core processors, and 16 GB of memory. The MPX 15000 is a high-capacity hardware platform intended for heavy use in enterprise and service provider environments. The following figure shows the front panel of the MPX 15000 appliance.

**Figure 1-44. Citrix NetScaler MPX 15000 appliance, front panel**

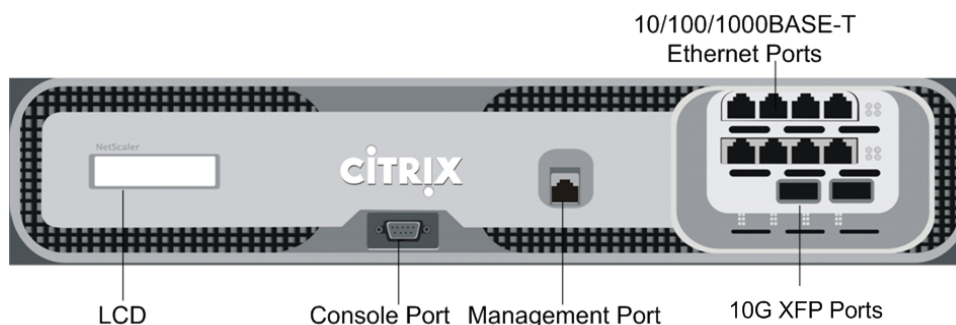

The appliance has the following ports:

- ◆ RS232 serial console port.
- ◆ 10/100/1000BASE-T copper Ethernet management port, numbered 0/1.
- ◆ Two XFP (10-Gigabit Small Form-Factor Pluggable) fiber optic ports, numbered from left to right 1/1 and 1/2.
- ◆ Eight 10/100/1000BASE-T copper Ethernet ports, numbered from upper left to bottom right 1/3, 1/4, 1/5, 1/6, 1/7, 1/8, 1/9, and 1/10.

When facing the bezel, the upper LEDs to the left of each port represent connectivity. They are lit and amber in color when active. The lower LEDs represent throughput. They are lit and green when active.

**Note:** The network port numbers on all appliances consist of two numbers separated by a forward slash. The first number is the port adapter slot number and will always be either 0 or 1. The second number is the interface port number. Ports on appliances are numbered sequentially starting with 1.

The following figure shows the back panel of the MPX 15000 appliance.

**Figure 1-45. Citrix NetScaler MPX 15000 appliance, back panel**

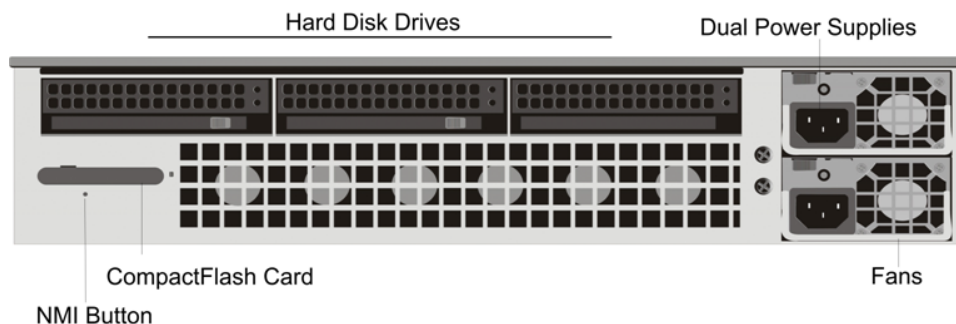

The following components are visible on the back panel of the MPX 15000 appliance:

- ◆ Removable hard-disk drive that is used to store user data.
- ◆ Dual power supplies, each rated at 500 watts, 110-220 volts.

You plug separate power cords into the power supplies and connect them to separate wall sockets. The MPX 15000 functions properly with a single power supply; the extra power supply serves as a backup.

- ◆ Non-maskable interrupt (NMI) button, which signals the MPX 15000 to perform an orderly shutdown after saving all files. You must use a pen, pencil, or other pointed object to press this button, which is located inside a small hole to prevent it from being pressed accidentally.
- ◆ Removable CompactFlash card that is used to store the NetScaler software.

## Citrix NetScaler MPX 17000

The Citrix NetScaler MPX 17000 appliance is a 2U appliance, with 2 quad-core processors, and 32 GB of memory. The MPX 17000 is a high-capacity hardware platform intended for any high traffic, intensive processing data center environment. There are two MPX 17000 models: the four network-port model and the ten network-port model.

The following figure shows the front panel of the MPX 17000, four network-port model.

**Figure 1-46.** Citrix NetScaler MPX 17000 four network-port model, front panel

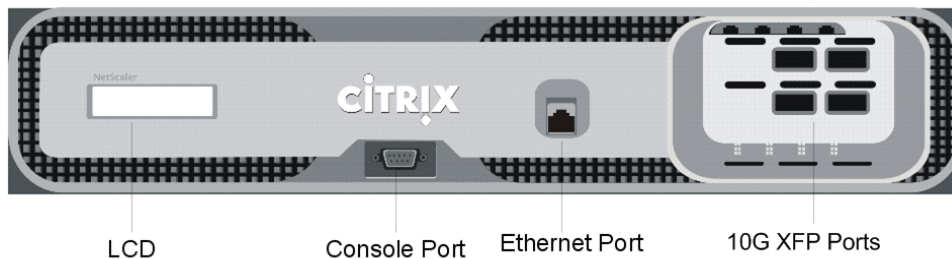

Depending on the model, the appliance has the following ports:

- ◆ RS232 serial console port.
- ◆ 10/100/1000BASE-T copper Ethernet management port, numbered 0/1.
- ◆ Network Ports
  - MPX 17000 four network-port model. Four XFP (10-Gigabit Small Form-Factor Pluggable) ports, numbered from upper left to bottom right 1/1, 1/2, 1/3, and 1/4.
  - MPX 17000 ten network-port model. Two XFP ports, numbered from left to right 1/1 and 1/2 and eight 10/100/1000BASE-T Ethernet ports, numbered from upper left to bottom right 1/3, 1/4, 1/5, 1/6, 1/7, 1/8, 1/9 and 1/10.

**Note:** The network port numbers on all appliances consist of two numbers separated by a forward slash. The first number is the port adapter slot number and will always be either 0 or 1. The second number is the interface port number. Ports on appliances are numbered sequentially starting with 1.

When facing the bezel, the upper LEDs to the left of each port represent connectivity. They are lit and amber in color when active. The lower LEDs represent throughput. They are lit and green when active.

The following figure shows the back panel of the MPX 17000 appliance.

**Figure 1-47. Citrix NetScaler MPX 17000 appliance, back panel**

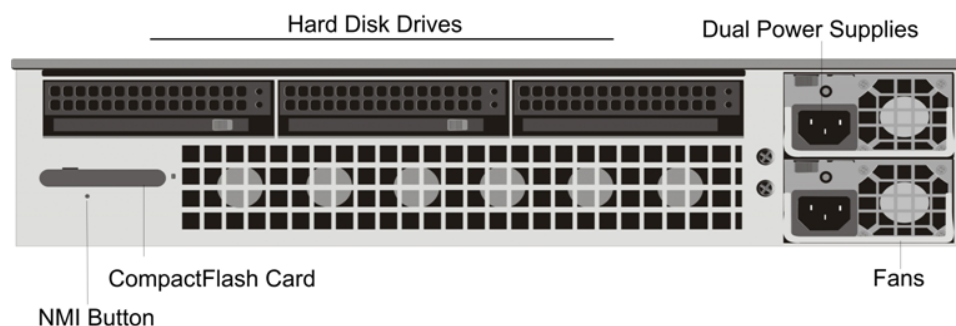

The following components are visible on the back of the MPX 17000 appliance:

- ◆ Removable hard-disk drive that is used to store user data.
- ◆ Dual power supplies, each rated at 500 watts, 110-220 volts.  
You plug separate power cords into the power supplies and connect them to separate wall sockets. The MPX 17000 functions properly with a single power supply; the extra power supply serves as a backup.
- ◆ Non-maskable interrupt (NMI) button, which signals the MPX 17000 to perform an orderly shutdown after saving all files. You must use a pen, pencil, or other pointed object to press this button, which is located inside a small hole to prevent it from being pressed accidentally.
- ◆ Removable CompactFlash card that is used to store the NetScaler software.

## Citrix NetScaler MPX 17500, MPX 19500, and MPX 21500

The Citrix NetScaler models MPX 17500/19500/21500 are 2U appliances. Each model has two 6-core processors and 48 gigabytes (GB) of memory.

The following figure shows the front panel of the MPX 17500/19500/21500 appliance.

**Figure 1-48. Citrix NetScaler MPX 17500/19500/21500 appliance, front panel**

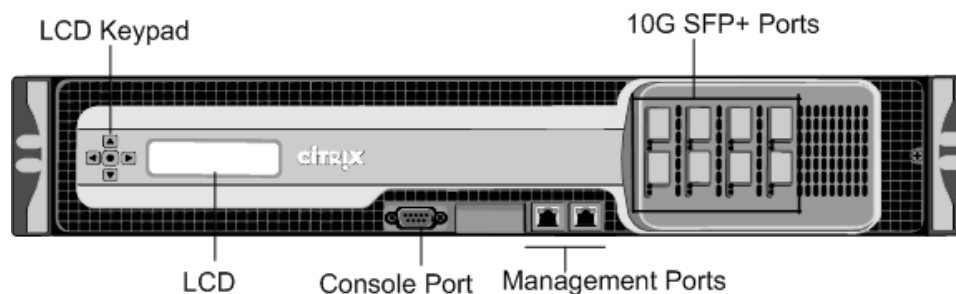

The MPX 17500/19500/21500 appliances have the following ports:

- ◆ RS232 serial console port.
- ◆ Two 10/100/1000Base-T copper Ethernet management ports (RJ45), numbered 0/1 and 0/2 from left to right. These ports are used to connect directly to the appliance for system administration functions.
- ◆ Eight 10G SFP+ ports numbered 10/1, 10/2, 10/3, and 10/4 on the top row from left to right, and 10/5, 10/6, 10/7, and 10/8 on the bottom row from left to right.

The following figure shows the back panel of the MPX 17500/19500/21500 appliance.

**Figure 1-49. Citrix NetScaler MPX 17500/19500/21500 appliance, back panel**

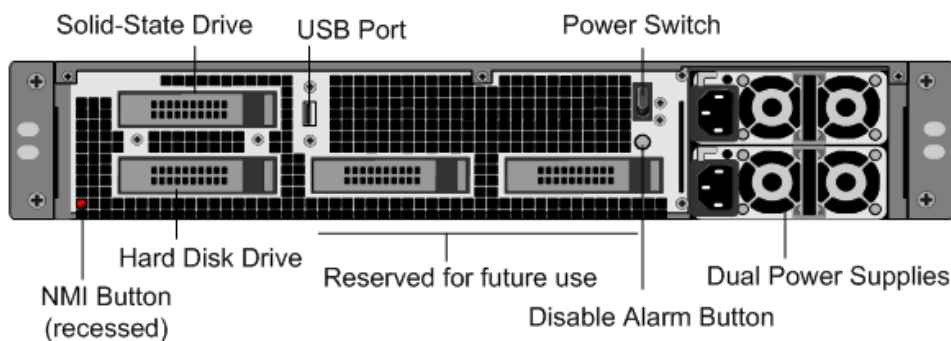

The following components are visible on the back panel of the MPX 17500/19500/21500 appliance:

- ◆ 160 GB removable solid-state drive that is used to store the NetScaler software.
- ◆ USB port (reserved for a future release).
- ◆ Power switch, which turns off power to the appliance, just as if you were to unplug the power supply. Press the switch for five seconds to turn off the power.
- ◆ Non-maskable interrupt (NMI) button that is used at the request of Technical Support and produces a core dump on the NetScaler. You must use a pen, pencil, or other pointed object to press this red button, which is recessed to prevent unintentional activation.
- ◆ Removable hard-disk drive that stores user data.
- ◆ Disable alarm button. This button is functional only when the appliance has two power supplies.  
Press this button to stop the power alarm from sounding when you have plugged the appliance into only one power outlet or when one power supply is malfunctioning and you want to continue operating the appliance until it is repaired.
- ◆ Dual power supplies, each rated at 650 watts, 110-220 volts.

## Citrix NetScaler MPX 17550, MPX 19550, MPX 20550, and MPX 21550

The Citrix NetScaler models MPX 17550, MPX 19550, MPX 20550, and MPX 21550 are 2U appliances. Each model has two 6-core processors for a total of 12 physical cores (24 cores with hyper-threading), and 96 gigabytes (GB) of memory.

The following figure shows the front panel of the MPX 17550/19550/20550/21550 appliance.

**Figure 1-50. Citrix NetScaler MPX 17550/19550/20550/21550 appliance, front panel**

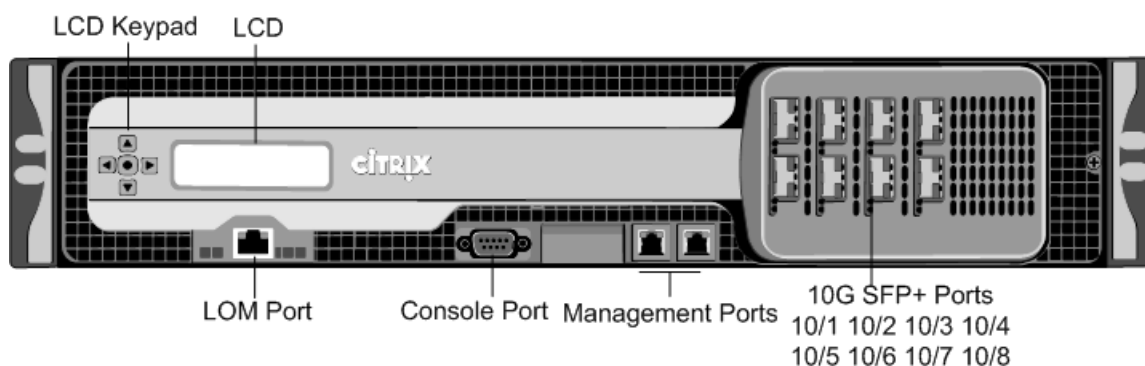

The MPX 17550/19550/20550/21550 appliance has the following ports:

- ◆ 10/100Base-T copper Ethernet Port (RJ45), also called LOM port. You can use this port to remotely monitor and manage the appliance independently of the NetScaler software.

**Note:** The LEDs on the LOM port are not operational by design.

- ◆ RS232 serial console port.
- ◆ Two 10/100/1000Base-T copper Ethernet management ports (RJ45), numbered 0/1 and 0/2 from left to right. These ports are used to connect directly to the appliance for system administration functions.
- ◆ Eight 10G SFP+ ports numbered 10/1, 10/2, 10/3, and 10/4 on the top row from left to right, and 10/5, 10/6, 10/7, and 10/8 on the bottom row from left to right.

The following figure shows the back panel of the MPX 17550/19550/20550/21550 appliance.

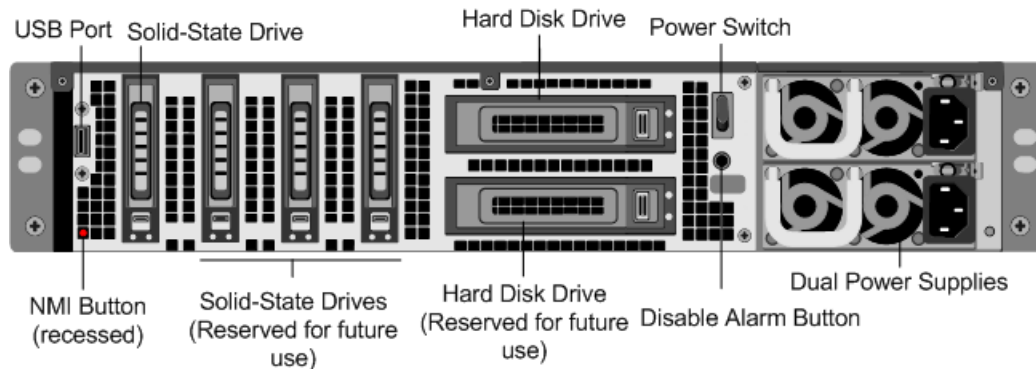

**Figure 1-51. Citrix NetScaler MPX 17550/19550/20550/21550 appliance, back panel**

The following components are visible on the back panel of the MPX 17550/19550/20550/21550 appliance:

- ◆ 160 GB removable solid-state drive that is used to store the NetScaler software.
- ◆ USB port (reserved for a future release).
- ◆ Power switch, which turns off power to the appliance, just as if you were to unplug the power supply. Press the switch for five seconds to turn off the power.
- ◆ Non-maskable interrupt (NMI) button that is used at the request of Technical Support and produces a core dump on the NetScaler. You must use a pen, pencil, or other pointed object to press this red button, which is recessed to prevent unintentional activation.
- ◆ Two removable hard-disk drives that store user data.
- ◆ Disable alarm button. This button is functional only when the appliance has two power supplies.

Press this button to stop the power alarm from sounding when you have plugged the appliance into only one power outlet or when one power supply is malfunctioning and you want to continue operating the appliance until it is repaired.

- ◆ Dual power supplies, each rated at 850 watts, 110-220 volts.

## Citrix NetScaler MPX 22040, MPX 22060, MPX 22080, MPX 22100, and MPX 22120

The Citrix NetScaler MPX 22040/22060/22080/22100/22120 are 2U appliances. Each model has two 8-core processors, and 256 gigabytes (GB) of memory. The MPX 22040/22060/22080/22100/22120 appliances are available in two port configurations:

- ◆ Twelve 1G SFP ports and twenty-four 10G SFP+ ports (12x1G SFP + 24x10G SFP+)
- ◆ Twenty-four 10G SFP+ ports (24x10G SFP+)

The following figure shows the front panel of the MPX 22040/22060/22080/22100/22120 (12x1G SFP + 24x10G SFP+) appliance.

**Figure 1-52. Citrix NetScaler MPX 22040/22060/22080/22100/22120 (12x1G SFP + 24x10G SFP+), front panel**

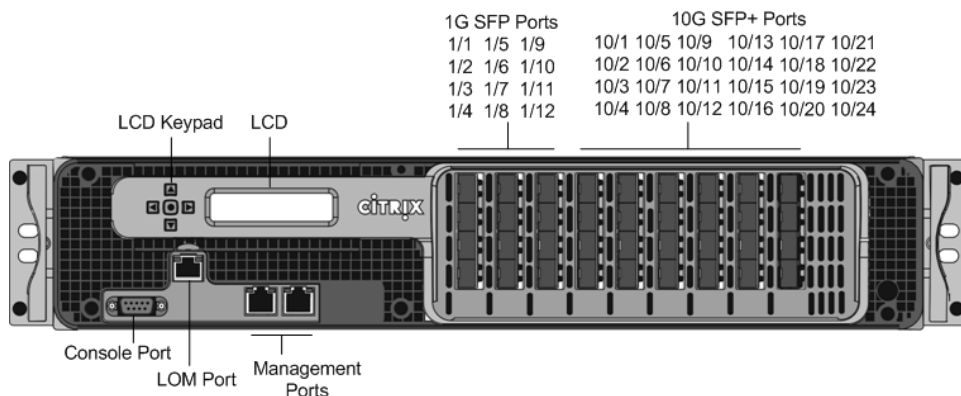

The following figure shows the front panel of the MPX 22040/22060/22080/22100/22120 (24x10G SFP+) appliance.

**Figure 1-53. Citrix NetScaler MPX 22040/22060/22080/22100/22120 (24x10G SFP+), front panel**

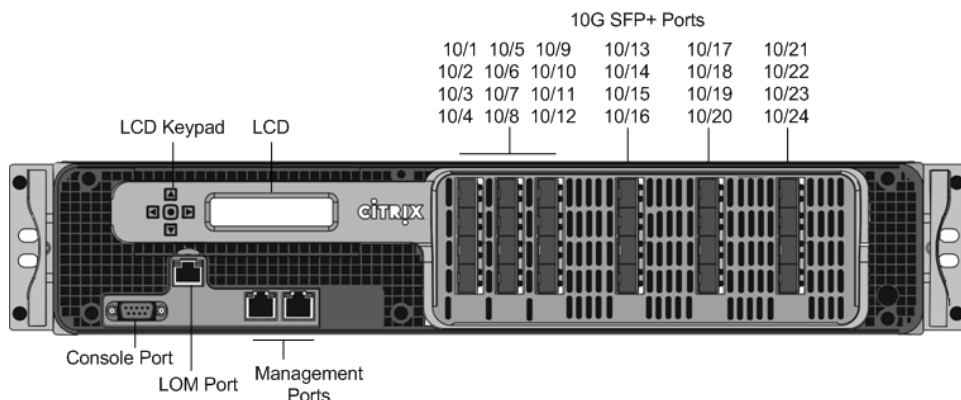

Depending on the model, the appliance has the following ports:

- ◆ RS232 serial Console Port.
- ◆ 10/100Base-T copper Ethernet Port (RJ45), also called LOM port. You can use this port to remotely monitor and manage the appliance independently of the NetScaler software.
- ◆ Two 10/100/1000Base-T copper Ethernet Management Ports (RJ45), numbered 0/1 and 0/2 from left to right. These ports are used to connect directly to the appliance for system administration functions.
- ◆ Network Ports
  - MPX 22040/22060/22080/22100/22120 (12x1G SFP + 24x10G SFP+). Twelve copper or fiber 1G SFP ports and twenty-four 10G SFP+ ports.
  - MPX 22040/22060/22080/22100/22120 (24x10G SFP+). Twenty-four 10G SFP+ ports.

The following figure shows the back panel of the MPX 22040/22060/22080/22100/22120 appliances.

**Figure 1-54. Citrix NetScaler MPX 22040/22060/22080/22100/22120, back panel**

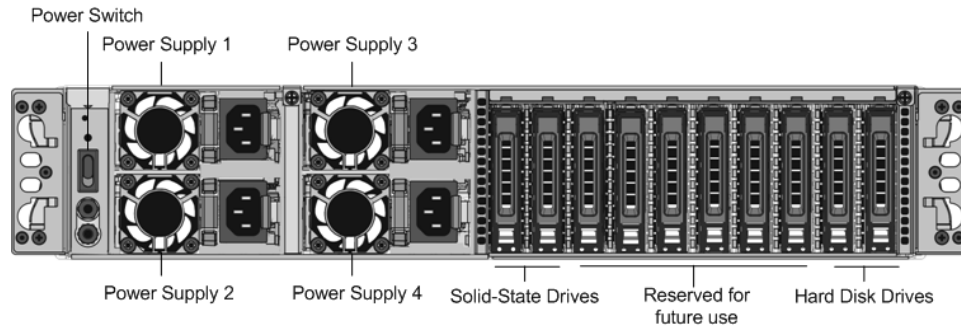

The following components are visible on the back panel of the MPX 22040/22060/22080/22100/22120 appliance:

- ◆ Power switch, which turns off power to the appliance, just as if you were to unplug the power supply. Press the switch for five seconds to turn off the power.
- ◆ Two 256 GB removable solid-state drives. The leftmost solid-state drive stores the NetScaler software. The other solid-state drive stores user data.
- ◆ Two 1TB removable hard disk drives that are used to store user data.
- ◆ Four power supplies, each rated at 750 watts, 100-240 volts. A minimum of two power supplies are required for proper operation. The extra power supplies act as backup.

## Summary of Hardware Specifications

The following tables summarize the specifications of the hardware platforms.

**Table 1-16. Standard Platform Summary**

	9010 FIPS	12000-10G
Processor	1 single-core	2 single-cores
Memory	2 GB	4 GB
Number of Power Supplies	2	2
Power Supply input voltage & frequency	100-240 VAC 47-63 Hz	100-240 VAC 47-63 Hz

	9010 FIPS	12000-10G
Maximum Power Consumption	500 W	500 W
Weight	52 lbs 23.59 kg	52 lbs 23.59 kg
Height	2U	2U
Width	EIA 310-D	EIA 310-D
Depth	24 in or 61 cm	24 in or 61 cm
Operating Temperature	0-40° C 32-104° F	0-40° C 32-104° F
Humidity range (non-condensing)	5%-95%	5%-95%
Safety Certifications	TUV	TUV
EMC & Susceptibility	FCC Class A, CB, FCC, CE, VCCI, C-Tick, NOM	FCC Class A, CB, FCC, CE, VCCI, C-Tick, NOM, SASO/CITC
Compliance	RoHS, WEEE	RoHS, WEEE

**Table 1-17. MPX Platform Summary**

	MPX 5500	MPX 5550/MPX 5650	MPX 7500/MPX 9500	MPX 15000
Processors	1 dual-core	1 quad-core	1 dual-core	2 quad-core
Memory	4 GB	8 GB	8 GB	16 GB
Ports - 1G	4x10/100/1000Base-T copper Ethernet ports	6x10/100/1000Base-T copper Ethernet ports	<b>8x10/100/1000Base-T copper Ethernet ports model:</b> 8x10/100/1000Base-T copper Ethernet ports	8x10/100/1000Base-T copper Ethernet ports

	MPX 5500	MPX 5550/MPX 5650	MPX 7500/MPX 9500	MPX 15000
			4x1G SFP + 4x10/100/1000Base-T copper Ethernet ports model:  4xcopper/fiber 1G SFP ports,  4x10/100/1000Base-T copper Ethernet ports	
Ports - 10G	NA	NA	NA	NA
Number of Power Supplies	1	1	1 with second optional	2
AC Power Supply input voltage, frequency, & current	100-240 VAC 50-60 Hz 3-1.5 A	100-240 VAC 50-60 Hz 2.5 A	100-240 VAC 50-60 Hz 3-1.5 A	100-240 VAC 47-63 Hz
Maximum Power Consumption	260 W	300 W	260 W	700 W
Heat Dissipation	887 BTU per hour	630 BTU per hour	887 BTU per hour	
Weight	22 lbs 9.98 kg	32 lbs 14.5 kg	23 lbs with one power supply 10.43 kg with one power supply	52 lbs 23.58 kg
Height	1U	1U	1U	2U
Width	EIA 310-D for 19-inch racks	EIA 310-D for 19-inch racks	EIA 310-D for 19-inch racks	EIA 310-D for 19-inch racks

	<b>MPX 5500</b>	<b>MPX 5550/MPX 5650</b>	<b>MPX 7500/MPX 9500</b>	<b>MPX 15000</b>
Depth	21.75 in or 55 cm	24.02 in or 61 cm	21.75 in or 55 cm	18.5 in or 47 cm
Operating Temperature	0-40° C 32-104° F	0-40° C 32-104° F	0-40° C 32-104° F	0-35° C 32-95° F
Humidity range (non-condensing)	5%-95%	5%-95%	5%-95%	5%-95%
Safety Certifications	CSA	CSA	CSA	UL & TUV-C
EMC & Susceptibility	FCC (Part 15 Class A), CE, C-Tick, CCC, KCC, NOM, PCT, VCCI, SASO, SABS	FCC (Part 15 Class A), CE, C-Tick, VCCI-A, CCC, KCC, NOM, SASO, SABS, PCT	FCC (Part 15 Class A), CE, C-Tick, CCC, KCC, NOM, PCT, VCCI, SASO, SABS	FCC (Part 15 Class A), DoC, CE, VCCI, CNS, AN/NES
Compliance	RoHS, WEEE	RoHS, WEEE	RoHS, WEEE	RoHS, WEEE

**Table 1-18. MPX Platform Summary (contd.)**

	<b>MPX 17000</b>	<b>MPX 8200/MPX 8400/MPX 8600/MPX 8800</b>	<b>MPX 9700/MPX 10500/MPX 12500/MPX 15500</b>	<b>MPX 11500/MPX 13500/MPX 14500/MPX 16500/MPX 18500/ MPX 20500</b>
Processors	2 quad-core	1 quad-core	2 quad-core	2 six-core
Memory	32 GB	32 GB	16 GB	48 GB
Ports - 1G	<b>Ten network-port model:</b>	<b>6x1G SFP + 6x10/100/1000 Base-T copper Ethernet model:</b>	8x10/100/1000 Base-T copper Ethernet ports, 8xcopper/fiber 1G SFP ports	8x1G SFP ports

	<b>MPX 17000</b>	<b>MPX 8200/MPX 8400/MPX 8600/MPX 8800</b>	<b>MPX 9700/MPX 10500/MPX 12500/MPX 15500</b>	<b>MPX 11500/MPX 13500/MPX 14500/MPX 16500/MPX 18500/ MPX 20500</b>
	8x10/100/1000Base-T copper Ethernet ports	6xcopper/fiber 1G SFP ports, 6x10/100/1000Base-T copper Ethernet ports  2x10G SFP+ 6x10/100/1000 Base-T copper Ethernet model:  6xcopper/fiber 1G SFP ports	<b>10G and FIPS model:</b>  8xcopper/fiber 1G SFP ports	
Ports - 10G	<b>Four network-port model:</b> 4x10G XFP ports  <b>Ten network-port model:</b> 2x10G XFP ports	2x10G SFP+ 6x10/100/1000 Base-T copper Ethernet model:  2x10G SFP+ Ports	<b>10G and FIPS model:</b>  2x10G SFP+ ports	4x10G SFP+ ports
Number of Power Supplies	2	1	2	2
AC Power Supply input voltage, frequency, & current	100-240 VAC 47-63 Hz	100-240 VAC 50-60 Hz 2.5 A	100-240 VAC 50-60 Hz 4.5-2.5 A	100-240 VAC 50-60 Hz 6.5-3.5 A
Maximum Power Consumption	700 W	450 W	450 W	650 W

	<b>MPX 17000</b>	<b>MPX 8200/MPX 8400/MPX 8600/MPX 8800</b>	<b>MPX 9700/MPX 10500/MPX 12500/MPX 15500</b>	<b>MPX 11500/MPX 13500/MPX 14500/MPX 16500/MPX 18500/ MPX 20500</b>
Heat Dissipation		630 BTU per hour	1550 BTU per hour	2200 BTU per hour
Weight	52 lbs 23.59 kg	32 lbs 14.52 kg	31 lbs 14.06 kg	46 lbs 20.87 kg
Height	2U	1U	2U	2U
Width	EIA 310-D for 19-inch racks	EIA 310-D for 19-inch racks	EIA 310-D for 19-inch racks	EIA 310-D for 19-inch racks
Depth	18.5 in or 47 cm	24.01 in or 61 cm	24.5 in or 62 cm	28 in or 71.68 cm
Operating Temperature	0-35° C 32-95° F	0-40° C 32-104° F	0-40° C 32-104° F	0-40° C 32-104° F
Humidity range (non-condensing)	5%-95%	5%-95%	5%-95%	5%-95%
Safety Certifications	UL & TUV-C	TUV	CSA	CSA
EMC & Susceptibility	FCC (Part 15 Class A), DoC, CE, VCCI, CNS, AN/NES	FCC (Part 15 Class A), CE, C-Tick, VCCI-A	FCC (Part 15 Class A), CE, C-Tick, KCC, NOM, PCT, VCCI, SASO, SABS	FCC (Part 15 Class A), CE, C-Tick, VCCI, CCC, KC, NOM, GOST, SABS, SASO
Compliance	RoHS, WEEE	RoHS, WEEE	RoHS, WEEE	RoHS, SVHC, WEEE



**Table 1-19. MPX Platform Summary (contd.)**

	<b>MPX 17500/MPX 19500/MPX 21500</b>	<b>MPX 17550/MPX 19550/MPX 20550/MPX 21550</b>	<b>MPX 22040/MPX 22060/MPX 22080/MPX 22100/MPX 22120</b>
Processors	2 six-core	2 six-core	2 eight-core
Memory	48 GB	96 GB	256 GB
Ports - 1G	NA	NA	<b>12x1G SFP + 24x10G SFP+ model:</b> 12xcopper/fiber 1G SFP ports
Ports - 10G	8x10G SFP+ ports	8x10G SFP+ ports	<b>12x1G SFP + 24x10G SFP+ model:</b> 24x10G SFP+ ports <b>24x10G SFP+ ports model:</b> 24x10G SFP+ ports
Number of Power Supplies	2	2	4
AC Power Supply input voltage, frequency, & current	100-240 VAC 50-60 Hz 6.5-3.5 A	100-240 VAC 50-60 Hz 6.5-3.5 A	<b>12x1G SFP + 24x10G SFP+ model:</b> 100-240VAC 50/60Hz 6.0-12.0A <b>24x10G SFP+ model:</b> 100-240VAC 50/60Hz 6.5-15.5A
Maximum Power Consumption	650 W	850 W	<b>12x1G SFP + 24x10G SFP+ model:</b> 1050 W

	<b>MPX 17500/MPX 19500/MPX 21500</b>	<b>MPX 17550/MPX 19550/MPX 20550/MPX 21550</b>	<b>MPX 22040/MPX 22060/MPX 22080/MPX 22100/MPX 22120</b>
			<b>24x10G SFP+ model:</b> 1400 W
Heat Dissipation	2200 BTU per hour	2900 BTU per hour	<b>12x1G SFP + 24x10G SFP+ model:</b> 2,000-2,6000 BTU per hour <b>24x10G SFP+ model:</b> 2,700-3,800 BTU per hour
Weight	40 lbs 18.14 kg	40 lbs 18.14 kg	85 lbs 38.56 kg
Height	2U	2U	2U
Width	EIA 310-D for 19-inch racks	EIA 310-D for 19-inch racks	EIA 310-D for 19-inch racks
Depth	24.75 in or 62.865 cm	24.75 in or 62.865 cm	28¼ in or 72 cm
Operating Temperature	0-40° C 32-104° F	0-40° C 32-104° F	0-40° C 32-104° F
Humidity range (non-condensing)	5%-95%	5%-95%	20%-80%
Safety Certifications	TUV	TUV	CSA
EMC & Susceptibility	FCC (Part 15 Class A), CE, C-Tick, VCCI-A	FCC (Part 15 Class A), CE, C-Tick, VCCI-A	FCC (Part 15 Class A), CE (EN55022/55024), C-Tick, VCCI

	<b>MPX 17500/MPX 19500/MPX 21500</b>	<b>MPX 17550/MPX 19550/MPX 20550/MPX 21550</b>	<b>MPX 22040/MPX 22060/MPX 22080/MPX 22100/MPX 22120</b>
Compliance	RoHS, WEEE	RoHS, WEEE	RoHS, WEEE



---

## Chapter 2

# Preparing for Installation

### Topics:

- [Unpacking the Appliance](#)
- [Preparing the Site and Rack](#)
- [Cautions and Warnings](#)

Before you install your new appliance, carefully unpack your appliance and make sure that all parts were delivered. Once you are satisfied that your appliance has been delivered to your expectations, verify that the location where the appliance will be installed meets temperature and power requirements and that the server cabinet or floor-to-ceiling cabinet is securely bolted to the floor and has sufficient airflow.

Only trained and qualified personnel should install, maintain, or replace the appliance, and efforts should be taken to ensure that all cautions and warnings are followed.

## Unpacking the Appliance

The hardware accessories for your particular appliance, such as cables, adapters, and rail kit, vary depending on the hardware platform you ordered. Unpack the box that contains your new appliance on a sturdy table with plenty of space and inspect the contents.

Use the following list to verify that you received everything that should have been included in the box.

- ◆ The appliance you ordered
- ◆ One RJ-45 to DB-9 adapter
- ◆ One 6 ft RJ-45/DB-9 cable
- ◆ The following list specifies the number of power cables included for each appliance model:
  - One power cable for the MPX 5500, MPX 5550/5650, MPX 7500/9500, and MPX 8200/8400/8600/8800 appliances
  - Two power cables for the 9010 FIPS, 12000-10G, MPX 15000, MPX 17000, MPX 9700/10500/12500/15500, MPX 11500/13500/14500/16500/18500/20500, MPX 17500/19500/21500, and MPX 17550/19550/20550/21550 appliances
  - Four power cables for the MPX 22040/22060/22080/22100/22120 appliance

**Note:** Make sure that a power outlet is available for each cable.

**Note:** For Brazilian customers, Citrix does not ship a power cable. Use a cable that conforms to the **ABNT NBR 14136:2002** standard.

- ◆ One standard 4-post rail kit

**Note:** If the kit that you received does not fit your rack, contact your Citrix sales representative to order the appropriate kit.

In addition to the items included in the box with your new appliance, you will need the following items to complete the installation and initial configuration process.

- ◆ Ethernet cables for each additional Ethernet port that you will connect to your network
- ◆ One available Ethernet port on your network switch or hub for each NetScaler Ethernet port you want to connect to your network

**Note:** Transceiver modules are sold separately. Contact your Citrix sales representative to order transceiver modules for your appliance. Only transceivers supplied by Citrix are supported on the appliance.

- ♦ A computer to serve as a management workstation

## Preparing the Site and Rack

There are specific site and rack requirements for the NetScaler appliance. You must make sure that adequate environmental control and power density are available. Racks must be bolted to the ground, have sufficient airflow, and have adequate power and network connections. Preparing the site and rack are important steps in the installation process and help ensure a smooth installation.

### Site Requirements

The appliance should be installed in a server room or server cabinet with the following features:

#### Environment control

An air conditioner, preferably a dedicated computer room air conditioner (CRAC), capable of maintaining the cabinet or server room at a temperature of no more than 21 degrees C/70 degrees F at altitudes of up to 2100 m/7000 ft, or 15 degrees C/60 degrees F at higher altitudes, a humidity level no greater than 45 percent, and a dust-free environment.

#### Power density

Wiring capable of handling at least 4,000 watts per rack unit in addition to power needs for the CRAC.

### Rack Requirements

The rack on which you install your appliance should meet the following criteria:

#### Rack characteristics

Racks should be either integrated into a purpose-designed server cabinet or be the floor-to-ceiling type, bolted down at both top and bottom to ensure stability. If you have a cabinet, it should be installed perpendicular to a load-bearing wall for stability and sufficient airflow. If you have a server room, your racks should be installed in rows spaced at least 1 meter/3 feet apart for sufficient airflow. Your rack must allow your IT personnel unfettered access to the front and back of each server and to all power and network connections.

#### Power connections

At minimum, two standard power outlets per unit.

#### Network connections

At minimum, four Ethernet connections per rack unit.

### Space requirements

One empty rack unit for the Citrix NetScaler 7000, MPX 5500, MPX 5550/5650, MPX 7500/9500, and MPX 8200/8400/8600/8800, and two consecutive empty rack units for all other appliance models.

**Note:** You can order the following rail kits separately.

- ◆ Compact 4-post rail kit, which fits racks of 23 to 33 inches.
- ◆ 2-post rail kit, which fits 2-post racks.

## Cautions and Warnings

### Electrical Safety Precautions

 **Caution:** During installation or maintenance procedures, wear a grounding wrist strap to avoid ESD damage to the electronics of the appliance. Use a conductive wrist strap attached to a good earth ground or to the appliance. You can attach it to the connector beside the ESD symbol on the back.

Follow basic electrical safety precautions to protect yourself from harm and the appliance from damage.

- ◆ Be aware of the location of the emergency power off (EPO) switch, so that you can quickly remove power to the appliance if an electrical accident occurs.
- ◆ Remove all jewelry and other metal objects that might come into contact with power sources or wires before installing or repairing the appliance. When you touch both a live power source or wire and ground, any metal objects can heat up rapidly and may cause burns, set clothing on fire, or fuse the metal object to an exposed terminal.
- ◆ Use a regulating, uninterruptible power supply (UPS) to protect the appliance from power surges and voltage spikes, and to keep the appliance operating in case of power failure.
- ◆ Never stack the appliance on top of any other server or electronic equipment.
- ◆ All appliances are designed to be installed on power systems that use TN earthing. Do not install your device on a power system that uses either TT or IT earthing.
- ◆ Make sure that the appliance has a direct physical connection to the earth during normal use. When installing or repairing an appliance, always make sure that the ground circuit is connected first and disconnected last.



- ◆ Make sure that a fuse or circuit breaker no larger than 120 VAC, 15 A U.S. (240 VAC, 16 A international) is used on all current-carrying conductors on the power system to which your appliances are connected.
- ◆ Do not work alone when working with high voltage components.
- ◆ Always disconnect the appliance from power before removing or installing any component. When disconnecting power, first shut down the appliance, and then unplug the power cords of all the power supply units connected to the appliance. As long as the power cord is plugged in, line voltages can be present in the power supply, even when the power switch is OFF.
- ◆ Do not use mats designed to decrease static electrical discharge as protection from electrical shock. Instead, use rubber mats that have been specifically designed as electrical insulators.
- ◆ Make sure that the power source can handle the appliance's maximum power consumption rating with no danger of an overload. Always unplug any appliance before performing repairs or upgrades.
- ◆ Do not overload the wiring in your server cabinet or on your server room rack.
- ◆ During thunderstorms, or anticipated thunderstorms, avoid performing any hardware repairs or upgrades until the danger of lightning has passed.
- ◆ When you dispose of an old appliance or any components, follow any local and national laws on disposal of electronic waste.
- ◆ To prevent possible explosions, replace expired batteries with the same model or a manufacturer-recommended substitute and follow the manufacturer's instructions for battery replacement.
- ◆ Never remove a power supply cover or any sealed part that has the following label:

**Hazardous voltage, current, and energy levels are present inside any component that has this label attached. There are no user-serviceable parts inside these components. If you suspect a problem with one of these parts, contact Citrix Technical Support.**

## Appliance Precautions

- ◆ Determine the placement of each component in the rack before you install the rail.
- ◆ Install the heaviest appliance first, at the bottom of the rack, and then work upward. Distribute the load on the rack evenly. An unbalanced rack is hazardous.
- ◆ Allow the power supply units and hard drives to cool before touching them.
- ◆ Install the equipment near an electrical outlet for easy access.
- ◆ Mount equipment in a rack with sufficient airflow for safe operation.
- ◆ For a closed or multiple-unit rack assembly, the ambient operating temperature of the rack environment might be greater than the ambient temperature of the room.

Therefore, consider the lowest and highest operating temperatures of the equipment when making a decision about where to install the appliance in the rack.

## Rack Precautions

- ♦ Make sure that the leveling jacks on the bottom of the rack are fully extended to the floor, with the full weight of the rack resting on them.
- ♦ For a single-rack installation, attach a stabilizer to the rack.
- ♦ For a multiple-rack installation, couple (attach) the racks together.
- ♦ Always make sure that the rack is stable before extending a component from the rack.
- ♦ Extend only one component at a time. Extending two or more simultaneously might cause the rack to become unstable.
- ♦ The handles on the left and right of the front panel of the appliance should be used only for extending the appliance out of the rack. Do not use these handles for mounting the appliance on the rack. Use the rack-rail hardware, described later, instead.

---

## Chapter 3

# Installing the Hardware

### Topics:

- [\*Rack Mounting the Appliance\*](#)
- [\*Installing and Removing 1G SFP Transceivers\*](#)
- [\*Installing and Removing XFP and 10G SFP+ Transceivers\*](#)
- [\*Connecting the Cables\*](#)
- [\*Switching on the Appliance\*](#)

After you have determined that the location where you will install your appliance meets the environmental standards and the server rack is in place according to the instructions, you are ready to install the hardware. After you mount the appliance, you are ready to connect it to the network, to a power source, and to the console terminal that you will use for initial configuration. To complete the installation, you turn on the appliance. Be sure to observe the cautions and warnings listed with the installation instructions.

## Rack Mounting the Appliance

Most appliances can be installed in standard server racks that conform to EIA-310-D specification. The appliances ship with a set of rails, which you must install before you mount the appliance. The only tools that you need for installing an appliance are a Phillips screwdriver and a flathead screwdriver.

**⚠ Caution:** If you are installing the appliance as the only unit in the rack, mount it at the bottom. If the rack contains other units, make sure that the heaviest unit is at the bottom. If the rack has stabilizing devices available, install them before mounting the appliance.

The following table lists the different hardware platforms and the rack units required for each platform.

**Table 3-1. Height Requirements For Each Platform**

Platform	Number of rack units
7000	One rack unit
9010 FIPS, 12000-10G	Two rack units
MPX 5500	One rack unit
MPX 5550/5650	One rack unit
MPX 7500/9500	One rack unit
MPX 8200/8400/8600/8800	One rack unit
MPX 9700/10500/12500/15500	Two rack units
MPX 15000, MPX 17000	Two rack units
MPX 11500/13500/14500/16500/18500/20500	Two rack units
MPX 17500/19500/21500	Two rack units
MPX 17550/19550/20550/21550	Two rack units
MPX 22040/22060/22080/22100/22120	Two rack units

Each appliance ships with a mounting rail kit that contains two rail assemblies, one for the left side and the other for the right side of the appliance, and screws to attach the rails. An assembly consists of an inner rail and a rack rail. The supplied rail kit is 28 inches long (38 inches extended). Contact your Citrix sales representative to order a 23-inch (33 inches extended) rail kit.

**Note:** The same rail kit is used for both square-hole and round-hole racks. See ["Installing the Rail Assembly to the Rack"](#) for specific instructions for threaded, round-hole racks.

To mount the appliance, you must first install the rails and then install the appliance in the rack.

Perform the following tasks to mount the appliance:

- ◆ Remove the inner rails from the rail assembly.
- ◆ Attach the inner rails to the appliance.
- ◆ Install the rack rails on the rack.
- ◆ Install the appliance in the rack.

The appliance is shipped with rack-rail hardware. This hardware consists of two inner rails that you attach to the appliance, one on each side, and a rack-rail assembly that you attach to the rack. The following figure illustrates the steps involved in mounting the Citrix NetScaler appliance to a rack.

## To remove the inner rails from the rail assembly

1. Place the rail assembly on a flat surface.
2. Slide out the inner rail toward the front of the assembly.
3. Depress the latch until the inner rail comes all the way out of the rail assembly.
4. Repeat steps 1 through 3 to remove the second inner rail.

## To attach the inner rails to the appliance

1. Position the right inner rail behind the handle on the right side of the appliance.
2. Align the holes on the rail with the corresponding holes on the side of the appliance.
3. Attach the rail to the appliance with the provided screws: 4 per side for a 1U appliance and 5 per side for a 2U appliance, as shown in the following figure.

**Figure 3-1. Attaching inner rails**



4. Repeat steps 1 through 3 to install the left inner rail on the other side of the appliance.

## To install the rack rails on the rack

1. If you have a round-hole, threaded rack, skip to step 3.
2. Install square nut retainers into the front post and back post of the rack as shown in the following figures. Before inserting a screw, be sure to align the square nut with the correct hole for your 1U or 2U appliance. The three holes are not evenly spaced.

**Figure 3-2. Installing Retainers into the Front Rack Posts**

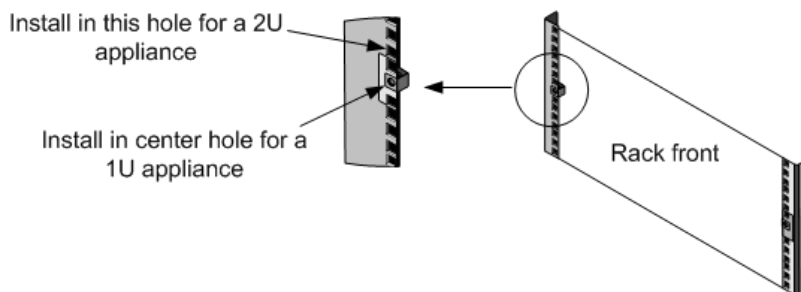

**Figure 3-3. Installing Retainers into the Rear Rack Posts**

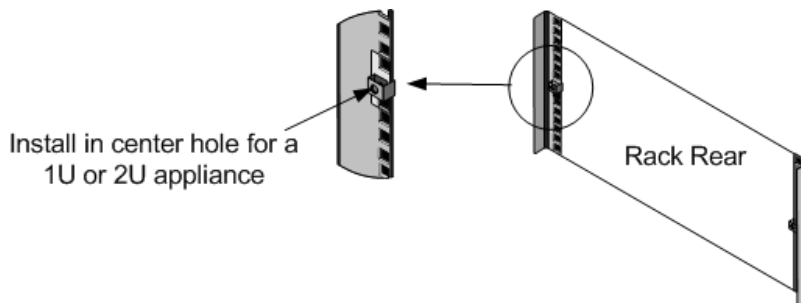

3. Install the adjustable rail assembly into the rack as shown in the following figures. Use a screw to lock the rear rail flange into the rack. With the screw securing the rail in place, you can optionally remove the latching spring.

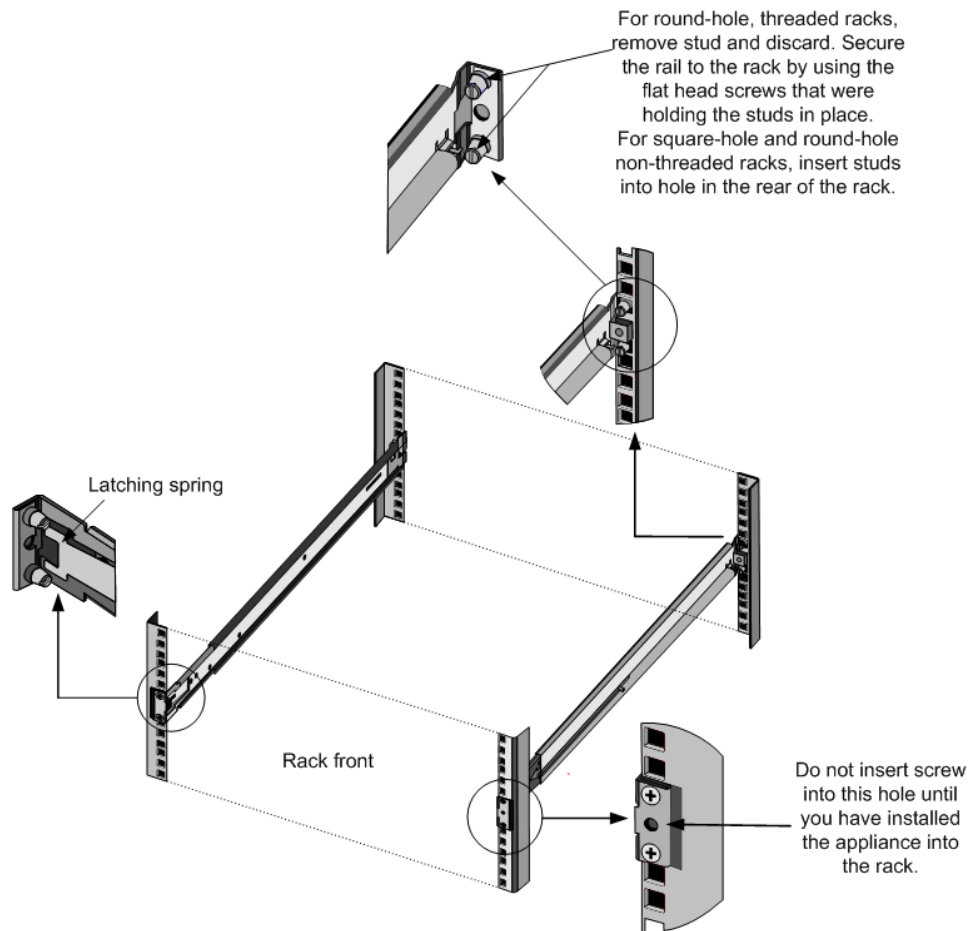
**Figure 3-4. Installing the Rail Assembly to the Rack**

## To install the appliance in the rack

1. Align the inner rails, attached to the appliance, with the rack rails.
2. Slide the appliance into the rack rails, keeping the pressure even on both sides.
3. Verify that the appliance is locked in place by pulling it all the way out from the rack.

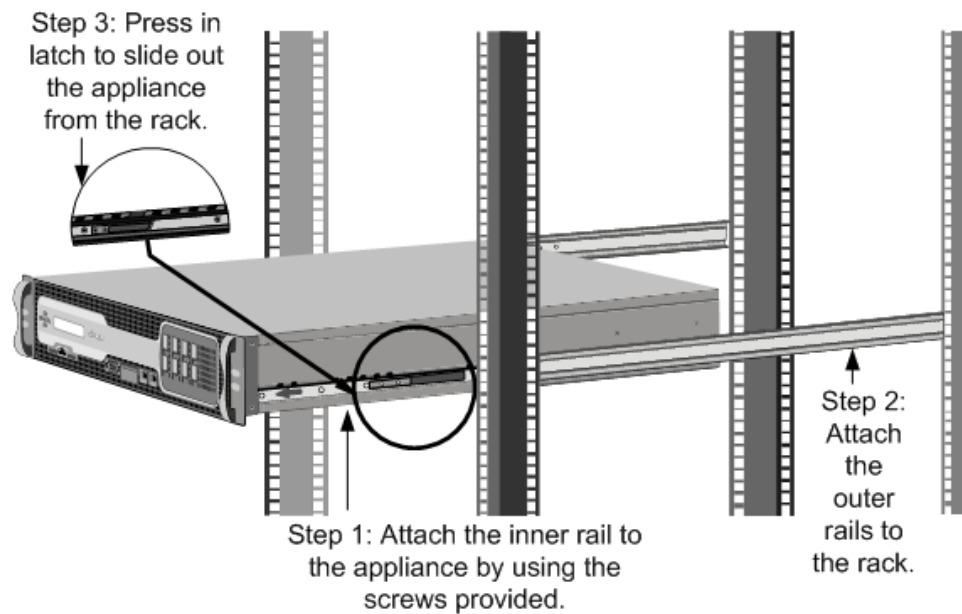
**Figure 3-5. Rack Mounting the Appliance**

## Installing and Removing 1G SFP Transceivers

**Note:** This section applies to the 9010 FIPS, 12000-10G, MPX 8200/8400/8600/8800, MPX 9700/10500/12500/15500, MPX 11500/13500/14500/16500/18500/20500, and MPX 22040/22060/22080/22100/22120 appliances.

A Small Form-Factor Pluggable (SFP) is a compact transceiver that can operate at speeds of up to 1 gigabit per second and is available in both copper and fiber types. Inserting a 1G SFP copper transceiver converts the 1G SFP port to a 1000BASE-T port. Inserting a 1G SFP fiber transceiver converts the 1G SFP port to a 1000BASE-X port. Auto-negotiation is enabled by default on the 1G SFP port into which you insert your 1G SFP transceiver. As soon as a link between the port and the network is established, the speed and mode are matched on both ends of the cable.

**Note:** The 1G SFP transceiver is hot-swappable from release 9.3 build 42.2 and later on the NetScaler appliances that use the e1k interface. The following platforms support 1G SFP transceivers:

- ◆ MPX 7500/9500
- ◆ MPX 8200/8400/8600/8800
- ◆ MPX 9700/10500/12500/15500
- ◆ MPX 11500/13500/14500/16500/18500/20500
- ◆ MPX 22040/22060/22080/22100/22120



**⚠ Caution:** NetScaler appliances do not support 1G SFP transceivers from vendors other than Citrix Systems. Attempting to install third-party 1G SFP transceivers on your NetScaler appliance voids the warranty.

Insert 1G SFP transceivers into the 1G SFP ports on the front panel of the appliance. Frequent installation and removal of transceivers shortens their life span. Follow the removal procedure carefully to avoid damaging the 1G SFP transceiver or the appliance.

**⚠ Caution:** Do not install the transceivers with the cables attached. Doing so can damage the cable, the connector, or the optical interface of the transceiver.

## To install a 1G SFP transceiver

1. Remove the 1G SFP transceiver carefully from its box.

**👉 Danger:** Do not look directly into fiber optic transceivers or cables. They emit laser beams that can damage your eyes.

2. Align the 1G SFP transceiver to the front of the 1G SFP transceiver port on the front panel of the appliance, as shown in the following figure.

**Note:** The illustration in the following figures might not represent your actual appliance.

**Figure 3-6. Installing a 1G SFP transceiver**

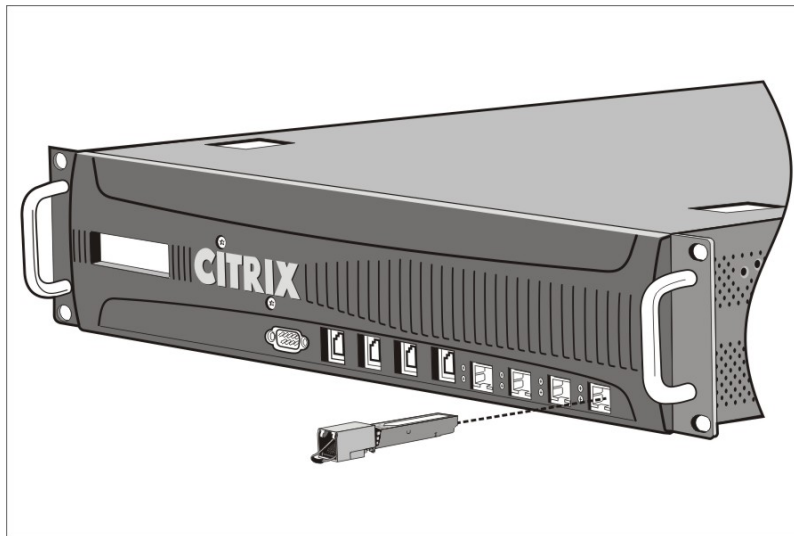

3. Hold the 1G SFP transceiver between your thumb and index finger and insert it into the 1G SFP transceiver port, pressing it in until you hear the transceiver snap into place.

4. Lock the transceiver.
5. Verify that the LED is green and blinks twice, which indicates that the transceiver is functioning correctly.
6. If you are using a fiber 1G SFP transceiver, do not remove the dust caps attached to the transceiver and the cable until you are ready to insert the cable.

## To remove a 1G SFP transceiver

1. Disconnect the cable from the 1G SFP transceiver. If you are using a fiber optic cable, replace the dust cap on the cable before putting it away.

 **Danger:** Do not look directly into fiber optic transceivers or cables. They emit laser beams that can damage your eyes.

2. Unlock the 1G SFP transceiver.
3. Hold the 1G SFP transceiver between your thumb and index finger and slowly pull it out of the port.
4. If you are removing a fiber 1G SFP transceiver, replace the dust cap before putting it away.
5. Put the 1G SFP transceiver into its original box or another appropriate container.

## Installing and Removing XFP and 10G SFP+ Transceivers

**Note:** This section applies to the 12000 10G, MPX 8200/8400/8600/8800, MPX 9700/10500/12500/15500, MPX 15000, MPX 17000, MPX 11500/13500/14500/16500/18500/20500, MPX 17500/19500/21500, MPX 17550/19550/20550/21550, and MPX 22040/22060/22080/22100/22120 appliances.

A 10-Gigabit Small Form-Factor Pluggable (XFP or SFP+) is a compact optical transceiver that can operate at speeds of up to 10 gigabits per second. The 12000 10G, MPX 15000, and MPX 17000 appliances use XFP transceivers and the MPX 8200/8400/8600/8800, MPX 9700/10500/12500/15500, MPX 11500/13500/14500/16500/18500/20500, MPX 17500/19500/21500, MPX 17550/19550/20550/21550, and MPX 22040/22060/22080/22100/22120 appliances use 10G SFP+ transceivers. Autonegotiation is enabled by default on the XFP/10G SFP+ ports into which you insert your XFP/10G SFP+ transceiver. As soon as a link between the port and the network is established, the mode is matched on both ends of the cable and for 10G SFP+ transceivers, the speed is also autonegotiated.

**Note:** An XFP transceiver is **not hot-swappable** on the NetScaler appliances. You must restart a NetScaler appliance after you insert an XFP transceiver.

However, the 10G SFP+ transceiver is hot-swappable from release 9.3 build 57.5 and later on the NetScaler appliances that use the ixgbe (ix) interface. The following platforms support 10G SFP+ transceivers:

- ◆ MPX 8200/8400/8600/8800
- ◆ MPX 9700/10500/12500/15500 10G and 10G FIPS
- ◆ MPX 11500/13500/14500/16500/18500/20500
- ◆ MPX 17500/19500/21500
- ◆ MPX 17550/19550/20550/21550
- ◆ MPX 22040/22060/22080/22100/22120

The following platforms support XFP transceivers:

- ◆ MPX 15000
- ◆ MPX 17000

 **Caution:** NetScaler appliances do not support XFP/10G SFP+ transceivers provided by vendors other than Citrix Systems. Attempting to install third-party XFP/10G SFP+ transceivers on your NetScaler appliance voids the warranty.

Insert the XFP/10G SFP+ transceivers into the XFP/10G SFP+ ports on the front panel of the appliance. Frequent installation and removal of transceivers shortens their life span. Follow the removal procedure carefully to avoid damaging the transceiver or the appliance.

 **Caution:** Do not install the transceivers with the cables attached. Doing so can damage the cable, the connector, or the optical interface of the transceiver.

## To install an XFP/10G SFP+ transceiver

1. Remove the XFP/10G SFP+ transceiver carefully from its box.

 **Danger:** Do not look directly into fiber optic transceivers and cables. They emit laser beams that can damage your eyes.

2. Align the XFP/10G SFP+ transceiver to the front of the XFP/10G SFP+ transceiver port on the front panel of the appliance.
3. Hold the XFP/10G SFP+ transceiver between your thumb and index finger and insert it into the XFP/10G SFP+ transceiver port, pressing it in until you hear the transceiver snap into place.
4. Move the locking hinge to the DOWN position as shown in the following figure.

**Figure 3-7. Locking an XFP transceiver**

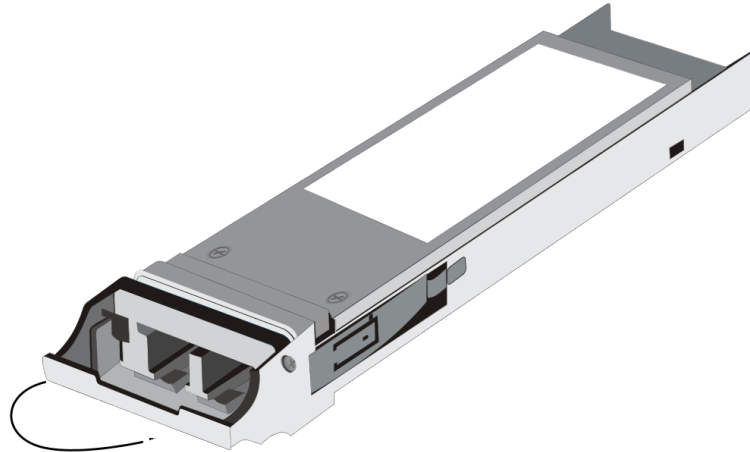

5. Verify that the LED is green and blinks twice, which indicates that the transceiver is functioning correctly.
6. Do not remove the dust caps attached to the transceiver and cable until you are ready to insert the cable.

## To remove an XFP/10G SFP+ transceiver

1. Disconnect the cable from the XFP/10G SFP+ transceiver. Replace the dust cap on the cable before putting it away.

 **Danger:** Do not look directly into fiber optic transceivers or cables. They emit laser beams that can damage your eyes.

2. Unlock the XFP/10G SFP+ transceiver by moving the locking hinge to the UP position.
3. Hold the XFP/10G SFP+ transceiver between your thumb and index finger and slowly pull it out of the port.
4. Replace the dust cap on the transceiver before putting it away.
5. Put the XFP/10G SFP+ transceiver into its original box or another appropriate container.

## Connecting the Cables

When the appliance is securely mounted on the rack, you are ready to connect the cables. Ethernet cables and the optional console cable are connected first. Connect the power cable last.

**⚠ Danger:** Before installing or repairing the appliance, remove all jewelry and other metal objects that might come in contact with power sources or wires. When you touch both a live power source or wire and ground, any metal objects can heat up rapidly and cause burns, set clothing on fire, or fuse the metal object to an exposed terminal.

## Connecting the Ethernet Cables

Ethernet cables connect your appliance to the network. The type of cable you need depends on the type of port used to connect to the network. Use a category 5e or category 6 Ethernet cable with a standard RJ-45 connector on a 10/100/1000BASE-T port or 1G SFP copper transceiver. Use a fiber optic cable with an LC duplex connector with a 1G SFP fiber transceiver, 10G SFP+, or XFP transceiver. The type of connector at the other end of the fiber optic cable depends on the port of the device that you are connecting to.

### To connect an Ethernet cable to a 10/100/1000BASE-T port or 1G SFP copper transceiver

1. Insert the RJ-45 connector on one end of your Ethernet cable into an appropriate port on the front panel of the appliance, as shown in the following figure.

**Figure 3-8.** Inserting an Ethernet cable

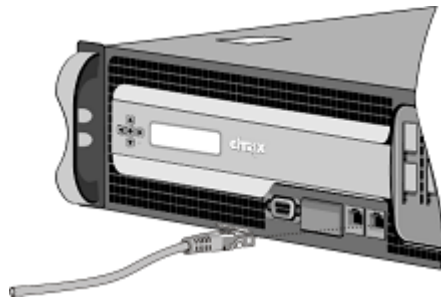

2. Insert the RJ-45 connector on the other end into the target device, such as a router or switch.
3. Verify that the LED glows amber when the connection is established.

### To connect the Ethernet cable to a 1G SFP fiber, 10G SFP+, or XFP transceiver

1. Remove the dust caps from the transceiver and cable.
2. Insert the LC connector on one end of the fiber optic cable into the appropriate port on the front panel of the appliance.
3. Insert the connector on the other end into the target device, such as a router or switch.
4. Verify that the LED glows amber when the connection is established.

## Connecting the Console Cable

You can use the console cable to connect your appliance to a computer or terminal, from which you can configure the appliance. Alternatively, you can use a computer connected to the network. Before connecting the console cable, configure the computer or terminal to support VT100 terminal emulation, 9600 baud, 8 data bits, 1 stop bit, parity, and flow control set to NONE. Then connect one end of the console cable to the RS232 serial port on the appliance and the other end to the computer or terminal.

### To connect the console cable to a computer or terminal

1. Insert the DB-9 connector at the end of the cable into the console port that is located on the front panel of the appliance, as shown in the following figure.

**Figure 3-9.** Inserting a console cable

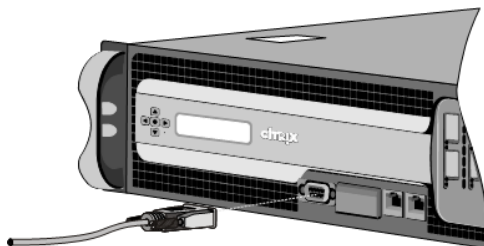

**Note:** To use a cable with an RJ-45 converter, insert the optional converter provided into the console port and attach the cable to it.

2. Insert the RJ-45 connector at the other end of the cable into the serial port of the computer or terminal.

## Connecting the Power Cable

An MPX 5500, MPX 5550/5650, MPX 7500/9500, MPX 8200/8400/8600/8800, and 7000 appliance has one power cable. All the other appliances come with two power cables, but they can also operate if only one power cable is connected, except the MPX 22040/22060/22080/22100/22120 which comes with four power cables and requires

two power cables for proper operation. A separate ground cable is not required, because the three-prong plug provides grounding.

## To connect the appliance to the power source

1. Connect one end of the power cable to the power outlet on the back panel of the appliance, next to the power supply, as shown in the following figure.

**Figure 3-10. Inserting a power cable**

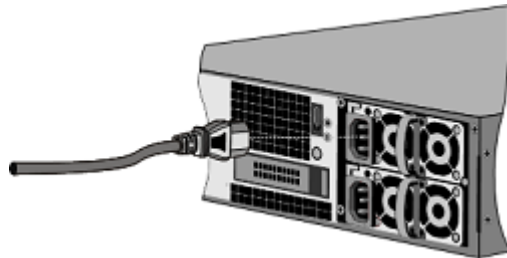

2. Connect the other end of the power cable to a standard 110V/220V power outlet.
3. If a second power supply is provided, repeat steps 1 and 2 to connect the second power supply.

**Note:** The 9010 FIPS, 12000-10G, MPX 9700/10500/12500/15500, MPX 11500/13500/14500/16500/18500/20500, MPX 17500/19500/21500, and MPX 17550/19550/20550/21550 appliances emit a high-pitched alert if one power supply fails or if you connect only one power cable to the appliance. To silence the alarm, you can press the small red button located on the back panel of the appliance.

## Switching on the Appliance

After you have installed the appliance in a rack and connected the cables, verify that the power cable is properly connected. If you have installed a second power supply, make sure the second cable is connected to an outlet for a different circuit than the first. After verifying the connections, you are ready to switch on the appliance.

### To switch on the appliance

1. Verify that the appliance is connected through a console or Ethernet port.  
This will ensure that you can configure the appliance after it is switched on.
2. Press the ON/OFF toggle power switch on the back panel of the appliance.

**Figure 3-11. Power switch on back panel**

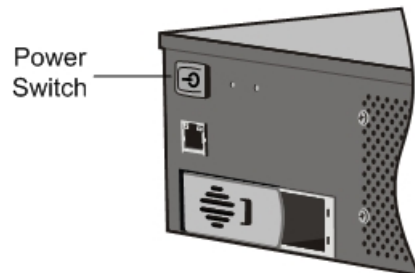

3. Verify that the LCD on the front panel is backlit and the start message appears, as shown in the following figure.

**Figure 3-12. LCD startup screen**

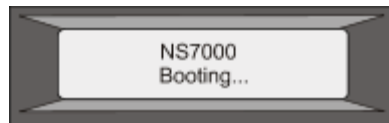

**⚠ Caution:** Be aware of the location of the emergency power off (EPO) switch, so that if an electrical accident occurs you can quickly remove power from the appliance.



---

## Chapter 4

# Initial Configuration

### Topics:

- [\*Using the LCD Keypad\*](#)
- [\*Using the NetScaler Serial Console\*](#)
- [\*Using the Setup Wizard\*](#)
- [\*Using DHCP for Initial Access\*](#)
- [\*Accessing a NetScaler by Using SSH Keys and No Password\*](#)
- [\*Changing the Administrative Password\*](#)

After you have installed your appliance in a rack, you are ready to perform the initial configuration. Once initial configuration is complete, refer to the specific configuration guides for the features you will be using.

Initial configuration is the same for the multifunction Citrix NetScaler, the dedicated Access Gateway Enterprise Edition, and the dedicated Citrix® Application Firewall™ appliances. To perform the initial configuration on the MPX 5500, MPX 5550/5650, MPX 7500/9500, MPX 8200/8400/8600/8800, MPX 9700/10500/12500/15500, MPX 11500/13500/14500/16500/18500/20500, MPX 17500/19500/21500, MPX 17550/19550/20550/21550, and MPX 22040/22060/22080/22100/22120 appliances, you can also use the LCD keypad on the front panel of the appliance. To perform the initial configuration, you can use the serial console or the setup wizard. You can access the setup wizard from any computer that is on the same network as the new NetScaler appliance. However, because this method uses the NetScaler default IP address, you must install and configure one NetScaler appliance at a time. If you want to configure a new appliance from a remote network, or if you want to install multiple NetScaler appliances and then configure them without using the console port, you can use Dynamic Host Configuration Protocol (DHCP) to assign each new appliance an IP address at which you can access the appliance for remote configuration.

For initial configuration, use nsroot as both the administrative user name and the password. For subsequent access, use the password assigned during initial configuration.

After you complete the initial configuration of the appliance, you can configure secure access to your appliance. As a result, you are no longer prompted for a password when logging on. This is especially helpful in environments for which you would otherwise have to keep track of a large number of passwords.

## Using the LCD Keypad

**Note:** The following section is applicable to MPX 5500, MPX 5550/5650, MPX 7500/9500, MPX 8200/8400/8600/8800, MPX 9700/10500/12500/15500, MPX 11500/13500/14500/16500/18500/20500, MPX 17500/19500/21500, MPX 17550/19550/20550/21550, and MPX 22040/22060/22080/22100/22120 appliances only.

When you first install the appliance, you can configure the initial settings by using the LCD keypad on the front panel of the appliance. The keypad interacts with the LCD display module, which is also on the front panel of these appliances.

**Note:** You can use the LCD keypad for initial configuration on a new appliance with the default configuration. The configuration file (ns.conf) should contain the following command and default values.

```
set ns config -IPAddress 192.168.100.1 -netmask 255.255.0.0
```

The functions of the different keys are explained in the following table.

**Table 4-1. LCD Key Functions**

Key	Function
<	Moves the cursor one digit to the left.
>	Moves the cursor one digit to the right.
^	Increments the digit under the cursor.
v	Decrements the digit under the cursor.
.	Processes the information, or terminates the configuration, if none of the values are changed. This key is also known as the ENTER key.

To perform the initial configuration by using the LCD keypad press the "<" key.

You are prompted to enter the subnet mask, NetScaler IP address (NSIP), and gateway in that order respectively. The subnet mask is associated with both the NSIP and default gateway IP address. The NSIP is the IPv4 address of the NetScaler appliance. The default gateway is the IPv4 address for the router, which will handle external IP traffic that the NetScaler cannot otherwise route. The NSIP and the default gateway should be on the same subnet.

If you enter a valid value for the subnet mask, such as 255.255.255.224, you are prompted to enter the IP address. Similarly, if you enter a valid value for the IP address, you are prompted to enter the gateway address. If the value you entered is

invalid, the following error message appears for three seconds, where xxx.xxx.xxx.xxx is the IP address you entered, followed by a request to re-enter the value.

```
Invalid addr!  
xxx.xxx.xxx.xxx
```

If you press the ENTER (.) key without changing any of the digits, the software interprets this as a user exit request. The following message will be displayed for three seconds.

```
Exiting menu...  
xxx.xxx.xxx.xxx
```

If all the values entered are valid, when you press the ENTER key, the following message appears.

```
Values accepted,  
Rebooting...
```

The subnet mask, NSIP, and gateway values are saved in the configuration file.

**Note:** For information about deploying a high availability (HA) pair, see "[Configuring High Availability](#)."

## Using the NetScaler Serial Console

When you first install the appliance, you can configure the initial settings by using the serial console. With the serial console, you can change the system IP address, create a subnet or mapped IP address, configure advanced network settings, and change the time zone.

**Note:** To locate the serial console port on your appliance, see "RS232 Serial Console Port" in "[Ports](#)."

## To configure initial settings by using a serial console

1. Connect the console cable into your appliance. For more information, see "Connecting the Console Cable" in "[Connecting the Cables](#)."
2. Run the vt100 terminal emulation program of your choice on your computer to connect to the appliance and configure the following settings:  
9600 baud, 8 data bits, 1 stop bit, parity, and flow control set to NONE.
3. Press ENTER.  
The terminal screen displays the Logon prompt.

**Note:** You might have to press ENTER two or three times, depending on which terminal program you are using.

4. Log on to the appliance with the administrator credentials.  
Your sales representative or Citrix Customer Service can provide you with the administrator credentials.
5. At the prompt, type **config ns** to run the NetScaler configuration script.
6. To complete the initial configuration of your appliance, follow the prompts.

**Note:** To prevent an attacker from breaching your ability to send packets to the appliance, choose a non-routable IP address on your organization's LAN as your appliance IP address.

You can replace steps 5 and 6 with the following NetScaler commands. At the NetScaler command prompt, type:

```
set ns config -ipaddress<IPAddress> -netmask<subnetMask>
```

```
add ns ip <IPAddress> <subnetMask> -type<type>
```

```
add route<network> <netmask> <gateway>
```

```
set system user <userName> -password
```

```
save ns config
```

```
reboot
```

#### Example

```
set ns config -ipaddress 10.102.29.60 -netmask  
255.255.255.0  
add ns ip 10.102.29.61 255.255.255.0 -type snip  
add route 0.0.0.0 0.0.0.0 10.102.29.1  
set system user nsroot -password  
Enter password: *****  
Confirm password: *****  
save ns config  
reboot
```

You have now completed initial configuration of your appliance.

To continue configuring the appliance, choose one of the following options:

#### Citrix NetScaler.

If you are configuring your appliance as a standard NetScaler with other licensed features, see "[Load Balancing](#)."

#### Citrix® Application Firewall™.

If you are configuring your appliance as a standalone application firewall, see "[Application Firewall](#)."

### Access Gateway.

If you are configuring your appliance as an Access Gateway, see "[Access Gateway 9.3, Enterprise Edition](#)."

**Note:** For information about deploying a high availability (HA) pair, see "[Configuring High Availability](#)."

## Using the Setup Wizard

To configure the appliance by using the Setup Wizard in the configuration utility, you need an administrative computer configured on the same network as the appliance. To run the configuration utility, the Java RunTime Environment (JRE) version 1.4.2\_04 or later must be installed on the workstation or laptop. You can use the Setup Wizard to configure the following initial settings on the appliance:

- ◆ System IP address and subnet mask
- ◆ Subnet or Mapped IP address and subnet mask
- ◆ Host name
- ◆ Default gateway
- ◆ Time zone
- ◆ Licenses
- ◆ Administrator password

**Important:** Before running the Setup Wizard, you should download your licenses from the Citrix Web site and put them in a location on your computer or another device where you can access them from your Web browser during configuration.

**Note:** If the appliance is configured with the default IP address, licenses are not installed on the appliance, or the mapped or subnet IP address is not configured, the configuration utility automatically opens the Setup Wizard when you log on to the appliance.

## To configure initial settings by using the Setup Wizard

1. In a Web browser, type: `http://192.168.100.1`

**Note:** The NetScaler software is preconfigured with a default IP address and associated netmask. The default IP address is 192.168.100.1 and the default netmask is 255.255.0.0.

2. In **User Name** and **Password**, type the administrator credentials.  
You can obtain the initial user name and password from your sales representative or from Citrix Customer Service.
3. In **Start in**, select **Configuration**, and then click **Login**.
4. In the **Setup Wizard**, click **Next**, and then follow the instructions in the wizard.

**Note:** To prevent an attacker from breaching your ability to send packets to the appliance, choose a non-routable IP address on your organization's LAN as your appliance IP address.

You have now completed initial configuration of your appliance. To continue configuring the appliance, choose one of the following options:

#### Citrix NetScaler.

If you are configuring your appliance as a standard NetScaler with other licensed features, see "[Load Balancing](#)."

#### Citrix® Application Firewall™.

If you are configuring your appliance as a standalone application firewall, see "[Application Firewall](#)."

#### Access Gateway.

If you are configuring your appliance as an Access Gateway, see "[Access Gateway 9.3, Enterprise Edition](#)."

**Note:** For information about deploying a high availability (HA) pair, see "[Configuring High Availability](#)."

## Using DHCP for Initial Access

**Note:** The terms NetScaler, NetScaler appliance, and appliance are used interchangeably.

For initial configuration of a NetScaler appliance, Dynamic Host Configuration Protocol (DHCP) can eliminate dependency on the console by providing a subnet IP (SNIP) address at which you can access the appliance to configure it remotely. You can also use DHCP after initial configuration if, for example, you want to move a NetScaler to a different subnet.

To use DHCP, you must first specify the NetScaler vendor class identifier on a DHCP server. Optionally, you can also specify the pool of IP addresses from which your NetScaler appliance can acquire an IP address. If a pool is not specified, the address is acquired from the general pool.

A new NetScaler appliance does not have a configuration file. When you connect an appliance without a configuration file to the network, its DHCP client automatically polls the DHCP server for an IP address. If you have specified the NetScaler vendor class identifier on the DHCP server, the server returns an address. You can also enable the DHCP client on a previously configured appliance.

## Prerequisites

To use DHCP, you must:

1. Note the system ID (sysid) on the serial number sticker on the back panel of the appliance. On an older appliance, the system ID may not be available. In this case, use the MAC address instead of the system ID.
2. Set up a DHCP server and configure it with the NetScaler vendor class identifier.

## To configure a Linux/UNIX DHCP server for the NetScaler appliance

1. Specify "citrix-NS" as the vendor class identifier for the NetScaler appliance by adding the following configuration to the server's `dhcpd.conf` file. The subclass declaration must be inside the subnet declaration.

```
option space auto;
option auto.key code 1 = text;

class "citrix-1" {
    match option vendor-class-identifier;
}

subclass "citrix-1" "citrix-NS"{
    vendor-option-space auto;
    option auto.key "citrix-NS";
}
```

**Note:** The location of the `dhcpd.conf` file can be different in different versions and flavors of the Linux/UNIX-based operating system (for example, in FreeBSD 6.3 the file is present in the `/etc/` folder). For the location, see the `dhcpd` man page of the DHCP server.

2. If you do not want NetScaler appliances to use IP addresses from the general pool, specify a pool of addresses for the appliance. You must include this pool declaration inside the subnet declaration. For example, adding the following configuration to the `dhcpd.conf` file specifies a pool of IP addresses ranging from 192.168.2.120 to 192.168.2.127.

```
pool {
    allow members of "citrix-1";
    range 192.168.2.120 192.168.2.127;
    option subnet-mask 255.255.255.0;
}
```

3. Terminate the DHCP process and restart it to reflect the change to the configuration file. At the shell prompt, type:

```
killall dhcpd
```

```
dhcpd&
```

### Sample DHCP configuration (dhcpd.conf)

```
option space auto;
option auto.key code 1 = text;

class "citrix-1" {
    match option vendor-class-identifier;
}

subnet 192.168.2.0 netmask 255.255.255.0 {
    option routers10.217.242.1;
    option domain-name"jeffbr.local";
    option domain-name-servers8.8.8.8;
    default-lease-time 21600;
    max-lease-time 43200;
    subclass "citrix-1" "citrix-NS" {
        vendor-option-space auto;
        option auto.key "citrix-NS";
    }
    pool {
        allow members of "citrix-1";
        range 192.168.2.120 192.168.2.127;
        option subnet-mask 255.255.255.0;
    }
}
```

## Implementing an Initial NetScaler Configuration from a Remote Computer

When a new NetScaler appliance (or any appliance that does not have a configuration file) starts, it automatically polls the DHCP server for an IP address and provides the DHCP server with its sysid. The DHCP server selects one IP address from its pool and assigns it as a subnet IP (SNIP) address to the appliance. The DHCP server includes the sysid of the appliance and the IP address that it assigns to the appliance in the server's dhcpd.leases file. To find the IP address currently assigned to your appliance, look in the dhcpd.leases file for the last entry with the sysid of your appliance in the uid or client-hostname field. Verify that the binding state in this entry is active. If the binding state is not active but free, the IP address is not yet associated with the appliance.

You can use this address to connect to the appliance and remotely configure the initial settings. For example, you can change the IP address, subnet mask, and gateway settings that were fetched from the DHCP server. After completing the initial configuration, you can manually return the DHCP IP address to the server pool.



Alternatively, restarting the appliance automatically releases the DHCP IP address back to the server pool.

You can find out the SNIP address assigned to the appliance from the NetScaler console or from the DHCP server.

## To find the SNIP address from the NetScaler console

At the console prompt, type:

```
> sh dhcpParams
DHCP Client on next reboot is ON
DHCP Client Current State: Active
DHCP Client Default route save: OFF
DHCP acquired IP:192.168.2.127
DHCP acquired Netmask:255.255.255.0
DHCP acquired Gateway:192.168.2.1
Done
```

## To find the SNIP address from the DHCP server

Look in the dhcpd.leases file for the last entry with the sysid of your appliance in the uid or client-hostname field.

**Example:** The following entry in a DHCP server's dhcpd.leases file verifies the binding state of the appliance whose sysid is 45eae1a8157e89b9314f.

```
lease 192.168.2.127 {
  starts 3 2013/08/19 00:40:37;
  ends 3 2013/08/19 06:40:37;
  cltt 3 2013/08/19 00:40:37;
  binding state active;
  next binding state free;
  hardware ethernet 00:d0:68:11:f4:d6;
  uid "45eae1a8157e89b9314f";
  client-hostname "45eae1a8157e89b9314f";
```

In the above example, the binding state is ACTIVE and the IP address assigned to the appliance is 192.168.2.127.

The following table describes DHCP-related CLI commands that you might want to use when configuring a new NetScaler appliance.

**Table 4-2. NetScaler CLI commands for using DHCP with a new NetScaler Appliance**

Task	At the NetScaler command prompt, type:
To verify the DHCP fetched details, such as IP address, subnet mask, and gateway on the appliance	> sh dhcpParams

Task	At the NetScaler command prompt, type:
To release the DHCP IP address and return it to the IP address pool on the DHCP server when the NetScaler configuration is complete	> <b>release dhcpIP</b>

## Using DHCP When a Configuration File is Present

If you need to move a NetScaler appliance to a different subnet, such as from a testing environment to a production environment, you can use DHCP to access an appliance that already has a configuration file. Before moving the appliance, enable its DHCP client and save the configuration. As a result, when the appliance restarts, it automatically polls the DHCP server for an IP address. If you did not enable the DHCP client and save the configuration before shutting down the appliance, you will need to connect to the appliance through the console and dynamically run the DHCP client on the appliance. The DHCP server will then provide an IP address, a gateway, and a subnet mask. You can use the IP address to access the appliance and configure the other settings remotely.

If the DHCP client is enabled in the configuration file, you should disable it and then save the configuration file. If the DHCP client is enabled, the appliance will poll the DHCP server again for an IP address when it restarts.

The following table lists the NetScaler CLI commands associated with each task.

**Table 4-3. NetScaler CLI commands for using DHCP with a previously configured NetScaler Appliance**

Task	At the NetScaler command prompt, type:
To dynamically run the DHCP client to fetch an IP address from the DHCP server	> <b>set dhcpParams dhcpClient on</b>
To configure the DHCP client to run when the appliance restarts	> <b>set dhcpParams dhcpClient on</b> > <b>save config</b>
To prevent the DHCP client from running when the appliance restarts	> <b>set dhcpParams dhcpClient off</b> > <b>save config</b>  <b>Note:</b> This is required only if the ON setting was saved.

Task	At the NetScaler command prompt, type:
To save the DHCP acquired route so that it is available when the appliance restarts	<pre>&gt; set dhcpParams -dhcpclient on - saveroute on &gt; save config</pre>
To prevent saving the DHCP acquired route (default behavior)	<pre>&gt; set dhcpParams -dhcpclient on - saveroute off &gt; save config</pre> <p><b>Note:</b> This is required only if the ON setting was saved.</p>

## Accessing a NetScaler by Using SSH Keys and No Password

If you administer a large number of NetScaler appliances, storing and looking up passwords for logging on to individual appliances can be cumbersome. To avoid being prompted for passwords, you can set up secure shell access with public key encryption on each appliance.

NetScaler features can also use SSH key based authentication for internal communication when the nsinternal user is disabled (by using the `set ns config -internaluserlogin disabled` command). In such cases, the key name must be set as "ns\_comm\_key".

To set up access using SSH keys, you must generate the public-private key pair on a client and copy the public key to the remote NetScaler appliance.

### To generate the keys and connect to a remote NetScaler by using SSH keys

1. On a client (Linux client or a NetScaler) change directory to `/root/.ssh`.

```
cd /root/.ssh
```

2. Generate the public-private key pair.

```
ssh-keygen -t <key_type> -f <optional_key_file_name>
```

**Example:** To create an RSA key with default file name.

```
ssh-keygen -t rsa
```

3. Press ENTER when prompted for a file name for the key pair.
4. Press ENTER two times when prompted for a passphrase.

**Note:** If the client is a NetScaler appliance, move the private key file to a persistent location such as sub-directories of the /flash and /var directories.

5. Log on to the remote NetScaler appliance from the client by using a file transfer protocol, and perform the following:
  - a. Change directory to /nsconfig/ssh. At the prompt, type:

```
cd /nsconfig/ssh
```

- b. Use the binary transfer mode to copy the public key to this directory.

```
bin  
put id_rsa.pub
```

6. Open a connection to the remote NetScaler appliance by using an SSH client, such as PuTTY, and perform the following:

- a. Log on to the remote appliance using the administrator credentials.
  - b. Go to the NetScaler shell.

```
> shell
```

- c. At the shell prompt, change the directory to /nsconfig/ssh.

```
root@ns# cd /nsconfig/ssh
```

- d. Append the public key to the authorized\_keys file. At the shell prompt, type:

```
root@ns# cat id_rsa.pub >> authorized_keys
```

**Note:** If the authorized\_keys file does not exist at the appliance, you need to first create the file and then append the contents.

- e. Change the permission of the /flash, nsconfig, and ssh directories to 755.

```
root@ns# chmod 755 /flash  
root@ns# chmod 755 /flash/nsconfig  
root@ns# chmod 755 /flash/nsconfig/ssh
```

- f. Change the permission of the authorized\_keys file to 744.

```
root@ns# chmod 744 authorized_keys
```

- g. Optionally, remove the public key.

```
root@ns# rm id_rsa.pub
```

7. On the client, verify that you can connect to the remote NetScaler appliance by using SSH, without entering the password.

If using the default file name for the public-private key pair.

```
ssh <user_name>@<NetScalerIPAddress>
```

If using "ns\_comm\_key" (when nsinternal user is disabled) for the public-private key pair.

```
ssh -i /nsconfig/ssh/ns_comm_key  
<user_name>@<NetScalerIPAddress>
```

If using any other name for the public-private key pair.

```
ssh -i <path_to_client_private_key>  
<user_name>@<NetScalerIPAddress>
```

## Changing the Administrative Password

The default user account is the administrative account, which provides complete access to all features of the Citrix NetScaler appliance. Therefore, to preserve security, the administrative account should be used only when necessary, and only individuals whose duties require full access should know the password for the administrative account. The default administrative username and password are nsroot and nsroot, respectively. Citrix recommends changing the administrative password frequently.

### To change the administrative password by using the configuration utility

1. Log on to the appliance by using the administrative credentials.
2. On the **Configuration** tab, in the navigation pane, expand **System**, and then click **Users**.
3. In the **Users** pane, click the default user account (nsroot), and then click **Change Password**.
4. In the **Change Password** dialog box, in **Password** and **Confirm Password**, type the password of your choice.
5. Click **OK**.

## To change the administrative password by using the command line interface

At the command prompt, type:

```
set system user <userName> -password
```

**Example:**

```
set system user nsroot -password
Enter password: *****
Confirm password: *****
Done
```

---

## Chapter 5

# Lights Out Management Port of the NetScaler Appliance

### Topics:

- [Accessing the LOM Port by using a Web Browser](#)
- [Configuring the LOM Port](#)
- [Power Cycling the Appliance](#)
- [Performing a Core Dump](#)
- [Accessing the Appliance by using the Access Console](#)
- [Obtaining Properties of the Host](#)
- [Obtaining Health Monitoring Information](#)
- [Obtaining the MAC Address and the Serial Number of the Appliance](#)
- [Power Control Operations using the LOM Port](#)

The MPX 8200/8400/8600/8800, MPX 11500/13500/14500/16500/18500/20500, MPX 17550/19550/20550/21550, and MPX 22040/22060/22080/22100/22120 appliances have an Intelligent Platform Management Interface (IPMI), also known as the Lights out Management (LOM), port on the front panel of the appliance. By using the LOM, you can remotely monitor and manage the appliance, independently of the NetScaler software. You can remotely change the IP address, perform different power operations, and obtain information of the appliance, such as health monitoring information, MAC address, serial number, and properties of the host, by connecting to the appliance through the LOM port.

By connecting the LOM port over a dedicated channel that is separate from the data channel, you can make sure that connectivity to the appliance is maintained even if the data network is down.

## Accessing the LOM Port by using a Web Browser

By using a web browser you can remotely log on to the LOM port to obtain information about the appliance and perform different operations on the appliance.

**To access the LOM by using a web browser**

1. In a web browser, type the IP address of the LOM port. For initial configuration, type the port's default address: `http://192.168.1.3`
2. In the **User Name** box, type `nsroot`.
3. In the **Password** box, type `nsroot`.

## Configuring the LOM Port

For initial configuration of the lights-out management (LOM) port, connect to the port's default IP address and change it to the address that you want to use for remote monitoring and management. Also specify the administrator credentials and the network settings.

**Note:** The LEDs on the LOM port are unoperational by design on all MPX platforms, except MPX 22040/22060/22080/22100/22120.

## To Configure the NetScaler LOM Port

1. Connect the NetScaler LOM port to a management workstation or network.
2. In a web browser, type: <http://192.168.1.3>.

**Note:** The NetScaler LOM port is preconfigured with the IP address 192.168.1.3 and subnet mask 255.255.255.0.

3. In the **User Name** box, type `nsroot`.
4. In the **Password** box, type `nsroot`.
5. In the **Configuration** tab, click **Network** and type values for the following parameters:
  - **IP Address**—IP address of the LOM port.
  - **Subnet Mask**—Subnet mask used to define the subnet of the LOM port.
  - **Default Gateway**—IP address of the router that connects the LOM port to the network.
6. Click **Save**.



## Power Cycling the Appliance

You can remotely turn off the appliance and turn it back on. The result is similar to pressing the power button on the back panel of the appliance for less than four seconds. The appliance's software performs a graceful shutdown. All operations on the appliance are stopped, no new connections to the client or server are accepted, and all existing connections are closed.

### To power cycle the appliance

1. In a web browser, type the IP address of the LOM port.
2. In the **User Name** and **Password** boxes, type the administrator credentials.
3. In the **Menu** bar, click **Remote Control**.
4. Under **Options**, click **Power Control**, and then click **Power Cycle System**.
5. Click **Perform Action**.

## Performing a Core Dump

If the appliance fails or becomes unresponsive, you can remotely perform a core dump. This procedure has the same effect as pressing the NMI button on the back panel of the appliance.

### To perform a core dump

1. In a web browser, type the IP address of the LOM port.
2. In the **User Name** and **Password** boxes, type the administrator credentials.
3. In the **Menu** bar, click **Remote Control**.
4. Under **Options**, click **NMI**, and then click **Initiate NMI**.

## Accessing the Appliance by using the Access Console

The LOM port allows you to remotely access and manage the appliance by logging on to a redirected console.

### To access the appliance by using the access console

1. In a web browser, type the IP address of the LOM port.
2. In the **User Name** and **Password** boxes, type the administrator credentials.

3. In the **Menu** bar, click **Remote Control**.
4. Under **Options**, click **Console Redirection**.
5. Click **Launch Console**, and then click **Yes**.
6. Type the administrator credentials for the appliance.

## Obtaining Properties of the Host

After you log on to the appliance by using the access console, you can remotely manage the appliance. At the console prompt, type **sh nsip**.

## Obtaining Health Monitoring Information

You can log on to the LOM port to view the health information about the appliance. All system sensor information, such as system temperature, CPU temperature, status of fan and power supplies, appears on the sensor readings page.

**To obtain health monitoring information**

1. In a web browser, type the IP address of the LOM port.
2. In the **User Name** and **Password** boxes, type the administrator credentials.
3. In the **Menu** bar, click **System Health**.
4. Under **Options**, click **Sensor Readings**.

## Obtaining the MAC Address and the Serial Number of the Appliance

A Media Access Control address (MAC address) is a unique identifier assigned to network interfaces for communications on the physical network segment.

**To obtain the MAC address and the serial number of the appliance**

1. In a web browser, type the IP address of the LOM port.
2. In the **User Name** and **Password** boxes, type the administrator credentials.
3. In the **Menu** bar, click **Remote Control**.
4. Under **Options**, click **Console Redirection**.
5. Click **Launch Console**, and then click **Yes**.
6. Type the administrator credentials for the appliance to log on.
7. Type **show interface <management\_interface\_id>** to obtain the MAC address.
8. Type **show hardware** to obtain the serial number of the appliance.

## Power Control Operations using the LOM Port

You can remotely perform different power control operations, such as restarting the appliance, performing a graceful shutdown, and performing a forced shutdown, by using the LOM port.

### To perform power control operations

1. In a web browser, log on to the LOM port by using the administrator credentials.
2. In the **Menu** bar, click **Remote Control**.
3. Under **Options**, click **Power Control**, and then select one of the following options:
  - **Reset System**—Restart the appliance.
  - **Power Off System - Immediate**—Disconnect power to the appliance without shutting down the appliance.
  - **Power Off System - Orderly Shutdown**—Shut down the appliance, and then disconnect power to the appliance.
  - **Power On System**—Turn on the appliance.
  - **Power Cycle System**—Turn off the appliance, and then turn it back on.
4. Click **Perform Action**.



---

## Chapter 6

# Migrating the Configuration of an Existing NetScaler Appliance to Another Appliance

### Topics:

- [To migrate a configuration](#)

If you are migrating to a new appliance, you must make some changes to the configuration (ns.conf file) of the old appliance before you copy the configuration to the new appliance.

**Note:** The following procedure does not apply to NetScaler FIPS appliances.

## To migrate a configuration

1. On the old appliance, create a backup copy of the configuration file (ns.conf).
2. Use a vi editor to edit the configuration file that you backed up. For example, you might want to change the user name, host name, and password.

**Note:** You must remove all interface-related configuration, such as set interface, bind vlan, add channel, bind channel, and set channel.

3. Shut down the old appliance.
4. Perform initial configuration on the new appliance. Connect to the serial console, and at the command prompt type **config ns** to run the NetScaler configuration script. Enter parameter values, such as NetScaler IP address and subnet mask. For information about performing initial configuration by using the configuration utility (GUI) or the LCD keypad, see [Initial Configuration](#).
5. Restart the new appliance.
6. Add a route on the new appliance. At the command prompt, type:  
**add route** <network> <netmask> <gateway>
7. Copy the edited configuration file to the new appliance.
8. Copy other relevant files, such as bookmarks, SSL certificates, and CRLs, to the new appliance. Return your feature license(s) to the Citrix licensing portal and reallocate it on the new appliance. For more info about returning your licenses, see <http://support.citrix.com/article/CTX131110>.

**Note:** The platform license is different for a new appliance.

9. Restart the new appliance.
10. Add interface-related configuration specific to your new appliance, switch, and router, and save the configuration.

If you have a high-availability setup, you must perform the above procedure on both the nodes.

## Free Manuals Download Website

<http://myh66.com>

<http://usermanuals.us>

<http://www.somanuals.com>

<http://www.4manuals.cc>

<http://www.manual-lib.com>

<http://www.404manual.com>

<http://www.luxmanual.com>

<http://aubethermostatmanual.com>

Golf course search by state

<http://golfingnear.com>

Email search by domain

<http://emailbydomain.com>

Auto manuals search

<http://auto.somanuals.com>

TV manuals search

<http://tv.somanuals.com>