

Spectra Logic

DAStape User Guide



P.N. 90930055 Revision A

Notices

Except as expressly stated herein, Spectra Logic Corporation makes available its products and associated documentation on an “as is” basis, without warranty of any kind, either expressed or implied, including but not limited to the implied warranties or conditions of merchantability and fitness for a particular purpose. In no event shall Spectra Logic be liable for any loss of profits, loss of business, loss of use of data, interruption of business, or for indirect, special, incidental, or consequential damages of any kind, even if Spectra Logic has been advised of the possibility of such damages arising from any defect or error.

Information furnished in this manual is believed to be accurate and reliable. However, no responsibility is assumed by Spectra Logic for its use. Because of continuing research and development, Spectra Logic may revise this publication from time to time without notice, and reserves the right to change any product specification at any time without notice.

Some products or services mentioned in this manual are provided by companies other than Spectra Logic. Inquiries about one or more of these products or services should be sent directly to the company in question. These brand or product names, registered trademarks, and trademarks are property of their respective owners. These trademarks may be registered in this country, other countries, or both.

DAStape User Guide

Copyright © 2003 Spectra Logic Corporation. All rights reserved.

How to Contact Spectra Logic Corporation

United States Office

Mailing Address Spectra Logic Corporation
1700 N 55th Street
Boulder CO 80301
USA

Phone (800) 833-1132 or (303) 449-6400

Fax (303) 939-8844

Technical Support (800) 227-4637 or (303) 449-0160

Web Site <http://www.SpectraLogic.com>

European Office

Mailing Address Spectra Logic Europe Limited
Magdalen Centre
Robert Robinson Avenue
Oxford Science Park
Oxford
UK OX44 7 RW

Phone +44 (0) 870 112 2150

Fax +44 (0) 870 112 2175

License

You have acquired Spectra Logic® products that include software owned by or licensed by Spectra Logic from one or more software licensors (Software Suppliers). Such software products, as well as associated media, printed materials and “online” or electronic documentation (Software) are protected by copyright laws and international copyright treaties, as well as other intellectual property laws and treaties. The Software is licensed, not sold.

If you do not agree to this End User License Agreement (EULA), do not use the Spectra Logic product. Instead, promptly contact Spectra Logic for instruction on return of the product for a refund. Any use of the Software, including but not limited to use of the product, will constitute your agreement to this EULA (or ratification of any previous consent).

GRANT OF LICENSE. The Software is licensed, not sold. This EULA grants you the following rights to the Software:

- You may use the Software only on the Product with which it was sold.
- **Not fault tolerant.** The Software is not fault tolerant. Spectra Logic has independently determined how to use the Software in the product, and suppliers have relied upon Spectra Logic to conduct sufficient testing to determine that the Software is suitable for such use.
- **No warranties for this software.** The Software is provided “as is” and with all faults. The entire risk as to satisfactory quality, performance, accuracy, and effort (including lack of negligence) is with you. Also, there is no warranty against interference with your enjoyment of the Software or against infringement. If you have received any warranties regarding Software, those warranties do not originate from, and are not binding on, Software Suppliers.
- **Note on Java support.** The Software may contain support for programs written in Java. Java technology is not fault tolerant and is not designed, manufactured, or intended for use of resale as online control equipment in hazardous environments requiring fail-safe performance, such as the operation of nuclear facilities, aircraft navigation or communication systems, air traffic control, direct life support machines, or weapons systems, in which the failure of Java technology could lead directly to death, personal injury, or severe physical or environmental damage.
- **No liability for certain damages.** Except as prohibited by law, Software Suppliers shall have no liability for any indirect, special, consequential or incidental, damages arising from or in connection with the use or performance of the Software. This limitation shall apply even if any remedy fails of its essential purpose. In no event shall Software Suppliers, individually, be liable for any amount in excess of U. S. two hundred fifty dollars (U.S. \$250.00).
- **Limitations on reverse engineering, decompilation, and disassembly.** You may not reverse engineer, decompile, or disassemble the Software, except and only to the extent that such activity is expressly permitted by applicable law notwithstanding this limitation.
- **Software transfer allowed with restrictions.** You may permanently transfer rights under this EULA only as part of a permanent sale or transfer of the Product, and only if the recipient agrees to this EULA. If the Software is an upgrade, any transfer must also include all prior versions of the Software.
- **Export restrictions.** Export of the Software from the United States is regulated by Export Administration Regulations (EAR, 15 CFR 730-744) of the U. S. Commerce Department, Bureau of Export Administration. You agree to comply with the EAR in the export of re-export of the Software: (i) to any country to which the U.S. has embargoed or restricted the export of goods or services, which as of May 1999 include, but are not necessarily limited to Cuba, Iran, Iraq, Libya, North Korea, Sudan, Syria, and the Federal Republic of Yugoslavia (including Serbia, but not Montenegro), or to any national or any such country, wherever located, who intends to transit or transport the Software back to such country; (ii) to any person or entity who you know or have reason to know will utilize the Software or portion thereof in the design, development or production of nuclear, chemical, or biological weapons; or (iii) to any person or entity who has been prohibited from participating in U.S. export transactions by any federal agency of the U.S. government. You warrant and represent that neither the BXA nor any other U.S. federal agency has suspended, revoked or denied your export privileges. For additional information see: <http://www.microsoft.com/exporting/>.

Warnings and Cautions

AC Power

Warning: Risk of electrical shock. To remove AC power from the DASTape unit, unplug the power cord from the power inlet. There are no user serviceable parts within the unit.

High Voltage

Warning: The DASTape unit contains high-voltage components that can cause injury or death. Only qualified electricians should replace or install high-voltage components.

Tapes

Caution: Use only the data cartridges approved for use with the drive installed in the DASTape unit. Improper data cartridges can cause damage to the DASTape, drive, and tape cartridges.

Contents

| | |
|--|---|
| Notices | 2 |
| How to Contact Spectra Logic Corporation | 2 |
| License | 3 |
| Warnings and Cautions | 4 |

Chapter 1. Introduction **7**

| | |
|------------------------|---|
| About DASTape® | 7 |
| About This Guide | 7 |

Chapter 2. Installing DASTape **9**

| | |
|----------------------------------|----|
| Preparing for Installation | 9 |
| Unpacking the DASTape | 10 |
| Connecting the DASTape | 12 |
| Configuring the DASTape | 12 |

Chapter 3. Using the DASTape **15**

| | |
|--|----|
| Powering On and Off | 15 |
| Purchasing Media and Cleaning Cartridges | 16 |

Chapter 4. DASTape 100 Tape Drives and Media **17**

| | |
|-----------------------|----|
| AIT Tape Drives | 17 |
|-----------------------|----|

Chapter 5. DASTape 200 Tape Drives and Media **23**

HP Ultrium Generation 1 Tape Drives 24
 IBM Ultrium Generation 2 Tape Drives 29
 Quantum SDLT 320 Tape Drives 36

Chapter 6. Warranty and Repair **41**

Limited Warranty 41
 Contacting Spectra Logic 44

Appendix A. Specifications **45**

DASTape Power Requirements 45
 DASTape Environmental Specifications 46
 Sony AIT Specifications 47
 HP LTO Ultrium Generation 1 Specifications 48
 IBM LTO Ultrium Generation 2 Specifications 49
 Quantum SDLT 320 Specifications 50

Appendix B. Regulatory and Safety Notices **51**

Safety Agency Standards 51
 FCC Notice 51
 Japan VCCI-A 52
 EU Declaration of Conformity 53

Index **55**

1 Introduction

About DASTape®

The DASTape provides an interconnection that is easy to install, configure, and use. It was designed specifically for the needs of direct-attached storage (DAS). The DASTape 100 and DASTape 200 support only single-ended or LVD SCSI tape drives.

Note: Neither DASTape 100 nor DASTape 200 will support high-voltage differential (HVD) tape drives.

The DASTape 100 supports a single Sony AIT-2 drive or Sony AIT-3 drive, and the DASTape 200 supports a single Quantum SDLT 320 or IBM LTO-2 tape drive.

About This Guide

This guide is written for DASTape owners, and reviews DASTape installation and use.

Conventions Used

This guide uses special conventions to highlight notes, cautions, and warnings.

Note: Read **Notes** for additional information or suggestions about the topic or procedure being discussed.

Caution: Read **Cautions** to learn ways to avoid damaging DASTape, tape drives or other equipment.

Warning: Read **Warnings** to learn ways to avoid personal injury.

2 Installing DASTape

This chapter covers the following information:

- *Preparing for Installation*
- *Unpacking the DASTape*
- *Connecting the DASTape*
- *Configuring the DASTape*

Preparing for Installation

Before you install a DASTape unit, complete these steps:

- Identify the host that is to be associated with the unit, and its operating system.
- Determine how the DASTape is to be used with your backup software.

Proper Installation Environment

When planning the DASTape installation, note that the unit, drives, and media must be maintained in a controlled environment. Environmental extremes and large quantities of airborne particulates can cause erratic operation of any peripheral, including the DASTape unit. See *Appendix A. Specifications* for information on DASTape operating specifications and tape drive operating specifications.

Unpacking the DASTape

Before unpacking the DASTape, note that it is shipped with the following items:

- *Quick Setup Guide*
- CD-ROM, including firmware and *User Guide* (this guide)
- One media cartridge and one cleaning cartridge
(only for the DASTape 200 configured with and SDLT 320 drive)
- AC power cord

Removing the DASTape from Its Packaging

To unpack the DASTape from its box, follow these steps.

1. Remove the DASTape unit and its foam protectors from the box (Figure 2-1).

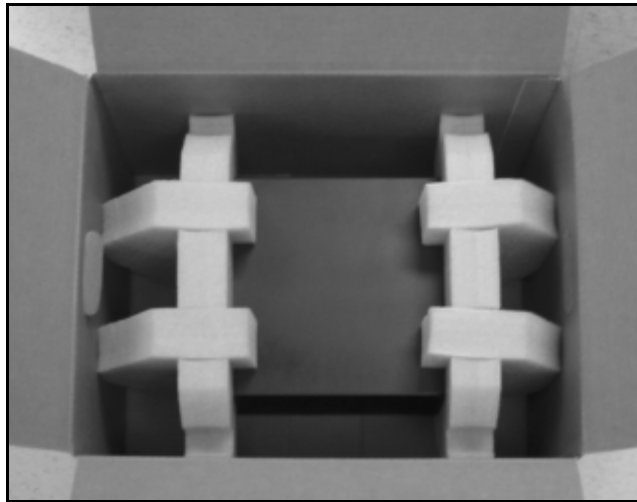

Figure 2-1 *The DASTape with its foam supports inside the box.*

2. Set the protected DASTape on a clean, stable work surface (Figure 2-2).

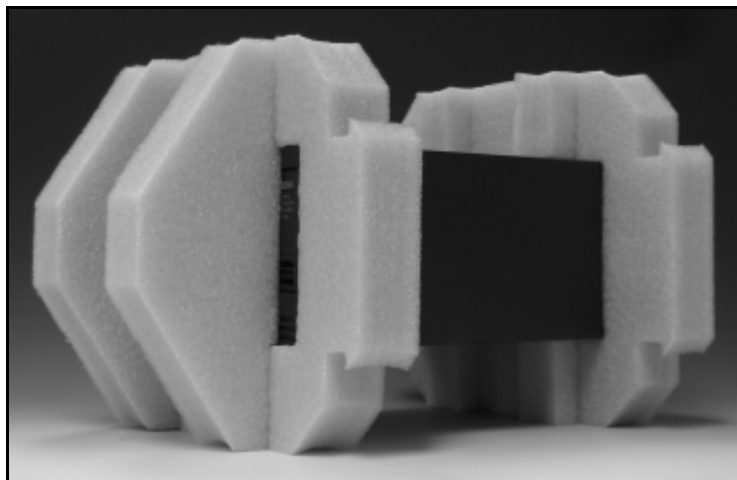

Figure 2-2 *The DASTape in its foam supports.*

3. Remove the foam from each end of the DASTape, one end at a time.

Caution: Be sure to support the first end before removing the foam from the second end.



Figure 2-3 *Remove the foam from the DASTape.*

4. Move the DASTape to the installation site when you are ready to connect it.

Note: Keep DASTape's packing materials in a safe place for moving or shipping the DASTape in the future. Any damage caused to DASTape due to improper packing may void its warranty.

Connecting the DASTape

Follow these instructions to connect the DASTape unit.

1. Plug in the power cord.
2. Turn on the DASTape unit.

Note: The DASTape will make a high-pitched noise upon start up. This is normal behavior for the low-voltage sensor in the unit.

Note: The DASTape has a SCSI terminator built into the unit. It can therefore only be placed at the end of a SCSI bus.

Configuring the DASTape

The DASTape comes with a SCSI ID switch that can be set for an ID between 0 and 15. You will need to make sure that the SCSI ID on the DASTape does not conflict with any other devices on the SCSI bus. To change the SCSI ID setting, follow these steps:

1. Locate the SCSI ID on the rear panel of the DASTape, just above the terminator ports. The current ID setting is shown in the indicator window (Figure 2-4).

2. Use an object with a small pointed tip (such as a stylus or a pen) to press the plus (+) on the bottom or the minus (-) at the top to change the SCSI ID setting (Figure 2-4).

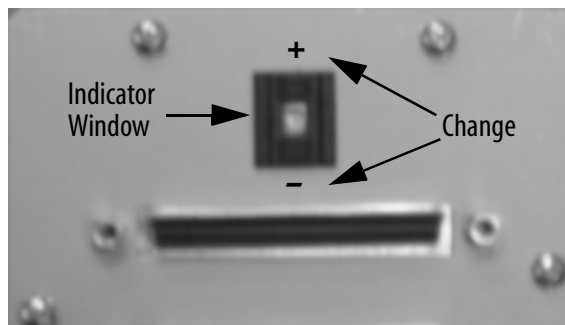

Figure 2-4 SCSI ID changer.

3. Once the DASTape's SCSI ID setting is unique from other devices on the SCSI bus, the DASTape is ready to use.

3 Using the DAStape

This chapter covers the following information:

- *Powering On and Off*
- *Purchasing Media and Cleaning Cartridges*

Powering On and Off

The DAStape unit power switch is located on the DAStape's rear panel, just to the right of the fan (Figure 3-1).



Figure 3-1 *The DAStape power switch.*

Purchasing Media and Cleaning Cartridges

Certified media and cleaning cartridges can be purchased directly from Spectra Logic's Web site or by calling your sales representative.

Contacting Spectra Logic

| Information | |
|--------------------|---|
| Web Site | http://www.spectrallogic.com |

| Supplies and Accessories Sales | |
|---------------------------------------|---|
| United States Sales | Phone: (800) 833-1132 or (303) 449-6400 Fax: (303) 939-8844 E-mail: sales@spectrallogic.com |
| European Sales | Phone: +44 (0) 870 112 2150 Fax: +44 (0) 870 112 2175 E-mail: eurosales@spectrallogic.com |
| Ordering Media | Web Site: http://www.SpectraLogic.com/media E-mail: media@spectrallogic.com |

4 DASTape 100 Tape Drives and Media

The DASTape 100 uses a Sony AIT tape drive, either AIT-2 or AIT-3. The Sony AIT tape drive is a high-performance, low-maintenance tape drive. This chapter covers the following information:

- *AIT Tape Drives*
- *AIT Tape Drive LEDs*
- *Maintaining the AIT Tape Drive*
- *Caring for AIT Data Cartridges*
- *Handling of Tape Cartridges*

AIT Tape Drives

The AIT tape drive has an internal, variable-speed fan that cools the baseplate and other drive components without introducing airborne dust into the tape path. The fan, visible from the outside of the DASTape, is also a critical part of the drive-cooling mechanism.

The Sony AIT drive uses a built-in head cleaner designed to last for the life of the drive. This built-in cleaner works well, but it should not be relied upon as the *only* drive-cleaning mechanism, particularly in environments where more excessive drive head contamination may occur. Spectra Logic recommends that drives be cleaned after every 100 hours of use in normal data center environments. If excessive read or write errors occur while the drives are being cleaned with that frequency, Spectra Logic recommends cutting the cleaning time to every 50 hours of drive use.

Caution: Drive cleaning should be performed using only approved Sony SDX-TCL cleaning cartridges. For ordering information, see *Purchasing Media and Cleaning Cartridges* on page 16.

For more information about cleaning your drives, see *Tape Drive Head Cleaning* on page 20.

AIT Tape Drive LEDs

The AIT tape drive has three light emitting diodes, or LEDs, on the front of the drive, as shown in Figure 4-1.

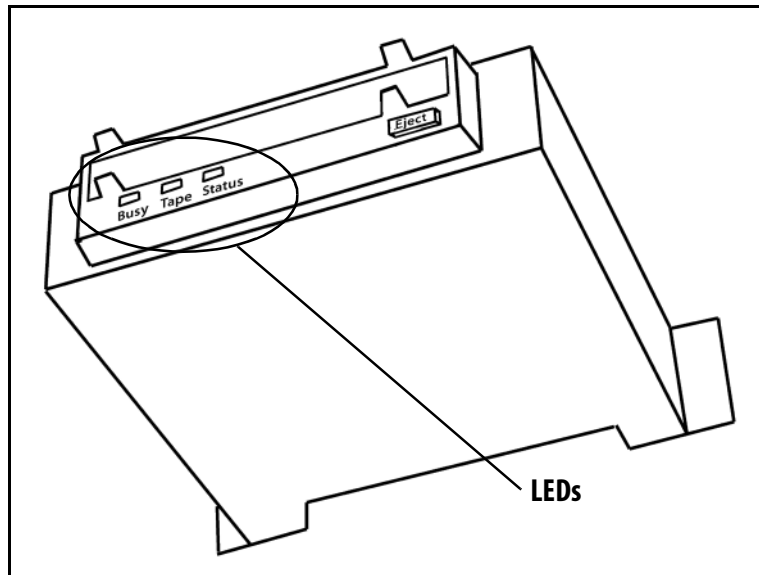

Figure 4-1 The AIT drive sled, showing its faceplate and LEDs.

Busy Indicates drive read and write activity.

Tape Indicates tape load, unload activity and error rate information.

Status Indicates the status of the tape drive including whether the tape inside is write protected, is a cleaning tape, or if the drive failed a self test.

Getting Information from the LEDs

The following table summarizes the information carried by the blinking methods of the different drive LEDs:

| Type of Blink | LED Type | | |
|---------------------------|-------------------|---|---|
| | Busy | Tape | Status |
| Off ^a | Not Busy | Unloaded | N/A |
| On ^b | SCSI Active | Loaded | Write protected |
| Fast Blink ^c | Drive active | Loading/Unloading | Cleaning tape at EOM |
| Slow Blink ^d | N/A | Error Rate Warning: data may be written incorrectly | Cleaning request |
| Single Pulse ^e | Waiting for reset | Waiting for eject | N/A |
| Double Pulse ^f | N/A | N/A | Self-test failure: power cycle the DASTape to reset |

- a. Off: no color in the LED
- b. On: green* and not blinking
- c. Fast blink: blinks green* for 1/4 second and off for 1/4 second
- d. Slow blink: blinks green* for 3-1/2 seconds and off for 1/2 second
- e. One pulse: blinks green* for 1/4 second and off for 1 second
- f. Two pulse: blinks green* for 1/4 second twice in a row then off for 1 second

* A green light on an AIT-2 drive is equivalent to a blue light on an AIT-3 drive.

If the drive's Tape LED indicates possible errors with the data on that tape, the errors may be caused by old media or physical damage to the media. Resolve the problem by copying the data to another tape and discarding the old tape.

Maintaining the AIT Tape Drive

The AIT tape drive is an extremely reliable media storage subsystem; performing a few simple maintenance procedures will keep the drives reading and writing reliably for many years.

- For best performance with AIT tape drives, perform a read/write confidence test with your backup software regularly. For information about performing this operation, see the documentation for your backup software.
- As explained in *AIT Tape Drives* on page 17, the drive cleans itself when necessary. If further cleaning is necessary, as indicated by the drive LED light and/or by the read/write confidence test, use only Sony SDX-TCL cleaning cartridges. For ordering information, see *Purchasing Media and Cleaning Cartridges* on page 16.

Tape Drive Head Cleaning

Head cleaning with a Sony SDX-TCL cleaning cartridge should be performed in the following situations:

- Every 100 hours of drive use (or less) in the following situations:
 - When the DASTape has been installed in areas having high amounts of airborne particulates.
 - When the drive fails to write or read data correctly.
 - When the drive fails to eject a data cartridge.

Note: Damaged media can also cause read/write errors and failures.

Most installations require scheduled cleaning using SDX-TCL cleaning cartridges. Scheduled cleaning is definitely required in installations having high amounts of airborne particulates.

To clean your AIT tape drives, follow these steps:

1. Power on the DASTape.
2. Carefully insert the Sony SDX-TCL cleaning tape into the drive with the window facing the top of the drive. The cleaning tape performs automatic cleaning and ejects the cartridge when complete.

Caution: Do not use the cleaning cartridge for more than the number of specified cleaning cycles indicated on the cartridge label. Mark the cleaning cartridge each time you use it or use backup software to track cleaning cartridge usage.

Caring for AIT Data Cartridges

Although AIT cartridges are ruggedly built, they must be handled with care to preserve the data that they contain. The following are guidelines for storing and using AIT cartridges:

- Do not open the tape access door of the cartridge or touch the magnetic tape; one fingerprint can prevent a drive from reading the tape. Handle only the plastic tape cartridge.
- Keep the cartridge away from sources of electromagnetic fields such as telephones, dictation equipment, mechanical or printing calculators, motors, stereo speakers, and bulk erasers. Do not lay cartridges on a computer monitor or on the base unit of a computer.
- Keep the cartridge away from direct sunlight and heat sources, such as radiators and warm air ducts.
- Keep the cartridge free of moisture. Do not wet or submerge a cartridge in liquid.
- Do not expose the cartridge to temperature extremes. Allow the cartridge to reach room temperature slowly.

Handling of Tape Cartridges

Proper handling of tape cartridges is essential to insuring data integrity.

- Tape cartridges must be kept in a clean, dust-free environment. Store tape cartridges in a sealed container (the individual tape case or the 15-slot cartridge packs with the dust cover installed) when they are not loaded in the DASTape. The Spectra Logic Pack Rack™ cartridge storage system is recommended when using the 15-cartridge pack.
- Avoid abusive handling or dropping of tape cartridges. If a cartridge is inadvertently dropped, inspect it for damage. The dust cover on the cartridge must be properly seated or it could cause a jam condition in the tape drive.
- Cartridges should be used within the environmental specifications described in *Appendix A. Specifications* on page 45.

Note: Extreme changes in temperature and humidity should be avoided whenever possible.

Conditioning Cartridges

Before use, the cartridge should be conditioned by exposure to the operating environment for a time at least equal to the period during which it has been out of the operating environment (up to a maximum of 24 hours).

5 DASTape 200 Tape Drives and Media

The DASTape 200 uses a half-inch tape drive that could be any of the following:

- HP First Generation Linear Tape Open (LTO-1) Ultrium
- IBM Second Generation Linear Tape Open (LTO-2) Ultrium
- Quantum Super Digital Linear Tape (SDLT) 320

The following sections provide detailed information about the care and use of the tape drive inside the DASTape 200, as well as the media used in that tape drive. See *Appendix A. Specifications* on page 45 for tape drive specifications.

HP Ultrium Generation 1 Tape Drives

HP Ultrium Tape Drive LEDs

The HP Ultrium tape drive has four light emitting diodes (LEDs) on the front of the drive, as shown in Figure 5-1.

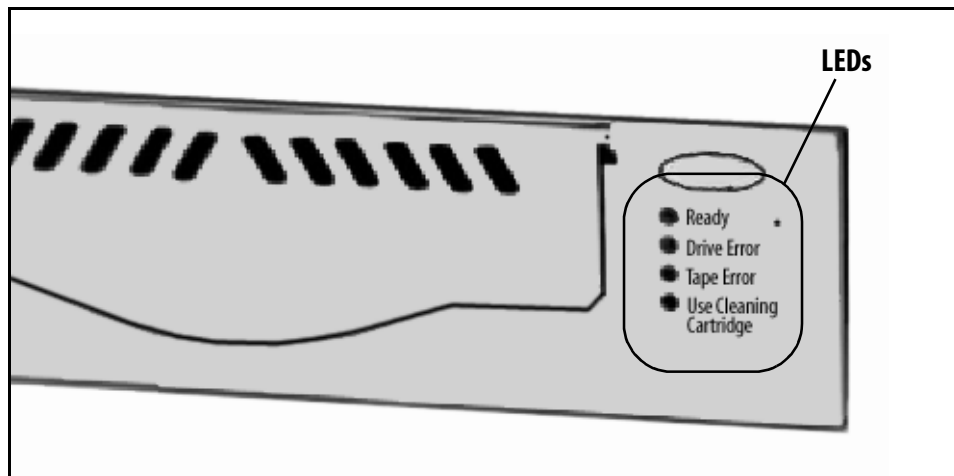

Figure 5-1 The HP LTO-1 drive face, showing its LEDs.

Ready This green LED indicates power and activity.

Drive Error This amber LED indicates an error in the drive.

Tape Error This amber LED indicates an error in the tape cartridge.

Use Cleaning Cartridge This amber LED indicates when a cleaning cartridge should be used.

Getting Information from the LEDs

The following table summarizes the information carried by the blinking methods of the different drive LEDs:

| Type of Blink | LED Type | | | |
|------------------|--|--|--|---|
| | Ready | Drive Error | Tape Error | Use Cleaning Cartridge |
| Off | Power is off, or there was a failure during self-test. | No fault has been detected. | No fault has been detected. | Drive does not require cleaning. |
| On | Ready for use. | N/A | N/A | Cleaning cartridge in use; the Ready LED will also flash. |
| Flashing | Active. | Unrecoverable hardware failure. ^a | Tape cartridge is faulty. ^b | Drive needs cleaning. ^c |
| Flashing Pattern | In OBDR mode. | N/A | N/A | N/A |

- a. A power cycle or a successful tape load will turn off the LED; but if the hardware fault is still present, it will come on again if the same operation is performed.
- b. This LED could come on for a number of reasons. Do not use the cartridge; replace it. The LED will go out when a new tape load is started.
- c. The LED will continue to flash if power is cycled; it will only go out after an approved cleaning cartridge has been used.

Maintaining the HP Ultrium Tape Drive

HP Ultrium tape drives have been developed to require minimal cleaning. The amber LED for Use Cleaning Cartridge will flash when the drive needs to be cleaned. Only insert a cleaning cartridge into the drive when the LED indicates to do so.

Note: Drive cleaning should be performed using only approved HP Ultrium cleaning cartridges; other cleaning cartridge formats will not load or run.

To order approved cleaning cartridges from Spectra Logic, see *Purchasing Media and Cleaning Cartridges* on page 16.

Manually Cleaning the HP Ultrium Tape Drive Head

To clean your HP Ultrium tape drives, follow these steps:

Note: Use only HP Ultrium cleaning cartridges.

1. Power on the DASTape.
2. Carefully insert the cleaning tape into the drive with the window facing the top of the drive.

The cleaning tape performs automatic cleaning; this takes approximately five minutes.

Note: If the cartridge ejects immediately, it has either expired or it is not an approved cleaning cartridge. In this case, discard the cartridge and begin the cleaning procedure with a new cartridge.

During the cleaning cycle, the amber Use Cleaning Cartridge LED will remain on and the green Ready LED will flash.

3. The drive ejects the cartridge when complete; remove the cleaning cartridge from the drive.

Caution: Do not use the cleaning cartridge for more than the number of specified cleaning cycles indicated on the cartridge label. Mark the cleaning cartridge each time you use it or use backup software to track cleaning cartridge usage.

Caring for HP Ultrium Media

Choosing Media

Use only LTO Ultrium cartridges. Compatible media is recognizable by the Ultrium logo, which is the same as the logo on the front of the drive.

Caring for HP Ultrium Media

In optimal environments, LTO cartridges are should last for 1,000,000 passes over any part of the tape (this equals approximately 2,000 complete backup and restore operations). These numbers should, however, be limited in harsher environments.

Caution: If you are using bar code labels, make sure that only one label is attached to the label area.

Never use non-standard labels, and never attach anything to the cartridge other than in the label area.

Using HP Ultrium Media

Only use LTO Ultrium media within its operating range requirements (see *Appendix A. Specifications*). If you expose the media to conditions that exceed these limits, stabilize the media before use. To do this, keep the media out of use in the operating environment for at least 24 hours.

Storing HP Ultrium Media

Only store LTO Ultrium media within its operating range requirements (see *Appendix A. Specifications*). Make sure that the environment is clean, and always store cartridges in their plastic cases.

Maximizing HP Ultrium Media Life

To maximize the life of your HP Ultrium media, follow these guidelines.

- Do not touch the surface of the tape inside the cartridge.
- Do not attempt to clean the tape path or the tape guides inside the cartridge.
- Do not expose the tapes to excessively dry or excessively humid conditions.
- Do not leave the cartridges in direct sunlight.
- Do not leave the cartridges in places where magnetic fields are present (such as under telephones, next to monitors, or near transformers).
- Do not drop the cartridges or handle them roughly.

Avoiding Condensation

Condensation can cause problems for tape drives and media. To minimize the chance of condensation, stay within specifications and observe the following guidelines.

- Make sure that the operating environment is stable (away from windows, doors, and heating or cooling sources).
- Avoid leaving cartridges in severe temperature conditions (such as in a car).
- Avoid transferring data when the temperature is changing by more than 18°F (16°C) per hour.
- If you bring a cold cartridge into a warm room, allow time for the cartridge to adjust to room temperature before use (up to 24 hours).

IBM Ultrium Generation 2 Tape Drives

IBM Ultrium Tape Drive LEDs

The IBM Ultrium tape drive has four light emitting diodes (LEDs) on the front of the drive, as shown in Figure 5-1.

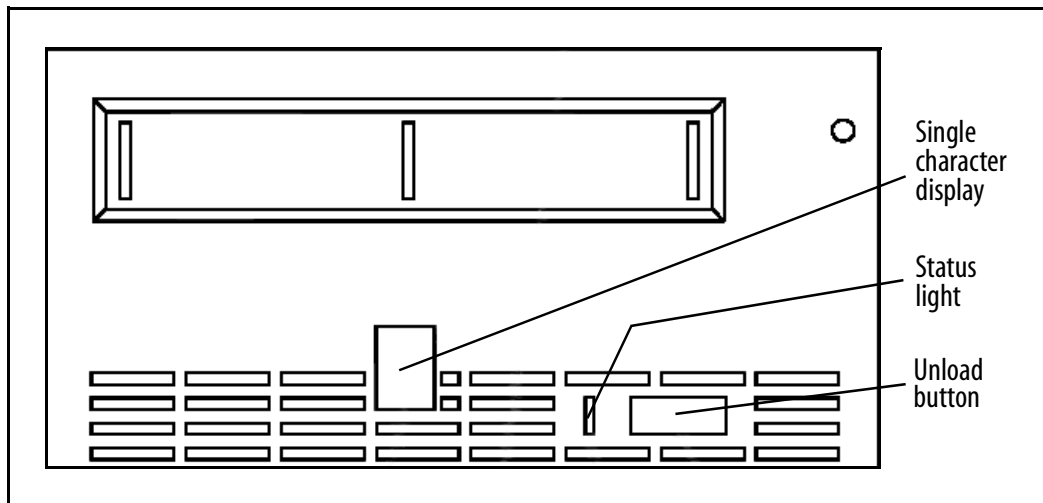

Figure 5-2 *The IBM LTO-2 drive face, showing its LEDs.*

Single-character display This LED presents a single-character code for:

- Error conditions and informational messages
- Diagnostic or maintenance functions (while in maintenance mode only)

Status light This LED provides information about the state of the drive. The light can be green or amber, and (when lit) solid or flashing.

Unload button This button is used for ejecting tapes from the unit as well as for initiating various maintenance functions.

Getting Information from the LEDs

When the LED is off, it means that the unit has no power or is powered off.

The following table summarizes the information given by the blinking methods of the status light LED:

| Indication | LED Color | |
|------------|--|--|
| | Green | Amber |
| Solid | The drive is powered on. If a solid C appears in the single-character display, the drive needs cleaning. | The drive is powering on or is in maintenance mode. |
| Flashing | The drive is reading from the tape, writing to the tape, rewinding the tape, locating data on the tape, loading the tape, or unloading the tape. The status light also flashes green if the drive contains a cartridge during the power-on cycle. In this case, the drive completes writing the current data and slowly rewinds the tape (the process may take up to 13 minutes). The light stops blinking when the drive completes the recovery and is ready for a read or write operation. | One of the following applies: <ul style="list-style-type: none"> - If the light flashes <i>once per second</i>, an error occurred and the tape drive or media may require service. (Note the code on the single-character display, then go to <i>Error Conditions and Informational Messages</i> on page 31 to determine the action that is required.) - If the light flashes <i>twice per second</i>, the tape drive is updating firmware. - If the light flashes <i>four times per second</i>, the tape drive detected an error and is performing a firmware recovery. It resets automatically. |

Getting Information from the Single-Character Display

Error Conditions and Informational Messages If multiple errors occur, the code with the highest priority (represented by the lowest number) displays first. When the error is corrected, the code with the next highest priority displays, and so on until no errors remain.

| Code | Cause and Solution |
|----------|---|
| 0 | No error occurred and no action is required. This code displays: <ul style="list-style-type: none"> - When power is cycled. - When diagnostics have finished running and no error occurred. |
| 1 | Cooling problem. The tape drive detected that the recommended operating temperature was exceeded. Perform one or more of the following actions: <ul style="list-style-type: none"> - Ensure that the cooling fan is rotating and is quiet. - Remove any blockage that prevents air from flowing freely through the tape drive. - Ensure that the operating temperature and airflow is within the specified range. - If the operating temperature is within the specified range and the problem persists, replace the drive. The error code clears when you power-off the tape drive or place it in maintenance mode. |
| 2 | Power problem. The tape drive detected that the externally supplied power is approaching the specified voltage limits (the tape drive is still operating) or is outside the specified voltage limits (the tape drive is not operating). Perform the following: <ul style="list-style-type: none"> - Ensure that the power connector is properly seated. - Ensure that the proper dc voltages are being applied within the tolerances allowed. - If the proper voltages are being applied but the problem persists, replace the drive. The error code clears when you power-off the tape drive or place it in maintenance mode. |

Note: The single-character display is blank during normal operation.

Diagnostics and Maintenance To initiate a function, you must be in maintenance mode. For more information, see *Functions of the Unload Button* on page 33.

| Function | Code ^a |
|--|-------------------|
| Run Tape Drive Diagnostics Runs tests and determines whether the drive can properly load and unload cartridges and read and write data. | 1 |
| Update Tape Drive Firmware from FMR Tape Load updated firmware from a field microcode replacement (FMR) tape. | 2 |
| Create FMR Tape Copies the drive's FMR data to a scratch (blank) data cartridge. | 3 |
| Force a Drive Dump Performs a dump of data (also known as saving a microcode trace). | 4 |
| Copy the Drive Dump to Tape (at Beginning of Tape) Copies data from a drive dump (captured by using Function Code 4) to the beginning of a scratch (blank) tape. | 5 |
| Run SCSI Wrap Test Performs a check of the SCSI circuitry from and to the SCSI connector. | 6 |
| Run RS-422 Wrap Test Not available. | 7 |
| Unmake FMR Tape Erases the FMR data on a scratch (blank) tape and rewrites the cartridge memory on the tape. This turns the cartridge into a valid scratch data cartridge. | 8 |
| Display Error Code Log Display the last 10 error codes, one at a time (the most recent is presented first and the oldest is presented last). | 9 |
| Clear Error Code Log Erases the contents of the error code log. | A |
| Insert Cartridge into Tape Drive This function cannot be selected by itself; it is a part of other functions that require a tape be loaded. | C |
| Test Cartridge & Media Performs tests to ensure that a suspect cartridge and its magnetic tape are acceptable. | E |
| Fast Read/Write Test Performs tests to ensure that the drive can read from and write to tape. | F |
| Test Head Performs tests to ensure that the tape drive's head and tape-carriage mechanics are working correctly. | H |
| Exit Maintenance Mode The drive becomes available for reading and writing data. | 0 |

a. The single-character display is blank during normal operation.

Functions of the Unload Button

The Unload push button enables you to perform several functions. The following table lists the functions and explains how to initiate them.

| Function | How To Initiate |
|---|---|
| Rewind the tape into a cartridge and eject the cartridge from the tape drive. | Press the unload button once. Note: During a rewind and eject operation, the drive will not accept SCSI commands from the server. |
| Place the tape drive in maintenance mode. | Ensure that the tape drive is unloaded. Then, within two seconds push the unload button three times. The drive is in maintenance mode when the status light becomes solid amber and a 0 appears in the single-character display. Note: While in maintenance mode, the drive will not accept SCSI commands from the server. |
| Scroll through the maintenance functions. | While in maintenance mode, push the unload button once per second to increment the characters on the single-character display by one. When you reach the character of the diagnostic or maintenance function that you want (see <i>Diagnostics and Maintenance</i> on page 32), press and hold the unload button for three seconds. |
| Exit maintenance mode. | Press the unload button once per second until a 0 appears in the single-character display. Then press and hold the unload button for three seconds. The drive has exited maintenance mode when the status light becomes solid green and the single-character display becomes blank. |

Note: If you press the Unload button during operation, the drive ends the command that is being processed, then unloads and ejects the tape. Depending on its location on the reel, the tape may take as long as 20 minutes to completely rewind and eject.

Maintaining the IBM Ultrium Tape Drive

Note: When cleaning the IBM Ultrium tape drive head, use only IBM LTO Ultrium cleaning cartridges. You may use another LTO cleaning cartridge, but it may not meet the standards of reliability established by IBM.

To order approved cleaning cartridges from Spectra Logic, see *Purchasing Media and Cleaning Cartridges* on page 16.

Cleaning the Drive Head

Clean the drive head whenever **C** displays on the single-character display and the status light is solid green. IBM does not recommend that you clean the drive head on a periodic basis, but only when **C** displays.

To clean the head:

1. Insert the cleaning cartridge into the tape load compartment.

The tape drive performs the cleaning automatically. The cleaning cycle takes less than two minutes.

2. When the cleaning is finished, the drive ejects the cartridge. Remove the cartridge.

Note: If you insert a cleaning cartridge when the drive does not need to be cleaned or if you insert a cleaning cartridge that has expired, the drive will automatically eject the cartridge.

The IBM LTO Ultrium cleaning cartridge is valid for 50 uses. Be sure to mark the cartridge after each use to keep track of how many times it is used.

Caring for IBM Ultrium Media

Caring for IBM Ultrium Media

Caution: Do not insert a damaged cartridge into the drive. A damaged cartridge can interfere with the reliability of the drive and may void the warranties of the drive and the cartridge.

Before inserting a tape cartridge, inspect the cartridge case, cartridge door, and write-protect switch for breaks. Incorrect handling or an incorrect environment can damage the LTO Ultrium tape cartridge or its magnetic tape. To avoid damage to your tape cartridges and to ensure the continued high reliability of your drive, use the following guidelines:

- Do not drop the cartridge. If the cartridge drops, slide the cartridge door back and ensure that the leader pin is properly seated in the pin-retaining spring clips. Inspect the rear of the cartridge (the part that you load first into the tape load compartment) and ensure that there are no gaps in the seam of the cartridge case.
- Open only the cartridge door. Do not open any other part of the cartridge case. The upper and lower parts of the case are held together with screws; separating them destroys the usefulness of the cartridge.
- Do not handle tape that is outside the cartridge. Handling the tape can damage the tape's surface or edges, which may interfere with read or write reliability. Pulling on tape that is outside the cartridge can damage the tape and the brake mechanism in the cartridge.
- Before you use a cartridge, let it acclimate for at least 24 hours to the normal operating environment.
- Ensure that all surfaces of a cartridge are dry before inserting it.
- Do not stack more than six cartridges.
- Do not expose the tape cartridge to moisture or direct sunlight.
- Do not degauss a tape cartridge that you intend to reuse. Degaussing makes the tape unusable.
- Do not expose recorded or blank tape cartridges to stray magnetic fields (such as terminals, motors, video equipment, X-ray equipment, or high-current cables or power supplies). Such exposure can cause the loss of recorded data or make the blank cartridge unusable.
- Maintain the environmental conditions specified in *Appendix A. Specifications*.

Quantum SDLT 320 Tape Drives

SDLT 320 Tape Drive LEDs

The tape drive has three light emitting diodes, or LEDs, on the front of the drive, as shown in Figure 5-3.

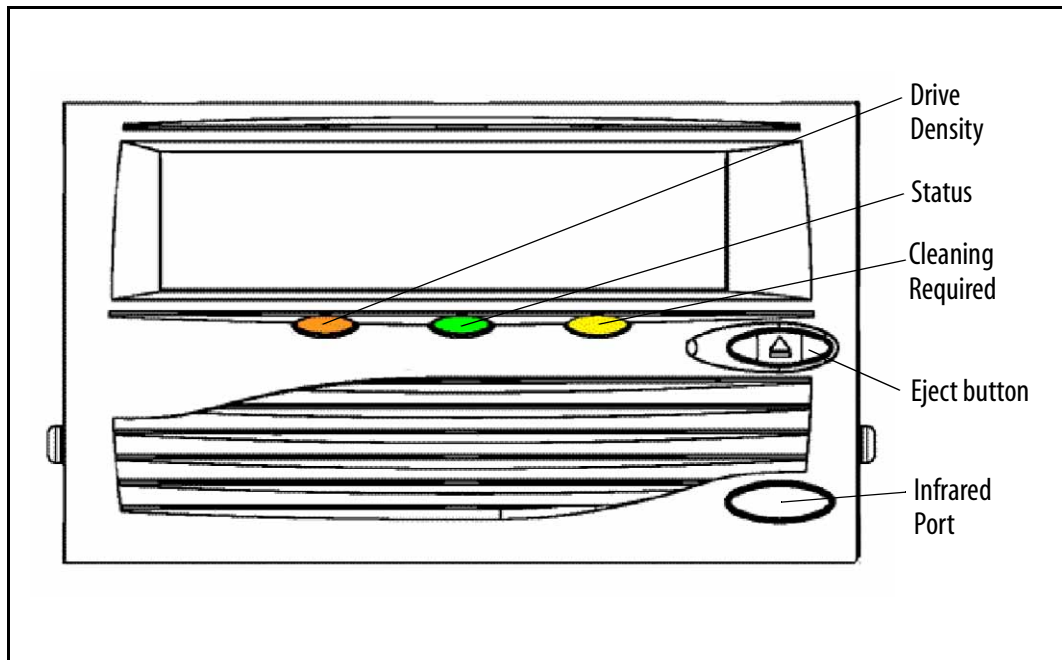

Figure 5-3 The SDLT drive sled, showing its faceplate and LEDs.

Density LED This amber LED indicates whether the tape in the drive is of the SDLT-220 format or SDLT-320 format.

Status LED This green LED indicates the tape drive status.

Cleaning LED This yellow LED indicates cleaning requirements and functions.

Eject This button ejects the tape cartridge from the drive. When the button is pressed, the drive completes any writing of data to the tape, and then ejects the cartridge.

Infrared Port This infrared port, also known as the Global Storage Link (GSLink), provides a wireless remote testing base for customers and integrators to access system diagnostic information.

Getting Information from the LEDs

The following table summarizes the information carried by the blinking methods of the different drive LEDs:

| Indication | LED Type | | |
|------------|---|---|---------------------------|
| | Density | Status | Cleaning |
| Off | The tape in the drive is SDLT-320 format. | The unit has not been turned on or is not plugged into a power source. | Cleaning is not required. |
| On | The tape in the drive is SDLT-220 format. | The drive is idle. There may or may not be a cartridge in the tape drive. | Cleaning is required. |
| Blinking | N/A | The tape drive is in use. This includes: <ul style="list-style-type: none"> • Calibrating, reading, writing, or rewinding the tape. • Loading or unloading. | N/A |

If the drive's Status LED indicates possible errors with the data on that tape, the errors may be caused by old media or physical damage to the media. Resolve the problem by copying the data to another tape and discarding the old tape.

Maintaining the SDLT Tape Drive

Cleaning Status

The Cleaning Required (yellow) LED on the front panel indicates to the operator that cleaning is needed.

Note: Use the SDLT cleaning tape if cleaning is indicated through your backup software or when the yellow alert light is *on*. Do not clean the drive unless the drive indicates that cleaning is necessary.

Once illuminated, the yellow LED stays lit until one of the following occurs:

- The drive is cleaned successfully.
- The drive is reset due to a firmware failure or firmware update.
- Power is cycled off and on.

Cleaning the SDLT Tape Drive Head

The SDLT cleaning tape is housed in a plastic case, and is light gray in color. Use only approved SDLT cleaning cartridges. To order these cartridges from Spectra Logic, see *Purchasing Media and Cleaning Cartridges* on page 16.

A yellow LED located on the front bezel of the tape drive indicates when cleaning is needed (the location of this LED is shown in Figure 5-3 on page 36).

Clean the DASTape as follows:

1. Power on the DASTape.
2. Carefully insert the cleaning tape into the drive with the window facing the top of the drive.
3. The cleaning tape performs automatic cleaning and ejects the cartridge when complete.

Note: Do not use the cleaning cartridge more than 20 times. Mark the cleaning cartridge each time you use it or use backup software to track cleaning cartridge usage.

Load Time for Cleaning Cartridge

Load (cycle) times for SDLT cleaning cartridges are as follows; these times are accurate to ± 20 seconds:

- Shortest load time (first pass of cleaning cartridge): 2 minutes 55 seconds
- Longest load time (20th pass of cleaning cartridge): 10 minutes 20 seconds
- Expired load time (expired cleaning tape): 4 minutes 30 seconds

On the last pass, the cleaning process stops, the tape is rewound, but the cartridge is not ejected. If the tape is loaded again after the 20th pass, it winds all the way to the end of the cartridge and back again without performing the cleaning sequence; the tape does not eject.

Caution: Never use a DLT cleaning tape in an SDLT drive; DLT cleaning tapes are incompatible with the SDLT heads.

Caring for SDLT Media

Super DLTtape I cartridges are engineered to be reliable, robust, and durable. They are manufactured to withstand 1,000,000 passes, and have a shelf life of 30 years. For best results, follow these guidelines for media care:

- Protect cartridges from shock, vibration, moisture, and magnetic fields.
- Keep media in protective cases at all times.
- Store cartridges vertically when not in use.
- Use the sliding labels provided. Do not use adhesive labels and do not write on the cartridge.
- Never touch the tape or tape leader. Dust and oils from your skin contaminate the tape and affect performance.
- If you drop a cartridge, perform a visual media inspection before inserting it into the drive.

Note: The safety of your data relies on proper care and handling of media cartridges.

Refer to the environmental specifications provided in the plastic cartridge case, or in *Appendix A. Specifications* on page 45, for detailed media information.

Handling SDLT Tape Cartridges

Improper media handling is the primary reason for tape drive problems. Mishandled and damaged cartridges lead to damaged drives. If the cartridge does not pass the following criteria, do not use it.

To inspect a cartridge:

1. Inspect the exterior of the cartridge for physical damage, cracks, or broken parts.
2. Gently shake the cartridge. Listen for rattling of loose pieces.
3. Check to make sure that both reel locks on the cartridge are visible. One reel lock is located on the end of the cartridge that is inserted into the drive. The other is on the bottom of the cartridge.
4. Confirm that the spring-loaded hub on the bottom of the cartridge is centered. Press the hub to ensure that the spring is functioning properly.
5. Verify that the orange write-protect switch is enabled and undamaged.

Conditioning Cartridges

Before use, the cartridge should be conditioned by exposure to the operating environment for a time at least equal to the period during which it has been out of the operating environment (up to a maximum of 24 hours).

6 Warranty and Repair

This chapter reviews the DASTape warranty and Spectra Logic's repair policies.

Limited Warranty

Spectra Logic warrants the DASTape unit to be in good working order for a period of three full years from the date of shipment from Spectra Logic or an authorized Spectra Logic dealer. Should this product fail to be in good working order at any time during this three-year period, Spectra Logic will, at its option, repair or replace this product at no additional charge except as follows:

Suspect parts sent to Spectra Logic will be repaired or replaced. Exchanged parts will be either reconditioned or new at the option of Spectra Logic. This limited warranty does not include:

- Service to repair damage resulting from accident
- Disaster, misuse, and abuse
- Non-Spectra Logic modification of the product including, but not limited to, product expansion through plug-in additions except as provided by Spectra Logic
- Removal of serial number tags
- Physical damage caused by inadequate packaging
- Tape head cleaning performed on drives provided by Spectra Logic with a non-certified cleaning cartridge
- Drives purchased from vendors other than Spectra Logic

If any of the above conditions exist, Spectra Logic reserves the right to repair the unit at the current fixed price of repair.

Warranty service can be acquired during the three-year period by shipping the product to Spectra Logic with an invoice and Return Materials Authorization (RMA) number.

Note: No return can be accepted without an RMA number from Spectra Logic Technical Support. Returns must be shipped prepaid in their original packing containers; damage incurred in transit is not covered by Spectra Logic's warranty.

Spectra Logic makes no other warranties, expressed or implied, and specifically disclaims any warranty of merchantability or fitness for a particular purpose or use. If this product is not in good working condition as warranted above, your sole remedy shall be replacement or repair as provided above. In no event will Spectra Logic be liable to you for any damages, including any lost profits, lost savings, or other incidental or consequential damages arising out of the use of or inability to use such product, even if Spectra Logic has been advised of the possibility of such damages, or for any claim by any other party.

Warranty Shipping

The DASTape unit must be returned in the original carton and packed with the original packing material. Failure to do so will void the warranty. See the label on the inside lid of the shipping container for instructions on packing the DASTape.

The purchaser is responsible for paying the shipping and insurance charges for warranty goods to Spectra Logic. Spectra Logic will pay for shipping the repaired item back to the purchaser.

International warranty repairs must be accompanied by a commercial invoice, a packing slip, and a carrier waybill. The following must be written on the invoice:

GOODS OF U.S. ORIGIN, RETURN FOR WARRANTY REPAIR, VALUE FOR CUSTOMS USE ONLY.

Import duties assessed on incoming shipments will be prorated to the customer's account if proper documentation does not accompany the shipment.

Warranty Turnaround Time

A standard repair turnaround time is two weeks from receipt of the product. Spectra Logic shall reserve the right to replace the unit if it cannot be repaired within the two week time frame. A 48-hour turnaround is available for an additional charge.

Warranty Provisions for Units Located in Europe

Spectra Logic has implemented special arrangements for honoring warranties on libraries located in Europe. Please contact Spectra Logic Technical Support for details.

Out-of-Warranty Repairs

Contact Technical Support for the current fixed repair price for DASTape. The repair is warranted for ninety days from the date the unit is shipped to a customer.

Out-of-Warranty Shipping

All non-warranty units will be shipped back to the purchaser as determined by the purchaser. Shipping charges to and from Spectra Logic are the responsibility of the

purchaser. International customers with non-warranty units are responsible for customs and duties charges coming into the United States as well as charges on returned products into their own countries.

Out-of-Warranty Turnaround Time

The non-warranty turnaround time is two weeks from receipt of the unit. An expedited turnaround of 48 hours is available for an additional fee. Spectra Logic reserves the right to either repair or replace the unit.

QuickSwap Service

QuickSwap service enables the North American user of a new DASTape to receive replacement parts or a replacement unit in a timely manner. The program includes:

- Access to a Spectra Logic Technical Support representative any business day (not including evenings, weekends or holidays) from 8:00 a.m. to 5:00 p.m. Mountain Time (MT).
- Upon verification that the unit has malfunctioned, the replacement parts or unit will be shipped to the customer. If Spectra Logic receives notification before 2:30 p.m. MT for the unit (and 4:30 p.m. MT for parts), the shipment will go out that same day.
- The replacement is shipped ground delivery via a carrier and service deemed appropriate by Spectra Logic. The customer has the option to upgrade to priority delivery for an additional charge. Check with Spectra Logic Technical Support personnel for details.

This program covers the product for the original return-to-factory period (three years from the date of shipment) at no cost to the customer.

Advanced Service Options

There are three advanced technical support services available on a contractual basis.

- Advanced Replacement Service
- Next Business Day On-Site Service
- Four-Hour On-Site Service

Please contact Technical Support for the contract pricing for these options.

Contacting Spectra Logic

| Information | |
|-------------|---|
| Web Site | http://www.spectralogic.com |

| Technical Assistance | |
|--------------------------|---|
| Technical Support Phone | United States: (800) 227-4637 or (303) 449-0160 Europe: +44 (0) 870 112 2185 |
| Technical Support E-Mail | support@spectralogic.com |
| Knowledge Base | http://www.spectralogic.com/support/kbase/index.cfm |

| RMA Number for Equipment Service and Returns | |
|--|---|
| Technical Support Phone | United States: (800) 227-4637 or (303) 449-0160 Europe: +44 (0) 870 112 2185 |
| Technical Support E-Mail | support@spectralogic.com |

Shipping Information

To ship the DASTape for any reason, reverse the procedure in *Unpacking the DASTape*, making sure to use the original packaging materials.

The following table lists the size and weight of the DASTape for shipping purposes.

| | DASTape 100 | DASTape 200 |
|---------------|--------------------|--------------------|
| Height | 3.5 in. (8.9 cm) | 5.9 in. (15.0 cm) |
| Width | 7.4 in. (18.8 cm) | 9.8 in. (24.9 cm) |
| Depth | 11.5 in. (29.2 cm) | 13.5 in. (34.3 cm) |
| Weight | 8.5 lbs. (3.9 kg) | 15 lbs. (6.8 kg) |

Caution: Do not ship the DASTape with a cartridge in the tape drive.

Appendix A. Specifications

This appendix contains the following information:

- *DASTape Power Requirements*
- *DASTape Environmental Specifications*
- *Sony AIT Specifications*
- *HP LTO Ultrium Generation 1 Specifications*
- *IBM LTO Ultrium Generation 2 Specifications*
- *Quantum SDLT 320 Specifications*

DASTape Power Requirements

Power requirements for DASTape are summarized in the table below.

| Source | Requirements |
|-----------------|---------------------------------------|
| Input Voltage | 115/230 Volts AC 1.0/.5 A |
| Input Power | 90 Watts minimum 120 Watts maximum |
| Input Frequency | 50/60 Hz |

Power Cable

The power cable included with DASTape is a standard, three conductor, 18 AWG power cord safe for 120-volt use in the United States and Canada. The cable has a molded NEMA 5-15P male connector to plug in the wall and a molded IEC 60320-type female connector to plug in the DASTape unit.

Note: To use the DASTape unit outside of the United States or Canada, the power cord must meet the specifications for that country.

220 Volt-AC Power Cord for Use in North America

The criteria for a U.S. and Canadian 220-volt AC power cord for the DAStape are as follows:

- Power cord must have a molded NEMA 6-15P attachment plug on one end.
- Power cord must have a molded IEC 60320-type female connector to connect to the DAStape unit.
- Cordage must be SJT type, three-conductor, 18 AWG minimum.
- Power cord must comply with local electrical code.

220 Volt-AC Power Cord for International Use

The criteria for an international 220-volt AC power cord are as follows:

- Power cord must have an attachment plug of the proper type, rating, and safety approval for the intended country.
- Power cord must have a molded IEC 60320-type female connector to connect to the DAStape.
- Cord must be a flexible, HAR (harmonized) type H05VV-F, three conductor, cord with minimum conductor size of 0.03 square inches (1.0 square millimeter).

DAStape Environmental Specifications

Place the DAStape unit and media in a reasonably controlled environment that does not exceed the environment limits listed in the table below.

| Condition | Minimum | Maximum |
|------------------------------------|-----------------|--------------------|
| Ambient Operating Temperature | 2° C | 30° C |
| Storage Temperature | -40° C | 65° C |
| Relative Humidity (non-condensing) | 20% | 80% |
| Max. wet bulb temperature | N/A | 26° C |
| Altitude | 0 m (sea level) | 3,000 m (9,842 ft) |

To allow for proper cooling and to maintain the proper temperature of the DAStape, leave at least six (6) inches of open space behind the unit.

Sony AIT Specifications

Drive Specifications

The following table summarizes the specifications for Sony AIT drives.

| Parameter | AIT-2 Specification ^a | AIT-3 Specification ^a |
|--------------------------------------|--|---|
| MTBF | 300,000 hours @ 100% duty cycle | 400,000 hours @ 100% duty cycle |
| Average file access time | Less than 27 seconds | Less than 27 seconds |
| Uncorrectable error rate | Less than 1×10^{-17} bits | Less than 1×10^{-17} bits |
| Sustained transfer rate ^b | 6 MB/sec native (15 MB/sec compressed) | 12 MB/sec native (31 MB/sec compressed) |
| Burst transfer rate ^c | 40 MB/sec Synchronous maximum | 160 MB/sec Synchronous maximum |

- All specifications are subject to change without notice.
- Compression throughput and capacity depends on the type of data.
- The actual burst data transfer rate is limited by the performance of the SCSI host bus adapter, the SCSI bus interface controller, and the buffer control hardware of the drive.

Media Specifications

The table below lists the capacities of the different types of AIT tape cartridges.

| Tape Type | Length | Capacity ^a |
|-------------------|------------|---|
| AIT-2 (SDX2-36C) | 170 meters | 36 GB native (94 GB compressed with ALDC) |
| AIT-2 (SDX2-50C) | 230 meters | 50 GB native (130 GB compressed with ALDC) |
| AIT-3 (SDX3-100C) | 230 meters | 100 GB native (260 GB compressed with ALDC) |

- All specifications are subject to change without notice.

Environmental Specifications

The table below lists the environmental specifications of AIT tape cartridges.

| Factor ^a | Operating Environment |
|------------------------------------|---------------------------------|
| Operating temperature ^b | +41°F to +104°F (+5°C to +40°C) |
| Operating humidity | 20% to 80% non-condensing |
| Maximum wet bulb temperature | +77°F (+25°C) |

- All specifications are subject to change without notice.
- The upper limit applies to the drive, not to the DASTape. Be sure there is adequate air flow around DASTape at all times.

HP LTO Ultrium Generation 1 Specifications

Drive Specifications

| Parameter | Specification ^a |
|--------------------------------------|---|
| MTBF | 250,000 hours @ 100% duty cycle |
| Average file access time | 71 seconds |
| Uncorrectable error rate | 1×10^{-17} bits |
| Sustained transfer rate ^b | 7.5 MB/sec native 15 MB/sec compressed |
| Burst transfer rate ^c | 80 MB/sec synchronous maximum |

- All specifications are subject to change without notice.
- Compression throughput and capacity depends on the type of data.
- The actual burst data transfer rate is limited by the performance of the SCSI host bus adapter, the SCSI bus interface controller, and the buffer control hardware of the drive.

Media Specifications

The table below lists the capacity of HP LTO-1 tape cartridges.

| Tape Type | Capacity ^a |
|--------------------------|---|
| LTO Ultrium Generation 1 | 100 GB native (200 GB compressed with LTO-DC) |

- All specifications are subject to change without notice.

Environmental Specifications

The table below lists the environmental specifications of HP LTO-1 tape cartridges.

| Factor ^a | Operating Environment ^b |
|---------------------|------------------------------------|
| Temperature | +50°F to +95°F (+10°C to +35°C) |
| Relative Humidity | 20% - 80% non-condensing |

- All specifications are subject to change without notice.
- The upper limit applies to the drive, not to the DASTape. Be sure there is adequate air flow around DASTape at all times.

IBM LTO Ultrium Generation 2 Specifications

Drive Specifications

| Parameter | Specification ^a |
|--------------------------------------|--|
| Average file access time | 65 seconds |
| Uncorrectable error rate | 1×10^{-17} bits |
| Sustained transfer rate ^b | 35 MB/sec native 70 MB/sec compressed |
| Burst transfer rate ^c | 80 MB/sec Synchronous maximum |

- All specifications are subject to change without notice.
- Compression throughput and capacity depends on the type of data.
- The actual burst data transfer rate is limited by the performance of the SCSI host bus adapter, the SCSI bus interface controller, and the buffer control hardware of the drive.

Media Specifications

The table below lists the capacity of IBM LTO-2 tape cartridges.

| Tape Type | Capacity ^a |
|--------------------------|--|
| LTO Ultrium Generation 2 | 200 GB native (400 GB compressed with DLZ) |

- All specifications are subject to change without notice.

Environmental Specifications

The table below lists the environmental specifications of IBM LTO-2 tape cartridges.

| Factor ^a | Operating ^b | Operational Storage | Archival Storage | Shipping |
|----------------------|-------------------------------------|------------------------------------|------------------------------------|------------------------------------|
| Temperature | +50°F to +113°F (+10°C to +45°C) | +61°F to +90°F (+16°C to +32°C) | +61°F to +77°F (+16°C to +25°C) | -9°F to +120°F (-23°C to +49°C) |
| Relative Humidity | 10% - 80% | 20% - 80% | 20% - 50% | 5% - 80% |
| Wet Bulb Temperature | +79°F (+26°C) | +79°F (+26°C) | +79°F (+26°C) | +79°F (+26°C) |

- All specifications are subject to change without notice.
- The upper limit applies to the drive, not to the DASTape. Be sure there is adequate air flow around DASTape at all times.

Quantum SDLT 320 Specifications

Drive Specifications

| Parameter | Specification ^a |
|--------------------------------------|--|
| MTBF | 250,000 hours @ 100% duty cycle |
| Average file access time | 70 seconds |
| Uncorrectable error rate | 1×10^{-17} bits |
| Sustained transfer rate ^b | 16 MB/sec native 32 MB/sec compressed |
| Burst transfer rate ^c | 80 MB/sec Synchronous maximum |

- All specifications are subject to change without notice.
- Compression throughput and capacity depends on the type of data.
- The actual burst data transfer rate is limited by the performance of the SCSI host bus adapter, the SCSI bus interface controller, and the buffer control hardware of the drive.

Media Specifications

The table below lists the capacity of SDLT tape cartridges.

| Tape Type | Capacity ^a |
|-----------------|--|
| Super DLTtape 1 | 160 GB native (320 GB compressed with DLZ) |

- All specifications are subject to change without notice.

Environmental Specifications

The table below lists the environmental specifications of SDLT tape cartridges.

| Factor ^a | Operating Environment ^b | Storage Environment |
|---------------------|------------------------------------|---------------------------------|
| Temperature | +50°F to +95°F (+10°C to +35°C) | +61°F to +90°F (+16°C to +32°C) |
| Relative Humidity | 20% - 80% non-condensing | 20% - 80% non-condensing |

- All specifications are subject to change without notice.
- The upper limit applies to the drive, not to the DASTape. Be sure there is adequate air flow around DASTape at all times.

Appendix B. Regulatory and Safety Notices

This appendix lists the following regulatory and safety notices:

- *Safety Agency Standards*
- *FCC Notice*
- *Japan VCCI-A*
- *EU Declaration of Conformity*

Safety Agency Standards

The DAStape unit complies with the following regulatory and safety standards, and bears the CE and VCCI marks:

- EN 60950-1: 2002
- CSA/UL 60950

FCC Notice

This equipment has been tested and found to comply with the limits for a Class A digital device, pursuant to Part 15 of the FCC rules. These limits are designed to provide reasonable protection against harmful interference when the equipment is operated in a commercial environment. This equipment generates, uses, and can radiate radio frequency energy and, if not installed and used in accordance with the instruction manual, may cause harmful interference to radio communications. Operation of this equipment in a residential area is likely to cause harmful interference, in which case the user will be required to correct the interference at his own expense.

Shielded cables are required for this device to comply with FCC rules.

Japan VCCI-A

この装置は、クラス A 情報技術装置です。この装置を家庭環境で使用すると電波妨害を引き起こすことがあります。この場合には使用者が適切な対策を講ずるよう要求されることがあります。

VCCI-A

EU Declaration of Conformity

We, Spectra Logic Corporation
 1700 North 55th Street
 Boulder, Colorado 80301 USA

declare under sole responsibility that **Spectra Logic's DASTape**, to which this declaration relates, meets the essential health and safety requirements and is in conformity with the EU Directives listed below using the relevant section of the following EU standards and other normative documents:

| | |
|--|---|
| EU Low Voltage Directive 73/23/EEC | Essential health and safety requirements relating to electrical equipment designed for use within certain voltage limits. |
| EN 55022 (CISPER 22) Class A | Limits and methods of measurements of radio interference characteristics of information technology equipment. |
| EN 60950 (IEC 60950) | Safety requirements of information technology equipment including electrical machines. |
| EN 61000-4-2 (1995) | Electrostatic discharge requirements for industrial process measurement and control equipment. |
| EN 61000-4-3 (1996), ENV 50204 (1995) | Radiated electromagnetic field requirements for industrial process measurement and control equipment. |
| EN 61000-4-4 (1995) | Electrically fast transients for industrial process measurement and control equipment. |
| EN 61000-4-5 (1995) | Electrical surge immunity for industrial process measurement and control equipment. |
| EN 61000-4-6 (1996) | Conducted radio frequency immunity for industrial process measurement and control equipment. |
| EN 61000-4-8 (1993) | Power frequency magnetic field immunity for industrial process measurement and control equipment. |
| EN 61000-4-11 (1994) | Immunity to voltage dips, interruptions and variations for industrial process measurement and control equipment. |
| EN 61000-3-2 (1998) | Power Line Harmonics, Class A. |
| EN 61000-3-3 (1998) | Power Line Flicker. |
| EU EMC Directive 89/336/EEC | Essential health and safety requirements relating to electromagnetic compatibility. |

The DAStape complies with all safety-relevant provisions referring to:

- Protection against electrical hazards
- Protection against hazards such as:
 - Mechanical hazards
 - Fire hazards
 - Noise
 - Vibration

The CE marking has been affixed on the device according to Article 10 of the EU Directive 89/336/EEC and 73/23/EEC.

Index

A

about

- AIT tape drives 17
- DASTape 7
- LTO-1 tape drives 24
- LTO-2 tape drives 29
- SDLT tape drives 36
- this user guide 7

AC power 45

accessories

- included 10
- purchasing additional 16

AIT cleaning cartridges

- ordering 16
- using 20

AIT media

- maintenance 21
- purchasing 16
- specifications 47

AIT tape drives

- about 17
- cleaning 20
- LEDs 18, 19
- specifications 47
- using 17

C

cautions

- as conventions 7
- DASTape 4
- media 4

cleaning

- AIT tape drives 20
- LTO-1 tape drives 26
- LTO-2 tape drives 34
- SDLT tape drives 38
- configuring DASTape 12
- contact information
 - Spectra Logic 2, 44
- conventions used in this guide 7

D

DASTape

- about 7
- accessories
 - included 10
 - purchasing additional 16
- cautions 4
- configuring 12
- environment 9
- environmental specifications 46
- installation 9
- repair policy 41
- returns 44
- service 44
- shipping 44
- unpacking 10
- using 15
- warnings 4
- warranty 41
- drives (see drive type)

E

e-mail Spectra Logic
 ordering media 16
 technical support 44
environmental specifications
 AIT tape drives 47
 DASTape 46
 LTO-1 tape drives 48
 LTO-2 tape drives 49
 SDLT tape drives 50

F

fax Spectra Logic 2

H

hardware environment 9
high voltage
 warning 4
HP LTO-1 (see LTO-1)

I

IBM LTO-2 (see LTO-2)
installation
 DASTape 9
 environment 9

K

Knowledge Base 44

L

LEDs
 AIT tape drive 18
 LTO-1 tape drive 24
 LTO-2 tape drive 29
 SDLT tape drive 36
legal
 license 3
 limited warranty 41
 notices 2
 repair policy 41
license, legal 3
limited warranty 41
LTO-1 cleaning cartridges
 ordering 16
 using 26
LTO-1 media
 maintenance 27
 purchasing 16
 specifications 48
LTO-1 tape drives
 about 24
 cleaning 26
 LEDs 24, 25
 specifications 48
 using 25
LTO-2 cleaning cartridges
 ordering 16
 using 34
LTO-2 media
 maintenance 35
 purchasing 16
 specifications 49
LTO-2 tape drives
 about 29
 cleaning 34
 LEDs 29, 30, 31
 specifications 49
 using 31, 32, 33

M

maintenance

- AIT media 21
- cleaning tape drives 20
- LTO-1 media 27
- LTO-2 media 35
- SDLT media 39

media

- AIT specifications 47
- caution 4
- LTO-1 specifications 48
- LTO-2 specifications 49
- purchasing 16
- SDLT specifications 50

N

notes

- as conventions 7

notices, legal 2

O

out-of-warranty repairs 42

P

phone Spectra Logic 2

- sales 16
- technical support 44

policies

- limited warranty 41
- repair 41

power

- cable 45
- DASTape requirements 45
- international requirements 46
- US requirements 46
- warning 4

Q

Quantum SDLT (see SDLT)

R

repair policy 41

- out-of-warranty 42

requirements

- DASTape power 45

RMA numbers

- contacting technical support 44

S

SDLT cleaning cartridges

- ordering 16
- using 38

SDLT media

- maintenance 39
- purchasing 16
- specifications 50

SDLT tape drives

- about 36
- cleaning 38
- LEDs 36, 37
- specifications 50

shipping

- DASTape 44
- under warranty 42

specifications

- AIT media 47
- AIT tape drives 47
- DASTape environment 46
- DASTape power 45
- LTO-1 media 48
- LTO-1 tape drives 48
- LTO-2 media 49
- LTO-2 tape drives 49
- SDLT media 50
- SDLT tape drives 50

Spectra Logic

- contacting 2
- Knowledge Base 44
- sales 16
- technical support 44
 - e-mail 44
 - phone 44
- Web site 16, 44

T

tape drives

- (also see drive type)
- about DASTape drives 7

technical support

- contacting 44
- Knowledge Base 44
- RMA numbers 44
- warranty policies 41

troubleshooting

- Knowledge Base 44

U

unpacking the DASTape 10

user guide

- intent 7

using

- AIT tape drives 17
- DASTape 15
- LTO-1 tape drive 25
- LTO-2 tape drives 31, 32, 33

V

voltage

- warning 4

W

warnings

- AC power 4
- as conventions 7
- DASTape 4
- high voltage 4

warranty 41

- shipping 42

Web site

- Spectra Logic 2, 16, 44
- Knowledge Base 44

Free Manuals Download Website

<http://myh66.com>

<http://usermanuals.us>

<http://www.somanuals.com>

<http://www.4manuals.cc>

<http://www.manual-lib.com>

<http://www.404manual.com>

<http://www.luxmanual.com>

<http://aubethermostatmanual.com>

Golf course search by state

<http://golfingnear.com>

Email search by domain

<http://emailbydomain.com>

Auto manuals search

<http://auto.somanuals.com>

TV manuals search

<http://tv.somanuals.com>