



RECUMBENT TYPE

Cateye ergociser

MODEL EC-3700

OPERATING INSTRUCTIONS

EC-3700 RECUMBENT TYPE Cateye ergociser

How to Use This Manual

After you read the **Starting up** section of this manual, assemble your Cateye Ergociser™ and try it out. When you get used to the machine and develop a greater interest in it, please read the **Operation** section in preparation to trying the machine's numerous functions. Turn to the **Reference** section whenever the need arises.

Starting up

1 Let's assemble -----	6
2 Installing the control unit -----	8
3 How to adjust each part -----	10
4 Handling the pulse (earlobe) Sensor -----	12
5 Your first ride -----	14
6 The six programs for operation -----	16
7 Using your Ergociser without a data card -----	18

Operation

1 Your strength level and training index -----	22
2 Aerobic power measurement (Physical fitness test) -----	26
3 Automatic training -----	30
4 Isopower (constant load) training -----	32
5 Interval training -----	34
6 Hill profile training -----	36
7 Manual training -----	38
8 Setting your own training pattern -----	40
9 How to make a data card -----	42

Reference

1 External computer control via an RS232C terminal -----	46
2 Using chestbelt heart rate sensor -----	48
3 Setting the date -----	49
4 Printing mechanism -----	50
5 Trouble shooting and handling care -----	52
6 Warranty service and optional parts -----	54
7 Specifications -----	55

Name of parts

CONTROL

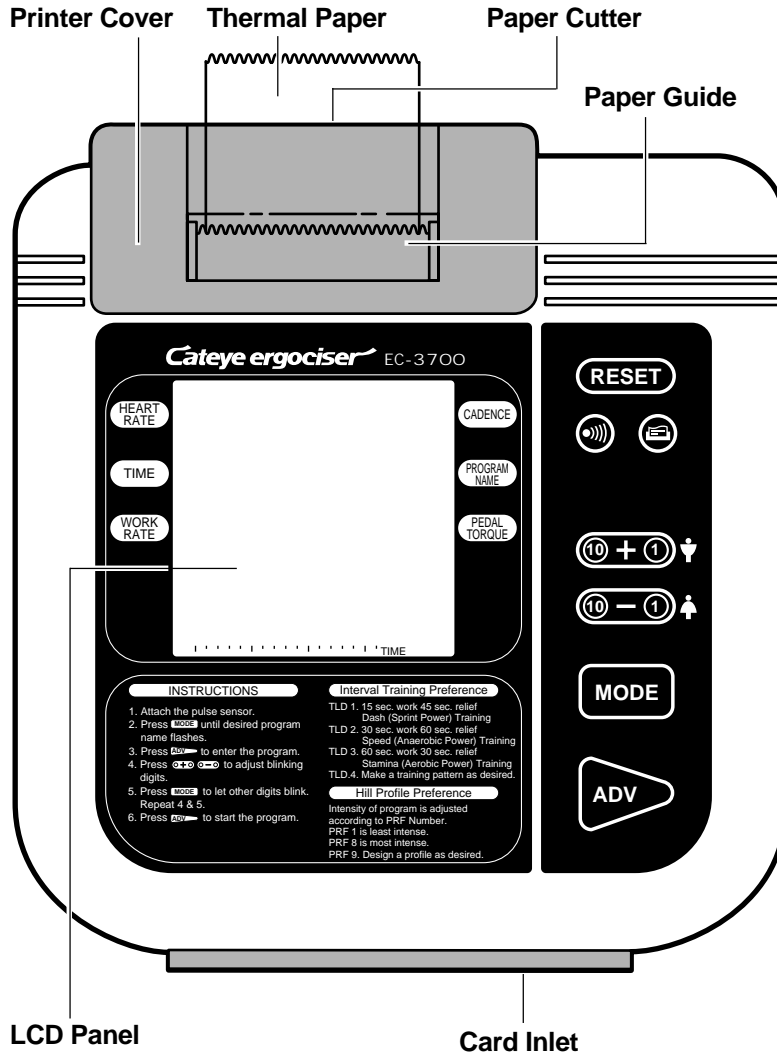

Reset Button (RESET)

Resets the program back to initial state.

Pitch Sound Button (Speaker Icon)

Turns on or off the pitch sound. When the pitch sound is on, (Speaker Icon) symbol appears on the LCD.

Printer Button (Printer Icon)

Turns on or off the printer function. When the printer is on, (Printer Icon) symbol appears on the LCD.

Value Adjust Button (+) (-)

Before exercise

(10) ---increases or decreases the blinking numerical value by 10. [For pedal torque (kg·m), by 1.0]

(1) ---increases or decreases the blinking numerical value by 1. [For pedal torque (kg·m) by 0.1]

* When selecting the gender, + (1) specifies MALE, and - (1) FEMALE)

During exercise

(10) ---increases or decreases pedal torque by 1.0 kg·m.

(1) ---increases or decreases pedal torque by 0.1kg·m.

Mode Button (MODE)

Before exercise

Used to select the program and to change the item of data to input.

During exercise

Displays the elapsed time or the calorie consumption alternatively.

ADV Button (ADV)

Makes the program proceed to the subsequent stage.

LCD PANEL

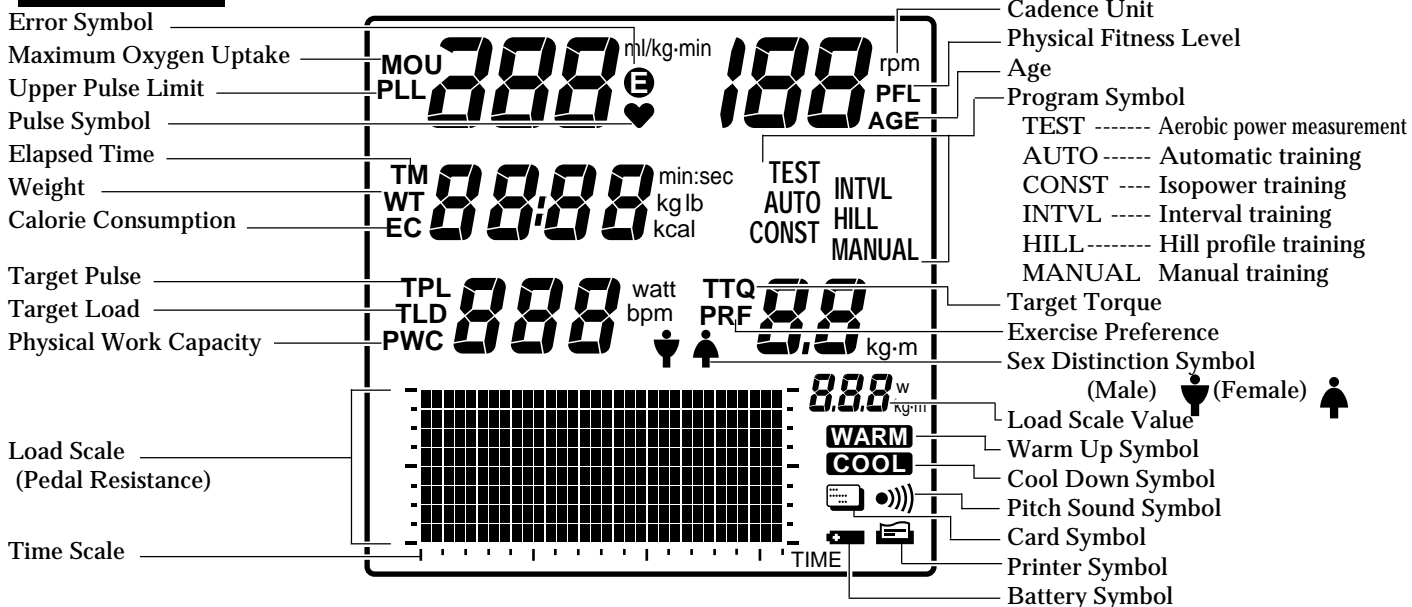

MAIN BODY

- ① Main Unit
- ② Control Unit
- ③ Pulse Sensor Jack
- ④ Card Inlet
(Data Card is inserted here.)
- ⑤ Cable Hooks
(Holds pulse sensor cable.)
- ⑥ Joint Fitting
(Connects main unit with rear frame.)
- ⑦ Seat Lock Pin
(Pull when adjusting seat position.)
- ⑧ Handlebar
- ⑨ Seat
- ⑩ Sensor Clip
(Attach pulse sensor when not in use.)
- ⑪ Rear Support Pipe
- ⑫ Seat Height Lock Knob
(Loosen when adjusting seat height.)
- ⑬ Rear Leg
- ⑭ Level Adjuster
(For better stability of the unit.)
- ⑮ Seat Pipe
- ⑯ Cable Holder
(Holds pulse sensor cable.)
- ⑰ Inner Pipe
- ⑱ Front Leg
- ⑲ Caster
(For easy transportation of the unit.)
- ⑳ Pedal
- ㉑ Crank
- ㉒ AC Adapter Inlet
- ㉓ Power Switch
- ㉔ Pulse Sensor
- ㉕ Cable Clip

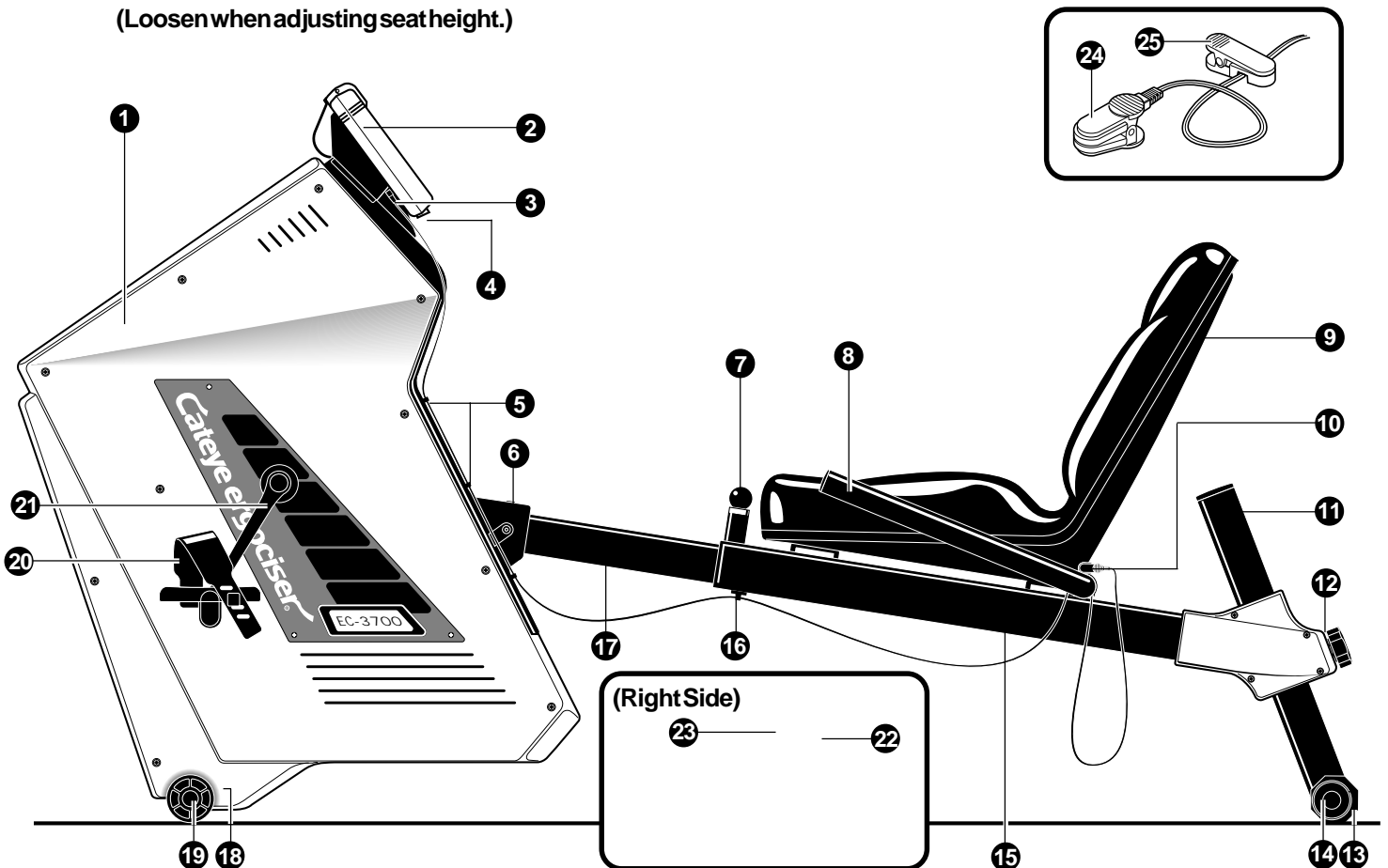

INTRODUCTION

Thank you very much for your purchase of the Model EC-3700 Cateye Ergociser™. The model EC-3700 is a new recumbent type high-tech exerciser with a built-in computerized training system designed specifically to promote cardiovascular fitness and overall endurance, the keystone of good health. With its endurance test program and five training programs, the EC-3700 will help you to maintain or improve your physical strength in a fun and pleasant way. We hope you will make good use of your Cateye Ergociser™ for years to come.

Before using your new exerciser, please read this manual carefully. Then store it in a safe place along with the warranty card.

FOR SAFE OPERATION

For safe use, always observe the following rules.

1. Before using the EC-3700, it is important to consult a medical specialist if you are suffering from any of the following : heart disease (angina pectoris, myocardial infarction), hypertension, diabetes, respiratory disease (asthma, chronic bronchitis, pulmonary emphysema, etc.), articular metamorphosis, rheumatism, gout, or other diseases and physical complaints. Pregnant women should also consult their doctor before commencing a training program.
2. If you are not used to regular physical activity, it may be dangerous to suddenly engage in strenuous activity. Increase your exercise level gradually.
3. If you feel sick or sense that something is wrong with your body during exercise, stop immediately.

IMPORTANT SAFETY INSTRUCTIONS

Read all instructions before using this exerciser.

DANGER — To reduce the risk of electric shock:

1. Always unplug this AC adapter from the electrical outlet immediately after using and before cleaning.

WARNING — To reduce the risk of burns, fire, electric shock, or injury to persons:

1. An AC adapter appliance should never be left unattended when plugged in. Unplug from outlet when not in use, and before putting on or taking of parts.
2. Close supervision is necessary when this exerciser is used by, on, or near children, invalids, or disabled persons.
3. Use this exerciser only for its intended use as described in this manual. Do not use attachments not recommended by the manufacturer.
4. Never operate this exerciser if it has a damaged cord or plug, if it is not working properly, if it has been dropped or damaged, or dropped into water. Return the exerciser to a service center for examination and repair.
5. Do not carry this exerciser by supply cord or use cord as a handle.
6. Keep the cord away from heated surface.
7. Never operate the exerciser with the air openings blocked. Keep the air openings free of lint, hair, and the like.
8. Never drop or insert any object into an opening.
9. Do not use outdoors.
10. Do not operate where aerosol (spray) products are being used or where oxygen is being administered.
11. To disconnect, turn all controls to the off position, then remove plug from outlet

This exerciser is intended for both household and commercial use.











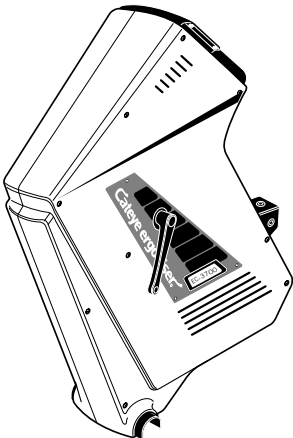

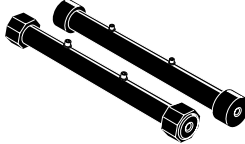
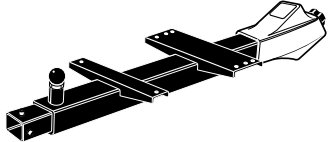

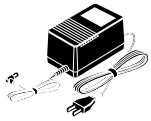

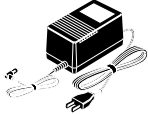
This equipment has been certified to comply with the limits for a Class B computing device, pursuant to Subpart J of Part 15 of FCC Rules. Only peripherals (computer input/output devices, terminals, printers, etc.) certified to comply with the Class B limits may be attached to this computer. Operation with non-certified peripherals is likely to result in interference to radio and TV reception.

SAVE THESE INSTRUCTIONS.

Starting up

- 1 Let's assemble
- 2 Installing the control unit
- 3 How to adjust each part
- 4 Handling the pulse (earlobe) Sensor
- 5 Your first ride
- 6 The six programs of operation
- 7 Using your Ergociser without a data card

Make sure all components are included in a package.

				
Main Unit	Rear Support Pipe	Front and Rear Legs		
				
Seat	Control Unit Base	Control Unit	Sensor Clip	Cable Holder
				
Handlebar	Control Unit Base	Data Card (10) Start Card (1)	Batteries (AAx2)	Mounting Screws (4 large, 4 small)
				
Pedals (L,R)	Tools			

Starting up

Let's assemble

1 Mounting Front Leg

- Remove the leg plate from the main unit. (This plate will not be used for assembly.)
- Place the front leg (with casters) under the main unit as shown in figure and fasten screws securely with the hexagon wrench making sure nuts locate at the bottom of the leg.

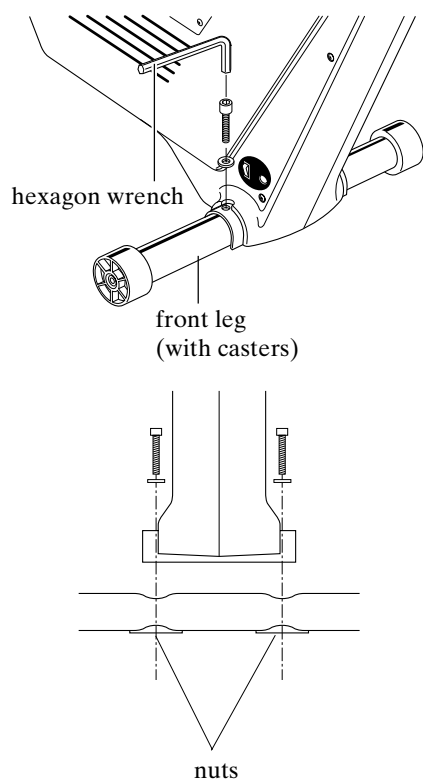

2 Mounting Rear Leg

- Place the rear leg (with level adjuster) under the rear support pipe as shown in figure and fasten screws securely with the hexagon wrench making sure nuts locate at the bottom of the leg.

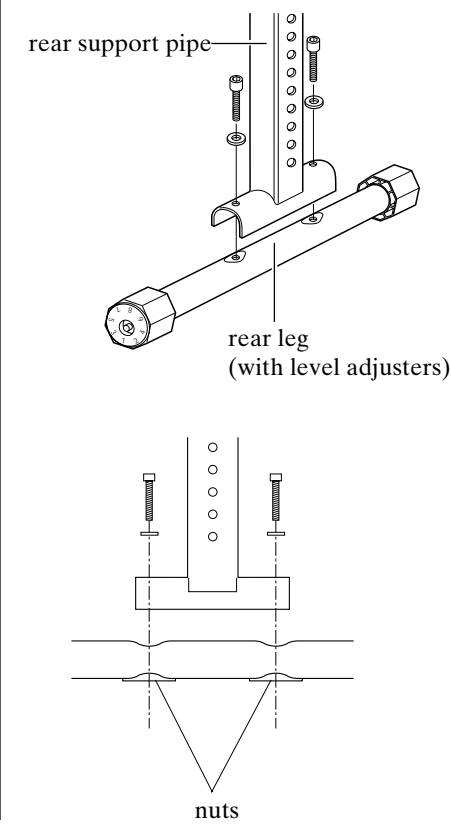

3 Mounting Seat and Handlebar

- Mount the seat to the seat pipe using the large screws and the handlebar using the small ones.

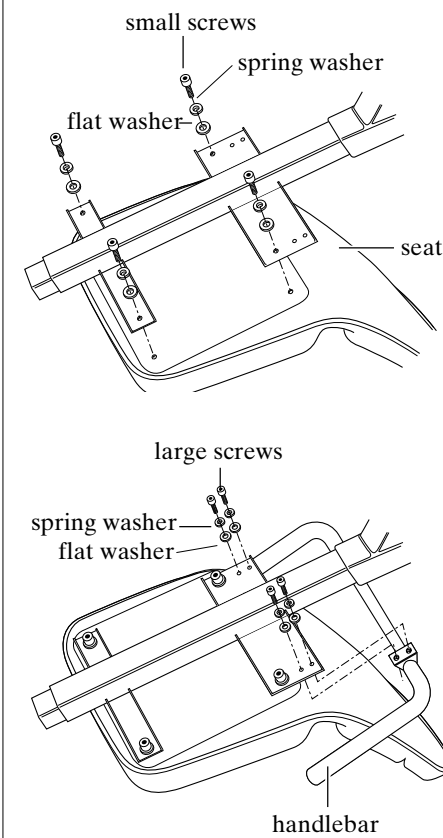

4 Assembling Rear Frame

- Loosen and remove the seat height lock knob.
- Insert the rear support pipe into the socket of seat pipe. Select any height and tighten the knob.

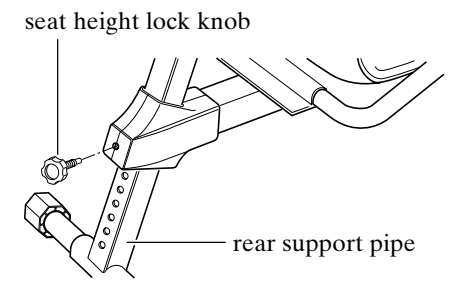

5 Connecting Inner Pipe

- Lift up the seat lock pin and pull out the inner pipe by a proper length for easier connection. Remove the 3 screws from the end of the inner pipe.
- Insert the inner pipe into the joint fitting of the main unit and fasten it securely with the 3 screws.

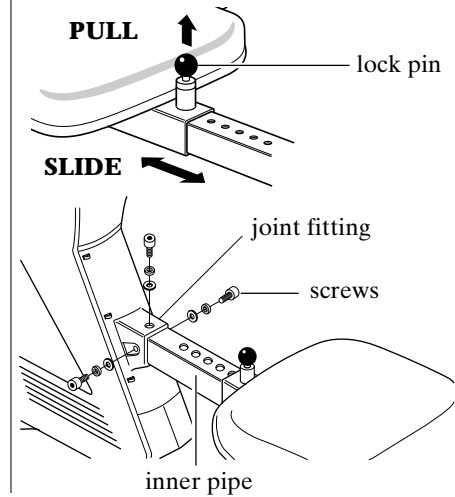

6 Mounting Pedals

- Attach the pedals to cranks using the spanner wrench #15.
- Be sure to install the pedal (R) on the right crank and (L) on the left crank to avoid cross threading.

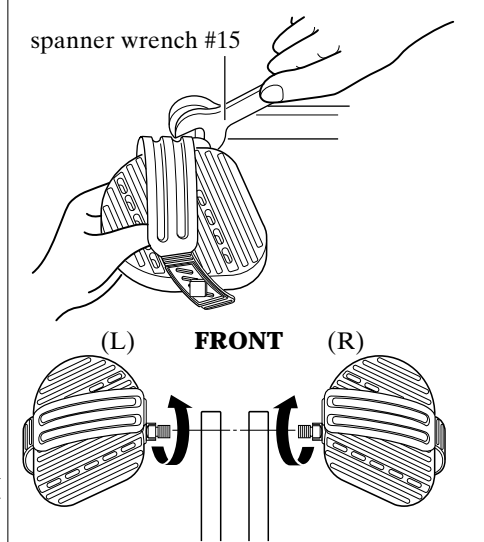

Caution: If the pedals are not attached firmly enough to the crank, they can an irritating noise. Be sure to attach them firmly.

Starting up

Installing the control unit

Using the select switches No.1 to 4 at the back of the control unit, the initial setting of fitness level evaluation table, body weight unit and printer function can be revised.

1 Loading backup batteries

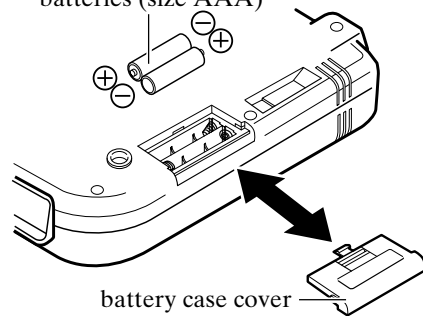

- The battery case cover is on the back of the control unit. You can open the cover by sliding off.
- Load batteries (size AAA x 2) in the battery case as shown in the diagram. Make sure the polarity is right, and close the case.



Note: The batteries are used for storing and updating the date memory even while the main unit is turned off. The batteries will last about 2 years under normal use. When the battery symbol  lights up on the LCD screen, replace the batteries promptly. Before replacing the batteries, remove the control unit by the reverse procedure of the sections 5 and 6 of page 9. Then connect the 5P cable to the control unit again and keep the main body power on while replacing the batteries. In this way the date memory is maintained. On how to set the date, refer to page 49 Reference 3.

2 Printer use

- Use select switch No.4 on the back of the control unit to activate or deactivate the printer.
NO.4-OFF-- printer activated
NO.4-ON --- printer deactivated
- This switch is initially set at "OFF" at our Factory, to activate the printer. In order that you will get familiar with the printer function, please leave this switch as it is at this stage.

Note: Though you set NO.4 at "OFF", you can temporarily deactivate the printer by depressing printer button on the control panel. (Printing mark  on LCD panel will disappear.)
When NO.4- is set at ON, printer button  on the main control panel does not function.

3 Units for body weight

- Use select switch No.3 on the back of the control unit to choose kilograms or pounds as your unit of body weight.
NO.3-OFF ----- kg
NO.3-ON ----- lb

Caution: When oxygen uptake (VO_2 max) is estimated in the aerobic power measurement (physical fitness test) program, body weight in kg is used. If you mistakenly assume the unit for body, the figure given for oxygen uptake will be wrong by a wide margin.

4 Strength evaluation table

- By using select switches No.1 and 2 in the aerobic power measurement (physical fitness test) program, you can change the internal tables by which your strength is judged.
- When the Model EC-3700 Cateye Ergociser™ leaves the factory, it is set for American use.

1-ON 2-OFF American use

Evaluation table by AHA Committee: "Exercise testing and training of apparently healthy individuals, A handbook for physicians (1972)"

1-OFF 2-ON European use

Evaluation table by Dr. Åstrand: "The values from P. -O. Åstrand, Work tests with the bicycle ergometer"

1-OFF 2-OFF Japanese use

Evaluation table by Dr. Ikegami: "Exercise prescriptions in theory and practice"

5 Attaching the control unit base

- Attach the control unit base to the back of the control unit as illustrated and fasten the base by the 4 screws.

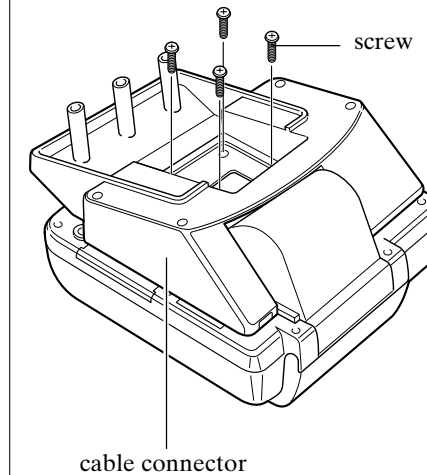

6 Installing the control unit

- Insert the cable connector coming out of the main unit into the cable inlet at the back of the control unit, until it clicks into place.

Note: Ensure that the connector is completely connected. If the connection is insufficient the unit will not work.

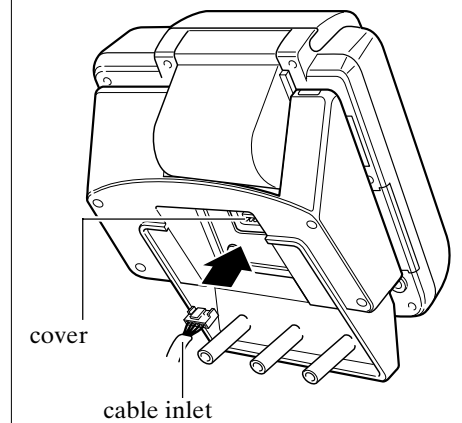

- Place the control unit on the main unit as illustrated and fasten it by the 4 screws.

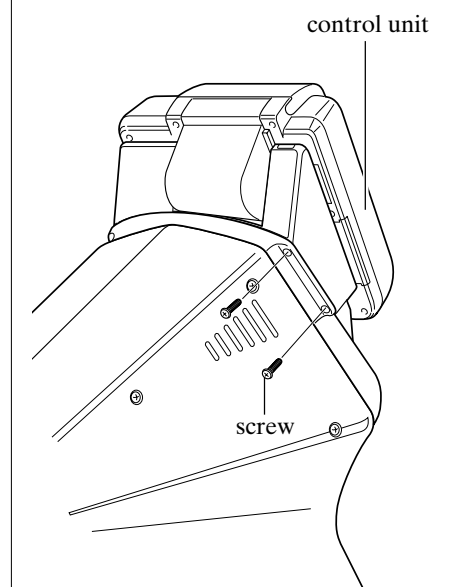

select switch

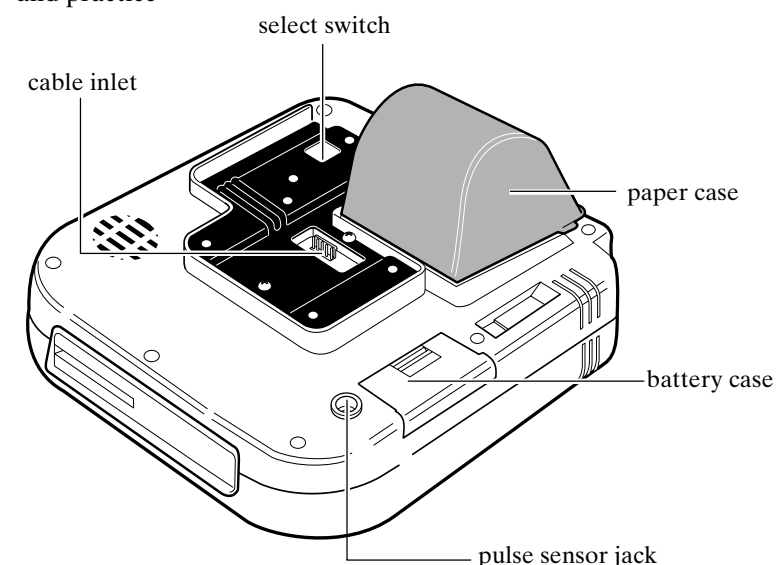
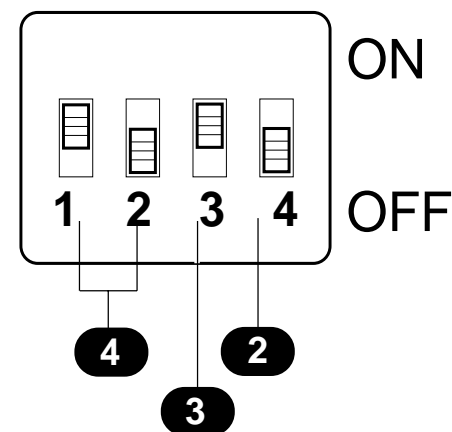

Starting up

How to Adjust each part

1 Level Adjustment

- Turn the level adjuster on the rear leg so that the unit is placed stably.
- When the indication line on the level adjuster is at the top, the rear leg is at the same level as the caster of the front leg.

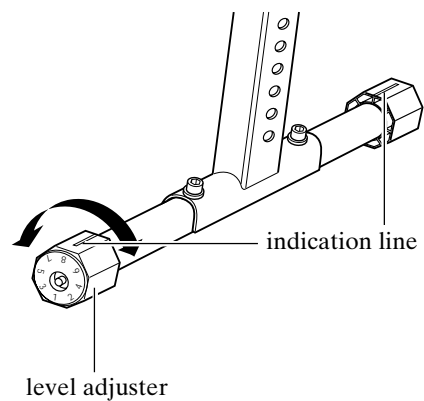

2 Adjusting Seat Position

- The seat position can be adjusted while pulling up the seat lock pin. When desired seat position is obtained, release the lock pin free and move the seat slightly and the lock pin will click into the nearest hole by spring pressure. Holes are provided at an interval of 3 cm (1-3/16").

Note: When sliding the seat, take care not to break the pulse sensor cable.

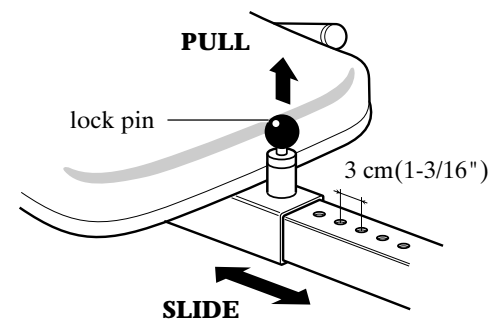

3 Adjusting Seat Height

- The seat height can be adjusted at your choice.
- Loosen and remove the seat height lock knob, supporting the seat pipe with the other hand.
- Move up or down the seat pipe to the desired height and screw-in the seat height lock knob. While tightening the knob lift the seat pipe slightly for easier screwing. Holes are provided at an interval of 3 cm (1-3/16").

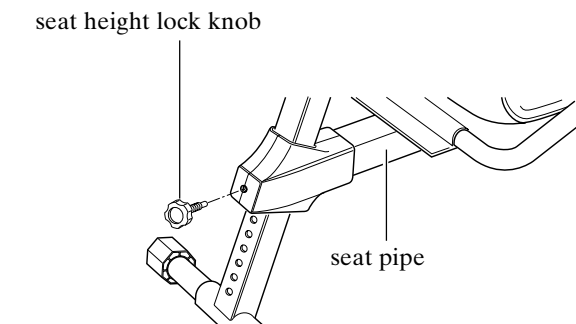

4 Adjusting Pedal Belts

- It is possible to adjust the pedal belt length according to your shoes size.



Recommended exercise posture

- Adjust the seat position as illustrated. Find the position where your knee is slightly bent when the pedal is at the farthest position.

Remark: When moving the main unit, lift the rear frame holding by the seat height lock knob, and roll the casters.

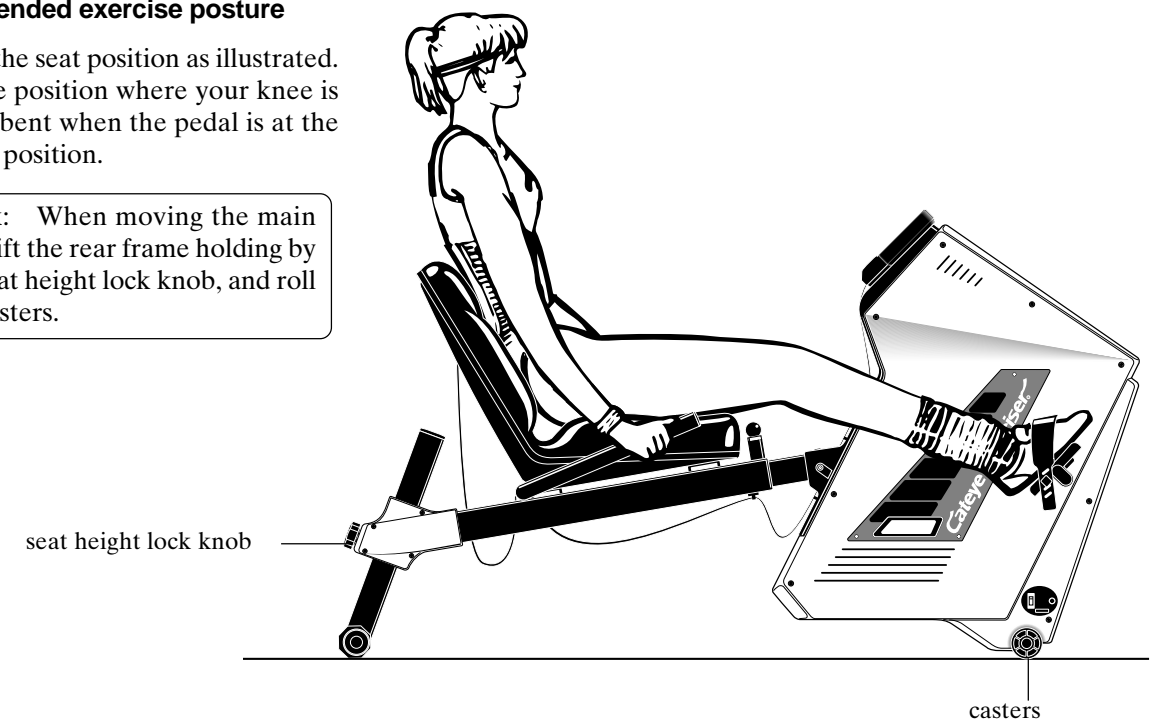

Starting up

Handling the pulse(earlobe) sensor

This model detects and displays your pulse rate during exercise by the pulse sensor from your earlobe. Being a sensitive electronic part, the pulse sensor must be handled with sufficient care.

1 Installing the pulse sensor

- Insert the pulse sensor plug into the pulse sensor jack on the back of the control unit, and hang the sensor cable on the cable hook.
- Attach the cable holder at the bottom of the seat pipe.
- Insert the sensor cable through the 3 cable hooks and cable holder. Hold the cable in position by attaching the sensor clip at the bend of the handlebar.
- Allow enough slack in cable under the seat pipe for seat adjustment.

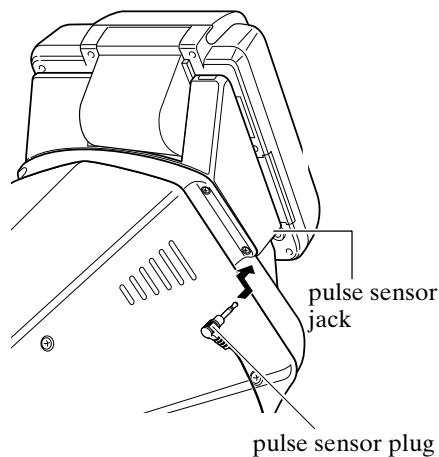

2 Use of sensor clip

- Always clip the pulse sensor to the sensor clip when it is not being used. This sensor clip can also be used to adjust the slack of the cable.

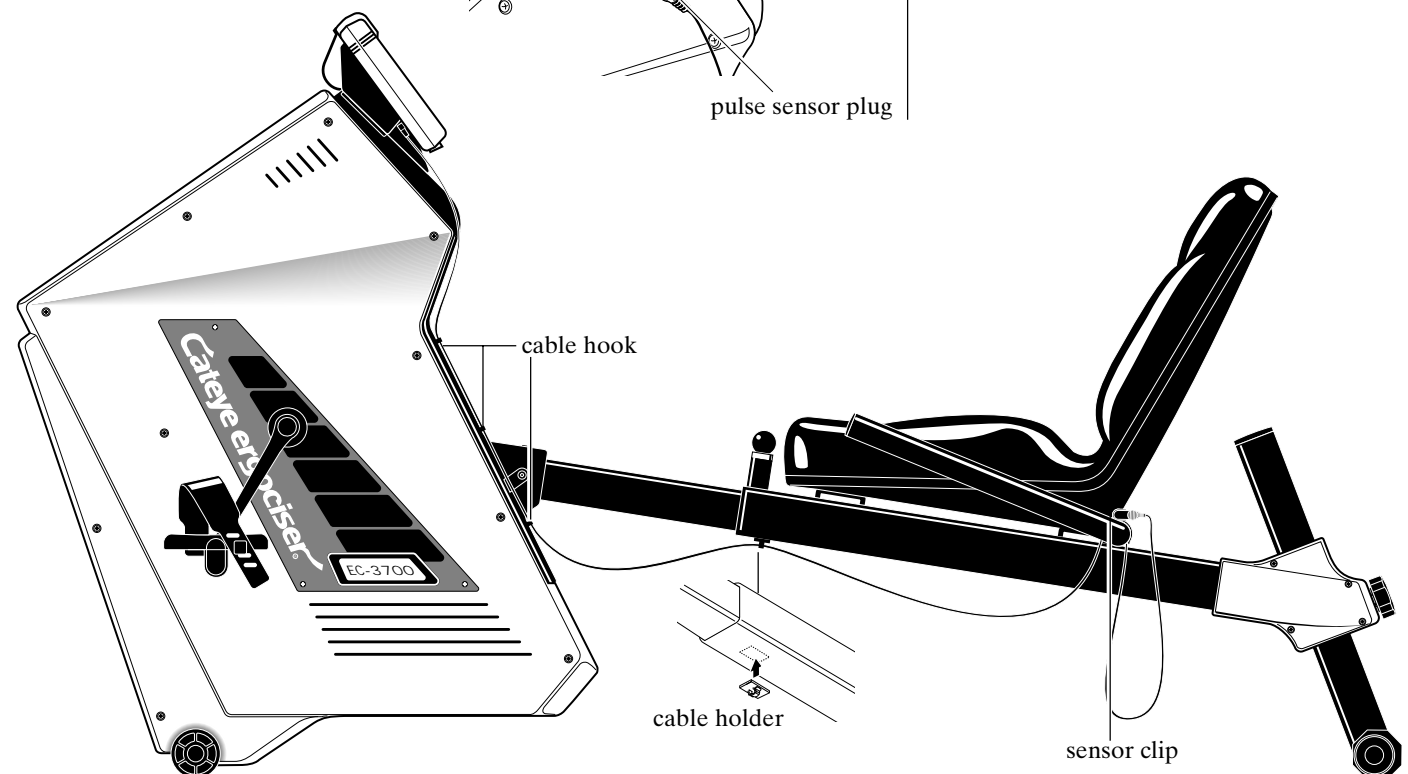
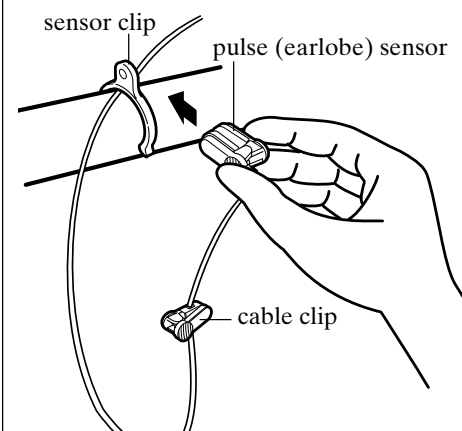



3 Using pulse sensor during exercise

- Clip the pulse sensor at the center of your either ear lobe.
- Ear rings or other ornaments must be removed before attaching the sensor and during exercise.
- When it is cold, massage your earlobe before use to improve blood circulation.
- Try not to change the position of the pulse sensor during the exercise.
- If the  symbol frequently lights up during use, remove once and re-attach the pulse sensor.
- Attach the cable clip to your clothes to prevent excessive swinging of the sensor cable.
- Always keep the pulse sensor attached on the sensor clip when it is not in use. This sensor clip can also be used to adjust the slack of the cable.
- When removing the pulse sensor after exercise, be sure to remove also the cable holder.

Caution: Treat the pulse sensor with care. The cable can be damaged if pulled strongly.

4 Checking the Pulse Sensor

- You can check the function of the pulse sensor on the LCD screen during the exercise.
- Remove the pulse sensor from your earlobe during exercise, then close it.
- The pulse sensor is normal if the pulse rate drops to zero and the  symbol goes out.
- If the pulse rate does not drop to zero or if the  symbol remains, the cable may be disconnected. If the cable proves to be disconnected, replace the pulse sensor with a new one (sold separately).

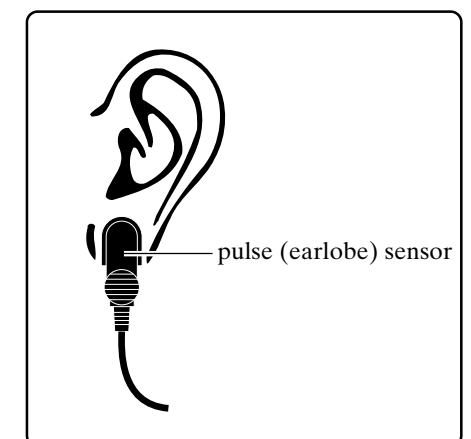
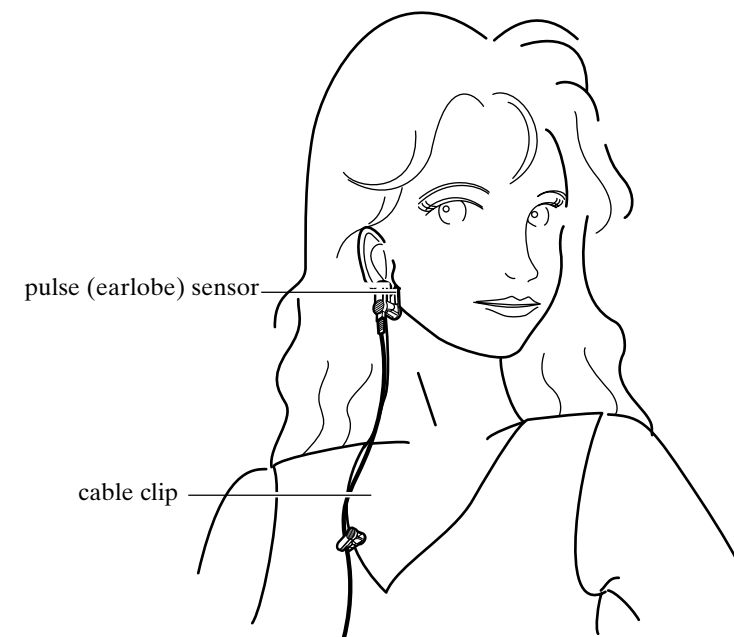

Starting up

Your first ride

1 Turn on power and attach pulse sensor

- Insert the DC connector into the AC adapter inlet at the right side of the main unit.
- Insert the plug of the AC adaptor into any household AC outlet (120V).

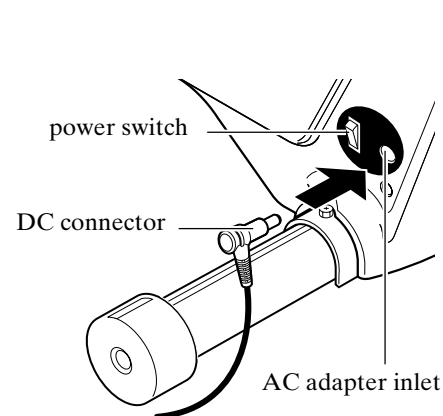

- Turn on power switch. The control unit should make a beep sound and "AUTO" symbol should appear on the screen.

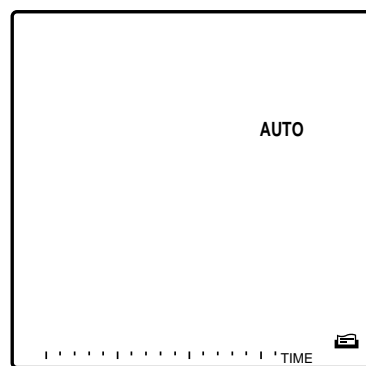

- Attach the pulse sensor to your earlobe. When it is cold, rub your earlobe to facilitate blood circulation before attaching the pulse sensor.

Caution: Do not use any AC adaptor other than the one supplied with the Model EC-3700.

2 Insert the start card (red card provided)

- Find the red card (start card) in the package of the EC-3700. Insert this card into the appropriate slot (card inlet) as shown in the diagram below.

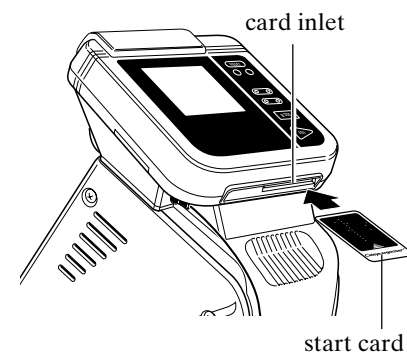

Caution: Use only the red card at this stage. It is a sample card with the exercise data already registered in it. The unit will not work with the black cards since they do not contain any data yet.

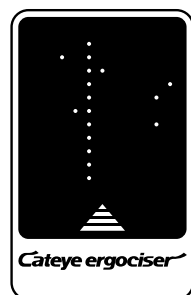

start card



Remark : You may change data at any time. The **O+** and **O-** buttons will raise or lower any of the numbers discussed above. Press the **MODE** button to move to the next number, which will flash on and off when it is eligible for changing. Now, however, the goal is to get you acquainted with Model EC-3700, so if you change any of the numeral values, please return them to their original setting.

3 Checking the screen display

- The display that appears on the screen should be as described below. If this display does not appear, pull the card out and slowly insert it again. The numbers in the display represent training conditions.

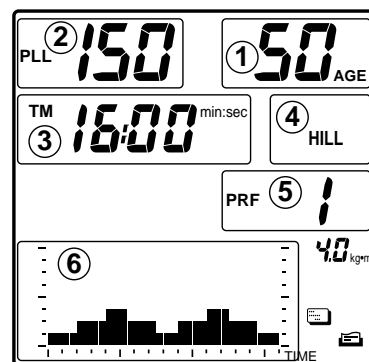

- ① Age is shown by the figure "50"
- ② "150" is the upper-limit pulse rate set by the machine (200-age). If this pulse rate is exceeded during training, an alarm will sound and the pedal resistance will drop to minimum (0.5kg·m).
- ③ Exercise time is shown by "16:00", which means 16 minutes.
- ④ "HILL" which is short for "hill profile training" shows the type of training to be engaged in.
- ⑤ "1" indicates the shape of the hill to be climbed. "1" is the gentlest slope.
- ⑥ Changes of pedal resistance are shown on the graph.

4 Press the **ADV** button to start

- Depress **ADV** button. This will activate the printer.
- Start pedaling at a low speed.
- When the printer stops, a display like that in the diagram below will appear on the screen. The numbers on this screen represent your own present condition, and they will keep changing as time goes on.

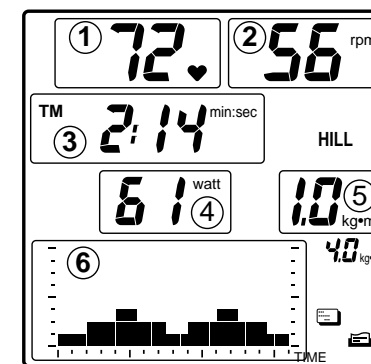

- ① Heartbeats per minute.
- ② Pedal revolutions per minute.
- ③ Elapsed time since start of training session.
- ④ Amount of working, expressed in watts. The higher the number, the more energy you are expending.
- ⑤ Pedal resistance (torque). The higher the number, the harder.
- ⑥ As time goes on, the blinking row in the graphic part will shift one by one toward the right hand. According to the position of the blinking row you can find how far you have progressed in the current session.

5 Calorie display

- Pressing the **MODE** button gives you the option of viewing a calorie consumption display (calorie consumed from the beginning of the present training session until now) instead of elapsed time.
- Now you are on the exerciser for your first ride. As you train, pedal resistance will change, energy expenditure will change, and your pulse rate will also change. The Model EC-3700 lets you keep track of all this information while you train.

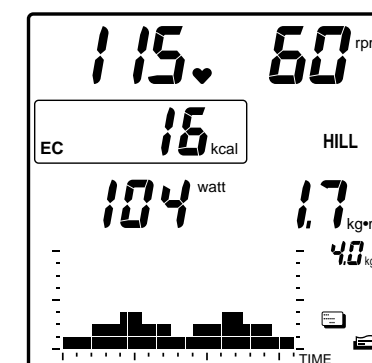

6 When you finish

- When 16 minutes have elapsed, a buzzer will sound and the training session will automatically stop.
- The printer prints out the E.C. (Energy Consumption) and then stops.
- You may stop exercise program at any time during workout by pressing **ADV** button twice.
- The liquid crystal display on the screen will return to initial display, "AUTO" alone flashing.
- The Model EC-3700 Cateye Ergociser™ function that we have explained up to this point is only the beginning. Let us move on to explanations of other functions.



The six programs of operation

1 Aerobic power measurement (physical fitness test)

- Over a period of 10 minutes, you will encounter three different levels of pedal resistance. Your pulse will change in response to the different levels of resistance, and this change in pulse will be used to calculate your overall fitness level, also expressed as MOU (VO₂ max). MOU stands for maximum oxygen uptake. The higher your overall fitness level, the greater your endurance.
- Your MOU value is compared with the MOU values of other people who are the same age and sex as you. You are given a physical strength number from 1 to 5 depending on how you rank.
- These results should give you a good idea of your own fitness level and help you to determine what sort of training program will be the most effective for you. For information on how to choose a training program, refer to "Your strength level and training index" on page 22~25 in the Operation section on this booklet.



2 Automatic training (training at a constant pulse rate)

- You set the pulse rate at which you want to exercise and the Model EC-3700 automatically adjusts pedal resistance to maintain that pulse rate. This is an ideal basic form of aerobic training.
- As you repeat the exercise at a certain pulse rate and make progress in your fitness level, you will be able to create a greater work intensity under the same pulse rate. Further, you will be able to try exercising at a higher target pulse rate.



3 Isopower training (training at a constant energy expenditure)

- The work rate or the figure for energy expenditure (watts) shown on the screen of the Model EC-3700 is calculated from pedal resistance (kg·m) and cadence (rpm).
- In isopower training, you set the desired work intensity in watts. The Model EC-3700 automatically adjusts the pedal resistance (kg·m) depending on your pedal cadence (rpm), so as to keep a constant work rate in watts.
- This type of training is also called constant load, and is often used in cardio-vascular rehabilitation.

Control range:
cadence: ----- 40~100 rpm
wattage: ----- 25~200 watts

Note: If you set your target wattage as under 50 watts, control limit of cadence (rpm) becomes under 100 rpm.



4 Interval training (exercise + relief periods)

- By switching back and forth between exercise and relief periods of varying length, interval training gives you the kind of program that professionals use to build their stamina and energy.
- On the model EC-3700, 3 patterns of interval training programs are preset for developing dashing power, speed, or your stamina respectively, PLUS one customized pattern for you to input your personal program.

TLD-1: dash strength training
(sprint power)
15 seconds exercise followed by a 45 second relief.

TLD-2: speed training
(anaerobic power)
30 seconds of exercise followed by a 60 second relief.

TLD-3: stamina training
(aerobic power)
60 seconds of exercise followed by a 30 second relief.

TLD-4: customized pattern

- Choose one of the above patterns, and adjust the level of intensity by specifying pedal resistance (torque: kg·m).
- During the exercise period (increased load portion of interval), you should pedal with your greatest effort, then you should pedal slower and lighter during relief period (lower load portion of interval).
- In the TLD-3 stamina training program, it is advisable to pedal fast enough in the exercise period to keep your pulse rate at 60~80% of the maximum pulse rate for your age. (Refer to page 22~23)
- By choosing TLD-4 customized pattern, you can write in your original pattern as desired. (See pages 40 and 41.)

TLD-1: dash strength training

TLD-2: speed training

TLD-3: stamina training

5 Hill profile training (training by cycling up mountains)

- Pedal resistance changes over time to simulate the effect of cycling in the mountains. All changes in pedal resistance are shown on the screen.
- The following eight types of mountain profiles plus one customized pattern are programmed.

PRF-1: the Apennines (Italy)

PRF-2: the Appalachian (U.S.A.)

PRF-3: the Cascades (U.S.A.)

PRF-4: the Pyrenees (France, Spain)

PRF-5: Mount Fuji (Japan)

PRF-6: the Rockies (U.S.A.)

PRF-7: the Alps (Switzerland)

PRF-8: the Himalayas (Nepal)

PRF-9: customized pattern

- The mountain profiles from 1 to 8 are arranged in order of ascending difficulty. Do not strain yourself, but rather enjoy the form of each mountain.
- Selecting PRF-9 customized pattern, you can create and input your original hill profile. (Also refer to pages 40 and 41.)
- Minimum training time is 16 minutes. If you set a longer training time, the mountain profiles will be stretched out horizontally.



PRF-1:
the Apennines

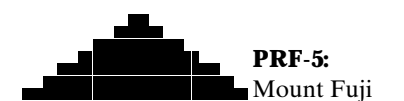

PRF-5:
Mount Fuji



PRF-2:
the Appalachian

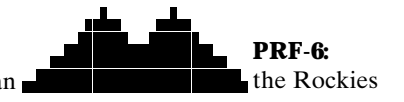

PRF-6:
the Rockies

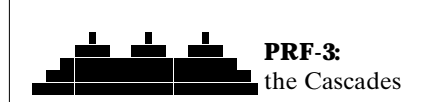

PRF-3:
the Cascades

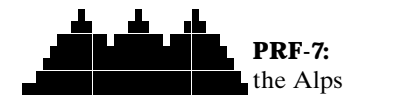

PRF-7:
the Alps

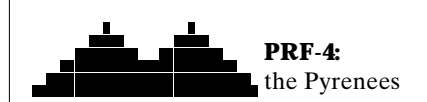

PRF-4:
the Pyrenees

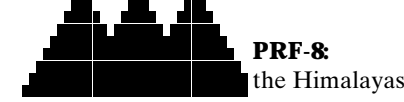

PRF-8:
the Himalayas

Upper Pulse Limit Alarm

- For your safety, the upper pulse limit alarm is provided in all the programs of the EC-3700. If your pulse rate exceeds this limit, the buzzer beeps and the pedal resistance automatically drops to the minimum of 0.5 kg·m.
- If this alarm is activated, the program is suspended at that point and enters the cool down phase, except in "Manual training" program in which you can continue the exercise using **⊕** button to set the desired torque again.

Starting up

Using your Cateye Ergociser™ without a data card

The red card you used on your first ride contains the data to select the type and condition of training. Without using this card, it is also possible to run through the same operations using the buttons on the control unit.

1 Switch on power supply

- Plug in the AC adaptor and turn on the switch at the right side of the main unit.
- In the screen "AUTO" appears blinking.

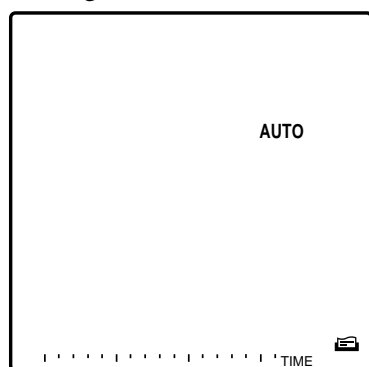

2 Select a training program

- With each press of the **MODE** button, the flashing indicator moves from one mode to another in the following order.

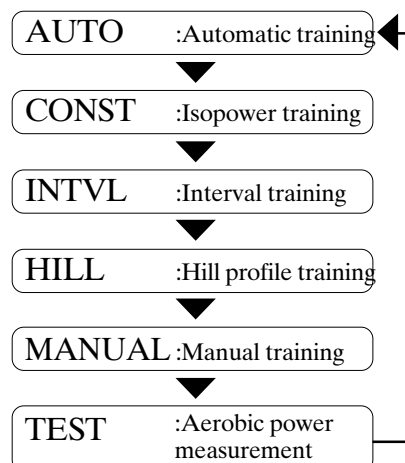

- On your first ride, you tried the hill profile training. This time choose "AUTO" as example.
- Press the **MODE** button until "AUTO" flashes again, then press **ADV** to lock in your choice.

3 Input training conditions

- The screen display will change to the one shown in the diagram here, with the number "40" flashing.

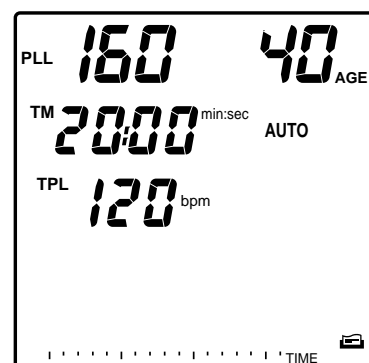

- You can raise or lower the flashing number by pressing either the **+0** or **0-** button. The **+0** and **0-** buttons change the tens column and the ones column of each number separately. For example, suppose you want to change the displayed age number from 40 to 52. Press **+0** once and **0-** two times. Has the number changed to "52"?

- With each press of the **MODE** button, the flashing indicator moves from one item to another in the following order.

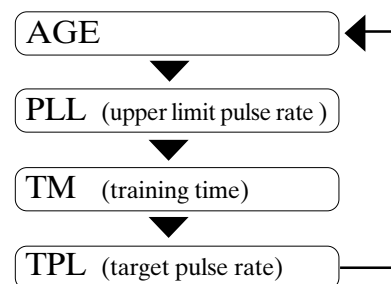

Remark: Conditions vary according to the training program. Upper limit pulse rate is automatically determined from your age, so there is no need to revise this number yourself, unless you have a particular purpose.

- Let's try changing the displayed target pulse rate from 120 to 115.
- Press the **MODE** button until "120" is flashing. You want to reduce the number by five, so press the **0-** button five times. Has the number changed to "115"?

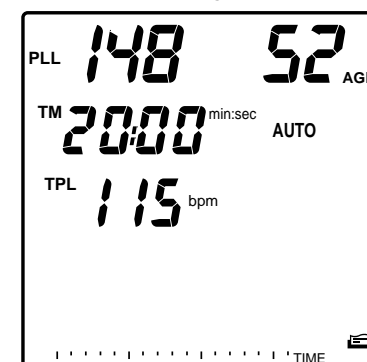

- The card is a tool for program choice and setting training conditions. It saves you the trouble of setting the same training conditions each time you use the exerciser. For instructions on how to make a card, please refer to page 42, "How to make a data card" in the Operation section.

4 Start training

- When you have set all the training conditions, press the **ADV** button. The printer will give a printout of training conditions. When this printout is complete, the screen display will change to the one similar to what is shown below. Then you can start pedaling.

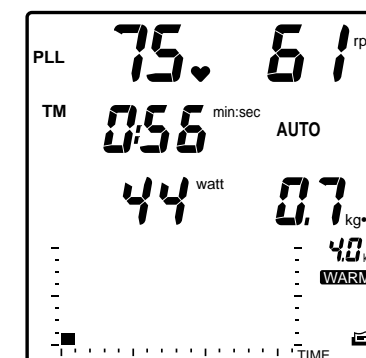

- The automatic training, isopower training, interval training and manual training programs all have a warm-up function. Pedal resistance increases slowly until you reach your target pulse rate (Automatic training) or for the first three minutes (all others). While the warm-up function is operating, **WARM** symbol will remain on the screen.
- By pressing the **MODE** button during the exercise, you can switch the display from elapsed time (TM min:sec) to calorie consumption (EC Kcal), and vice-versa.

5 At the end of training

- A buzzer will sound when the training time you have set is finished. If you wish, you can continue training even after this buzzer sounds.
- Whenever you want to stop training, before or after the buzzer sounds, push the **ADV** button once.
- The **COOL** symbol appears on the screen and the pedal resistance drops to the minimum of 0.5 kg·m. This is the cooling down function, which lasts for a maximum of 5 minutes.

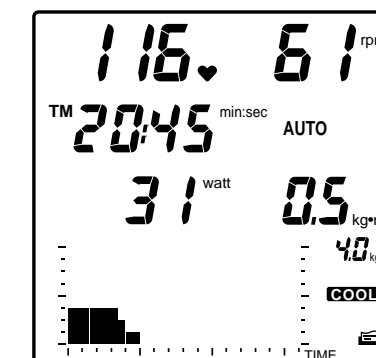

- At this stage review your workout data such as time and calorie consumption.
- Press the **ADV** button once more and the printer will give a printout of calories expended, then the display turns to the initial state. (If you stay in the cool down phase for a full five minutes, you do not have to push the **ADV** button.)
- You should now understand how to use the Model EC-3700 Cateye Ergociser™. Once you get used to the exerciser, you will probably want to refer to the Operation section for more detailed information on functions, etc.

Operation

- 1 Your strength level and training index
- 2 Aerobic power measurement (Physical fitness test)
- 3 Automatic training
- 4 Isopower (constant load) training
- 5 Interval training
- 6 Hill profile training
- 7 Manual training
- 8 Setting your own training pattern
- 9 How to make a data card

Your strength level and training index (1)

Purpose of Exercise

- Have you ever been out of breath after climbing a flight of stairs or after a brisk walk? When we are walking, running and even sleeping, our body is taking in oxygen and generating energy. Oxygen taken in by the lungs is sent to the entire body via the circulatory system. If the function of the circulatory system, i.e. aerobic power, is insufficient, we may experience being "out of breath" or experience yet other physical problems.
- We therefore perform "sports for the heart" (aerobic exercise), which causes the heart to work a little more a few times a week, thus increasing the oxygen supply to the body via the circulatory system. The purpose of exercise with the Ergociser is to improve both your physical strength and the functioning of the circulatory system: to improve our aerobic power.

Exercise Plan

- To effectively perform "sports for the heart" and to improve your aerobic power, it is necessary to exercise according to your age and physical fitness. If exercise exceeds your physical fitness level you only injure your body. On the other hand, if the exercise is insufficient, a positive effect cannot be expected.
- The Ergociser EC-3700 has 6 types of computer-controlled programs. One program is the "Aerobic Power Measurement Program". This test program evaluates your physical fitness level, while the other 5 programs are for actual exercise.
- The "Aerobic Power Measurement Program" evaluates your physical fitness level so that you can determine the training index and begin exercise based on the measured result. After exercising for a while (about 3 months), you become aware of the effect on your body. Test your physical fitness level again and gradually set a higher training index, thus maintaining and improving your physical fitness level. A special feature of the Ergociser™ EC-3700 is that it combines testing with exercise.

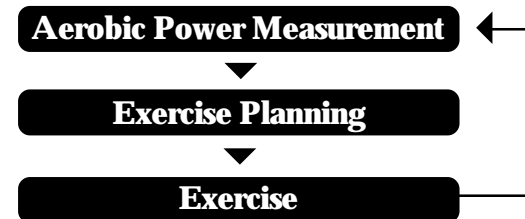

Exercise Frequency and Time

- At least 15 minutes are required for one exercise period, however if possible a 20 ~ 30 minute period is even better.
- To maintain your present condition, exercise at least twice a week, 3 times a week would improve your condition even more. The ideal however is to exercise every day or 5 ~ 6 times a week.

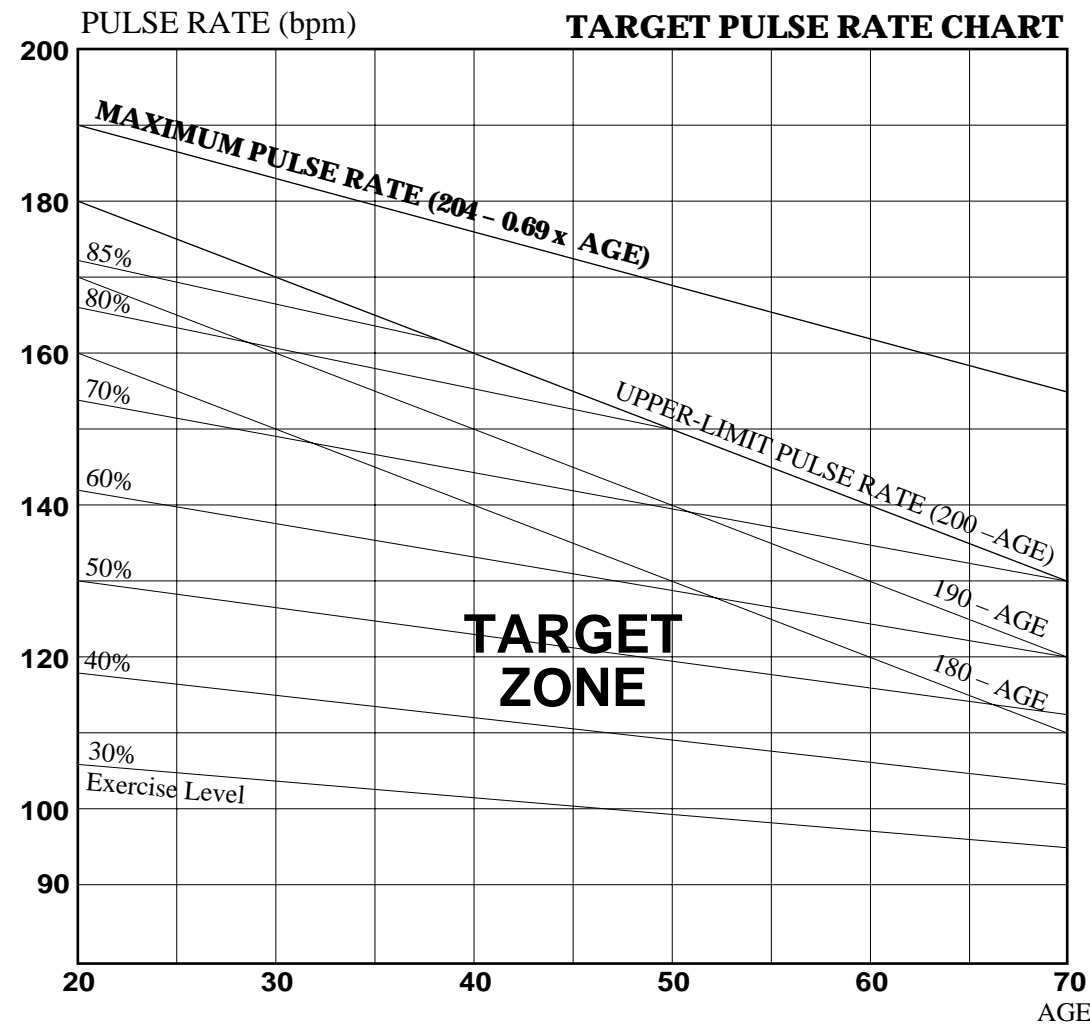

Note : You could also decide your target pulse rate more simply by deducting your age from a certain figure. For a beginner, for instance, it is recommendable to start with [160-age (approx. 30~50% depending on your age)], and gradually proceed to higher level such as [180-age (approx. 50~70%)]. It would be ideal to aim at [190-age] eventually.

Glossary of Terms

• Maximum Heart Rate

The heart rate increases according to the intensity of exercise, there is however a limit. The maximum heart rate that a person can sustain is called the "maximum heart rate". Generally the heart rate declines as we get older, this differs however between individuals, and is largely due to how much one exercises.

• Difference Between the Heart Rate and Pulse Rate

The heart rate is the rate of the heart beat per minute measured by an electrocardiograph. On the other hand, the pulse rate is measured as follows.

- 1) By palpating an artery near the skin surface, such as the carotid artery, measure the pulse count of a blood vessel.
- 2) Transmit a sensor light to an earlobe or finger tip, and measure the pulse count via the subtle changes of the sensor light transmission caused by the heart beat.

Although the measurement principle and method are different, both the heart and pulse rates have the same value per minute, and are therefore regarded as synonymous.

Since earlobes move very little during exercise and are not influenced very much by physical movement, it is appropriate to use an earlobe to measure the pulse rate during exercise. The Ergociser EC-3700 therefore measures the pulse rate by detecting changes in the circulation of the earlobe.

• Pulse Limit

As a standard maximum heart rate, "220-Age", "204-0.69 x Age", etc. are used. With the Ergociser EC-3700, a somewhat lower value is used: "200-Age". This pulse limit allows a person to safely exercise.

• Target Pulse Rate

The pulse rate to maintain during exercise as a target is called the "target pulse rate". In the "Auto training" program, this pulse rate is automatically maintained. However, even with other programs, always be conscious of your target pulse rate during exercise. Refer to the illustration on the left.

• Exercise Level Based on the Pulse Rate

The pulse rate increases according to the intensity of the exercise. In other words, the pulse rate during exercise is a barometer for the exercise level. The exercise level can be determined in percentages by the following formula.

$$\text{Exercise Level (\%)} = \frac{\text{Pulse rate during exercise} - \text{Pulse rate at rest}}{\text{Maximum heart rate} - \text{Pulse rate at rest}} \times 100$$

Therefore, if you want to discern the target of the exercise level from the pulse rate (target pulse rate), you can calculate as follows.

$$\text{Target pulse rate} = (\text{maximum heart rate} - \text{pulse rate at rest}) \times \frac{\text{Exercise Level (\%)}}{100} + \text{pulse rate at rest}$$

Your strength level and training index (2)

Physical Fitness Level and Training Index

1 Automatic Training

The "Aerobic power measurement" program evaluates your physical fitness level according to 5 levels and, it also evaluates your maximum oxygen uptake with an estimated value. Based on the result, you can choose your own training level (program type and exercise intensity) from the following index.

- In this program, the exercise intensity is set by the target pulse rate (beats per minute: bpm). Select your target pulse rate from the following table, based on your age and physical fitness level (PFL) from 1 to 5.
- If the target you select is difficult, reduce the target pulse rate by 10 bpm. You need not work hard from the beginning, continuing is most important.
- This table is arranged so that even people who have not exercised so much can benefit. The targets in this table may be too easy for people who exercise often. If you have confidence, increase your target in 10 bpm units, referring to the target zone in the illustration on page 22 ~ 23.
- Exercise for at least a 15 minute period. If possible a 20 ~ 30 minute period is even better.

PFL	20~30s	40~50s	over 60s
1	110 bpm	100 bpm	95 bpm
2 ~ 3	120 bpm	110 bpm	105 bpm
4 ~ 5	130 bpm	120 bpm	115 bpm

2 Isopower Training

- In this program the exercise intensity is set by the work rate: wattage. Select the target wattage from the table shown below, according to your PWCmax. value provided by the Aerobic Power Measurement.
- If the selected wattage proves too hard for you, try again at the level 10 watts lower. When it becomes easy enough, raise the target by 10 watts.
- Exercise for at least a 15 minute period. If possible a 20 ~ 30 minute period is even better. Since warm up takes 3 minutes, set your actual exercise time to "actual exercise time + 3 minutes".

PWCmax	TargetWattage	PWCmax	TargetWattage
100 watt	40 watt	220 watt	90 watt
120 watt	50 watt	240 watt	95 watt
140 watt	55 watt	260 watt	105 watt
160 watt	65 watt	300 watt	120 watt
180 watt	70 watt	350 watt	140 watt
200 watt	80 watt	400 watt	160 watt

3 Interval Training

- In this program, select one of the 4 patterns (TLD 1 ~ 4) depending on the power you want to improve, then set the exercise intensity by the pedal resistance (torque: kg-m.).
- This program is for people with a long history of exercise.
- The following is a reference. Settings should match your physical fitness level and purpose.

- Exercise for at least a 15 minute period. If possible a 20 ~ 30 minute period is even better. Since warm up takes 3 minutes, set your exercise time to "actual exercise time + 3 minutes".
- Depending on the physical fitness level and purpose, some people may exercise at a higher pulse limit than the value calculated by age. In such instances, set the pulse limit slightly higher, being conscious of your own physical condition.
- If you select the stamina aerobic power development pattern (TLD 3), maintain your pulse rate in the 60 ~ 80% range of the illustration on page 22 ~ 23.

TLD1		TLD2		TLD3	
PWCmax	Pedal Torque	PWCmax	Pedal Torque	PWCmax	Pedal Torque
150 watt	1.5 kg-m	150 watt	1.4 kg-m	150 watt	1.3 kg-m
200 watt	2.0 kg-m	200 watt	1.8 kg-m	200 watt	1.7 kg-m
250 watt	2.5 kg-m	250 watt	2.3 kg-m	250 watt	2.1 kg-m
300 watt	3.0 kg-m	300 watt	2.8 kg-m	300 watt	2.6 kg-m
350 watt	3.5 kg-m	350 watt	3.2 kg-m	350 watt	3.0 kg-m
400 watt	4.0 kg-m	400 watt	3.7 kg-m	400 watt	3.5 kg-m

4 Hill Profile Training

- Merely select one of the 9 patterns of this program. Try different hill profiles (shape of the mountain) in a range where you don't feel too much difficulty. The exercise intensity can also be adjusted by pedaling slower or faster depending on the changes of pedal resistance.
- First, choose the most suitable preference (PRF) according to your PWCmax value, from the table shown below.
- The exercise time is initially set as 16 minutes, but you can revise it up to 99 minutes at maximum.

PWCmax	140 watt	175 watt	195 watt	240 watt	290 watt	310 watt	330 watt	~
ExercisePattern(PRf)	1	2	3	4	5	6	7	8
CalorieConsumption	75 kcal	95 kcal	110 kcal	120 kcal	130 kcal	140 kcal	155 kcal	200 kcal

- The calorie consumption provided above is based on the cadence of 60 rpm and the exercise time of 16 minutes. The calorie expenditure will vary in proportion with the pedal cadence and the exercise time.

5 Manual Training

- In this program, the exercise intensity is set by the pedal resistance (torque: kg-m.).
- Exercise for at least a 15 minute period. If possible a 20 ~ 30 minute period is even better. Since the warm up takes 3 minutes, set your exercise time to "actual exercise time + 3 minutes".

PWCmax	PedalTorque(kg-m)			PWCmax	PedalTorque(kg-m)		
	50 rpm	70 rpm	90 rpm		50 rpm	70 rpm	90 rpm
120 watt	0.9	0.7	0.5	240 watt	1.9	1.3	1.1
140 watt	1.1	0.8	0.6	260 watt	2.0	1.5	1.1
160 watt	1.2	0.9	0.7	280 watt	2.1	1.6	1.2
180 watt	1.4	1.0	0.8	300 watt	2.3	1.7	1.3
200 watt	1.6	1.1	0.9	350 watt	2.7	1.9	1.5
220 watt	1.7	1.2	1.0	400 watt	3.1	2.2	1.7

Aerobic power measurement (1)

1 Select the Aerobic Power Measurement Program

- For program selection see the Starting up section page 18.

2 Input Conditions

- Input your age, pulse limit, weight and sex. The initial display prior to input is as in the drawing. The numeric for age is blinking.

Initial	Value	Setting Range
Age	40	10~ 99
Pulse Limit	160 bpm	80~ 200 bpm
Weight	130 lb	
Sex	Male	

- The pitch sound to adjust your cadence at 60 rpm (rings every half second) is set "ON".
- There is no graphic display yet in the LCD.
- Press the **MODE** button to change the blinking numeric.
- You can increase or decrease the blinking numeric by pressing the **+**/**-** button.

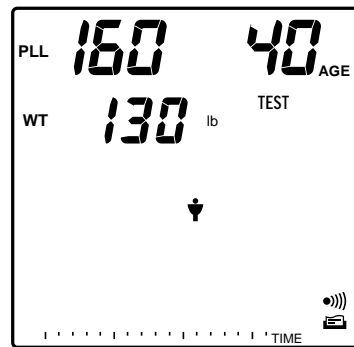

3 Start Program

- After setting your conditions, adapt the earlobe pulse sensor and press **ADV** button to start program.
- After printing out the conditions the LCD changes as in the drawing.
- The word "READY" will be displayed on LCD panel. Wait still for one minute.
- After one minute has elapsed, the buzzer sounds and the pitch sound begins. Then start pedaling according to the pitch sound.

Note: You can cancel the pitch sound by pressing the **OFF** button. If the **OFF** symbol is on the LCD, the pitch sound is ON, and if not pitch sound is OFF. Pressing the pitch sound button toggles ON/OFF.

- The initial workload (pedal torque) is indicated in blinking dot in the graphic section of the LCD. One dot along the horizontal axis indicates 30 seconds, and one along the vertical axis 0.5 kg-m. At every 30 seconds, the row of dots will increase by one towards the right of the graphic display, with the last row blinking.
- At the 4th and 7th minutes the pedal torque will increase depending on your pulse rate at that time. The increased torque of 2nd and 3rd stages will be indicated in dots time after time in the graphic part.

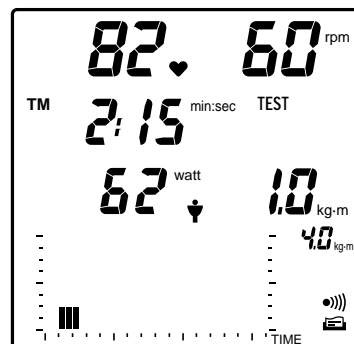
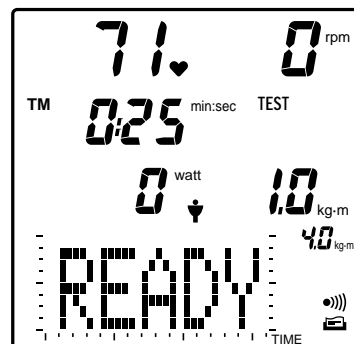

4 Test Result Display, Cool Down

- The buzzer sounds ten minutes later and the test result is displayed on the LCD, and also printed out. The program then enters the 5 minute cool down phase and the **COOL** symbol lights up, however the LCD still displays the test result. Only the calorie consumption data on LCD panel will be updated if you keep pedaling.

Note: When the upper pulse limit alarm is activated
If the upper pulse limit alarm is activated while the elapsed time is within 4 minutes, making the buzzer beep and dropping the resistance to the minimum of 0.5 kg-m, the test result is not displayed. If the upper pulse limit alarm is activated after the elapsed time exceeds 4 minutes, the result is displayed based on the progress up to that point. In this case the result is distinguished from normal results by adding "=" to the printing data of the printer.

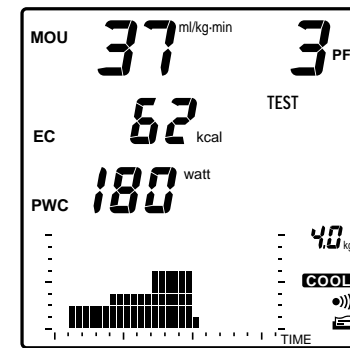

5 End Program

- If the 5 minute cool down phase elapses or if you press the **ADV** button, the buzzer sounds and the program ends.
- The LCD returns to the initial screen.
- If you are completely finishing the exercise, be sure to turn the power off by the switch at the right side of the main unit.

Sample print out

```

*** ERGOBIOSER T.M ***
FITNESS DATA
"TEST"
DATE '93. 3.27
NAME
SEX M
AGE 40
WEIGHT (lb) 130
PULSE LT. 160
TH CDC WATT PULSE
0 0 0 81
1 0 0 82
2 58 61 90
3 57 58 99
4 61 63 96
5 60 111 106
6 60 111 116
8 59 109 119
7 56 57 99
8 57 152 126
9 62 165 148
10 62 165 159
E.C. = 61 KCAL
PWC MAX = 180 W
MOU = 37 ML/KG.MIN
PFL = 3 RYER
    
```

- Shows that the Aerobic Power Measurement program has been performed.
- Date of execution
- Name: Put down your name in the blank.
- Sex : M = Male, F = Female
- Age
- Weight (lb or kg)
- Upper limit pulse rate
- Elapsed time (minute): printed every 30 seconds
- Cadence
- Work rate (watt)
- Pulse rate
- Pulse rate chart
- One minute before exercise: shows the pulse rate at the rest.
- 1st stage
- 2nd stage
- 3rd stage
- Calorie consumption
- Maximum physical capacity (PWCmax): the greater, the better.
- Maximum Oxygen uptake (MOU): the greater, the better.
- 5 rank physical fitness level

Aerobic power measurement (2)

Physical Fitness Level (PFL)

- There are five physical fitness levels: 1 ~ 5. These levels are relative evaluations that compare your maximum oxygen uptake (MOU), estimated by the aerobic power measurement program, with the values of other people of the same age and sex (Physical Fitness Level Test Table).
- Ergociser™ EC-3700 stores the following physical fitness level test table, which can be selected by the selector switch on the back panel of the control unit. (See page 8)

Physical Fitness Level Test Table by Maximum Oxygen Uptake (MOU)

- 5: Excellent
- 4: Good
- 3: Average
- 2: Fair
- 1: Poor

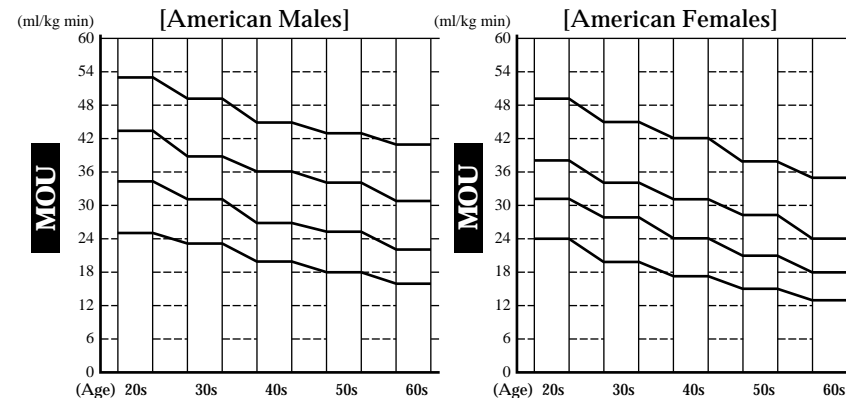

Maximum Oxygen Uptake (MOU)

- MOU is widely used as an index for total physical endurance. MOU indicates the amount of oxygen one can intake at the limit of their physical work capacity. In the Ergociser™ EC-3700, MOU is calculated based on the maximum physical work capacity (PWC max.) explained below, assuming that
1 litre of oxygen corresponds to 5.0 Kcal, and
the human body efficiency rate for a bicycle exercise is 23%

Maximum Physical Work Capacity (PWC max.)

- In the Ergociser™ EC-3700 "Aerobic power measurement" program the weight of the pedals are changed at 3 levels, and the pulse rate at the end point of each level is measured. Based on the result, the relationship between the work rate (wattage) and the pulse rate is analyzed by linear regression. Extend the regression line until reaching the maximum heart rate (=204-0.69 x age) which is estimated by age. The work rate (wattage) of this point becomes the maximum physical work capacity.
- PWC max. safely estimates how much exercise is possible at the limit of physical work capacity, that is, at maximum heart rate without performing actual exercise.

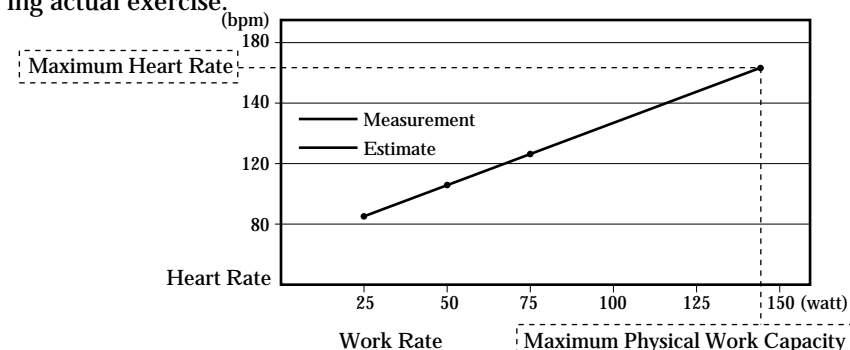

Test Protocol

- In the "Aerobic power measurement" program of the EC-3700, the workload (pedal resistance: torque) for the subsequent stage is determined depending on your pulse rate at the previous stage. The workload (pedal resistance: torque) will be increased along one of the routes illustrated below, depending on your pulse rate™ during the program.
- The pulse rates specified below represent the protocol for a person of 20 years. For the people over 20, the borderline of pulse rate will be adjusted by the age adjustment coefficient (K), which is obtained by the following formula:

$$K = \frac{204 - 0.69 \times \text{Age}}{204 - 0.69 \times 20}$$

- For people over 60 years, the coefficient (K) is calculated as 60.

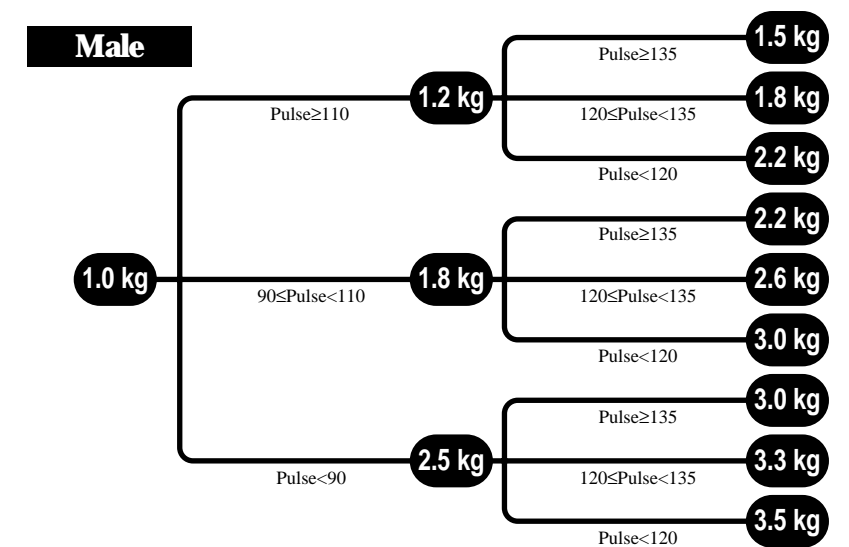

Remark: The load change for males over 50 years of age is the same as for females.
When the age is less than 20, the load changes as if the age were 20.

Automatic training

1 Select the Automatic Training Program

- For program selection see the Starting up section page 18.

2 Input Conditions

- Input age, pulse limit, exercise time and the target pulse rate. The initial display before input is as in the drawing, with the numeric for age blinking.

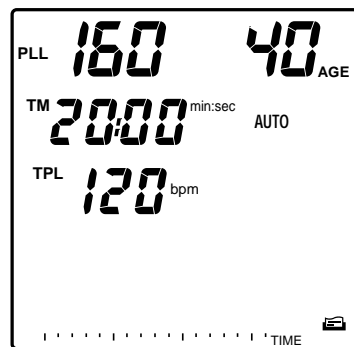

	Initial Value	Setting Range
Age	40	10~ 99
Pulse Limit	160 bpm	80~ 200 bpm
Exercise Time	20 min	0~ 99 min
Target Pulse Rate	120 bpm	60~ 180 bpm

- The pitch sound to adjust your cadence at 60 rpm (rings every half second) is set "OFF".
- There is no graphic display yet in the LCD.
- You can increase or decrease the blinking numeric by pressing the \oplus \ominus buttons.
- Press the **MODE** button to change the blinking numeric.

3 Start Program

- After setting your conditions, adapt the earlobe pulse sensor and depress **ADV** button to start program.

4 Start / Warm Up

- After printing out the conditions, the LCD changes as in the drawing.
- The initial workload (pedal torque) is indicated in blinking dot in the graphic section of the LCD. One dot along the horizontal axis indicates 30 seconds, and one along the vertical axis 0.5 kg-m. At every 30 seconds, the row of dots will increase by one towards the right of the graphic section, with the last row blinking.
- The pedal resistance increases gradually, so that the pulse rate goes up toward the target pulse rate.
- The **WARM** symbol remains until your pulse rate gets close to the target pulse rate.

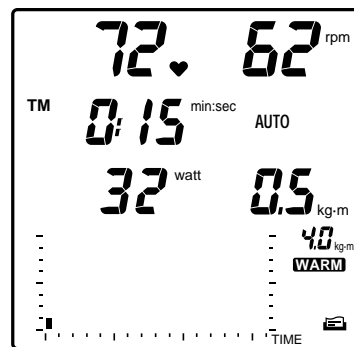

5 Exercise Maintaining the Target Pulse Rate

- After the **WARM** symbol has gone out, during exercise every time the pulse rate digresses ± 3 bpm from the target, the load changes 0.1 kg-m, keeping your pulse rate close to the target pulse rate.

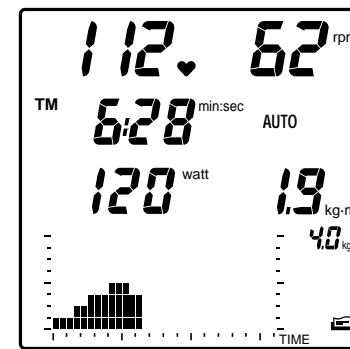

Note: When the pulse rate is "0" (when the earlobe sensor is removed) or when the pedal cadence is "0" (when not exercising) the pedal resistance does not change.

Remark 1: You can increase or decrease the pedal resistance by pressing the \oplus \ominus buttons.

Remark 2: The graphic section will display the torque pattern for maximum 16 minutes. At the end of 16 minutes period, torque pattern once disappear and the actual torque at that moment will be displayed flashing at the left end of the section.

6 Finish Exercise Cool Down

- The buzzer sounds at the specified time. If you press the **ADV** button, the program enters a 5 minute cool down phase and the **COOL** symbol lights up, then the pedal resistance becomes the minimum of 0.5 kg-m.

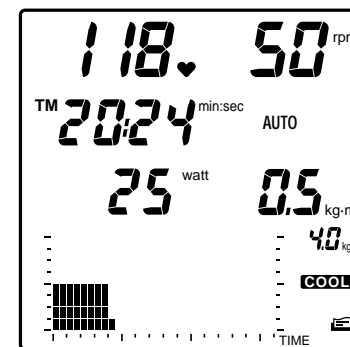

Note: Even if the buzzer sounds the program does not enter the cool down phase unless you press the **ADV** button.

- The LCD still displays the same exercise data.

7 End Program

- If the 5 minute cool down phase has elapsed or if you press the **ADV** button, the buzzer sounds and the program ends. The calorie consumption is printed out, and the LCD returns to the initial screen.
- If you are completely finishing the exercise, be sure to switch off the main unit.

Sample print out

```

*** ERGOCISER T.M ***
FITNESS DATA
" AUTO "
DATE '93.10.12
NAME
AGE 40
TG.PULSE 120
PULSE LT. 160
TM CDC WATT PULSE
0
59 30 81
1 59 42 83
2 59 53 90
2 59 55
    
```

- Shows that the Auto training program has been preformed.
- Target pulse rate
- Upper limit pulse rate

```

101
25 180
51 20 90
25 50 20 90
    
```

- Calorie consumption

Isopower (constant load) training

1 Select the Isopower Training Program

- For program selection see the Starting Up section page 18.

2 Input Conditions

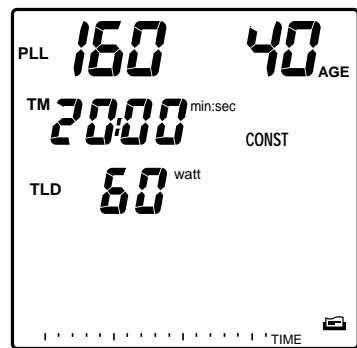

- Input age, pulse limit, exercise time and set wattage. The initial display prior to input is as in the drawing. The numeric for age is blinking.

	Initial Value	Setting Range
Age	40	10~ 99
Pulse Limit	160 bpm	80~ 200 bpm
Exercise Time	20 min	0~ 99 min
Set Wattage	60 watts	25~ 200 watts

- The pitch sound to adjust your cadence at 60 rpm (rings every half second) is set "OFF".
- There is no graphic display yet in the LCD.
- You can increase or decrease the blinking numeric by pressing the **+** or **-** buttons.
- Press the **MODE** button to change the blinking numeric.

3 Start Program

- After setting your conditions, adapt the earlobe pulse sensor and depress **ADV** button to

start program.

Start / Warm Up

- After printing out the conditions, the LCD changes as in the

4 drawing.

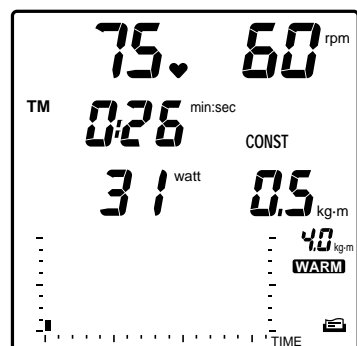

- The initial workload (pedal torque) is indicated in blinking dot in the graphic section of the LCD. One dot along the horizontal axis indicates 30 seconds, and one along the vertical axis 0.5 kg-m. At every 30 seconds, the row of dots will increase by one towards the right of the graphic section, with the last row blinking.
- For the 3 minutes warming up time after starting exercise, pedal resistance will gradually increase and **WARM** mark appears on the panel.

Note: During the warm up, the pedal resistance is increased so as to reach the set wattage in 3 minutes provided you pedal at 50 rpm. If you pedal faster than 50 rpm and reach the set wattage earlier than 3 minutes, the warm up is finished at that moment.

Remark: If you first press the **MODE** button, and holding it down press the **ADV** button to start the program, instead of just pressing the **ADV** button, you can skip the warm up phase and start the exercise at the preset wattage from the scratch.

5 Exercise at Constant Wattage

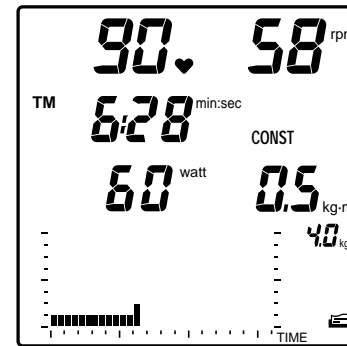

- After the **WARM** symbol goes out, the pedal resistance (torque kg-m) increases or decreases according to the pedal cadence. During exercise the pedal resistance (torque: kg-m) changes in 0.1 kg-m units to maintain the set value for wattage.
- Target wattage can be changed during exercise by pressing either **+** or **-** button. The new target wattage will be displayed for 2 seconds in place of the current wattage.

Note: For calculation purposes, pedal cadence under 40 rpm is regarded as 40 rpm, and pedal cadence over 100 rpm is regarded as 100 rpm.

Remarks: The graphic section will display the torque pattern for maximum 16 minutes. At the end of the 16 minutes period, the torque pattern once disappear and the actual torque at that moment will be displayed flashing at the left end of the section.

6 Finish Exercise Cool Down

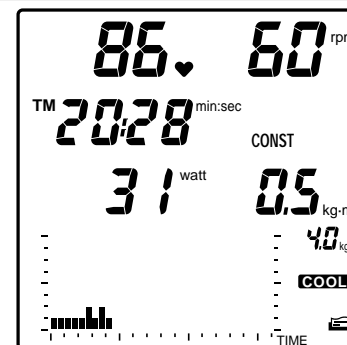

- The buzzer sounds at the specified time.
- If you press the **ADV** button, the program enters a 5 minute cool down phase and the **COOL** symbol lights up. Then the pedal resistance becomes the minimum of 0.5 kg-m.

Note: Even if the buzzer sounds, the program does not enter the cool down phase unless you press the **ADV** button.

- The LCD still displays the same exercise data.

7 End Program

- If the 5 minute cool down phase has elapsed or if you press the **ADV** button, the buzzer sounds and the program ends. The calorie consumption is printed out, and the LCD returns to the initial screen.
- If you are completely finishing the exercise, be sure to switch off the main unit.

Sample print out

```

*** ERGOEXER T.H ***
FITNESS DATA
"CONST"
DATE '93.10.12
NAME
AGE 40
LOAD 60
PULSE LT. 160

TH CDC WATT PULSE
0 60 31 60 #
1 60 37 64 #
2 59 42 64 #

```

Shows that the Isopower (constant load) training program has been performed.

Set wattage

Upper limit pulse rate

```

    59 38 63 #
    60 31 63 #
    25 60 31 63 #
E.C. = 91 KJ/L

```

Calorie consumption

Interval training

1 Select Interval Training Program

- For program selection see the Starting up section page 18.

2 Input Conditions

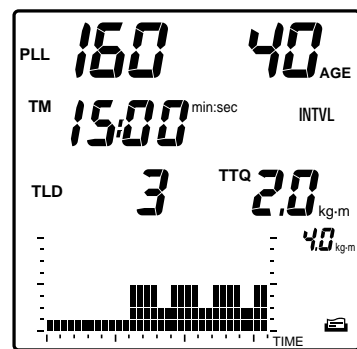

- Input age, pulse limit, exercise time, set torque and the exercise pattern.
- The initial display prior to input is as in the drawing. The numeric for age is blinking.

	Initial Value	Setting Range
Age	40	10 ~ 99
Pulse Limit	160 bpm	80 ~ 200 bpm
Exercise Time	15 min	0 ~ 99 min
Target Torque Value	2.0 kg-m	0.5 ~ 4.0 kg-m
Exercise pattern	3	1 ~ 4

- The pitch sound to adjust your cadence at 60 rpm (rings every half second) is set "OFF".
- The load pattern is displayed in the graphic section according to the selected exercise pattern and set torque value.
- You can increase or decrease the blinking numeric by pressing the $\odot+\odot$ $\odot-\odot$ buttons.
- Press the **MODE** button to change the blinking numeric.

3 Start Program

- After setting your conditions, adapt the earlobe pulse sensor and depress **ADV** button to start program.

4 Start / Warm Up

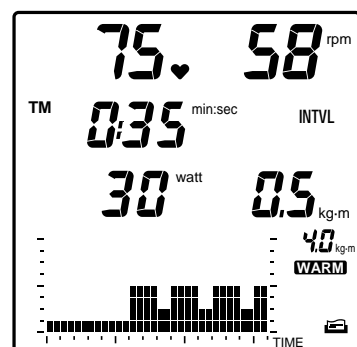

- After printing out the conditions, the LCD changes as in the drawing.
- Load pattern is displayed in the graphic section, and the dot at the far left is blinking. 1 dot in the horizontal axis indicates 15 seconds; 1 dot in the vertical axis indicates 0.5 kg-m.
- When 15 seconds is over, the dot to the immediate right will start blinking. With the lapse of time, the blinking row will move to the right. The position of the blinking dots determines where you are in the interval pattern.
- During the first 3 minutes of warm up, the pedal resistance gradually increases and the **WARM** symbol lights.

Note: After three minutes, the pedal resistance (torque value: kg-m) reaches about a half of the set torque value.

5 Exercise

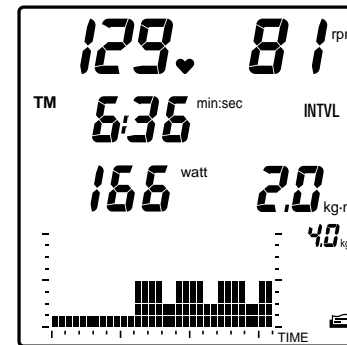

- After the **WARM** symbol goes out, the pedal resistance (torque kg-m.) change periodically according to the exercise pattern.
- During the exercise period (higher load portion of interval), you should pedal with your greatest effort, then you should pedal slower and lighter during relief period (lower load portion).
- In the TLD-3 stamina training program, it is advisable to pedal fast enough in the exercise period to keep your pulse rate at 60~80% of the maximum pulse rate for your age. (Refer to page 22 ~ 23)

6 End Exercise Cool Down

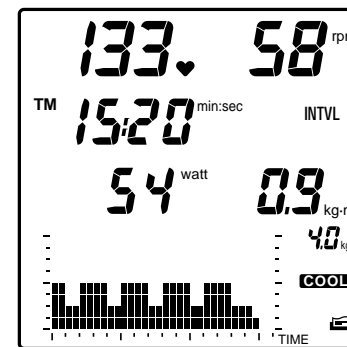

- The buzzer sounds at the specified time.
- If you press the **ADV** button, the program enters a 5 minute cool down phase and the **COOL** symbol lights, then the pedal resistance becomes the minimum of 0.5 kg-m.

Note: Even if the buzzer sounds, the program does not enter the cool down phase unless you press the **ADV** button.

- The LCD still displays the same exercise data.

7 End Program

- If 5 minutes of cool down elapses or if you press the **ADV** button, the buzzer sounds and the program ends.
- Calorie consumption is printed out, and the LCD returns to the initial screen.
- If you are completely finishing the exercise, be sure to switch off the main unit.

Sample print out

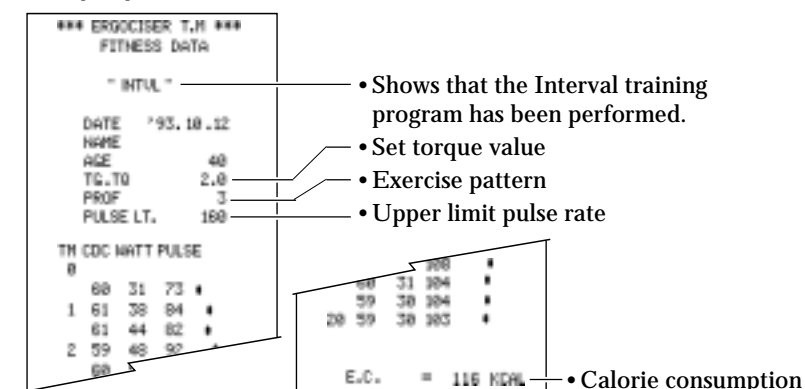

Exercise Pattern

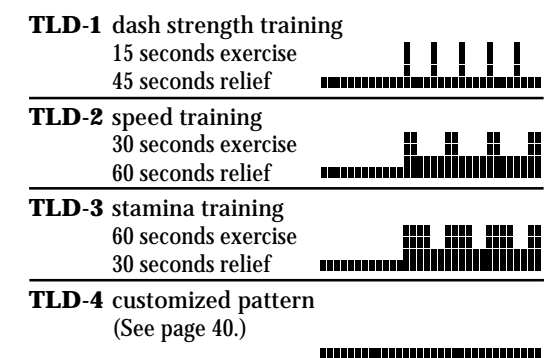

Hill profile training

1 Select the Hill Profile Training Program

- For program selection see the Starting up section page 18.

2 Input Conditions

- Input pulse limit, exercise time, and the exercise pattern. The initial display prior to input is as in the drawing. The numeric for age is blinking.

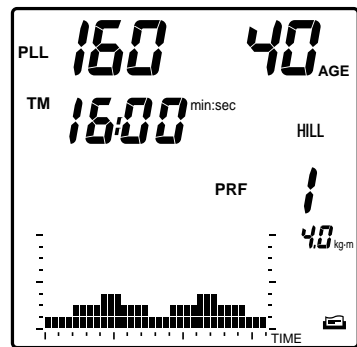

	Initial Value	Setting Range
Age	40	10 ~ 99
Pulse Limit	160 bpm	80 ~ 200 bpm
Exercise Time	16 min	16 ~ 99 min
Exercise pattern	1	1 ~ 9

- The pitch sound to adjust your cadence at 60 rpm (rings every half second) is set "OFF".
- The whole hill pattern of the selected number is displayed in the graphic section.
- You can increase or decrease the blinking numeric by pressing the $\odot+\odot$ or $\odot-\odot$ buttons.
- Press the **MODE** button to change the blinking numeric.

3 Start Program

- After setting your conditions, adapt the earlobe pulse sensor and depress **ADV** button to start program.
- After printing out the conditions, the LCD changes as in the drawing.
- The hill pattern is shown in the graphic section, and the dot at the far left is blinking. One dot along the vertical axis indicates 0.5 kg-m, while one along the horizontal axis differs in proportion with the preset exercise time. If it is 16 minutes for example, one dot stands for 30 seconds, and if 32 minutes one is 1 minute.
- When the time represented by one dot is over, the dot to the immediate right will start blinking. With the lapse of time, the blinking row will move to the right. The position of the blinking dots determines where you are in the hill pattern.

Note: There is no warm up phase in the "Hill profile training" program.

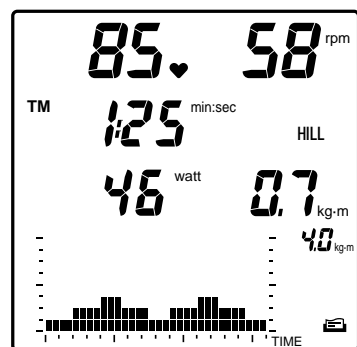

4 Exercise

- The pedal resistance (torque, kg-m) changes periodically according to the exercise pattern.

Remarks: In this program, you can change the pedal resistance temporarily by depressing either $\odot+\odot$ or $\odot-\odot$ button, whenever desired.

5 End Program

- The buzzer sounds at the specified time. The program ends and the calorie consumption is printed out.
- The LCD returns to the initial screen.
- If you are completely finishing the exercise, be sure to switch off the main unit.

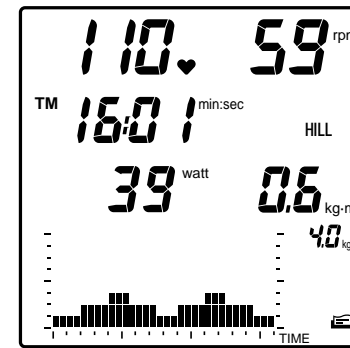

Note 1: There is no cool down phase if you finish Hill profile program at the end of the specified exercise time.

Note 2: If you press the **ADV** button during exercise, the program enters a 5 minute cool down phase and the pedal resistance becomes the minimum of 0.5 kg-m. The LCD still displays the same exercise data. The program ends if the 5 minute cool down phase elapses or if the **ADV** button is pressed.

Sample print out

```

*** EXERCISE T.M ***
FITNESS DATA
"HILL"
DATE '95.10.12
NAME
AGE 40
HILL 1
PULSE LT. 160
TM CDC WATT PULSE
0 68 31 79
1 60 39 86
2 57 46 89
    
```

- Shows that the Hill profile training program has been performed.
- Exercise pattern
- Upper limit pulse rate

```

115
99 47 112
16 58 38 110
E.C. = 89 KCAL
    
```

- Calorie consumption

Exercise Pattern

PRF-1 the Apennines
maximum torque 1.7 kg-m

PRF-2 the Apparachian
maximum torque 2.2 kg-m

PRF-3 the Cascades
maximum torque 2.5 kg-m

PRF-4 the Pyrenees
maximum torque 3.0 kg-m

PRF-5 Mount Fuji
maximum torque 3.7 kg-m

PRF-6 the Rockies
maximum torque 3.5 kg-m

PRF-7 the Alps
maximum torque 3.7 kg-m

PRF-8 the Himalayas
maximum torque 4.0 kg-m

PRF-9 customized pattern
(See page 40.)

Manual training

1 Select the Manual Training Program

- For program selection see the Starting up section page 18.

2 Input Conditions

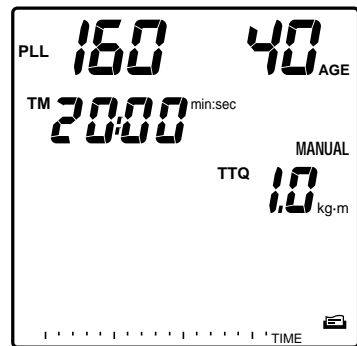

- Input age, pulse limit, exercise time, and the setting torque value. The initial display prior to input is as in the drawing. The numeric for age is blinking.

	Initial Value	Setting Range
Age	40	10 ~ 99
Pulse Limit	160 bpm	80 ~ 200 bpm
Exercise Time	20 min	0 ~ 99 min
Set Torque Value	1.0 kg·m	0.5 ~ 4.0 kg·m

- The pitch sound to adjust your cadence at 60 rpm (rings every half second) is set "OFF".
- There is no graphic display yet in the LCD.
- You can increase or decrease the blinking numeric by pressing the $\odot+\odot$ / $\odot-\odot$ buttons.
- Press the **MODE** button to change the blinking numeric.

3 Start Program

- Press the **ADV** button to start the program after you set the conditions.

4 Start / Warm Up

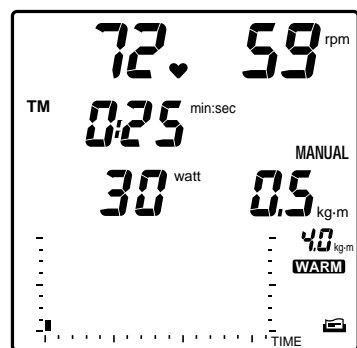

- After printing out the conditions, the LCD changes as in the drawing.
- The initial workload (pedal torque) is indicated in blinking dot in the graphic section of the LCD. One dot along the horizontal axis indicates 30 seconds, and one along the vertical axis 0.5 kg·m. At every 30 seconds, the row of dots will increase by one towards the right of the graphic section, with the last row blinking.
- After starting exercise, during the 3 minute warm up, the pedal resistance gradually increases and the **WARM** symbol is shown.

Note: During the warm up the pedal resistance increases so that it reached the set torque value in 3 minutes. If you have increased the torque value to more than the set torque value by pressing the $\odot+\odot$ / $\odot-\odot$ buttons, the warm up phase ends at that point.

Remark: If you first press the **MODE** button, and holding it down press the **ADV** button to start the program, instead of just pressing the **ADV** button, you can skip the warm up phase and start the exercise at the preset pedal torque from the scratch.

5 Exercise

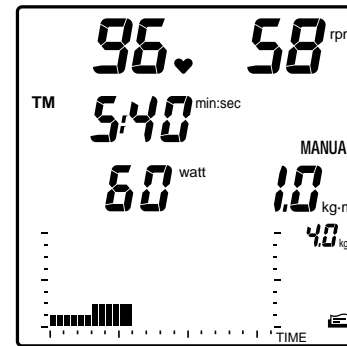

- Exercise at the set pedal resistance (torque, kg·m).

Note: In this program, you can increase or decrease the pedal resistance by pressing the $\odot+\odot$ / $\odot-\odot$ buttons whenever desired.

Remark 1: In this program only, even if the upper pulse limit alarm is activated and the pedal torque drops down to 0.5 kg·m, the program does not enter the cooling down phase, and you can carry on the preset workout by increasing pedal torque with $\odot+\odot$ / $\odot-\odot$ button.

Remark 2: The graphic section will display the torque pattern for maximum 16 minutes. At the end of the 16 minutes period, the torque pattern once disappear and the actual torque at that moment will be displayed flashing at the left end of the section.

6 Finish Exercise Cool Down

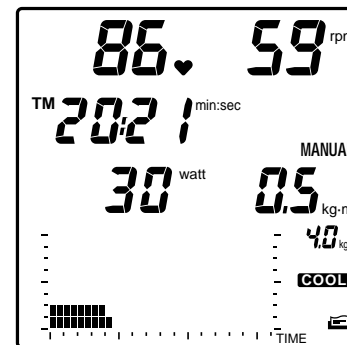

- The buzzer sounds at the specified time.
- If you press the **ADV** button, the program enters a 5 minute cool down phase and the **COOL** symbol lights up, then the pedal resistance becomes the minimum of 0.5 kg·m.

Note: Even if the buzzer sounds, the program does not enter the cool down phase unless you press the **ADV** button.

- The LCD still displays the same exercise data.

7 End Program

- If the 5 minute cool down phase elapses or if you press the **ADV** button, the buzzer sounds, the program ends and the calorie consumption is printed out.

- The LCD returns to the initial screen.

Sample print out

```

*** EXERCISE T.M ***
FITNESS DATA
"MANU"
DATE '93.10.12
NAME
AGE 40
TG.TQ 1.0
PULSE LT. 160
TM CDC WATT PULSE
0 59 30 72 *
1 00 37 83 *
2 09 43 90 *

```

- Shows that the Manual training program has been performed.
- Torque value you set initially
- Upper limit pulse rate

```

E.C. = 01 KCAL

```

- Calorie consumption

Setting your own training pattern

You can create your own training pattern as desired, for both interval training and hill profile training, and can keep them in memory for future use. Enjoy your exercise under your original training program on this model.

It is 1 pattern each in the Interval training (TLD-4) and Hill profile training (PRF-9), that you can write in your own customized pattern.

Procedure for writing a new pattern is the same for both interval training and hill profile training. The following is an example of writing in a new pattern on the hill profile training.

1 Select the Hill Profile Training Program

- Press **MODE** button until "HILL" (or INTVL) flashes, and press **ADV** button to enter the program.

2 Select the customized pattern

- Press **MODE** button until the PRF number blinks.
- Using **+** or **-** button, let the number 9 (TLD-4 in case of interval training) appear on the screen.

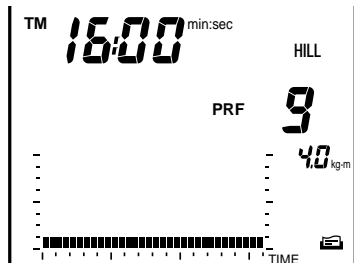

3 Change display panel into write-in phase

- Hold down the **MODE** button about 2 seconds. A buzzer beeps and the LCD screen will enter the pattern write-in mode. The far left dot in the graphic section is blinking.

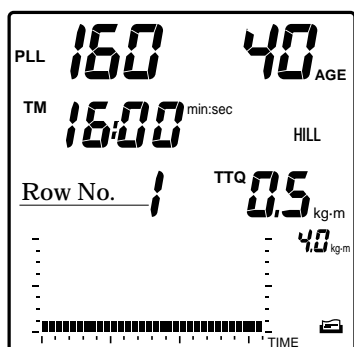

4 Input new training pattern

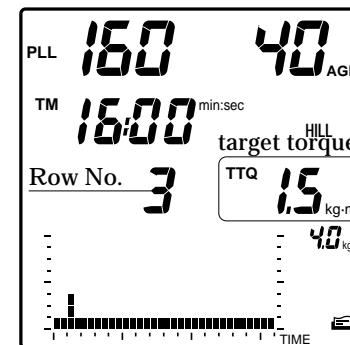

- Using **+** or **-** button, you can change the pedal resistance (workload level) of the blinking row.
- Pedal resistance will be displayed in both numerical value and dot pattern. Set your preferred torque value in the range from 0.5 kg-m to the maximum of 4.0 kg-m.
- Having set the torque value for the first row, press **MODE** button and the next right row starts blinking. Repeat the same procedure until you finalize the total pattern ending up with the 32nd row.

Remarks: Pressing **MODE** button when the 32nd column is blinking, the blinking system restarts from the first column towards the right for your modification of load pattern whenever necessary by using **+** or **-** button.

5 Register new training pattern

- After writing in the whole load pattern, press **ADV** button. Your new training program is registered in memory, and the LCD will turn to the condition input screen.
- Your own training pattern will be displayed on the screen simply by selecting exercise pattern PRF-9 (TLD-4 in case of interval training) hereafter.

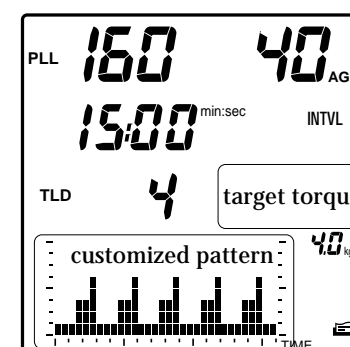

Customized pattern (TLD-4) of interval training

- The customized pattern created in 8 minutes time frame will be repeated during the target exercise time without warm up phase, unlike other training patterns (TLD-1~TLD-3).
- Since different torque values may be set in each time frame, the "Target Torque" cannot be determined in a single value. Therefore, neither TTQ display appears on the condition input screen, nor will the printer print out the indication of set torque.

How to make a data card

If you record your training conditions to this "Data Card", you can set the conditions merely by inserting the card into the card inlet of the control unit. You can start a program just by inserting the card and pressing the **ADV** button, saving all the button operation process.

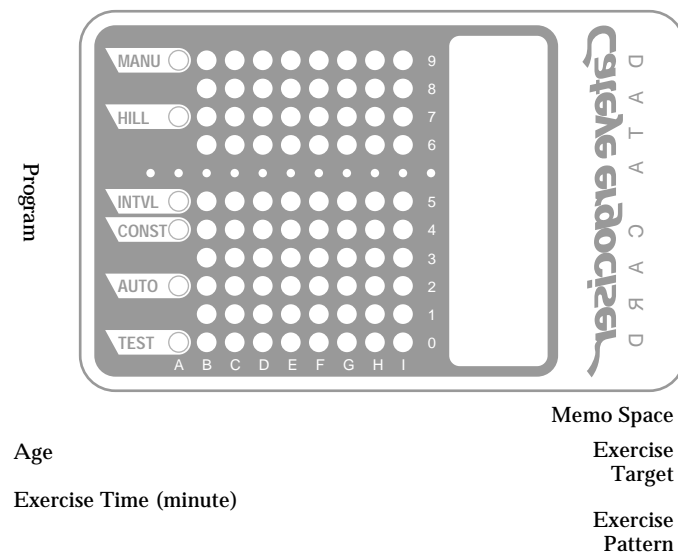

To record your conditions to the data card, scratch off the appropriate silver part on the back of the card with a coin etc. This removal allows the photo scanner in the control unit to detect the position of the exposed part. Now let's make your "Data Card."

Note: One Data Card is necessary for each of the desired conditions. You cannot specify two or more conditions on one card.

EXAMPLES OF DATA CARD PROGRAMMING

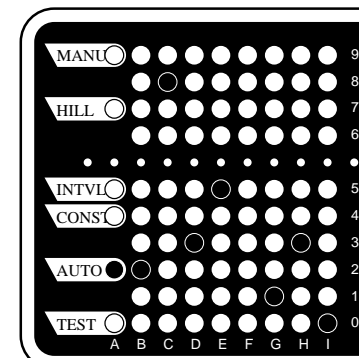

For Automatic Training

Age: 28 years Time: 35 minutes
Target Pulse Rate: 130 bpm

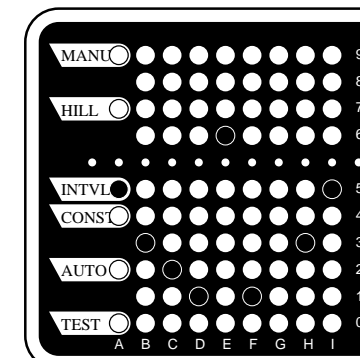

For Interval Training

Age: 32 years Time: 16 minutes
Pattern: TLD 1 Maximum Torque: 3.5 kg-m

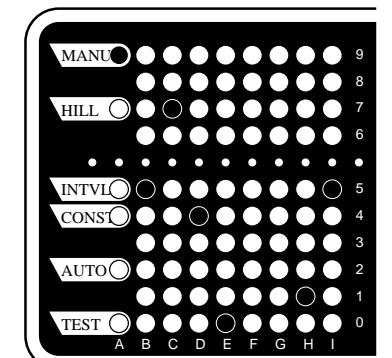

For Manual Training

Age: 57 years Time: 40 minutes
Set Torque: 1.5 kg/m

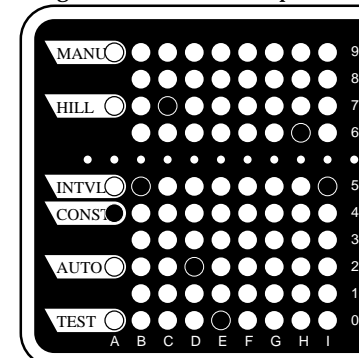

For Isopower Training

Age: 57 years Time: 20 minutes
Target Wattage: 65 watts

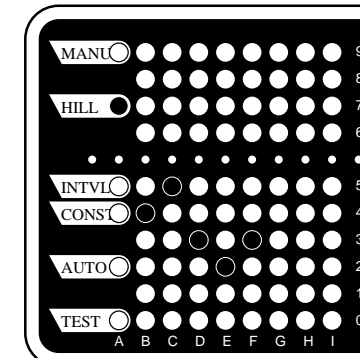

For Hill Profile Training

Age: 45 years Time: 32 minutes
Pattern: 3 (The Cascades)

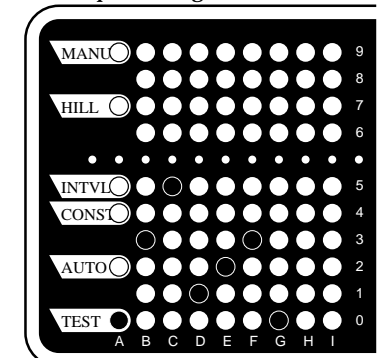

For Aerobic Power Measurement

Age: 35 years Weight: 123 lbs.
Sex: Female

1 Specify Program

- Specify the program in "A".

2 Specify Age

- Specify your age in "B" and "C".
- "B" indicates the first digit of your age, "C" indicates the second.
Example: Age 35 years
Enter "3" in "B" column
Enter "5" in "C" column

3 Specify Exercise Time

- Specify your exercise time in "D" and "E".
- "D" indicates the first digit of the exercise time, "E" indicates the second.

4 Specify Exercise Pattern

- Specify the exercise pattern in "F" when the "Interval training" or "Hill profile training" is selected.
- What you specify in "F" is invalid for other exercise programs.
- For Interval Training, choose one of 1 ~ 4.
- For Hill Profile Training, choose one of 1 ~ 9.

5 Specify Training Target

- Specify the training target in "G", "H" and "I".

1) Automatic Training

Specify the target pulse rate. "G" indicates the first digit of the value, "H" indicates the second and "I" indicates the third digit.

2) Isopower Training

Specify the set wattage. "G" indicates the first digit of the wattage, "H" indicates the second, and "I" indicates the third digit.

3) Interval Training

Specify the set torque Value. "H" indicates the first digit of the value, "I" indicates the first decimal place. If you select TLD-4, you don't have to specify any figure here. Whatever you may set in "G" is invalid.

4) Hill Profile Training

Whatever you specify in "G", "H", "I" is invalid.

5) Manual Training

Specify the set torque value. "H" indicates the first digit of the value, "I" indicates the first decimal place. Whatever you may set in "G" is invalid.

Note 1: When you execute the "Aerobic Power Measurement" with the card, specify your weight in "D", "E" and "F".
"D" is the third digit, "E" the second and "F" the first digit.
Your sex is specified in "G".
"0" indicates female, "1" male.

CAUTIONS ON HANDLING THE DATA CARD

- Treat the card with care. Do not bend or damp the card.
- Scratch only the necessary part of the silver ink. Otherwise the sensor will not read out the data.
- Wipe the residue of the scratched silver ink off the card before inserting the card into the control unit.
- The blank space on the card can be utilized as memo space to enter the programmed data, user's name etc.
- If you have scratched incorrect data, use "white out" to cover the hole. If the light doesn't go through the hole that you have covered up, the card can be used normally.

Note: If "ERROR" appears on the LCD when you insert the card, check whether any incorrect or unnecessary point has been scratched out.

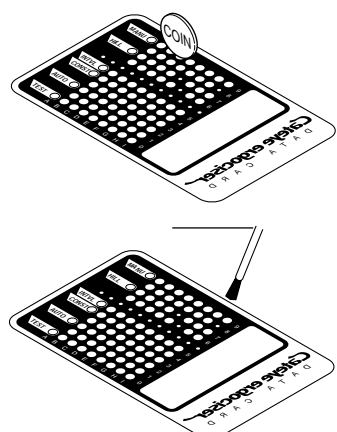

Reference

- 1 External computer control via an RS232C terminal
- 2 Using chestbelt heart rate sensor
- 3 Setting the date
- 4 Printing mechanism
- 5 Troubleshooting and handling care
- 6 Warranty service and optional parts
- 7 Specifications

External computer control via an RS232C terminal

External computer control via an RS232C terminal

If you connect the optional "RS232C Communication Kit," the Ergociser™ can communicate with an external computer. Specifically, you can write a program with an external computer in Basic or in another computer language, and operate the Ergociser™ EC-3700 according to the written procedure. Any instructions input by the buttons on the EC-3700 control unit can be input from the external computer, and the EC-3700 sends data to an external computer every second. Since command signals are in ASCII character code, any computer that generates these codes can be used, receiving and transmitting via the RS232C terminal.

Transmission Format

Communication speed (baud rate)	2400
Data bit length	8 bit
Stop bit	1 bit
Parity check	none
XON / XOFF control	none
SI/SO control	none

Contents of Data Transmission from the EC-3700

The EC-3700 outputs display data in character code, continuously when you set exercise conditions and once per second when you are exercising. Since the contents of the LCD differs according to setting exercise conditions and during exercise, the content of data output also differs.

1) Setting Exercise Conditions

Address	Data	Function
1	A code	Hexadecimal 41H
2	3 digit numeric	Set wattage (Isopower Training)
5	1 digit numeric	Exercise pattern (Interval Training)
6	3 digit numeric	Target pulse rate (Auto Training)
9	1 digit numeric	Sex (male:"1", female:"0")
10	1 digit numeric	Exercise pattern (Hill Profile Training)
11	2 digit numeric	Set torque x 10
13	3 digit numeric	Weight (Aerobic Power Measurement)
16	2 digit numeric	Target time (minutes)
18	3 digit numeric	Pulse limit value
21	2 digit numeric	Age
23	CR code	Hexadecimal 0DH

2) During Exercise

Address	Data	Function
1	B code	Hexadecimal 42H
2	4 digit numeric	Elapsed time 2 digits = "minute" 2 digits = "second"
6	4 digit numeric	Calorie consumption
10	3 digit numeric	Wattage
13	2 digit numeric	Pedal torque x 10

15	3 digit numeric	Pulse rate
18	3 digit numeric	Pedal cadence
21	1 digit numeric	Aerobic power measurement result: PFL
22	2 digit numeric	Aerobic power measurement result: MOU
24	3 digit numeric	Aerobic power measurement result: PWC max.
27	3 digit numeric	Set wattage (Isopower training)
30	2 digit numeric	Lowest 2 digits of addition value of data address 2 ~ 29
32	CR code	Hexadecimal 0DH

Note: "0" is displayed in each digit for the 3 types of aerobic power measurement results, until the program is completed.

Externally Controlling the EC-3700

1) During Setting Exercise Conditions

When exercise conditions are being set, you can send data in a "character code + numeric code + CR code" format (shown in example below) from an external computer, setting your exercise conditions.

Example) "K6CR" : Selects Auto Training

Character Code	Function
A	Age (up to 2 digits)
B	Pulse limit value (up to 3 digits)
C	Target time (up to 2 digits)
D	Weight (up to 3 digits)
E	Set torque x 10 (2 digits)
F	Exercise pattern (Hill Profile Training)
G	Sex (male: "1", female: "0")
H	Target pulse rate (up to 3 digits)
I	Set wattage (up to 3 digits)
J	Exercise pattern (Interval Training)
K	Exercise program 1: Aerobic Power Measurement 2: Manual Training 3: Hill Profile Training 4: Interval Training 5: Isopower Training 6: Auto Training
L	Reset torque during exercise x 10 (2 digits)

2) During Exercise

By using the following character codes for button operation, you can externally control the program during exercise.

Example) Sending "i CR" during Manual Training
-> increases pedal resistance (torque) 0.1 kg•m

Character Code	Function
r	RESET button
g	ADV button
i	+ 1 button
d	- 1 button

See the instruction manual for the optional "RS232C Communication Kit" for details.

Using chestbelt heart rate sensor

Wireless chestbelt sensor picks up your heart rate

In place of the earlobe pulse sensor, the EC-3700 can also receive your pulse signal transmitted from a particular type of wireless chestbelt sensor. The "Wireless Pulse Sensor Kit" (an optional item) is recommended for the customers who may feel inconvenience in picking up the pulse rate from the earlobe.

Function of wireless chestbelt sensor

The wireless chestbelt sensor is a simplified and compact electrocardiograph as widely used in hospitals on the same principle. At hospitals, electrodes are attached to several parts of the body, and a cardiogram is determined on the basis of potential differences among those electrodes. The chestbelt sensor picks up the heart rate more simply through potential difference between two electrodes built-in there and in contact with the body.

The pulse data are transmitted to the control unit by radio wave, thus eliminating inconveniences of handling the sensor cable and offering concentrated intense training.

The "Wireless Heart Rate Sensor Kit" consists of a chestbelt sensor unit (transmitter) and a receiving circuitry to be mounted inside of the control unit.

Attaching the chestbelt sensor

The chestbelt sensor should be put around your chest with two electrodes in contact with your body at the center.

For further information, please refer to the Manual enclosed in the "Wireless Heart Rate Sensor Kit" (an optional item).

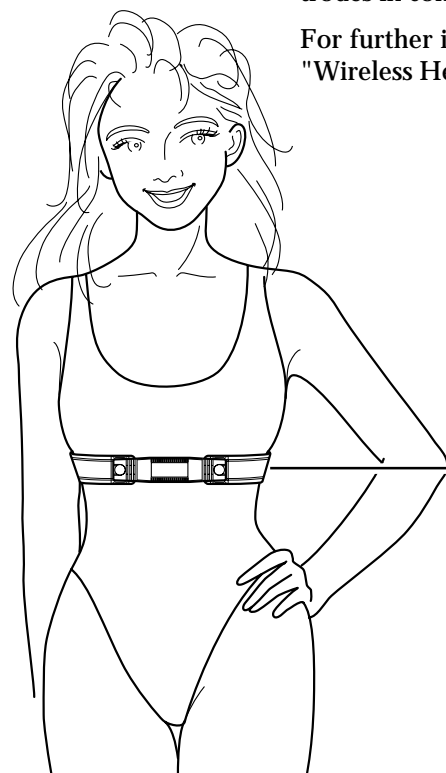

Chestbelt heart rate sensor adapted in position

Direct contact to lower chest skin is ideal in use.

Setting the date

Displaying the Date

- While holding down the **MODE** button, hit the **RESET** button once, and the date

and time are displayed. (as displayed in the lower column)

Setting the Date

- By each press of the **MODE** button, different numerics will blink in

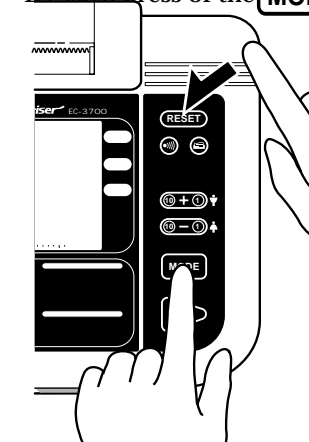

the sequence of minute-

hour-date-month-year.

- Set the date and time by pressing the **0+0** **0-0** buttons to increase or decrease the blinking numeric.
- Once the minute is set, the clock starts working. So set at the actual minutes without considering the time for setting other data.

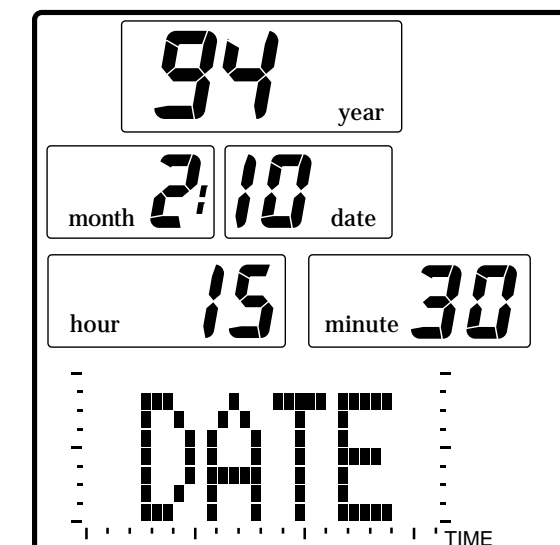

Finishing the Setting

- When the setting is over, press the **ADV** button. The LCD returns to the initial display (screen to select a program).
- The date is printed out at the beginning of a printer printout.

Printing mechanism

Inserting printer paper

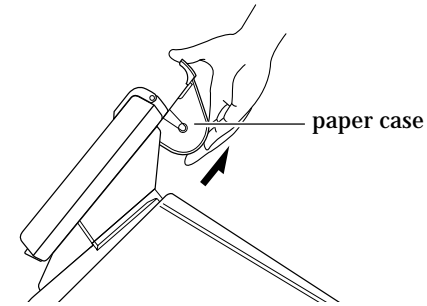

1. Pull out the paper case at the bottom of the control unit and detach it.

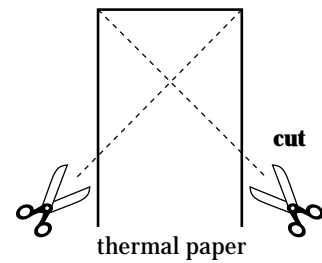

2. Cut the edge of the thermal paper to a point with a scissors (as illustrated).

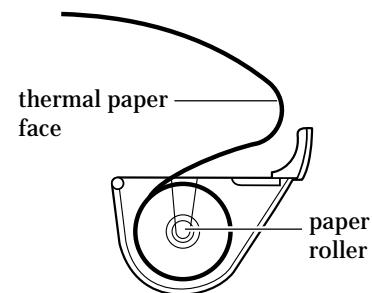

3. Insert the paper roller into the paper roll, and place the roll in the case in the correct position and direction as illustrated.

Note: The printer will not print out data on the reverse side of the paper. Check the proper direction before inserting.

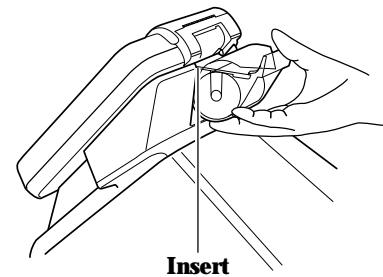

4. Insert the paper case halfway into the bottom of the control unit (as illustrated below).

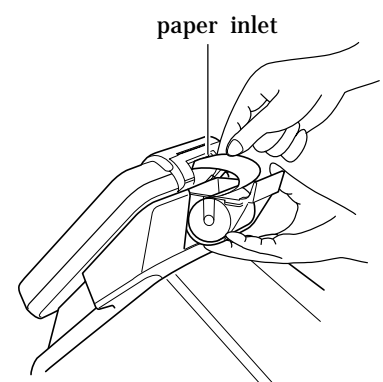

5. Then raise the printer cover and insert the pointed edge of thermal paper into the paper inlet of the control unit.

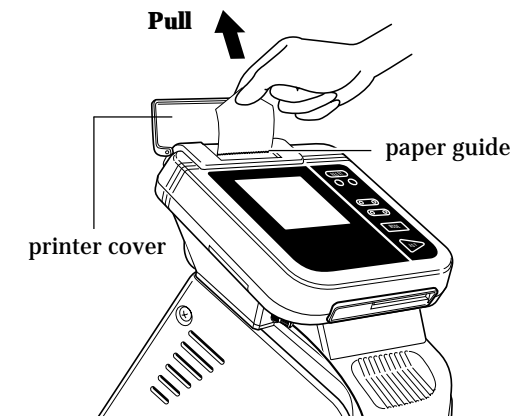

6. Holding the edge of the thermal paper coming out of the paper guide, pull it out and pass it under the printer cover. Close the printer cover, and draw the paper until the paper edge entirely comes out of the printer cover.

7. Insert the paper case completely into the bottom of the control unit. Then pull the thermal paper again to remove the paper sag in the paper case. This completes setting the thermal paper. You can cut the thermal paper with the printer cover closed.

What to do when printer paper gets jammed

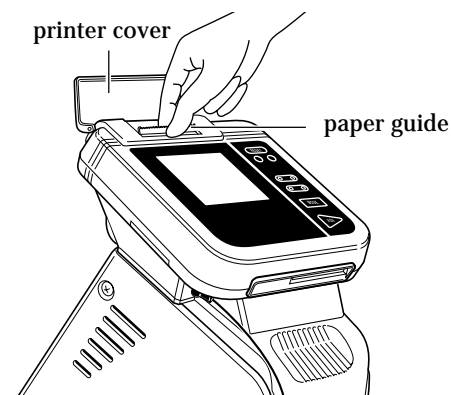

1. Lift up the paper guide on the front panel of the control unit.

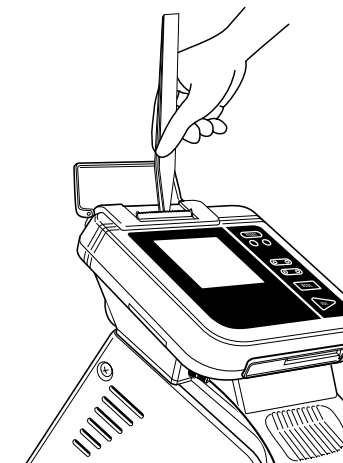

2. Use tweezers to remove the jammed paper.





Caution on printer operation



- Do not drive the printer without the thermal paper on it. If the thermal paper is unavailable, press the printer button and confirm that the printer symbol on the LCD is not lit up before use.
- Please use the specified Cateye thermal paper (part #7226502) only.

Troubleshooting and handling care

Troubleshooting

Problems noted in the following chart are not disorders. Prior to seeking repair, read the contents of the entire chart first.

Problem	Item to check	Countermeasure
Display does not appear.	Is the power supply connected?	Connect the AC adaptor correctly. (see page 14)
	Is the power switch on?	Turn the power on.
	Isn't the cable of the AC Adapter damaged?	Replace the AC Adapter if its interior circuit or the cable is damaged.
Printer does not work.	Didn't you select "not to use" the printer with the selector switch on the back panel of the control unit?	Set the select switch No.4 to OFF. (see page 8)
	Is the  symbol shown on the LCD?	Press the  button on the Control Unit to let the  symbol show up. But if the select switch No.4 on the back of the control unit is ON, the  symbol doesn't appear even if you press the button.
	Isn't the paper jammed?	Remove the jammed paper. (see page 51)
Date memory is incorrect.	Did you set the date?	Set the date correctly (page 49)
	Are the backup batteries installed? If not, the date memory is lost each time you turn off the power.	Load the backup batteries. (see page 8)
	Isn't the  symbol shown on the LCD?	Replace the backup batteries, because they have worn out. (see page 8)
ERROR or irregular display appears when you insert the data card.	Isn't the data card reversed?	Hold the card yellow arrow side up, and insert to the direction of arrow.
	Didn't you insert the card too quickly?	Insert the card slowly.
	Didn't you specify two or more programs, or open unnecessary holes?	Refer to P.42~43 and specify the program and conditions correctly.
The pulse rate is not displayed, remaining "0".	Is the pulse sensor attached correctly to your earlobe?	Insert the sensor plug securely into the sensor jack, and check the pulse sensor function according to page 13. If the sensor cable proves to be broken, replace the pulse sensor (part #7801101).
	Is the sensor plug completely inserted into the sensor jack?	
The pulse rate increases abnormally.	Is the pulse sensor correctly attached to your earlobe?	Attach the sensor correctly to your earlobe and take care not to swing the sensor or sensor cable during the exercise. If the sensor cable proves to be damaged, replace the whole pulse sensor with a new one.
	Isn't the sensor cable damaged?	

Problem	Item to check	Countermeasure
The evaluation of fitness level seems incorrect.	Is the weight unit correct?	Set the weight unit correctly. (see page 8)
	Did you select the correct fitness level evaluation table?	Check the selector switch on the back panel of the control unit. (see page 8~9)
The program is suspended halfway.	Isn't the upper pulse limit alarm ringing due to the excess of your pulse rate during the exercise?	Input your age correctly to prevent the alarm from ringing unduly.
Buzzer keeps sounding.	Isn't the pulse limit setting too low due to an incorrect age input?	
The pitch sound doesn't ring.	Is the  symbol shown on the LCD?	Press the  button on the control unit to let the  symbol show up.
	Check if sensor plug is completely connected.	Unit does not give pitch sound if plug is out of jack.
Clattering noise is heard with the pedal rotation.	Are the pedals firmly attached to the crank? If not, noise may be produced.	Attach the pedals firmly.

Handling

For longer use of the Ergociser™ EC-3700, observe the following precautions.

- Do not disassemble the main and control units. In case of problems contact your dealer where the unit was purchased.
- Avoid using the Ergociser™ EC-3700 in a high temperatures or in high humidity. Also, do not splash the unit with water.
- Handle the pulse sensor carefully. If strongly pulled out the cable may become disconnected.
- When the EC-3700 is not in use, shut the power switch OFF and disconnect the power cord from the outlet.
- Do not wipe the main unit with organic solvents such as thinner, kerosine, gasoline and alcohol. When dirty, wipe the unit with a cloth soaked in a neutral detergent, then wipe well with a dry cloth.
- Do not place the EC-3700 in direct sun light.

Warranty service and parts

Warranty service

- Cat Eye Co., Ltd. warrants that the Cateye Ergociser™ Model EC-3700 is free from material defects and malfunctions under correct and normal use for three (3) years from the date of purchase. In case there should be defects or malfunctions, Cat Eye will repair or replace the unit or parts, according to the terms and conditions mentioned in the separate Warranty Card.
- If repair service is required, contact your dealer where the unit was purchased.
- The warranty covers only the main unit and the control unit. Accessories such as the pulse sensor or the AC adaptor are not covered.

Parts for Replacement

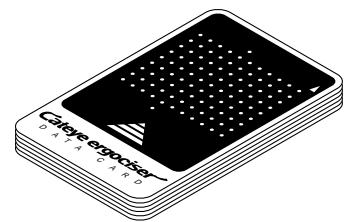

Data Card (10 pcs)
(Part #7224950)

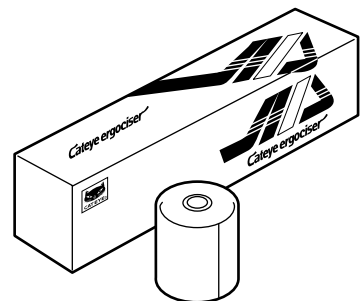

Thermal Paper (5 rolls/box)
(Part #7226502)

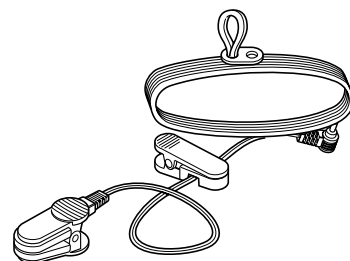

Pulse Sensor (Long)
(Part #7801101)

Optional Parts

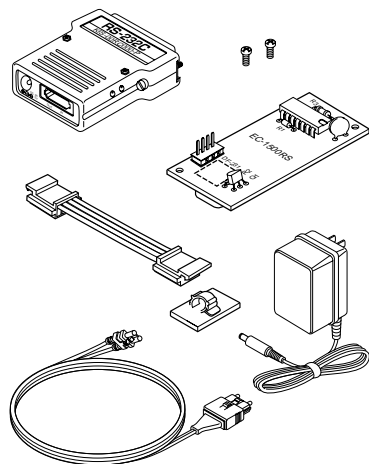

RS232C PC Communication Kit
(Part #7015701)

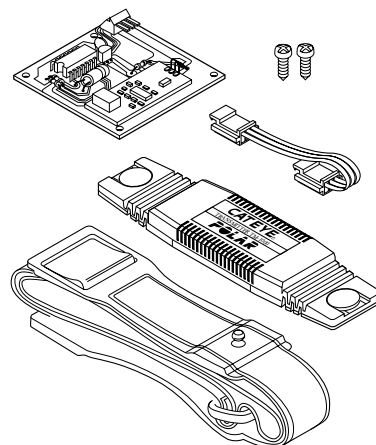

Wireless Heart Rate Sensor Kit
(Part#7016700)

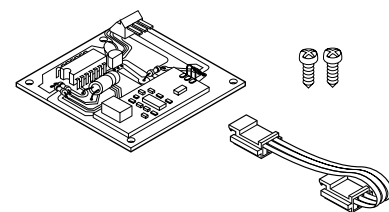

Wireless Heart Rate Receiver Kit
(Part#7016801)

Specifications

Item	Specifications		
Power source	Home AC Power (Use specified AC adapter only.)		
Power consumption	Max. approx. 15 W		
Loading system	Eddy current system		
Speed increasing mechanism	2-step speed increase by chain and timing belt		
Control system	8-bit microcomputer control system		
Display system	Liquid crystal display		
Display functions	Function	Display range	
	Pulse rate	50 ~ 199 bpm	
	Pedal cadence	20 ~ 199 rpm	
	Exercise time	00min. 00sec. ~ 99min. 59sec.	
	Calorie consumption	0 ~ 999 kcal (Estimated value)	
	Load torque	0.5 ~ 4.0 kg-m	
	Work rate (wattage)	0 ~ 400 watts	
Printing system	Thermal printer, Thermal paper (57mm x 25m roll)		
Data input system	Data card (Use specified cards only) and buttons		
Pulse sensor	Earlobe pulse sensor (with special noise reducing system)		
Exercise programs	Program	Specifications	
	Aerobic power measurement	Fitness level evaluation by MOU value Applicable range: age of 20 ~ 69 years	
	Auto matic training	Exercise under a constant pulse rate Setting range: 60 ~ 180 bpm	
	Isopower training	Exercise under a constant load(wattage) Setting range: 25 ~ 200 watts	
	Interval training	Exercise under one of the 4 patterns of work and relief interval	
	Hill profile training	Exercise under one of the 9 patterns of hill profiles	
	Manual training	Exercise under a constant pedal resistance (torque) Setting range: 0.5 ~ 4.0 kg-m	
	Alarm function	Upper pulse limit alarm, buzzer beeps continuously and pedal torque is reduced to the minimum	
	Buzzer sound	Pitch sound (120 times/min. cancellable), Upper pulse limit, Confirmation of button function	
	Backup Batteries	AAA(R03) x 2 for date memory (life: approx. 2 years)	
	User's weight limit	Approx. 286 lbs. (130 kgs)	
	Measurement	Overall Length	75-3/16 inches max. (1910 mm)
		Unit Height	37-9/16 inches max. (954 mm)
Width		22-1/16 inches (560 mm)	
Seat to Crank Axle Distance		14-31/32 ~ 26-25/32 inches (380 mm ~ 680mm)	
Seat Height		11-11/32 ~ 19-3/32 inches (288 ~ 680 mm)	
Crank Axle		17-1/8 inches max. (435 mm) from floor	
Weight	Net Weight	Approx. 79 lbs (36 kgs)	
Connection with an external computer	Two-way communication with an external computer is possible with the optional accessory "RS232C Communication Kit"		
Wireless heart rate sensor	Optional item (Wireless heart rate sensor kit) applicable		

U.S. Pat. 4775145, Pat. & Design Pat. Pending

* The specifications and design are subject to alteration without notice for improvement purpose.

**"CATEYE™" and "ERGOCISER™" are registered trademarks of CAT EYE CO., LTD.

Copyright© 1994
Cat Eye Co., Ltd.
Printed in Japan
ECME37-940212-1



CATEYE CO., LTD.

2-8-25, Kuwazu, Higashi Sumiyoshi-ku, OSAKA, 546-0041 JAPAN
PHONE: 81-6-6719-7781 FAX: 81-6-6719-2362

Free Manuals Download Website

<http://myh66.com>

<http://usermanuals.us>

<http://www.somanuals.com>

<http://www.4manuals.cc>

<http://www.manual-lib.com>

<http://www.404manual.com>

<http://www.luxmanual.com>

<http://aubethermostatmanual.com>

Golf course search by state

<http://golfingnear.com>

Email search by domain

<http://emailbydomain.com>

Auto manuals search

<http://auto.somanuals.com>

TV manuals search

<http://tv.somanuals.com>