

Digital Camera

QV-5700

User's Guide

Exif Print

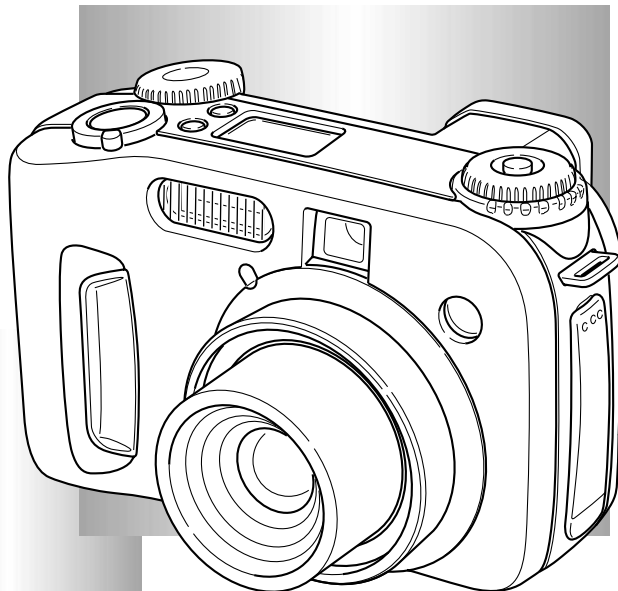

Congratulations upon your selection of the new CASIO Digital Camera. To get the most out of your new CASIO Digital Camera, make sure you read this manual carefully and keep it on hand for future reference.

INTRODUCTION

Contents

2 INTRODUCTION

Quick Reference	6
Getting Ready	6
Recording an Image	7
Viewing (Playing Back) an Image	8
Deleting an Image	9
Features	11
Recording Features	13
Precautions	14
General Precautions	14
Operating conditions	15
Condensation	15
Lens Precautions	16
About the camera's backlight... ..	16

17 GETTING ACQUAINTED

General Guide	17
Front	17
Back	18
Side	19
Bottom	19
Open Terminal Panel Cover	19
Mode Dials	20
Using the Control Button	21

Monitor Screen Indicators	22
REC mode	22
PLAY mode	23
Changing the Contents of the Monitor Screen	24
Indicator display	24
Operation Indicator Lamp	25
Operation/card access lamp	25
Flash Charge lamp	26
AF Assist Light/Self-timer Lamp	26
Using the Bundled Accessories	27
Attaching the Neck Strap	27
Adjusting the Length of the Neck Strap	27
Using the Lens Cap	28
Power Requirements	29
Loading Batteries	29
Battery Handling Precautions	32
Low Battery Indicator	33
Using AC Power	33
Turning the Camera On and Off	35
Power Save Settings	35
Memory Cards	37
Inserting a Memory Card into the Camera	37
Removing a Memory Card from the Camera	38
Formatting a Memory Card	39
Memory Card Precautions	40
IBM Microdrive Precautions	41
Menu Screens	42
Setting the Current Date and Time	43
Setting the Date and Time	43
Selecting the Date Format	44

INTRODUCTION

45 BASIC IMAGE RECORDING

Using the Full Auto Mode	45
Recording Precautions	47
Focusing	47
About Auto Focus	48
Image Recording when the Batteries are Low	48
About the REC Mode Monitor Screen	49
Using Optical Zoom	49
Using the Viewfinder for Recording	51
Using the Self-timer	52
Camera Orientation Detection	53

54 OTHER RECORDING FUNCTIONS

Recording a Single Image (1-Image)	54
Previewing the Last Image Recorded	54
Deleting the Last Image Recorded in the REC Mode	55
Using the Flash	55
Selecting the Flash Mode	55
Flash Status Indicators	56
Adjusting the Flash Intensity	57
Changing the Sync Speed	57
Selecting a Flash Sync Setting	58
Precautions when Using Flash	60
Selecting the Focus Mode	61
Using Auto Focus (Multi-area Auto Focus)	62
Using the Spot Auto Focus Mode	63
Using the Manual Focus Mode	64

Using the Infinity Mode	65
Using the Macro Mode	65
Using Focus Lock	66
Expanding the Focus Area	67
Camera Shake Indicator	67
Selecting the Metering Mode	68
Selecting White Balance	69
Adjusting White Balance Manually	70
Using AE Lock	71
Exposure Compensation	72
Using the Histogram	74
Using Digital Zoom	75
Instant Setup Using the Best Shot Mode	76
Copying a Scene from the CD-ROM Best Shot Library	77
Registering Your Own Best Shot Scenes	80
Specifying the Location of Best Shot Mode Scenes	81
Specifying the Exposure Mode	82
Full Auto	82
Program AE	83
Aperture Priority AE	84
Shutter Speed Priority AE	85
Manual Exposure	87
Using the Continuous Shutter Mode	88
Using the AEB (Automatic Exposure Bracketing) Mode ...	89
To configure AEB Mode settings	89
To record an image using AEB	90
Creating a Panorama	91

INTRODUCTION

Recording a Movie	93
REC Mode Camera Settings	94
Specifying Image Size and Quality	94
Specifying Sensitivity	96
Enhancing Certain Colors	96
Using the Filter Function	97
Specifying Color Saturation	98
Specifying Contrast	98
Specifying Outline Sharpness	99
Turning the On-screen Grid On and Off	99
Inserting a Time Stamp into an Image	100
Specifying Power On Default Settings	101
Resetting the Camera	102
Using the Remote Shutter Release	103
Using an External Flash	104
External Flash Unit Requirements	104
Attaching an External Flash Unit	104
Attaching a Conversion Lens, Close-up Lens, or Filter	106
Installing a Conversion Lens or Close-up Lens	106
Using a Filter	108

109 PLAYBACK

Basic Playback Operation	109
Playing a Movie	110
Playing a Panorama	111
Enlarging the Playback Image	112

Displaying the 9-image View	113
Selecting a Specific Image in the 9-image View	114
Displaying the Histogram and Other Image Information	115
Using the Slide Show Feature	117
Resizing an Image	118

119 DELETING IMAGES

Deleting the Displayed Image	119
Deleting Selected Images	120
Deleting All Images in Selected Folders	121
Deleting All Unprotected Images	122

123 MANAGING IMAGES

Folders and Files	123
Folders	123
Files	124
Protecting Images Against Deletion	125
Protecting Selected Images	125
Protecting and Unprotecting All Images in Selected Folders	126
Protecting and Unprotecting All Images	127

INTRODUCTION

DPOF	127
Making DPOF Settings for Particular Images	128
Making DPOF Settings for Particular Folders	129
Making DPOF Settings of All Images on the Memory Card	129
PRINT Image Matching II	130
Exif Print	131

132 OTHER SETTINGS

Changing the Menu Language	132
Installing a Different Language Set	132
Turning the Confirmation Beep On and Off	136

137 CONNECTING TO EXTERNAL EQUIPMENT

Connecting to a Television	137
Selecting the Video Output Signal Mode	138
Connecting to a Computer	139
Installing the Software from the CD-ROM	139
About the bundled CD-ROM	139
Computer System Requirements	140
Installing Software from the CD-ROM in Windows	141
Installing Software from the CD-ROM on a Macintosh	143
Installing Software	143
Transferring Files to a Computer	147

Using a Memory Card to Transfer Image Data	149
Memory Card Data	150
DCF Protocol	150
Memory Card File Structure	151
Image Files Supported by the Camera	152
Precautions when Using a Memory Card on a Computer	153
Using the HTML Card Browser	154
Specifying the Card Browser Type	154
Viewing Card Browser File Contents	156
Saving Card Browser Files	158

159 REFERENCE

Camera Menus	159
REC mode	159
PLAY mode	160
Mode Settings	161
Settings in Each Mode	161
Drive Mode + Exposure Mode Combinations	162
Full Auto Mode Settings	163
Menu Settings	163
Non-Menu Settings	163
Troubleshooting	164
Messages	167
Specifications	169

Getting Ready

1

Load batteries.

(page 29)

1



2



3



2

Insert the memory card.

(page 37)

1



2

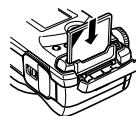
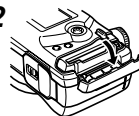

3

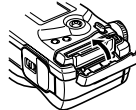

3

Set the current time and date.

(page 43)

Recording an Image (page 45)

1

Remove the lens cap from the lens.

2

Align the exposure mode dial with **A** (Full Auto Mode).

3

Align the drive mode dial with **[]** (1-Image).

5

Point the camera at the subject, compose the image on the monitor screen, and press the shutter release button half way to focus the image.

4

Align the power/function switch with **[]**.

6

After confirming that the Auto Focus operation is complete (the operation lamp lights green), press the shutter release button all the way down to record the image.

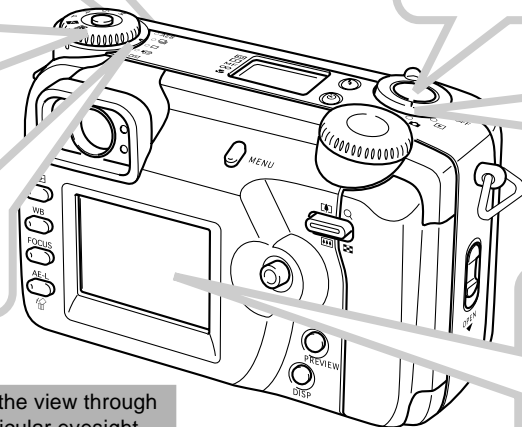

Use the Diopter Dial to adjust the view through the viewfinder to suit your particular eyesight. (page 51)

Viewing (Playing Back) an Image (page 109)

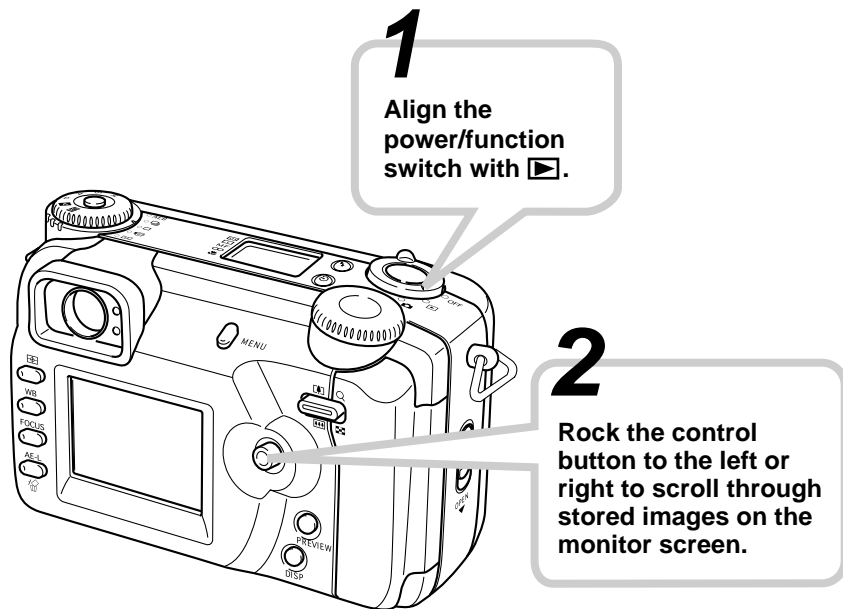

Deleting an Image (page 119)

4

Double check to make sure that you really want to delete the image you selected.

- You can exit the image delete operation by pressing AE-L .

1

Align the power/function switch with .

2

Rock the control button to the left or right to scroll through stored images and display the one you want to delete.

3

Press AE-L .

5

Rock the control button down to select "Yes" and then click the control button.

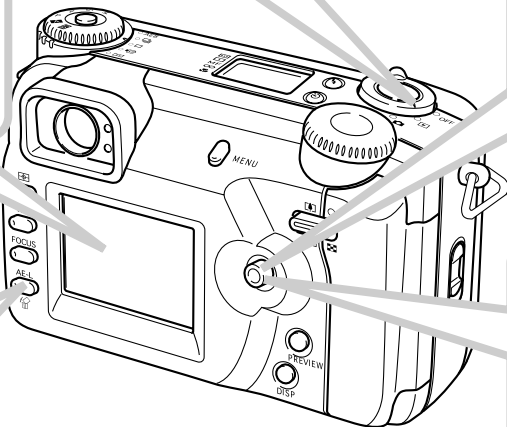

INTRODUCTION

- The contents of this manual are subject to change without notice.
 - CASIO COMPUTER CO., LTD. assumes no responsibility for any damage or loss resulting from the use of this manual.
 - CASIO COMPUTER CO., LTD. assumes no responsibility for any loss or claims by third parties which may arise through the use of the QV-5700.
 - CASIO COMPUTER CO., LTD. shall not be held liable for any damages or losses suffered by you or any third party due to the use of Photo Loader, Photohands and/or Panorama Editor.
 - CASIO COMPUTER CO., LTD. assumes no responsibility for any damage or loss caused by deletion of data as a result of malfunction, repairs, or battery replacement. Be sure to back up all important data on other media to protect against its loss.
 - *CompactFlash™ and the  logo are registered trademarks of SanDisk Corporation.*
 - *Windows, Internet Explorer, and DirectX are registered trademarks of Microsoft Corporation.*
 - *Macintosh is a registered trademark of Apple Computer, Inc.*
 - *Acrobat and Acrobat Reader are trademarks of Adobe Systems Incorporated.*
 - *The USB driver (mass storage) uses Phoenix Technologies Ltd. software.*
- Compatibility Software Copyright © 1997*

Phoenix Technologies Ltd., All Rights Reserved.

- *Other company, product and service names used herein may also be trademarks or service marks of others.*
- *Photo Loader, Photohands and Panorama Editor are the property of CASIO COMPUTER CO., LTD. Except as stipulated above, all copyrights and other related rights to these applications revert to CASIO COMPUTER CO., LTD.*

Features

- **High-resolution 5.0 megapixel CCD (5.36 million total pixels)**
Record images that capture everything from delicate skin tone nuances to all the fine detail of natural scenery.
- **Canon F2.0 wide-aperture lens**
Provides high contrast and captures the most delicate of nuances.
- **World's first digital soft focus**
Creates stunning effects for portraits and floral shots.
- **Real-time histogram**
Quickly and easily obtains exactly the exposure you want, even under difficult lighting conditions.
- **Easy-to-understand control panel**
Aperture, shutter speed, focus and other settings can be seen at a glance, even when the monitor screen is turned off.
- **Dual dial operation**
A pair of dials helps to make drive mode and exposure mode settings quick and easy.
- **AF assist light**
Improves auto focus accuracy when shooting under dim lighting.
- **Multi-area AF**
Helps to prevent out-of-focus areas in an image.
- **Focus area expansion**
Makes it easier achieve the focus you want.
- **Image preview**
Provides instant preview of an image you just recorded.
- **1.8-inch TFT low-glare color LCD (HAST) monitor screen**
- **9.6X seamless digital zoom**
3X digital zoom, 3.2X digital zoom
- **External flash connectability**
- **Memory card image storage**
Supports CompactFlash cards (CF TYPE I/II) and the IBM Microdrive.
- **Digital Print Order Format (DPOF)**
Images can be printed easily in the sequence you want using a DPOF compatible printer. DPOF can also be used when specifying images and quantities for printing by professional print services.
- **PRINT Image Matching II Compatible**
Images include PRINT Image Matching II data (mode setting and other camera setup information). A printer that supports PRINT Image Matching II reads this data and adjusts the printed image accordingly, so your images come out just the way you intended when you recorded them.

INTRODUCTION

- DCF Data Storage
DCF (Design rule for Camera File system) data storage protocol provides image inter-compatibility with printers and other digital cameras.
- VIDEO OUT terminal
Connects to your TV for big-screen viewing of images.
- USB compatibility
Connects to your computer for quick and easy image exchange.
- Image management and manipulation software
The QV-5700 comes bundled with a CD-ROM that's packed with useful software: Photo Loader for transferring images to your computer, Photohands* for editing and printing images, and Panorama Editor* for stitching images into panoramas. Other bundled...
* Windows version only.

Recording Features

Best Shot Mode

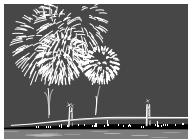

page 76

Movie Mode



page 93

Auto Exposure Bracketting (AEB)

Automatically records multiple images at different exposure settings.



page 89

Panorama Mode

Stitches multiple images into a sweeping panorama.



page 91

Five focus modes

Multi-area AF, Spot AF, Manual, Infinity, Macro

page 62 to 65

Three metering modes

Multi-pattern, Center-weighted, Spot

page 68

Five exposure modes

Full auto, Program AE, aperture priority AE, shutter speed priority AE, manual exposure

page 82 to 87

Precautions

General Precautions

Be sure to observe the following important precautions whenever using the QV-5700.

All references in this manual to “this camera” and “the camera” refer to the CASIO QV-5700 Digital Camera.

- Never try to take pictures or use the built-in display while operating a motor vehicle or while walking. Doing so creates the danger of serious accident.
- Never try to open the case of the camera or attempt your own repairs. High-voltage internal components create the risk of electrical shock when exposed. Always leave maintenance and repair work up to authorized CASIO service providers.
- Never fire the flash in the direction of a person operating a motor vehicle. Doing so can interfere with the driver's vision and create the danger of accident.
- Never fire the flash while it is too close to the subject's eyes. Intense light from the flash can cause eye damage if it is fired too close to the eyes, especially with young children. When using the flash, the camera should be at least one meter (3.3') from the eyes of the subject.
- Keep the camera away from water and other liquids, and never let it get wet. Moisture creates the danger of fire and electrical shock. Never use the camera outdoors in the rain or snow, at the seashore or beach, in the bathroom, etc.

- Should foreign matter or water ever get into the camera, immediately turn power off, unplug the AC adaptor from the power outlet, and contact your dealer or nearest CASIO service provider. Using the camera under these conditions creates the danger of fire and electrical shock.
- Should you ever notice smoke or a strange odor coming out of the camera, immediately turn power off and unplug the AC adaptor from the power outlet. Using the camera under these conditions creates the danger of fire and electrical shock. After making sure there is no more smoke coming from the camera, take it to your nearest CASIO service provider for repair. Never attempt your own maintenance.
- At least once a year, unplug the AC adaptor from the power outlet and clean the area around the prongs of the plug. Dust build up around the prongs can create the danger of fire.
- If the camera's case should ever become cracked due to dropping it or otherwise subjecting it to rough treatment, immediately turn power off, unplug the AC adaptor from the power outlet, and contact your nearest CASIO service provider.
- Never use the camera inside of an aircraft or in any other areas where its use is prohibited. Doing so can result in an accident.
- Physical damage and malfunction of this camera can cause the image data stored in its memory to be deleted. Be sure to always keep backup copies of data by transferring them to personal computer memory.

INTRODUCTION

- Never open the battery compartment cover, disconnect the AC adaptor from the camera or unplug it from the wall socket while recording images. Doing so will not only make storage of the current image impossible, it can also corrupt other image data already stored in camera memory.

Operating conditions

- This camera is designed for use in temperatures ranging from 0°C to 40°C (32°F to 104°F).
- Do not use or keep the camera in the following areas.
 - In areas subject to direct sunlight
 - In areas subject to high humidity or dust
 - Near air conditioners, heaters, or other areas subject to temperature extremes
 - Inside of a closed vehicle, especially one parked in the sun
 - In areas subject to strong vibration

Condensation

- When you bring the camera indoors on a cold day or otherwise expose it to a sudden change of temperature, condensation can form on the exterior of the camera or on internal components. Condensation can cause malfunction of the camera, so you should avoid exposing it to conditions that might cause condensation.
- To keep condensation from forming, place the camera into a plastic bag before moving it into a location that is much warmer or colder than your current location. Leave it in the plastic bag until the air inside the bag has a chance to reach the same temperature as the new location.

Lens Precautions

- Fingerprints, dust, or any other soiling of the lens can interfere with proper image recording. Never touch the lens with your fingers. You can remove dust particles from the lens surface by using a lens blower to blow them off. Next, wipe the surface of the lens with a soft lens cloth.
- The lens of this camera extends from its body when you turn on power and retracts when you turn off power. Take care not to subject the lens to undue force or impact, and never set the camera face down so the lens is in contact with a tabletop, etc. Be sure to remove the lens cap before turning on the camera.
- If you align the power/function switch with  while the lens cap is on the lens, the message "LENS CAP" appears on the display and camera power turns off automatically. If this happens, remove the lens cap and try again.
- Never remove the camera's batteries or unplug its AC adaptor while the lens is extended. Doing so leaves the lens extended, and creates the risk of lens damage.

About the camera's backlight...

- The camera is equipped with a fluorescent light source to provide the back lighting for its LCD.
- The normal service life of the backlight is approximately six years, when the camera is used for about two hours a day.
- Should the LCD image appear abnormally dark, take the camera to your dealer or an authorized CASIO service provider to have the light source replaced. Note that you will be charged for this replacement.
- Under very cold conditions, the backlight may require more time than normal to light, or reddish bands may appear in the displayed image. These conditions do not indicate malfunction, and normal operation should return at higher temperatures.

GETTING ACQUAINTED

This section contains important information you should know when trying to operate the camera.

General Guide

The following illustrations show the names of each component, button, and switch on the camera.

Front

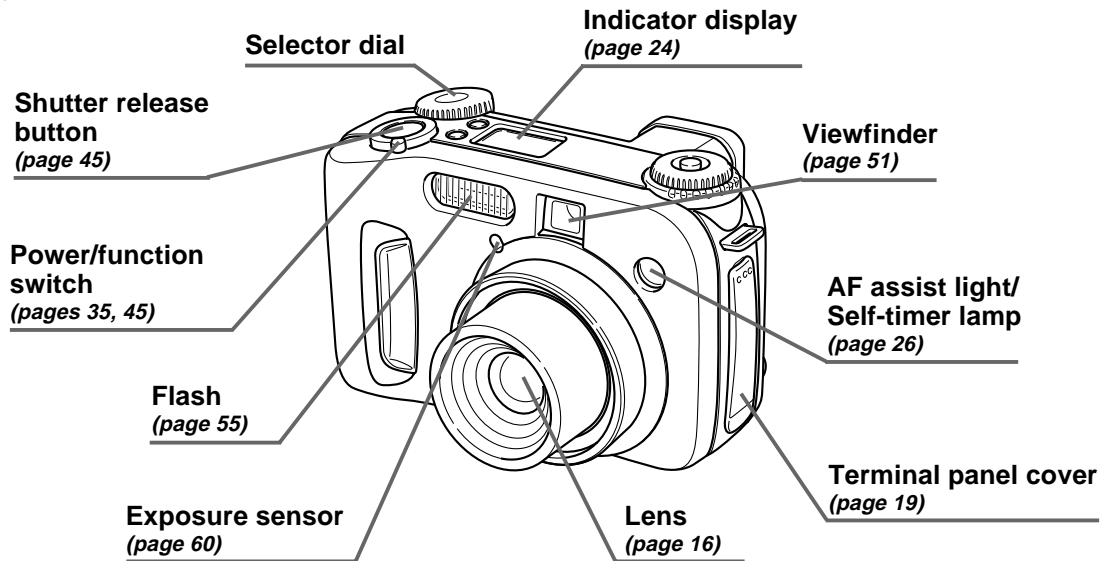

Back

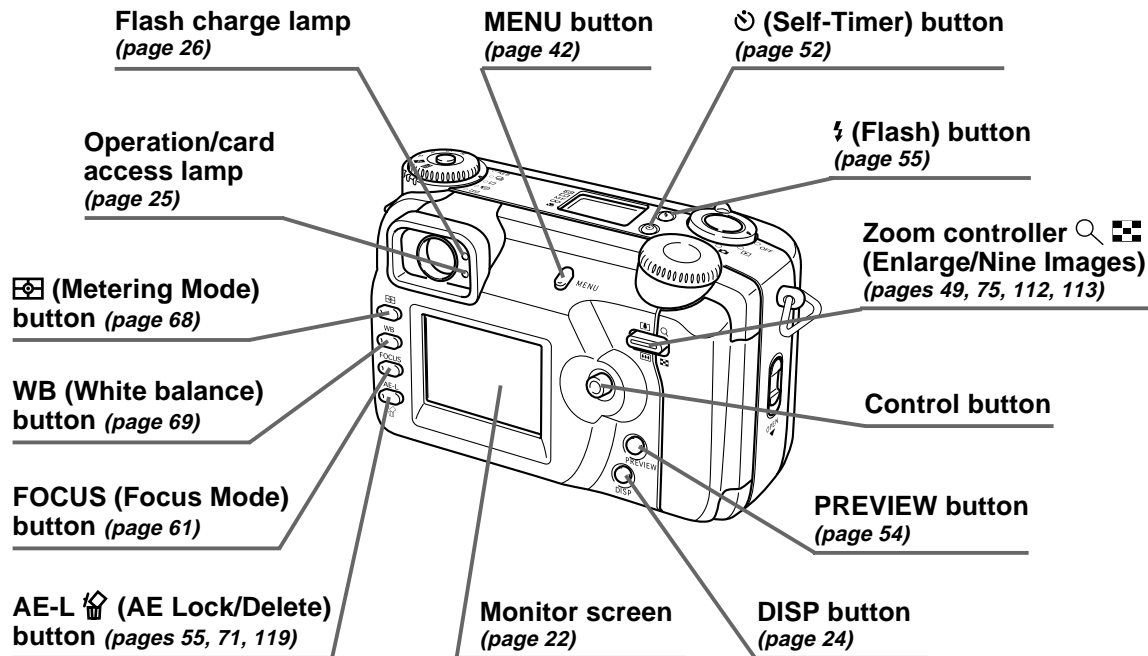

Side

DIGITAL terminal
(page 103)

Diopter dial
(page 51)

VIDEO OUT terminal
(page 137)

USB port
(page 139)

DC IN 6V terminal
(page 33)

**External flash
sync terminal**
(page 104)

**Memory card slot
cover** (pages 37, 38)

**Card slot cover
lock** (pages 37, 38)

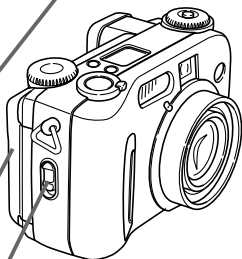
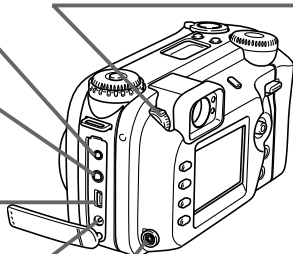

Bottom

**Tripod
screw hole**

**Battery compartment
cover lock** (page 29)

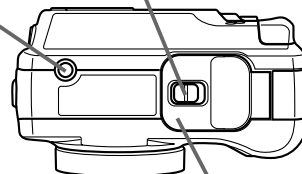

**Battery compartment
cover** (page 29)



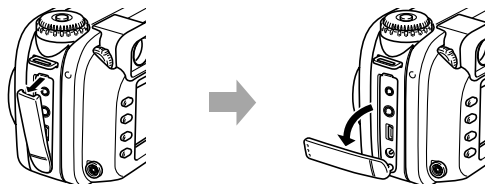

Open Terminal Panel Cover

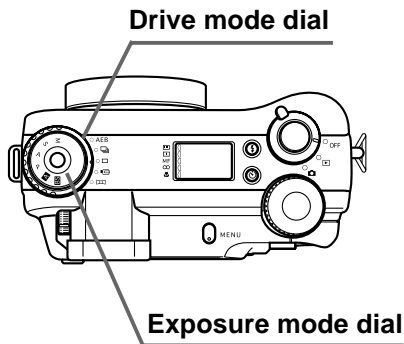

Mode Dials



■ Drive mode dial

AEB	Auto Exposure Bracketing (AEB)	page 89
	Continuous Shutter recording	page 88
	1-Image recording	page 54
	Movie recording	page 93
	Panorama recording	page 91

■ Exposure mode dial

M	M Mode (Manual Exposure)	page 87
S	S Mode (Shutter Speed Priority AE)	page 85
A	A Mode (Aperture Priority AE)	page 84
P	P Mode (Program AE)	page 83
A	Full Auto Mode	page 82
BS	Best Shot Mode	page 76

Using the Control Button

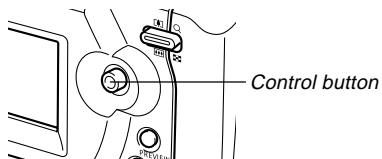

The control button is used to select menu items and execute function. The following are the terms used in this manual to describe control button operations.

Term	Meaning
Rock	Use your thumb to move the control button up, down, left, or right.
Click	Press the control button straight down until it clicks, something like a computer mouse.

Monitor Screen Indicators

The following describes the different indicators and markings that appear on the camera's monitor screen.

REC mode

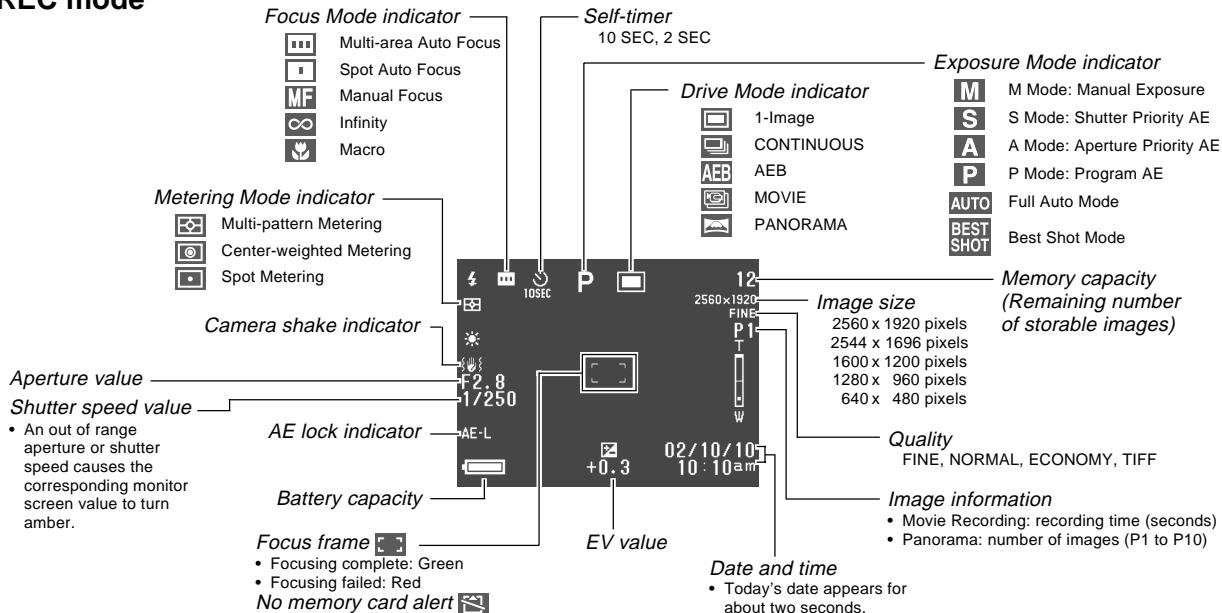

GETTING ACQUAINTED

Flash Mode indicator

None Auto



Flash On



Flash Off



Red-eye reduction

- Flash indicator indicates that the flash will fire (when auto flash is selected).

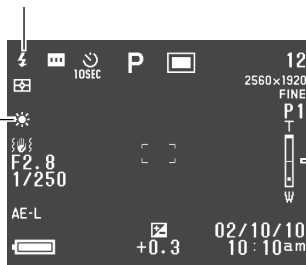

White balance indicator



Daylight

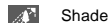

Shade

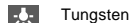

Tungsten

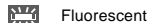

Fluorescent



Manual

Zoom bar

- Lower half indicates optical zoom.
Upper half indicates digital zoom.

PLAY mode

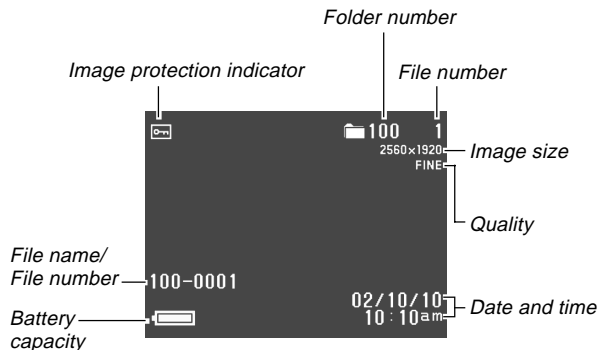

Changing the Contents of the Monitor Screen

Use DISP to cycle through monitor screen information settings as shown below.

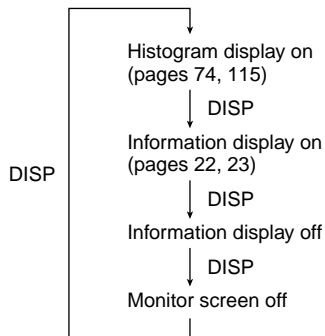

►► IMPORTANT! ◀◀

- The histogram is not displayed in the movie REC or PLAY mode (pages 93,110).

Indicator display

The indicator display located on the top of the camera also shows various camera status indicators during image recording. The indicator display comes in handy especially when the monitor screen is turned off.

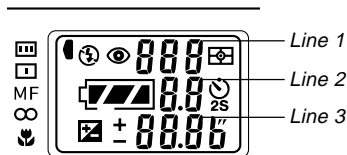

	Multi-area AF indicator		Multi-pattern Metering indicator
	Spot AF indicator		Center-weighted Metering indicator
MF	Manual focus indicator		Spot Metering indicator
	Infinity indicator		Battery capacity
	Macro mode indicator	Line 2	Aperture value
	Flash off indicator		Self-timer time settings
	Flash on indicator		Exposure compensation
	Red eye reduction indicator	Line 3	Shutter speed value/EV value
Line 1	Remaining number of images/File number		

Operation Indicator Lamp

Operation/card access lamp

The operation/card access lamp shows the operational status of the camera as described below.

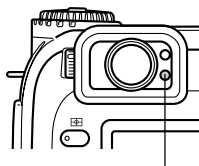

Operation/card access lamp

REC mode

Lamp Color	Flashing
Green	One of the following operations is in progress: start up, save (multiple), movie recording standby

- The camera is ready to record when the lamp is off.

Partial press of the shutter release button

Lamp Color	On
Green	Auto Focus complete
Red	Auto Focus operation failed

PLAY mode

Lamp Color	Flashing
Green	One of the following operations is in progress: delete, format, battery alert, card browser generation.
Red	Memory card is defective.

- The operation/card access lamp remains lit (green) while the monitor screen is turned off in the PLAY mode.

▶▶ IMPORTANT! ◀◀

- Never open the memory card cover while the operation/card access lamp is flashing.

Flash Charge lamp

The flash charge lamp also lights and flashes during a record operation as described below.

Flash charge lamp

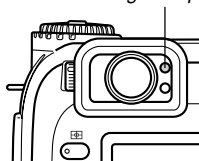

REC mode

Lamp Color	Flashing
Amber	Flash is charging.

Partial press of the shutter release button

Lamp Color	On
Amber	Ready to fire.

►► IMPORTANT! ◀◀

- When batteries go low, the operation/card access lamp and flash charge lamp flash amber for about one second. After that, the camera powers down automatically. If this happens, replace batteries as soon as possible.

AF Assist Light/Self-timer Lamp

The AF assist light operates automatically to assist the Auto Focus operation whenever you are shooting where lighting is dim. This lamp also flashes to indicate the countdown until the shutter releases during a self-timer operation.

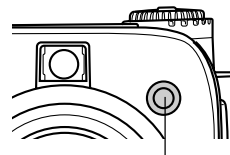

AF assist light/self-timer lamp

►► IMPORTANT! ◀◀

- Auto Focus using the AF assist light/ self-timer lamp is possible when the distance from the camera to the subject is less than about 2.5 meters (8.2').
- When the AF assist light operates while Multi-area AF or Spot AF is specified as the focus mode, the camera automatically assumes that focus area is the center area for Spot AF. See pages 62 and 63 for more information.
- Do not look directly at the AF assist light/self-timer lamp or point it directly at the subject's eyes.

Using the Bundled Accessories

Attaching the Neck Strap

Attach the neck strap to the strap ring as shown in the illustration below.

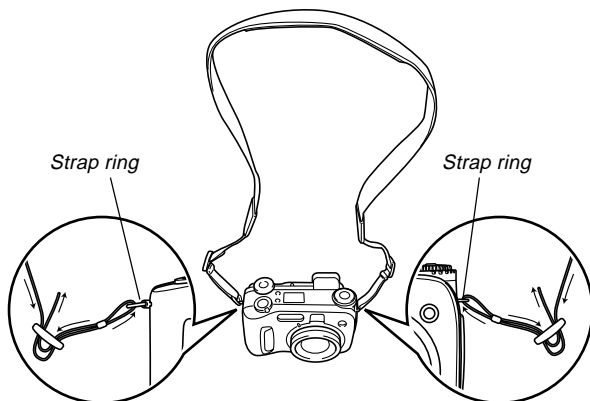

Adjusting the Length of the Neck Strap

Use the buckle to adjust the length of the neck strap.

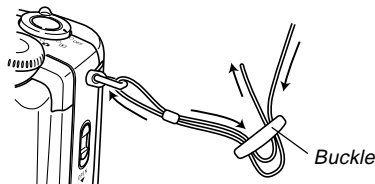

▶▶ IMPORTANT! ◀◀

- Be sure to keep the neck strap around your neck when using the camera to protect against accidentally dropping it.
- The supplied neck strap is intended for use with this camera only. Do not use it for any other application.
- Never swing the camera around by the neck strap.
- Allowing the camera to swing freely from your neck can result in damage to the camera due to its bumping against other objects. It also creates the danger of the camera becoming caught in a door or on other objects, resulting in personal injury.
- Keep the camera out of the reach of small children, especially when the neck strap is attached. The neck strap can accidentally wind around the neck of a child and create the risk of strangulation.

Using the Lens Cap

Always keep the lens cap on the lens whenever you are not using the camera. Always leave the lens cap on the lens when the camera is turned off and the lens is retracted.

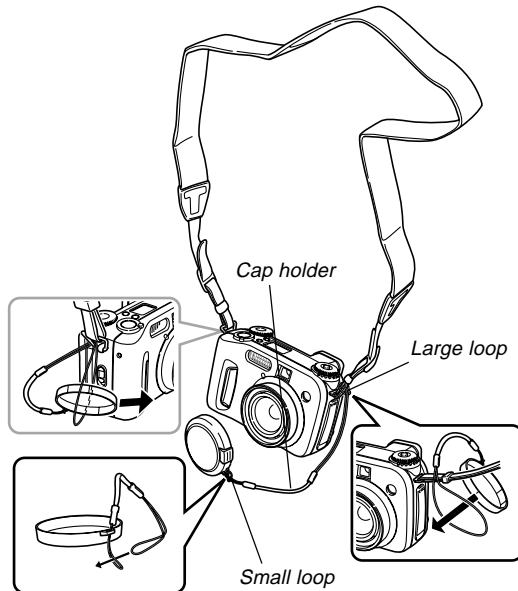

Attach the lens cap holder to the neck strap or the strap ring. This protects against accidental loss of the lens cap.

►► IMPORTANT! ◀◀

- Never turn on camera power with the lens cap affixed to the lens.

Power Requirements

Your camera features a two-way power supply that lets you use either AA-size batteries or household AC current.

■ Batteries

- Four AA-size alkaline batteries: LR6
- Four AA-size lithium batteries: FR6
- Four AA-size nickel-metal hydride rechargeable batteries: NP-H3

■ Household Current

- AC Adaptor: AD-C620 (Option)
- AC Adaptor/Charger: BC-3HA (Option)

Loading Batteries

Make sure that camera power is turned off whenever loading or replacing batteries.

- 1. On the bottom of the camera, slide the battery compartment cover lock in the direction indicated by the arrow and open the battery compartment cover.**

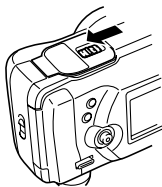

- 2. Load the batteries so their plus (+) and minus (-) ends are facing as shown in the illustration.**



- 3. Close and press down on the battery compartment cover as you slide the battery compartment cover lock in the direction indicated by the arrow to lock it.**



▶▶ IMPORTANT! ◀◀

- Never use manganese batteries. Use only the battery types specifically mentioned in this User's Guide.

GETTING ACQUAINTED

● Battery Life Guidelines

The battery life guideline values given below indicate the amount of time at standard temperature (25°C (77°F)) until power automatically turns off due to battery failure. They do not guarantee that batteries will provide the amount of service indicated. Low temperatures reduce battery life.

Type of Operation	Continuous Playback*2	Continuous Recording*1
AA-size Alkaline Batteries LR6	180 minutes	75 minutes (460 shots)
AA-size Lithium Batteries FR6	320 minutes	180 minutes (1130 shots)
AA-size Ni-MH Batteries NP-H3	180 minutes	90 minutes (540 shots)

*1 Continuous Recording Conditions

- Normal temperature: 25°C (77°F)
- Flash: Off
- Monitor screen: On
- Image recorded about every 10 seconds using the following operations: Zoom to full wide angle → Auto Focus → Zoom to full close-up → Auto Focus → Image recording
 - Recording one image per minute under the above conditions reduces battery life to about one sixth of that noted above.

*2 Continuous Playback Conditions

- Normal temperature: 25°C (77°F)
- Scroll one image about every 10 seconds

- The above values are approximations only.
- The above guidelines are based on the following battery types:
 - Alkaline: MX1500 (AA) DURACELL ULTRA
 - Lithium: Energizer
- * Battery life varies with brand.
- Battery life is greatly affected by how much you use flash, zoom and other functions, and how long you leave power turned on.

● Tips for Prolonging Battery Life

- Use  to turn off the flash when you are not using it (page 55).
- You can also use the power save settings (page 35) to protect against wasting battery power when you forget to turn off the camera.
- You can also conserve battery power by using DISP to turn off the monitor screen.

● Alkaline Battery Life

The actual life of alkaline batteries is affected by a variety of factors, including the battery manufacturer, the amount of time the batteries spend in storage before you use them, temperature while you are recording, and photographic conditions. As a rule, we recommend the use of lithium batteries or Ni-MH batteries, which have longer lives than alkaline batteries.

GETTING ACQUAINTED

The following examples show how alkaline battery life changes under different shooting conditions.

Example 1: Intermittent use of the camera shortens battery life.

Conditions

- Temperature: 25°C (77°F)
- Repeat of a cycle of recording of one shot per minute for 10 minutes, followed by one minute of playback, and nine minutes of power off (power on, full lens extension, half lens contraction, full lens extension, image recording, power off)
- Flash on

Approximate Battery Life: 35 minutes (32 shots)

Example 2: Low temperatures shorten battery life.

Conditions

- Temperature: 0°C (32°F)
- Repeat of a cycle of recording of one shot per minute for 10 minutes, followed by one minute of playback, and nine minutes of power off (power on, full lens extension, half lens contraction, full lens extension, image recording, power off)
- Flash on

Approximate Battery Life: 8 minutes (8 shots)

● About rechargeable batteries

Use only the nickel-metal hydride batteries (NP-H3) that are specifically recommended for this camera. Proper camera operation is not guaranteed when other rechargeable batteries are used.

AC Adaptor/Charger : BC-3HA

Nickel-metal hydride batteries (4-battery set)/Quick Charger Set : BC-1HB4

Nickel-metal hydride batteries (4-battery set) : NP-H3P4

))) IMPORTANT! (((

- Be sure to keep all four batteries together as a set at all times, for both charging and powering the camera. Mixing batteries from different sets can shorten overall battery life and cause malfunction of the camera.
- Batteries cannot be charged while they are loaded in the camera.

Battery Handling Precautions

Incorrect use or handling of batteries can cause them to leak or burst and create the danger of serious damage to your camera. Be sure to note the following important precautions to avoid problems with batteries.









CAUTION

- Use only LR6 (AM-3) type alkaline or FR6 type lithium or Ni-MH (nickel-metal hydride) dry cell batteries with this camera. Never mix old batteries with new ones. Doing so can result in bursting or leaking of batteries, creating the danger of fire or personal injury.
- Always make sure that the plus (+) and minus (–) ends of the batteries are facing correctly, as noted by the markings on the camera itself. Improper loading of batteries can result in bursting or leaking of batteries, creating the danger of personal injury or soiling of objects nearby.

- Remove batteries from the camera if you do not plan to use it for more than two weeks.
- Never recharge non-rechargeable type batteries, never allow direct connection between two ends of a battery, and never try to take batteries apart.
- Do not expose batteries to direct heat or dispose of them by burning. Doing so can create the danger of explosion.
- Never mix batteries of different types.
- Dead batteries are susceptible to leakage, which can cause serious damage to your camera. Remove batteries from the camera as soon as you notice they are dead.
- The batteries that power the camera normally become warm as they discharge.

Low Battery Indicator

The following shows how the battery capacity indicator on the monitor screen and the indicator display changes as battery power is used. Replace all four batteries as soon as possible after they go dead. If you continue to use the camera while the battery level is , camera power will automatically turn off.

Battery Capacity	High ←————→ Low
Monitor Screen	 →  → 
Indicator Display	 →  → 

Using AC Power

Use the adaptor as shown below to power the camera from a household power outlet.

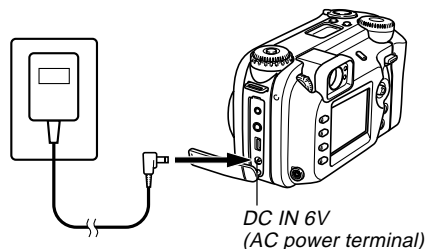

- AC Adaptor: AD-C620 (Option)
- AC Adaptor/Charger: BC-3HA (Option)
The BC-3HA functions both as an AC adaptor and as a charger unit for AA-size nickel metal hydride batteries. It comes complete with four rechargeable nickel metal hydride batteries. This AC adaptor/charger unit can be used with any household power outlet rated for 100V to 240V AC.

AC Adaptor precautions

- Never use an electrical outlet whose voltage is outside the rating marked on the AC adaptor. Doing so can create the danger of fire or electric shock. Use only the optional AC adaptor specified for this camera.
- Do not allow the AC adaptor power cord to become cut or damaged, do not place heavy objects on it, and keep it away from heat. A damaged power cord creates the risk of fire and electric shock.
- Never try to modify the AC adaptor power cord, or subject it to severe bending, twisting, or pulling. Doing so creates the risk of fire and electric shock.
- Never touch the AC adaptor while your hands are wet. Doing so creates the risk of electric shock.
- Do not overload extension cords or wall outlets. Doing so creates the danger of fire and electric shock.
- Should the cord of the AC adaptor become damaged (exposed internal wiring), request a replacement from an authorized CASIO service provider. A damaged AC adaptor cord creates the danger of fire or electric shock.





- Be sure to turn off power before connecting or disconnecting the adaptor.
- Always turn camera power off before disconnecting the AC adaptor, even if the camera has batteries installed. If you don't, the camera will turn off automatically when you disconnect the AC adaptor. You also run the risk of damaging the camera whenever you disconnect the AC adaptor without first turning power off.
- The AC adaptor may become warm to touch after extended periods of use. This is normal and is not cause for alarm.
- After using the camera, turn it off and unplug the adaptor from the AC outlet.
- The camera automatically switches over to AC adaptor powered operation whenever the AC adaptor is plugged into the camera.
- Always use the AC adaptor to power the camera whenever it is connected to a computer.





Turning the Camera On and Off

Rotate the power/function switch to turn camera power on and off.



-  : Turns on power and enters the REC mode.
-  : Turns on power and enters the PLAY mode.
- OFF : Turns off power.

»» IMPORTANT! ««

- Never align the power/function switch with  while the lens cap is on the lens.
- Never align the power/function switch with  while the lens is facing downwards towards the ground.
- To restore camera power after it has been turned off by auto power off, rotate the power/function switch to OFF and then back to  or .

Power Save Settings

The settings described below let you specify sleep and auto power off trigger times that help to conserve valuable battery power.

AUTO POWER OFF

Auto Power Off turns off camera power if no operation is performed for five minutes in the PLAY mode. In the REC mode, you can specify an Auto Power Off trigger time of two or five minutes.

SLEEP

The monitor screen enters a sleep state if no operation is performed for a specified amount of time in the REC mode. Pressing any button immediately wakes up the monitor and restores normal operation. You can specify 30 seconds, 1 minute, or 2 minutes before the sleep state is triggered, or you can turn off this setting entirely.

To configure power save settings

1. Align the power/function switch with .
2. Press MENU.
3. Rock the control button up or down to select “Power Save” and then rock the control button to the right.
4. Rock the control button up or down to select the item whose settings you want to change, and then rock the control button to the right.
 - To make auto power off settings, select “Auto Power Off”.
 - To make sleep settings, select “Sleep”.
5. On the screen that appears, rock the control button up or down to make the setting you want, and then click the control button to apply it.

Auto power off settings: “2 min” “5 min”
Sleep settings: “Off” “30 sec” “1 min” “2 min”
6. Press MENU to exit the setting procedure.

- In the PLAY mode, the Auto Power Off trigger time is fixed at five minutes.
- Sleep is disabled in the PLAY mode.
- Performing any button operation while the monitor is asleep immediately wakes it up and restores normal operation.
- The Auto Power Off setting is given priority if you have “2 min” set for both Sleep and Auto Power Off. This means that the camera turns off if you do not perform any operation for about two minutes in the REC mode.
- Auto Power Off is automatically disabled under any one of the following conditions.
 - While a slideshow is playing
 - When you are performing operations on a computer connected to the camera's USB port
 - While the AC adaptor is connected to the camera

Memory Cards

This camera supports use of a CompactFlash memory card (CF TYPE I/II) or IBM Microdrive for image storage. Note that all mentions of “memory” card in this manual refer both to a CompactFlash memory card and IBM Microdrive, unless specifically noted otherwise.

» IMPORTANT! «

- Make sure that the power of the camera is turned off before you insert or remove a memory card.
- When inserting a memory card into the camera, make sure its correct side is facing up and that you insert its terminal end into the camera. Trying to force a card into the camera can damage the card and the camera.

Inserting a Memory Card into the Camera

1. Slide the card slot cover lock in the direction indicated by the arrow and open the memory card slot cover.

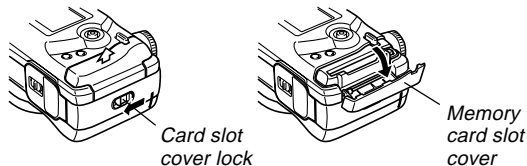

2. With the side of the memory card that has an arrow marked facing towards the memory card slot cover, slide the card into the camera as far as it will go.

- If the eject button is extended, press it in before sliding the memory card into the slot.

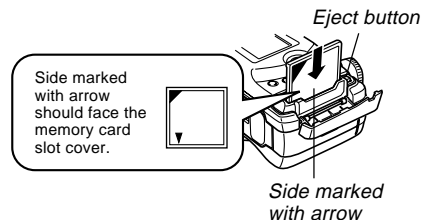

3. Close the memory card slot cover.



Removing a Memory Card from the Camera

1. Slide the card slot cover lock in the direction indicated by the arrow and open the memory card slot cover.

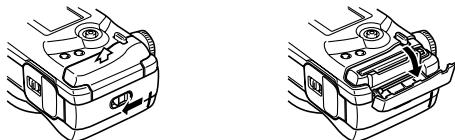

2. Press the eject button so it extends from the camera.

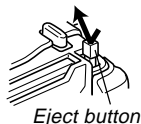

3. Press the eject button once again to eject the card.

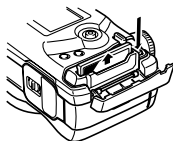

4. Remove the memory card.

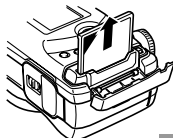

5. Close the memory card slot cover.



▶▶ IMPORTANT! ◀◀



- Insert only memory cards into the memory card slot. Inserting any other type of card can cause malfunction.
- Should water or any other foreign matter get into the memory card slot, immediately turn off power, unplug the AC adaptor, and contact your original retailer or nearest CASIO Service Provider.
- Never eject the memory card while the card slot is facing downwards. Doing so creates the danger of the memory card falling, which can corrupt data or damage the memory card.
- Never remove the memory card from the camera while the operation/card access lamp is flashing. Doing so can cause loss of recorded images or corruption of memory card data.

Formatting a Memory Card

You can format a memory card to delete all of the data stored on it.

▶▶ IMPORTANT! ◀◀

- Formatting a memory card deletes all images on the card, even if some or all of the images are protected (page 125).
- Formatting a memory card deletes all Best Shot Mode scene files you have imported from the CD-ROM and stored on the card. After formatting the card, you have to import the Best Shot scene files you want to the memory card (page 77).
- Data deleted by a memory card format operation cannot be recovered! Be sure to carefully check and confirm that you no longer need the data stored in a memory card before formatting it.

1. Align the power/function switch with  or .
2. Press MENU.
3. Select “Format” and then rock the control button to the right (page 42).
4. In response to the confirmation message that appears, rock the control button up or down to select “Yes” to format or “No” to exit and then click the control button.

Yes : Formats the memory card.

No : Does not format the memory card.

Memory Card Precautions

- Images cannot be recorded with this camera unless a memory card is installed in it.
 - Be sure to use only CASIO or SanDisk CompactFlash cards, or an IBM Microdrive. Proper operation is not guaranteed with other memory cards.
 - Static electricity, electrical noise, and other electrical phenomena can cause corruption or even total loss of data stored on a memory card. Because of this, you should always make backup copies of important images on other media.
 - Memory card problems can be corrected by reformatting the memory card. Reformatting a memory card deletes all images stored on the card, but you can use a computer to copy the images you want to keep to the computer's hard disk before reformatting your card. If you plan to be recording images where you do not have access to a computer, it is a good idea to take along an extra memory card or two just in case you experience an unexpected memory card problem.
- Formatting is recommended for any memory card that you suspect contains corrupted image data (due to a RECORD ERROR, strange image colors, malformed images) or for newly purchased memory cards.
 - Before starting a format operation, switch to AC adaptor power or load a new set of recommended batteries into the camera.

IBM Microdrive Precautions

Compatibility of the camera with the IBM Microdrive has been confirmed by CASIO. However, you should note the following important points whenever using the IBM Microdrive.

- Be sure to carefully read all of the documentation that comes with the Microdrive before using it.
- Note that the Microdrive becomes hot during normal use. Take care when removing it from the camera.
- Take care to avoid strong pressure on the label side of the Microdrive when it is removed from the camera. Strong pressure can damage internal components and cause malfunction.
- Never turn off camera power or subject the camera to impact while the operation/card access lamp is flashing. Doing so can cause malfunction of the Microdrive.
- The Microdrive is a very high precision device. Dropping the camera can result in malfunction of the Microdrive, even though the camera is undamaged. Take extra care when handling the camera while the Microdrive is installed.
- The Microdrive has very large storage capacity. Because of this, certain operations can take a relatively long time to perform.
- The Microdrive may not operate properly in areas where barometric pressure is low. Because of this, you should avoid using it at high altitudes.

- A Microdrive consumes much more electrical power than a CompactFlash card. Depending on how a Microdrive is used, it can greatly reduce battery life. When using alkaline batteries, certain operating conditions and certain battery brands can result in batteries going dead right after you install new ones. Whenever using a Microdrive, we recommend that you use rechargeable nickel metal hydride batteries or lithium batteries to power the camera.
- When battery power is low, the amount of time required between shots may become longer. This longer interval is designed to protect the Microdrive.

In case of Microdrive malfunction....

- Contact your original Microdrive retailer or the contact point noted in the Microdrive documentation.
- CASIO does not provide any servicing or maintenance support for the Microdrive.
- Note that CASIO assumes no responsibility for any data loss you may suffer while using the Microdrive.
- This camera supports use of both a CompactFlash card and the Microdrive. Note, however, that ejecting a Microdrive from the camera is relatively more difficult than ejecting a CompactFlash card.

Menu Screens

Pressing MENU displays the menu screen. The contents of the menu screen depend on whether you are in the PLAY mode or REC mode. The following procedure shows operation in the REC mode as an example.

1. Align the power/function switch with .

- To perform a menu operation in the PLAY mode, align the power/function switch with .

2. Press MENU.



If you want to do this:	Do this:
Select a menu item	Rock the control button up or down.
Display details of the selected menu item	Rock the control button to the right.
Execute the selected item	Click the control button.
Back step to the previous screen	Press MENU.

3. Rock the control button up or down to select the menu item you want, and then rock the control button to the right.

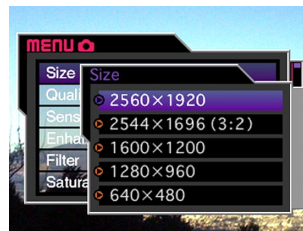

- See the “Camera Menus” on page 159 for more information about menu contents.

Setting the Current Date and Time



Use the following procedures to set the current date and time, and to select the date format.

When you record an image, the time and date the image was shot is registered in accordance with data from the camera's built-in clock. You can even use the time stamp function to "stamp" the date and time inside the image (page 100).

▶▶ IMPORTANT! ◀◀

- The time and date settings are cleared if the camera is left for about 24 hours without battery and AC power being supplied. If this happens, restore power and make new time and date settings before using the camera again.
- A flashing time display indicates that the time and date (clock) settings have been cleared. Use the procedure on this page to make the correct time and date settings.
- If you do not set the camera's built-in clock to the current date and time, all images are recorded with the default date and time, which probably is not your correct current date and time. Be sure to correctly set the clock before you use the camera.

Setting the Date and Time

1. Align the power/function switch with  or .
2. Press MENU.
3. Select "Date" and then rock the control button to the right.
4. Select "Adjust" and then rock the control button to the right.
5. Select and change the digits on the screen to set the current date and time.

Purple selection boundary





GETTING ACQUAINTED

If you want to do this:	Do this:
Move the selection boundary	Rock the control button to the left or right.
Increase or decrease the value where the selection boundary is located	Rock the control button up or down.

6. Click the control button to apply your settings.
7. Press MENU to exit the setting procedure.

Selecting the Date Format

You can use the following procedure to select one of the three different date formats.

1. Align the power/function switch with  or .
2. Press MENU.
3. Select "Date" and then rock the control button to the right.
4. Select "Date Style" and then rock the control button to the right.
5. Rock the control button up or down to select the setting you want to use, and then click the control button to apply it.

Example: October 23, 2002

Year/Month/Day: 02/10/23

Day/Month/Year: 23/10/02

Month/Day/Year: 10/23/02

6. Press MENU to exit the setting procedure.

BASIC IMAGE RECORDING



This section describes the basic procedure for recording an image using the Full Auto Mode. It also explains about basic camera settings.

Using the Full Auto Mode



The Full Auto Mode makes it easy even for complete novices to record good-looking digital images every time. The camera makes focus, shutter speed, aperture, flash and other settings automatically in accordance with subject brightness.

►► IMPORTANT! ◀◀

- In the Full Auto Mode, all keys except for the shutter release button, DISP, the zoom controller, and  are disabled. See "Program AE vs Full Auto" on page 83 for more information.

1. Before turning on the camera, remove its lens cap.
2. Align the exposure mode dial with  (Full Auto Mode).
3. Align the drive mode dial with  (1-Image).

4. Align the power/function switch with .

-  : Turns on power and enters the REC mode.
-  : Turns on power and enters the PLAY mode.
- OFF : Turns off power.



5. Compose the image as you view it on the monitor screen.

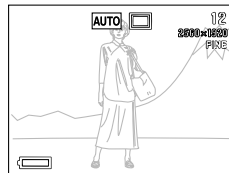

- If you prefer to use the optical viewfinder to compose the image, press DISP to turn off the monitor screen.

6. Press the shutter release button about half way and hold it there to perform auto focus.

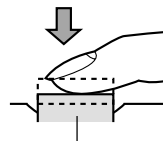

Shutter release button

BASIC IMAGE RECORDING

- Pressing the shutter release button causes the focus frame to appear on the monitor screen (page 62).
- Multi-area Auto Focus (page 62) automatically focuses the image and displays shutter speed and aperture values.
- You can find out the status of the Auto Focus operation by checking the color of the focus frame and the status of the operation/card access lamp.

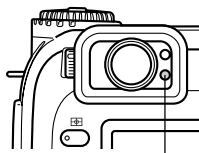

Operation/card access lamp

If you see this:	It means this:
Focus frame: Green	The image is in focus.
Operation/card access lamp: Green	
Focus frame: Red	The image is not in focus.
Operation/card access lamp: Red	

- Take care that you do not block the lens or the sensors with your fingers as you hold the camera.



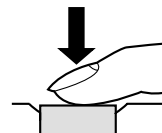

- 7. After confirming that the image is in focus, press the shutter release button all the way down to record the image.**



- Recorded images are temporarily stored in a buffer from which they are stored to the memory card. You can continue to shoot consecutive images as long as there is space available in the buffer.
- The number of images you can store in the camera depends on the storage medium and the image quality setting (pages 95, 169) you are using.
- To avoid hand movement, press the shutter release button gently.

►► IMPORTANT! ◀◀

- In any of the following cases, the message “One moment please...” appears on the display after you record each image as it is saved to the memory card.
 - When you are recording TIFF (uncompressed) images (page 95)
 - When you are recording a movie or panorama (pages 91, 93)
 - When you are recording using certain Best Shot scene setups (page 76)
 - When the  low battery indicator is on the display while you are using a CompactFlash card (page 33)
 - When the  low battery indicator is on the display while you are using an IBM Microdrive (page 33).
- Recording images in the Full Auto Mode causes a number of camera settings to be made automatically in accordance with shooting conditions. See “Full Auto Mode Settings” on page 163 for more information.

Recording Precautions

- Never remove the camera's batteries, disconnect the AC adaptor, or remove the memory card from the camera while it is saving images to its memory card. Doing so not only causes a loss of the image being saved, it can also corrupt images already stored on the memory card.
- Fluorescent lighting actually flickers at a frequency that cannot be detected by the human eye. When using the camera indoors under such lighting, you may experience some brightness or color problems with recorded images.

Focusing

The Full Auto Mode uses Multi-area AF, which measures three distances and automatically focuses on the subject nearest to the camera. Note that the focusing range is approximately 30 cm to ∞ (11.8" to ∞).

►► IMPORTANT! ◀◀

- You cannot select a different focusing method when using the Full Auto Mode (Page 61).

About Auto Focus

Auto Focus tends not to work well with the types of subjects listed below.

- Solid color walls or objects with little contrast
- Strongly backlit objects
- Polished metal or other brightly reflective objects
- Venetian blinds or other horizontally repeating patterns
- Multiple images that are varying distances from the camera
- Subjects in poorly lit areas
- Moving subjects

Auto Focus also may not work properly when the camera is unsteady or shaking.

■ Fixed Focusing Distances

- Depending on actual conditions, a green operation/card access lamp and focus frame do not necessarily guarantee that the image is in focus.

Image Recording when the Batteries are Low

To protect against unexpected loss of image data, each image is recorded directly to the memory card (without going into the buffer) whenever battery level is indicated as  or lower. The message “ **DISP** Press to cancel save” appears on the monitor screen during the save operation under this condition. As long as you do not press DISP, the save operation continues and takes a few seconds to complete. Pressing DISP while the “ **DISP** Press to cancel save” is on the monitor screen cancels the image save operation.

- If you have a Microdrive loaded in the camera, the above message appears whenever the battery level is indicated as  or lower.
- The message “ **DISP** Press to cancel save” also appears momentarily during save operations in the Panorama Mode, Movie Mode, and when you are using certain Best Shot scene setups. In this case, this message does not indicate that battery power is low.
- The message described above does not appear while the monitor screen is turned off.





About the REC Mode Monitor Screen

- The actual image is recorded and saved in accordance with the image quality setting currently selected on your camera. The image recorded on the memory card has much better resolution and detail than the REC mode monitor screen image.
- Certain levels of subject brightness can cause the response of the REC mode monitor screen to slow down, which causes some static noise in the monitor screen image.

Using Optical Zoom

Optical zoom enlarges the image by changing the focal distance of the lens. You can zoom an image by a zoom factor ranging from 1 (normal size) to 3 (three times normal size).

1. Align the power/function switch with .

2. Push the zoom controller upwards towards  (telephoto)  to zoom in on the subject, or downwards towards  (wide-angle)  to zoom out.



Zoom controller



 (telephoto)

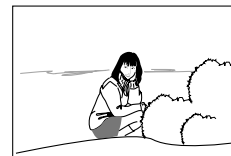

 (wide-angle)

»» NOTES ««

- Changing the optical zoom factor also affects the lens aperture value.
- The lens aperture value indicated on the camera is the aperture when optical zoom is 1X. Using a higher optical zoom setting results in a higher aperture value (smaller aperture).
- Use of a tripod is recommended for telephoto shots to avoid blurring of the image due to camera movement.

Using the Viewfinder for Recording

The illustrations below show what you see when you look through the viewfinder to compose an image for recording.

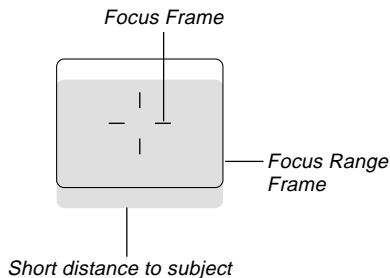

Note that the focus range frame is valid for subjects that are about three meters (9.8') away. A different focus range is used for subjects that are closer or farther away. Because of this, you should change to the Manual Focus Mode (MF) or Macro Mode (M) whenever the distance between the camera and the subject is 30cm (11.8") or less (pages 64, 65).

- The monitor screen turns on automatically whenever the camera is in the Manual Focus Mode or Macro Mode. Use the monitor screen to compose images in the Manual Focus Mode or Macro Mode.

- You can use the Diopter Dial to adjust the image in viewfinder screen to your eyesight.

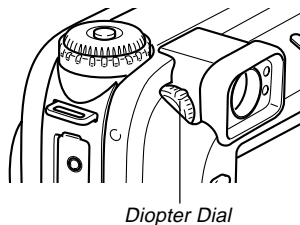



▶▶ IMPORTANT! ◀◀

- Focusing of the viewfinder image is disabled while the camera is turned off or in the PLAY mode.

Using the Self-timer

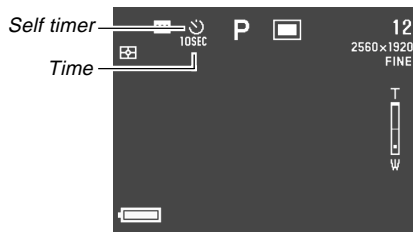
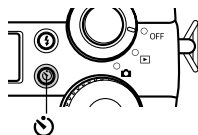

You can set the self-timer to either one of two starting times.

1. Align the power/function switch with .
2. Press  to select the self-timer time you want.



Self-timer Time Settings:

Each press of  cycles through the available self-timer settings described below.

To do this:	Select this setting:
Turn the self-timer off	No display
Record 10 seconds after the shutter release button is pressed	
Record two seconds after the shutter release button is pressed	

3. Press the shutter release button to start the self-timer countdown.

- The AF assist light/self-timer lamp flashes as the seconds are counted down. If you have the monitor screen turned on, the seconds are counted down on the screen.
- To stop a countdown part way through, press the shutter release button.

NOTES

- The hand-shake limiter is enabled when you use a slow shutter speed and the two-second self-timer at the same time.
- You cannot use the self-timer in combination with the Continuous Shutter Mode.

Camera Orientation Detection

The camera automatically detects whether it is oriented vertically or horizontally when you record an image, and stores the orientation along with the image data.

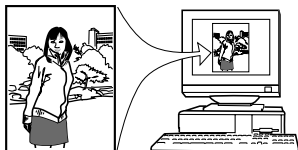

When you display the images on the camera's monitor screen, they are automatically oriented correctly as you recorded them. You can also configure the bundled Photo Loader application (page 139) so it automatically positions each image using the orientation data stored with it.

►► IMPORTANT! ◀◀

- Note that all images are displayed on the camera's monitor screen using standard horizontal orientation during fast scrolling of images, on the 9-image screen, and on all image selection menu screens.
- Note the following precautions to ensure that the sensor built into the camera can correctly detect the orientation of the camera.
 - Make sure you are holding the camera still when recording images. Camera movement can cause sensor errors.

- When recording portrait orientation images, position the camera so it is standing up as straight as possible, as shown in the illustration below. Holding the camera at an angle can cause sensor errors. As a general rule, do not allow the camera to be more than about 20 degrees off of vertical.

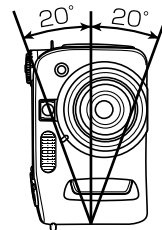

- Tilting the camera too far upwards or downwards can also cause sensor errors. As a general rule, do not allow the camera to point more than about 60 degrees up or down.

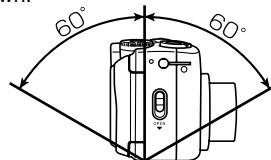

- The camera orientation sensor does not work with movie images.

Free Manuals Download Website

<http://myh66.com>

<http://usermanuals.us>

<http://www.somanuals.com>

<http://www.4manuals.cc>

<http://www.manual-lib.com>

<http://www.404manual.com>

<http://www.luxmanual.com>

<http://aubethermostatmanual.com>

Golf course search by state

<http://golfingnear.com>

Email search by domain

<http://emailbydomain.com>

Auto manuals search

<http://auto.somanuals.com>

TV manuals search

<http://tv.somanuals.com>