

fx-FD10 Pro

User's Guide

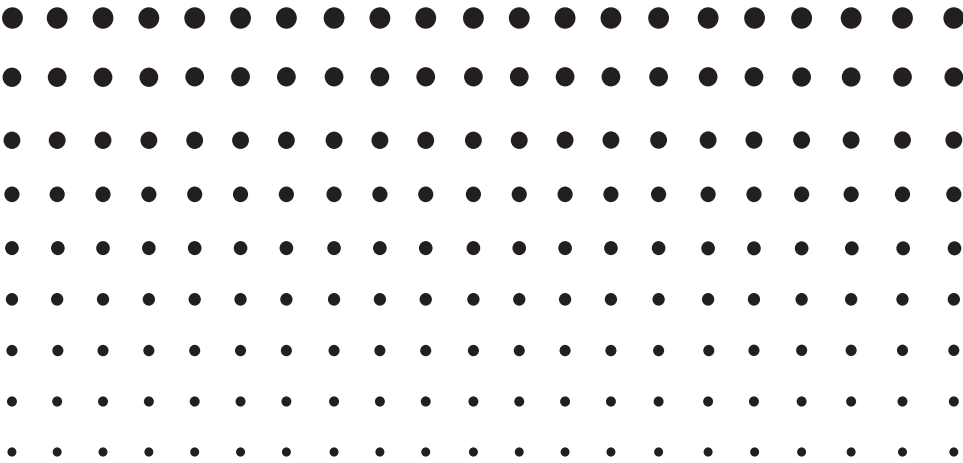

GUIDELINES LAID DOWN BY FCC RULES FOR USE OF THE UNIT IN THE U.S.A. (not applicable to other areas).

NOTICE

This equipment has been tested and found to comply with the limits for a Class B digital device, pursuant to Part 15 of the FCC Rules. These limits are designed to provide reasonable protection against harmful interference in a residential installation. This equipment generates, uses and can radiate radio frequency energy and, if not installed and used in accordance with the instructions, may cause harmful interference to radio communications. However, there is no guarantee that interference will not occur in a particular installation. If this equipment does cause harmful interference to radio or television reception, which can be determined by turning the equipment off and on, the user is encouraged to try to correct the interference by one or more of the following measures:

- Reorient or relocate the receiving antenna.
- Increase the separation between the equipment and receiver.
- Connect the equipment into an outlet on a circuit different from that to which the receiver is connected.
- Consult the dealer or an experienced radio/TV technician for help.

FCC WARNING

Changes or modifications not expressly approved by the party responsible for compliance could void the user's authority to operate the equipment.

Proper connectors must be used for connection to host computer and/or peripherals in order to meet FCC emission limits.

USB connector that comes with the fx-FD10 Pro
Power Graphic Unit to Windows® compatible PC

Declaration of Conformity

Model Number: fx-FD10 Pro
Trade Name: CASIO COMPUTER CO., LTD.
Responsible party: CASIO AMERICA, INC.
Address: 570 MT. PLEASANT AVENUE, DOVER, NEW JERSEY 07801
Telephone number: 973-361-5400

This device complies with Part 15 of the FCC Rules. Operation is subject to the following two conditions: (1) This device may not cause harmful interference, and (2) this device must accept any interference received, including interference that may cause undesired operation.

Important!

The splash resistance and dust resistance performance of the calculator are based on CASIO testing methods. Indicated performance is based on performance at the time of shipment from the factory (at the time of delivery to you). CASIO makes no guarantee that such performance will be provided in environments where you use the calculator. Also note that submersion in water during use is not covered by the warranty, so be sure to take the same precautions that you take with other electrical devices whenever using this calculator in the rain.

- The contents of this user's guide are subject to change without notice.
- No part of this user's guide may be reproduced in any form without the express written consent of the manufacturer.
- Microsoft, Windows, and Windows Vista are registered trademarks or trademarks of Microsoft Corporation in the United States and other countries.
- Mac OS is a trademark of Apple, Inc. in the United States and other countries.
- The SDHC Logo is a trademark of SD-3C, LLC.
- Company and product names used in this manual may be registered trademarks or trademarks of their respective owners.

Contents

Chapter 1 Getting Acquainted — Read This First!

1. BEFORE USING THE CALCULATOR FOR THE FIRST TIME.....	1-1
2. Handling Precautions.....	1-3
3. LCD and Key Back Lighting.....	1-6
4. Splash Resistance, Dust Resistance, and Shock Resistance.....	1-7
5. About this User's Guide.....	1-8

Chapter 2 Basic Operation

1. Keys.....	2-1
2. Display.....	2-3
3. Inputting and Editing Calculations.....	2-6
4. Option (OPTN) Menu.....	2-11
5. Variable Data (VARS) Menu.....	2-12
6. Program (PRGM) Menu.....	2-13
7. Using the Setup Screen.....	2-14
8. When you keep having problems... ..	2-16

Chapter 3 Manual Calculations

1. Basic Calculations.....	3-1
2. Special Functions.....	3-4
3. Specifying the Angle Unit and Display Format.....	3-8
4. Function Calculations.....	3-10
5. Numerical Calculations.....	3-19
6. Complex Number Calculations.....	3-28
7. Binary, Octal, Decimal, and Hexadecimal Calculations with Integers.....	3-31
8. Matrix Calculations.....	3-34
9. Metric Conversion Calculations.....	3-48

Chapter 4 List Function

1. Inputting and Editing a List.....	4-1
2. Manipulating List Data.....	4-5
3. Arithmetic Calculations Using Lists.....	4-10
4. Switching Between List Files.....	4-12
5. Using CSV Files.....	4-13

Chapter 5 Statistical Graphs and Calculations

1. Before Performing Statistical Calculations.....	5-1
2. Calculating and Graphing Single-Variable Statistical Data.....	5-4
3. Calculating and Graphing Paired-Variable Statistical Data.....	5-9
4. Statistical Graph Display Operations.....	5-14
5. Performing Statistical Calculations.....	5-20

Chapter 6 Programming

1. Basic Programming Steps.....	6-1
2. PRGM Mode Function Keys.....	6-3
3. Editing Program Contents.....	6-4
4. File Management.....	6-6
5. Command Reference.....	6-10
6. Using Calculator Functions in Programs.....	6-26
7. PRGM Mode Command List.....	6-31

8. CASIO Scientific Function Calculator Special Commands ⇔ Text Conversion Table	6-34
Chapter 7 Spreadsheet	
1. Spreadsheet Basics and the Function Menu	7-1
2. Basic Spreadsheet Operations	7-2
3. Using Special S•SHT Mode Commands	7-15
4. Drawing Statistical Graphs, and Performing Statistical and Regression Calculations.....	7-16
5. S•SHT Mode Memory	7-21
Chapter 8 Memory Manager	
1. Using the Memory Manager.....	8-1
Chapter 9 System Manager	
1. Using the System Manager.....	9-1
2. System Settings	9-1
Chapter 10 Data Communication	
1. Establishing a Connection between the Calculator and a Personal Computer.....	10-1
2. Transferring Data between the Calculator and a Personal Computer	10-3
Chapter 11 Using SD Cards and SDHC Cards	
1. Using an SD Card	11-1
2. Formatting an SD Card	11-3
3. SD Card Precautions during Use	11-3
Appendix	
1. Power Supply	α-1
2. Error Message Table.....	α-4
3. Input Ranges.....	α-8
4. Specifications	α-10
5. Preset Programs	α-12

Chapter 1 Getting Acquainted

— Read This First!

1

1. BEFORE USING THE CALCULATOR FOR THE FIRST TIME...

Batteries are not loaded in your calculator at the factory.

Be sure to follow the procedure below to load batteries and adjust the display contrast before trying to use the calculator for the first time.

1. Turn over the calculator and rotate the center knob to the left.

- During the remainder of this procedure, take care that you do not accidentally press the **AC/ON** key.

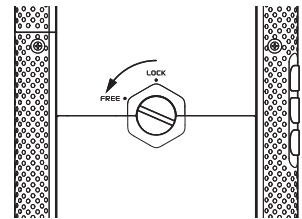

2. Lift up the battery compartment cover (①) and remove it (②).

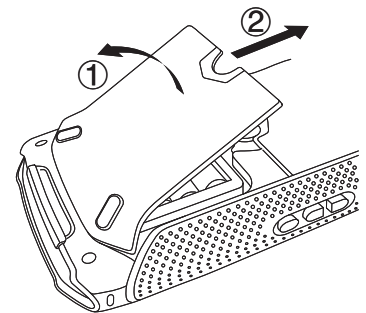

3. Load the four batteries that come with the calculator.

- When loading batteries other than those that come with the calculator, be sure to load full set of four AAA-size alkaline or rechargeable nickel-metal hydride batteries.
- Make sure that the positive (+) and negative (-) ends of the batteries are facing correctly.

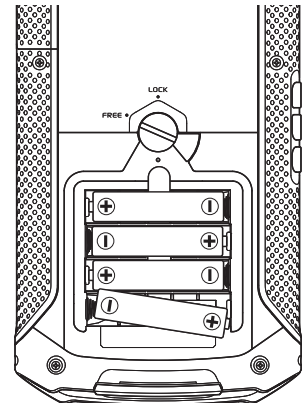

4. Replace the battery compartment cover. While pressing down on the cover, rotate the center knob to the right.

Important!

- You may not be able to rotate the center knob if you do not press down on the battery compartment cover as you do.
- Splash resistance, dust resistance, and shock resistance are maximized while the battery compartment cover is fully and securely closed.
- Even a slight amount of foreign matter (a single hair, speck of dust, etc.) on the contact surface of the battery compartment cover can allow moisture and/or dust to get into the interior of the calculator.

- If the Power Properties screen shown to the right is not on the display, press the RESTART button on the back of the calculator.

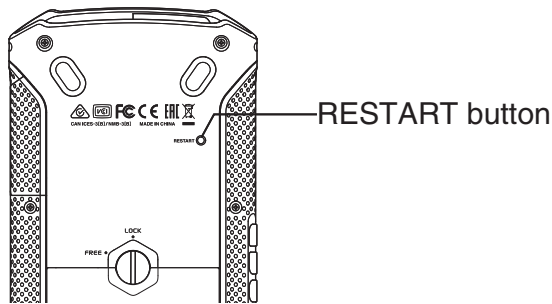

5. To change the LCD and key backlight duration, use \blacktriangledown and \blacktriangle to move the highlighting to “Backlight Duration” and then press one of the keys below.

- [F1]** (10) ... Backlight remains lit for 10 seconds after the backlight on operation.*
Performing a key operation while the backlight is lit will restart the duration until 10 seconds after that key operation.
- [F2]** (30) ... Backlight remains lit for 30 seconds after the backlight on operation.*
Performing a key operation while the backlight is lit will restart the duration until 30 seconds after that operation.
- [F3]** (Always) ... Backlight remains lit after the backlight on operation* until you press **[SHIFT]** **[ALPHA]** (LIGHT) or until the calculator is turned off.

* The backlight on operation depends on what is selected for the calculator’s “Backlight Setting”. The initial default setting turns the backlight on when any key operation is performed.

6. Press **[F6]** (Next).

- This displays the Battery Settings screen.

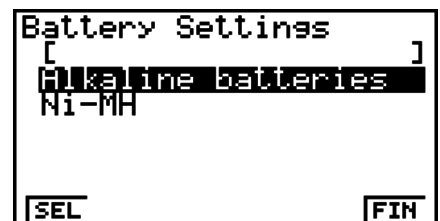

7. Use \blacktriangle and \blacktriangledown to move the highlighting to the battery type matches the batteries you loaded in step 2 above, and then press **[F1]** (SEL).

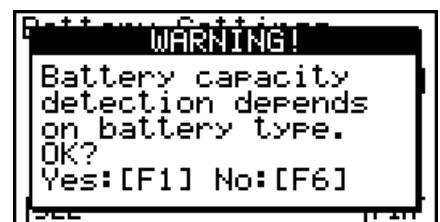

8. On the confirmation screen that appears, press **[F1]** (Yes).
9. Press **[F6]** (FIN) to complete the initial setup procedure.
 - This will display the main menu.

2. Handling Precautions

- Your calculator is made up of precision components. Never try to take it apart.
- Avoid dropping your calculator and subjecting it to strong impact.
- Do not store the calculator or leave it in areas exposed to high temperatures or humidity, or large amounts of dust. When exposed to low temperatures, the calculator may require more time to display results and may even fail to operate. Correct operation will resume once the calculator is brought back to normal temperature.
- Your calculator supports use of both alkaline batteries and rechargeable nickel-metal hydride batteries. Note that the amount of operation between charges provided by nickel-metal hydride batteries is shorter than the life of alkaline batteries. Use only batteries that are specifically recommended for this calculator.
- Replace the main batteries once every one year regardless of how much the calculator is used during that period. Never leave dead batteries in the battery compartment. They can leak and damage the unit. Immediately remove nickel-metal hydride batteries from the calculator after their charge is used up. Leaving uncharged nickel-metal hydride batteries in the calculator can cause them to deteriorate.
- Keep batteries out of the reach of small children. If swallowed, consult a physician immediately.
- Avoid using volatile liquids such as thinner or benzene to clean the unit. Wipe it with a soft, dry cloth, or with a cloth that has been moistened with a solution of water and a neutral detergent and wrung out.
- Always be gentle when wiping dust off the display to avoid scratching it.
- In no event will the manufacturer and its suppliers be liable to you or any other person for any damages, expenses, lost profits, lost savings or any other damages arising out of loss of data and/or formulas arising out of malfunction, repairs, or battery replacement. It is up to you to prepare physical records of data to protect against such data loss.
- Never dispose of batteries, the liquid crystal panel, or other components by burning them.
- Be sure that the power switch is set to OFF when replacing batteries.
- If the calculator is exposed to a strong electrostatic charge, its memory contents may be damaged or the keys may stop working. In such a case, perform the Reset operation to clear the memory and restore normal key operation.
- If the calculator stops operating correctly for some reason, use a thin, pointed object to press the RESTART button on the back of the calculator. Note, however, that this clears all the data in calculator memory.
- Note that strong vibration or impact during program execution can cause execution to stop or can damage the calculator's memory contents.
- Using the calculator near a television or radio can cause interference with TV or radio reception.
- Before assuming malfunction of the unit, be sure to carefully reread this User's Guide and ensure that the problem is not due to insufficient battery power, programming or operational errors.
- Avoid contact with water and other liquids.
Though your calculator is designed to be splash-resistant, note that splash-resistance is reduced if it is exposed to moisture, dirt, or dust while the battery compartment cover, USB port cap, SD card cap, or other opening is uncovered. Moisture getting into the calculator creates the risk of malfunction, fire, and electric shock.

- Do not swing the calculator around by its strap. Doing so creates the risk of calculator malfunction and personal injury.
- Avoid opening the battery compartment cover, USB port cap, and SD card cap in areas where moisture or salt wind is present, when your hands are wet, when wearing wet gloves, etc.
- Periodically check the battery compartment cover, USB port cap, SD card cap, and the areas around them for dirt, sand, and other foreign matter. If any of these areas are dirty, use a soft, clean, and dry cloth to wipe them. Note that even a minute particle of foreign matter (a single strand of hair, a single grain of sand, etc.) on a cover or cap contact surface creates the risk of moisture reaching the calculator interior.
- If the calculator is exposed to large amounts of rain or other water, wipe it dry. Make sure that all moisture is removed before using the calculator again.
- Do not use the calculator for long periods in the rain.
- When closing the battery compartment cover, USB port cap, or SD card cap, inspect its gasket for cracks, damage, looseness, or other irregularities, and make sure that the cover or cap closes securely.
- Take care to avoid dropping the calculator and do not leave it in an area that is outside the allowable operating temperature range. Such conditions can cause deterioration of splash and/or dust resistance.
- Calculator accessories and options are not splash or dust resistant.
- Subjecting the calculator to extreme shock may cause loss of splash and/or dust resistance.
- CASIO COMPUTER CO., LTD. shall held in no way liable for any malfunction of or damage to the calculator or SD card being used, or for any corruption or deletion of memory contents due to problems related to invasion of moisture that may occur due to misuse by you.
- CASIO COMPUTER CO., LTD. shall not be held responsible for any problems caused by exposure of this calculator to moisture.
- A progress bar and/or a busy indicator appear on the display whenever the calculator is performing a calculation, writing to memory, or reading from memory.



Progress bar

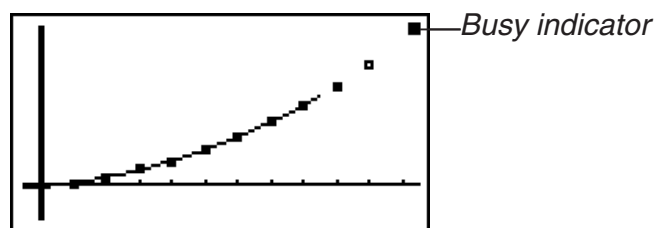

Never press the RESTART button or remove the batteries from the calculator when the progress bar or busy indicator is on the display. Doing so can cause memory contents to be lost and can cause malfunction of the calculator.

Be sure to keep physical records of all important data!

The large memory capacity of the unit makes it possible to store large amounts of data.

You should note, however, that low battery power or incorrect replacement of the batteries that power the unit can cause the data stored in memory to be corrupted or even lost entirely. Stored data can also be affected by strong electrostatic charge or strong impact. It is up to you to keep back up copies of data to protect against its loss.

Since this calculator employs unused memory as a work area when performing its internal calculations, an error may occur when there is not enough memory available to perform calculations. To avoid such problems, it is a good idea to leave 1 or 2 kbytes of memory free (unused) at all times.

In no event shall CASIO Computer Co., Ltd. be liable to anyone for special, collateral, incidental, or consequential damages in connection with or arising out of the purchase or use of these materials. Moreover, CASIO Computer Co., Ltd. shall not be liable for any claim of any kind whatsoever against the use of these materials by any other party.

3. LCD and Key Back Lighting

This calculator is equipped with LCD and key back lighting to make the keys and display easy to read, even in the dark. You can conserve battery power by limiting backlight operation to only when you need it.

- **To turn the backlight on or off**

Press **SHIFT** **ALPHA** (LIGHT) to toggle the backlight on and off.

- **Changing the Backlight On/Off Key**

You can configure the calculator so the backlight turns on when any key is pressed, instead of requiring the **SHIFT** **ALPHA** (LIGHT) to toggle the backlight on and off. For details, see “To specify the backlight key” (page 9-2).

- **Backlight duration**

You can configure backlight settings so it remains on or turns off after a specific period (30 seconds or 10 seconds) of calculator non-use. See “To specify the backlight duration” for details about the applicable operation procedure.

- **Backlight and Battery Life**

- Long-term backlight illumination can shorten battery life.
- The table below shows approximate battery life values for a new set of alkaline batteries or a new set of nickel-metal hydride batteries when operations (1) through (3) are performed repeatedly at one-hour intervals, under a temperature of 25°C.

(1) Five minutes of main menu display

(2) **PRGM** mode calculation for 5 minutes

(3) 50 minutes of **PRGM** mode display

Batteries	Backlight Use	Approximate Battery Life
Alkaline	Lit for the first 30 seconds of the three-step operation, then turned off after that.	200 hours
	Continuously lit.	25 hours
Nickel-metal hydride batteries (Recommended batteries only)	Lit for the first 30 seconds of the three-step operation, then turned off after that.	120 hours (Reference value)
	Continuously lit.	15 hours (Reference value)

4. Splash Resistance, Dust Resistance, and Shock Resistance

■ Splash Resistance and Dust Resistance

This calculator satisfies the requirements of the IP54* splash proof and dust proof protection levels defined by the International Electrotechnical Commission (IEC).

* IP stands for “ingress protection”. The “5” of the left digit means Class 5 (no ingress of dust that affect device operation) protection against solid objects. The “4” means Class 4 protection against liquids (no harmful effects from water sprayed from all directions).

■ Shock Resistance

This calculator has cleared independent testing by CASIO that was conducted based on the United States Defense Department MIL-STD-810G shock resistance performance test methods*. Test methods are those described below.

Local testing by natural dropping of the calculator to the floor (P tile on concrete) from a height of 122 cm on six faces. Test data represents actual cumulative values based on CASIO standards, and do not constitute any guarantee of non-destruction of or non-damage to the actual product exterior.

* Environmental laboratory test method (Method 516.6-Shock) of the United States Department of Defense MIL-STD-810G military standard, which requires passage by a total of at least five devices, which are drop tested from a height of 122 centimeters (4 feet) onto a plywood (lauan) drop zone, in groups of five, for a total of 26 drops (6 faces, 8 corners, 12 edges)

Important!

- Shock resistance testing assumes exposure to shock during normal everyday use. Subjecting the calculator to extreme shock may destroy it.
- Even if exposure to shock does not result in calculator operational performance, it can cause scratching of the calculator’s display or other damage.
- Splash resistance, dust resistance, and shock resistance testing of this calculator was performed using CASIO test methods. No guarantees are made concerning the ability of the calculator to be impervious to damage and/or malfunction.

5. About this User's Guide

- **SHIFT** **x²** ($\sqrt{\quad}$)

The above indicates you should press **SHIFT** and then **x²**, which will input a $\sqrt{\quad}$ symbol. All multiple-key input operations are indicated like this. Key cap markings are shown, followed by the input character or command in parentheses.

- **MENU** **STAT**

This indicates you should first press **MENU**, use the cursor keys (**▲**, **▼**, **◀**, **▶**) to select the **STAT** mode, and then press **EXE**. Operations you need to perform to enter a mode from the Main Menu are indicated like this.

- **Function Keys and Menus**

- Many of the operations performed by this calculator can be executed by pressing function keys **F1** through **F6**. The operation assigned to each function key changes according to the mode the calculator is in, and current operation assignments are indicated by function menus that appear at the bottom of the display.
- This User's Guide shows the current operation assigned to a function key in parentheses following the key cap for that key. **F1** (Comp), for example, indicates that pressing **F1** selects {Comp}, which is also indicated in the function menu.
- When (**▶**) is indicated in the function menu for key **F6**, it means that pressing **F6** displays the next page or previous page of menu options.

- **Menu Titles**

- Menu titles in this User's Guide include the key operation required to display the menu being explained. The key operation for a menu that is displayed by pressing **OPTN** and then {LIST} would be shown as: **[OPTN]-[LIST]**.
- **F6** (**▶**) key operations to change to another menu page are not shown in menu title key operations.

- **Command List**

The **PRGM** Mode Command List (page 6-31) provides a graphic flowchart of the various function key menus and shows how to maneuver to the menu of commands you need.

Example: The following operation displays Xfct: **[VARS]-[FACT]-[Xfct]**

- **E-CON2**

This manual does not cover the **E-CON2** mode. For more information about the **E-CON2** mode, download the E-CON2 manual (English version only) from: <http://edu.casio.com>.

Calculator Front Keys

Almost all of the keys on the front of the calculator have two functions assigned to them.

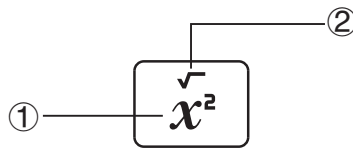

For example, pressing the x^2 key directly inputs $\wedge 2$ (①: square), while pressing SHIFT and then x^2 inputs $\sqrt{\quad}$ (②: square root).

Note

- For information about keys F1 through F6 , see “About the Function Menu” (page 2-5).
- The ALPHA key is used when inputting alphabetic characters. See “Inputting Alphabetic Characters” for more information.
- Pressing the ALPHA key twice in succession displays a function menu of up to six functions or commands registered by you to the Favorites category. You can use the function menu to input Favorites functions and commands. For more information, see “To input Favorites category commands using the function keys” (page 2-11).

Side Keys

There are three keys on the right side of the calculator: up cursor key, down cursor key, and EXE key.

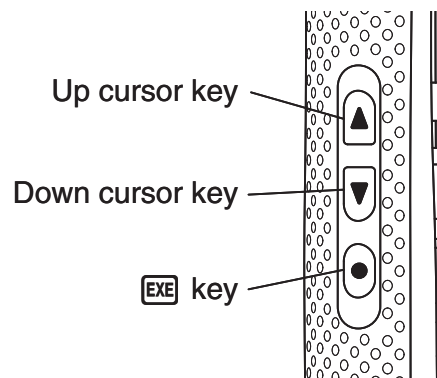

These keys perform the same operations as the corresponding keys on the front of the calculator.

As shown in the example below, the up and down cursor keys can be used to scroll certain screens one screen by pressing one of the keys twice in succession.

Example To use the up and down cursor keys to scroll a program list one screen

1. Press PROG to display the program list.

Program List	
ANGLE	: 96
AXISTRAN	: 156
BACKWARD	: 368
CL-CURVE	: 224
COORD	: 120
DECENTER	: 128↓
EXE	D

2. Press the down side cursor key twice in succession to scroll the screen contents downwards one screen.

Program List	
FORWARD	: 244↑
HERON	: 112
INTSEC1	: 192
INTSEC2	: 212
INVERSE	: 216
MID-ORD	: 108↓
EXE	▢ ▸

3. Press the up side cursor key twice in succession to scroll the screen contents upwards one screen.

Program List	
ANGLE	: 96
AXISTRAN	: 156
BACKWARD	: 368
CL-CURVE	: 224
COORD	: 120
DECENTER	: 128↓
EXE	▢ ▸

Note

- Each press of a side cursor key scrolls one screen when any of the following screens is displayed.
 - Matrix memory element input screen (Matrix Calculations, page 3-34)
 - List Editor screen (Chapter 4 List Function)
 - Program List screen (Chapter 6 Programming)
 - Spreadsheet screen (Chapter 7 Spreadsheet)
 - Memory information screen (Chapter 8 Memory Manager)
- If a screen does not support scrolling with the side cursor keys, screen contents will not change when either key is pressed twice in succession.
- Pressing the front up/down cursor keys twice in succession will not scroll screen contents.

2. Display

■ Selecting Icons

This section describes how to select an icon in the Main Menu to enter the mode you want.

• To select an icon

1. Press **[MENU]** to display the Main Menu.
2. Use the cursor keys (**◀**, **▶**, **▲**, **▼**) to move the highlighting to the icon you want.

Currently selected icon

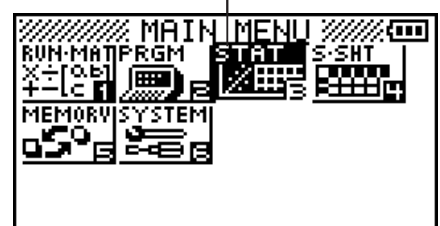

3. Press **EXE** to display the initial screen of the mode whose icon you selected. Here we will enter the **STAT** mode.

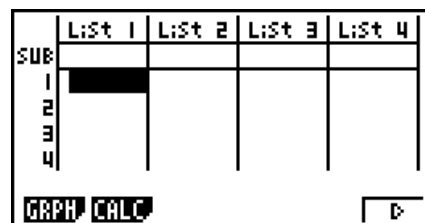

- You can also enter a mode without highlighting an icon in the Main Menu by inputting the number marked in the lower right corner of the icon.
- Use only the procedures described above to enter a mode. If you use any other procedure, you may end up in a mode that is different than the one you thought you selected.

The following explains the meaning of each icon.

Icon	Mode Name	Description
	RUN • MAT (Run • Matrix)	Use this mode for arithmetic calculations and function calculations, and for calculations involving binary, octal, decimal, and hexadecimal values and matrices.
	PRGM (Program)	Use this mode to write, store and recall programs that be reused for calculation as required. A variety of different useful preset programs are provided.
	STAT (Statistics)	Use this mode to perform single-variable (standard deviation) and paired-variable (regression) statistical calculations, to perform tests, to analyze data and to draw statistical graphs.
	S • SHT (Spreadsheet)	Use this mode to perform spreadsheet calculations. You can also perform the same statistical calculations and statistical graphing operations you perform in the STAT mode.
	MEMORY	Use this mode to manage data in the calculator's main memory and storage memory, and on an SD card loaded in the calculator.
	SYSTEM	Use this mode to adjust display contrast, and to configure power supply, display language, memory reset, and other general operational settings.

■ Battery Level Indicator

An icon in the upper right corner of the Main Menu (**MENU**) shows approximately how much battery power is remaining.

... From left to right: Level 3, Level 2, Level 1, Dead.

Important!

- Replace batteries as soon as possible whenever (Level 1) is indicated. For information about battery replacement, see “Replacing Batteries” (page α-1).
- The calculator will display a message prompting you to replace batteries when battery power goes very low. For more information, see “Low Battery Message” (page 2-17).

■ About the Function Menu

Use the function keys (**F1**) to (**F6**) to access the menus and commands in the menu bar along the bottom of the display screen. You can tell whether a menu bar item is a menu or a command by its appearance.

■ Normal Display

The calculator normally displays values up to 10 digits long. Values that exceed this limit are automatically converted to and displayed in exponential format.

• How to interpret exponential format

$$\boxed{1.2E12 \qquad 1.2E+12}$$

$1.2E+12$ indicates that the result is equivalent to 1.2×10^{12} . This means that you should move the decimal point in 1.2 twelve places to the right, because the exponent is positive. This results in the value 1,200,000,000,000.

$$\boxed{1.2E-3 \qquad 1.2E-03}$$

$1.2E-03$ indicates that the result is equivalent to 1.2×10^{-3} . This means that you should move the decimal point in 1.2 three places to the left, because the exponent is negative. This results in the value 0.0012.

You can specify one of two different ranges for automatic changeover to normal display.

Norm 1 10^{-2} (0.01) > $|x|$, $|x| \geq 10^{10}$

Norm 2 10^{-9} (0.000000001) > $|x|$, $|x| \geq 10^{10}$

All of the examples in this manual show calculation results using Norm 1.

See page 3-9 for details on switching between Norm 1 and Norm 2.

■ Special Display Formats

This calculator uses special display formats to indicate fractions, hexadecimal values, and degrees/minutes/seconds values.

• Fractions

$$\boxed{456.12123 \qquad 456.12123} \dots \text{Indicates: } 456 \frac{12}{23}$$

• Hexadecimal Values

$$\boxed{ABCDEF1 \qquad 0ABCDEF1} \dots \text{Indicates: } 0ABCDEF1_{(16)}, \text{ which equals } 180150001_{(10)}$$

• Degrees/Minutes/Seconds

$$\boxed{12.58244 \qquad 12^{\circ}34'56.78''} \dots \text{Indicates: } 12^{\circ}34'56.78''$$

- In addition to the above, this calculator also uses other indicators or symbols, which are described in each applicable section of this manual as they come up.

3. Inputting and Editing Calculations

■ Inputting Calculations

When you are ready to input a calculation, first press **AC** to clear the display. Next, input your calculation formulas exactly as they are written, from left to right, and press **EXE** to obtain the result.

Example $2 + 3 - 4 + 10 =$

AC **2** **+** **3** **-** **4** **+** **1** **0** **EXE**

$2+3-4+10$	11
------------	----

■ Editing Calculations

Use the **◀** and **▶** keys to move the cursor to the position you want to change, and then perform one of the operations described below. After you edit the calculation, you can execute it by pressing **EXE**. Or you can use **▶** to move to the end of the calculation and input more.

• To change a step

Example To change $\cos 60$ to $\sin 60$

AC **SHIFT** **8** (cos) **6** **0**

$\cos 60$

◀ **◀** **◀**

$\cos 60$

DEL

$\cos 60$

SHIFT **7** (sin)

$\sin 60$

• To delete a step

Example To change $369 \times \times 2$ to 369×2

AC **3** **6** **9** **×** **×** **2**

$369 \times \times 2$

◀ **DEL**

369×2

In the insert mode, the **DEL** key operates as a backspace key.

• To insert a step

Example To change 2.36^2 to $\sin 2.36^2$

AC **2** **.** **3** **6** **x²**

2.36²

◀ **◀** **◀** **◀** **◀**

2.36²

SHIFT **7** (sin)

sin 2.36²

■ Alphabetic Character Input

Use the function menu that appears when you press **ALPHA** to input alphabetic characters for variable memory names (A through Z), program names, etc.

Example To input $A + B + C$

ALPHA **F1** (A-E) **F1** (A) **+** **F2** (B) **+** **F3** (C)

A+B+C

Note

To input symbols (', ", ~, =) and spaces, use the function menu that appears after you press **ALPHA** **F6** (SYBL).

■ Using Replay Memory

The last calculation performed is always stored into replay memory. You can recall the contents of the replay memory by pressing **◀** or **▶**.

If you press **▶**, the calculation appears with the cursor at the beginning. Pressing **◀** causes the calculation to appear with the cursor at the end. You can make changes in the calculation as you wish and then execute it again.

Example 1 To perform the following two calculations

$$4.12 \times 6.4 = 26.368$$

$$4.12 \times 7.1 = 29.252$$

AC **4** **.** **1** **2** **x** **6** **.** **4** **EXE**

4.12×6.4 26.368

◀ **DEL** **DEL** **DEL**

4.12×

7 **.** **1**

4.12×7.1

EXE

4.12×7.1 29.252

After you press **AC**, you can press **▲** or **▼** to recall previous calculations, in sequence from the newest to the oldest (Multi-Replay Function). Once you recall a calculation, you can use **▶** and **◀** to move the cursor around the calculation and make changes in it to create a new calculation.

Example 2

AC **1** **2** **3** **+** **4** **5** **6** **EXE**

2 **3** **4** **-** **5** **6** **7** **EXE**

AC

▲ (One calculation back)

▲▲ (Two calculations back)

123+456	579
234-567	-333

234-567

123+456

- A calculation remains stored in replay memory until you perform another calculation.
- The contents of replay memory are not cleared when you press the **AC** key, so you can recall a calculation and execute it even after pressing the **AC** key.

■ Making Corrections in the Original Calculation

Example **14 ÷ 0 × 2.3 entered by mistake for 14 ÷ 10 × 2.3**

AC **1** **4** **÷** **0** **×** **2** **.** **3**

EXE

Press **EXIT**.

Make necessary changes.

◀ **1**

Execute again.

EXE

14÷0×2.3

14÷0×2.3
Ma ERROR
Press:[EXIT]

14÷0×2.3

Cursor is positioned automatically at the location of the cause of the error.

14÷10×2.3

14÷10×2.3	3.22
-----------	------

■ Using the Clipboard for Copy and Paste

You can copy (or cut) a function, command, or other input to the clipboard, and then paste the clipboard contents at another location.

• To specify the copy range

1. Move the cursor (**|**) to the beginning or end of the range of text you want to copy and then press **SHIFT** **1** (CLIP). This changes the cursor to **☐**.

14÷10×2.3☐

2. Use the cursor keys to move the cursor and highlight the range of text you want to copy.

14÷10×2.3

- Press **F1** (COPY) to copy the highlighted text to the clipboard, and exit the copy range specification mode.

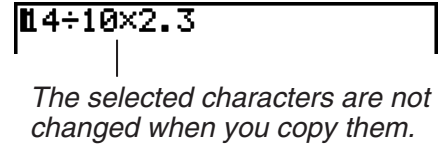

To cancel text highlighting without performing a copy operation, press **EXIT**.

• To cut the text

- Move the cursor (|) to the beginning or end of the range of text you want to cut and then press **SHIFT** **1** (CLIP). This changes the cursor to "⌂".

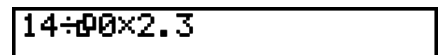

- Use the cursor keys to move the cursor and highlight the range of text you want to cut.

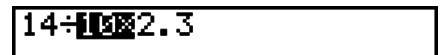

- Press **F2** (CUT) to cut the highlighted text to the clipboard.

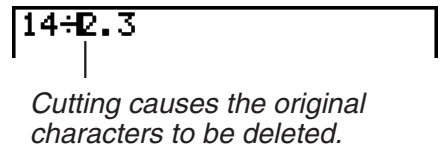

• Pasting Text

Move the cursor to the location where you want to paste the text, and then press **SHIFT** **2** (PASTE). The contents of the clipboard are pasted at the cursor position.



■ Catalog Function

The Catalog is an alphabetic list of all the commands available on this calculator. You can input a command by calling up the Catalog and then selecting the command you want.

Registering often-used commands to Favorites makes them more easily accessible for input.

• To use the Catalog to input a command

- Press **SHIFT** **0** (CATALOG) to display an alphabetic Catalog of commands.
 - The screen that appears first is the last one you used for command input.

2. Press **F6** (CTGY) to display the category list.

- You can skip this step and go straight to step 5, if you want.

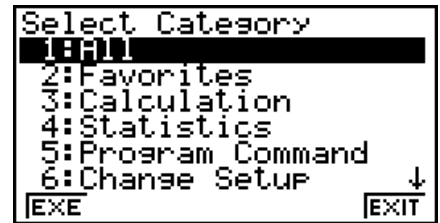

3. Use the cursor keys (**▲**, **▼**) to highlight the command category you want, and then press **F1** (EXE) or **EXE**.

- This displays a list of commands in the category you selected.

4. Input the first letter of the command you want to input. This will display the first command that starts with that letter.

5. Use the cursor keys (**▲**, **▼**) to highlight the command you want to input, and then press **F1** (INPUT) or **EXE**.

Example To use the Catalog to input the ClrList command

AC **SHIFT** **0** (CATALOG) **ALPHA** **F1** (A-E)
F3 (C) **▼** ~ **▼** **EXE**



Pressing **EXIT** or **SHIFT** **EXIT** (QUIT) closes the Catalog.

• To register a frequently used command to Favorites

1. Press **SHIFT** **0** (CATALOG) to display an alphabetic Catalog of commands.

2. Press **F6** (CTGY) to display the category list.

- You can skip this step and go straight to step 5, if you want.

3. Use the cursor keys (**▲**, **▼**) to highlight the command category you want, and then press **F1** (EXE) or **EXE**.

4. Input the first letter of the command you want to register to Favorites.

- This will display the first command that begins with that letter.

5. Use **▲** and **▼** to move the highlighting to the command you want to register, and then press **F2** (FAV).

- This registers the highlighted command to Favorites. A Favorites category list will appear on the display at this time.



Note

- The first six commands in the Favorites category can be input using the function menu that appears when the **ALPHA** key is pressed twice in succession. The top command is assigned to key **F1** (FAV1), the second command to key **F2** (FAV2), and so on up to **F6** (FAV6).
- Each time a new command is added to Favorites, it is added to the end of the list. For information about changing the order of the commands in the list, see “To re-arrange the sequence of Favorites category list commands” (page 2-11).

• To input Favorites category commands using the function keys

1. Press the **[ALPHA]** key twice.

- This displays a function menu for inputting Favorites category commands.



2. Press the function key (**[F1]**(FAV1) to **[F6]**(FAV6)) that corresponds to the command you want to input.

• To re-arrange the sequence of Favorites category list commands

1. Press **[SHIFT]** **[0]** (CATALOG) to display the catalog screen, and then press **[F6]**(CTGY) **[2]** to display the Favorites category list.

2. Use **[▲]** and **[▼]** to move the highlighting to one of the commands you want to move, and then press **[F2]**(SWAP).



3. Use **[▲]** and **[▼]** to move the highlighting to the command you want to swap with the command you selected above, and then press **[F2]**(SWAP).



• To delete a command from the Favorites category

While the Favorites category list is displayed, use **[▲]** and **[▼]** to move the highlighting to the command you want to delete, and then press **[F5]**(DEL).

4. Option (OPTN) Menu

The option menu gives you access to scientific functions and features that are not marked on the calculator's keyboard. The contents of the option menu differ according to the mode you are in when you press the **[OPTN]** key.

- The option menu does not appear if you press **[OPTN]** while binary, octal, decimal, or hexadecimal is set as the default number system.
- For details about the commands included on the option (OPTN) menu, see the "**[OPTN]** key" item in the "**PRGM** Mode Command List" (page 6-31).
- The meanings of the option menu items are described in the sections that cover each mode.

The following list shows the option menu that is displayed when the **RUN•MAT** or **PRGM** mode is selected.

- **{LIST}** ... {list function menu}
- **{MAT}** ... {matrix operation menu}
- **{CPLX}** ... {complex number calculation menu}
- **{CALC}** ... {functional analysis menu}

- **{STAT}** ... {menu for paired-variable statistical estimated value}
- **{CONV}** ... {metric conversion menu}
- **{HYP}** ... {hyperbolic calculation menu}
- **{PROB}** ... {probability/distribution calculation menu}
- **{NUM}** ... {numeric calculation menu}
- **{ANGL}** ... {menu for angle/coordinate conversion, sexagesimal input/conversion}
- **{ESYM}** ... {engineering symbol menu}
- **{PICT}** ... {graph save/recall menu}
- **{FMEM}** ... {function memory menu}
- **{LOGIC}** ... {logic operator menu}

5. Variable Data (VARS) Menu

To recall variable data, press $\boxed{\text{SHIFT}} \boxed{\text{OPTN}}$ (VARS) to display the variable data menu.

{V-WIN}/**{FACT}**/**{STAT}**/**{Str}**

- Note that the Str item appears for function key $\boxed{\text{F6}}$ only when you access the variable data menu from the **RUN•MAT** or **PRGM** mode.
- The variable data menu does not appear if you press $\boxed{\text{SHIFT}} \boxed{\text{OPTN}}$ (VARS) while binary, octal, decimal, or hexadecimal is set as the default number system.
- For details about the commands included on the variable data (VARS) menu, see the “ $\boxed{\text{SHIFT}} \boxed{\text{OPTN}}$ (VARS) key” item in the “**PRGM** Mode Command List” (page 6-31).

• **V-WIN — Recalling V-Window values**

- **{X}**/**{Y}** ... {x-axis menu}/y-axis menu}
 - **{min}**/**{max}**/**{scal}**/**{dot}** ... {minimum value}/maximum value}/scale}/dot value*¹
- *¹ The dot value indicates the display range (Xmax value – Xmin value) divided by the screen dot pitch (126). The dot value is normally calculated automatically from the minimum and maximum values. Changing the dot value causes the maximum to be calculated automatically.

• **FACT — Recalling zoom factors**

- **{Xfct}**/**{Yfct}** ... {x-axis factor}/y-axis factor}

• **STAT — Recalling statistical data**

- **{X}** ... {single-variable, paired-variable x-data}
 - **{n}**/**{ \bar{x} }**/**{ Σx }**/**{ Σx^2 }**/**{ σ_x }**/**{s_x}**/**{minX}**/**{maxX}** ... {number of data}/mean}/sum}/sum of squares}/population standard deviation}/sample standard deviation}/minimum value}/maximum value}
- **{Y}** ... {paired-variable y-data}
 - **{ \bar{y} }**/**{ Σy }**/**{ Σy^2 }**/**{ Σxy }**/**{ σ_y }**/**{s_y}**/**{minY}**/**{maxY}** ... {mean}/sum}/sum of squares}/sum of products of x-data and y-data}/population standard deviation}/sample standard deviation}/minimum value}/maximum value}

- **{GRPH}** ... {graph data menu}
 - **{a}/{b}/{c}/{d}/{e}** ... {regression coefficient and polynomial coefficients}
 - **{r}/{r²}** ... {correlation coefficient}/{coefficient of determination}
 - **{MSe}** ... {mean square error}
 - **{Q₁}/{Q₃}** ... {first quartile}/{third quartile}
 - **{Med}/{Mod}** ... {median}/{mode} of input data
 - **{Strt}/{Pitch}** ... histogram {start division}/{pitch}
- **{PTS}** ... {summary point data menu}
 - **{x₁}/{y₁}/{x₂}/{y₂}/{x₃}/{y₃}** ... {coordinates of summary points}
- **Str — Str command**
 - **{Str}** ... {string memory}

6. Program (PRGM) Menu

To display the program (PRGM) menu, first enter the **RUN•MAT** or **PRGM** mode from the Main Menu and then press **SHIFT** **PROG** (PRGM). The following are the selections available in the program (PRGM) menu.

- **{COM}** {program command menu}
- **{CTL}** {program control command menu}
- **{JUMP}**..... {jump command menu}
- **{?}** {input command}
- **{▲}** {output command}
- **{CLR}** {clear command menu}
- **{DISP}** {display command menu}
- **{REL}** {conditional jump relational operator menu}
- **{I/O}** {I/O control/transfer command menu}
- **{:}** {multi-statement command}
- **{STR}** {string command}

The following function key menu appears if you press **SHIFT** **PROG** (PRGM) in the **RUN•MAT** mode or the **PRGM** mode while binary, octal, decimal, or hexadecimal is set as the default number system.

- **{Prog}**..... {program recall}
- **{JUMP}/{?}/{▲}/{REL}/{:}**

The functions assigned to the function keys are the same as those in the Comp mode.

For details on the commands that are available in the various menus you can access from the program menu, see “Chapter 6 Programming”.

7. Using the Setup Screen

The mode's Setup screen shows the current status of mode settings and lets you make any changes you want. The following procedure shows how to change a setup.

• To change a mode setup

1. Select the icon you want and press **[EXE]** to enter a mode and display its initial screen. Here we will enter the **RUN•MAT** mode.
2. Press **[SHIFT] [MENU]** (SET UP) to display the mode's Setup screen.
 - This Setup screen is just one possible example. Actual Setup screen contents will differ according to the mode you are in and that mode's current settings.

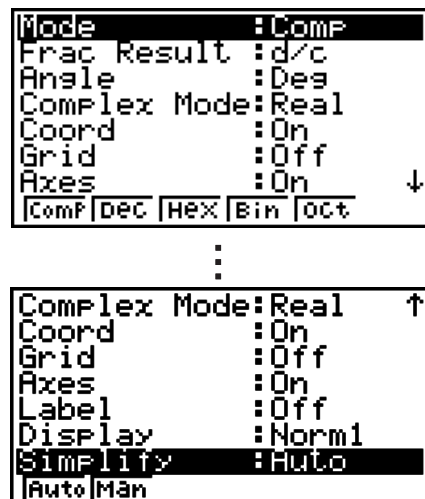

3. Use the **[▲]** and **[▼]** cursor keys to move the highlighting to the item whose setting you want to change.
4. Press the function key (**[F1]** to **[F6]**) that is marked with the setting you want to make.
5. After you are finished making any changes you want, press **[EXIT]** to exit the Setup screen.

■ Setup Screen Function Key Menus

This section details the settings you can make using the function keys in the Setup screen.  indicates default setting.

• Mode (calculation/binary, octal, decimal, hexadecimal mode)

- **[Comp]** ... {arithmetic calculation mode}
- **[Dec]/[Hex]/[Bin]/[Oct]** ... {decimal}/{hexadecimal}/{binary}/{octal}

• Frac Result (fraction result display format)

- **[d/c]/[ab/c]** ... {improper}/{mixed} fraction

• Angle (default angle unit)

- **[Deg]/[Rad]/[Gra]** ... {degrees}/{radians}/{grads}

• Complex Mode

- **[Real]** ... {calculation in real number range only}
- **[a+bi]/[r∠θ]** ... {rectangular format}/{polar format} display of a complex calculation

• Coord (graph pointer coordinate display)

- **[On]/[Off]** ... {display on}/{display off}

- **Grid (graph gridline display)**
 - **{On}/{Off}** ... {display on}/{display off}
- **Axes (graph axis display)**
 - **{On}/{Off}** ... {display on}/{display off}
- **Label (graph axis label display)**
 - **{On}/{Off}** ... {display on}/{display off}
- **Display (display format)**
 - **{Fix}/{Sci}/{Norm}/{Eng}** ... {fixed number of decimal places specification}/{number of significant digits specification}/{normal display setting}/{engineering mode}
- **Simplify (calculation result auto/manual reduction specification)**
 - **{Auto}/{Man}** ... {auto reduce and display}/{display without reduction}
- **Stat Wind (statistical graph V-Window setting method)**
 - **{Auto}/{Man}** ... {automatic}/{manual}
- **Resid List (residual calculation)**
 - **{None}/{LIST}** ... {no calculation}/{list specification for the calculated residual data}
- **List File (list file display settings)**
 - **{FILE}** ... {settings of list file on the display}
- **Sub Name (list naming)**
 - **{On}/{Off}** ... {display on}/{display off}
- **Graph Func (graph name display during graph drawing and trace)**
 - **{On}/{Off}** ... {display on}/{display off}
- **Background (graph display background)**
 - **{None}/{PICT}** ... {no background}/{graph background picture specification}
- **Sketch Line (overlaid line type)**
 - **{—}/{—}/{.....}/{.....}** ... {normal}/{thick}/{broken}/{dotted}
- **Q1Q3 Type (Q₁/Q₃ calculation formulas)**
 - **{Std}/{OnD}** ... {Divide total population on its center point between upper and lower groups, with the median of the lower group Q₁ and the median of the upper group Q₃/
{Make the value of element whose cumulative frequency ratio is greater than 1/4 and nearest to 1/4 Q₁ and the value of element whose cumulative frequency ratio is greater than 3/4 and nearest to 3/4 Q₃}
- **Auto Calc (spreadsheet auto calc)**
 - **{On}/{Off}** ... {execute}/{not execute} the formulas automatically
- **Show Cell (spreadsheet cell display mode)**
 - **{Form}/{Val}** ... {formula}*1/{value}

- **Move (spreadsheet cell cursor direction)*2**

- **{Low}/{Right}** ... {move down}/{move right}

*1 Selecting “Form” (formula) causes a formula in the cell to be displayed as a formula. The “Form” does not affect any non-formula data in the cell.

*2 Specifies the direction the cell cursor moves when you press the **[EXE]** key to register cell input, when the Sequence command generates a number table, and when you recall data from List memory.

8. When you keep having problems...

If you keep having problems when you are trying to perform operations, try the following before assuming that there is something wrong with the calculator.

■ Getting the Calculator Back to its Original Mode Settings

1. From the Main Menu, enter the **SYSTEM** mode.
2. Press **[F5]** (RSET).
3. Press **[F1]** (STUP), and then press **[F1]** (Yes).
4. Press **[EXIT]** **[MENU]** to return to the Main Menu.

Now enter the correct mode and perform your calculation again, monitoring the results on the display.

■ Restart and Reset

- **Restart**

Should the calculator start to act abnormally, you can restart it by pressing the **RESTART** button. Note, however, that you should only use the **RESTART** button only as a last resort. Normally, pressing the **RESTART** button reboots the calculator’s operating system, so programs and other data in calculator memory is retained.

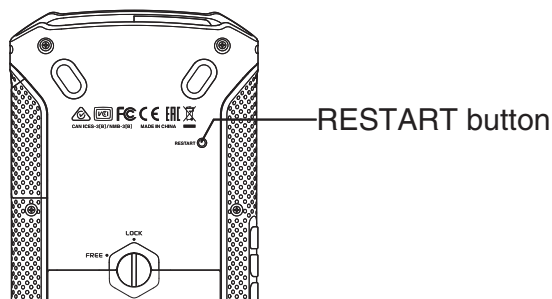

Important!

The calculator backs up user data (main memory) when you turn power off and loads the backed up data when you turn power back on.

When you press the RESTART button, the calculator restarts and loads backed up data. This means that if you press the RESTART button after you edit a program or other data, any data that has not been backed up will be lost.

● **Reset**

Use reset when you want to delete all data currently in calculator memory and return all mode settings to their initial defaults.

Before performing the reset operation, first make a written copy of all important data. For details, see “Reset” (page 9-3).

■ **Low Battery Message**

If the following message appears on the display, immediately turn off the calculator and replace batteries as instructed.

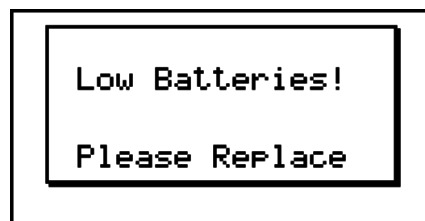

If you continue using the calculator without replacing batteries, power will automatically turn off to protect memory contents. Once this happens, you will not be able to turn power back on, and there is the danger that memory contents will be corrupted or lost entirely.

- You will not be able to perform data communications operations after the low battery message appears.

Chapter 3 Manual Calculations

1. Basic Calculations

■ Arithmetic Calculations

- Enter arithmetic calculations as they are written, from left to right.
- Use the \ominus key to input the minus sign before a negative value.
- Calculations are performed internally with a 15-digit mantissa. The result is rounded to a 10-digit mantissa before it is displayed.
- For mixed arithmetic calculations, multiplication and division are given priority over addition and subtraction.

Example	Operation
$56 \times (-12) \div (-2.5) = 268.8$	56 \times \ominus 12 \div \ominus 2.5 EXE
$(2 + 3) \times 10^2 = 500$	SHIFT \times (() 2 $+$ 3 SHIFT \div (()) \times 10 x^2 EXE
$2 + 3 \times (4 + 5) = 29$	2 $+$ 3 \times SHIFT \times (() 4 $+$ 5 EXE ^{*1}
$\frac{6}{4 \times 5} = 0.3$	6 \div SHIFT \times (() 4 \times 5 SHIFT \div (()) EXE

*1 Final closed parentheses (immediately before operation of the EXE key) may be omitted, no matter how many are required.

■ Number of Decimal Places, Number of Significant Digits, Normal Display Range

[SET UP]- [Display]- [Fix]/[Sci]/[Norm]

- Even after you specify the number of decimal places or the number of significant digits, internal calculations are still performed using a 15-digit mantissa, and displayed values are stored with a 10-digit mantissa. Use Rnd of the Numeric Calculation Menu (NUM) (page 3-10) to round the displayed value off to the number of decimal place and significant digit settings.
- Number of decimal place (Fix) and significant digit (Sci) settings normally remain in effect until you change them or until you change the normal display range (Norm) setting.

Example 1 $100 \div 6 = 16.66666666\dots$

Condition	Operation	Display
	100 \div 6 EXE	16.66666667
4 decimal places	SHIFT MENU (SET UP) \uparrow \uparrow F1 (Fix) 4 EXE EXIT EXE	16.6667 ^{*1}
5 significant digits	SHIFT MENU (SET UP) \uparrow \uparrow F2 (Sci) 5 EXE EXIT EXE	1.6667 ^{*1} _{E+01}
Cancels specification	SHIFT MENU (SET UP) \uparrow \uparrow F3 (Norm) EXIT EXE	16.66666667

*1 Displayed values are rounded off to the place you specify.

Example 2 $200 \div 7 \times 14 = 400$

Condition	Operation	Display
	$200 \div 7 \times 14$ [EXE]	400
3 decimal places	[SHIFT] [MENU] (SET UP) [▲] [▲] [F1] (Fix) [3] [EXE] [EXIT] [EXE]	400.000
Calculation continues using display capacity of 10 digits	$200 \div 7$ [EXE] [X] 14 [EXE]	28.571 Ans × ■ 400.000

- If the same calculation is performed using the specified number of digits:

	$200 \div 7$ [EXE]	28.571
The value stored internally is rounded off to the number of decimal places specified on the Setup screen.	[OPTN] [F6] (▷) [F4] (NUM) [F4] (Rnd) [EXE] [X]	28.571 Ans × ■
	14 [EXE]	399.994
	$200 \div 7$ [EXE]	28.571
You can also specify the number of decimal places for rounding of internal values for a specific calculation. (Example: To specify rounding to two decimal places)	[F6] (▷) [F1] (RndFi) [Ans] [◀] 2 [SHIFT] [÷] () [EXE] [X]	RndFix(Ans,2) 28.570 Ans × ■
	14 [EXE]	399.980

■ Calculation Priority Sequence

This calculator employs true algebraic logic to calculate the parts of a formula in the following order:

① Type A functions

- Coordinate transformation Pol (x, y), Rec (r, θ)
- Functions that include parentheses (such as derivatives, integrations, Σ , etc.)
 $d/dx, d^2/dx^2, \int dx, \Sigma, \text{Solve, FMin, FMax, List} \rightarrow \text{Mat, Fill, Seq, SortA, SortD, Min, Max, Median, Mean, Augment, Mat} \rightarrow \text{List, P(, Q(, R(, t(, RndFix, log}_a b$
- Composite functions*1, List, Mat, fn

② Type B functions

With these functions, the value is entered and then the function key is pressed.

$x^2, x^{-1}, x!, ^\circ, ' , ^\circ, ^\circ, ^\circ$, ENG symbols, angle unit $^\circ, ^\circ, ^\circ$

③ Power/root $^{\wedge}(x^y), \sqrt[x]{\quad}$

④ Fractions a^b/c

⑤ Abbreviated multiplication format in front of π , memory name, or variable name.

$2\pi, 5A, Xmin, H \text{ Start, etc.}$

⑥ Type C functions

With these functions, the function key is pressed and then the value is entered.

$\sqrt{\quad}, \sqrt[3]{\quad}, \log, \ln, e^x, 10^x, \sin, \cos, \tan, \sin^{-1}, \cos^{-1}, \tan^{-1}, \sinh, \cosh, \tanh, \sinh^{-1}, \cosh^{-1}, \tanh^{-1}, (-), d, h, b, o, \text{Neg, Not, Det, Trn, Dim, Identity, Ref, Rref, Sum, Prod, Cuml, Percent, } \Delta \text{List, Abs, Int, Frac, Intg, Arg, Conjg, ReP, ImP}$

- ⑦ Abbreviated multiplication format in front of Type A functions, Type C functions, and parenthesis.
 $2\sqrt{3}$, $A \log 2$, etc.
- ⑧ Permutation, combination nPr , nCr
- ⑨ Metric conversion commands
- ⑩ \times , \div , $\text{Int}\div$, Rnd
- ⑪ $+$, $-$
- ⑫ Relational operators $=$, \neq , $>$, $<$, \geq , \leq
- ⑬ And (logical operator), and (bitwise operator)
- ⑭ Or, Xor (logical operator), or, xor, xnor (bitwise operator)

*1 You can combine the contents of multiple function memory (fn) locations into composite functions. Specifying fn1(fn2), for example, results in the composite function fn1°fn2. A composite function can consist of up to five functions.

Example $2 + 3 \times (\log \sin 2\pi^2 + 6.8) = 22.07101691$ (angle unit = Rad)

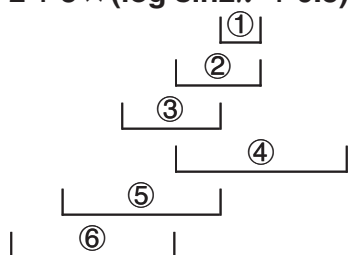

- You cannot use a differential, quadratic differential, integration, Σ , maximum/minimum value, Solve, RndFix or $\log_a b$ calculation expression inside of a RndFix calculation term.
- When functions with the same priority are used in series, execution is performed from right to left.
 $e^{x \ln \sqrt{120}} \rightarrow e^{x \{ \ln(\sqrt{120}) \}}$
 Otherwise, execution is from left to right.
- Compound functions are executed from right to left.
- Anything contained within parentheses receives highest priority.

■ Multiplication Operations without a Multiplication Sign

You can omit the multiplication sign (\times) in any of the following operations.

- Before Type A functions (① on page 3-2) and Type C functions (⑥ on page 3-2), except for negative signs

Example 1 $2\sin 30$, $10\log 1.2$, $2\sqrt{3}$, $2\text{Pol}(5, 12)$, etc.

- Before constants, variable names, memory names

Example 2 2π , $2AB$, $3Ans$, etc.

- Before an open parenthesis

Example 3 $3(5 + 6)$, $(A + 1)(B - 1)$, etc.

Note

If you execute a calculation that includes both division and multiplication operations in which a multiplication sign has been omitted, parentheses will be inserted automatically as shown in the examples below.

- When a multiplication sign is omitted immediately before an open parenthesis or after a closed parenthesis.

Example 1 $6 \div 2(1 + 2) \rightarrow 6 \div (2(1 + 2))$
 $6 \div A(1 + 2) \rightarrow 6 \div (A(1 + 2))$
 $1 \div (2 + 3)\sin 30 \rightarrow 1 \div ((2 + 3)\sin 30)$

- When a multiplication sign is omitted immediately before a variable, a constant, etc.

Example 2 $6 \div 2\pi \rightarrow 6 \div (2\pi)$
 $2 \div 2\sqrt{2} \rightarrow 2 \div (2\sqrt{2})$
 $4\pi \div 2\pi \rightarrow 4\pi \div (2\pi)$

■ Overflow and Errors

Exceeding a specified input or calculation range, or attempting an illegal input causes an error message to appear on the display. Further operation of the calculator is impossible while an error message is displayed. For details, see the “Error Message Table” on page α -4.

- Most of the calculator’s keys are inoperative while an error message is displayed. Press **EXIT** to clear the error and return to normal operation.

■ Memory Capacity

Each time you press a key, either one byte or two bytes is used. Some of the functions that require one byte are: **1**, **2**, **3**, **SHIFT** **7** (sin), **SHIFT** **8** (cos), **SHIFT** **9** (tan), and **SHIFT** **x²** ($\sqrt{\quad}$). Some of the functions that take up two bytes are d/dx (, Mat, Xmin, If, For, Return, and SortA.

2. Special Functions

■ Calculations Using Variables

Example	Operation	Display
	193.2 SHIFT Ans (\rightarrow) ALPHA F1 (A-E) F1 (A) EXE	193.2
$193.2 \div 23 = 8.4$	F1 (A) ÷ 23 EXE	8.4
$193.2 \div 28 = 6.9$	F1 (A) ÷ 28 EXE	6.9

■ Memory

• Variables (Alpha Memory)

This calculator comes with 28 variables as standard. You can use variables to store values you want to use inside of calculations. Variables are identified by single-letter names, which are made up of the 26 letters of the alphabet, plus r and θ . The maximum size of values that you can assign to variables is 15 digits for the mantissa and 2 digits for the exponent.

- Variable contents are retained even when you turn power off.

• **To assign a value to a variable**

[value] **SHIFT** **Ans** (→) [variable name] **EXE**

Example 1 To assign 123 to variable A

AC **1** **2** **3** **SHIFT** **Ans** (→) **123→A** **123**
ALPHA **F1** (A-E) **F1** (A) **EXE**

Example 2 To add 456 to variable A and store the result in variable B

AC **ALPHA** **F1** (A-E) **F1** (A) **+** **4** **5** **6** **A+456→B** **579**
SHIFT **Ans** (→) **ALPHA** **F1** (A-E) **F2** (B) **EXE**

• **To assign the same value to more than one variable**

[value] **SHIFT** **Ans** (→) [first variable name] **ALPHA** **F6** (SYBL) **F3** (~) [last variable name] **EXE**

- You cannot use “r” or “θ” as a variable name.

Example To assign a value of 10 to variables A through F

AC **1** **0** **SHIFT** **Ans** (→) **ALPHA** **F1** (A-E) **10→A~F** **10**
F1 (A) **EXIT** **F6** (SYBL) **F3** (~) **EXIT**
F2 (F-J) **F1** (F) **EXE**

• **String Memory**

You can store up to 20 strings (named Str 1 to Str 20) in string memory. Stored strings can be output to the display or used inside functions and commands that support the use of strings as arguments.

For details about string operations, see “Strings” (page 6-20).

Example To assign string “ABC” to Str 1 and then output Str 1 to the display

AC **ALPHA** **F6** (SYBL) **F2** (") **EXIT**
F1 (A-E) **F1** (A) **F2** (B) **F3** (C) **EXIT**
F6 (SYBL) **F2** (") **SHIFT** **Ans** (→) **SHIFT** **OPTN** (VARS)
F6 (Str) **1** **EXE** **"ABC"→Str 1** **Done**
F6 (Str) **1** **EXE** **"ABC"→Str 1** **Done**
Str 1
ABC

String is displayed justified left.

• Function Memory

[OPTN]-[FMEM]

Function memory is convenient for temporary storage of often-used expressions.

- {STO}/{RCL}/{fn}/{SEE} ... {function store}/{function recall}/{function area specification as a variable name inside an expression}/{function list}

• To store a function

Example To store the function $(A+B)(A-B)$ as function memory number 1

SHIFT X (() ALPHA F1 (A-E) F1 (A) +

ALPHA F2 (B) SHIFT ÷ ())

SHIFT X (() ALPHA F1 (A-E) F1 (A) -

ALPHA F2 (B) SHIFT ÷ ())

```
(A+B)(A-B)|
```

OPTN F6 (▷) F6 (▷) F3 (FMEM)

F1 (STO) 1 EXE

```
== Function Memory ==
f1:(A+B)(A-B)
```

EXIT EXIT EXIT

- If the function memory number to which you store a function already contains a function, the previous function is replaced with the new one.
- You can also use SHIFT Ans (→) to store a function in function memory in a program. In this case, you must enclose the function inside of double quotation marks.

```
"(A+B)(A-B)"→fn1|
```

• To recall a function

Example To recall the contents of function memory number 1

AC OPTN F6 (▷) F6 (▷) F3 (FMEM)

F2 (RCL) 1 EXE

```
(A+B)(A-B)|
```

- The recalled function appears at the current location of the cursor on the display.

• To recall a function as a variable

AC 3 SHIFT Ans (→) ALPHA F1 (A-E) F1 (A) EXE

1 SHIFT Ans (→) ALPHA F1 (A-E) F2 (B) EXE

OPTN F6 (▷) F6 (▷) F3 (FMEM) F3 (fn)

1 + 2 EXE

```
3→A
1→B
fn1+2
3
1
10
```

• To display a list of available functions

OPTN **F6** (\triangleright) **F6** (\triangleright) **F3** (FMEM)
F4 (SEE)

```
== Function Memory ==
f1:(A+B)(A-B)
f2:
f3:
f4:
f5:
f6:
```

• To delete a function

Example To delete the contents of function memory number 1

AC

```
|
```

OPTN **F6** (\triangleright) **F6** (\triangleright) **F3** (FMEM)
F1 (STO) **1** **EXE**

```
== Function Memory ==
f1:
```

- Executing the store operation while the display is blank deletes the function in the function memory you specify.

■ **Answer Function**

The Answer Function automatically stores the last result you calculated by pressing **EXE** (unless the **EXE** key operation results in an error). The result is stored in the answer memory.

- The largest value that the answer memory can hold is 15 digits for the mantissa and 2 digits for the exponent.
- Answer memory contents are not cleared when you press the **AC** key or when you switch power off.

• To use the contents of the answer memory in a calculation

Example $123 + 456 = 579$
 $789 - 579 = 210$

AC **1** **2** **3** **+** **4** **5** **6** **EXE**
7 **8** **9** **-** **Ans** **EXE**

```
123+456           579
789-Ans          210
```

■ Performing Continuous Calculations

Answer memory also lets you use the result of one calculation as one of the arguments in the next calculation.

Example $1 \div 3 =$
 $1 \div 3 \times 3 =$

AC **1** **÷** **3** **EXE**
(Continuing) **×** **3** **EXE**

1÷3	0.3333333333
Ans×3	1

Continuous calculations can also be used with Type B functions (x^2 , x^{-1} , $x!$, on page 3-2), +, −, $^{\wedge}(x^y)$, $^x\sqrt{\quad}$, $^{\circ}$, etc.

3. Specifying the Angle Unit and Display Format

Before performing a calculation for the first time, you should use the Setup screen to specify the angle unit and display format.

■ Setting the Angle Unit

[SET UP]- [Angle]

1. On the Setup screen, highlight “Angle”.
2. Press the function key for the angle unit you want to specify, then press **EXIT**.
 - **{Deg}/{Rad}/{Gra}** ... {degrees}/{radians}/{grads}
 - The relationship between degrees, grads, and radians is shown below.

$$360^{\circ} = 2\pi \text{ radians} = 400 \text{ grads}$$

$$90^{\circ} = \pi/2 \text{ radians} = 100 \text{ grads}$$

■ Setting the Display Format

[SET UP]- [Display]

1. On the Setup screen, highlight “Display”.
2. Press the function key for the item you want to set, then press **EXIT**.
 - **{Fix}/{Sci}/{Norm}/{Eng}** ... {fixed number of decimal places specification}/
{number of significant digits specification}/{normal display}/{Engineering mode}

• To specify the number of decimal places (Fix)

Example To specify two decimal places

F1 (Fix) **2** **EXE**

Display **:Fix2**

Press the number key that corresponds to the number of decimal places you want to specify ($n = 0$ to 9).

- Displayed values are rounded off to the number of decimal places you specify.

- **To specify the number of significant digits (Sci)**

Example **To specify three significant digits**

F2 (Sci) **3** **EXE**

Display **:Sci3**

Press the number key that corresponds to the number of significant digits you want to specify (n = 0 to 9). Specifying 0 makes the number of significant digits 10.

- Displayed values are rounded off to the number of significant digits you specify.

- **To specify the normal display (Norm 1/Norm 2)**

Press **F3** (Norm) to switch between Norm 1 and Norm 2.

Norm 1: 10^{-2} (0.01) > |x|, |x| $\geq 10^{10}$

Norm 2: 10^{-9} (0.000000001) > |x|, |x| $\geq 10^{10}$

- **To specify the engineering notation display (Eng mode)**

Press **F4** (Eng) to switch between engineering notation and standard notation. The indicator “/E” is on the display while engineering notation is in effect.

You can use the following symbols to convert values to engineering notation, such as 2,000 (= 2×10^3) → 2k.

E (Exa)	$\times 10^{18}$	m (milli)	$\times 10^{-3}$
P (Peta)	$\times 10^{15}$	μ (micro)	$\times 10^{-6}$
T (Tera)	$\times 10^{12}$	n (nano)	$\times 10^{-9}$
G (Giga)	$\times 10^9$	p (pico)	$\times 10^{-12}$
M (Mega)	$\times 10^6$	f (femto)	$\times 10^{-15}$
k (kilo)	$\times 10^3$		

- The engineering symbol that makes the mantissa a value from 1 to 1000 is automatically selected by the calculator when engineering notation is in effect.

4. Function Calculations

■ Function Menus

This calculator includes five function menus that give you access to scientific functions not printed on the key panel.

- The contents of the function menu differ according to the mode you entered from the Main Menu before you pressed the **[OPTN]** key. The following examples show function menus that appear in the **RUN • MAT** or **PRGM** mode.

● Hyperbolic Calculations (HYP) [OPTN]-[HYP]

- **{sinh}**/**{cosh}**/**{tanh}** ... hyperbolic {sine}/**{cosine}**/**{tangent}**
- **{sinh⁻¹}**/**{cosh⁻¹}**/**{tanh⁻¹}** ... inverse hyperbolic {sine}/**{cosine}**/**{tangent}**

● Probability/Distribution Calculations (PROB) [OPTN]-[PROB]

- **{x!}** ... {press after inputting a value to obtain the factorial of the value}
- **{nPr}**/**{nCr}** ... {permutation}/**{combination}**
- **{RAND}** ... {random number generation}
- **{Ran#}**/**{Int}**/**{Norm}**/**{Bin}**/**{List}** ... {random number generation (0 to 1)}/**{random integer generation}**/**{random number generation in accordance with normal distribution based on mean μ and standard deviation σ }**/**{random number generation in accordance with binomial distribution based on number of trials n and probability p }**/**{random number generation (0 to 1) and storage of result in ListAns}**
- **{P}**/**{Q}**/**{R}** ... normal probability **{P(t)}**/**{Q(t)}**/**{R(t)}**
- **{t}** ... {value of normalized variate $t(x)$ }

● Numeric Calculations (NUM) [OPTN]-[NUM]

- **{Abs}** ... {select this item and input a value to obtain the absolute value of the value}
- **{Int}**/**{Frac}** ... select the item and input a value to extract the {integer}/**{fraction}** part.
- **{Rnd}** ... {rounds off the value used for internal calculations to 10 significant digits (to match the value in the answer memory), or to the number of decimal places (Fix) and number of significant digits (Sci) specified by you}
- **{Intg}** ... {select this item and input a value to obtain the largest integer that is not greater than the value}
- **{RndFi}** ... {rounds off the value used for internal calculations to specified digits (0 to 9) (see page 3-2).}
- **{GCD}** ... {greatest common divisor for two values}
- **{LCM}** ... {least common multiple for two values}
- **{MOD}** ... {remainder of division (remainder output when n is divided by m)}
- **{MOD • E}** ... {remainder when division is performed on a power value (remainder output when n is raised to p power and then divided by m)}

• Angle Units, Coordinate Conversion, Sexagesimal Operations (ANGL)

[OPTN]-[ANGL]

- $\{^\circ\}/\{r\}/\{g\}$... {degrees}/{radians}/{grads} for a specific input value
 - $\{^\circ ' ''\}^*$... {specifies degrees (hours), minutes, seconds when inputting a degrees/minutes/seconds value}
 - $\{\overleftarrow{\circ ' ''}\}^*$... {converts decimal value to degrees/minutes/seconds value}
 - The $\{\overleftarrow{\circ ' ''}\}$ menu operation is available only when there is a calculation result on the display.
 - $\{\text{Pol}()\}/\{\text{Rec}()\}^*$... {rectangular-to-polar}/{polar-to-rectangular} coordinate conversion
 - $\{\blacktriangleright\text{DMS}\}$... {converts decimal value to sexagesimal value}
- * These commands ($\{^\circ ' ''\}$, $\{\overleftarrow{\circ ' ''}\}$, $\{\text{Pol}()\}$, $\{\text{Rec}()\}$) can be input using key operations, without going through the option (OPTN) menu. For operation examples, see “Angle Units” (page 3-11).

• Engineering Symbol (ESYM)

[OPTN]-[ESYM]

- $\{m\}/\{\mu\}/\{n\}/\{p\}/\{f\}$... {milli (10^{-3})}{/micro (10^{-6})}{/nano (10^{-9})}{/pico (10^{-12})}{/femto (10^{-15})}
- $\{k\}/\{M\}/\{G\}/\{T\}/\{P\}/\{E\}$... {kilo (10^3)}{/mega (10^6)}{/giga (10^9)}{/tera (10^{12})}{/peta (10^{15})}{/exa (10^{18})}
- $\{\text{ENG}\}/\{\overleftarrow{\text{ENG}}\}$... shifts the decimal place of the displayed value three digits to the {left}/{right} and {decreases}/{increases} the exponent by three.

When you are using engineering notation, the engineering symbol is also changed accordingly.

 - The $\{\text{ENG}\}$ and $\{\overleftarrow{\text{ENG}}\}$ menu operations are available only when there is a calculation result on the display.

■ Angle Units

- Be sure to specify Comp for Mode in the Setup screen.

Example	Operation
$47.3^\circ + 82.5\text{rad} = 4774.20181^\circ$	$47.3 \text{ [] } + 82.5 \text{ [OPTN] [F6] (▷) [F5] (ANGL) [F2] (r) [EXE]}$
$2^\circ 20' 30'' + 39^\circ 30'' = 3^\circ 00' 00''$	$2 \text{ [] } 20 \text{ [] } 30 \text{ [] } + 0 \text{ [] } 39 \text{ [] } 30 \text{ [] } \text{ [EXE]}$ $\text{[SHIFT] [] } (\overleftarrow{\circ ' ''})$
Convert 60° to radians. 1.047197551	$\text{[SHIFT] [MENU] (SET UP) [] } \text{[] } \text{[F2] (Rad) [EXIT]}$ $60 \text{ [OPTN] [F6] (▷) [F5] (ANGL) [F1] (°) [EXE]}$
To convert 2.255 (decimal) to sexagesimal 2°15'18"	$2.255 \text{ [EXE] [SHIFT] [] } (\overleftarrow{\circ ' ''})$

■ Trigonometric and Inverse Trigonometric Functions

- Be sure to set the angle unit before performing trigonometric function and inverse trigonometric function calculations.

$$(90^\circ = \frac{\pi}{2} \text{ radians} = 100 \text{ grads})$$

- Be sure to specify Comp for Mode in the Setup screen.

Example	Operation
$\cos\left(\frac{\pi}{3}\text{ rad}\right) = 0.5$	SHIFT MENU (SET UP) ▼ ▼ F2 (Rad) EXIT SHIFT 8 (cos) SHIFT ⊗ (()) SHIFT 0 (CATALOG) ALPHA F6 (SYBL) F4 (,) ▼ ▼ (π) EXE 3 SHIFT ÷ ()) EXE
$2 \cdot \sin 45^\circ \times \cos 65^\circ = 0.5976724775$	SHIFT MENU (SET UP) ▼ ▼ F1 (Deg) EXIT 2 ⊗ SHIFT 7 (sin) 45 ⊗ cos 65 EXE *1
$\sin^{-1}0.5 = 30^\circ$ (x when $\sin x = 0.5$)	SHIFT 4 (\sin^{-1}) 0.5 *2 EXE

*1 **⊗** can be omitted.

*2 Input of leading zero is not necessary.

■ Logarithmic and Exponential Functions

- Be sure to specify Comp for Mode in the Setup screen.

Example	Operation
$\log 1.23$ ($\log_{10}1.23$) = 0.08990511144	SHIFT 0 (CATALOG) ALPHA F3 (K-O) F2 (L) ▼ ~ ▼ (log) EXE 1.23 EXE
$\log_2 8 = 3$	OPTN F4 (CALC) F6 (\triangleright) F4 ($\log_a b$) 2 ↵ 8 SHIFT ÷ ()) EXE
$(-3)^4 = (-3) \times (-3) \times (-3) \times (-3) = 81$	SHIFT ⊗ (()) = 3 SHIFT ÷ ()) SHIFT 0 (CATALOG) ALPHA F6 (SYBL) F4 (,) ▼ ~ ▼ (^) EXE 4 EXE
$\sqrt[7]{123}$ ($= 123^{\frac{1}{7}}$) = 1.988647795	7 SHIFT 0 (CATALOG) ALPHA F6 (SYBL) F4 (,) ▼ ~ ▼ ($^x\sqrt{\quad}$) EXE 123 EXE

■ Hyperbolic and Inverse Hyperbolic Functions

- Be sure to specify Comp for Mode in the Setup screen.

Example	Operation
$\sinh 3.6 = 18.28545536$	OPTN F6 (\triangleright) F2 (HYP) F1 (sinh) 3.6 EXE
$\cosh^{-1}\left(\frac{20}{15}\right) = 0.7953654612$	OPTN F6 (\triangleright) F2 (HYP) F5 (\cosh^{-1}) SHIFT ⊗ (()) 20 ÷ 15 SHIFT ÷ ()) EXE

Other Functions

- Be sure to specify Comp for Mode in the Setup screen.

Example	Operation
$\sqrt{2} + \sqrt{5} = 3.65028154$	$\text{SHIFT} \text{ } \boxed{x^2} (\sqrt{}) 2 \text{ } \boxed{+} \text{ } \text{SHIFT} \text{ } \boxed{x^2} (\sqrt{}) 5 \text{ } \boxed{\text{EXE}}$
$(-3)^2 = (-3) \times (-3) = 9$	$\text{SHIFT} \text{ } \boxed{\times} ((-) \text{ } \boxed{-} 3 \text{ } \text{SHIFT} \text{ } \boxed{\div} ()) \text{ } \boxed{x^2} \text{ } \boxed{\text{EXE}}$
$8! (= 1 \times 2 \times 3 \times \dots \times 8) = 40320$	$8 \text{ } \boxed{\text{OPTN}} \text{ } \boxed{\text{F6}} (\triangleright) \boxed{\text{F3}} (\text{PROB}) \boxed{\text{F1}} (x!) \text{ } \boxed{\text{EXE}}$
What is the integer part of -3.5 ? - 3	$\boxed{\text{OPTN}} \text{ } \boxed{\text{F6}} (\triangleright) \boxed{\text{F4}} (\text{NUM}) \boxed{\text{F2}} (\text{Int}) \text{ } \boxed{-} 3.5 \text{ } \boxed{\text{EXE}}$

Random Number Generation (RAND)

Random Number Generation (0 to 1) (Ran#, RanList#)

Ran# and RanList# generate 10 digit random numbers randomly or sequentially from 0 to 1. Ran# returns a single random number, while RanList# returns multiple random numbers in list form. The following shows the syntaxes of Ran# and RanList#.

Ran# [a] $1 \leq a \leq 9$

RanList# (n [,a]) $1 \leq n \leq 999$

- n is the number of trials. RanList# generates the number of random numbers that corresponds to n and displays them on the ListAns screen. A value must be input for n .
- " a " is the randomization sequence. Random numbers are returned if nothing is input for " a ". Entering an integer of 1 through 9 for a will return the corresponding sequential random number.
- Executing the function Ran# 0 initializes the sequences of both Ran# and RanList#. The sequence also is initialized when a sequential random number is generated with a different sequence of the previous execution using Ran# or RanList#, or when generating a random number.

Ran# Examples

Example	Operation
Ran# (Generates a random number.) (Each press of $\boxed{\text{EXE}}$ generates a new random number.)	$\boxed{\text{OPTN}} \text{ } \boxed{\text{F6}} (\triangleright) \boxed{\text{F3}} (\text{PROB}) \boxed{\text{F4}} (\text{RAND})$ $\boxed{\text{F1}} (\text{Ran\#}) \text{ } \boxed{\text{EXE}}$ $\boxed{\text{EXE}}$ $\boxed{\text{EXE}}$
Ran# 1 (Generates the first random number in sequence 1.) (Generates the second random number in sequence 1.)	$\boxed{\text{OPTN}} \text{ } \boxed{\text{F6}} (\triangleright) \boxed{\text{F3}} (\text{PROB}) \boxed{\text{F4}} (\text{RAND})$ $\boxed{\text{F1}} (\text{Ran\#}) 1 \text{ } \boxed{\text{EXE}}$ $\boxed{\text{EXE}}$
Ran# 0 (Initializes the sequence.)	$\boxed{\text{F1}} (\text{Ran\#}) 0 \text{ } \boxed{\text{EXE}}$
Ran# 1 (Generates the first random number in sequence 1.)	$\boxed{\text{F1}} (\text{Ran\#}) 1 \text{ } \boxed{\text{EXE}}$

RanList# Examples

Example	Operation
RanList# (4) (Generates four random numbers and displays the result on the ListAns screen.)	OPTN F6 (\triangleright) F3 (PROB) F4 (RAND) F5 (List) 4 SHIFT ÷ () EXE
RanList# (3, 1) (Generates from the first to the third random numbers of sequence 1 and displays the result on the ListAns screen.)	EXIT OPTN F6 (\triangleright) F3 (PROB) F4 (RAND) F5 (List) 3 ↵ 1 SHIFT ÷ () EXE
(Next, generates from the fourth to the sixth random number of sequence 1 and displays the result on the ListAns screen.)	EXIT EXE
Ran# 0 (Initializes the sequence.)	EXIT F1 (Ran#) 0 EXE
RanList# (3, 1) (Re-generates from the first to the third random numbers of sequence 1 and displays the result on the ListAns screen.)	F5 (List) 3 ↵ 1 SHIFT ÷ () EXE

• Random Integer Generation (RanInt#)

RanInt# generates random integers that fall between two specified integers.

RanInt# (A, B [,n]) $A < B$ $|A|, |B| < 1E10$ $B - A < 1E10$ $1 \leq n \leq 999$

- A is the start value and B is the end value. Omitting a value for n returns a generated random number as-is. Specifying a value for n returns the specified number of random values in list form.

Example	Operation
RanInt# (1, 5) (Generates one random integer from 1 and 5.)	OPTN F6 (\triangleright) F3 (PROB) F4 (RAND) F2 (Int) 1 ↵ 5 SHIFT ÷ () EXE
RanInt# (1, 10, 5) (Generates five random integers from 1 to 10 and displays the result on the ListAns screen.)	OPTN F6 (\triangleright) F3 (PROB) F4 (RAND) F2 (Int) 1 ↵ 10 ↵ 5 SHIFT ÷ () EXE

• Random Number Generation in Accordance with Normal Distribution (RanNorm#)

This function generates a 10-digit random number in accordance with normal distribution based on a specified mean μ and standard deviation σ values.

RanNorm# (σ , μ [,n]) $\sigma > 0$ $1 \leq n \leq 999$

- Omitting a value for n returns a generated random number as-is. Specifying a value for n returns the specified number of random values in list form.

Example	Operation
RanNorm# (8, 68) (Randomly produces a body length value obtained in accordance with the normal distribution of a group of infants less than one year old with a mean body length of 68cm and standard deviation of 8.)	OPTN F6 (\triangleright) F3 (PROB) F4 (RAND) F3 (Norm) 8 ▸ 68 SHIFT ÷ () EXE
RanNorm# (8, 68, 5) (Randomly produces the body lengths of five infants in the above example, and displays them in a list.)	OPTN F6 (\triangleright) F3 (PROB) F4 (RAND) F3 (Norm) 8 ▸ 68 ▸ 5 SHIFT ÷ () EXE

• Random Number Generation in Accordance with Binomial Distribution (RanBin#)

This function generates random integers in accordance with binomial distribution based on values specified for the number of trials n and probability p .

RanBin# (n, p [,m]) $1 \leq n \leq 100000$ $1 \leq m \leq 999$ $0 \leq p \leq 1$

- Omitting a value for m returns a generated random number as-is. Specifying a value for m returns the specified number of random values in list form.

Example	Operation
RanBin# (5, 0.5) (Randomly produces the number of heads that can be expected in accordance with binomial distribution for five coin tosses where the probability of heads is 0.5.)	OPTN F6 (\triangleright) F3 (PROB) F4 (RAND) F4 (Bin) 5 ▸ 0.5 SHIFT ÷ () EXE
RanBin# (5, 0.5, 3) (Performs the same coin toss sequence described above three times and displays the results in a list.)	OPTN F6 (\triangleright) F3 (PROB) F4 (RAND) F4 (Bin) 5 ▸ 0.5 ▸ 3 SHIFT ÷ () EXE

■ Coordinate Conversion

You can perform coordinate conversion using the following key operations: **SHIFT** **−** (Pol) or **SHIFT** **+** (Rec).

• Rectangular Coordinates

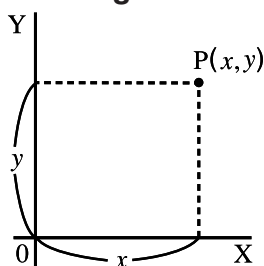

Pol
←
Rec

• Polar Coordinates

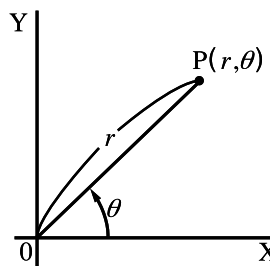

- With polar coordinates, θ can be calculated and displayed within a range of $-180^\circ < \theta \leq 180^\circ$ (radians and grads have same range).
- Be sure to specify Comp for Mode in the Setup screen.

Example	Operation
① Calculate r and θ° when $x = 14$ and $y = 20.7$ 1 [24.989] → 24.98979792 (r) 2 [55.928] → 55.92839019 (θ) ② Calculate x and y when $r = 25$ and $\theta = 56^\circ$ 1 [13.979] → 13.97982259 (x) 2 [20.725] → 20.72593931 (y)	SHIFT MENU (SET UP) F1 (Deg) EXIT SHIFT = (Pol) 14 $\text{}$ 20.7 SHIFT $\text{}$ () EXE EXIT SHIFT + (Rec) 25 $\text{}$ 56 SHIFT $\text{}$ () EXE

- The results of coordinate conversions are automatically stored in ListAns Memory.

Pol(14,20.7)	Done
List Ans[1]	24.98979792
List Ans[2]	55.92839019
MAT	

Example ① result

Rec(25,56)	Done
List Ans[1]	13.97982259
List Ans[2]	20.72593931
MAT	

Example ② result

■ Permutation and Combination

- Permutation**

$${}_n P_r = \frac{n!}{(n-r)!}$$

- Combination**

$${}_n C_r = \frac{n!}{r!(n-r)!}$$

- Be sure to specify Comp for Mode in the Setup screen.

Example 1 To calculate the possible number of different arrangements using 4 items selected from among 10 items

Formula	Operation
${}_{10}P_4 = 5040$	10 OPTN F6 (>) F3 (PROB) F2 (${}_n P_r$) 4 EXE

Example 2 To calculate the possible number of different combinations of 4 items that can be selected from among 10 items

Formula	Operation
${}_{10}C_4 = 210$	10 OPTN F6 (>) F3 (PROB) F3 (${}_n C_r$) 4 EXE

■ Greatest Common Divisor (GCD), Least Common Multiple (LCM)

Example	Operation
To determine the greatest common divisor of 28 and 35 (GCD (28, 35) = 7)	OPTN F6 (>) F4 (NUM) F6 (>) F2 (GCD) 28 $\text{}$ 35 SHIFT $\text{}$ () EXE
To determine the least common multiple of 9 and 15 (LCM (9, 15) = 45)	OPTN F6 (>) F4 (NUM) F6 (>) F3 (LCM) 9 $\text{}$ 15 SHIFT $\text{}$ () EXE

■ Division Remainder (MOD), Remainder of Exponential Division (MOD Exp)

Example	Operation
To determine the remainder when 137 is divided by 7 (MOD (137, 7) = 4)	OPTN F6 (▷) F4 (NUM) F6 (▷) F4 (MOD) 137 ↵ 7 SHIFT ÷ () EXE
To determine the remainder when 5 ³ is divided by 3 (MOD • E (5, 3, 3) = 2)	OPTN F6 (▷) F4 (NUM) F6 (▷) F5 (MOD • E) 5 ↵ 3 ↵ 3 SHIFT ÷ () EXE

■ Fractions

- Be sure to specify Comp for Mode in the Setup screen.

Example	Operation
$\frac{2}{5} + 3\frac{1}{4} = \frac{73}{20}$	2 SHIFT 0 (CATALOG) ALPHA F6 (SYBL) F4 (,) ↵ ~ ↵ (↓) EXE 5 + 3 SHIFT 0 (CATALOG) (↓) F1 (INPUT) 1 SHIFT 0 (CATALOG) (↓) F1 (INPUT) 4 EXE
$\frac{1}{2578} + \frac{1}{4572} = 6.066202547 \times 10^{-4}$ *1	1 SHIFT 0 (CATALOG) ALPHA F6 (SYBL) F4 (,) ↵ ~ ↵ (↓) EXE 2578 + 1 SHIFT 0 (CATALOG) (↓) F1 (INPUT) 4572 EXE
$\frac{1}{2} \times 0.5 = 0.25$ *2	1 SHIFT 0 (CATALOG) ALPHA F6 (SYBL) F4 (,) ↵ ~ ↵ (↓) EXE 2 X .5 EXE

*1 When the total number of characters, including integer, numerator, denominator and delimiter marks exceeds 10, the fraction is automatically displayed in decimal format.

*2 Calculations containing both fractions and decimals are calculated in decimal format.

■ Engineering Notation Calculations

Input engineering symbols using the engineering notation menu.

- Be sure to specify Comp for Mode in the Setup screen.

Example	Operation
999k (kilo) + 25k (kilo) = 1.024M (mega)	SHIFT MENU (SET UP) ▲ ▲ F4 (Eng) EXIT 999 OPTN F6 (▷) F6 (▷) F1 (ESYM) F6 (▷) F1 (k) + 25 F1 (k) EXE
9 ÷ 10 = 0.9 = 900m (milli) = 0.9	9 ÷ 10 EXE OPTN F6 (▷) F6 (▷) F1 (ESYM) F6 (▷) F6 (▷) F3 (ENG)*1
= 0.0009k (kilo)	F3 (ENG)*1
= 0.9	F2 (ENG)*2
= 900m	F2 (ENG)*2

- *1 Converts the displayed value to the next higher engineering unit, by shifting the decimal point three places to the right.
- *2 Converts the displayed value to the next lower engineering unit, by shifting the decimal point three places to the left.

■ Logical Operators (AND, OR, NOT, XOR)

[OPTN]-[LOGIC]

The logical operator menu provides a selection of logical operators.

- {**And**}/{**Or**}/{**Not**}/{**Xor**} ... {logical AND}/{logical OR}/{logical NOT}/{logical XOR}
- Be sure to specify Comp for Mode in the Setup screen.

Example **What is the logical AND of A and B when A = 3 and B = 2?
A AND B = 1**

Operation	Display
3 [SHIFT] [Ans] (→) [ALPHA] [F1] (A-E) [F1] (A) [EXE] 2 [SHIFT] [Ans] (→) [ALPHA] [F1] (A-E) [F2] (B) [EXE] [F1] (A) [OPTN] [F6] (▷) [F6] (▷) [F4] (LOGIC) [F1] (And) [ALPHA] [F1] (A-E) [F2] (B) [EXE]	1

● About Logical Operations

- A logical operation always produces either 0 or 1 as its result.
- The following table shows all of possible results that can be produced by AND, OR and XOR operations.

Value or Expression A	Value or Expression B	A AND B	A OR B	A XOR B
A ≠ 0	B ≠ 0	1	1	0
A ≠ 0	B = 0	0	1	1
A = 0	B ≠ 0	0	1	1
A = 0	B = 0	0	0	0

- The following table shows the results produced by the NOT operation.

Value or Expression A	NOT A
A ≠ 0	0
A = 0	1

5. Numerical Calculations

The following explains the numerical calculation operations included in the function menu displayed when OPTN F4 (CALC) is pressed. The following calculations can be performed.

- $\{\text{Int}\div\}/\{\text{Rmdr}\}/\{\text{Simp}\}$... {quotient}/remainder/simplification
- $\{\text{Solve}\}/\{d/dx\}/\{d^2/dx^2\}/\{dx\}/\{\text{SolvN}\}$... {equality solution}/differential/quadratic differential/integration/ $f(x)$ function solution
- $\{\text{FMin}\}/\{\text{FMax}\}/\{\Sigma\}/\{\log_a b\}$... {minimum value}/maximum value/summation/logarithm $\log_a b$

■ Quotient of Integer \div Integer

$[\text{OPTN}]-[\text{CALC}]-[\text{Int}\div]$

The “Int \div ” function can be used to determine the quotient when one integer is divided by another integer.

Example To calculate the quotient of $107 \div 7$

AC 1 0 7 OPTN F4 (CALC) F6 (\triangleright)
 F6 (\triangleright) F1 (Int \div) 7
 EXE

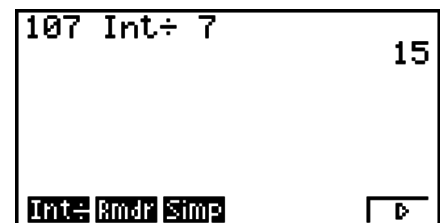

■ Remainder of Integer \div Integer

$[\text{OPTN}]-[\text{CALC}]-[\text{Rmdr}]$

The “Rmdr” function can be used to determine the remainder when one integer is divided by another integer.

Example To calculate the remainder of $107 \div 7$

AC 1 0 7 OPTN F4 (CALC) F6 (\triangleright)
 F6 (\triangleright) F2 (Rmdr) 7
 EXE

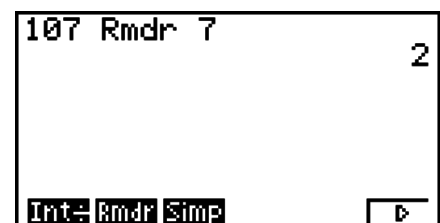

■ Simplification

$[\text{OPTN}]-[\text{CALC}]-[\text{Simp}]$

The “ \blacktriangleright Simp” function can be used to simplify fractions manually. The following operations can be used to perform simplification when an unsimplified calculation result is on the display.

- $\{\text{Simp}\}$ EXE ... This function automatically simplifies the displayed calculation result using the smallest prime number available. The prime number used and the simplified result are shown on the display.
- $\{\text{Simp}\}$ n EXE ... This function performs simplification according to the specified divisor n .

Under initial default settings, this calculator automatically simplifies fraction calculation results before displaying them. Before performing the following examples, use the Setup screen to change the “Simplify” setting from “Auto” to “Manual” (page 2-15).

- When “ $a+bi$ ” or “ $r\angle\theta$ ” is specified for the Setup screen “Complex Mode” setting, fraction calculation results always are simplified before being displayed, even if the “Simplify” setting is “Manual”.
- If you want to simplify fractions manually (Simplify: Manual), make sure that the “Real” is selected for the “Complex Mode” setting.

Example 1 To simplify $\frac{15}{60}$ ($\frac{15}{60} = \frac{5}{20} = \frac{1}{4}$)

AC 1 5 SHIFT 0 (CATALOG)
 ALPHA F6 (SYBL) F4 (,) ~ (,) (J) EXE
 6 0 EXE OPTN F4 (CALC) F6 (▷) F6 (▷)
 F3 (Simp) EXE

F3 (Simp) EXE

```

15.60
Ans▶Simp      15.60
                F=3
                5.20
Int: Rndr Simp  |▷|
  
```

```

15.60
Ans▶Simp      15.60
                F=3
                5.20
Ans▶Simp      15.60
                F=5
                1.4
Int: Rndr Simp  |▷|
  
```

The “F=” value is the divisor.

Example 2 To simplify $\frac{27}{63}$ specifying a divisor of 9 ($\frac{27}{63} = \frac{3}{7}$)

AC 2 7 SHIFT 0 (CATALOG)
 ALPHA F6 (SYBL) F4 (,) ~ (,) (J) EXE
 6 3 EXE OPTN F4 (CALC) F6 (▷) F6 (▷)
 F3 (Simp) 9 EXE

```

27.63
Ans▶Simp 9     27.63
                F=9
                3.7
Int: Rndr Simp  |▷|
  
```

- An error occurs if simplification cannot be performed using the specified divisor.
- Executing ▶Simp while a value that cannot be simplified is displayed will return the original value, without displaying “F=”.

■ Solve Calculations

[OPTN]-[CALC]-[Solve]

SOLVE uses approximation based on Newton’s Law to solve equations.

The following is the syntax for using the Solve function.

Solve($f(x)$, n , a , b) (a : lower limit, b : upper limit, n : initial estimated value)

An error (Time Out) occurs when there is no convergence of the solution.

- You cannot use a quadratic differential, Σ , maximum/minimum value or Solve calculation expression inside of any of the above functions.
- Pressing AC during calculation of Solve (while the cursor is not shown on the display) interrupts the calculation.

■ Solving an $f(x)$ Function

[OPTN]-[CALC]-[SolvN]

You can use SolvN to solve an $f(x)$ function using numerical analysis. The following is the input syntax.

SolveN (left side [=right side] [,variable] [, lower limit, upper limit])

- The right side, variable, lower limit and upper limit all can be omitted.
- “left side[=right side]” is the expression to be solved. Supported variables are A through Z, r , and θ . When the right side is omitted, solution is perform using right side = 0.
- The variable specifies the variable within the expression to be solved for (A through Z, r , θ). Omitting a variable specification cause X to be used as the variable.
- The lower limit and upper limit specify the range of the solution. You can input a value or an expression as the range.
- The following functions cannot be used within any of the arguments.
Solve(, d^2/dx^2 , FMin(, FMax(, Σ (

Up to 10 calculation results can be displayed simultaneously in ListAns format.

- The message “No Solution” is displayed if no solution exists.
- The message “More solutions may exist.” is displayed when there may be solutions other than those displayed by SolvN.

Example To solve $x^2 - 5x - 6 = 0$

[OPTN] [F4] (CALC) [F5] (SolvN)
[ALPHA] [F5] (U-Z) [F4] (X) x^2 [=] [5] [F4] (X)
[-] [6] [SHIFT] [\div] () [EXE]

[EXIT]

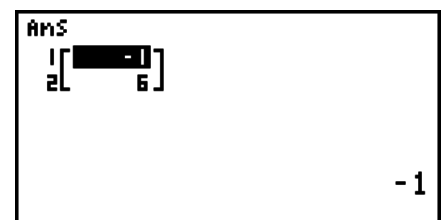
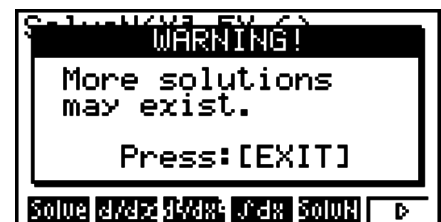

To perform differential calculations, first display the function analysis menu, and then input the values using the syntax below.

[OPTN] [F4] (CALC) [F2] (d/dx) f(x) [] a [] tol [SHIFT] [÷] ()

(a: point for which you want to determine the derivative, tol: tolerance)

$$d/dx (f(x), a) \Rightarrow \frac{d}{dx} f(a)$$

The differentiation for this type of calculation is defined as:

$$f'(a) = \lim_{\Delta x \rightarrow 0} \frac{f(a + \Delta x) - f(a)}{\Delta x}$$

In this definition, *infinitesimal* is replaced by a *sufficiently small* Δx , with the value in the neighborhood of $f'(a)$ calculated as:

$$f'(a) \doteq \frac{f(a + \Delta x) - f(a)}{\Delta x}$$

In order to provide the best precision possible, this unit employs central difference to perform differential calculations.

Example To determine the derivative at point $x = 3$ for the function $y = x^3 + 4x^2 + x - 6$, with a tolerance of “tol” = $1E-5$

Input the function $f(x)$.

[AC] [OPTN] [F4] (CALC) [F2] (d/dx) [ALPHA] [F5] (U-Z) [F4] (X) [SHIFT] [0] (CATALOG)
 [ALPHA] [F6] (SYBL) [F4] () [] ~ [] (^) [EXE] [3] [] [] [ALPHA] [F5] (U-Z) [F4] (X)
 [x²] [] [F4] (X) [] [] []

Input point $x = a$ for which you want to determine the derivative.

[3] []

Input the tolerance value.

[1] [SHIFT] [0] (CATALOG) [ALPHA] [F1] (A-E) [F5] (E)
 [] ~ [] (EXP) [EXE] [] [] [SHIFT] [÷] () [EXE]

d/dx(X^3+4X^2+X-6,3,1E-5)	52
---------------------------	----

Differential Calculation Precautions

- In the function $f(x)$, only X can be used as a variable in expressions. Other variables (A through Z excluding X, r, θ) are treated as constants, and the value currently assigned to that variable is applied during the calculation.
- Input of the tolerance (tol) value and the closing parenthesis can be omitted. If you omit tolerance (tol) value, the calculator automatically uses a value for tol as $1E-10$.
- Specify a tolerance (tol) value of $1E-14$ or greater. An error (Time Out) occurs whenever no solution that satisfies the tolerance value can be obtained.
- Pressing [AC] during calculation of a differential (while the cursor is not shown on the display) interrupts the calculation.
- Inaccurate results and errors can be caused by the following:
 - discontinuous points in x values
 - extreme changes in x values
 - inclusion of the local maximum point and local minimum point in x values

- inclusion of the inflection point in x values
- inclusion of undifferentiable points in x values
- differential calculation results approaching zero
- Always use radians (Rad mode) as the angle unit when performing trigonometric differentials.
- You cannot use a differential, quadratic differential, integration, Σ , maximum/minimum value, Solve, RndFix or $\log_a b$ calculation expression inside a differential calculation term.

■ Quadratic Differential Calculations

[OPTN]-[CALC]-[d^2/dx^2]

After displaying the function analysis menu, you can input quadratic differentials using the following syntax.

[OPTN] [F4] (CALC) [F3] (d^2/dx^2) $f(x)$ [>] a [>] tol [SHIFT] [÷] ())
 (a : differential coefficient point, tol : tolerance)

Quadratic differential calculations produce an approximate differential value using the following second order differential formula, which is based on Newton's polynomial interpretation.

In this expression, values for "sufficiently small increments of h " are used to obtain a value that approximates $f''(a)$.

Example **To determine the quadratic differential coefficient at the point where $x = 3$ for the function $y = x^3 + 4x^2 + x - 6$. Here we will use a tolerance $tol = 1E-5$**

Input the function $f(x)$.

[AC] [OPTN] [F4] (CALC) [F3] (d^2/dx^2) [ALPHA] [F5] (U-Z) [F4] (X) [SHIFT] [0] (CATALOG)
 [ALPHA] [F6] (SYBL) [F4] () [▼] ~ [▼] (^) [EXE] [3] [+] [4] [ALPHA] [F5] (U-Z) [F4] (X)
 [x^2] [+] [F4] (X) [-] [6] [,]

Input 3 as point a , which is the differential coefficient point.

[3] [,]

Input the tolerance value.

[1] [SHIFT] [0] (CATALOG) [ALPHA] [F1] (A-E)
 [F5] (E) [▼] ~ [▼] (EXP) [EXE]
 [-] [5] [SHIFT] [÷] ())
 [EXE]

$d^2/dx^2(X^3+4X^2+X-6, 3,$ $1E-5)$	26
----------------------------------------	----

Quadratic Differential Calculation Precautions

- With quadratic differential calculation, calculation precision is up to five digits for the mantissa.
- The rules that apply for linear differential also apply when using a quadratic differential calculation. See "Differential Calculation Precautions" on page 3-22.

Integration Calculations

[OPTN]-[CALC]-[$\int dx$]

To perform integration calculations, first display the function analysis menu and then input the values using the syntax below.

[OPTN] [F4] (CALC) [F4] ($\int dx$) $f(x)$ [,] a [,] b [,] tol [SHIFT] [÷] ()

(a : start point, b : end point, tol : tolerance)

$$\int(f(x), a, b, tol) \Rightarrow \int_a^b f(x)dx$$

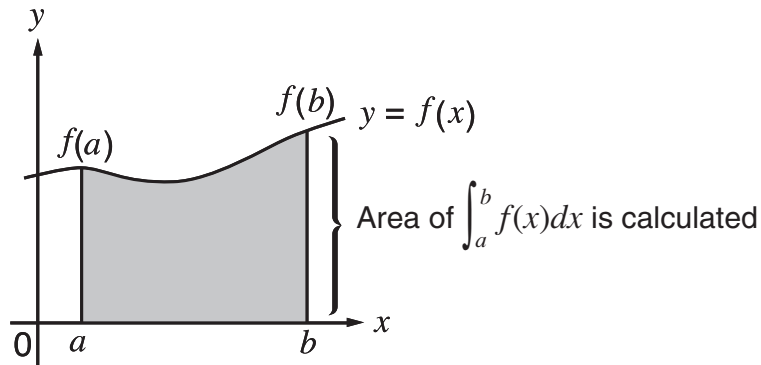

As shown in the illustration above, integration calculations are performed by calculating integral values from a through b for the function $y = f(x)$ where $a \leq x \leq b$, and $f(x) \geq 0$. This in effect calculates the surface area of the shaded area in the illustration.

Example 1 To perform the integration calculation for the function shown below, with a tolerance of “ tol ” = $1E - 4$

$$\int_1^5 (2x^2 + 3x + 4) dx$$

Input the function $f(x)$.

[AC] [OPTN] [F4] (CALC) [F4] ($\int dx$) [2] [ALPHA] [F5] (U-Z) [F4] (X) [x²] [+] [3] [F4] (X) [+] [4] [,]

Input the start point and end point.

[1] [,] [5] [,]

Input the tolerance value.

[1] [SHIFT] [0] (CATALOG) [ALPHA] [F1] (A-E) [F5] (E) $\int(2X^2+3X+4, 1, 5, 1E-4)$
 [v] ~ [v] (EXP) [EXE] [=] [4] 404.3
 [SHIFT] [÷] () [EXE]

Example 2 When the angle unit setting is degrees, trigonometric function integration calculation is performed using radians (Angle unit = Deg)

$\int(\cos X^r, \pi \div 2, \pi)$ -1

Examples Calculation Result Display

Note the following points to ensure correct integration values.

- (1) When cyclical functions for integration values become positive or negative for different divisions, perform the calculation for single cycles, or divide between negative and positive, and then add the results together.

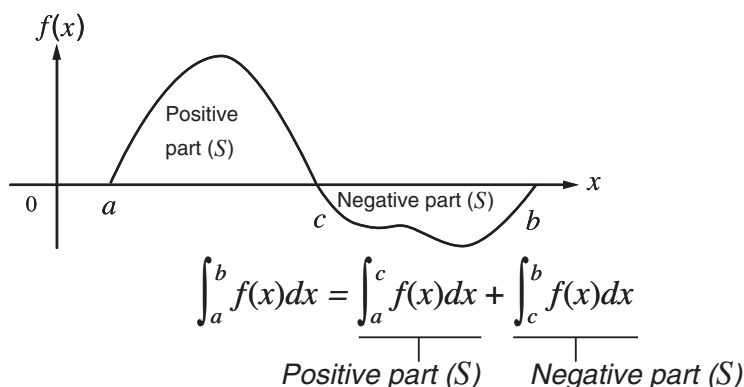

- (2) When minute fluctuations in integration divisions produce large fluctuations in integration values, calculate the integration divisions separately (divide the large fluctuation areas into smaller divisions), and then add the results together.

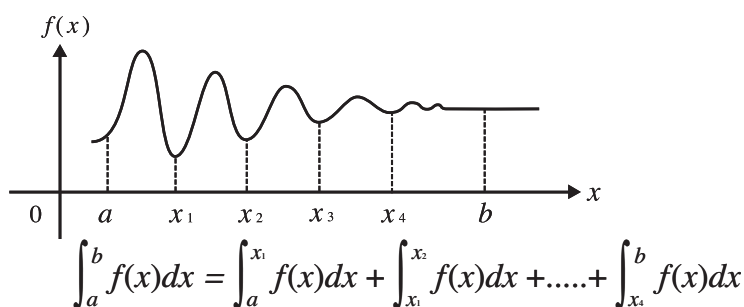

- Pressing **AC** during calculation of an integral (while the cursor is not shown on the display) interrupts the calculation.
- Always use radians (Rad mode) as the angle unit when performing trigonometric integrations.
- An error (Time Out) occurs whenever no solution that satisfies the tolerance value can be obtained.

Integration Calculation Precautions

- In the function $f(x)$, only X can be used as a variable in expressions. Other variables (A through Z excluding X , r , θ) are treated as constants, and the value currently assigned to that variable is applied during the calculation.
- Input of "tol" and closing parenthesis can be omitted. If you omit "tol," the calculator automatically uses a default value of $1E-5$.
- Integration calculations can take a long time to complete.
- You cannot use a differential, quadratic differential, integration, Σ , maximum/minimum value, Solve, RndFix or $\log_a b$ calculation expression inside of an integration calculation term.

■ Σ Calculations

[OPTN]-[CALC]-[Σ (]

To perform Σ calculations, first display the function analysis menu, and then input the values using the syntax below.

[OPTN] [F4] (CALC) [F6] (\triangleright) [F3] (Σ () a_k [,] k [,] α [,] β [,] n [SHIFT] [] ())

$$\Sigma(a_k, k, \alpha, \beta, n) = \sum_{k=\alpha}^{\beta} a_k = a_{\alpha} + a_{\alpha+1} + \dots + a_{\beta}$$

(n : distance between partitions)

Example To calculate the following:

$$\sum_{k=2}^6 (k^2 - 3k + 5)$$

Use $n = 1$ as the distance between partitions.

[AC] [OPTN] [F4] (CALC) [F6] (\triangleright) [F3] (Σ ()
 [ALPHA] [F3] (K-O) [F1] (K) [x²] [=] [3] [F1] (K)
 [+] [5] [,] [F1] (K) [,] [2] [,] [6] [,] [1]
 [SHIFT] [] () [EXE]

$\Sigma(K^2-3K+5,K,2,6,1)$ 55

Σ Calculation Precautions

- The value of the specified variable changes during a Σ calculation. Be sure to keep separate written records of the specified variable values you might need later before you perform the calculation.
- You can use only one variable in the function for input sequence a_k .
- Input integers only for the initial term (α) of sequence a_k and last term (β) of sequence a_k .
- Input of n and the closing parentheses can be omitted. If you omit n , the calculator automatically uses $n = 1$.
- Make sure that the value used as the final term β is greater than the value used as the initial term α . Otherwise, an error will occur.
- To interrupt an ongoing Σ calculation (indicated when the cursor is not on the display), press the [AC] key.
- You cannot use a differential, quadratic differential, integration, Σ , maximum/minimum value, Solve, RndFix or $\log_a b$ calculation expression inside of a Σ calculation term.

■ Maximum/Minimum Value Calculations

[OPTN]-[CALC]-[FMin]/[FMax]

After displaying the function analysis menu, you can input maximum/minimum calculations using the formats below, and solve for the maximum and minimum of a function within interval $a \leq x \leq b$.

• Minimum Value

[OPTN] [F4] (CALC) [F6] (\triangleright) [F1] (FMin) $f(x)$ [,] a [,] b [,] n [SHIFT] [] ())

(a : start point of interval, b : end point of interval, n : precision ($n = 1$ to 9))

• Maximum Value

OPTN F4 (CALC) F6 (\triangleright) F2 (FMax) $f(x)$, a , b , n SHIFT F3 ())
 (a : start point of interval, b : end point of interval, n : precision ($n = 1$ to 9))

Example To determine the minimum value for the interval defined by start point $a = 0$ and end point $b = 3$, with a precision of $n = 6$ for the function $y = x^2 - 4x + 9$

Input $f(x)$.

AC OPTN F4 (CALC) F6 (\triangleright) F1 (FMin) ALPHA F5 (U-Z) F4 (X) x^2 $=$ 4 F4 (X) $+$ 9 ,

Input the interval $a = 0$, $b = 3$.

0 , 3 ,

Input the precision $n = 6$.

6 SHIFT F3 ()) EXE



- In the function $f(x)$, only X can be used as a variable in expressions. Other variables (A through Z excluding X, r , θ) are treated as constants, and the value currently assigned to that variable is applied during the calculation.
- Input of n and the closing parenthesis can be omitted.
- Discontinuous points or sections with drastic fluctuation can adversely affect precision or even cause an error.
- Inputting a larger value for n increases the precision of the calculation, but it also increases the amount of time required to perform the calculation.
- The value you input for the end point of the interval (b) must be greater than the value you input for the start point (a). Otherwise an error occurs.
- You can interrupt an ongoing maximum/minimum calculation by pressing the AC key.
- You can input an integer in the range of 1 to 9 for the value of n . Using any value outside this range causes an error.
- You cannot use a differential, quadratic differential, integration, Σ , maximum/minimum value, Solve, RndFix or $\log_a b$ calculation expression inside of a maximum/minimum calculation term.

6. Complex Number Calculations

You can perform addition, subtraction, multiplication, division, parentheses calculations, function calculations, and memory calculations with complex numbers just as you do with the manual calculations described on pages 3-1 to 3-13.

You can select the complex number calculation mode by changing the Complex Mode item on the Setup screen to one of the following settings.

- **{Real}** ... Calculation in the real number range only*¹
- **{a+bi}** ... Performs complex number calculation and displays results in rectangular form
- **{r∠θ}** ... Performs complex number calculation and displays results in polar form*²

*¹ When there is an imaginary number in the argument, however, complex number calculation is performed and the result is displayed using rectangular form.

Examples:

$$\ln 2i = 0.6931471806 + 1.570796327i$$

$$\ln 2i + \ln(-2) = (\text{Non-Real ERROR})$$

*² The display range of θ depends on the angle unit set for the Angle item on the Setup screen.

- Deg ... $-180 < \theta \leq 180$
- Rad ... $-\pi < \theta \leq \pi$
- Gra ... $-200 < \theta \leq 200$

Press **[OPTN]** **[F3]** (CPLX) to display the complex calculation number menu, which contains the following items.

- **{i}** ... {imaginary unit i input}
- **{Abs}/****{Arg}** ... obtains {absolute value}/{argument}
- **{Conj}** ... {obtains conjugate}
- **{ReP}/****{ImP}** ... {real}/ {imaginary} part extraction
- **{►r∠θ}/****{►a+bi}** ... converts the result to {polar}/ {rectangular} form
- Solutions obtained by the Real, $a+bi$ and $r\angle\theta$ modes are different for power root ($x\sqrt[y]{}$) calculations when $x < 0$ and $y = m/n$ when n is an odd number.

$$\begin{aligned} \text{Example: } 3^x\sqrt{-8} &= -2 \text{ (Real)} \\ &= 1 + 1.732050808i \text{ (a+bi)} \\ &= 2\angle 60 \text{ (r}\angle\theta) \end{aligned}$$

- To input the “ \angle ” operator into the polar coordinate expression ($r\angle\theta$), press **[SHIFT]** **[0]** (CATALOG) **[ALPHA]** **[F6]** (SYBL) **[F4]** (┘) **[▼]** ~ **[▼]** (\angle) **[EXE]**.

■ Arithmetic Operations

[OPTN]-[CPLX]-[i]

Arithmetic operations are the same as those you use for manual calculations. You can even use parentheses and memory.

Example $(1 + 2i) + (2 + 3i)$

AC OPTN F3 (CPLX)
 SHIFT X (() 1 + 2 F1 (i) SHIFT ÷ ())
 + SHIFT X (() 2 + 3 F1 (i)
 SHIFT ÷ ()) EXE

(1+2i)+(2+3i) 3+5i

■ Reciprocals, Square Roots, and Squares

Example $\sqrt{3 + i}$

AC OPTN F3 (CPLX)
 SHIFT x² (√) SHIFT X (() 3 +
 F1 (i) SHIFT ÷ ()) EXE

√(3+i)
 1.755317302
 +0.2848487846i

■ Complex Number Format Using Polar Form

Example $2\angle 30 \times 3\angle 45 = 6\angle 75$

SHIFT MENU (SET UP) ↓ ↓ F1 (Deg) ↓
 F3 (r∠θ) EXIT
 AC 2 SHIFT 0 (CATALOG) ALPHA F6 (SYBL)
 F4 (,) ↓ ~ ↓ (∠) EXE 3 0 X 3
 SHIFT 0 (CATALOG) (∠) F1 (INPUT) 4 5 EXE

2∠30×3∠45 6∠75

■ Absolute Value and Argument

[OPTN]-[CPLX]-[Abs]/[Arg]

The unit regards a complex number in the form $a + bi$ as a coordinate on a Gaussian plane, and calculates absolute value $|Z|$ and argument (arg).

Example To calculate absolute value (r) and argument (θ) for the complex number $3 + 4i$, with the angle unit set for degrees

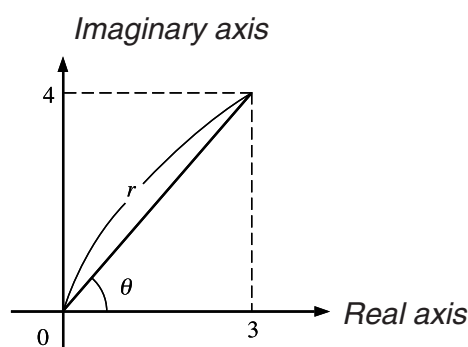

$\boxed{\text{AC}} \boxed{\text{OPTN}} \boxed{\text{F3}} (\text{CPLX}) \boxed{\text{F2}} (\text{Abs})$
 $\boxed{\text{SHIFT}} \boxed{\times} (() \boxed{3} \boxed{+} \boxed{4} \boxed{\text{F1}} (i) \boxed{\text{SHIFT}} \boxed{\div} ()) \boxed{\text{EXE}}$
 (Calculation of absolute value)

$\boxed{\text{Abs } (3+4i)}$
 $\boxed{5}$

$\boxed{\text{AC}} \boxed{\text{OPTN}} \boxed{\text{F3}} (\text{CPLX}) \boxed{\text{F3}} (\text{Arg})$
 $\boxed{\text{SHIFT}} \boxed{\times} (() \boxed{3} \boxed{+} \boxed{4} \boxed{\text{F1}} (i) \boxed{\text{SHIFT}} \boxed{\div} ()) \boxed{\text{EXE}}$
 (Calculation of argument)

$\boxed{\text{Arg } (3+4i)}$
 $\boxed{53.13010235}$

- The result of the argument calculation differs in accordance with the current angle unit setting (degrees, radians, grads).

■ Conjugate Complex Numbers

[OPTN]-[CPLX]-[Conj]

A complex number of the form $a + bi$ becomes a conjugate complex number of the form $a - bi$.

Example To calculate the conjugate complex number for the complex number $2 + 4i$

$\boxed{\text{AC}} \boxed{\text{OPTN}} \boxed{\text{F3}} (\text{CPLX}) \boxed{\text{F4}} (\text{Conj})$
 $\boxed{\text{SHIFT}} \boxed{\times} (() \boxed{2} \boxed{+} \boxed{4} \boxed{\text{F1}} (i) \boxed{\text{SHIFT}} \boxed{\div} ()) \boxed{\text{EXE}}$

$\boxed{\text{Conj } (2+4i)}$
 $\boxed{2-4i}$

■ Extraction of Real and Imaginary Parts

[OPTN]-[CPLX]-[ReP]/[ImP]

Use the following procedure to extract the real part a and the imaginary part b from a complex number of the form $a + bi$.

Example To extract the real and imaginary parts of the complex number $2 + 5i$

$\boxed{\text{AC}} \boxed{\text{OPTN}} \boxed{\text{F3}} (\text{CPLX}) \boxed{\text{F6}} (\triangleright) \boxed{\text{F1}} (\text{ReP})$
 $\boxed{\text{SHIFT}} \boxed{\times} (() \boxed{2} \boxed{+} \boxed{5} \boxed{\text{F6}} (\triangleright) \boxed{\text{F1}} (i)$
 $\boxed{\text{SHIFT}} \boxed{\div} ()) \boxed{\text{EXE}}$
 (Real part extraction)

$\boxed{\text{ReP } (2+5i)}$
 $\boxed{2}$

$\boxed{\text{AC}} \boxed{\text{OPTN}} \boxed{\text{F3}} (\text{CPLX}) \boxed{\text{F6}} (\triangleright) \boxed{\text{F2}} (\text{ImP})$
 $\boxed{\text{SHIFT}} \boxed{\times} (() \boxed{2} \boxed{+} \boxed{5} \boxed{\text{F6}} (\triangleright) \boxed{\text{F1}} (i)$
 $\boxed{\text{SHIFT}} \boxed{\div} ()) \boxed{\text{EXE}}$
 (Imaginary part extraction)

$\boxed{\text{ImP } (2+5i)}$
 $\boxed{5}$

■ Polar and Rectangular Form Transformation

[OPTN]-[CPLX]-[►r∠θ]/[►a+bi]

Use the following procedure to transform a complex number displayed in rectangular form to polar form, and vice versa.

Example To transform the rectangular form of complex number $1 + \sqrt{3}i$ to its polar form

SHIFT MENU (SET UP) ⏴ ⏴ F1 (Deg) ⏴
 F2 ($a+bi$) EXIT
 AC 1 + SHIFT X () SHIFT x² (√) 3
 SHIFT ÷ () OPTN F3 (CPLX)
 F1 (i) F6 (▷) F3 (▶ $r\angle\theta$) EXE

$1+(\sqrt{3})i \rightarrow r\angle\theta$ 2∠60

AC 2 SHIFT 0 (CATALOG) ALPHA F6 (SYBL)
 F4 (⏴) ⏴ ~ ⏴ (∠) EXE 6 0 OPTN F3 (CPLX)
 F6 (▷) F4 (▶ $a+bi$) EXE

$2\angle 60 \rightarrow a+bi$
 $1+1.732050808i$

- The input/output range of complex numbers is normally 10 digits for the mantissa and two digits for the exponent.
- When a complex number has more than 21 digits, the real part and imaginary part are displayed on separate lines.
- The following functions can be used with complex numbers.
 $\sqrt{\quad}$, x^2 , x^{-1} , $\wedge(x^y)$, $\sqrt[3]{\quad}$, $\sqrt[x]{\quad}$, ln, log, $\log_a b$, 10^x , e^x , Int, Frac, Rnd, Intg, RndFix(, Fix, Sci, ENG, $\overleftarrow{\text{ENG}}$, ° ' ", $\frac{\quad}{\quad}$, a^b/c , d/c

7. Binary, Octal, Decimal, and Hexadecimal Calculations with Integers

You can use the **RUN • MAT** mode and binary, octal, decimal, and hexadecimal settings to perform calculations that involve binary, octal, decimal and hexadecimal values. You can also convert between number systems and perform bitwise operations.

- You cannot use scientific functions in binary, octal, decimal, and hexadecimal calculations.
- You can use only integers in binary, octal, decimal, and hexadecimal calculations, which means that fractional values are not allowed. If you input a value that includes a decimal part, the calculator automatically cuts off the decimal part.
- If you attempt to enter a value that is invalid for the number system (binary, octal, decimal, hexadecimal) you are using, the calculator displays an error message. The following shows the numerals that can be used in each number system.

Binary: 0, 1

Octal: 0, 1, 2, 3, 4, 5, 6, 7

Decimal: 0, 1, 2, 3, 4, 5, 6, 7, 8, 9

Hexadecimal: 0, 1, 2, 3, 4, 5, 6, 7, 8, 9, A, B, C, D, E, F

- Negative binary, octal, and hexadecimal values are produced using the two's complement of the original value.
- The following are the display capacities for each of the number systems.

Number System	Binary	Octal	Decimal	Hexadecimal
Display Capacity	16 digits	11 digits	10 digits	8 digits

- The alphabetic characters used in the hexadecimal number appear differently on the display to distinguish them from text characters.

Normal Text	A	B	C	D	E	F
Hexadecimal Values	A	B	C	D	E	F
Keys	F4 (HEX) F1 (A)	F4 (HEX) F2 (B)	F4 (HEX) F3 (C)	F4 (HEX) F4 (D)	F4 (HEX) F5 (E)	F4 (HEX) F6 (F)

- The following are the calculation ranges for each of the number systems.

Binary Values

Positive: $0 \leq x \leq 1111111111111111$

Negative: $1000000000000000 \leq x \leq 1111111111111111$

Octal Values

Positive: $0 \leq x \leq 17777777777$

Negative: $20000000000 \leq x \leq 37777777777$

Decimal Values

Positive: $0 \leq x \leq 2147483647$

Negative: $-2147483648 \leq x \leq -1$

Hexadecimal Values

Positive: $0 \leq x \leq 7FFFFFFF$

Negative: $80000000 \leq x \leq FFFFFFFF$

- **To perform a binary, octal, decimal, or hexadecimal calculation**

[SET UP]-[Mode]-[Dec]/[Hex]/[Bin]/[Oct]

1. In the Main Menu, select **RUN • MAT**.
2. Press **SHIFT** **MENU** (SET UP). Move the highlighting to “Mode”, and then specify the default number system by pressing **F2** (Dec), **F3** (Hex), **F4** (Bin), or **F5** (Oct) for the Mode setting.
3. Press **EXIT** to change to the screen for calculation input. This causes a function menu with the following items to appear.
 - **{d~o}/LOG/DISP/HEX** ... {number system specification}/{bitwise operation}/
{decimal/hexadecimal/binary/octal conversion}/{hexadecimal letter (A through F)
input} menu

■ Selecting a Number System

You can specify decimal, hexadecimal, binary, or octal as the default number system using the Setup screen.

- **To specify a number system for an input value**

You can specify a number system for each individual value you input. Press **F1** (d~o) to display a menu of number system symbols. Press the function key that corresponds to the symbol you want to select and then input the value.

- **{d}/h/b/o** ... {decimal}/hexadecimal/binary/octal}

• To input values of mixed number systems

Example To input 123₁₀, when the default number system is hexadecimal

SHIFT **MENU** (SET UP)

Move the highlighting to “Mode”, and then press **F3** (Hex) **EXIT**.

AC **F1** (d~o) **F1** (d) **1** **2** **3** **EXE**

d123 0000007B

■ Negative Values and Bitwise Operations

Press **F2** (LOG) to display a menu of negation and bitwise operators.

- **{Neg}** ... {negation}^{*1}
- **{Not}/{and}/{or}/{xor}/{xnor}** ... {NOT}^{*2}/**{AND}**/**{OR}**/**{XOR}**/**{XNOR}**^{*3}

*1 two's complement

*2 one's complement (bitwise complement)

*3 bitwise AND, bitwise OR, bitwise XOR, bitwise XNOR

• Negative Values

Example To determine the negative of 110010₂

SHIFT **MENU** (SET UP)

Move the highlighting to “Mode”, and then press **F4** (Bin) **EXIT**.

AC **F2** (LOG) **F1** (Neg)

1 **1** **0** **0** **1** **0** **EXE**

Neg 110010
1111111111001110

- Negative binary, octal, and hexadecimal values are produced by taking the binary two's complement and then returning the result to the original number base. With the decimal number base, negative values are displayed with a minus sign.

• Bitwise Operations

Example To input and execute “120₁₆ and AD₁₆”

SHIFT **MENU** (SET UP)

Move the highlighting to “Mode”, and then press **F3** (Hex) **EXIT**.

AC **1** **2** **0** **F2** (LOG)

F3 (and) **EXIT** **F4** (HEX) **F1** (A) **F4** (D) **EXE**

120andAD 00000020

■ Number System Transformation

Press **F3** (DISP) to display a menu of number system transformation functions.

- **{►Dec}/{►Hex}/{►Bin}/{►Oct}** ... transformation of displayed value to its {decimal}/ {hexadecimal}/ {binary}/ {octal} equivalent

• To convert a displayed value from one number system to another

Example **To convert 22₁₀ (default number system) to its binary or octal value**

AC **SHIFT** **MENU** (SET UP)

Move the highlighting to “Mode”, and then press **F2** (Dec) **EXIT**.

F1 (d~o) **F1** (d) **2** **2** **EXE**

d22 22

EXIT **F3** (DISP) **F3** (►Bin) **EXE**

Ans►Bin
0000000000010110

F4 (►Oct) **EXE**

Ans►Oct
00000000026

8. Matrix Calculations

From the Main Menu, enter the **RUN • MAT** mode, and press **F1** (►MAT) to perform Matrix calculations.

26 matrix memories (Mat A through Mat Z) plus a Matrix Answer Memory (MatAns), make it possible to perform the following matrix operations.

- Addition, subtraction, multiplication, division
- Scalar multiplication calculations
- Determinant calculations
- Matrix transposition
- Matrix inversion
- Matrix squaring
- Raising a matrix to a specific power
- Absolute value, integer part extraction, fractional part extraction, maximum integer calculations
- Inputting complex numbers in matrix elements and using complex number related functions
- Matrix modification using matrix commands

The maximum number of rows that can be specified for a matrix is 999, and the maximum number of columns is 999.

About Matrix Answer Memory (MatAns)

- The calculator automatically stores matrix calculation results in Matrix Answer Memory. Note the following points about Matrix Answer Memory.
- Whenever you perform a matrix calculation, the current Matrix Answer Memory contents are replaced by the new result. The previous contents are deleted and cannot be recovered.
- Inputting values into a matrix does not affect Matrix Answer Memory contents.

Inputting and Editing Matrices

Pressing **F1** (▶MAT) displays the Matrix Editor screen. Use the Matrix Editor to input and edit matrices.

$m \times n$... m (row) \times n (column) matrix
None... no matrix preset

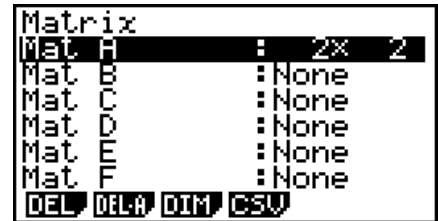

- **{DEL}**/**{DEL·A}** ... deletes {a specific matrix}/{all matrices}
- **{DIM}** ... {specifies the matrix dimensions (number of cells)}
- **{CSV}** ... {transfers data between matrices and CSV files}

Creating a Matrix

To create a matrix, you must first define its dimensions (size) in the Matrix Editor. Then you can input values into the matrix.

To specify the dimensions (size) of a matrix

Example To create a 2-row \times 3-column matrix in the area named Mat B

Highlight Mat B.



F3 (DIM) (This step can be omitted.)

Specify the number of rows.

2 **EXE**

Specify the number of columns.

3 **EXE**

EXE

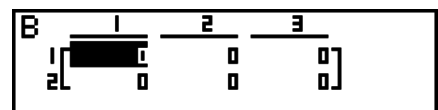

- All of the cells of a new matrix contain the value 0.
- Changing the dimensions of a matrix deletes its current contents.
- If “Memory ERROR” remains next to the matrix area name after you input the dimensions, it means there is not enough free memory to create the matrix you want.

To input cell values

Example To input the following data into Matrix B:

1	2	3
4	5	6

The following operation is a continuation of the example calculation in “To specify the dimensions (size) of a matrix”.

1 [EXE] 2 [EXE] 3 [EXE]
 4 [EXE] 5 [EXE] 6 [EXE]

(Data is input into the highlighted cell. Each time you press [EXE], the highlighting moves to the next cell to the right.)

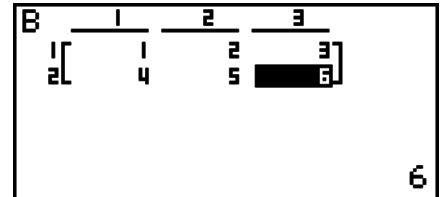

- Displayed cell values show positive integers up to six digits, and negative integers up to five digits (one digit used for the negative sign). Exponential values are shown with up to two digits for the exponent. Fractional values are not displayed.

• Deleting Matrices

You can delete either a specific matrix or all matrices in memory.

• To delete a specific matrix

1. While the Matrix Editor is on the display, use \blacktriangle and \blacktriangledown to highlight the matrix you want to delete.
2. Press [F1] (DEL).
3. Press [F1] (Yes) to delete the matrix or [F6] (No) to abort the operation without deleting anything.

• To delete all matrices

1. While the Matrix Editor is on the display, press [F2] (DEL • A).
2. Press [F1] (Yes) to delete all matrices in memory or [F6] (No) to abort the operation without deleting anything.

■ Matrix Cell Operations

Use the following procedure to prepare a matrix for cell operations.

1. While the Matrix Editor is on the display, use \blacktriangle and \blacktriangledown to highlight the name of the matrix you want to use.

You can jump to a specific matrix by inputting the letter that corresponds to the matrix name. Inputting α [F3] (K-O) [F4] (N), for example, jumps to Mat N.

Pressing [Ans] jumps to the matrix current memory.

2. Press [EXE] and the function menu with the following items appears.

- {R-OP} ... {row operation menu}
- {ROW}
 - {DEL}/{INS}/{ADD} ... row {delete}/{insert}/{add}
- {COL}
 - {DEL}/{INS}/{ADD} ... column {delete}/{insert}/{add}
- {EDIT} ... {cell editing screen}

All of the following examples use Matrix A.

• Row Calculations

The following menu appears whenever you press **F1** (R-OP) while a recalled matrix is on the display.

- **{Swap}** ... {row swap}
- **{×Rw}** ... {product of specified row and scalar}
- **{×Rw+}** ... {addition of one row and the product of a specified row with a scalar}
- **{Rw+}** ... {addition of specified row to another row}

• To swap two rows

Example To swap rows two and three of the following matrix:

All of the operation examples are performed using the following matrix.

$$\text{Matrix A} = \begin{bmatrix} 1 & 2 \\ 3 & 4 \\ 5 & 6 \end{bmatrix}$$

F1 (R-OP) **F1** (Swap)

Input the number of the rows you want to swap.

2 **EXE** **3** **EXE** **EXE**

A	1	2
1	1	2
2	5	6
3	3	4

• To calculate the scalar multiplication of a row

Example To calculate the product of row 2 and the scalar 4

F1 (R-OP) **F2** (×Rw)

Input multiplier value.*

4 **EXE**

Specify row number.

2 **EXE** **EXE**

A	1	2
1	1	2
2	12	16
3	5	6

* A complex number also can be input as multiplier value (k).

• To calculate the scalar multiplication of a row and add the result to another row

Example To calculate the product of row 2 and the scalar 4, then add the result to row 3

F1 (R-OP) **F3** (×Rw+)

Input multiplier value.*

4 **EXE**

Specify number of row whose product should be calculated.

2 **EXE**

Specify number of row where result should be added.

3 **EXE** **EXE**

A	1	2
1	1	2
2	3	4
3	17	22

* A complex number also can be input as multiplier value (k).

• **To add two rows together**

Example **To add row 2 to row 3**

F1 (R-OP) **F4** (Rw+)

Specify number of row to be added.

2 **EXE**

Specify number of row to be added to.

3 **EXE** **EXE**

A	1	2
1	1	2
2	3	4
3	8	6

• **Row Operations**

- **{DEL}** ... {delete row}
- **{INS}** ... {insert row}
- **{ADD}** ... {add row}

• **To delete a row**

Example **To delete row 2**

F2 (ROW) **▼**

A	1	2
1	1	2
2	3	4
3	5	6

F1 (DEL)

A	1	2
1	1	2
2	5	6

• **To insert a row**

Example **To insert a new row between rows one and two**

F2 (ROW) **▼**

F2 (INS)

A	1	2
1	1	2
2	0	0
3	3	4
4	5	6

• **To add a row**

Example **To add a new row below row 3**

F2 (ROW) **▼** **▼**

F3 (ADD)

A	1	2
1	1	2
2	3	4
3	5	6
4	0	0

• Column Operations

- {DEL} ... {delete column}
- {INS} ... {insert column}
- {ADD} ... {add column}

• To delete a column

Example **To delete column 2**

F3 (COL) 





F1 (DEL)



■ Transferring Data between Matrices and CSV Files

You can import the contents of a CSV file stored with this calculator or transferred from a computer into one of the matrix memories (Mat A through Mat Z, and MatAns). You also can save the contents of one of the matrix memories (Mat A through Mat Z, and MatAns) as a CSV file.

• To import the contents of a CSV file to a matrix memory

1. Prepare the CSV file you want to import.
 - See “Import CSV File Requirements” (page 4-13).
2. While the Matrix Editor is on the display, use  and  to highlight the name of the matrix to which you want to import the CSV file contents.
 - If the matrix you select already contains data, performing the following steps will overwrite its current contents with the newly imported CSV file data.
3. Press **F4** (CSV) **F1** (LOAD).
 - This will display a dialog box for specifying whether a CSV file should be imported from storage memory or the SD card.
4. Select **1** (Storage Mem) to select storage memory, or **2** (SD Card) to select the SD card.
 - Pressing **EXE** in the next step will overwrite the specified matrix memory data with the CSV file data.
5. On the select file dialog box that appears, use  and  to move the highlighting to the file you want to import and then press **EXE**.
 - This imports the contents of the CSV file you specified to the matrix memory.

Important!

Attempting to import the following types of CSV files will result in an error.

- A CSV file that includes data that cannot be converted. In this case, an error message will appear showing the location in the CSV file (Example: row 2, column 3) where the data that cannot be converted is located.
- A CSV file with more than 999 columns or 999 rows. In this case, an “Invalid Data Size” error will occur.

• To save matrix contents as a CSV file

1. While the Matrix Editor is on the display, use \blacktriangle and \blacktriangledown to highlight the name of the matrix whose contents you want to save as a CSV file.
2. Press $\boxed{F4}$ (CSV) $\boxed{F2}$ (SV • AS).
 - This will display a dialog box for specifying whether the CSV file should be saved to storage memory or the SD card.
3. Select $\boxed{1}$ (Storage Mem) to select storage memory, or $\boxed{2}$ (SD Card) to select the SD card.
 - This displays a folder selection screen.
4. Select the folder where you want to save the CSV file.
 - To store the CSV file in the root directory, highlight "ROOT".
 - To store the CSV file in a folder, use \blacktriangle and \blacktriangledown to move the highlighting to the desired folder and then press $\boxed{F1}$ (OPEN).
5. Press $\boxed{F1}$ (SV • AS).
6. Input up to eight characters for the file name and then press \boxed{EXE} .

Important!

- When saving matrix data to a CSV file, some data is converted as described below.
 - Complex number data: Only the real number part is extracted.
 - Fraction data: Converted to calculation line format (Example: $2\frac{3}{4} \rightarrow =2+3/4$)

• To specify the CSV file delimiter symbol and decimal point

While the Matrix Editor is on the display, press $\boxed{F4}$ (CSV) $\boxed{F3}$ (SET) to display the CSV format setting screen. Next, perform the procedure from step 3 under "Specifying the CSV File Delimiter Symbol and Decimal Point" (page 4-15).

■ Modifying Matrices Using Matrix Commands

[OPTN]-[MAT]

• To display the matrix commands

1. From the Main Menu, enter the **RUN • MAT** mode.
2. Press \boxed{OPTN} to display the option menu.
3. Press $\boxed{F2}$ (MAT) to display the matrix command menu.

The following describes only the matrix command menu items that are used for creating matrices and inputting matrix data.

- **{Mat}** ... {Mat command (matrix specification)}
- **{M→L}** ... {Mat→List command (assign contents of selected column to list file)}
- **{Aug}** ... {Augment command (link two matrices)}
- **{Iden}** ... {Identity command (identity matrix input)}
- **{Dim}** ... {Dim command (dimension check)}
- **{Fill}** ... {Fill command (identical cell values)}

• Matrix Data Input Format

[OPTN]-[MAT]-[Mat]

The following shows the format you should use when inputting data to create a matrix using the Mat command.

$$\begin{bmatrix} a_{11} & a_{12} & \dots & a_{1n} \\ a_{21} & a_{22} & \dots & a_{2n} \\ \vdots & \vdots & & \vdots \\ a_{m1} & a_{m2} & \dots & a_{mn} \end{bmatrix} = [[a_{11}, a_{12}, \dots, a_{1n}] [a_{21}, a_{22}, \dots, a_{2n}] \dots [a_{m1}, a_{m2}, \dots, a_{mn}]]$$

→ Mat [letter A through Z]

Example To input the following data as Matrix A: $\begin{bmatrix} 1 & 3 & 5 \\ 2 & 4 & 6 \end{bmatrix}$

[SHIFT] [0] (CATALOG) [ALPHA] [F6] (SYBL) [F4] (..) [[1,3,5][2,4,6]]→Mat
 [▼] ~ [▼] ([]) [EXE] [SHIFT] [0] (CATALOG) ([]) A
 [F1] (INPUT) [1] [,] [3] [,] [5]
 [SHIFT] [0] (CATALOG) [▼] ([]) [F1] (INPUT)
 [SHIFT] [0] (CATALOG) [▲] ([]) [F1] (INPUT)
 [2] [,] [4] [,] [6]
 [SHIFT] [0] (CATALOG) [▼] ([]) [F1] (INPUT)
 [SHIFT] [0] (CATALOG) ([]) [F1] (INPUT) [SHIFT] [Ans] (→)
 [OPTN] [F2] (MAT) [F1] (Mat) [ALPHA] [F1] (A-E) [F1] (A)
 [EXE] Matrix name A

	1	2	3
1	1	3	5
2	2	4	6

- The maximum value of both m and n is 999.
- An error occurs if memory becomes full as you are inputting data.
- You can also use the above format inside a program that inputs matrix data.

• To input an identity matrix

[OPTN]-[MAT]-[Iden]

Use the Identity command to create an identity matrix.

Example To create a 3×3 identity matrix as Matrix A

[OPTN] [F2] (MAT) [F6] (▷) [F1] (Iden) A
 [3] [SHIFT] [Ans] (→) [F6] (▷) [F1] (Mat) [ALPHA] 1
└─ Number of rows/columns
 [F1] (A-E) [F1] (A) [EXE]

	1	2	3
1	1	0	0
2	0	1	0
3	0	0	1

• To check the dimensions of a matrix

[OPTN]-[MAT]-[Dim]

Use the Dim command to check the dimensions of an existing matrix.

Example 1 To check the dimensions of Matrix A

OPTN F2 (MAT) F6 (\triangleright) F2 (Dim)
 F6 (\triangleright) F1 (Mat) ALPHA F1 (A-E) F1 (A) EXE

Ans
 $\begin{bmatrix} 1 & \blacksquare & \blacksquare \\ 2 & \blacksquare & \blacksquare \end{bmatrix}$

The display shows that Matrix A consists of two rows and three columns. Since the result of the Dim command is list type data, it is stored in ListAns Memory.

You can also use {Dim} to specify the dimensions of the matrix.

Example 2 To specify dimensions of 2 rows and 3 columns for Matrix B

SHIFT 0 (CATALOG) ALPHA F6 (SYBL) F4 ()
 \blacktriangledown \sim \blacktriangledown ({) EXE 2 , 3
 SHIFT 0 (CATALOG) \blacktriangledown ()
 F1 (INPUT) SHIFT Ans (\rightarrow) OPTN F2 (MAT)
 F6 (\triangleright) F2 (Dim) F6 (\triangleright) F1 (Mat)
 ALPHA F1 (A-E) F2 (B) EXE

B

	1	2	3
1	\blacksquare	0	0
2	0	0	0

• Modifying Matrices Using Matrix Commands

You can also use matrix commands to assign values to and recall values from an existing matrix, to fill in all cells of an existing matrix with the same value, to combine two matrices into a single matrix, and to assign the contents of a matrix column to a list file.

• To assign values to and recall values from an existing matrix

[OPTN]-[MAT]-[Mat]

Use the following format with the Mat command to specify a cell for value assignment and recall.

Mat X [m , n]

X = matrix name (A through Z, or Ans)

m = row number

n = column number

Example 1 To assign 10 to the cell at row 1, column 2 of the following matrix:

Matrix A = $\begin{bmatrix} 1 & 2 \\ 3 & 4 \\ 5 & 6 \end{bmatrix}$

1 0 SHIFT Ans (\rightarrow) OPTN F2 (MAT) F1 (Mat)
 ALPHA F1 (A-E) F1 (A) SHIFT 0 (CATALOG)
 ALPHA F6 (SYBL) F4 () \blacktriangledown \sim \blacktriangledown ([) EXE
 1 , 2 SHIFT 0 (CATALOG) \blacktriangledown ()
 F1 (INPUT) EXE

$\text{10} \rightarrow \text{Mat A}[1,2]$ 10

Example 2 Multiply the value in the cell at row 2, column 2 of the above matrix by 5

[OPTN] [F2] (MAT) [F1] (Mat) [ALPHA] [F1] (A-E) [F1] (A) [Mat] A[2,2]×5 20
 [SHIFT] [0] (CATALOG) [ALPHA] [F6] (SYBL) [F4] (.)
 [↓] ~ [↓] ([) [EXE] [2] , [2]
 [SHIFT] [0] (CATALOG) [↓] ([) [F1] (INPUT) [X] [5] [EXE]

• **To fill a matrix with identical values and to combine two matrices into a single matrix** [OPTN]-[MAT]-[Fill]/[Aug]

Use the Fill command to fill all the cells of an existing matrix with an identical value and the Augment command to combine two existing matrices into a single matrix.

Example 1 To fill all of the cells of Matrix A with the value 3

[OPTN] [F2] (MAT) [F6] (▷) [F3] (Fill) [3] , [F6] (▷) [F1] (Mat)
 [ALPHA] [F1] (A-E) [F1] (A) [EXE] [EXIT] [EXIT]
 [F1] (Mat) [ALPHA] [F1] (A-E) [F1] (A) [EXE]

Ans	1	2
1	3	3
2	3	3
3	3	3

Example 2 To combine the following two matrices:

$$A = \begin{bmatrix} 1 \\ 2 \end{bmatrix} \quad B = \begin{bmatrix} 3 \\ 4 \end{bmatrix}$$

[OPTN] [F2] (MAT) [F5] (Aug) [F1] (Mat) [ALPHA] [F1] (A-E) [F1] (A) , [EXIT] [EXIT]
 [F1] (Mat) [ALPHA] [F1] (A-E) [F2] (B) [EXE]

Ans	1	2
1	1	3
2	2	4

- The two matrices you combine must have the same number of rows. An error occurs if you try to combine two matrices that have different number of rows.
- You can use Matrix Answer Memory to assign the results of the above matrix input and edit operations to a matrix variable. To do so, use the following syntax.

Fill (n , Mat α)

Augment (Mat α , Mat β) → Mat γ

In the above, α , β , and γ are any variable names A through Z, and n is any value.

The above does not affect the contents of Matrix Answer Memory.

• **To assign the contents of a matrix column to a list** [OPTN]-[MAT]-[M→L]

Use the following format with the Mat→List command to specify a column and a list.

Mat → List (Mat X, m) → List n

X = matrix name (A through Z)

m = column number

n = list number

Example To assign the contents of column 2 of the following matrix to list 1:

$$\text{Matrix A} = \begin{bmatrix} 1 & 2 \\ 3 & 4 \\ 5 & 6 \end{bmatrix}$$

[OPTN] [F2] (MAT) [F2] (M→L) [F1] (Mat)
 [ALPHA] [F1] (A-E) [F1] (A) [2] [SHIFT] [÷] ())
 [SHIFT] [Ans] (→) [OPTN] [F1] (LIST) [F1] (List) [1] [EXE]
 [F1] (List) [1] [EXE]

Ans

1	2
2	4
3	6

Matrix Calculations

[OPTN]-[MAT]

Use the matrix command menu to perform matrix calculation operations.

• To display the matrix commands

1. From the Main Menu, enter the **RUN • MAT** mode.
2. Press [OPTN] to display the option menu.
3. Press [F2] (MAT) to display the matrix command menu.

The following describes only the matrix commands that are used for matrix arithmetic operations.

- {Mat} ... {Mat command (matrix specification)}
- {Det} ... {Det command (determinant command)}
- {Trn} ... {Trn command (transpose matrix command)}
- {Iden} ... {Identity command (identity matrix input)}
- {Ref} ... {Ref command (row echelon form command)}
- {Rref} ... {Rref command (reduced row echelon form command)}

All of the following examples assume that matrix data is already stored in memory.

• Matrix Arithmetic Operations

[OPTN]-[MAT]-[Mat]/[Iden]

Example 1 To add the following two matrices (Matrix A + Matrix B):

$$A = \begin{bmatrix} 1 & 1 \\ 2 & 1 \end{bmatrix} \quad B = \begin{bmatrix} 2 & 3 \\ 2 & 1 \end{bmatrix}$$

[AC] [OPTN] [F2] (MAT) [F1] (Mat)
 [ALPHA] [F1] (A-E) [F1] (A) [+] [EXIT] [EXIT]
 [F1] (Mat) [ALPHA] [F1] (A-E) [F2] (B) [EXE]

Ans

	1	2
1	3	4
2	4	2

Example 2 To multiply the two matrices in Example 1 (Matrix A × Matrix B)

[AC] [OPTN] [F2] (MAT) [F1] (Mat)
 [ALPHA] [F1] (A-E) [F1] (A) [×] [EXIT] [EXIT]
 [F1] (Mat) [ALPHA] [F1] (A-E) [F2] (B) [EXE]

Ans

	1	2
1	0	4
2	6	7

- The two matrices must have the same dimensions in order to be added or subtracted. An error occurs if you try to add or subtract matrices of different dimensions.
- For multiplication (Matrix 1 × Matrix 2), the number of columns in Matrix 1 must match the number of rows in Matrix 2. Otherwise, an error occurs.

• Determinant

[OPTN]-[MAT]-[Det]

Example Obtain the determinant for the following matrix:

$$\text{Matrix A} = \begin{bmatrix} 1 & 2 & 3 \\ 4 & 5 & 6 \\ -1 & -2 & 0 \end{bmatrix}$$

[OPTN] [F2] (MAT) [F3] (Det) [F1] (Mat)
[ALPHA] [F1] (A-E) [F1] (A) [EXE]

Det Mat A	-9
-----------	----

- Determinants can be obtained only for square matrices (same number of rows and columns). Trying to obtain a determinant for a matrix that is not square produces an error.
- The determinant of a 2×2 matrix is calculated as shown below.

$$|A| = \begin{vmatrix} a_{11} & a_{12} \\ a_{21} & a_{22} \end{vmatrix} = a_{11}a_{22} - a_{12}a_{21}$$

- The determinant of a 3×3 matrix is calculated as shown below.

$$|A| = \begin{vmatrix} a_{11} & a_{12} & a_{13} \\ a_{21} & a_{22} & a_{23} \\ a_{31} & a_{32} & a_{33} \end{vmatrix} = a_{11}a_{22}a_{33} + a_{12}a_{23}a_{31} + a_{13}a_{21}a_{32} - a_{11}a_{23}a_{32} - a_{12}a_{21}a_{33} - a_{13}a_{22}a_{31}$$

• Matrix Transposition

[OPTN]-[MAT]-[Trn]

A matrix is transposed when its rows become columns and its columns become rows.

Example To transpose the following matrix:

$$\text{Matrix A} = \begin{bmatrix} 1 & 2 \\ 3 & 4 \\ 5 & 6 \end{bmatrix}$$

[OPTN] [F2] (MAT) [F4] (Trn) [F1] (Mat)
[ALPHA] [F1] (A-E) [F1] (A) [EXE]

Ans	1	2	3
1	1	3	5
2	2	4	6

• Row Echelon Form

[OPTN]-[MAT]-[Ref]

This command uses the Gaussian elimination algorithm to find the row echelon form of a matrix.

Example To find the row echelon form of the following matrix:

$$\text{Matrix A} = \begin{bmatrix} 1 & 2 & 3 \\ 4 & 5 & 6 \end{bmatrix}$$

[OPTN] [F2] (MAT) [F6] (>) [F4] (Ref)
[F6] (>) [F1] (Mat) [ALPHA] [F1] (A-E) [F1] (A) [EXE]

Ans	1	2	3
1	1	1.25	1.5
2	0	1	2

1

• Reduced Row Echelon Form

[OPTN]-[MAT]-[Rref]

This command finds the reduced row echelon form of a matrix.

Example To find the reduced row echelon form of the following matrix:

$$\text{Matrix A} = \begin{bmatrix} 2 & -1 & 3 & 19 \\ 1 & 1 & -5 & -21 \\ 0 & 4 & 3 & 0 \end{bmatrix}$$

[OPTN] [F2] (MAT) [F6] (▷) [F5] (Rref)
[F6] (▷) [F1] (Mat) [ALPHA] [F1] (A-E) [F1] (A) [EXE]

Ans	1	2	3	4
1	1	0	0	2
2	0	1	0	-3
3	0	0	1	4
				1

- The row echelon form and reduced row echelon form operation may not produce accurate results due to dropped digits.

• Matrix Inversion

[x⁻¹]

Example To invert the following matrix:

$$\text{Matrix A} = \begin{bmatrix} 1 & 2 \\ 3 & 4 \end{bmatrix}$$

[OPTN] [F2] (MAT) [F1] (Mat)
[ALPHA] [F1] (A-E) [F1] (A) [SHIFT] [0] (CATALOG)
[ALPHA] [F6] (SYBL) [F4] (└) [▽] ~ [▽] (-1) [EXE] [EXE]

Ans	1	2
1	-2	1
2	1.5	-0.5

- Only square matrices (same number of rows and columns) can be inverted. Trying to invert a matrix that is not square produces an error.
- A matrix with a determinant of zero cannot be inverted. Trying to invert a matrix with determinant of zero produces an error.
- Calculation precision is affected for matrices whose determinant is near zero.
- A matrix being inverted must satisfy the conditions shown below.

$$\mathbf{A A^{-1} = A^{-1} A = E = \begin{bmatrix} 1 & 0 \\ 0 & 1 \end{bmatrix}}$$

The following shows the formula used to invert Matrix A into inverse matrix A⁻¹.

$$\mathbf{A = \begin{bmatrix} a & b \\ c & d \end{bmatrix}}$$

$$\mathbf{A^{-1} = \frac{1}{ad - bc} \begin{bmatrix} d & -b \\ -c & a \end{bmatrix}}$$

Note that $ad - bc \neq 0$.

• Squaring a Matrix

[x²]

Example To square the following matrix:

$$\text{Matrix A} = \begin{bmatrix} 1 & 2 \\ 3 & 4 \end{bmatrix}$$

OPTN F2 (MAT) F1 (Mat) ALPHA F1 (A-E)
F1 (A) x² EXE

Ans	1	2
1	5	10
2	15	22

• Raising a Matrix to a Power

[^]

Example To raise the following matrix to the third power:

$$\text{Matrix A} = \begin{bmatrix} 1 & 2 \\ 3 & 4 \end{bmatrix}$$

OPTN F2 (MAT) F1 (Mat) ALPHA F1 (A-E)
F1 (A) SHIFT 0 (CATALOG) ALPHA F6 (SYBL)
F4 () ~ (^) EXE 3 EXE

Ans	1	2
1	27	54
2	81	118

- For matrix power calculations, calculation is possible up to a power of 32766.

• Determining the Absolute Value, Integer Part, Fraction Part, and Maximum Integer of a Matrix

[OPTN]-[NUM]-[Abs]/[Frac]/[Int]/[Intg]

Example To determine the absolute value of the following matrix:

$$\text{Matrix A} = \begin{bmatrix} 1 & -2 \\ -3 & 4 \end{bmatrix}$$

OPTN F6 (▷) F4 (NUM) F1 (Abs)
OPTN F2 (MAT) F1 (Mat)
ALPHA F1 (A-E) F1 (A) EXE

Ans	1	2
1	2	2
2	3	4

• Complex Number Calculations with a Matrix

Example To determine the absolute value of a matrix with the following complex number elements:

$$\text{Matrix D} = \begin{bmatrix} -1 + i & 1 + i \\ 1 + i & -2 + 2i \end{bmatrix}$$

AC OPTN F6 (▷) F4 (NUM) F1 (Abs)
OPTN F2 (MAT) F1 (Mat) ALPHA F1 (A-E)
F4 (D) EXE

Ans	1	2
1	1.4142	1.4142
2	1.4142	2.8284

1.414213562

- The following complex number functions are supported in matrices.
i, Abs, Arg, Conj, ReP, ImP

Matrix Calculation Precautions

- Determinants and inverse matrices are subject to error due to dropped digits.
- Matrix operations are performed individually on each cell, so calculations may require considerable time to complete.
- The calculation precision of displayed results for matrix calculations is ± 1 at the least significant digit.
- If a matrix calculation result is too large to fit into Matrix Answer Memory, an error occurs.
- You can use the following operation to transfer Matrix Answer Memory contents to another matrix (or when Matrix Answer Memory contains a determinant to a variable).

MatAns \rightarrow Mat α

In the above, α is any variable name A through Z. The above does not affect the contents of Matrix Answer Memory.

9. Metric Conversion Calculations

You can convert values from one unit of measurement to another. Measurement units are classified according to the following 11 categories. The indicators in the “Display Name” column show the text that appears in the calculator’s function menu.

Display Name	Category	Display Name	Category	Display Name	Category
LENG	Length	TMPR	Temperature	PRES	Pressure
AREA	Area	VELO	Velocity	ENGY	Energy/Work
VLUM	Volume	MASS	Mass	PWR	Power
TIME	Time	FORC	Force/Weight		

You can convert from any unit in a category to any other unit in the same category.

- Attempting to convert from a unit in one category (such as “AREA”) to a unit in another category (such as “TIME”) results in a Conversion ERROR.
- See the “Unit Conversion Command List” (page 3-50) for information about the units included in each category.

■ Performing a Unit Conversion Calculation

[OPTN]-[CONV]

Input the value you are converting from and the conversion commands using the syntax shown below to perform a unit conversion calculation.

{value converting from}{conversion command 1} \blacktriangleright {conversion command 2}

- Use {conversion command 1} to specify the unit being converted from and {conversion command 2} to specify the unit being converted to.
- \blacktriangleright is a command that links the two conversion commands. This command is always available at **F1**(\blacktriangleright) of the Conversion menu.

- Real numbers or a list that contains real number elements only can be used as the value being converted from. When values being converted from are input into a list (or when list memory is specified), conversion calculation is performed for each element in the list and calculation results are returned in list format (ListAns screen).
- A complex number cannot be used as a value to be converted from. An error occurs if even a single element of a list being used as the value being converted from contains a complex number.

Example 1 To convert 50cm to inches

AC [5] [0] [OPTN] [F6] (▷) [F1] (CONV) [F2] (LENG) [5] (cm) [F1] (▶) [F2] (LENG) [▶] [2] (in) [EXE]

50[cm]▶[in]
19.68503937

Example 2 To convert {175, 162, 180} square meters to hectares

AC [SHIFT] [0] (CATALOG) [ALPHA] [F6] (SYBL)
 [F4] (L) [▼] ~ [▼] ({) [EXE] [1] [7] [5] [,] [1] [6]
 [2] [,] [1] [8] [0] [SHIFT] [0] (CATALOG)
 [▼] (}) [EXE] [OPTN] [F6] (▷) [F1] (CONV) [F3] (AREA)
 [2] (m²) [F1] (▶) [F3] (AREA) [3] (ha) [EXE]

Ans
1 [0.0175]
2 [0.0162]
3 [0.018]
0.0175

■ Unit Conversion Command List

Cat.	Display Name	Unit	Cat.	Display Name	Unit
Length	fm	fermi	Volume	cm ³	cubic centimeter
	Å	angstrom		mL	milliliter
	μm	micrometer		L	liter
	mm	millimeter		m ³	cubic meter
	cm	centimeter		in ³	cubic inch
	m	meter		ft ³	cubic foot
	km	kilometer		fl_oz(UK)	ounce
	AU	astronomical unit		fl_oz(US)	fluid ounce (U.S.)
	l.y.	light year		gal(US)	gallon
	pc	parsec		gal(UK)	UK gallon
	Mil	1/1000 inch		pt	pint
	in	inch		qt	quart
	ft	foot		tsp	teaspoon
	yd	yard		tbsp	tablespoon
	fath	fathom		cup	cup
	rd	rod		ns	nanosecond
	mile	mile		μs	microsecond
	n mile	nautical mile		ms	millisecond
Area	cm ²	square centimeter	Time	s	second
	m ²	square meter		min	minute
	ha	hectare		h	hour
	km ²	square kilometer		day	day
	in ²	square inch		week	week
	ft ²	square foot		yr	year
	yd ²	square yard		s-yr	sidereal year
	acre	acre		t-yr	tropical year
	mile ²	square mile			
	mu(CN)	亩			

Cat.	Display Name	Unit	Cat.	Display Name	Unit
Temperature	°C	degrees Celsius	Pressure	Pa	Pascal
	K	Kelvin		kPa	Kilo Pascal
	°F	degrees Fahrenheit		mmH ₂ O	millimeter of water
	°R	degrees Rankine		mmHg	millimeter of Mercury
Velocity	m/s	meter per second		atm	atmosphere
	km/h	kilometer per hour		inH ₂ O	inch of water
	knot	knot		inHg	inch of Mercury
	ft/s	foot per second		lbf/in ²	pound per square inch
	mile/h	mile per hour		bar	bar
Mass	u	atomic mass unit		kgf/cm ²	kilogram force per square centimeter
	mg	milligram		Energy/Work	eV
	g	gram	J		Joule
	kg	kilogram	cal _{th}		calorie _{th}
	mton	metric ton	cal ₁₅		calorie (15°C)
	oz	avoirdupois ounce	cal _I T		calorie _I T
	lb	pound mass	kcal _{th}		kilocalorie _{th}
	slug	slug	kcal ₁₅		kilocalorie (15°C)
	ton(short)	ton, short (2000lbm)	kcal _I T		kilocalorie _I T
	ton(long)	ton, long (2240lbm)	l-atm		liter atmosphere
Force/Weight	N	newton	kW•h		kilowatt hour
	lbf	pound of force	ft•lbf	foot-pound	
	tonf	ton of force	Btu	British thermal unit	
	dyne	dyne	erg	erg	
	kgf	kilogram of force	kgf•m	kilogram force meter	
Power	W	watt	Power	cal _{th} /s	calorie per second
	hp	horsepower		ft•lbf/s	foot-pound per second
	Btu/min	British thermal unit per minute			

Source: NIST Special Publication 811 (2008). However, “MU (CN)” (1[m²] = 0.0015[亩]) is in accordance with the “Chinese system of measurements” (1930) of the People’s Republic of China).

Chapter 4 List Function

A list is a storage place for multiple data items.

This calculator lets you store up to 26 lists in a single file, and you can store up to six files in memory. Stored lists can be used in arithmetic and statistical calculations, and for graphing.

Element number	Display range				Cell	Column	
	List 1	List 2	List 3	List 4	List 5	List 26	List name
SUB							Sub name
1	56	1	107	3.5	4	0	
2	37	2	75	6	0	0	
3	21	4	122	2.1	0	0	
4	69	8	87	4.4	2	0	
5	40	16	298	3	0	0	
6	48	32	48	6.8	3	0	
7	93	64	338	2	9	0	
8	30	128	49	8.7	0	0	Row
⋮	⋮	⋮	⋮	⋮	⋮	⋮	
⋮	⋮	⋮	⋮	⋮	⋮	⋮	
⋮	⋮	⋮	⋮	⋮	⋮	⋮	

4

1. Inputting and Editing a List

When you enter the **STAT** mode, the “List Editor” will appear first. You can use the List Editor to input data into a list and to perform a variety of other list data operations.

• To input values one-by-one

Use the cursor keys to move the highlighting to the list name, sub name or cell you want to select. Note that  does not move the highlighting to a cell that does not contain a value.

	List 1	List 2	List 3	List 4
SUB				
1	56	107	0	3.5
2	37	75	0	6
3	21	122	0	2.1
4	69	87	0	4.4
				56
				GRAPH CALC

The screen automatically scrolls when the highlighting is located at either edge of the screen.

The following example is performed starting with the highlighting located at Cell 1 of List 1.

1. Input a value and press **EXE** to store it in the list.

3 **EXE**

- The highlighting automatically moves down to the next cell for input.

	List 1	List 2	List 3	List 4
SUB				
1	3			
2				
3				
4				

2. Input the value 4 in the second cell, and then input the result of $2 + 3$ in the next cell.

4 **EXE** **2** **+** **3** **EXE**

	List 1	List 2	List 3	List 4
SUB				
1	3			
2	4			
3	5			
4				

- You can also input the result of an expression or a complex number into a cell.
- You can input values up to 999 cells in a single list.

• To batch input a series of values

1. Use the cursor keys to move the highlighting to another list.

	List 1	List 2	List 3	List 4
SUB				
1	3			

2. Input a left brace ({), and then enter the values, separated by commas. After inputting all of the values you want, input a right brace (}).

[SHIFT] **[0]** (CATALOG) **[ALPHA]** **[F6]** (SYBL) **[F4]** (,)

[↓] ~ **[↓]** ({) **[EXE]** **[6]** , **[7]** , **[8]**

[SHIFT] **[0]** (CATALOG) **[↓]** (}) **[EXE]**

	List 1	List 2	List 3	List 4
SUB				
1	3			
2	4			
3	5			
4	{ 6, 7, 8 }			

3. Press **[EXE]** to store all of the values in your list.

[EXE]

	List 1	List 2	List 3	List 4
SUB				
1	3	6		
2	4	7		
3	5	8		
4				

GRAPH **CALC** 6

• Remember that a comma separates values, so you should not input a comma after the final value of the set you are inputting.

Right: {34, 53, 78}

Wrong: {34, 53, 78,}

You can also use list names inside of a mathematical expression to input values into another cell. The following example shows how to add the values in each row in List 1 and List 2, and input the result into List 3.

1. Use the cursor keys to move the highlighting to the name of the list where you want the calculation results to be input.

	List 1	List 2	List 3	List 4
SUB				
1	3	6		

2. Press **[OPTN]** and input the expression.

[OPTN] **[F1]** (LIST) **[F1]** (List) **[1]** **[+]**

[OPTN] **[F1]** (LIST) **[F1]** (List) **[2]** **[EXE]**

	List 1	List 2	List 3	List 4
SUB				
1	3	6	9	
2	4	7	11	
3	5	8	13	
4				

List **L→M** **Dim** **Fill** **Seq** 9

■ Editing List Values

• To change a cell value

Use the cursor keys to move the highlighting to the cell whose value you want to change. Input the new value and press **[EXE]** to replace the old data with the new one.

• To edit the contents of a cell

1. Use the cursor keys to move the highlighting to the cell whose contents you want to edit.

2. Press **[F6]** (▷) **[F2]** (EDIT).

3. Make any changes in the data you want.

• To delete a cell

1. Use the cursor keys to move the highlighting to the cell you want to delete.
 2. Press **F6**(▷)**F3**(DEL) to delete the selected cell and cause everything below it to be shifted up.
- The cell delete operation does not affect cells in other lists. If the data in the list whose cell you delete is somehow related to the data in neighboring lists, deleting a cell can cause related values to become misaligned.

• To delete all cells in a list

Use the following procedure to delete all the data in a list.

1. Use the cursor keys to move the highlighting to any cell of the list whose data you want to delete.
2. Pressing **F6**(▷)**F4**(DEL•A) causes a confirmation message to appear.
3. Press **F1**(Yes) to delete all the cells in the selected list or **F6**(No) to abort the delete operation without deleting anything.

• To insert a new cell

1. Use the cursor keys to move the highlighting to the location where you want to insert the new cell.
 2. Press **F6**(▷)**F5**(INS) to insert a new cell, which contains a value of 0, causing everything below it to be shifted down.
- The cell insert operation does not affect cells in other lists. If the data in the list where you insert a cell is somehow related to the data in neighboring lists, inserting a cell can cause related values to become misaligned.

■ Naming a List

You can assign List 1 through List 26 “sub names” of up to eight bytes each.

• To name a list

1. On the Setup screen, highlight “Sub Name” and then press **F1**(On) **EXIT**.
2. Use the cursor keys to move the highlighting to the SUB cell of the list you want to name.

	List 1	List 2	List 3	List 4
SUB				
1				
2				
3				
4				

GRAPH CALC D

Ascending order

1. While the lists are on the screen, press **F6**(▷) **F1**(TOOL) **F1**(SRT • A).
2. The prompt “How Many Lists?:” appears to ask how many lists you want to sort. Here we will sort one base list linked to one other list, so we should input 2.

2 **EXE**

3. In response to the “Select Base List List No:” prompt, input the number of the list you want to sort into ascending order. Here we will specify List 1.

1 **EXE**

4. In response to the “Select Second List List No:” prompt, input the number of the list you want to link to the base list. Here we will specify List 2.

2 **EXE**

Descending order

Use the same procedure as that for the ascending order sort. The only difference is that you should press **F2**(SRT • D) in place of **F1**(SRT • A).

- You can specify a value from 1 to 6 as the number of lists for sorting.
- If you specify a list more than once for a single sort operation, an error occurs.
An error also occurs if lists specified for sorting do not have the same number of values (rows).

2. Manipulating List Data

List data can be used in arithmetic and function calculations. In addition, various list data manipulation functions make manipulation of list data quick and easy.

You can use list data manipulation functions in the **RUN • MAT**, **STAT** and **PRGM** modes.

■ Accessing the List Data Manipulation Function Menu

All of the following examples are performed after entering the **RUN • MAT** mode.

Press **OPTN** and then **F1**(LIST) to display the list data manipulation menu, which contains the following items.

- **{List}/{L→M}/{Dim}/{Fill}/{Seq}/{Min}/{Max}/{Mean}/{Med}/{Aug}/{Sum}/{Prod}/{CumI}/
{%}/{Δ}**

Note that all closing parentheses at the end of the following operations can be omitted.

• To transfer list contents to Matrix Answer Memory **[OPTN]-[LIST]-[L→M]**

OPTN **F1**(LIST) **F2**(L→M) **F1**(List) <list number 1-26> **▾** **F1**(List) <list number 1-26> ...
▾ **F1**(List) <list number 1-26> **SHIFT** **↵** () **EXE**

- You can skip input **F1**(List) in the part of the above operation.

Example: List → Mat (1, 2) **EXE**

- All the lists must contain the same number of data items. If they don't, an error occurs.

Example To transfer the contents of List 1 (2, 3, 6, 5, 4) to column 1, and the contents of List 2 (11, 12, 13, 14, 15) to column 2 of Matrix Answer Memory

AC OPTN F1 (LIST) F2 (L→M)
 F1 (List) 1 ▸ F1 (List) 2 SHIFT $\frac{\square}{\square}$ () EXE

Ans	1	2
1	2	11
2	3	12
3	6	13
4	5	14
5	4	15

• **To count the number of data items in a list** [OPTN]-[LIST]-[Dim]

OPTN F1 (LIST) F3 (Dim) F1 (List) <list number 1 - 26> EXE

• The number of cells a list contains is its “dimension.”

Example To count the number of values in List 1 (36, 16, 58, 46, 56)

AC OPTN F1 (LIST) F3 (Dim)
 F1 (List) 1 EXE

Dim List 1	5
------------	---

• **To create a list by specifying the number of data items** [OPTN]-[LIST]-[Dim]

Use the following procedure to specify the number of data in the assignment statement and create a list.

<number of data n > SHIFT Ans (→) OPTN F1 (LIST) F3 (Dim) F1 (List) <list number 1 - 26> EXE
 ($n = 1 - 999$)

Example To create five data items (each of which contains 0) in List 1

AC 5 SHIFT Ans (→) OPTN F1 (LIST) F3 (Dim)
 F1 (List) 1 EXE

SUB	List 1	List 2	List 3	List 4
1	0			
2	0			
3	0			
4	0			

You can view the newly created list by entering the **STAT** mode.

• **To replace all data items with the same value** [OPTN]-[LIST]-[Fill]

OPTN F1 (LIST) F4 (Fill) <value> ▸ F1 (List) <list number 1 - 26> SHIFT $\frac{\square}{\square}$ () EXE

Example To replace all data items in List 1 with the number 3

AC OPTN F1 (LIST) F4 (Fill)
 3 ▸ F1 (List) 1 SHIFT $\frac{\square}{\square}$ () EXE

Fill(3, List 1)	Done
-----------------	------

The following shows the new contents of List 1.

SUB	List 1	List 2	List 3	List 4
1	3			
2	3			
3	3			
4	3			

• **To generate a sequence of numbers**

[OPTN]-[LIST]-[Seq]

[OPTN] [F1] (LIST) [F5] (Seq) <expression> [] <variable name> [] <start value> [] <end value> [] <increment> [SHIFT] [] () [EXE]

- The result of this operation is stored in ListAns Memory.

Example To input the number sequence $1^2, 6^2, 11^2$, into a list, using the function $f(x) = X^2$. Use a starting value of 1, an ending value of 11, and an increment of 5.

[AC] [OPTN] [F1] (LIST) [F5] (Seq)
 [ALPHA] [F5] (U-Z) [F4] (X) x^2 [] [F4] (X)
 [] [1] [] [] [] [] [] [5] [SHIFT] [] () [EXE]

Ans	
1	1
2	36
3	121

Specifying an ending value of 12, 13, 14, or 15 produces the same result as shown above since they are less than the value produced by the next increment (16).

• **To find the minimum value in a list**

[OPTN]-[LIST]-[Min]

[OPTN] [F1] (LIST) [F6] (▷) [F1] (Min) [F6] (▷) [F6] (▷) [F1] (List) <list number 1 - 26> [SHIFT] [] () [EXE]

Example To find the minimum value in List 1 (36, 16, 58, 46, 56)

[AC] [OPTN] [F1] (LIST) [F6] (▷) [F1] (Min)
 [F6] (▷) [F6] (▷) [F1] (List) [1] [SHIFT] [] () [EXE]

Min(List 1)	
	16

• **To find which of two lists contains the greatest value**

[OPTN]-[LIST]-[Max]

[OPTN] [F1] (LIST) [F6] (▷) [F2] (Max) [F6] (▷) [F6] (▷) [F1] (List) <list number 1 - 26> [] [F1] (List) <list number 1 - 26> [SHIFT] [] () [EXE]

- The two lists must contain the same number of data items. If they don't, an error occurs.
- The result of this operation is stored in ListAns Memory.

Example To find whether List 1 (75, 16, 98, 46, 56) or List 2 (35, 59, 58, 72, 67) contains the greatest value

[OPTN] [F1] (LIST) [F6] (▷) [F2] (Max)
 [F6] (▷) [F6] (▷) [F1] (List) [1] []
 [F1] (List) [2] [SHIFT] [] () [EXE]

Ans	
1	75
2	59
3	98
4	72
5	67

• **To calculate the mean of data items**

[OPTN]-[LIST]-[Mean]

[OPTN] [F1] (LIST) [F6] (▷) [F3] (Mean) [F6] (▷) [F6] (▷) [F1] (List) <list number 1 - 26> [SHIFT] [] () [EXE]

Example To calculate the mean of data items in List 1 (36, 16, 58, 46, 56)

[AC] [OPTN] [F1] (LIST) [F6] (▷) [F3] (Mean)
 [F6] (▷) [F6] (▷) [F1] (List) [1] [SHIFT] [] () [EXE]

Mean(List 1)	
	42.4

• **To calculate the median of data items of specified frequency**

[OPTN]-[LIST]-[Med]

This procedure uses two lists: one that contains values and one that indicates the frequency (number of occurrences) of each value. The frequency of the data in Cell 1 of the first list is indicated by the value in Cell 1 of the second list, etc.

- The two lists must contain the same number of data items. If they don't, an error occurs.

[OPTN] [F1] (LIST) [F6] (▷) [F4] (Med) [F6] (▷) [F6] (▷) [F1] (List) <list number 1 - 26 (data)> [◁] [F1] (List) <list number 1 - 26 (frequency)> [SHIFT] [÷] () [EXE]

Example To calculate the median of values in List 1 (36, 16, 58, 46, 56), whose frequency is indicated by List 2 (75, 89, 98, 72, 67)

[AC] [OPTN] [F1] (LIST) [F6] (▷) [F4] (Med)
 [F6] (▷) [F6] (▷) [F1] (List) [1] [◁]
 [F1] (List) [2] [SHIFT] [÷] () [EXE]

Median(List 1, List 2)
46

• **To combine lists**

[OPTN]-[LIST]-[Aug]

- You can combine two different lists into a single list. The result of a list combination operation is stored in ListAns memory.

[OPTN] [F1] (LIST) [F6] (▷) [F5] (Aug) [F6] (▷) [F6] (▷) [F1] (List) <list number 1 - 26> [◁] [F1] (List) <list number 1 - 26> [SHIFT] [÷] () [EXE]

Example To combine the List 1 (-3, -2) and List 2 (1, 9, 10)

[AC] [OPTN] [F1] (LIST) [F6] (▷) [F5] (Aug)
 [F6] (▷) [F6] (▷) [F1] (List) [1] [◁]
 [F1] (List) [2] [SHIFT] [÷] () [EXE]

Ans	
1	-3
2	-2
3	1
4	9
5	10

• **To calculate the sum of data items in a list**

[OPTN]-[LIST]-[Sum]

[OPTN] [F1] (LIST) [F6] (▷) [F6] (▷) [F1] (Sum) [F6] (▷) [F1] (List) <list number 1 - 26> [EXE]

Example To calculate the sum of data items in List 1 (36, 16, 58, 46, 56)

[AC] [OPTN] [F1] (LIST) [F6] (▷) [F6] (▷) [F1] (Sum)
 [F6] (▷) [F1] (List) [1] [EXE]

Sum List 1	212
------------	-----

• **To calculate the product of values in a list**

[OPTN]-[LIST]-[Prod]

[OPTN] [F1] (LIST) [F6] (▷) [F6] (▷) [F2] (Prod) [F6] (▷) [F1] (List) <list number 1 - 26> [EXE]

Example To calculate the product of values in List 1 (2, 3, 6, 5, 4)

[AC] [OPTN] [F1] (LIST) [F6] (▷) [F6] (▷) [F2] (Prod)
 [F6] (▷) [F1] (List) [1] [EXE]

Prod List 1	720
-------------	-----

• **To calculate the cumulative frequency of each data item** [OPTN]-[LIST]-[CumI]

[OPTN] [F1] (LIST) [F6] (▷) [F6] (▷) [F3] (CumI) [F6] (▷) [F1] (List) <list number 1 - 26> [EXE]

- The result of this operation is stored in ListAns Memory.

Example To calculate the cumulative frequency of each data item in List 1 (2, 3, 6, 5, 4)

[AC] [OPTN] [F1] (LIST) [F6] (▷) [F6] (▷) [F3] (CumI)
[F6] (▷) [F1] (List) [1] [EXE]

	Ans
$2+3=$	5
$2+3+6=$	11
$2+3+6+5=$	16
$2+3+6+5+4=$	20

• **To calculate the percentage represented by each data item** [OPTN]-[LIST]-[%]

[OPTN] [F1] (LIST) [F6] (▷) [F6] (▷) [F4] (%) [F6] (▷) [F1] (List) <list number 1 - 26> [EXE]

- The above operation calculates what percentage of the list total is represented by each data item.
- The result of this operation is stored in ListAns Memory.

Example To calculate the percentage represented by each data item in List 1 (2, 3, 6, 5, 4)

[AC] [OPTN] [F1] (LIST) [F6] (▷) [F6] (▷) [F4] (%)
[F6] (▷) [F1] (List) [1] [EXE]

	Ans
$2/(2+3+6+5+4) \times 100 =$	10
$3/(2+3+6+5+4) \times 100 =$	15
$6/(2+3+6+5+4) \times 100 =$	30
$5/(2+3+6+5+4) \times 100 =$	25
$4/(2+3+6+5+4) \times 100 =$	20

• **To calculate the differences between neighboring data inside a list** [OPTN]-[LIST]-[Δ]

[OPTN] [F1] (LIST) [F6] (▷) [F6] (▷) [F5] (Δ) <list number 1 - 26> [EXE]

- The result of this operation is stored in ListAns Memory.

Example To calculate the difference between the data items in List 1 (1, 3, 8, 5, 4)

[AC] [OPTN] [F1] (LIST) [F6] (▷) [F6] (▷) [F5] (Δ)
[1] [EXE]

	Ans
$3 - 1 =$	2
$8 - 3 =$	5
$5 - 8 =$	-3
$4 - 5 =$	-1

- You can specify the storage location in list memory for a calculation result produced by a list calculation whose result is stored in ListAns memory. For example, specifying “ Δ List 1 \rightarrow List 2” will store the result of Δ List 1 in List 2.
- The number of cells in the new Δ List is one less than the number of cells in the original list.
- An error occurs if you execute Δ List for a list that has no data or only one data item.

3. Arithmetic Calculations Using Lists

You can perform arithmetic calculations using two lists or one list and a numeric value.

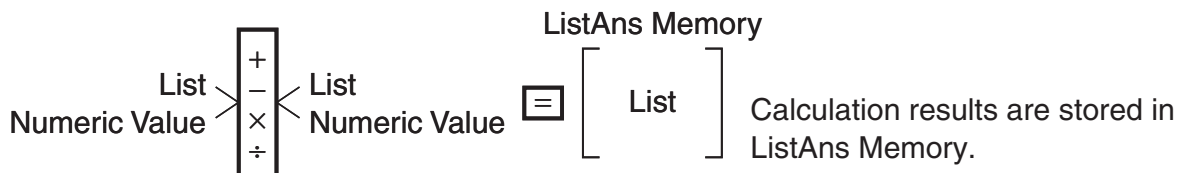

■ Error Messages

- A calculation involving two lists performs the operation between corresponding cells. Because of this, an error occurs if the two lists do not have the same number of values (which means they have different “dimensions”).
- An error occurs whenever an operation involving any two cells generates a mathematical error.

■ Inputting a List into a Calculation

There are three methods you can use to input a list into a calculation.

- Specification of the list number of a list created with List Editor.
- Specification of the sub name of a list created with List Editor.
- Direct input of a list of values.

• To specify the list number of a list created with List Editor

1. In the **RUN • MAT** mode, perform the following key operation.

AC **OPTN** **F1** (LIST) **F1** (List)

- Enter the “List” command.
2. Enter the list number (integer from 1 to 26) you want to specify.

List 11

• To specify the sub name of a list created with List Editor

1. In the **RUN • MAT** mode, perform the following key operation.

AC **OPTN** **F1** (LIST) **F1** (List)

- Enter the “List” command.
2. Enter the sub name of the list you want to specify, enclosed in double quotes (" ").

Example: "QTY"

List "QTY"

• To directly input a list of values

You can also directly input a list of values using {, }, and \square .

Example **To input the list: 56, 82, 64**

\square SHIFT \square 0 (CATALOG) \square ALPHA \square F6 (SYBL) \square F4 (..) { 56, 82, 64 } I
 \square ~ \square ({) \square EXE \square 5 \square 6 \square , \square 8 \square 2 \square , \square 6 \square 4
 \square SHIFT \square 0 (CATALOG) \square () \square EXE

• To assign the contents of one list to another list

Use \square SHIFT \square Ans (\rightarrow) to assign the contents of one list to another list.

Example **To assign the contents of List 3 (41, 65, 22) to List 1**

\square OPTN \square F1 (LIST) \square F1 (List) \square 3 \square SHIFT \square Ans (\rightarrow) \square F1 (List) \square 1 \square EXE

• To recall the value in a specific list cell

You can recall the value in a specific list cell and use it in a calculation. Specify the cell number by enclosing it inside square brackets.

Example **To calculate the sine of the value stored in Cell 3 of List 2**

\square sin \square OPTN \square F1 (LIST) \square F1 (List) \square 2 \square SHIFT \square 0 (CATALOG) \square ALPHA \square F6 (SYBL) \square F4 (..) \square ~ \square ([] \square EXE \square 3 \square SHIFT \square 0 (CATALOG) \square () \square EXE \square EXE

• To input a value into a specific list cell

You can input a value into a specific list cell inside a list. When you do, the value that was previously stored in the cell is replaced with the new value you input.

Example **To input the value 25 into Cell 2 of List 3**

\square 2 \square 5 \square SHIFT \square Ans (\rightarrow) \square OPTN \square F1 (LIST) \square F1 (List) \square 3 \square SHIFT \square 0 (CATALOG) \square ALPHA \square F6 (SYBL) \square F4 (..) \square ~ \square ([] \square EXE \square 2 \square SHIFT \square 0 (CATALOG) \square () \square EXE \square EXE

■ Recalling List Contents

Example **To recall the contents of List 1**

\square OPTN \square F1 (LIST) \square F1 (List) \square 1 \square EXE

- The above operation displays the contents of the list you specify and also stores them in ListAns Memory. You can then use the ListAns Memory contents in a calculation.

- **To use list contents in ListAns Memory in a calculation**

Example To multiply the list contents in ListAns Memory by 36

[OPTN] **[F1]** (LIST) **[F1]** (List) **[SHIFT]** **[Ans]** **[X]** **[3]** **[6]** **[EXE]**

- The operation **[OPTN]** **[F1]** (LIST) **[F1]** (List) **[SHIFT]** **[Ans]** recalls ListAns Memory contents.
- This operation replaces current ListAns Memory contents with the result of the above calculation.

■ Performing Scientific Function Calculations Using a List

Lists can be used just as numeric values are in scientific function calculations. When the calculation produces a list as a result, the list is stored in ListAns Memory.

Example To use List 3 $\begin{bmatrix} 41 \\ 65 \\ 22 \end{bmatrix}$ to perform $\sin(\text{List } 3)$

Use radians as the angle unit.

[SHIFT] **[7]** (sin) **[OPTN]** **[F1]** (LIST) **[F1]** (List) **[3]** **[EXE]**

4. Switching Between List Files

You can store up to 26 lists (List 1 to List 26) in each file (File 1 to File 6). A simple operation lets you switch between list files.

- **To switch between list files**

1. From the Main Menu, enter the **STAT** mode.

Press **[SHIFT]** **[MENU]** (SET UP) to display the **STAT** mode Setup screen.

```

Stat Wind      :Auto
Resid List    :None
List File     :file1
Sub Name      :On
Frac Result   :d/c
Graph Func    :On
Background    :None
FILE
  
```

2. Use **[↓]** to highlight "List File".

3. Press **[F1]** (FILE) and then input the number of the list file you want to use.

Example To select File 3

[F1] (FILE) **[3]**

[EXE]

```

Resid List :None
Select File No.
File[1~6]: 3
Graph Func :None
List File :Files
  
```

All subsequent list operations are applied to the lists contained in the file you select (List File 3 in the above example).

5. Using CSV Files

You can import the contents of a CSV file stored with this calculator or transferred from a computer into the List Editor. You also can save the contents of all the list data in the List Editor as a CSV file. These operations are performed using the CSV function menu, which appears when you press **F6**(▷)**F6**(▷)**F1**(CSV) while the List Editor is on the display.

LOAD SVAS SET

■ Import CSV File Requirements

A CSV file that has been output from the List Editor, Matrix Editor (page 3-35), or Spreadsheet (page 7-1), or a CSV file transferred from a computer to storage memory can be used for import. The following types of CSV files are supported for import.

- A CSV file that uses the comma (,) or semi-colon (;) as its delimiter, and the period (.) or comma (,) as its decimal point. A CSV file that uses the tab as its delimiter is not supported.
- CR, LF and CRLF are supported for the line break code.
- When importing a CSV file to the calculator, if the data in Line 1 of each column of the file (or Line 1 of Column 1 of the file) contains double quotation marks (") or a single quotation mark ('), Line 1 of all of the columns of the CSV file will be ignored, and data will be input starting from Line 2.

For information about transferring files from a computer to the calculator, see “Chapter 10 Data Communication”.

■ Transferring Data between Lists and CSV Files

● To import the contents of a CSV file to the List Editor

1. Prepare the CSV file you want to import.
 - See “Import CSV File Requirements” described above.
2. While the List Editor is on the display, press **F6**(▷)**F6**(▷)**F1**(CSV) to display the CSV function menu.
3. What you should do next depends on the type of CSV file import operation you want to perform.

To start import from a specific row:	To overwrite the entire contents of the List Editor:
Use the cursor keys to move the highlighting to the row from which you want to start importing data and then press F1 (LOAD) F1 (LIST).	Press F1 (LOAD) F2 (FILE).

- This will display a dialog box for specifying whether a CSV file should be imported from storage memory or the SD card.

4. Select **[1]** (Storage Mem) to select storage memory, or **[2]** (SD Card) to select the SD card.
 - Pressing **[EXE]** in the next step will overwrite the specified list editor data with the CSV file data.
5. On the select file dialog box that appears, use **[▲]** and **[▼]** to move the highlighting to the file you want to import and then press **[EXE]**.
 - This imports the contents of the CSV file you specified to the List Editor.
 - If you pressed **[F1]**(LOAD)**[F1]**(LIST) in step 3, import starts from the row where the highlighted cell is located, overwriting List Editor rows only with the same number of rows contained in the CSV file.

Examples

List Editor Original Content

List 1	List 2	List 3	List 4	List 5
1	1	1	1	1
2	2	2	2	2
3	3	3	3	3
4	4	4	4	4

Highlighting

Import CSV File Data

20	20	20
30	30	30
40	40	40

List Editor Content following Import

List 1	List 2	List 3	List 4	List 5
1	20	20	20	1
2	30	30	30	2
3	40	40	40	3
4				4

Important!

Attempting to import the following types of CSV files will result in an error.

- A CSV file that includes data that cannot be converted. In this case, an error message will appear showing the location in the CSV file (Example: row 2, column 3) where the data that cannot be converted is located.
- A CSV file with more than 26 columns or 999 rows. In this case, an “Invalid Data Size” error will occur.

● To save the contents of all the list data in the List Editor as a single CSV file

1. While the List Editor is on the display, press **F6**(▷) **F6**(▷) **F1**(CSV) to display the CSV function menu.
2. Press **F2**(SV•AS).
 - This will display a dialog box for specifying whether the CSV file should be saved to storage memory or the SD card.
3. Select **1**(Storage Mem) to select storage memory, or **2**(SD Card) to select the SD card.
 - This displays a folder selection screen.
4. Select the folder where you want to save the CSV file.
 - To store the CSV file in the root directory, highlight “ROOT”.
 - To store the CSV file in a folder, use **▲** and **▼** to move the highlighting to the desired folder and then press **F1**(OPEN).
5. Press **F1**(SV•AS).
6. Input up to eight characters for the file name and then press **EXE**.

Important!

- The sub name line of the List Editor is not saved in the CSV file.
- When saving list data to a CSV file, some data is converted as described below.
 - Complex number data: Only the real number part is extracted.
 - Fraction data: Converted to calculation line format (Example: $2\downarrow 3\downarrow 4 \rightarrow =2+3/4$)

■ Specifying the CSV File Delimiter Symbol and Decimal Point

When importing a CSV file that has been transferred from a computer to the calculator, specify the delimiter symbol and decimal point in accordance with the settings you specified on the application when outputting the CSV file. The comma (,) or semi-colon (;) can be specified for the delimiter, while the period (.) or comma (,) can be specified as the decimal point.

● To specify the CSV file delimiter symbol and decimal point

1. While the List Editor is on the display, press **F6**(▷) **F6**(▷) **F1**(CSV) to display the CSV function menu.
2. Press **F3**(SET).
 - This displays the CSV format setting screen.
3. Use the **▲** and **▼** keys to move the highlighting to “CSV Separator” and then press **F1**(,) or **F2**(;).
4. Use the **▲** and **▼** keys to move the highlighting to “CSV Decimal Symbol” and then press **F1**(.) or **F2**(,).
 - If you specified **F1**(,) in step 3, you will not be able to specify **F2**(,) here.
5. After the setting is the way you want, press **EXIT**.

Chapter 5 Statistical Graphs and Calculations





Important!

This chapter contains a number of graph screen shots. In each case, new data values were input in order to highlight the particular characteristics of the graph being drawn. Note that when you try to draw a similar graph, the unit uses data values that you have input using the List function. Because of this, the graphs that appear on the screen when you perform a graphing operation will probably differ somewhat from those shown in this manual.

1. Before Performing Statistical Calculations

Entering the **STAT** mode from the Main Menu displays the List Editor screen.

You can use the List Editor screen to input statistical data and perform statistical calculations.

Use , ,  and  to move the highlighting around the lists.

Once you input data, you can use it to produce a graph and check for tendencies. You can also use a variety of different regression calculations to analyze the data.

- For information about using the statistical data lists, see “Chapter 4 List Function”.

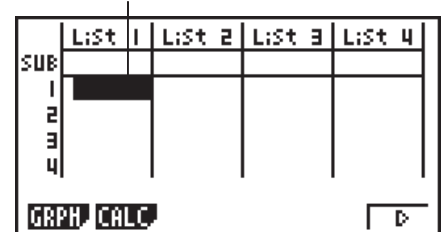

5

■ Changing Graph Parameters

Use the following procedures to specify the graph draw/non-draw status, the graph type, and other general settings for each of the graphs in the graph menu (GPH1, GPH2, GPH3).

While the statistical data list is on the display, press **[F1]** (GRPH) to display the graph menu, which contains the following items.

- {GPH1}/{GPH2}/{GPH3} ... graph {1}/{2}/{3} drawing*¹
- {SEL} ... {simultaneous graph (GPH1, GPH2, GPH3) selection}
You can specify the multiple graphs.
- {SET} ... {graph settings (graph type, list assignments)}

*¹ The initial default graph type setting for all the graphs (Graph 1 through Graph 3) is scatter diagram, but you can change to one of a number of other graph types.

1. General graph settings

[GRPH]-[SET]

This section describes how to use the general graph settings screen to make the following settings for each graph (GPH1, GPH2, GPH3).

• Graph Type

The initial default graph type setting for all the graphs is scatter graph. You can select one of a variety of other statistical graph types for each graph.

- **List**

The initial default statistical data is List 1 for single-variable data, and List 1 and List 2 for paired-variable data. You can specify which statistical data list you want to use for x -data and y -data.

- **Frequency**

Normally, each data item or data pair in the statistical data list is represented on a graph as a point. When you are working with a large number of data items however, this can cause problems because of the number of plot points on the graph. When this happens, you can specify a frequency list that contains values indicating the number of instances (the frequency) of the data items in the corresponding cells of the lists you are using for x -data and y -data. Once you do this, only one point is plotted for the multiple data items, which makes the graph easier to read.

- **Mark Type**

This setting lets you specify the shape of the plot points on the graph.

- **To display the general graph settings screen**

[GRPH]-[SET]

Pressing **[F1]**(GRPH)**[F6]**(SET) displays the general graph settings screen.

STATGRAPH1	
Graph Type	: Scatter
XList	: List1
YList	: List2
Frequency	: 1
Mark Type	: □
[GPH1] [GPH2] [GPH3]	

- **StatGraph (statistical graph specification)**

- {GPH1}/{GPH2}/{GPH3} ... graph {1}/{2}/{3}

- **Graph Type (graph type specification)**

- {Scat}/{xy}/{NPP}/{Pie} ... {scatter diagram}/{xy line graph}/{normal probability plot}/{pie graph}
- {Hist}/{Box}/{Bar}/{N-Dis}/{Brkn} ... {histogram}/{med-box graph}/{bar graph}/{normal distribution curve}/{broken line graph}
- {X}/{Med}/{X^2}/{X^3}/{X^4} ... {linear regression graph}/{Med-Med graph}/{quadratic regression graph}/{cubic regression graph}/{quartic regression graph}
- {Log}/{Exp}/{Pwr}/{Sin}/{Lgst} ... {logarithmic regression graph}/{exponential regression graph}/{power regression graph}/{sinusoidal regression graph}/{logistic regression graph}

- **XList (x-axis data list)/YList (y-axis data list)**

- {List} ... {List 1 to 26}

- **Frequency (number of times a value occurs)**

- {1} ... {1-to-1 plot}
- {List} ... {List 1 to 26}

- **Mark Type (plot mark type)**

- {□}/{×}/{•} ... scatter diagram plot points

When “Pie” (pie graph) is selected as the Graph Type:

- **Data (Specifies the list to be used as graph data.)**

- {LIST} ... {List 1 to List 26}

- **Display (pie graph value display setting)**

- {%/}{Data} ... For each data element {display as percentage}/{display as value}

- **% Sto Mem (Specifies storage of percentage values to a list.)**
 - **{None}/{List}** ... For percentage values: {Do not store to list}/{Specify List 1 to 26 and store}

When “Box” (med-box graph) is selected as the Graph Type:

- **Outliers (outliers specification)**
 - **{On}/{Off}** ... {display}/{do not display} Med-Box outliers

When “Bar” (bar graph) is selected as the Graph Type:

- **Data1 (first stick data list)**
 - **{LIST}** ... {List 1 to 26}
- **Data2 (second stick data list)/Data3 (third stick data list)**
 - **{None}/{LIST}** ... {none}/{List 1 to 26}
- **Stick Style (stick style specification)**
 - **{Leng}/{HZtl}** ... {length}/{horizontal}

2. Graph draw/non-draw status

[GRPH]-[SEL]

The following procedure can be used to specify the draw (On)/non-draw (Off) status of each of the graphs in the graph menu.

• To specify the draw/non-draw status of a graph

1. Pressing **[F1]**(GRPH) **[F4]**(SEL) displays the graph On/Off screen.

```
StatGraph1 : DrawOn
StatGraph2 : DrawOff
StatGraph3 : DrawOff
```

- Note that the StatGraph1 setting is for Graph 1 (GPH1 of the graph menu), StatGraph2 is for Graph 2, and StatGraph3 is for Graph 3.
2. Use the cursor keys to move the highlighting to the graph whose status you want to change, and press the applicable function key to change the status.
 - **{On}/{Off}** ... {On (draw)}/{Off (non-draw)}
 - **{DRAW}** ... {draws all On graphs}
 3. To return to the graph menu, press **[EXIT]**.

■ Statistical Graph View Window (V-Window) Settings

View Window settings specify the range that needs to be specified when you draw a graph. View Window settings are configured automatically in the case of statistical graphs (when “Auto” is specified for the “Stat Wind” setting).

Note

- For statistical graphing, you can select either “Auto” or “Manual” for the “Stat Wind” (page 2-15) item on the setup screen to specify the View Window setting method. For information about switching between auto and manual, see “To change a mode setup” (page 2-14).
- For the View Window setting procedures you need to perform while “Manual” is selected as the “Stat Wind” setting, see “Configuring View Window Settings Manually” in this manual (page 5-16).
- Pie graphs are always displayed in accordance with a predetermined format, regardless of the current View Window settings.

2. Calculating and Graphing Single-Variable Statistical Data

Single-variable data is data with only a single variable. If you are calculating the average height of the members of a class for example, there is only one variable (height).

Single-variable statistics include distribution and sum. The following types of graphs are available for single-variable statistics.

You can also use the procedures under “Changing Graph Parameters” on page 5-1 to make the settings you want before drawing each graph.

■ Normal Probability Plot

This plot compares the data accumulated ratio with a normal distribution accumulated ratio. XList specifies the list where data is input, and Mark Type is used to select from among the marks {□ / × / •} you want to plot.

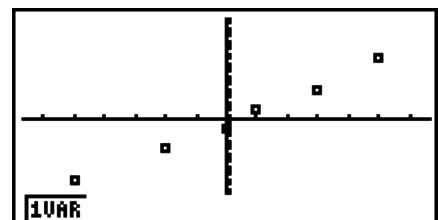

Press **AC**, **EXIT** or **SHIFT** **EXIT** (QUIT) to return to the statistical data list.

■ Pie Graph

You can draw a pie graph based on the data in a specific list. The maximum number of graph data items (list lines) is 20. The graph is labeled A, B, C, and so on, corresponding to lines 1, 2, 3, and so on of the list used for the graph data.

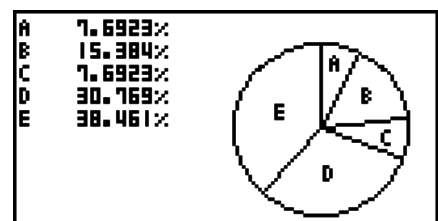

When “%” is selected for the “Display” setting on the general graph settings screen (page 5-2), a value showing the percentage is displayed for each of the alphabetic label letters.

■ Histogram

XList specifies the list where the data is input, while Freq specifies the list where the data frequency is input. 1 is specified for Freq when frequency is not specified.

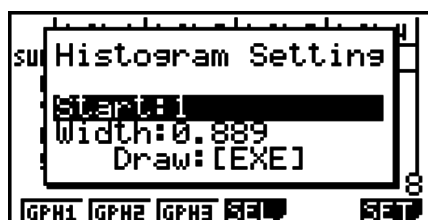

⇒
EXE (DRAW)

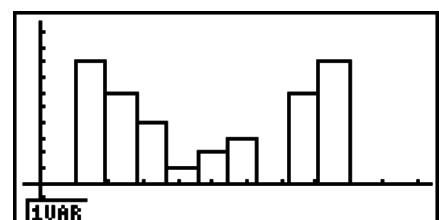

The display screen appears as shown above before the graph is drawn. At this point, you can change the Start and Width values.

■ Med-box Graph

This type of graph lets you see how a large number of data items are grouped within specific ranges. A box encloses all the data in an area from the first quartile (Q1) to the third quartile (Q3), with a line drawn at the median (Med). Lines (called whiskers) extend from either end of the box up to the minimum (minX) and maximum (maxX) of the data.

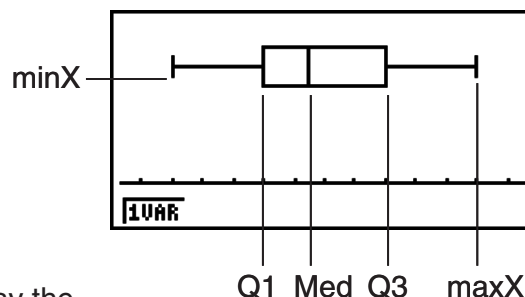

From the statistical data list, press **F1** (GRPH) to display the graph menu, press **F6** (SET), and then change the graph type of the graph you want to use (GPH1, GPH2, GPH3) to med-box graph.

To plot the data that falls outside the box, first specify “MedBox” as the Graph Type. Then, on the same screen you use to specify the graph type, turn the Outliers item “On”, and draw the graph.

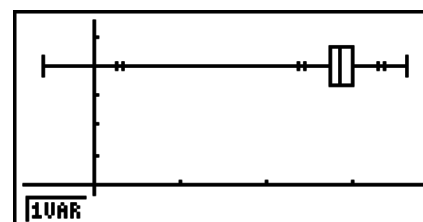

- Changing the “Q1Q3 Type” setting on the Setup screen can cause the Q1 and Q3 positions to change, even when a Med-box graph is drawn based on a single list.

■ Bar Graph

You can specify up to three lists for drawing a bar graph. The graph is labeled [1], [2], [3], and so on, corresponding to lines 1, 2, 3, and so on of the list used for the graph data.

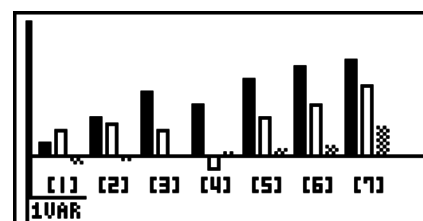

- Any of the following causes an error and cancels bar graph drawing.
 - A Condition ERROR occurs when drawing of multiple graphs is specified using the graph On/Off screen (page 5-3), and bar graph is specified for one of the graphs and a different graph type is specified for another graph.
 - A Dimension ERROR occurs when you draw a graph with two or three lists specified and the specified lists have a different number of list elements.
 - A Condition ERROR occurs when lists are assigned for Data1 and Data3, while “None” is specified for Data2.

Normal Distribution Curve

The normal distribution curve is graphed using the normal distribution function.

XList specifies the list where the data is input, while Freq specifies the list where the data frequency is input. 1 is specified for Freq when frequency is not specified.

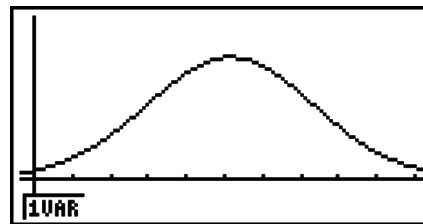

Broken Line Graph

Lines connect center points of a histogram bar.

XList specifies the list where the data is input, while Freq specifies the list where the data frequency is input. 1 is specified for Freq when frequency is not specified.



⇒
[EXE] (DRAW)

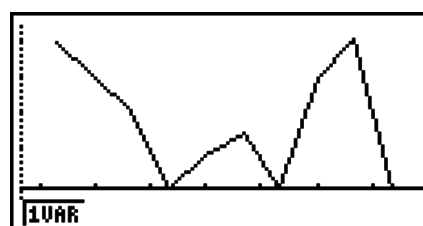

The display screen appears as shown above before the graph is drawn. At this point, you can change the Start and Width values.

Displaying the Calculation Results of a Drawn Single-Variable Graph

Single-variable statistics can be expressed as both graphs and parameter values. When these graphs are displayed, the single-variable calculation results appear as shown to the right when you press [F1] (1VAR).

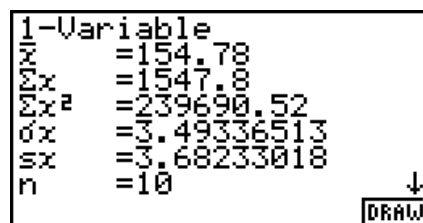

- Use to scroll the list so you can view the items that run off the bottom of the screen.

The following describes the meaning of each of the parameters.

\bar{x}	mean	Q1	first quartile
Σx	sum	Med	median
Σx^2	sum of squares	Q3	third quartile
σ_x	population standard deviation	maxX	maximum
s_x	sample standard deviation	Mod	mode
n	number of data items	Mod:n	number of data mode items
minX	minimum	Mod:F	data mode frequency

- Press **F6** (DRAW) to return to the original single-variable statistical graph.
- When Mod has multiple solutions, they are all displayed.
- You can use the Setup screen's "Q1Q3 Type" setting to select either "Std" (standard calculation) or "OnData" (French calculation) for the Q1 and Q3 calculation mode.

For details about calculation methods while "Std" or "OnData" is selected, see "Calculation Methods for the Std and OnData Settings" below.

■ Calculation Methods for the Std and OnData Settings

Q1 and Q3 can be calculated in accordance with the Setup screen's "Q1Q3 Type" setting as described below.

• Std

With this calculation method, processing depends on whether the number of elements n in the population is an even number or odd number.

When the number of elements n is an even number:

Using the center point of the total population as the reference, the population elements are divided into two groups: a lower half group and an upper half group. Q1 and Q3 then become the values described below.

Q1 = {median of the group of $\frac{n}{2}$ items from the bottom of the population}

Q3 = {median of the group of $\frac{n}{2}$ items from the top of the population}

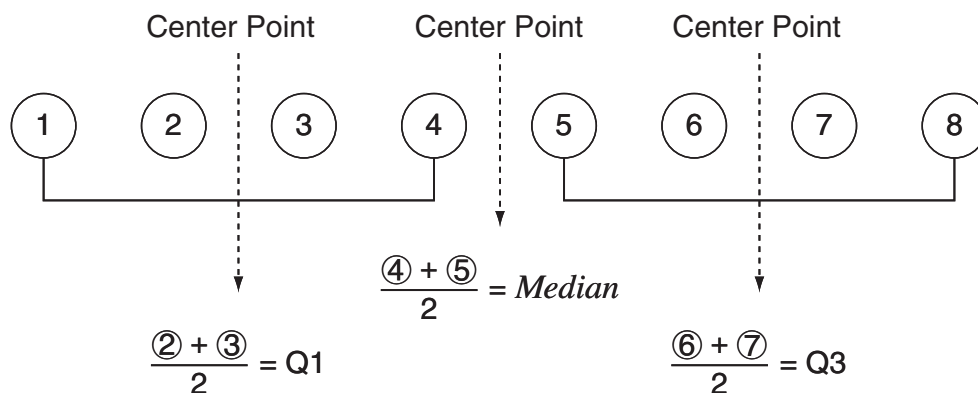

When the number of elements n is an odd number:

Using the median of the total population as the reference, the population elements are divided into two groups: a lower half group (values less than the median) and an upper half group (values greater than the median). The median value is excluded. Q1 and Q3 then become the values described below.

Q1 = {median of the group of $\frac{n-1}{2}$ items from the bottom of the population}

Q3 = {median of the group of $\frac{n-1}{2}$ items from the top of the population}

- When $n = 1$, Q1 = Q3 = population center point.

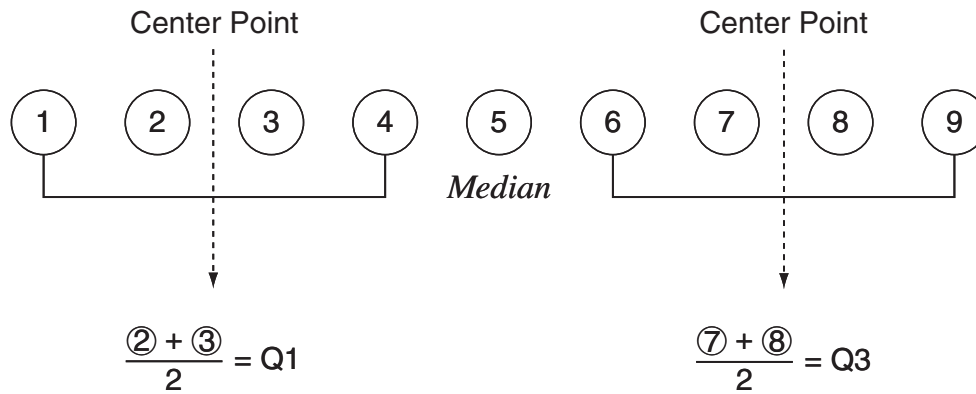

● **OnData**

The Q1 and Q3 values for this calculation method are described below.

Q1 = {value of element whose cumulative frequency ratio is greater than 1/4 and nearest to 1/4}

Q3 = {value of element whose cumulative frequency ratio is greater than 3/4 and nearest to 3/4}

The following shows an actual example of the above.

(Number of Elements: 10)

Data Value	Frequency	Cumulative Frequency	Cumulative Frequency Ratio
1	1	1	1/10 = 0.1
2	1	2	2/10 = 0.2
3	2	4	4/10 = 0.4
4	3	7	7/10 = 0.7
5	1	8	8/10 = 0.8
6	1	9	9/10 = 0.9
7	1	10	10/10 = 1.0

- 3 is the value of whose cumulative frequency ratio is greater than 1/4 and nearest to 1/4, so Q1 = 3.
- 5 is the value of whose cumulative frequency ratio is greater than 3/4 and nearest to 3/4, so Q3 = 5.

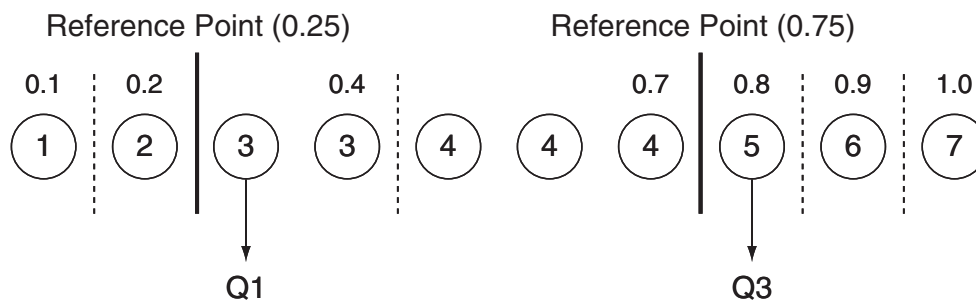

3. Calculating and Graphing Paired-Variable Statistical Data

■ Drawing a Scatter Diagram and *xy* Line Graph

The following procedure plots a scatter diagram and connects the dots to produce an *xy* line graph.

1. From the Main Menu, enter the **STAT** mode.
2. Input the data into a list.
3. Specify Scat (scatter diagram) or *xy* (*xy* line graph) as the graph type, and then execute the graph operation.

Press **AC**, **EXIT** or **SHIFT** **EXIT** (QUIT) to return to the statistical data list.

Example **Input the two sets of data shown below. Next, plot the data on a scatter diagram and connect the dots to produce an *xy* line graph.**

0.5, 1.2, 2.4, 4.0, 5.2 (xList)

-2.1, 0.3, 1.5, 2.0, 2.4 (yList)

① **MENU** STAT

② **0** **.** **5** **EXE** **1** **.** **2** **EXE** **2** **.** **4** **EXE** **4** **EXE** **5** **.** **2** **EXE** **▶**
- **2** **.** **1** **EXE** **0** **.** **3** **EXE** **1** **.** **5** **EXE** **2** **EXE** **2** **.** **4** **EXE**

③ (Scatter diagram) **F1**(GRPH) **F6**(SET) **▼** **F1**(Scat) **EXIT** **F1**(GPH1)

③ (*xy* line graph) **F1**(GRPH) **F6**(SET) **▼** **F2**(*xy*) **EXIT** **F1**(GPH1)



(Scatter diagram)

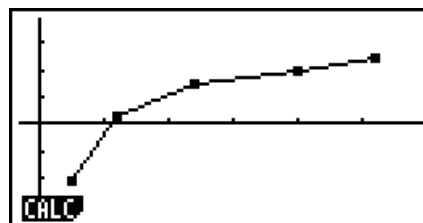

(*xy* line graph)

■ Drawing a Regression Graph

Use the following procedure to input paired-variable statistical data, perform a regression calculation using the data, and then graph the results.

1. From the Main Menu, enter the **STAT** mode.
2. Input the data into a list, and plot the scatter diagram.
3. Select the regression type, execute the calculation, and display the regression parameters.
4. Draw the regression graph.

Example Input the two sets of data shown below and plot the data on a scatter diagram. Next, perform logarithmic regression on the data to display the regression parameters, and then draw the corresponding regression graph.

0.5, 1.2, 2.4, 4.0, 5.2 (xList)
 -2.1, 0.3, 1.5, 2.0, 2.4 (yList)

- ① **MENU** STAT
- ② **0** **.** **5** **EXE** **1** **.** **2** **EXE** **2** **.** **4** **EXE** **4** **EXE** **5** **.** **2** **EXE** **▶**
- **2** **.** **1** **EXE** **0** **.** **3** **EXE** **1** **.** **5** **EXE** **2** **EXE** **2** **.** **4** **EXE**
F1 (GRPH) **F6** (SET) **▼** **F1** (Scat) **EXIT** **F1** (GPH1)
- ③ **F1** (CALC) **F6** (**▷**) **F2** (Log)
- ④ **F6** (DRAW)

```

LogReg
a =-0.4546843
b =1.87475856
r =0.98216271
r²=0.9646436
MSe=0.15495531
y=a+b·lnx
DRAW
  
```

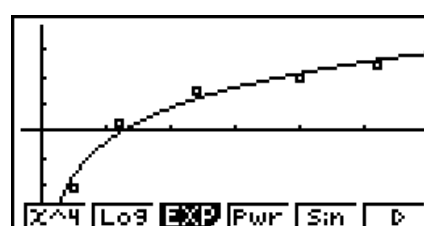

■ Selecting the Regression Type

After you graph paired-variable statistical data, you can use the function menu at the bottom of the display to select from a variety of different types of regression.

- $\{ax+b\}/\{a+bx\}/\{\text{Med}\}/\{X^2\}/\{X^3\}/\{X^4\}/\{\text{Log}\}/\{ae^{bx}\}/\{ab^x\}/\{\text{Pwr}\}/\{\text{Sin}\}/\{\text{Lgst}\}$...
 {linear regression ($ax+b$ form)}/{linear regression ($a+bx$ form)}/{Med-Med}/{quadratic regression}/{cubic regression}/{quartic regression}/{logarithmic regression}/{exponential regression (ae^{bx} form)}/{exponential regression (ab^x form)}/{power regression}/
 {sinusoidal regression}/{logistic regression} calculation and graphing
- **{2VAR}**... {paired-variable statistical results}

■ Displaying Regression Calculation Results

Whenever you perform a regression calculation, the regression formula parameter (such as a and b in the linear regression $y = ax + b$) calculation results appear on the display. You can use these to obtain statistical calculation results.

Regression parameters are calculated as soon as you press a function key to select a regression type, while a graph is on the display.

The following parameters are used by linear regression, logarithmic regression, exponential regression, and power regression.

- r correlation coefficient
- r^2 coefficient of determination
- MSe mean square error

■ Graphing Statistical Calculation Results

While the parameter calculation result is on the display, you can graph the displayed regression formula by pressing **F6** (DRAW).

■ Linear Regression Graph

Linear regression uses the method of least squares to plot a straight line that passes close to as many data points as possible, and returns values for the slope and y -intercept (y -coordinate when $x = 0$) of the line.

The graphic representation of this relationship is a linear regression graph.

F1 (CALC) **F2** (X)
F1 ($ax+b$) or **F2** ($a+bx$)
F6 (DRAW)

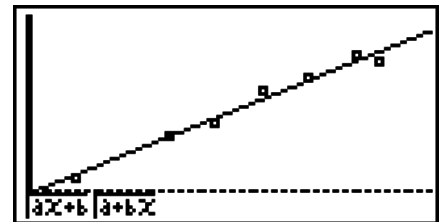

The following is the linear regression model formula.

$$y = ax + b$$

a regression coefficient (slope)

b regression constant term (y -intercept)

$$y = a + bx$$

a regression constant term (y -intercept)

b regression coefficient (slope)

■ Med-Med Graph

When it is suspected that there are a number of extreme values, a Med-Med graph can be used in place of the least squares method. This is similar to linear regression, but it minimizes the effects of extreme values.

F1 (CALC) **F3** (Med)
F6 (DRAW)

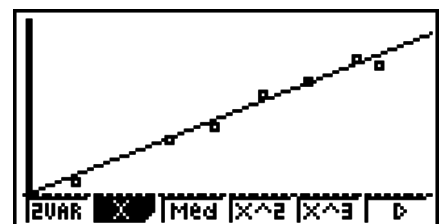

The following is the Med-Med graph model formula.

$$y = ax + b$$

a Med-Med graph slope

b Med-Med graph y -intercept

■ Quadratic/Cubic/Quartic Regression Graph

A quadratic/cubic/quartic regression graph represents connection of the data points of a scatter diagram. It uses the method of least squares to draw a curve that passes close to as many data points as possible. The formula that represents this is quadratic/cubic/quartic regression.

Ex. Quadratic regression

F1 (CALC) **F4** (X^2)
F6 (DRAW)

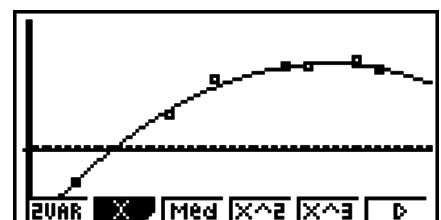

Quadratic regression

Model formula..... $y = ax^2 + bx + c$
 a..... regression second coefficient
 b..... regression first coefficient
 c..... regression constant term
 (y-intercept)

Cubic regression

Model formula..... $y = ax^3 + bx^2 + cx + d$
 a..... regression third coefficient
 b..... regression second coefficient
 c..... regression first coefficient
 d..... regression constant term
 (y-intercept)

Quartic regression

Model formula..... $y = ax^4 + bx^3 + cx^2 + dx + e$
 a..... regression fourth coefficient
 b..... regression third coefficient
 c..... regression second coefficient
 d..... regression first coefficient
 e..... regression constant term (y-intercept)

■ Logarithmic Regression Graph

Logarithmic regression expresses y as a logarithmic function of x . The standard logarithmic regression formula is $y = a + b \times \ln x$, so if we say that $X = \ln x$, the formula corresponds to linear regression formula $y = a + bX$.

F1 (CALC) **F6** (\triangleright) **F2** (Log)
F6 (DRAW)

The following is the logarithmic regression model formula.

$y = a + b \cdot \ln x$
 a..... regression constant term
 b..... regression coefficient

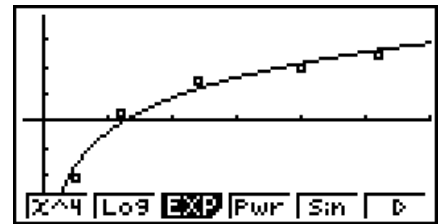

■ Exponential Regression Graph

Exponential regression expresses y as a proportion of the exponential function of x . The standard exponential regression formula is $y = a \times e^{bx}$, so if we take the logarithms of both sides we get $\ln y = \ln a + bx$. Next, if we say $Y = \ln y$, and $A = \ln a$, the formula corresponds to linear regression formula $Y = A + bx$.

F1 (CALC) **F6** (\triangleright) **F3** (EXP)
F1 (ae^{bx}) or **F2** (ab^x)
F6 (DRAW)

The following is the exponential regression model formula.

$y = a \cdot e^{bx}$
 a..... regression coefficient
 b..... regression constant term
 $y = a \cdot b^x$
 a..... regression constant term
 b..... regression coefficient

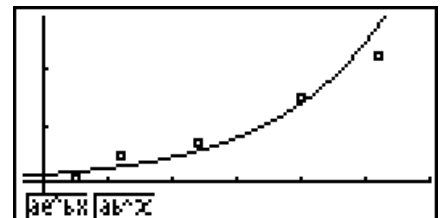

■ Power Regression Graph

Power regression expresses y as a proportion of the power of x . The standard power regression formula is $y = a \times x^b$, so if we take the logarithm of both sides we get $\ln y = \ln a + b \times \ln x$. Next, if we say $X = \ln x$, $Y = \ln y$, and $A = \ln a$, the formula corresponds to linear regression formula $Y = A + bX$.

F1 (CALC) **F6** (▷) **F4** (Pwr)
F6 (DRAW)

The following is the power regression model formula.

$$y = a \cdot x^b$$

a regression coefficient

b regression power

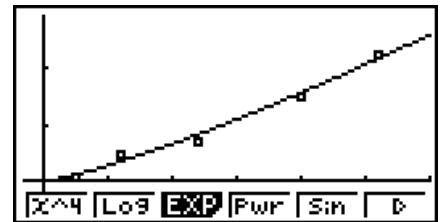

■ Sinusoidal Regression Graph

Sinusoidal regression is best applied for cyclical data.

The following is the sinusoidal regression model formula.

$$y = a \cdot \sin(bx + c) + d$$

F1 (CALC) **F6** (▷) **F5** (Sin)
F6 (DRAW)

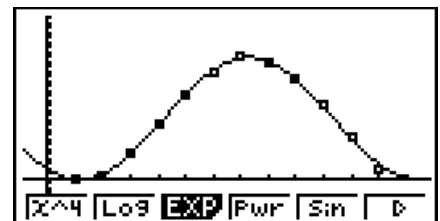

Drawing a sine regression graph causes the angle unit setting of the calculator to automatically change to Rad (radians). The angle unit does not change when you perform a sine regression calculation without drawing a graph.

- Certain types of data may take a long time to calculate. This does not indicate malfunction.

■ Logistic Regression Graph

Logistic regression is best applied for time-based phenomena in which there is a continual increase until a saturation point is reached.

The following is the logistic regression model formula.

$$y = \frac{c}{1 + ae^{-bx}}$$

F1 (CALC) **F6** (▷) **F6** (▷) **F1** (Lgst)
F6 (DRAW)

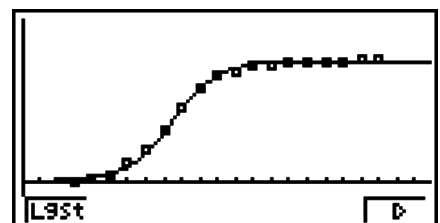

- Certain types of data may take a long time to calculate. This does not indicate malfunction.

■ Residual Calculation

Actual plot points (y -coordinates) and regression model distance can be calculated during regression calculations.

While the statistical data list is on the display, recall the Setup screen to specify a LIST (“List 1” through “List 26”) for “Resid List”. Calculated residual data is stored in the specified list.

The vertical distance from the plots to the regression model will be stored in the list.

Plots that are higher than the regression model are positive, while those that are lower are negative.

Residual calculation can be performed and saved for all regression models.

Any data already existing in the selected list is cleared. The residual of each plot is stored in the same precedence as the data used as the model.

■ Displaying the Calculation Results of a Drawn Paired-Variable Graph

Paired-variable statistics can be expressed as both graphs and parameter values. When these graphs are displayed, the paired-variable calculation results appear as shown below when you press **F1**(CALC)**F1**(2VAR).

```

2-Variable
x̄      =3.88730158
Σx     =24.49
Σx²    =105.993
σx     =1.30888199
sx    =1.42702911
n      =6.3
DRAW

```

- Use **▽** to scroll the list so you can view the items that run off the bottom of the screen.

\bar{x}	mean of data stored in xList	Σy^2	sum of squares of data stored in yList
Σx	sum of data stored in xList	σ_y	population standard deviation of data stored in yList
Σx^2	sum of squares of data stored in xList	s_y	sample standard deviation of data stored in yList
σ_x	population standard deviation of data stored in xList	Σxy	sum of the product of data stored in xList and yList
s_x	sample standard deviation of data stored in xList	minX.....	minimum of data stored in xList
n	number of data	maxX.....	maximum of data stored in xList
\bar{y}	mean of data stored in yList	minY.....	minimum of data stored in yList
Σy	sum of data stored in yList	maxY.....	maximum of data stored in yList

4. Statistical Graph Display Operations

This section explains the functions of the function menu that appears when you press **SHIFT** while a statistical graph is displayed.

- SHIFT** **F1** (TRCE) ... Reads graph data values (page 5-15)
- SHIFT** **F2** (ZOOM) ... Zooms the graph display (page 5-15)
- SHIFT** **F3** (V-WIN) ... Enables manual View Window setting (page 5-16)
- SHIFT** **F4** (SKTCH) ... Enables sketching on a graph (page 5-18)
- SHIFT** **F5** (G-SLV) ... Calculates estimated values based on a regression graph (page 5-19)
- SHIFT** **F6** (G↔T) ... Returns to the List Editor screen from the graph screen

■ Reading Graph Data Values (Trace)

Perform the key operation below while a statistical graph is displayed to start the trace operation that reads data values.

1. **[SHIFT] [F1] (TRCE)**

- This causes a pointer (\oplus) to appear on the graph screen. The data values at the current pointer location will be displayed at the bottom of the screen.

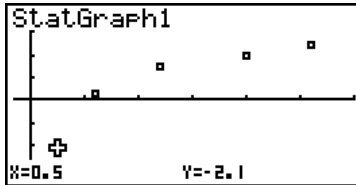

Normal probability density plot (NPP) example screen

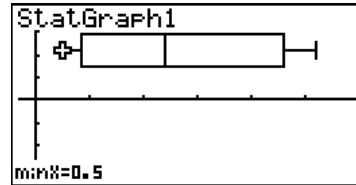

Med box graph (MedBox) example screen

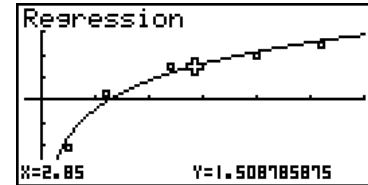

Regression graph example screen

2. Use **[LEFT]** and **[RIGHT]** to move the pointer.

- The data values at the bottom of the screen will be updated in accordance with the current pointer position.
- The table below explains operation of the **[DOWN]** and **[UP]** keys during trace.

While this type of statistical graph is displayed:	Pressing [UP] or [DOWN] does this:
Bar graph based on multiple data lists (Data 1, Data 2, Data 3)	Moves the pointer between the bars (Data 1, Data 2, Data 3)
Regression graph overlaid on a scatter plot or xy line graphs	Moves the pointer between the scatter plot or line graph and the regression graph

3. To exit the trace operation and return to the normal graph screen, press **[SHIFT] [F1] (TRCE)**.

- Pressing **[EXIT]** instead of **[SHIFT] [F1] (TRCE)** returns to the List Editor screen.

Note

- The graph screen display range is fixed while a trace operation is in progress. Because of this, pointer movement will not cause the screen to scroll.
- The pointer is not visible on the graph when it is located at a point outside the graph display area or when an error of no value occurs.
- The data values at the current pointer location will not appear on the display if "Off" is selected for the setup screen's "Coord" setting (page 2-14).

■ Zooming a Graph Display (Zoom)

This function lets you enlarge and reduce the graph on the screen.

1. Draw the graph.
2. Specify the zoom type.

[SHIFT] [F2] (ZOOM) [F1] (BOX) ... Box zoom

Draw a box around a display area, and that area is enlarged to fill the entire screen.

F2 (FACT)

Specifies the x -axis and y -axis zoom factors for factor zoom.

F3 (IN)/**F4** (OUT) ... Factor zoom

The graph is enlarged or reduced in accordance with the factor you specify, centered on the current pointer location.

F6 (\triangleright) **F1** (ORIG) ... Original size

Returns the graph to its original size following a zoom operation.

F6 (\triangleright) **F2** (SQR) ... Graph correction

V-Window x -axis values are corrected so they are identical to the y -axis values.

F6 (\triangleright) **F3** (RND) ... Coordinate rounding

Rounds the coordinate values at the current pointer location.

F6 (\triangleright) **F4** (INTG) ... Integer

Each dot is given a width of 1, which makes coordinate values integers.

F6 (\triangleright) **F5** (PRE) ... Previous

V-Window parameters are returned to what they were prior to the last zoom operation.

Box zoom range specification

- Use the cursor keys to move the pointer (\oplus) in the center of the screen to the location where you want one corner of the box to be, and then press **EXE**.
- Use the cursor keys to move the pointer. This causes a box to appear on the screen. Move the cursor until the area you want to enlarge is enclosed in the box, and then press **EXE** to enlarge it.

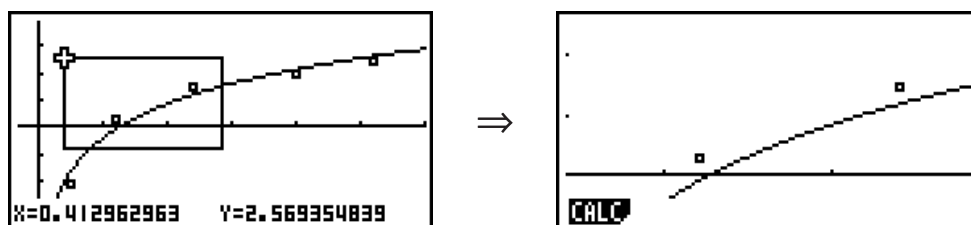

- You must specify two different points for box zoom, and the two points cannot be on a straight line vertically or horizontally from each other.

■ Configuring View Window Settings Manually

When “Manual” is selected for the setup screen’s “Stat Wind” setting (page 2-15), the calculator draws statistical graphs in accordance with the settings currently input on the View Window.

● To configure View Window settings manually

- On the **STAT** mode List Editor screen or graph screen, press **SHIFT** **F3** (V-WIN).

2. On the View Window setting screen that appears, configure the settings as desired.

- Use \blacktriangledown and \blacktriangle to move the highlighting to the item whose setting you want to change, enter the desired value, and then press $\boxed{\text{EXE}}$.

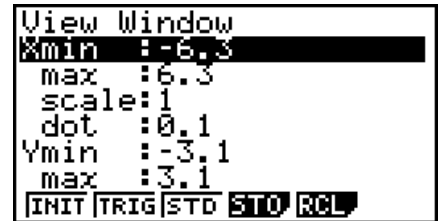

Xmin/Xmax Minimum/maximum x -axis value
 Xscale Spacing of x -axis increments
 Xdot Value that corresponds to one x -axis dot
 Ymin/Ymax Minimum/maximum y -axis value
 Yscale Spacing of y -axis increments

- You can also batch configure settings with preset values by pressing the keys described below. Pressing any one of these keys positions the linear coordinate origin in the center of the screen.

$\boxed{\text{F1}}$ (INIT) Makes display range x -axis = -6.3 to 6.3 , y -axis = -3.1 to 3.1

$\boxed{\text{F2}}$ (TRIG) Makes display range x -axis = -540 to 540 , y -axis = -1.6 to 1.6^*

$\boxed{\text{F3}}$ (STD) Makes display range x -axis = -10 to 10 , y -axis = -10 to 10

* When the setup screen angle unit (Angle) setting is “Deg”. The x -axis range is -3π to 3π when the angle unit setting is “Rad”, and -600 to 600 when it is “Gra”.

3. When all of the View Window settings are the way you want, press $\boxed{\text{EXIT}}$ or $\boxed{\text{SHIFT}} \boxed{\text{EXIT}}$ (QUIT).

Note

- If the above operation is started by pressing $\boxed{\text{SHIFT}} \boxed{\text{F3}}$ (V-WIN) while a graph screen is displayed, completing the procedure in step 3 will return to the List Editor screen. The View Window settings that you configured will be applied the next time you draw a graph.
- Changing the Xmin or Xmax value will automatically cause the Xdot value to be adjusted as well. Changing the Xdot value will automatically cause the Xmax value to be adjusted accordingly.
- The input range for each View Window item is shown below.
 $-9.999999999\text{E } 97$ to $9.999999999\text{E } 97$

• To save a View Window setup

1. Perform steps 1 and 2 of the procedure under “To configure View Window settings manually” to configure View Window settings to the values you want.
2. Press $\boxed{\text{F4}}$ (STO).

- This displays a dialog box for assigning a to the View Window setup.



3. Input a number from 1 to 6 and then press $\boxed{\text{EXE}}$.

• To recall a View Window setup

1. On the View Window setup screen, press $\boxed{\text{F5}}$ (RCL).
2. On the View Window setup number input dialog box that appears, input the number of the setup you want to recall and then press $\boxed{\text{EXE}}$.

■ Sketching on a Graph (Sketch)

The sketch function lets you draw points and lines inside of graphs.

You can select one of four different line styles for drawing with the sketch function.

1. From the Main Menu, enter the **GRAPH** mode.
2. Make V-Window settings.
3. On the Setup screen, use the “Sketch Line” setting to specify the line style you want.

F1(—) ... Normal (initial default)

F2(—) ... Thick (twice the thickness of Normal)

F3(.....) ... Broken (thick broken)

F4(.....) ... Dot (dotted)

4. Input the function of the graph.
5. Draw the graph.
6. Select the sketch function you want to use.*1

SHIFT **F4** (SKTCH) **F1** (Cls) ... Screen clear

F2 (Tang) ... Tangent line

F3 (Norm) ... Line normal to a curve

F4 (Inv) ... Inverse function*2

F6 (▷) **F1** (PLOT)

{Plot}/{PI•On}/{PI•Off}/{PI•Chg} ... Point {Plot}/{On}/{Off}/{Change}

F6 (▷) **F2** (LINE)

{Line}/{F•Line} ... {connects 2 points plotted by **F6** (▷) **F1** (PLOT) with a line}/{for drawing a line between any 2 points}

F6 (▷) **F3** (Crcl) ... Circle

F6 (▷) **F4** (Vert) ... Vertical line

F6 (▷) **F5** (Hztl) ... Horizontal line

F6 (▷) **F6** (▷) **F1** (PEN) ... Freehand

F6 (▷) **F6** (▷) **F2** (Text) ... Text input

7. Use the cursor keys to move the pointer (⊕) to the location where you want to draw, and press **EXE**.*3

*1 The above shows the function menu that appears in the **GRAPH** mode. Menu items may differ somewhat in other modes.

*2 In the case of an inverse function graph, drawing starts immediately after you select this option.

*3 Some sketch functions require specification of two points. After you press **EXE** to specify the first point, use the cursor keys to move the pointer to the location of the second point and press **EXE**.

- You can specify line type for the following sketch functions: Tangent, Normal, Inverse, Line, F•Line, Circle, Vertical, Horizontal, Pen

Example Draw a line that is tangent to point (2, 0) on the graph for $y = x(x + 2)(x - 2)$.

- ① **MENU** GRAPH
- ② **SHIFT** **F3** (V-WIN) **F1** (INIT) **EXIT**
- ③ **SHIFT** **MENU** (SET UP) **▼** **▼** **▼** **▼** **▼** **▼** **▼** **F1** (—) **EXIT**
- ④ **F3** (TYPE) **F1** (Y=) **X,θ,T** **SHIFT** **X** (() **X,θ,T** **+** **2**
SHIFT **÷** ()) **SHIFT** **X** (() **X,θ,T** **-** **2** **SHIFT** **÷** ()) **EXE**
- ⑤ **F6** (DRAW)
- ⑥ **SHIFT** **F4** (SKTCH) **F2** (Tang)
- ⑦ **▶** ~ **▶** **EXE** *1

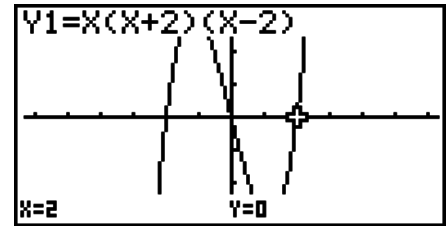

*1 You can draw a tangent line in succession by moving the “+” pointer and pressing **EXE**.

■ Using a Regression Graph to Calculate Estimated Values

The **STAT** mode also includes a Y-CAL function that uses regression to calculate the estimated y -value for a particular x -value after graphing a paired-variable statistical regression.

The following is the general procedure for using the Y-CAL function.

1. After drawing a regression graph, press **SHIFT** **F5** (G-SLV) **F1** (Y-CAL) to enter the graph selection mode, and then press **EXE**.

If there are multiple graphs on the display, use **▲** and **▼** to select the graph you want, and then press **EXE**.

- This causes an x -value input dialog box to appear.

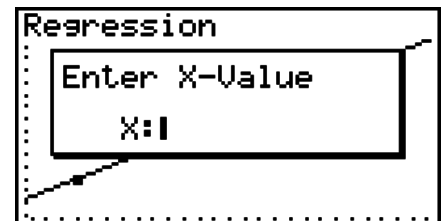

2. Input the value you want for x and then press **EXE**.

- This causes the coordinates for x and y to appear at the bottom of the display, and moves the pointer to the corresponding point on the graph.

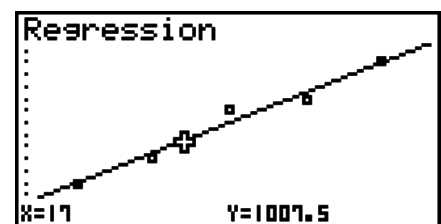

3. Pressing a number key at this time causes the x -value input dialog box to reappear so you can perform another estimated value calculation if you want.

- The pointer does not appear if the calculated coordinates are not within the display range.
- The coordinates do not appear if “Off” is specified for the “Coord” item of the Setup screen.
- The Y-CAL function can also be used with a graph drawn by using DefG feature.

5. Performing Statistical Calculations

All of the statistical calculations up to this point were performed after displaying a graph. The following procedures can be used to perform statistical calculations alone.

• To specify statistical calculation data lists

You have to input the statistical data for the calculation you want to perform and specify where it is located before you start a calculation. Display the statistical data and then press **F2**(CALC) **F6**(SET).



```
1Var XList :List1
1Var Freq  :1
2Var XList :List1
2Var YList :List2
2Var Freq  :1
LIST
```

The following is the meaning for each item.

- 1Var XList.....location of single-variable statistic x values (XList)
 - 1Var Freqlocation of single-variable frequency values (Frequency)
 - 2Var XList.....location of paired-variable statistic x values (XList)
 - 2Var YList.....location of paired-variable statistic y values (YList)
 - 2Var Freqlocation of paired-variable frequency values (Frequency)
- Calculations in this section are performed based on the above specifications.

■ Single-Variable Statistical Calculations

In the previous example under “Displaying the Calculation Results of a Drawn Single-Variable Graph”, statistical calculation results were displayed after the graph was drawn. These were numeric expressions of the characteristics of variables used in the graphic display.

These values can also be directly obtained by displaying the statistical data list and pressing **F2**(CALC) **F1**(1VAR).

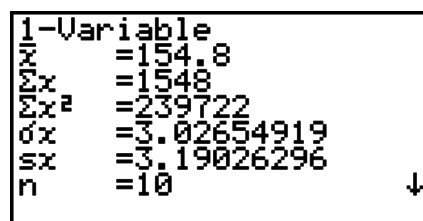

```
1-Variable
x̄ =154.8
Σx =1548
Σx² =239722
σx =3.02654919
sx =3.19026296
n =10 ↓
```

After this, pressing **▲** or **▼** scrolls the statistical calculation result display so you can view variable characteristics.

For details on the meanings of these statistical values, see “Displaying the Calculation Results of a Drawn Single-Variable Graph” (page 5-6).

■ Paired-Variable Statistical Calculations

In the previous example under “Displaying the Calculation Results of a Drawn Paired-Variable Graph”, statistical calculation results were displayed after the graph was drawn. These were numeric expressions of the characteristics of variables used in the graphic display.

These values can also be directly obtained by displaying the statistical data list and pressing $\boxed{F2}$ (CALC) $\boxed{F2}$ (2VAR).

```

2-Variable
 $\bar{x}$  =20
 $\Sigma x$  =100
 $\Sigma x^2$  =2250
 $\sigma x$  =7.07106781
 $s_x$  =7.90569415
n =5
↓

```

After this, pressing \uparrow or \downarrow scrolls the statistical calculation result display so you can view variable characteristics.

For details on the meanings of these statistical values, see “Displaying the Calculation Results of a Drawn Paired-Variable Graph” (page 5-14).

■ Regression Calculation

In the explanations from “Linear Regression Graph” to “Logistic Regression Graph”, regression calculation results were displayed after the graph was drawn. Here, each coefficient value of the regression line or regression curve is expressed as a number.

You can directly determine the same expression from the data input screen.

Pressing $\boxed{F2}$ (CALC) $\boxed{F3}$ (REG) displays a function menu, which contains the following items.

- $\{ax+b\}/\{a+bx\}/\{\text{Med}\}/\{X^2\}/\{X^3\}/\{X^4\}/\{\text{Log}\}/\{ae^{bx}\}/\{ab^x\}/\{\text{Pwr}\}/\{\text{Sin}\}/\{\text{Lgst}\}$...
 {linear regression ($ax+b$ form)}/{linear regression ($a+bx$ form)}/{Med-Med}/{quadratic regression}/{cubic regression}/{quartic regression}/{logarithmic regression}/{exponential regression (ae^{bx} form)}/{exponential regression (ab^x form)}/{power regression}/{sinusoidal regression}/{logistic regression} parameters

Example **To display single-variable regression parameters**

$\boxed{F2}$ (CALC) $\boxed{F3}$ (REG) $\boxed{F1}$ (X) $\boxed{F1}$ ($ax+b$)

```

LinearReg(ax+b)
a =-0.2727272
b =2.63636363
r =-0.227022
r^2=0.05153901
MSe=16.060606
y=ax+b
COPY

```

The meanings of the parameters that appear on this screen are the same as those for “Linear Regression Graph” to “Logistic Regression Graph”.

● Calculation of the Coefficient of Determination (r^2) and MSe

You can use the **STAT** mode to calculate the coefficient of determination (r^2) for quadratic regression, cubic regression, and quartic regression. The following types of MSe calculations are also available for each type of regression.

```

QuadReg
a =0.31765306
b =-0.1133673
c =0.11530612
r^2=0.99991584
MSe=4.8149E-03
y=ax^2+bx+c
COPY

```

- Linear Regression $(ax + b)$ $MSe = \frac{1}{n-2} \sum_{i=1}^n (y_i - (ax_i + b))^2$
 $(a + bx)$ $MSe = \frac{1}{n-2} \sum_{i=1}^n (y_i - (a + bx_i))^2$
- Quadratic Regression..... $MSe = \frac{1}{n-3} \sum_{i=1}^n (y_i - (ax_i^2 + bx_i + c))^2$
- Cubic Regression..... $MSe = \frac{1}{n-4} \sum_{i=1}^n (y_i - (ax_i^3 + bx_i^2 + cx_i + d))^2$
- Quartic Regression..... $MSe = \frac{1}{n-5} \sum_{i=1}^n (y_i - (ax_i^4 + bx_i^3 + cx_i^2 + dx_i + e))^2$
- Logarithmic Regression..... $MSe = \frac{1}{n-2} \sum_{i=1}^n (y_i - (a + b \ln x_i))^2$
- Exponential Repression $(a \cdot e^{bx})$ $MSe = \frac{1}{n-2} \sum_{i=1}^n (\ln y_i - (\ln a + bx_i))^2$
 $(a \cdot b^x)$ $MSe = \frac{1}{n-2} \sum_{i=1}^n (\ln y_i - (\ln a + (\ln b) \cdot x_i))^2$
- Power Regression..... $MSe = \frac{1}{n-2} \sum_{i=1}^n (\ln y_i - (\ln a + b \ln x_i))^2$
- Sin Regression..... $MSe = \frac{1}{n-2} \sum_{i=1}^n (y_i - (a \sin (bx_i + c) + d))^2$
- Logistic Regression..... $MSe = \frac{1}{n-2} \sum_{i=1}^n \left(y_i - \frac{C}{1 + ae^{-bx_i}} \right)^2$

■ Estimated Value Calculation (\hat{x} , \hat{y})

After drawing a regression graph with the **STAT** mode, you can use the **RUN • MAT** mode to calculate estimated values for the regression graph's x and y parameters.

Example To perform a linear regression using the nearby data and estimate the values of \hat{y} and \hat{x} when $x_i = 20$ and $y_i = 1000$

x_i	10	15	20	25	30
y_i	1003	1005	1010	1011	1014

1. From the Main Menu, enter the **STAT** mode.
2. Input data into the list and draw the linear regression graph.
3. From the Main Menu, enter the **RUN • MAT** mode.
4. Press the keys as follows.

$\boxed{2}$ $\boxed{0}$ (value of x_i)
 $\boxed{\text{OPTN}}$ $\boxed{\text{F5}}$ (STAT) $\boxed{\text{F2}}$ (\hat{y}) $\boxed{\text{EXE}}$

$\boxed{20}$ $\boxed{1008.6}$

The estimated value \hat{y} is displayed for $x_i = 20$.

$\boxed{1} \boxed{0} \boxed{0} \boxed{0}$ (value of y_i)

$\boxed{F1}(\hat{x}) \boxed{EXE}$

20%	1008.6
1000%	4.642857143

The estimated value \hat{x} is displayed for $y_i = 1000$.

- You cannot obtain estimated values for a Med-Med, quadratic regression, cubic regression, quartic regression, sinusoidal regression, or logistic regression graph.

Normal Probability Distribution Calculation

You can calculate normal probability distributions for single-variable statistics with the **RUN • MAT** mode.

Press $\boxed{OPTN} \boxed{F6}(\triangleright) \boxed{F3}(\text{PROB}) \boxed{F6}(\triangleright)$ to display a function menu, which contains the following items.

- $\{P\}/\{Q\}/\{R\}$... obtains normal probability $\{P(t)\}/\{Q(t)\}/\{R(t)\}$ value
- $\{t\}$... {obtains normalized variate $t(x)$ value}
- Normal probability $P(t)$, $Q(t)$, and $R(t)$, and normalized variate $t(x)$ are calculated using the following formulas.

Standard Normal Distribution

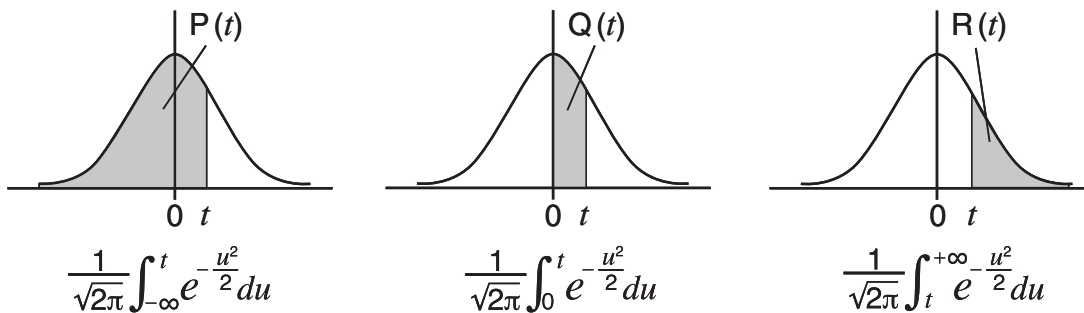

$$t(x) = \frac{x - \bar{x}}{\sigma_x}$$

Example

The following table shows the results of measurements of the height of 20 college students. Determine what percentage of the students fall in the range 160.5 cm to 175.5 cm. Also, in what percentile does the 175.5 cm tall student fall?

Class no.	Height (cm)	Frequency
1	158.5	1
2	160.5	1
3	163.3	2
4	167.5	2
5	170.2	3

Class no.	Height (cm)	Frequency
6	173.3	4
7	175.5	2
8	178.6	2
9	180.4	2
10	186.7	1

1. From the Main Menu, enter the **STAT** mode.
2. Input the height data into List 1 and the frequency data into List 2.
3. Perform the single-variable statistical calculations.

You can obtain the normalized variate immediately after performing single-variable statistical calculations only.

F2(CALC) **F6**(SET)
F1(LIST) **1** **EXE**
F2(LIST) **2** **EXE** **SHIFT** **EXIT**(QUIT)
F2(CALC) **F1**(1VAR)

1-Variable	
\bar{x}	=172.005
Σx	=3440.1
Σx^2	=592706.09
σx	=7.04162445
sx	=7.22455425
n	=20

4. Press **MENU**, select the **RUN • MAT** mode, press **OPTN** **F6**(\triangleright) **F3**(PROB) **F6**(\triangleright) to recall the probability calculation (PROB) menu.

F4(t) **1** **6** **0** **.** **5** **SHIFT** **\div** () **EXE**
 (Normalized variate t for 160.5 cm) Result: -1.633855948
(\approx -1.634)

F4(t) **1** **7** **5** **.** **5** **SHIFT** **\div** () **EXE**
 (Normalized variate t for 175.5 cm) Result: 0.4963343361
(\approx 0.496)

F1(P) **0** **.** **4** **9** **6** **SHIFT** **\div** () **=**
F1(P) **=** **1** **.** **6** **3** **4** **SHIFT** **\div** () **EXE**
 (Percentage of total) Result: 0.6389233692
(63.9% of total)

F3(R) **0** **.** **4** **9** **6** **SHIFT** **\div** () **EXE**
 (Percentile) Result: 0.3099472055
(31.0 percentile)

■ Determining Standard Deviation and Variance from List Data

You can use functions to determine standard deviation and variance for specified list data. This calculation is performed in the **RUN • MAT** mode. You can perform calculations using data you saved to a list (List 1 to List 26) with the **STAT** mode List Editor or list data you input directly on the **RUN • MAT** mode screen.

Syntax StdDev(List n [,List m])
 Variance(List n [,List m])
 List nSample data
 List mFrequency data

Example **To store the x -data below in List 1, the frequency values in List 2, and determine the standard deviation and variance**

x	60	70	80	90
Frequency	3	5	4	1

1. From the Main Menu, enter the **STAT** mode.
2. Use the List Editor to store the above data.
3. From the Main Menu, enter the **RUN • MAT** mode.
4. Press the keys as follows.

OPTN F5 (STAT) F3 (S • Dev) EXIT
 F1 (LIST) F1 (List) 1 ▸ F1 (List) 2
 SHIFT ÷ ()) EXE

```

StdDev(List 1,List 2)
          9.26808696
  
```

EXIT F5 (STAT) F4 (Var) EXIT
 F1 (LIST) F1 (List) 1 ▸ F1 (List) 2
 SHIFT ÷ ()) EXE

```

StdDev(List 1,List 2)
          9.26808696
Variance(List 1,List
2)
          85.8974359
List L→M Dim Fill Seq ▸
  
```

Chapter 6 Programming

1. Basic Programming Steps

Commands and calculations are executed sequentially, just like manual calculation multi-statements.

1. From the Main Menu, enter the **PRGM** mode.

When you do, a program list appears on the display.

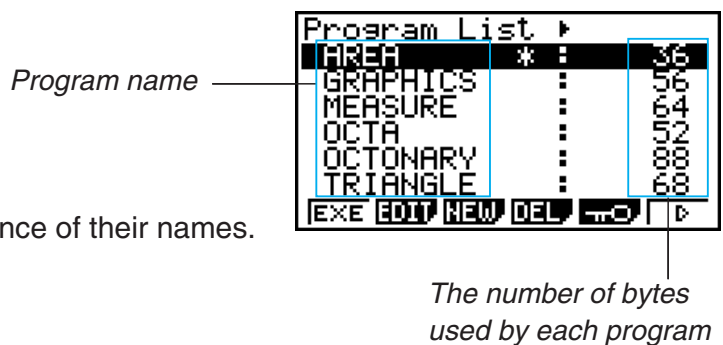

Files are listed in the alphabetic sequence of their names.

2. Register a file name.
3. Input the program.
4. Run the program.

- A file name can be up to eight characters long.
- The following are the characters you can use in a file name: A through Z, ', ~, 0 through 9, +, -
- Registering a file name uses 32 bytes of memory.

Example To calculate the surface area (cm^2) and volume (cm^3) of three regular octahedrons when the length of one side is 7, 10, and 15 cm, respectively

Store the calculation formula under the file name OCTA.

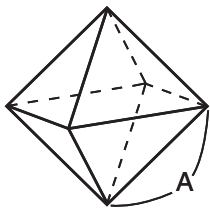

The following are the formulas used for calculating surface area S and volume V of a regular octahedron for which the length of one side A is known.

$$S = 2\sqrt{3} A^2, \quad V = \frac{\sqrt{2}}{3} A^3$$

- ① **MENU** PRGM
- ② **F3** (NEW) **ALPHA** **F3** (K-O) **F5** (O) **EXIT** **F1** (A-E) **F3** (C) **EXIT** **F4** (P-T) **F5** (T) **EXIT**
F1 (A-E) **F1** (A) **EXE**
- ③ **SHIFT** **PROG** (PRGM) **F4** (?) **ALPHA** **F1** (A-E) **F1** (A) **SHIFT** **PROG** (PRGM) **F6** **F5** (:)
2 **X** **SHIFT** $\sqrt{\quad}$ **3** **X** **ALPHA** **F1** (A-E) **F1** (A) $\sqrt{\quad}$ **SHIFT** **PROG** (PRGM) **F5** (\blacktriangle)
SHIFT $\sqrt{\quad}$ **2** **÷** **3** **X** **ALPHA** **F1** (A-E) **F1** (A)
SHIFT **0** (CATALOG) **ALPHA** **F6** (SYBL) **F4** () \blacktriangledown ~ \blacktriangledown (\wedge)
EXIT **EXIT** **F1** (INPUT) **3**
EXIT **EXIT**



- ④ **F1** (EXE) or **EXE**
7 **EXE** (Value of A)
EXE

A?	0
7	
S when A = 7	169.7409791
V when A = 7	161.6917506

- EXE** **EXE**
1 **0** **EXE**
EXE

A?	7
10	
S when A = 10	346.4101615
V when A = 10	471.4045208

- EXE** **EXE**
1 **5** **EXE**
EXE *1

A?	10
15	
S when A = 15	779.4228634
V when A = 15	1590.990258

*1 Pressing **EXE** while the program's final result is on the display exits the program.

• Running an Existing Program

- On the Main Menu or the **RUN•MAT** mode screen, press **PROG**.
 - This will display a Program List like the one shown nearby.

Program List		
ANGLE	:	36
AXISTRAN	:	156
BACKWARD	:	368
CL-CURVE	:	224
COORD	:	120
DECENTER	:	128↓
EXE		▢

- Use **▼** and **▲** to move the highlighting to the name of the program you want to run.
- Press **F1** (EXE) or **EXE**.
 - This runs the program.
 - Pressing **EXE** while a program's final calculation result is displayed re-runs the program.

Note

- In the **RUN•MAT** mode, you can also run a program by directly specifying the program file name using the syntax below.
 Prog "<file name>". An error will occur if the calculator is unable to find a program with the file name you specified.
- Even if you run a program by inputting its program name as described above, pressing **EXE** while the program's final calculation result is displayed will re-run the program.

• Re-running Program You Recently Ran

- While the Program List is displayed, press **▶**.
 - This displays a recently run program log, which can display up to six programs.

History ▶		
R-TRIG	:	36
AXISTRAN	:	36
OCTA	:	40
EXE		▢

2. To re-run a program in the log, use ▲ and ▼ to move the highlighting to it and then press **F2** (EXE) or **EXE**.

- To return to the Program List, press ▶.

Note

- A right indicator (▶) is displayed in the first line of the Program List when there is one or more programs listed in the recently run program log. If the down indicator is not displayed, pressing ▶ on the Program List will not display the recently run program log.
- The recently run program log includes programs that were run from the Program List. It does not include program that were run in the **RUN•MAT** mode or that were executed by a call inside another program.

2. PRGM Mode Function Keys

• File List Function Menu

- **{EXE}/{EDIT}** ... program {execute}/{edit}
 - **{NEW}** ... {new program}
 - **{DEL}** ... specific program delete
 - **{π0}** ... password protects a program or removes password protection
 - **{SRC}/{REN}** ... file name {search}/{change}
 - **{SV-AS}** ... saves program as a text file
 - **{LOAD}** ... converts a text file to a program and saves it
-

• When you are registering a file name

- **{RUN}/{BASE}** ... {general calculation}/{number base} program input
 - **{π0}** ... {password registration}
 - **{SYBL}** ... {symbol menu}
-

• When you are inputting a program — **F1** (RUN) ... default

- **{TOP}/{BTM}** ... {top}/{bottom} of program
- **{SRC}** ... {search}
- **{MENU}** ... {mode menu}
- **{STAT}/{MAT}/{LIST}** ... {statistic}/{matrix}/{list} menu
- **{A↔a}** ... {toggles between upper-case and lower-case input}
- **{CHAR}** ... {displays a screen for selecting various mathematical symbols, special symbols, and accented characters}
- Pressing **SHIFT** **PROG** (PRGM) displays the following program (PRGM) menu.
 - **{COM}** ... {program command menu}
 - **{CTL}** ... {program control command menu}
 - **{JUMP}** ... {jump command menu}
 - **{?}/{▲}** ... {input}/{output} command

- {CLR}/{DISP} ... {clear}/{display} command menu
- {REL} ... {conditional jump relational operator menu}
- {I/O} ... {I/O control/transfer command menu}
- {:} ... {multi-statement command}
- {STR} ... {string command}

See “Command Reference” on page 6-10 for full details on each of these commands.

- Pressing **SHIFT** **MENU** (SET UP) displays the mode command menu shown below.
 - {ANGL}/{COOR}/{GRID}/{AXES}/{LABL}/{DISP}/{S/L}/{BACK}/{FUNC}/{S-WIN}/{LIST}/{RESID}/{CPLX}/{FRAC}/{SIMP}/{Q1Q3}

See “Setup Screen Function Key Menus” on page 2-14 for details about each of these commands.

• When you are inputting a program — **F2** (BASE)*¹

- {TOP}/{BTM}/{SRC}
- {MENU}
 - {d~o} ... {decimal}/{hexadecimal}/{binary}/{octal} value input
 - {LOG} ... {bitwise operator}
 - {DISP} ... conversion of displayed value to {decimal}/{hexadecimal}/{binary}/{octal}
 - {HEX} ... Displays a menu for input letters (A through F) used in hexadecimal notation.
 - {A↔a}/{SYBL}
- Pressing **SHIFT** **PROG** (PRGM) displays the following PRGM (PROGRAM) menu.
 - {Prog} ... {program recall}
 - {JUMP}/{?}/{▲}
 - {REL} ... {conditional jump relational operator menu}
 - {:} ... {multi-statement command}
- Pressing **SHIFT** **MENU** (SET UP) displays the mode command menu shown below.
 - {Dec}/{Hex}/{Bin}/{Oct}

*¹ Programs input after pressing **F2** (BASE) are indicated by **B** to the right of the file name.

3. Editing Program Contents

■ Debugging a Program

A problem in a program that keeps the program from running correctly is called a “bug”, and the process of eliminating such problems is called “debugging”. Either of the following symptoms indicates that your program contains bugs that require debugging.

- Error messages appearing when the program is run
- Results that are not within your expectations

• To eliminate bugs that cause error messages

An error message, like the one shown to the right, appears whenever something illegal occurs during program execution.



When such a message appears, press **[EXIT]** to display the place in the program where the error was caused. The cursor will be flashing at the location of the problem. Check the “Error Message Table” (page α-4) for steps you should take to correct the situation.

- Note that pressing **[EXIT]** does not display the location of the error if the program is password protected.

• To eliminate bugs that cause bad results

If your program produces results that are not what you normally expect, check the contents of the program and make necessary changes.

[F1](TOP)... Moves the cursor to the top of the program



[F2](BTM)... Moves the cursor to the bottom of the program



■ Searching for Data Inside a Program

Example To search for the letter “A” inside the program named OCTA

1. Recall the program.
2. Press **[F3]**(SRC) and input the data you want to find.

[F3](SRC)
[ALPHA] **[F1]**(A-E) **[F1]**(A)

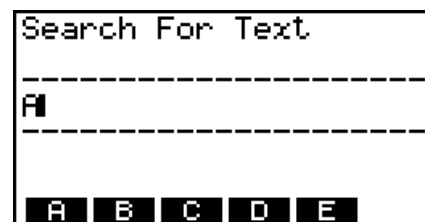

3. Press **[EXE]** to begin the search. The contents of the program appear on the screen with the cursor located at the first instance of the data you specified.*1



4. Each press of **[EXE]** or **[F1]**(SRC) causes the cursor to jump to the next instance of the data you specified.*2



*1 The message “Not Found” appears when the search data you specify cannot be found in the program.

*2 If there are no more instances of the data you specified, the search operation ends.

- You cannot specify the newline symbol (↵) or display command (▲) for the search data.
- Once the contents of the program are on the screen, you can use the cursor keys to move the cursor to another location before searching for the next instance of the data. Only the part of the program starting from the current cursor location is searched when you press [EXE].
- Once the search finds an instance of your data, inputting characters or moving the cursor causes the search operation to be cancelled.
- If you make a mistake while inputting characters to search for, press [AC] to clear your input and re-input from the beginning.

4. File Management

■ Searching for a File

• To find a file using initial character search

Example To use initial character search to recall the program named OCTA

1. While the program list is on the display, press [F6](>) [F1](SRC) and input the initial characters of the file you want to find.

[F6](>) [F1](SRC)

[ALPHA] [F3](K-O) [F5](O) [EXIT] [F1](A-E) [F3](C) [EXIT]

[F4](P-T) [F5](T)

```
Search For Program
[OCTA ]
```

2. Press [EXE] to search.

- The name that starts with the characters you input highlights.

```
Program List
OCTA : 44↑
OCTONARY : 89
TRIANGLE : 69
```

- If there is no program whose file name starts with the characters you input, the message “Not Found” appears on the display. If this happens, press [EXIT] to clear the error message.

■ Editing a File Name

1. While the program list is on the display, use ▲ and ▼ to move the highlighting to the file whose name you want to edit and then press [F6](>) [F2](REN).

2. Make any changes you want.

3. Press [EXE] to register the new name and return to the program list.

The program list is resorted according to the changes you made in the file name.

- If the modifications you make result in a file name that is identical to the name of a program already stored in memory, the message “Already Exists” appears. When this happens, you can perform either of the following two operations to correct the situation.
 - Press [EXIT] to clear the error and return to the file name editing screen.
 - Press [AC] to clear the input file name and input a new one.

■ Converting Programs and Text Files

You can convert programs created on this calculator to a text file, and then use a text editor or other application on your computer to edit them. You also can convert text files created and edited on your computer to a program that can be run by the calculator.

■ Deleting a Program

● To delete a specific program

1. While the program list is on the display, use \blacktriangle and \blacktriangledown to move the highlighting to the name of the program you want to delete.
 2. Press $\boxed{F4}$ (DEL).
 3. Press $\boxed{F1}$ (YES) to delete the selected program or $\boxed{F6}$ (NO) to abort the operation without deleting anything.
-

● Program and Text File Conversion Rules

Conversion of program and text files is subject to the following rules.

- Certain characters in the program name are automatically replaced and the result is assigned as the file name whenever you convert a program to a text file. When you convert from a text file to a program, the program name is assigned by converting in the opposite direction.

Program Name Characters	Text File Name Characters
r	_r_
θ	_t_
Leading/trailing spaces	_s_
"	_q_
Leading/trailing dots	_p_
\times	_x_
\div	_d_
+	_+_
-	_-

- The following header information is added to the text file when converting from a program to a text file.
'Program Mode: RUN (RUN Mode program)
'Program Mode: BASE (BASE Mode program)
- Converting a text file that contains the above header information to a program converts to a program of the mode specified in the header information. The header information line text is not included in the converted program.
- Converting a program to a text file causes all CASIO scientific function calculator-specific commands in the program to be replaced by special corresponding character strings. Conversely, converting from a text file to a program converts the special character strings back to their corresponding commands. For information about program commands and their corresponding special character strings, see "CASIO Scientific Function Calculator Special Commands \leftrightarrow Text Conversion Table" (page 6-34).

• To convert a program to a text file

1. In the program list, use \blacktriangle and \blacktriangledown to move the highlighting to the name of the program you want to convert to a text file.
2. Press $\boxed{F6}$ (\triangleright) $\boxed{F3}$ (SV • AS).
 - This starts conversion to a text file. The message “Complete!” appears after conversion is complete. To close the message dialog box, press \boxed{EXIT} .
 - The resulting text file is stored in the storage memory’s @MainMem\PROGRAM folder, under a name that is basically the same as the original file, except for certain special characters. For details about special character exceptions, see “Program and Text File Conversion Rules” above.

Important!

A program that is password protected cannot be converted to a text file. To convert a password protected file, first use the procedure under “To remove password protection from a program” (page 6-9) to remove password protection and then convert it.

• Auto Conversion from Text Files to Programs

Whenever you terminate the USB connection between the calculator and computer, all of the text files that were transferred from the computer to Storage Memory\@MainMem\PROGRAM\ while they were connected will be automatically converted to programs and stored in the calculator’s main memory.

For details, see “Transferring Data between the Calculator and a Personal Computer” (page 10-3).

• To convert a text file to a program

Important!

Using the procedure below to convert a text file to a program will create and save a program under a name that is basically the same as the original file, except for certain special characters. For details about special character exceptions, see “Program and Text File Conversion Rules” (page 6-7).

If there is already a program in memory with the same name as the program created by the conversion process, the existing program will be overwritten automatically with the new program. If you do not want such an existing program to be overwritten, use the program list to change its name before performing this procedure.

1. Copy the text file to be converted to a program to the calculator’s storage memory root directory or in any folder up to three levels under the root directory.
 - For information about the procedure for copying files from a computer to this calculator’s storage memory, see “Chapter 10 Data Communication”.
2. From the Main Menu, enter the **PRGM** mode.
3. On the program list, press $\boxed{F6}$ (\triangleright) $\boxed{F4}$ (LOAD).
 - This displays a list of folders and text files currently in the storage memory root directory.
4. If the text file to be converted is located inside a folder, open the folder.
5. Use \blacktriangle and \blacktriangledown to move the highlighting to the text file you want to convert and then press $\boxed{F1}$ (OPEN).

■ Registering a password

When inputting a program, you can protect it with a password that limits access to the program contents to those who know the password.

- You do not need to input the password to run a program.
- The password input procedure is identical to that used for file name input.

• To password protect a program as you are creating it

1. While the program list is on the display, press **[F3]** (NEW) and input the file name of the new program file.
2. Press **[F5]** (**π0**) and then input the password.
3. Press **[EXE]** to register the file name and password. Now you can input the contents of the program file.
4. After inputting the program, press **[SHIFT]** **[EXIT]** (QUIT) to exit the program file and return to the program list. Files that are password protected are indicated by an asterisk to the right of the file name.



Program List	
AREA *	34
GRAPHICS	56

• To password protect an existing program

1. In the program list, use **▲** and **▼** to move the highlighting to the name of the program you want to password protect.
2. Press **[F5]** (**π0**) and then input the password.
3. Press **[EXE]** to register the password.
 - This returns to the program list.

• To remove password protection from a program

1. In the program list, use **▲** and **▼** to move the highlighting to the name of the program whose password you want to remove.
2. Press **[F5]** (**π0**) and then input the programs current password.
3. To remove password protection, press **[EXE]**.
 - This returns to the program list.

■ Recalling a Password Protected Program

1. In the program list, use **▲** and **▼** to move the highlighting to the name of the program you want to recall.
 2. Press **[F2]** (EDIT).
 3. Input the password and press **[EXE]** to recall the program.
- Inputting the wrong password when recalling a password protected program causes the message "Mismatch" to appear.

5. Command Reference

■ Command Index

Break.....	6-14	StrCmp(.....	6-21
CloseCSV	6-24	StrInv(.....	6-21
ClrGraph	6-18	StrJoin(.....	6-21
ClrList	6-18	StrLeft(.....	6-21
ClrMat	6-18	StrLen(.....	6-21
ClrText	6-18	StrLwr(.....	6-21
CSVInfo.....	6-24	StrMid(.....	6-22
Do~LpWhile	6-14	StrRight(.....	6-22
DrawStat	6-18	StrRotate(.....	6-22
Dsz	6-16	StrShift(.....	6-22
Exp(.....	6-21	StrSrc(.....	6-22
Exp►Str(.....	6-21	StrUp(.....	6-22
For~To~(Step~)Next.....	6-13	While~WhileEnd	6-14
GetCellString.....	6-26	" " (Text string display)	6-11
GetCellValue.....	6-26	?→ (Value input for assignment to a variable)	6-11
Getkey	6-19	? (Display of the variable's current value and value input for assignment to a variable)	6-11
Goto~Lbl	6-16	▲ (Output Command)	6-12
If~Then~(Else~)IfEnd	6-13	: (Multi-statement Command)	6-12
Isz	6-16	␣ (Carriage Return)	6-12
LoadNextCell	6-25	' (Comment Text Delimiter)	6-12
Locate	6-19	⇒ (Jump Code)	6-17
Menu.....	6-17	=, ≠, >, <, ≥, ≤ (Relational Operators) ..	6-20
OpenCSV.....	6-24	+.....	6-22
Prog	6-15		
Return	6-15		
Stop	6-15		

The following are conventions that are used in this section when describing the various commands.

- Boldface Text** Actual commands and other items that always must be input are shown in boldface.
- {Curly Brackets} Curly brackets are used to enclose a number of items, one of which must be selected when using a command. Do not input the curly brackets when inputting a command.
- [Square Brackets] Square brackets are used to enclose items that are optional. Do not input the square brackets when inputting a command.
- Numeric Expressions... Numeric expressions (such as 10, 10 + 20, A) indicate constants, calculations, numeric constants, etc.
- Alpha Characters Alpha characters indicate literal strings (such as AB).

■ Basic Operation Commands

" " (Text string display)

Function: Causes the text string inside the quotation marks (" ") to appear on the display.

Syntax: "<text string>"

Example: "Test #01"

Description: Enclosing alphabetic characters, numerals, calculation commands or other text inside the quotation marks (" ") causes the text to be displayed as comment text. "<text string>" can contain up to 255 bytes of text.

?→ (Value input for assignment to a variable)

Function: Displays a prompt for input of a value to be assigned to a variable.

Syntax 1: ?→<variable name>

Syntax 2: "<text string>" ?→<variable name>

Example 1: ?→A

Example 2: "Input"?→A

Description:

- This command pauses the program and displays a prompt for input of a value to be assigned to a variable. Syntax 1 displays a question mark (?) for the prompt, while Syntax 2 displays the <text string> text followed by a question mark (?). Up to 255 bytes of text can be specified for the <text string>.
- Input in response to the input command must be a value or an expression, and the expression cannot be a multi-statement.
- You can specify a list name, matrix name, string memory, function memory (fn), etc. as a variable name.

? (Display of the variable's current value and value input for assignment to a variable)

Function: Displays the value currently assigned to a value and prompts for input of new value to be assigned to the variable, if desired.

Syntax 1: ?<variable name>

Syntax 2: "<text string>" ?<variable name>

Example 1: ?A

Example 2: "Input"? A

Description:

- This command pauses the program and displays a prompt for input of a value to be assigned to a variable on the left side of the screen. At the same time the value currently assigned to the variable is displayed on the right side of the screen.

- Syntax 1 displays a question mark (?) for the prompt, while Syntax 2 displays the <text string> text followed by a question mark (?). Up to 255 bytes of text can be specified for the <text string>.
- Input in response to the input command must be a value or an expression, and the expression cannot be a multi-statement.
- An alphabetic character from A to Z can be specified as the variable name.

▲ (Output Command)

Function: Displays an intermediate result during program execution.

Description:

- This command momentarily interrupts program execution and displays alpha character text or the result of the calculation immediately before the command.
- The output command should be used at locations where you would normally press the **EXE** key during a manual calculation.

: (Multi-statement Command)

Function: Connects two statements for sequential execution without stopping.

Description:

- Unlike the output command (▲), statements connected with the multi-statement command are executed non-stop.
- The multi-statement command can be used to link two calculation expressions or two commands.
- You can also use a carriage return indicated by ↵ in place of the multi-statement command.

↵ (Carriage Return)

Function: Connects two statements for sequential execution without stopping.

Description:

- Operation of the carriage return is identical to that of the multi-statement command.
- You can create a blank line in a program by inputting a carriage return only. Using a carriage return in place of the multi-statement command makes the displayed program easier to read.

' (Comment Text Delimiter)

Function: Indicates comment text inserted inside a program.

Description: Anything following the apostrophe is treated as non-executable comment text.

■ Program Commands (COM)

If~Then~(Else~)IfEnd

Function: The Then-statement is executed only when the If-condition is true (non-zero). The Else-statement is executed when the If-condition is false (0). The IfEnd-statement is always executed following either the Then-statement or Else-statement.

Syntax:

$$\text{If } \underbrace{\langle \text{condition} \rangle}_{\text{numeric expression}} \left\{ \begin{array}{c} \leftarrow \\ : \\ \blacktriangle \end{array} \right\} \text{Then } \langle \text{statement} \rangle \left[\left\{ \begin{array}{c} \leftarrow \\ : \\ \blacktriangle \end{array} \right\} \langle \text{statement} \rangle \right]$$
$$\left\{ \begin{array}{c} \leftarrow \\ : \\ \blacktriangle \end{array} \right\} \left(\text{Else } \langle \text{statement} \rangle \left[\left\{ \begin{array}{c} \leftarrow \\ : \\ \blacktriangle \end{array} \right\} \langle \text{statement} \rangle \right] \left\{ \begin{array}{c} \leftarrow \\ : \\ \blacktriangle \end{array} \right\} \right) \text{IfEnd}$$

Parameters: condition, numeric expression

Description:

(1) If ~ Then ~ IfEnd

- When the condition is true, execution proceeds with the Then-statement and then continues with the statement following IfEnd.
- When the condition is false, execution jumps to the statement following IfEnd.

(2) If ~ Then ~ Else ~ IfEnd

- When the condition is true, execution proceeds with the Then-statement and then jumps to the statement following IfEnd.
- When the condition is false, execution jumps to the Else-statement and then continues with the statement following IfEnd.

For~To~(Step~)Next

Function: This command repeats everything between the For-statement and the Next-statement. The starting value is assigned to the control variable with the first execution, and the value of the control variable is changed according to the step value with each execution. Execution continues until the value of the control variable exceeds the ending value.

Syntax: For <starting value> → <control variable name> To <ending value>

$$\left(\text{Step } \langle \text{step value} \rangle \right) \left\{ \begin{array}{c} \leftarrow \\ : \\ \blacktriangle \end{array} \right\} \text{Next}$$

Parameters:

- control variable name: A to Z
- starting value: value or expression that produces a value (i.e. $\sin x$, A, etc.)
- ending value: value or expression that produces a value (i.e. $\sin x$, A, etc.)
- step value: numeric value (default: 1)

Description:

- The default step value is 1.
- Making the starting value less than the ending value and specifying a positive step value causes the control variable to be incremented with each execution. Making the starting value greater than the ending value and specifying a negative step value causes the control variable to be decremented with each execution.

Do~LpWhile

Function: This command repeats specific commands as long as its condition is true (non-zero).

Syntax:

Do { : } <statement> { : } LpWhile <condition>
numeric expression

Parameters: expression

Description:

- This command repeats the commands contained in the loop as long as its condition is true (non-zero). When the condition becomes false (0), execution proceeds from the statement following the LpWhile-statement.
- Since the condition comes after the LpWhile-statement, the condition is tested (checked) after all of the commands inside the loop are executed.

While~WhileEnd

Function: This command repeats specific commands as long as its condition is true (non-zero).

Syntax:

While <condition> { : } <statement> { : } WhileEnd
numeric expression

Parameters: expression

Description:

- This command repeats the commands contained in the loop as long as its condition is true (non-zero). When the condition becomes false (0), execution proceeds from the statement following the WhileEnd-statement.
- Since the condition comes after the While-statement, the condition is tested (checked) before the commands inside the loop are executed.

■ Program Control Commands (CTL)

Break

Function: This command breaks execution of a loop and continues from the next command following the loop.

Syntax: Break ↵

Description:

- This command breaks execution of a loop and continues from the next command following the loop.
- This command can be used to break execution of a For-statement, Do-statement, and While-statement.

Prog

Function: This command specifies execution of another program as a subroutine. In the **RUN•MAT** mode, this command executes a new program.

Syntax: Prog "file name" ↵

Example: Prog "ABC" ↵

Description:

- Even when this command is located inside of a loop, its execution immediately breaks the loop and launches the subroutine.
- This command can be used as many times as necessary inside of a main routine to call up independent subroutines to perform specific tasks.
- A subroutine can be used in multiple locations in the same main routine, or it can be called up by any number of main routines.

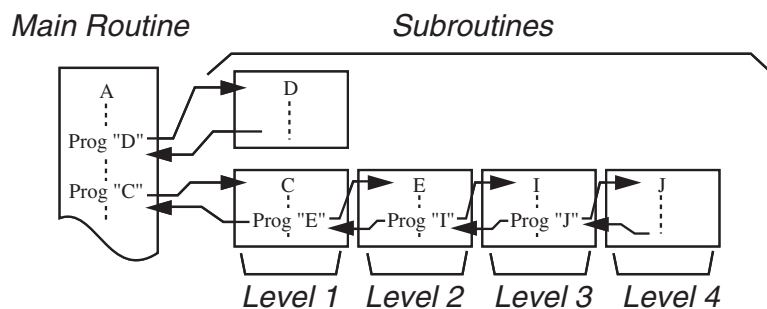

- Calling up a subroutine causes it to be executed from the beginning. After execution of the subroutine is complete, execution returns to the main routine, continuing from the statement following the Prog command.
- A Goto~Lbl command inside of a subroutine is valid inside of that subroutine only. It cannot be used to jump to a label outside of the subroutine.
- If a subroutine with the file name specified by the Prog command does not exist, an error occurs.
- In the **RUN•MAT** mode, inputting the Prog command and pressing **[EXE]** launches the program specified by the command.

Return

Function: This command returns from a subroutine.

Syntax: Return ↵

Description: Execution of the Return command inside a main routine causes execution of the program to stop. Execution of the Return command within a subroutine terminates the subroutine and returns to the program from which the subroutine was jumped to.

Stop

Function: This command terminates execution of a program.

Syntax: Stop ↵

Description:

- This command terminates program execution.
- Execution of this command inside of a loop terminates program execution without an error being generated.

Jump Commands (JUMP)

Dsz

Function: This command is a count jump that decrements the value of a control variable by 1, and then jumps if the current value of the variable is zero.

Syntax:

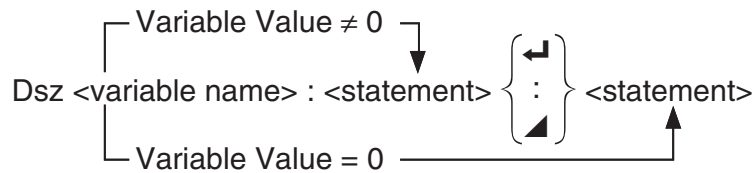

Parameters: variable name: A to Z, r , θ

[Example] Dsz B : Decrements the value assigned to variable B by 1.

Description: This command decrements the value of a control variable by 1, and then tests (checks) it. If the current value is non-zero, execution continues with the next statement. If the current value is zero, execution jumps to the statement following the multi-statement command (:), display command (\blacktriangleleft), or carriage return (\blacktriangleleft).

Goto~Lbl

Function: This command performs an unconditional jump to a specified location.

Syntax: Goto <label name> ~ Lbl <label name>

Parameters: label name: value (0 to 9), variable (A to Z, r , θ)

Description:

- This command consists of two parts: Goto n (where n is a parameter as described above) and Lbl n (where n is the parameter referenced by Goto n). This command causes program execution to jump to the Lbl-statement whose n parameter matches that specified by the Goto-statement.
- This command can be used to loop back to the beginning of a program or to jump to any location within the program.
- This command can be used in combination with conditional jumps and count jumps.
- If there is no Lbl-statement whose value matches that specified by the Goto-statement, an error occurs.

Isz

Function: This command is a count jump that increments the value of a control variable by 1, and then jumps if the current value of the variable is zero.

Syntax:

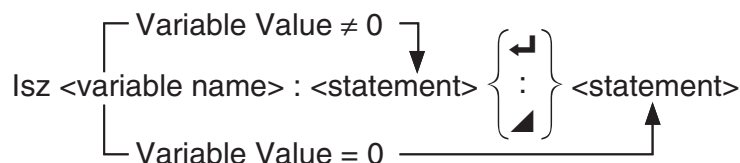

Parameters: variable name: A to Z, r , θ

[Example] Isz A : Increments the value assigned to variable A by 1.

Description: This command increments the value of a control variable by 1, and then tests (checks) it. If the current value is non-zero, execution continues with the next statement. If the current value is zero, execution jumps to the statement following the multi-statement command (:), display command (▲), or carriage return (↵).

⇒ (Jump Code)

Function: This code is used to set up conditions for a conditional jump. The jump is executed whenever the conditions are false.

Syntax:

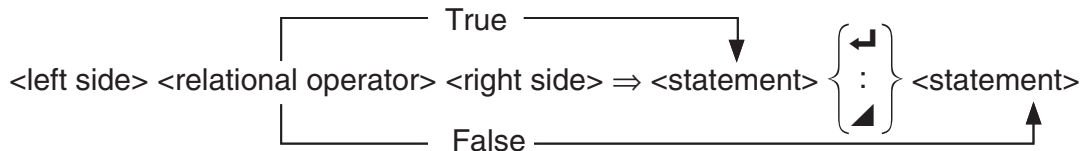

Parameters:

- left side/right side: variable (A to Z, *r*, *θ*), numeric constant, variable expression (such as: $A \times 2$)
- relational operator: =, ≠, >, <, ≥, ≤ (page 6-20)

Description:

- The conditional jump compares the contents of two variables or the results of two expressions, and a decision is made whether or not to execute the jump based on the results of the comparison.
- If the comparison returns a true result, execution continues with the statement following the ⇒ command. If the comparison returns a false result, execution jumps to the statements following the multi-statement command (:), display command (▲), or carriage return (↵).

Menu

Function: Creates a branching menu in a program.

Syntax: Menu "<string (menu name)>", "<string (branch name) 1>", <value or variable 1>, "<string (branch name) 2>", <value or variable 2>, ... , "<string (branch name) n>", <value or variable n>

Parameters: value (0 to 9), variable (A to Z, *r*, *θ*)

Description:

- Each "<string (branch name) n>", <value or variable n> part is a branch set, and the entire branch set must be included.
- From two to nine branching sets can be included. An error occurs when there is only one or more than nine branching sets.
- Selecting a branch on the menu while the program is running jumps to the same type of label (Lbl *n*) as the one used in combination with the Goto command. Specifying "OK", 3" for the "<string (branch name) n>", <value or variable n>" part specifies a jump to Lbl 3.

Example: Lbl 2 ↵

Menu "IS IT DONE?", "OK", 1, "EXIT", 2 ↵

Lbl 1 ↵

"IT'S DONE !"

■ Clear Commands (CLR)

ClrGraph

Function: This command clears the graph screen.

Syntax: ClrGraph ↵

Description: This command clears the graph screen during program execution.

ClrList

Function: This command deletes list data.

Syntax: ClrList <list name>

ClrList

Parameters: list name: 1 to 26, Ans

Description: This command deletes the data in the list specified by “list name”. All list data is deleted if nothing is specified for “list name”.

ClrMat

Function: This command deletes matrix data.

Syntax: ClrMat <matrix name>

ClrMat

Parameters: matrix name: A to Z, Ans

Description: This command deletes the data in the matrix specified by “matrix name”. All matrix data is deleted if nothing is specified for “matrix name”.

ClrText

Function: This command clears the text screen.

Syntax: ClrText ↵

Description: This command clears text from the screen during program execution.

■ Display Commands (DISP)

DrawStat

Function: This draws a statistical graph.

Syntax: See “Using Statistical Calculations and Graphs in a Program” on page 6-28.

Description: This command draws a statistical graph in accordance with conditions defined within the program.

Input/Output Commands (I/O)

Getkey

Function: This command returns the code that corresponds to the last key pressed.

Syntax: Getkey ↵

Description:

- This command returns the code that corresponds to the last key pressed.

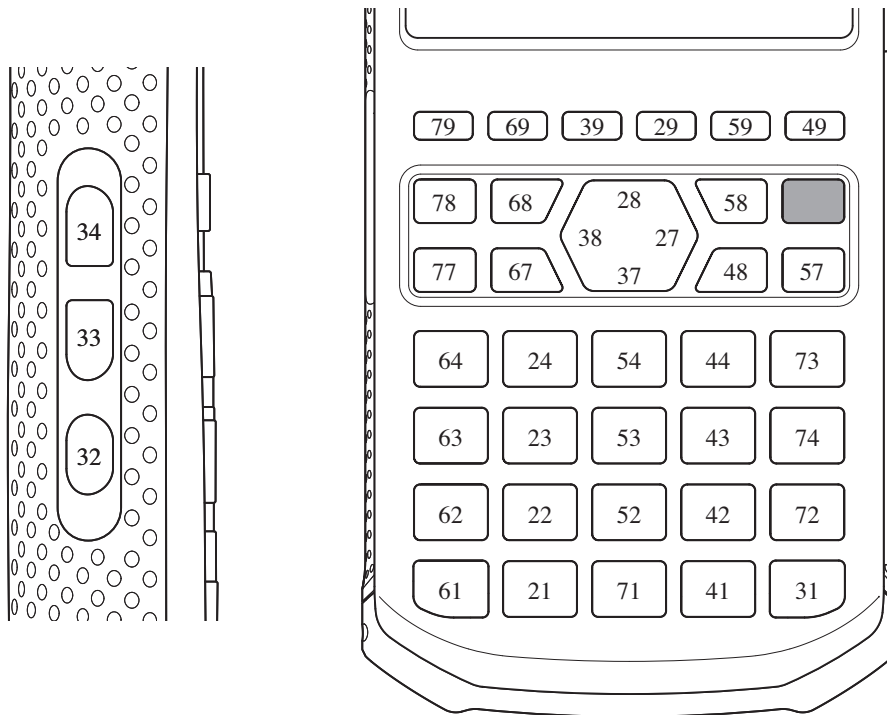

- A value of zero is returned if no key was pressed previous to executing this command.
- This command can be used inside of a loop.

Locate

Function: This command displays alpha-numeric characters at a specific location on the text screen.

Syntax: Locate <column number>, <line number>, <value>

Locate <column number>, <line number>, <numeric expression>

Locate <column number>, <line number>, "<string>"

[Example] Locate 1, 1, "AB" ↵

Parameters:

- line number: number from 1 to 7
- column number: number from 1 to 21
- value and numeric expression
- string: character string

Description:

- This command displays values (including variable contents) or text at a specific location on the text screen. If there is a calculation input, that calculation result is displayed.
- The line is designated by a value from 1 to 7, while the column is designated by a value from 1 to 21.

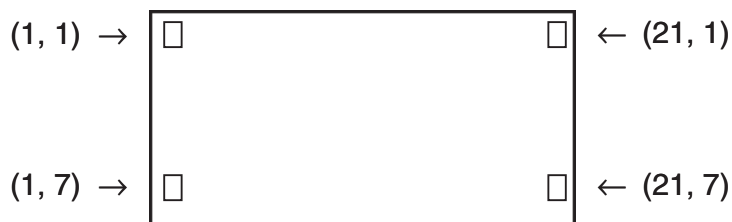

Example: Cls ←

Locate 7, 1, "CASIO FX"

This program displays the text "CASIO FX" in the center of the screen.

- In some cases, the ClrText command should be executed before running the above program.

■ Conditional Jump Relational Operators (REL)

=, ≠, >, <, ≥, ≤

Function: These relational operators are used in combination with the conditional jump command.

Syntax: <left side> <relational operator> <right side>

Parameters:

- left side/right side: variable (A to Z, r, θ), numeric constant, variable expression (such as: $A \times 2$)
- relational operator: =, ≠, >, <, ≥, ≤

■ Strings

A string is a series of characters enclosed in double quotes. In a program, strings are used to specify display text. A string made up of numbers (like "123") or an expression (like " $x-1$ ") cannot be processed as a calculation.

To display a string at a specific location on the screen, use the Locate command (page 6-19).

- To include double quotes (") or a backslash (\) in a string, put a backslash (\) in front of the double quotes (") or backslash (\).

Example 1: To include Japan: "Tokyo" in a string

"Japan:\"Tokyo\""

Example 2: To include main\abc in a string

"main\\abc"

You can input a backslash from the menu that appears when you press **F6** (CHAR) **F2** (SYBL) in the **PRGM** mode, or from the String category of the catalog that appears when you press **SHIFT** **0** (CATALOG).

- You can assign strings to string memory (Str 1 through Str 20). For details about strings, see "String Memory" (page 3-5).

- You can use the “+” command (page 6-22) to connect strings inside of an argument.
- A function or command within a string function (Exp(), StrCmp(), etc.) is treated as a single character. For example, the “sin” function is treated as a single character.

Exp(

Function: Converts a string to an expression, and executes the expression.

Syntax: Exp("<string>")]

Exp►Str(

Function: Converts an expression to a string and assigns it to the specified variable.

Syntax: Exp►Str(<formula>, <string variable name>)]

Description: Function memory (f_n) can be used as the first argument (<formula>).

StrCmp(

Function: Compares “<string 1>” and “<string 2>” (character code comparison).

Syntax: StrCmp("<string 1>", "<string 2>")]

Description: Compares two strings and returns one of the following values.

Returns 0 when “<string 1>” = “<string 2>”.

Returns 1 when “<string 1>” > “<string 2>”.

Returns -1 when “<string 1>” < “<string 2>”.

StrInv(

Function: Inverts the sequence of a string.

Syntax: StrInv("<string>")]

StrJoin(

Function: Joins “<string 1>” and “<string 2>”.

Syntax: StrJoin("<string 1>", "<string 2>")]

Note: The same result also can be achieved using the “+” command (page 6-22).

StrLeft(

Function: Copies a string up to the n th character from the left.

Syntax: StrLeft("<string>", n)] ($0 \leq n \leq 9999$, n is a natural number)

StrLen(

Function: Returns the length of a string (the number of its characters).

Syntax: StrLen("<string>")]

StrLwr(

Function: Converts all the characters of a string to lower case.

Syntax: StrLwr("<string>")]

StrMid(

Function: Extracts from the n -th to the m -th character of a string.

Syntax: StrMid("<string>", n [, m]) ($0 \leq n \leq 9999$, n is a natural number)

Description: Omitting " m " will extract from the n -th character to the end of the string.

StrRight(

Function: Copies a string up to the n th character from the right.

Syntax: StrRight("<string>", n []) ($0 \leq n \leq 9999$, n is a natural number)

StrRotate(

Function: Rotates the left side part and right side part of a string at the n th character.

Syntax: StrRotate("<string>", [, n]) ($-9999 \leq n \leq 9999$, n is an integer)

Description: Rotation is to the left when " n " is positive, and to the right when " n " is negative. Omitting " n " uses a default value of +1.

Example: StrRotate("abcde", 2) Returns the string "cdeab".

StrShift(

Function: Shifts a string left or right n characters.

Syntax: StrShift("<string>", [, n]) ($-9999 \leq n \leq 9999$, n is an integer)

Description: Shift is to the left when " n " is positive, and to the right when " n " is negative. Omitting " n " uses a default value of +1.

Example: StrShift("abcde", 2) Returns the string "cde".

StrSrc(

Function: Searches "<string 1>" starting from the specified point (n th character from beginning of string) to determine if it contains the data specified by "<string 2>". If the data is found, this command returns the location of the first character of "<string 2>", starting from the beginning of "<string 1>".

Syntax: StrSrc("<string 1>", "<string 2>"[, n]) ($0 \leq n \leq 9999$, n is a natural number)

Description: Omitting the start point causes the search to start from the beginning of "<string 1>".

StrUpr(

Function: Converts all the characters of a string to upper case.

Syntax: StrUpr("<string>"[])

+

Function: Joins "<string 1>" and "<string 2>".

Syntax: "<string 1>"+ "<string 2>"

Example: "abc"+"de"→Str 1..... Assigns "abcde" to Str 1.

■ CSV Access Commands

CSV access commands provide a means to directly load data into a program from a CSV file in storage memory or on an SD card.

- For sake of simplicity, the explanations in this section use numbers (1, 2, 3, etc.) for rows and letters (A, B, C, etc.) for columns. For example, the cell in the upper left corner of any CSV file (the first cell in the file) is Cell A1. The cell in the lower right corner of a 3 × 3 CSV file would be Cell C3.
- The term “next cell” is used to refer to the cell immediately to the right of the current cell. If the current cell is at the end of a row (the rightmost cell), the “next cell” is the first (leftmost) cell in the row below it.

The table below shows the six CSV access codes.

Command	Overview
CSVInfo	Gets the row count and column count of a CSV file and outputs the result in list format.
OpenCSV	Opens a CSV file.
CloseCSV	Closes the currently open CSV file.
LoadNextCell	Loading of CSV file data with CSV access commands is always performed in cell units. The first execution of the LoadNextCell command following the OpenCSV command makes the first cell of the file the load target cell. After that, each subsequent execution will sequentially switch the load target cell to the next cell. Each execution of this command gets the attribute data of the load target cell and outputs it in list format.
GetCellValue	Gets the data in the current load target cell and outputs it as a value.
GetCellString	Gets the data in the current load target cell and outputs it as a text string.

The rough flow for a program would be as shown below.

OpenCSV: To open the CSV file

LoadNextCell: To specify the load target cell

GetCellValue; GetCellString: To get the cell data

CloseCSV: To close the CSV file

CSV File Handling Precautions

Note the following precautions whenever handling CSV files with CSV access commands.

- Specification of a comma (,) or semicolon (;) as the delimiter symbol, and a period (.) or comma (,) as the decimal point symbol is in accordance with the calculator’s “CSV Separator” and “CSV Decimal Symbol” setting. For details, refer to “Specifying the CSV File Delimiter Symbol and Decimal Point” (page 4-15).
- CR, LF, and CRLF in a CSV file are all recognized as line feed codes.
- Single spaces and tab operations at the beginning of rows, before or after delimiter symbols, and before line feeds, and multiple spaces and tabs in a CSV file are ignored.

- Anything in a CSV file between a pair of quotation marks (" "), between quotation marks (") and a line feed, or between quotation marks (") and the end of a file is treated as a text string. Any delimiter symbol within a text string range is ignored.

CSVInfo

Function: Gets the row count and column count of the CSV file specified by the path and file name and outputs the result in list format.

Syntax: CSVInfo "<path>\<filename>"

Example: CSVInfo "SMEM:\Data0827.csv"→List 1

The above gets the row count and column count of the file named "Data0827.csv", which is located in the storage memory root directory, and outputs the result to List 1 in the format {row count, column count}.

CSVInfo "SD:\FOLDER1\Data0827.csv"→List 1

The above gets the row count and column count of the file named "Data0827.csv", which is located in FOLDER1 of the SD card, and outputs the result to List 1 in the format {row count, column count}.

Description:

- If the CSV file contains rows of different lengths (different number of columns), the number of columns value produced by this command will be for the longest line.
- This command cannot be used to access a CSV file that is currently open with the OpenCSV command.

OpenCSV

Function: Opens the CSV file specified by the path and file name (including extension).

Syntax: OpenCSV "<path>\<filename>"

Example: OpenCSV "SMEM:\Data0827.csv"

OpenCSV "SD:\FOLDER1\Data0827.csv"

Description:

- A CSV file must be opened with this command in order to load data from the file.
- A file with a file name extension other than .csv (such as .txt) can be specified with this command as long as it is a text file that includes delimiter symbols and line feed codes.
- Opening multiple instances of the same file and opening multiple CSV files at the same time are not supported. To re-open the currently opened CSV file, first be sure to execute the CloseCSV command then execute the OpenCSV command.

CloseCSV

Function: Closes the currently open CSV file.

Syntax: CloseCSV

Description: This command is used in combination with the OpenCSV command. The currently open CSV file is forced to close automatically when a program ends, even if CloseCSV is not executed.

LoadNextCell

Function: Switches the load target cell of the CSV file to the next cell, and outputs attribute information of the new load target cell in list format.

Syntax: LoadNextCell

Example: LoadNextCell→List 20

Description:

- After opening a CSV file with OpenCSV, this command must be executed once before using GetCellValue or GetCellString to get data from a file. Executing this command after opening a CSV file uses the first cell in the file as the data load target. After that, each executing shift the load focus to the next cell.
- Each execution of this command outputs the attributes of the load target cell in the following list format {status, row number, column number}. Status is assigned one of the integers described below.

0: Null data; 1: Value; 2: Text string (non-value data); -1: File end

-1 (file end) is returned when LoadNextCell is executed while the load target cell is last cell (in a 3×3 CSF file, for example, Cell C3) in the CSF file. Executing LoadNextCell again after file end is returned results in an error (Range ERROR).

GetCellValue

Function: Gets the data in the load target cell in the CSV file and outputs it as a value.

Syntax: GetCellValue

Example: GetCellValue→List 1[N]

The above gets the data of the load target cell and assigns the value to the *n*th element in List 1.

Description: Executing this command when the data of the load target cell is not value data or null data results in an error (Data ERROR).

GetCellString

Function: Gets the data in the load target cell in the CSV file and outputs it as a text string.

Syntax: GetCellString

Example: GetCellString→Str 1

The above gets the data of the load target cell and assigns it to Str1 as a text string.

Description: Executing this command when the data of the load target cell is value data does not result in an error.

6. Using Calculator Functions in Programs

■ Text Display

You can include text in a program by simply enclosing it between double quotation marks. Such text appears on the display during program execution, which means you can add labels to input prompts and results.

Program	Display
"CASIO"	CASIO
? → X	?
"X =" ? → X	X = ?

- If the text is followed by a calculation formula, be sure to insert a display command (▲) between the text and calculation.
- Inputting more than 21 characters causes the text to move down to the next line. The screen scrolls automatically if the text exceeds 21 characters.
- You can specify up to 255 bytes of text for a comment.

■ Using Matrix Row Operations in a Program

These commands let you manipulate the rows of a matrix in a program.

- For this program, enter the **RUN•MAT** mode and then use the Matrix Editor to input the matrix, and then enter the **PRGM** mode to input the program.

• To swap the contents of two rows (Swap)

Example 1 To swap the values of Row 2 and Row 3 in the following matrix:

$$\text{Matrix A} = \begin{bmatrix} 1 & 2 \\ 3 & 4 \\ 5 & 6 \end{bmatrix}$$

The following is the syntax to use for this program.

Swap A, 2, 3 ←
┌───┬───┬───┐
└───┴───┴───┘ Rows to be swapped
└──────────┘ Matrix name
Mat A

Executing this program produces the following result.

Ans	1	2
1	1	2
2	5	6
3	3	4

- **To calculate a scalar multiplication (* Row)**

Example 2 To calculate the product of Row 2 of the matrix in Example 1 and the scalar 4

The following is the syntax to use for this program.

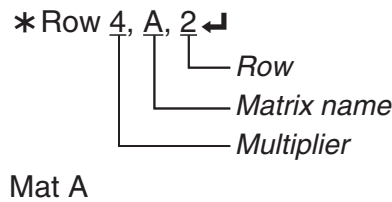

- **To calculate a scalar multiplication and add the results to another row (*Row+)**

Example 3 To calculate the product of Row 2 of the matrix in Example 1 and the scalar 4, then add the result to row 3

The following is the syntax to use for this program.

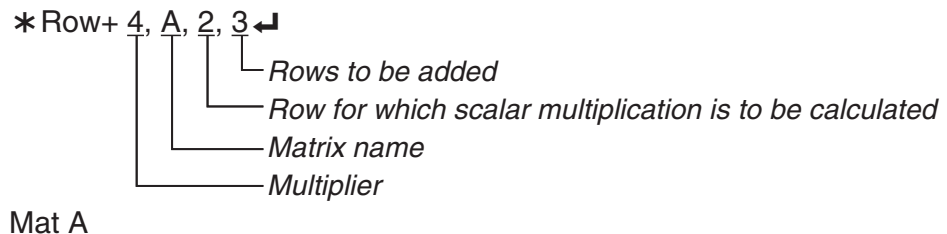

- **To add two rows (Row+)**

Example 4 To add Row 2 to Row 3 of the matrix in Example 1

The following is the syntax to use for this program.

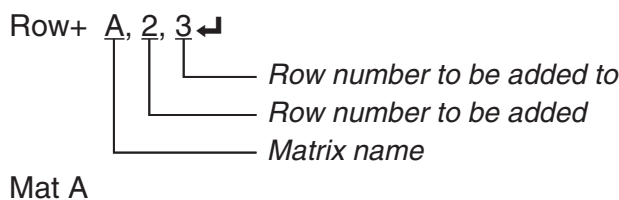

■ Using List Sort Functions in a Program

These functions let you sort data in lists into ascending or descending order.

- Ascending order

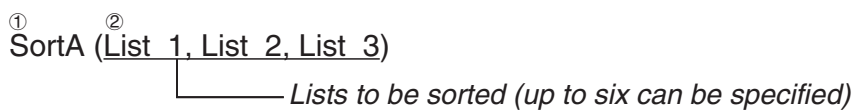

- Descending order

③ SortD (List 1, List 2, List 3)
 └── Lists to be sorted (up to six can be specified)

③ **F4** **F3** **F2**

■ Using Statistical Calculations and Graphs in a Program

Including statistical calculations and graphing operations in a program lets you calculate and graph statistical data.

• To set conditions and draw a statistical graph

Following a StatGraph command (“S-Gph1”, “S-Gph2”, or “S-Gph3”), you must specify the following graph conditions:

- Graph draw/non-draw status (DrawOn/DrawOff)
- Graph Type
- x-axis data location (list name)
- y-axis data location (list name)
- Frequency data location (list name)
- Mark Type
- Pie graph display setting (% or Data)
- Pie graph percentage data storage list specification (None or list name)
- First bar graph data (list name)
- Second and third bar graph data (list name)
- Bar graph orientation (Length or Horizontal)

The graph conditions that are required depends on the graph type. See “Changing Graph Parameters” (page 5-1).

- The following is a typical graph condition specification for a scatter diagram or *xy* line graph.

S-Gph1 DrawOn, Scatter, List 1, List 2, 1, Square ◀

In the case of an *xy* line graph, replace “Scatter” in the above specification with “*xy*Line”.

- The following is a typical graph condition specification for a normal probability plot.

S-Gph1 DrawOn, NPPlot, List 1, Square ◀

- The following is a typical graph condition specification for a single-variable graph.

S-Gph1 DrawOn, Hist, List 1, List 2 ◀

The same format can be used for the following types of graphs, by simply replacing “Hist” in the above specification with the applicable graph type.

Histogram Hist Normal Distribution N-Dist

Median Box MedBox*1 Broken Line Broken

*1 Outliers:On

Outliers:Off

S-Gph1 DrawOn, MedBox, List 1, 1, 1 S-Gph1 DrawOn, MedBox, List 1, 1, 0

- The following is a typical graph condition specification for a regression graph.

S-Gph1 DrawOn, Linear, List 1, List 2, List 3 ↵

The same format can be used for the following types of graphs, by simply replacing “Linear” in the above specification with the applicable graph type.

Linear Regression	Linear	Logarithmic Regression	Log
Med-Med.....	Med-Med	Exponential Regression	$\text{Exp}(a \cdot e^{bx})$
Quadratic Regression	Quad		$\text{Exp}(a \cdot b^x)$
Cubic Regression	Cubic	Power Regression	Power
Quartic Regression	Quart		

- The following is a typical graph condition specification for a sinusoidal regression graph.

S-Gph1 DrawOn, Sinusoidal, List 1, List 2 ↵

- The following is a typical graph condition specification for a logistic regression graph.

S-Gph1 DrawOn, Logistic, List 1, List 2 ↵

- The following is a typical graph condition specification for a pie graph.

S-Gph1 DrawOn, Pie, List 1, %, None ↵

- The following is a typical graph condition specification for a bar graph.

S-Gph1 DrawOn, Bar, List 1, None, None, StickLength ↵

- To draw a statistical graph, insert the “DrawStat” command following the graph condition specification line.

```
ClrGraph
S-WindAuto
{1, 2, 3} → List 1
{1, 2, 3} → List 2
S-Gph1 DrawOn, Scatter, List 1, List 2, 1, Square ↵
DrawStat
```

■ Performing Statistical Calculations in a Program

- Single-variable statistical calculation

① 1-Variable List1, List 2
└── Frequency data (Frequency)
└── x-axis data (XList)

① **F4** **F1** **F6** **F1**

- Paired-variable statistical calculation

① 2-Variable List 1, List 2, List 3
└── Frequency data (Frequency)
└── y-axis data (YList)
└── x-axis data (XList)

① **F4** **F1** **F6** **F2**

- Regression statistical calculation

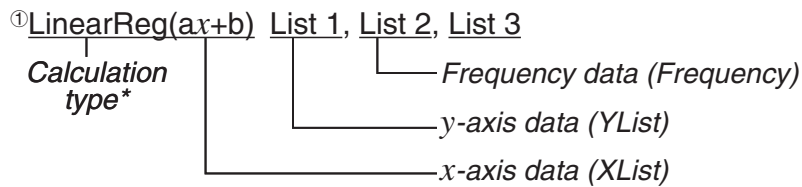

① **F4** **F1** **F6** **F6** **F1** **F1**

* Any one of the following can be specified as the calculation type.

- LinearReg(ax+b).....linear regression ($ax+b$ type)
- LinearReg(a+bx).....linear regression ($a+bx$ type)
- Med-MedLineMed-Med calculation
- QuadRegquadratic regression
- CubicRegcubic regression
- QuartRegquartic regression
- LogReglogarithmic regression
- ExpReg($a \cdot e^{bx}$).....exponential regression ($a \cdot e^{bx}$ type)
- ExpReg($a \cdot b^x$).....exponential regression ($a \cdot b^x$ type)
- PowerRegpower regression

- Sinusoidal regression statistical calculation

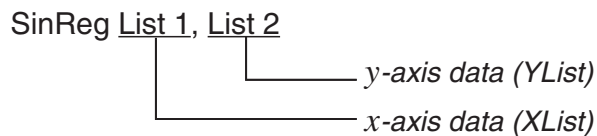

- Logistic regression statistical calculation

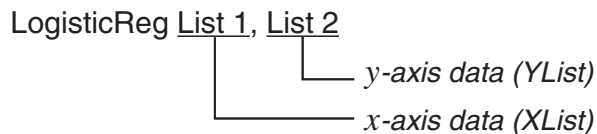

7. PRGM Mode Command List

Not all of the commands listed below are available on all models covered by this manual.

RUN Program

[F4] (MENU) key			
Level 1	Level 2	Level 3	Command
STAT	DRAW	On	DrawOn
		Off	DrawOff
	GRPH	GPH1	S-Gph1_
		GPH2	S-Gph2_
		GPH3	S-Gph3_
		Scat	Scatter
		xy	xyLine
		Hist	Hist
		Box	MedBox
		Bar	Bar
		N-Dis	N-Dist
		Brkn	Broken
		X	Linear
		Med	Med-Med
		X^2	Quad
		X^3	Cubic
		X^4	Quart
		Log	Log
			*1
		Pwr	Power
		Sin	Sinusoidal
		NPP	NPPlot
	Lgst	Logistic	
	Pie	Pie	
	List	List_	
	TYPE	*2	
	CALC	1VAR	1-Variable_
		2VAR	2-Variable_
			*3
		Med	Med-MedLine_
		X^2	QuadReg_
		X^3	CubicReg_
		X^4	QuartReg_
Log		LogReg_	
	*4		
Pwr	PowerReg_		
Sin	SinReg_		
Lgst	LogisticReg_		
MAT	Swap	Swap_	
	xRw	*Row_	
	xRw+	*Row+_	
	Rw+	Row+_	
LIST	Srt-A	SortA(
	Srt-D	SortD(
CSV	Open	OpenCSV_	
	Close	CloseCSV	
	Load	LoadNextCell	
	GetV	GetCellValue	
	GetS	GetCellString	
	Info	CSVInfo_	
	:	:	
\	\		

[OPTN] key				
Level 1	Level 2	Level 3	Command	
LIST	List		List_	
	L→M		List→Mat(
	Dim		Dim_	
	Fill		Fill(
	Seq		Seq(
	Min		Min(
	Max		Max(
	Mean		Mean(
	Med		Median(
	Aug		Augment(
	Sum		Sum_	
	Prod		Prod_	
	Cuml		Cuml_	
	%		Percent_	
	∠		∠List_	
	MAT	Mat		Mat_
		M→L		Mat→List(
		Det		Det_
		Trn		Trn_
		Aug		Augment(
Iden			Identity_	
Dim			Dim_	
Fill			Fill(
Ref			Ref_	
Rref			Rref_	
CPLX		i		i
		Abs		Abs_
		Arg		Arg_
		Conj		Conjg_
	ReP		ReP_	
	ImP		ImP_	
	►r∠θ		►r∠θ	
	►a+bi		►a+bi	
	CALC	Solve		Solve(
		d/dx		d/dx(
d ² /dx ²			d ² /dx ² (
∫dx			∫(
SolvN			SolveN(
FMin			FMin(
FMax			FMax(
Σ(Σ(
log _a b			log _a b(
Int÷			_Int÷_	
Rmdr			_Rmdr_	
Simp			►Simp_	
STAT		χ̂		χ̂
		ŷ		ŷ
	S-Dev		StdDev(
	Var		Variance(
CONV	►		►	
	LENG	fm	[fm]	

	Å	[Å]	
	µm	[µm]	
	mm	[mm]	
	cm	[cm]	
	m	[m]	
	km	[km]	
	AU	[AU]	
	l.y.	[l.y.]	
	pc	[pc]	
	Mil	[Mil]	
	in	[in]	
	ft	[ft]	
	yd	[yd]	
	fath	[fath]	
	rd	[rd]	
	mile	[mile]	
	n mile	[n mile]	
	AREA	cm ²	[cm ²]
		m ²	[m ²]
ha		[ha]	
km ²		[km ²]	
in ²		[in ²]	
ft ²		[ft ²]	
yd ²		[yd ²]	
acre		[acre]	
mile ²		[mile ²]	
mu(CN)		[mu(CN)]	
VLUM		cm ³	[cm ³]
	mL	[mL]	
	L	[L]	
	m ³	[m ³]	
	in ³	[in ³]	
	ft ³	[ft ³]	
	fl_oz(UK)	[fl_oz(UK)]	
	fl_oz(US)	[fl_oz(US)]	
	gal(US)	[gal(US)]	
	gal(UK)	[gal(UK)]	
	pt	[pt]	
	qt	[qt]	
	tsp	[tsp]	
	tbsp	[tbsp]	
cup	[cup]		
TIME	ns	[ns]	
	µs	[µs]	
	ms	[ms]	
	s	[s]	
	min	[min]	
	h	[h]	
	day	[day]	
	week	[week]	
	yr	[yr]	
s-yr	[s-yr]		
t-yr	[t-yr]		
TMPR	°C	[°C]	

	K	[K]
	°F	[°F]
	°R	[°R]
VELO	m/s	[m/s]
	km/h	[km/h]
	knot	[knot]
	ft/s	[ft/s]
	mile/h	[mile/h]
MASS	u	[u]
	mg	[mg]
	g	[g]
	kg	[kg]
	mton	[mton]
	oz	[oz]
	lb	[lb]
	slug	[slug]
	ton(short)	[ton(short)]
	ton(long)	[ton(long)]
FORC	N	[N]
	lbf	[lbf]
	tonf	[tonf]
	dyne	[dyne]
PRES	kgf	[kgf]
	Pa	[Pa]
	kPa	[kPa]
	mmH ₂ O	[mmH ₂ O]
	mmHg	[mmHg]
	atm	[atm]
	inH ₂ O	[inH ₂ O]
	inHg	[inHg]
	lbf/in ²	[lbf/in ²]
	bar	[bar]
ENGY	kgf/cm ²	[kgf/cm ²]
	eV	[eV]
	J	[J]
	cal _{th}	[cal _{th}]
	cal ₁₅	[cal ₁₅]
	cal _{IT}	[cal _{IT}]
	kcal _{th}	[kcal _{th}]
	kcal ₁₅	[kcal ₁₅]
	kcal _{IT}	[kcal _{IT}]
	l-atm	[l-atm]
	kW·h	[kW·h]
	ft·lbf	[ft·lbf]
	Btu	[Btu]
PWR	erg	[erg]
	kgf·m	[kgf·m]
	W	[W]
	cal _{th} /s	[cal _{th} /s]
	hp	[hp]
HYP	ft·lbf/s	[ft·lbf/s]
	Btu/min	[Btu/min]
	sinh	sinh
	cosh	cosh
	tanh	tanh
PROB	sinh ⁻¹	sinh ⁻¹
	cosh ⁻¹	cosh ⁻¹
	tanh ⁻¹	tanh ⁻¹
	x!	!
nPr	P	
nCr	C	

RAND	Ran#	Ran#	
	Int	RanInt#(
	Norm	RanNorm#(
	Bin	RanBin#(
	List	RanList#(
	P(P(
	Q(Q(
	R(R(
	t(t(
	NUM	Abs	Abs
Int		Int	
Frac		Frac	
Rnd		Rnd	
Intg		Intg	
RndFi		RndFix(
GCD		GCD(
LCM		LCM(
MOD		MOD(
MOD·E		MOD_Exp(
ANGL		°	°
		r	r
		g	g
	° ' "	□	
	Pol(Pol(
	Rec(Rec(
	►DMS	►DMS	
	ESYM	m	m
		μ	μ
		n	n
p		p	
f		f	
k		k	
M		M	
G		G	
T		T	
P		P	
PICT	E	E	
	Sto	StoPic	
Rcl	RclPic		
FMEM	fn	fn	
	LOGIC	And	_And
Or		_Or	
Not		Not	
Xor		_Xor	

SHIFT OPTN (VARS) key				
Level 1	Level 2	Level 3	Command	
V-WIN	X	min	Xmin	
		max	Xmax	
		scal	Xscl	
		dot	Xdot	
		Y	min	Ymin
	FACT	Y	max	Ymax
			scal	Yscl
			Xfct	Xfct
			Yfct	Yfct
			STAT	X
\bar{x}	\bar{x}			
Σx	Σx			

		Σx^2	Σx^2		
		σ_x	σ_x		
		Sx	Sx		
		minX	minX		
		maxX	maxX		
		Y		\bar{y}	\bar{y}
Σy	Σy				
Σy^2	Σy^2				
Σxy	Σxy				
σ_y	σ_y				
Sy	Sy				
minY	minY				
maxY	maxY				
GRPH				a	a
				b	b
		c	c		
		d	d		
		e	e		
		r	r		
		r ²	r ²		
		MSe	MSe		
		Q ₁	Q ₁		
		Med	Med		
		Q ₃	Q ₃		
		Mod	Mod		
		Strt	H_Start		
Pitch	H_pitch				
PTS		x ₁	x ₁		
		y ₁	y ₁		
		x ₂	x ₂		
		y ₂	y ₂		
		x ₃	x ₃		
		y ₃	y ₃		
Str		Str			

SHIFT PROG (PRGM) key			
Level 1	Level 2	Level 3	Command
COM	If		If
		Then	Then
		Else	Else
		l-End	IfEnd
		For	For
		To	_To
		Step	_Step
		Next	Next
		Whle	While
		WEnd	WhileEnd
		Do	Do
		Lp-W	LpWhile
		CTL	Prog
Rtrn	Return		
Brk	Break		
Stop	Stop		
JUMP	Lbl		Lbl
		Goto	Goto
		⇒	⇒
		lsz	lsz
Dsz	Dsz		

	Menu		Menu_
?			?
▲			▲
CLR	Text		ClrText
	Grph		ClrGraph
	List		ClrList_
	Mat		ClrMat_
DISP	Stat		DrawStat
REL	=		=
	≠		≠
	>		>
	<		<
	≥		≥
	≤		≤
I/O	Lcte		Locate_
	Gtkey		Getkey
:			:
STR	Join		StrJoin(
	Len		StrLen(
	Cmp		StrCmp(
	Src		StrSrc(
	Left		StrLeft(
	Right		StrRight(
	Mid		StrMid(
	E▶S		Exp▶Str(
	Exp		Exp(
	Upr		StrUpr(
	Lwr		StrLwr(
	Inv		StrInv(
Shift		StrShift(
Rot		StrRotate(

SHIFT MENU (SET UP) key				
Level 1	Level 2	Level 3	Command	
ANGL	Deg		Deg	
	Rad		Rad	
	Gra		Gra	
COORD	On		CoordOn	
	Off		CoordOff	
GRID	On		GridOn	
	Off		GridOff	
AXES	On		AxesOn	
	Off		AxesOff	
LABL	On		LabelOn	
	Off		LabelOff	
DISP	Fix		Fix_	
	Sci		Sci_	
	Norm		Norm_	
	Eng	On		EngOn
		Off		EngOff
Eng		Eng		
S/L	—		S-L-Normal	
	—		S-L-Thick	
		S-L-Broken	
		S-L-Dot	
BACK	None		BG-None	
	Pict		BG-Pict_	
FUNC	On		FuncOn	
	Off		FuncOff	

S-WIN	Auto		S-WindAuto
	Man		S-WindMan
LIST	File		File_
RESID	None		Resid-None
	List		Resid-List_
CPLX	Real		Real
	a+bi		a+bi
	r∠θ		r∠θ
FRAC	d/c		d/c
	ab/c		ab/c
SIMP	Auto		SimplifyAuto
	Man		SimplifyMan
Q1Q3	Std		Q1Q3TypeStd
	OnD		Q1Q3TypeOnData

SHIFT key				
Level 1	Level 2	Level 3	Command	
ZOOM	Fact		Factor_	
V-WIN	V-Win		ViewWindow_	
	Sto		StoV-Win_	
	Rcl		RclV-Win_	
SKTCH	Cls		Cls	
	PLOT	Plot		Plot_
		Pl-On		PlotOn_
		Pl-Off		PlotOff_
		Pl-Chg		PlotChg_
	LINE	Line		Line
		F-Line		F-Line_
	Crcl		Circle_	
	Vert		Vertical_	
	Hztl		Horizontal_	
Text		Text_		
PIXL	On		PxlOn_	
	Off		PxlOff_	
	Chg		PxlChg_	
Test			PxlTest(
	---		SketchNormal_	
	---		SketchThick_	
		SketchBroken_	
		SketchDot_	

BASE Program

F4 (MENU) key				
Level 1	Level 2	Level 3	Command	
d~o	d		d	
	h		h	
	b		b	
	o		o	
LOG	Neg		Neg_	
	Not		Not_	
	and		and	
	or		or	
	xor		xor	
	xnor		xnor	
	DISP	▶Dec		▶Dec
		▶Hex		▶Hex

	▶Bin		▶Bin
	▶Oct		▶Oct
HEX	A		A
	B		B
	C		C
	D		D
	E		E
	F		F

SHIFT PROG (PRGM) key			
Level 1	Level 2	Level 3	Command
Prog			Prog_
JUMP	Lbl		Lbl_
	Goto		Goto_
	⇒		⇒
	lsz		lsz_
	Dsz		Dsz_
Menu			Menu_
?			?
▲			▲
REL	=		=
	≠		≠
	>		>
	<		<
	≥		≥
	≤		≤
:			:

SHIFT MENU (SET UP) key			
Level 1	Level 2	Level 3	Command
Dec			Dec
Hex			Hex
Bin			Bin
Oct			Oct

	Level 3	Level 4	Command
*1	Exp	ae^bx	Exp(a•e^bx)
		ab^x	Exp(a•b^x)
*2	MARK	▣	Square
		x	Cross
		▣	Dot
	STICK	Leng	StickLength
		Hztl	StickHoriz
	%DATA	%	%
Data		Data	
None		None	
		None	
*3	X	ax+b	LinearReg(ax+b)
		a+bx	LinearReg(a+bx)
*4	EXP	ae^bx	ExpReg(a•e^bx)
		ab^x	ExpReg(a•b^x)

8. CASIO Scientific Function Calculator Special Commands ⇔ Text Conversion Table

The table below shows the special text strings that correspond to commands when converting between programs and text files. For details about the operations for converting between programs and text files, see “Converting Programs and Text Files” (page 6-7).

Important!

- Converting a program that contains the types of commands described below to a text file will cause the commands to be converted to text strings with underbar (_) characters appended at the beginning and end, as shown in the table below.
 - A command enclosed in quotation marks (" ")
 - A command in a comment line, which is a line that begins with a single quotation mark (')

Note that non-command alpha-numeric characters in a program that are enclosed in quotation marks (" ") or are in a comment line are output to the text file as-is.

Example:

In the program:	In the text file (after conversion):
"θ"	"_Theta_"
"Theta"*1	"Theta"
"or"*2	"_or_"
"or"*1	"or"

*1 Non-command alpha-numeric characters

*2 Logical operator or

Converting from a text file to a program converts the special character strings back to their corresponding commands, shown above.

- When converting a program that contains special characters input using **F6** (CHAR) when editing the program on the calculator, the special characters will be converted to character string codes as shown below.

Example:

In the program:	In the text file (after conversion):
Λ	#E54A
□	#E5A5
β	#E641
▲	#E69C
⇔	#E6D6

These codes are not included in the tables on the pages 6-35 through 6-38.

* "□" in the following tables indicates a space.

Command	Text
f	femto
p	pico
n	nano
μ	micro
m	milli
k	kilo
M	Mega
G	Giga
T	Tera
P	Peta
E	Exa
▲	Disps
␣	(CR)
→	->
E	Exp
≤	<=
≠	<>
≥	>=
⇒	=>
f ₁	f1
f ₂	f2
f ₃	f3
f ₄	f4
f ₅	f5
f ₆	f6
A	&HA
B	&HB
C	&HC
D	&HD
E	&HE
F	&HF
□	□
!	Char!
"	"
#	#
\$	\$
%	%
&	&
,	,
((
))
*	**
+	++
,	,
-	Char-
.	.
/	//
0	0
1	1
2	2
3	3
4	4
5	5
6	6

Command	Text
7	7
8	8
9	9
:	:
;	;
<	<
=	=
>	>
?	?
@	@
A	A
B	B
C	C
D	D
E	E
F	F
G	G
H	H
I	I
J	J
K	K
L	L
M	M
N	N
O	O
P	P
Q	Q
R	R
S	S
T	T
U	U
V	V
W	W
X	X
Y	Y
Z	Z
[[
\	¥
]]
^	^^
_	_
,	,
a	a
b	b
c	c
d	d
e	e
f	f
g	g
h	h
i	i
j	j
k	k
l	l

Command	Text
m	m
n	n
o	o
p	p
q	q
r	r
s	s
t	t
u	u
v	v
w	w
x	x
y	y
z	z
{	{
}	}
~	~
Pol(Pol(
sin□	sin□
cos□	cos□
tan□	tan□
h	&h
ln□	ln□
√	Sqrt
-	(-)
P	nPr
+	+
xnor	xnor
²	^<2>
□	dms
∫(Integral(
Mod	Mod
Σx²	Sigmax^2
sin ⁻¹ □	sin ⁻¹ □
cos ⁻¹ □	cos ⁻¹ □
tan ⁻¹ □	tan ⁻¹ □
d	&d
log□	log□
³√	Cbrt
Abs□	Abs□
¢	nCr
-	-
xor	xor
⁻¹	^-1
°	deg
Med	Med
Σx	Sigmax
Rec(Rec(
sinh□	sinh□
cosh□	cosh□
tanh□	tanh□
o	&o
e^	e^

Command	Text
Int□	Int□
Not□	Not□
^	^
x	*
or	or
!	!
r	rad
minY	minY
minX	minX
n	Statn
\sinh^{-1} □	\sinh^{-1} □
\cosh^{-1} □	\cosh^{-1} □
\tanh^{-1} □	\tanh^{-1} □
b	&b
¹⁰	(10)
Frac□	Frac□
Neg□	Neg□
$\sqrt[x]{}$	Xrt
÷	/
and	and
┘	frac
^g	gra
maxY	maxY
maxX	maxX
Σy^2	Sigmay2
Ans	Ans
Ran#□	Ran#
\bar{x}	x-bar
\bar{y}	y-bar
σ_x	sigmax
sx	Sx
σ_y	sigmay
sy	Sy
a	Regression_a
b	Regression_b
r	Regression_r
\hat{x}	x-hat
\hat{y}	y-hat
r	<r>
θ	Theta
Σy	Sigmay
π	pi
Cls	Cls
Rnd	Rnd
Dec	&D
Hex	&H
Bin	&B
Oct	&O
Norm□	Norm□
Deg	Deg
Rad	Rad
Gra	Gra
Eng	Eng
Intg□	Intg□
Σxy	Sigmaxy

Command	Text
Plot□	Plot□
Line	Line
Lbl□	Lbl□
Fix□	Fix□
Sci□	Sci□
Dsz□	Dsz□
Isz□	Isz□
Factor□	Factor□
ViewWindow□	ViewWindow□
Goto□	Goto□
Prog□	Prog□
,	Para,
P(ProbP(
Q(ProbQ(
R(ProbR(
t(Probt(
Xmin	Xmin
Xmax	Xmax
Xscl	Xscl
Ymin	Ymin
Ymax	Ymax
Yscl	Yscl
Xfct	Xfct
Yfct	Yfct
c	Regression_c
d	Regression_d
e	Regression_e
Max(Max(
Det□	Det□
Arg□	Arg□
Conjg□	Conjg□
ReP□	ReP□
ImP□	ImP□
d/dx(d/dx(
d ² /dx ² (d ² /dx ² (
Solve(Solve(
Σ (Sigma(
FMin(FMin(
FMax(FMax(
Seq(Seq(
Min(Min(
Mean(Mean(
Median(Median(
SolveN(SolveN(
MOD(MOD(
MOD_Exp(MOD_Exp(
GCD(GCD(
LCM(LCM(
StdDev(StdDev(
Variance(Variance(
Mat□	Mat□
Trn□	Trn□
*Row□	*Row□
*Row+□	*Row+□
Row+□	Row+□

Command	Text
Swap□	Swap□
Dim□	Dim□
Fill(Fill(
Identity□	Identity□
Augment(Augment(
List→Mat(List->Mat(
Mat→List(Mat->List(
Sum□	Sum□
Prod□	Prod□
Percent□	Percent□
Cuml□	Cuml□
i	Imaginary
List□	List□
Δ List□	Dlist□
∞	Infinity
\sphericalangle	Angle
Ref□	Ref□
Rref□	Rref□
►	Conv
List1	List1
List2	List2
List3	List3
List4	List4
List5	List5
List6	List6
Q1	Q1
Q3	Q3
x1	x1
y1	y1
x2	x2
y2	y2
x3	x3
y3	y3
logab(logab(
RndFix(RndFix(
RanInt#(RanInt#(
RanList#(RanList#(
RanBin#(RanBin#(
RanNorm#(RanNorm#(
Getkey	Getkey
H□Start	H□Start
H□pitch	H□pitch
►Simp□	>Simp
□And□	□And□
□Or□	□Or□
Not□	□Not□
□Xor□	□Xor□
□Int÷□	□Int/□
□Rmndr□	□Rmndr□
CellSum(CellSum(
CellProd(CellProd(
CellMin(CellMin(
CellMax(CellMax(
CellMean(CellMean(
CellMedian(CellMedian(

Command	Text
CellIf(CellIf(
[ns]	[ns]
[μs]	[micros]
[ms]	[ms]
[s]	[s]
[min]	[min]
[h]	[h]
[day]	[day]
[week]	[week]
[yr]	[yr]
[s-yr]	[s-yr]
[t-yr]	[t-yr]
[°C]	[Centigrade]
[K]	[Kel]
[°F]	[Fahrenheit]
[°R]	[Rankine]
[u]	[u]
[g]	[g]
[kg]	[kg]
[lb]	[lb]
[oz]	[oz]
[slug]	[slug]
[ton(short)]	[ton(short)]
[ton(long)]	[ton(long)]
[mton]	[mton]
[l-atm]	[l-atm]
[ft·lbf]	[ftlbf]
[calIT]	[callT]
[calth]	[calth]
[Btu]	[Btu]
[kW·h]	[kWh]
[kgf·m]	[kgfm]
[Pa]	[Pa]
[kPa]	[kPa]
[bar]	[bar]
[mmH ₂ O]	[mmH2O]
[mmHg]	[mmHg]
[inH ₂ O]	[inH2O]
[inHg]	[inHg]
[lbf/in ²]	[lbf/in^2]
[kgf/cm ²]	[kgf/cm^2]
[atm]	[atm]
[dyne]	[dyne]
[N]	[New]
[kgf]	[kgf]
[lbf]	[lbf]
[tonf]	[tonf]
[fm]	[fm]
[mm]	[mm]
[cm]	[cm]
[m]	[m]
[km]	[km]
[Mil]	[Mil]
[in]	[in]
[ft]	[ft]

Command	Text
[yd]	[yd]
[fath]	[fath]
[rd]	[rd]
[mile]	[mile]
[n_mile]	[n_mile]
[acre]	[acre]
[ha]	[ha]
[cm ²]	[cm^2]
[m ²]	[m^2]
[km ²]	[km^2]
[in ²]	[in^2]
[ft ²]	[ft^2]
[yd ²]	[yd^2]
[mile ²]	[mile^2]
[μ(CN)]	[mu(CN)]
[m/s]	[m/s]
[km/h]	[km/h]
[ft/s]	[ft/s]
[mile/h]	[mile/h]
[knot]	[knot]
[mL]	[mL]
[L]	[Lit]
[tsp]	[tsp]
[cm ³]	[cm^3]
[m ³]	[m^3]
[tbsp]	[tbsp]
[in ³]	[in^3]
[ft ³]	[ft^3]
[fl_oz(UK)]	[fl_oz(UK)]
[fl_oz(US)]	[fl_oz(US)]
[cup]	[cup]
[pt]	[pt]
[qt]	[qt]
[gal(US)]	[gal(US)]
[gal(UK)]	[gal(UK)]
[μm]	[microm]
[mg]	[mg]
[Å]	[Ang]
[AU]	[AstU]
[l.y.]	[l.y.]
[pc]	[pc]
[ft·lbf/s]	[ftlbf/s]
[calth/s]	[calth/s]
[hp]	[hp]
[Btu/min]	[Btu/min]
[W]	[Wat]
[eV]	[eV]
[erg]	[erg]
[J]	[Jou]
[cal ₁₅]	[cal15]
[kcal ₁₅]	[kcal15]
[kcalth]	[kcalth]
[kcalIT]	[kcallT]
If□	If□
Then□	Then□

Command	Text
Else□	Else□
IfEnd	IfEnd
For□	For□
□To□	□To□
□Step□	□Step□
Next	Next
While□	While□
WhileEnd	WhileEnd
Do	Do
LpWhile□	LpWhile□
Return	Return
Break	Break
Stop	Stop
Locate□	Locate□
ClrText	ClrText
ClrGraph	ClrGraph
ClrList□	ClrList
LinearReg(a+bx)□	LinearReg(a+bx)□
S-L-Normal	S-L-Normal
S-L-Thick	S-L-Thick
S-L-Broken	S-L-Broken
S-L-Dot	S-L-Dot
DrawStat	DrawStat
SimplifyAuto	SimplifyAuto
SimplifyMan	SimplifyMan
NPPlot	NPPlot
Sinusoidal	Sinusoidal
SinReg□	SinReg□
Logistic	Logistic
LogisticReg□	LogisticReg□
Pie	Pie
Bar	Bar
1-Variable□	1-Variable□
2-Variable□	2-Variable□
LinearReg(ax+b)□	LinearReg(ax+b)□
Med-MedLine□	Med-MedLine□
QuadReg□	QuadReg□
CubicReg□	CubicReg□
QuartReg□	QuartReg□
LogReg□	LogReg□
ExpReg(a·e^bx)□	ExpReg(ae^bx)□
PowerReg□	PowerReg□
S-Gph1□	S-Gph1□
S-Gph2□	S-Gph2□
S-Gph3□	S-Gph3□
Square	Square
Cross	Cross
Dot	Dot
Scatter	Scatter
xyLine	xyLine
Hist	Hist
MedBox	MedBox
N-Dist	N-Dist
Broken	Broken
Linear	Linear

Command	Text
Med-Med	Med-Med
Quad	Quad
Cubic	Cubic
Quart	Quart
Log	Log
Exp(a·e ^{bx})	Exp(ae ^{bx})
Power	Power
ExpReg(a·b ^x) <input type="checkbox"/>	ExpReg(ab ^x) <input type="checkbox"/>
S-WindAuto	S-WindAuto
S-WindMan	S-WindMan
Resid-None	Resid-None
Resid-List <input type="checkbox"/>	Resid-List <input type="checkbox"/>
BG-None	BG-None
BG-Pict <input type="checkbox"/>	BG-Pict <input type="checkbox"/>
GridOff	GridOff
GridOn	GridOn
Exp(a·b ^x)	Exp(a ^{bx})
Q1Q3TypeStd	Q1Q3TypeStd
Q1Q3TypeOnData	Q1Q3TypeOnData
SketchNormal <input type="checkbox"/>	SketchNormal <input type="checkbox"/>
SketchThick <input type="checkbox"/>	SketchThick <input type="checkbox"/>
SketchBroken <input type="checkbox"/>	SketchBroken <input type="checkbox"/>
SketchDot <input type="checkbox"/>	SketchDot <input type="checkbox"/>
StoPict <input type="checkbox"/>	StoPict <input type="checkbox"/>
RclPict <input type="checkbox"/>	RclPict <input type="checkbox"/>
StoV-Win <input type="checkbox"/>	StoV-Win <input type="checkbox"/>
RclV-Win <input type="checkbox"/>	RclV-Win <input type="checkbox"/>
%	Display%
Data	DisplayData
Menu <input type="checkbox"/>	Menu <input type="checkbox"/>
Vertical <input type="checkbox"/>	Vertical <input type="checkbox"/>
Horizontal <input type="checkbox"/>	Horizontal <input type="checkbox"/>
Text <input type="checkbox"/>	Text <input type="checkbox"/>
Circle <input type="checkbox"/>	Circle <input type="checkbox"/>
F-Line <input type="checkbox"/>	F-Line <input type="checkbox"/>
PlotOn <input type="checkbox"/>	PlotOn <input type="checkbox"/>
PlotOff <input type="checkbox"/>	PlotOff <input type="checkbox"/>
PlotChg <input type="checkbox"/>	PlotChg <input type="checkbox"/>
PxlOn <input type="checkbox"/>	PxlOn <input type="checkbox"/>
PxlOff <input type="checkbox"/>	PxlOff <input type="checkbox"/>
PxlChg <input type="checkbox"/>	PxlChg <input type="checkbox"/>
PxlTest(PxlTest(
SortA(SortA(
SortD(SortD(
File1	File1
File2	File2
File3	File3
File4	File4
File5	File5
File6	File6
FuncOn	FuncOn
AxesOn	AxesOn
CoordOn	CoordOn
LabelOn	LabelOn
DrawOn	DrawOn

Command	Text
ab/c	ab/c
d/c	d/c
FuncOff	FuncOff
AxesOff	AxesOff
CoordOff	CoordOff
LabelOff	LabelOff
DrawOff	DrawOff
►Dec	>&D
►Hex	>&H
►Bin	>&B
►Oct	>&O
►DMS	>DMS
►a+bi	>a+bi
►r∠θ	>re ^{Theta}
Real	Real
a+bi	a+bi
r∠θ	re ^{Theta}
EngOn	EngOn
EngOff	EngOff
f _n	fn
File <input type="checkbox"/>	File <input type="checkbox"/>
ClrMat <input type="checkbox"/>	ClrMat <input type="checkbox"/>
Xdot	Xdot
None	None
StickLength	StickLength
StickHoriz	StickHoriz
StrJoin(StrJoin(
StrLen(StrLen(
StrCmp(StrCmp(
StrSrc(StrSrc(
StrLeft(StrLeft(
StrRight(StrRight(
StrMid(StrMid(
Exp►Str(Exp>Str(
Exp(Exp(
StrUpr(StrUpr(
StrLwr(StrLwr(
StrInv(StrInv(
StrShift(StrShift(
StrRotate(StrRotate(
Str <input type="checkbox"/>	Str <input type="checkbox"/>
OpenCSV <input type="checkbox"/>	OpenCSV <input type="checkbox"/>
CloseCSV	CloseCSV
LoadNextCell	LoadNextCell
GetCellValue	GetCellValue
GetCellString	GetCellString
CSVInfo <input type="checkbox"/>	CSVInfo <input type="checkbox"/>

Chapter 7 Spreadsheet

1. Spreadsheet Basics and the Function Menu

Selecting **S•SHT** on the Main Menu will display a spreadsheet screen. Entering the **S•SHT** mode automatically creates a new spreadsheet file named "SHEET".

The spreadsheet screen shows a number of cells (squares) and the data contained in each cell.

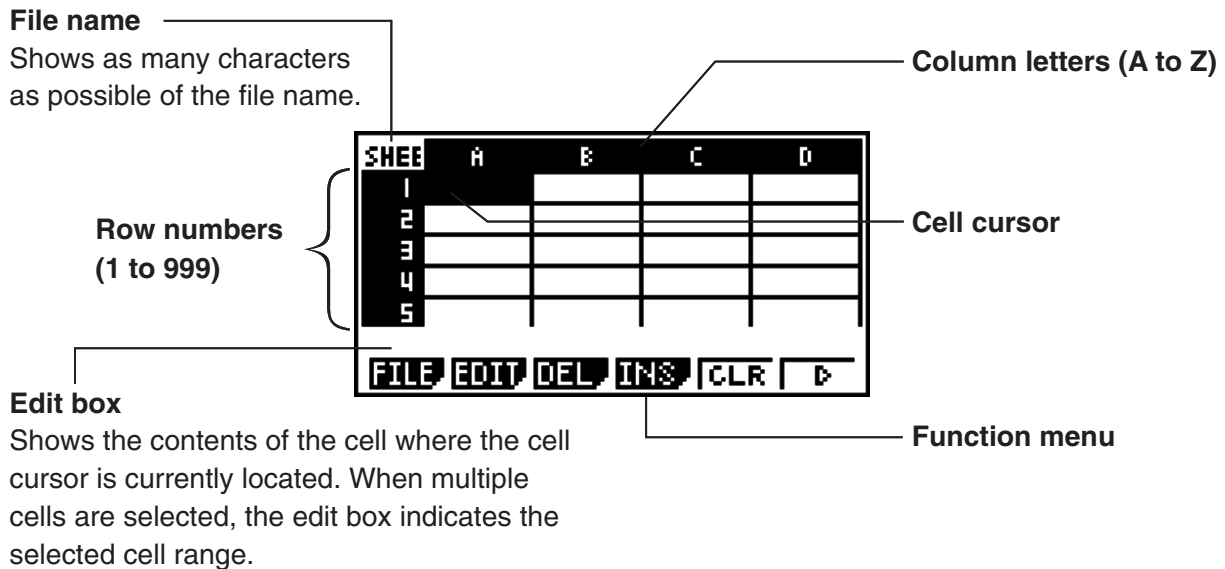

You can enter the following types of data into a cell.

Constants A constant is something whose value is fixed as soon as you finalize its input. A constant can be either a numeric value, or a calculation formula (such as $7+3$, $\sin 30$, $A1 \times 2$, etc.) that does not have an equal sign (=) in front of it.

Text A character string that starts with a quote mark (") is treated as text.

Formula A formula that starts out with an equal sign (=), such as $=A1 \times 2$, is executed as it is written.

Note that complex numbers are not supported in the **S•SHT** mode.

■ Spreadsheet Screen Function Menu

- **{FILE}** ... Displays the following FILE submenu.
 - **{NEW}**/**{OPEN}**/**{SV•AS}**/**{RECAL}**/**{CSV}**
- **{EDIT}** ... Displays the following EDIT submenu.
 - **{CUT}**/**{PASTE}**/**{COPY}**/**{CELL}**/**{JUMP}**/**{SEQ}**/**{FILL}**/**{SRT•A}**/**{SRT•D}**
 - PASTE is displayed only immediately after CUT or COPY is executed.
- **{DEL}** ... Displays the following DEL (delete) submenu.
 - **{ROW}**/**{COL}**/**{ALL}**
- **{INS}** ... Displays the following INS (insert) submenu.
 - **{ROW}**/**{COL}**
- **{CLR}** ... Clears the content from a selected range of cells.

- **{GRPH}** ... Displays the following GRPH menu. (Same as in the **STAT** mode.)
 - **{GPH1}/{GPH2}/{GPH3}/{SEL}/{SET}**
- **{CALC}** ... Displays the following CALC (statistical calculation) menu. (Same as in the **STAT** mode.)
 - **{1VAR}/{2VAR}/{REG}/{SET}**
- **{STO}** ... Displays the following STO (store) submenu.
 - **{VAR}/{LIST}/{FILE}/{MAT}**
- **{RCL}** ... Displays the following RCL (recall) submenu.
 - **{LIST}/{FILE}/{MAT}**
- **Data Entry Function Menu**
- **{GRAB}** ... Enters the GRAB mode for entering a cell reference name.
- **{\$}** ... Inputs the cell absolute reference command (\$).
- **{:}** ... Inputs the cell range specification command (:).
- **{If}** ... Inputs the CellIf(command.
- **{CEL}** ... Displays a submenu for inputting the following commands.
 - CellMin(, CellMax(, CellMean(, CellMedian, CellSum, CellProd(
- **{REL}** ... Displays a submenu for inputting the following relational operators.
 - =, ≠, >, <, ≥, ≤

2. Basic Spreadsheet Operations

This section explains spreadsheet file operations, how to move the cursor and select one or more cells, and how to enter and edit data.

■ Spreadsheet File Operations

● To create a new file

1. Press **[F1]**(FILE) **[F1]**(NEW).
2. On the dialog box that appears, enter up to eight characters for the file name, and then press **[EXE]**.
 - This will create a new file and display a blank spreadsheet.
 - A new file will not be created if there is already a file with the same file name you enter in step 2. Instead, the existing file will be opened.

● To open a file

1. Press **[F1]**(FILE) **[F2]**(OPEN).
2. On the file list that appears, use **▲** and **▼** to select the file you want and then press **[EXE]**.

● Auto Save

In the **S•SHT** mode, Auto Save saves the currently open file automatically whenever you edit it. This means you do not need to perform any manual save operation.

• To save a file under a new name

1. Press **F1**(FILE) **F3**(SV•AS).
2. On the dialog box that appears, enter up to eight characters for the new file name, and then press **EXE**.
 - If a file already exists with the same file name you enter in step 2, a message will appear asking if you want to replace the existing file with the new one. Press **F1**(Yes) to replace the existing file, or **F6**(No) to cancel the save operation and return to the file name input dialog box in step 2.

• To delete a file

1. Press **F1**(FILE) **F2**(OPEN).
2. On the file list that appears, use **▲** and **▼** to select the file you want to delete and then press **F1**(DEL).
3. This causes a confirmation message to appear. Press **F1**(Yes) to delete the file, or **F6**(No) to cancel without deleting anything.
4. To return to the spreadsheet from the file list, press **EXIT**.
 - Deleting all of the files will automatically create a new file named “SHEET” and display its spreadsheet.

■ Transferring Data between a Spreadsheet and CSV Files

You can import the contents of a CSV file stored with this calculator or transferred from a computer into a spreadsheet. You also can save the contents of a spreadsheet as a CSV file.

• To import the contents of a CSV file to a spreadsheet

1. Prepare the CSV file you want to import.
 - See “Import CSV File Requirements” (page 4-13).
2. Press **F1**(FILE) **F5**(CSV) **F1**(LOAD).
 - This will display a dialog box for specifying whether a CSV file should be imported from storage memory or the SD card.
3. Select **1**(Storage Mem) to select storage memory, or **2**(SD Card) to select the SD card.
 - Pressing **EXE** in the next step will overwrite all of the data on the spreadsheet with the CSV file data.
4. On the select file dialog box that appears, use **▲** and **▼** to move the highlighting to the file you want to import and then press **EXE**.
 - This imports the contents of the CSV file you specified to the spreadsheet.

Important!

- All blank data in the CSV file is imported as a blank cell.
- An error occurs if a CSV file contains even a single text string data item.
- If the CSV file includes data that cannot be converted, an error message will appear showing the location in the CSV file (Example: row 2, column 3) where the data that cannot be converted is located.
- Attempting to import a CSV file that has more than 26 columns or 999 rows will cause an “Invalid Data Size” error.

• To save spreadsheet contents as a CSV file

1. If required, press **[F1]** (FILE) **[F4]** (RECAL) to recalculate the spreadsheet contents.
 - Note that recalculation is not performed automatically when you save spreadsheet contents to a CSV file. Be sure to perform recalculation if the spreadsheet contains a formula, which starts with an equals symbol (=). See “Inputting a Formula into a Cell” (page 7-9) for more information.
 - Formulas are not saved to the CSV file. Only calculation results are saved.
 - All ERROR cell data on the spreadsheet is saved as blank data.
2. Press **[F1]** (FILE) **[F5]** (CSV) **[F2]** (SV•AS).
 - This will display a dialog box for specifying whether the CSV file should be saved to storage memory or the SD card.
3. Select **[1]** (Storage Mem) to select storage memory, or **[2]** (SD Card) to select the SD card.
 - This displays a folder selection screen.
4. Select the folder where you want to save the CSV file.
 - To store the CSV file in the root directory, highlight “ROOT”.
 - To store the CSV file in a folder, use **[▲]** and **[▼]** to move the highlighting to the desired folder and then press **[F1]** (OPEN).
5. Press **[F1]** (SV•AS).
6. Input up to eight characters for the file name and then press **[EXE]**.
 - For information about how certain types of data is converted when being saved to a CSV file, see the “Important!” note under “To save matrix contents as a CSV file” (page 3-40).

• To specify the CSV file delimiter symbol and decimal point

Press **[F1]** (FILE) **[F5]** (CSV) **[F3]** (SET) to display the CSV format setting screen. Next, perform the procedure from step 3 under “Specifying the CSV File Delimiter Symbol and Decimal Point” (page 4-15).

■ Recalculating All of the Formulas in the Currently Open Spreadsheet

The **S•SHT** mode has an Auto Calc features that automatically recalculates all of the formulas in a spreadsheet whenever you open it or perform any editing operation. Auto Calc is enabled under initial factory default settings. You also can execute a recalculation manually, if you want.

• Auto Calc

Auto Calc is an **S•SHT** mode Setup item (page 2-15).

When Auto Calc is enabled (On), all of the formulas in a spreadsheet are recalculated when the spreadsheet is opened or when any editing operation is performed. It should be noted, however, that recalculation can slow down the overall processing speed. When Auto Calc is disabled (Off), you need to execute recalculation manually as required.

• To execute spreadsheet re-calculation manually

Press **[F1]** (FILE) **[F4]** (RECAL). This recalculates all of the formulas in the currently open file and displays the applicable results.

■ Using the Cell Cursor

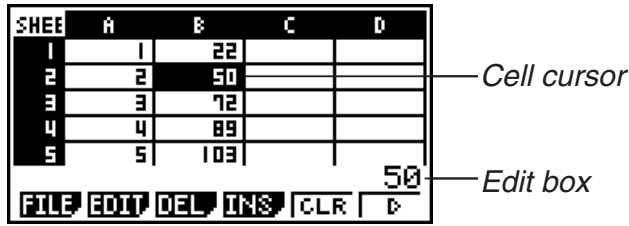

The cell cursor shows the cell that is selected on a spreadsheet. The highlighted cell is the one that is currently selected by the cell cursor.



When a single cell is selected by the cell cursor, the contents of that cell are displayed in the edit box. The cell contents can be edited in the edit box.

When a multiple cells are selected by the cell cursor, the selection range is displayed in the edit box. In this case, you can copy, delete, or perform other cell operations on the entire range of selected cells.

● To select cells

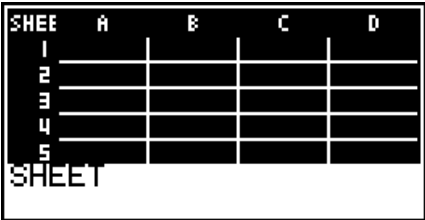
To select this:	Do this:
A single cell	Use the cursor keys to move the cell cursor to the cell you want, or use the JUMP comment to jump directly to the cell.
A range of cells	See "To select a range of cells" (page 7-6).
An entire row of cells 	Move the cell cursor to column A of the row whose cells you want to select and then press . Pressing while the cell cursor is located at cell A2, for example, will select the entire second row (from A2 to Z2). This will cause A2:Z2 (which indicates the selected range) to appear in the edit box.
An entire column of cells. 	Move the cell cursor to row 1 of the column whose cells you want to select and then press . Pressing while the cell cursor is located at cell C1, for example, will select the entire column C (from C1 to C999). This will cause C1:C999 (which indicates the selected range) to appear in the edit box.
All of the cells in the spreadsheet 	Press while the entire column A is selected or press while the entire row 1 is selected. This will select all of the cells in the spreadsheet and display the spreadsheet file name in the edit box.

• Using the JUMP Command to Move the Cell Cursor

To move the cell cursor to here:	Do this:
A particular cell	<ol style="list-style-type: none"> 1. Press F2 (EDIT) F4 (JUMP) F1 (GO). 2. On the dialog box that appears, enter the name of the cell (A1 to Z999) to which you want to jump. 3. Press EXE.
Line 1 of the current column	Press F2 (EDIT) F4 (JUMP) F2 (TOP↑).
Column A of the current row	Press F2 (EDIT) F4 (JUMP) F3 (TOP←).
Last line of the current column	Press F2 (EDIT) F4 (JUMP) F4 (BOT↓).
Column Z of the current row	Press F2 (EDIT) F4 (JUMP) F5 (BOT→).

• To select a range of cells

1. Move the cell cursor to the start point of the range of cells you want to select.
 - You could select an entire row or column of cells as the start point, if you want. For details about selecting cells, see “To select cells” on page 7-5.
2. Press **SHIFT** **1** (CLIP).
 - This will change the cell cursor to a thick-line boundary instead of the normal highlighting.
3. Use the cursor keys to move the cell cursor to the end point of the range of cells you want to select.
 - The edit box will show the range of the selected cells.
 - To cancel cell selection, press **EXIT**. If you do, the cell cursor will be located at the end point of the range you selected.

SHEET	A	B	C	D
1	1	6		
2	7	7		
3	8	8		
4	9	9		
5	10	10		

A2:B3
FILE EDIT DEL INS CLR ▸

■ Data (Constants, Text, Formula) Input Basics

First let's have a look at a few basic procedures that apply regardless of the type of data you are inputting.

• To overwrite data currently in a cell with new data

1. Move the cell cursor to the cell where you want to input data.
 - If the cell you select already contains data, the following step will overwrite the existing data with new input.
2. Use the calculator's keys to input data.
 - As you perform key operations to input values or text (such as **1**, **ALPHA** **F1** (A-E) **F2** (B), etc.), the applicable figures will appear aligned left inside the edit box.
 - To cancel an input operation part way through at any point before advancing to step 3 below, press **EXIT**. This will return the cell contents to what they were in step 1 of this procedure.
3. To finalize and apply your input, press **EXE**.

SHEET	A	B	C	D
1				
2				
3				
4				
5				

567
GRAB \$ % : If CEL REL

• To edit cell data

1. Move the cell cursor to the cell whose contents you want to edit.
2. Press **F2** (EDIT) **F3** (CELL).
 - Cell contents in the edit box will change from align left to align right. A text cursor will appear in the edit box so you can edit its contents.

SHEE	A	B	C	D
1	567			
2				
3				
4				
5				

EDIT

GRAB \$: If DEL REL

3. Use **▶** and **◀** to move the cursor around the contents of the cell, and edit them as required.
 - To cancel an edit operation part way through at any point before advancing to step 4 below, press **EXIT**. This will return the cell contents to what they were in step 1 of this procedure.
4. To finalize and apply your edits, press **EXE**.

• To move the cell cursor while inputting data into a cell

Under factory default settings, pressing **EXE** while inputting data into a cell will cause the cell cursor to move to the next line. You can specify movement to the next column instead using the “Move” setting as described on page 2-16.

■ Inputting a Constant (Value, Calculation Result, Number Sequence) into a Cell

A constant is something whose value is fixed as soon as you finalize its input. A constant can be either a numeric value, or a calculation formula (such as $7+3$, $\sin 30$, $A1 \times 2$, etc.) that does not have an equal sign (=) in front of it. Inputting **SHIFT** **7** (**sin**) **3** **0** **EXE**, for example will cause the value 0.5 (the calculation result) to appear in the cell (when Deg is selected as the Angle unit).

• To input a number sequence automatically based on a function expression

1. Move the cell cursor to the cell where you want number sequence input to start.
 - Under initial default settings, automatic input of the number sequence will proceed downwards from the start cell. You can specify a different direction using the “Move” setting as described on page 2-16.
2. Press **F2** (EDIT) **F5** (SEQ) to display the Sequence screen, and then specify the function expression and values required to generate the required number sequence.

Sequence

Expr : _____

Var : _____

Start : _____

End : _____

Incre : _____

1st Cell:A1

EXE

You can input data for the item that is highlighted on the screen.

Reference name of the cell selected in step 1

Item	Description
Expr	Input the function expression $f(x)$ for generating the number sequence. Example: $\text{[ALPHA] [F5] (U-Z) [F4] (X) [x^2] [+] [1] [EXE] (X^2 + 1)$
Var	Input the variable name used in the function expression input for Expr. Example: $\text{[ALPHA] [F5] (U-Z) [F4] (X) [EXE] (X)$
Start	Input the starting value (X_1) of the value to be substituted for the variable specified by Var. Example: [2] [EXE]
End	Input the ending value (X_n) of the value to be substituted for the variable specified by Var. Example: [1] [0] [EXE]
Incre	Input the increment value (m) for successive value of X_1 , as in: ($X_2 = X_1 + m$), ($X_3 = X_2 + m$), and so on. The number sequence is generated in the range of $X_1 + (n - 1) m \leq X_n$. Example: [2] [EXE]
1st Cell	Input the reference name (A1, B2, etc.) of the cell where you want the first value of the number sequence to be input. Specify a cell here only if the starting cell is different from the one you specified in step 1 of this procedure. Example: $\text{[ALPHA] [F1] (A-E) [F2] (B) [1] [EXE] (B1)$

- Each time you press [EXE] after inputting data for a setting item, the highlighting will move to the next setting item. You also can use [▲] and [▼] to move the highlighting upwards and downwards as required.
 - Performing the next step will input the number string automatically starting from the specified cell. If any cell that is within the range of cells where the number sequence values will be input already contains data, the existing data will be replaced with the number sequence values.
3. After inputting data for all the setting items, press [F6] (EXE) or the [EXE] key to start number sequence generation and input.

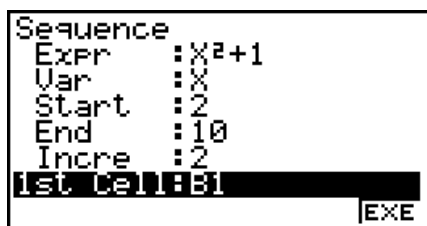

SHEET	A	B	C	D
1		5		
2		17		
3		29		
4		41		
5		53		

[CUT] [COPY] [CELL] [JUMP] [SEQ.] [D]

Inputting Text into a Cell

To input text, make sure the first thing you input into the cell is $\text{[ALPHA] [F6] (SYBL) [F2] (")}$. The quote mark (") tells the calculator that what follows is text, and should be displayed as-is without calculation. The quote mark (") is not displayed as part of the text.

■ Inputting a Formula into a Cell

For the sake of example, let's try making a table that contains data based on the formula $\langle \text{PRICE} \rangle \times \langle \text{QUANTITY} \rangle = \langle \text{TOTAL} \rangle$. To do this, we would put $\langle \text{PRICE} \rangle$ values in column A, $\langle \text{QUANTITY} \rangle$ values in column B, and calculation formulas (like $= A1 \times B1$, $= A2 \times B2$, and so on) in column C. If the Auto Calc feature is enabled (On), the values in column C would be recalculated and updated any time we change the values in column A or B.

In this example, note that we must start out the data in column C with the equal sign (=) in order to indicate it is a formula. In addition to values, arithmetic operators, and cell reference names, a formula also can contain built-in function commands (page 3-10) and special **S•SHT** mode commands (page 7-15).

● Formula Input Example

	A	B	C
1	PRICE	QUANTITY	TOTAL
2	35	15	525
3	52	15	780
4	78	20	1560

Procedure

1. Input the text for line 1, and the applicable values in cells A2 through B4.
2. Move the cursor to cell C2, and input the formula for $A2 \times B2$.

[ALPHA] **[F6]** (SYBL) **[F5]** (=) **[EXIT]** **[F1]** (A-E) **[F1]** (A) **[2]** **[X]** **[ALPHA]** **[F2]** (B) **[2]** **[EXE]**

3. Copy the formula in cell C2 and copy it into cells C3 and C4. Move the cell cursor to cell C2 and then perform the following operation.

[F2] (EDIT) **[F2]** (COPY) **[▼]** **[F1]** (PASTE) **[▼]** **[F1]** (PASTE) **[EXIT]**

- For details about the copy and paste operations, see "Copying and Pasting Cell Contents" (page 7-11).

SHEET	A	B	C	D
1	PRICE	QUANT	TOTAL	
2	35	15	525	
3	52	15	780	
4	78	20	1560	
5				

$=A4 \times B4$

[CUT] **[COPY]** **[CELL]** **[NUM]** **[SEC]** **[D]**

■ Inputting a Cell Reference Name

Each cell on a spreadsheet has what is called a "reference name", which is derived by combining its column name (A through Z) with its row name (1 through 999). A cell reference name can be used inside of a formula, which makes the value of the called cell part of the formula. See "Inputting a Formula into a Cell" above for more information. There are two methods you can use to input a cell reference name: direct input of the name and input using the GRAB command. The following illustrates how you would use each of these methods to input $=A1+5$ into cell B1.

- **To input a cell reference name using direct input**

Move the cell cursor to cell B1 and then perform the following operation.

[ALPHA] **[F6]** (SYBL) **[F5]** (=) **[EXIT]** **[F1]** (A-E) **[F1]** (A) **[1]** **[+]** **[5]** **[EXE]**

- **To input a cell reference name using the GRAB command**

Move the cell cursor to cell B1 and then perform the following operation.

[ALPHA] **[F6]** (SYBL) **[F5]** (=) **[EXIT]** **[EXIT]** **[F1]** (GRAB) **[F1]** (SET) **[+]** **[5]** **[EXE]**

- Commands **[F2]** (GO) through **[F6]** (BOT→) on the submenu that appears when you press **[F1]** (GRAB) are identical to commands **[F1]** (GO) through **[F5]** (BOT→) of the JUMP command submenu. See “Using the JUMP Command to Move the Cell Cursor” on page 7-6 about these commands.
-

■ Relative and Absolute Cell Reference Names

There are two types of cell reference names: relative and absolute. Normally, cell reference names are treated as being relative.

Relative Cell Reference Names

In the formula =A1+5, the cell reference name A1 indicates a relative cell reference. It is “relative” because copying the formula and pasting in a different cell will cause the cell reference name to change in accordance with the location of cell where it is pasted. If the formula =A1+5 is originally located in cell B1, for example, copying at pasting in cell C3 will result in =B3+5 in cell C3. Moving from column A to column B (one column) causes A to change to B, while moving from row 1 to row 3 changes (two rows) changes the 1 to 3.

Important!: If the result of a copy and paste operation causes a relative cell reference name to change to something that is outside the range of the spreadsheet cells, the applicable column letter and/or row number will be replaced by a question mark (?), and “ERROR” will be displayed as the cell’s data.

Absolute Reference Names

If you want the row or the column, or both the row and the column parts of a cell reference name to remain the same to matter where you paste them, you need to create an absolute cell reference name. You do this by affixing a dollar sign (\$) in front of the part of the cell reference name you want to remain unchanged. You have three options when using the dollar sign (\$) to create an absolute cell reference name: absolute column with relative row (\$A1), relative column with absolute row (A\$1), and absolute row and column (\$A\$1).

- **To input the absolute cell reference name symbol (\$)**

When inputting a cell reference into a spreadsheet cell, press **[F2]** (\$).

For example, the following key operation inputs the absolute cell reference name = \$B\$1

[ALPHA] **[F6]** (SYBL) **[F5]** (=) **[EXIT]** **[EXIT]** **[F2]** (\$) **[ALPHA]** **[F1]** (A-E) **[F2]** (B) **[EXIT]** **[EXIT]** **[F2]** (\$) **[1]**

■ Copying and Pasting Cell Contents

You can copy the contents of one or more cells and paste them into another location. Once you perform the copy operation, you can copy the contents to multiple locations, if you want.

● To copy and paste spreadsheet data

1. Select the cell(s) you want to copy.
 - See “To select cells” (page 7-5) for more information.
- 2 Press **F2** (EDIT) **F2** (COPY).
 - This will go into paste standby for the selected data, indicated by the **F1** menu item changing to (PASTE).
 - You can exit the paste standby at any time before you perform step 4 below by pressing **EXIT**.
3. Use the cursor keys to move the cell cursor to location where you want to paste the data.
 - If you selected a range of cells in step 1, the cell you select with the cell cursor will be the upper left cell of the paste range.
 - If the location you select is within the range that you copied, performing step below will cause the existing data to be overwritten with the pasted data.
4. Press **F1** (PASTE).
 - This will paste the copied data.
 - To paste the same data in other locations, repeat steps 3 and 4.
5. After you are finish pasting the data, press **EXIT** to exit paste standby.

■ Cutting and Pasting Cell Contents

You can use cut and paste to move the contents of one or more cells to another location. Cell contents (regardless of whether it includes relative or absolute cell name references) generally are unchanged by a cut and paste operation.

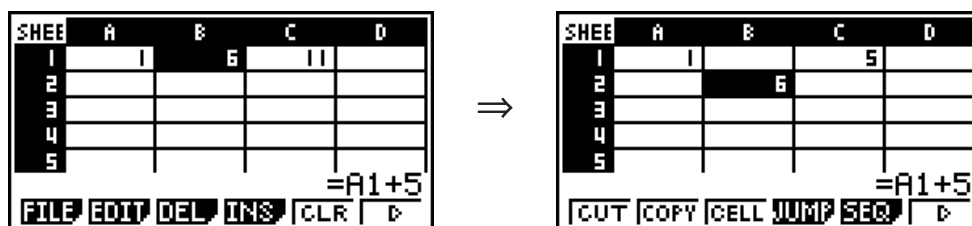

Cutting the formula =A1+5 in cell B1 and pasting it into cell B2. The A1 reference name is unchanged.

When you are cut and paste a range cells, reference names that affect relationships within the range are changed accordingly when the range is pasted in order to maintain the correct relationship, regardless of whether they are relative or absolute reference names.

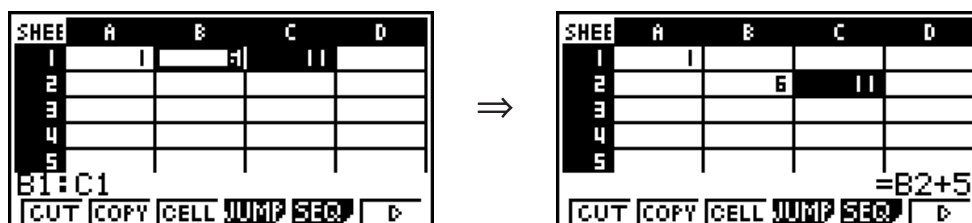

Cutting the B1:C1 range of cells that includes the formula =B1+5 and pasting it into B2:C2. The formula pasted into C2 is changed to =B2+5 in order to maintain the relationship with the cell to the left, which was also part of the pasted range.

● To cut and paste spreadsheet data

1. Select the cell(s) you want to cut.
 - See “To select cells” (page 7-5) for more information.
2. Press **F2** (EDIT) **F1** (CUT).
 - This will go into paste standby for the selected data, indicated by the **F1** menu item changing to (PASTE).
 - You can exit the paste standby at any time before you perform step 4 below by pressing **EXIT**.
3. Use the cursor keys to move the cell cursor to location where you want to paste the data.
 - If you selected a range of cells in step 1, the cell you select with the cell cursor will be the upper left cell of the paste range.
 - If the location you select is within the range that you cut, performing step below will cause the exiting data to be overwritten with the pasted data.
4. Press **F1** (PASTE).
 - This will paste the data from the cell(s) you selected in step 1 and paste it into the location you selected in step 3.
 - Regardless of whether Auto Calc is enabled or disabled (page 7-4), pasting cut data will cause all of the formulas in the spreadsheet to be recalculated.

■ Inputting the Same Formula into a Range of Cells

Use the Fill command when you want to input the same formula into a specified range of cells. The rules governing relative and absolute cell name references are the same as those for copy and paste.

When you need to input the same formula into cells B1, B2, and B3, for example, the Fill command lets you do so by inputting the formula once, into cell B1. Note the following about how the Fill command handles cell name references in this case.

When cell B1 contains this:	The Fill command will do this:		
=A1×2	A	B	* Note that in actual practice cells B1, B2, and B3 will show the calculation results, not the formulas as shown here.
	1	=A1×2	
	2	=A2×2	
	3	=A3×2	
=A\$2×2	A	B	
	1	=A\$2×2	
	2	=A\$2×2	
	3	=A\$2×2	

• To input the same formula into a range of cells

1. Select the range of cells into which you want to input the same formula.
 - In this example we will assume the B1:B3 is selected. See “To select a range of cells” (page 7-6).
2. Press **F2** (EDIT) **F6** (>) **F1** (FILL).
3. On the Fill screen that appears, enter the formula you want to input.



You can input data for the item that is highlighted on the screen.

This is the range of cells you selected in step 1.

- In the “Formula” line, input =A1×2 (**ALPHA** **F6** (SYBL) **F5** (=) **EXIT** **F1** (A-E) **F1** (A) **1** **X** **2** **EXE**).
 - Pressing **EXE** will cause the cell cursor to move to the “Cell Range” line.
 - If any cell within the cell range already contains data, performing the next step will cause the existing data to be overwritten with the new fill data (formula).
4. Press **F6** (EXE) or the **EXE** key.
 - This will input the formula into the range of cells you specified.

■ Sorting Constant Data

Note that only constant data can be sorted. You can select multiple columns within a single line or multiple lines within a single column for sorting.

• To sort constant data

1. Select a range of column cells in a single row or a range of row cells in a single column.
 - See “To select a range of cells” (page 7-6).
 - A Syntax ERROR message will appear if any of the cells in the range you select contain data other than constant data.
2. Depending on the type of sort you want to perform, perform either one of the following operations.
 - To sort ascending: **F2** (EDIT) **F6** (>) **F2** (SRT•A)
 - To sort descending: **F2** (EDIT) **F6** (>) **F3** (SRT•D)

■ Deleting and Inserting Cells

• To delete an entire line or column of cells

Select the row(s) or column(s) you want to delete and then press **F3** (DEL). This will delete the selected row(s) or column(s) immediately, without displaying a confirmation message.

You also can perform the following steps to delete a row or column.

1. Select one or more cells inside the row(s) or column(s) you want to delete.
 - If you want to delete lines 2 through 4, for example, you could select A2:B4, C2:C4, or any other range of cells that includes the lines to be deleted.
 - If you want to delete columns A and B, for example, you could select A1:B1, A2:B4, etc.
2. Press **F3** (DEL).
 - This enters delete standby. If you decide you want to cancel the delete operation at this time, press **EXIT**.
3. To delete the entire line(s) that include the cells you selected in step 1, press **F1** (ROW). To delete the entire column, press **F2** (COL).

• To delete the contents of all the cells in a spreadsheet

1. Press **F3** (DEL) **F3** (ALL).
2. In response to the confirmation message that appears, press **F1** (Yes) to delete the data or **F6** (No) to cancel without deleting anything.

• To insert a row or column of blank cells

1. Perform one of the following operations to specify the location of the insert and the number of rows or columns to be inserted.

- **To insert rows**

Starting with the row immediately below of the row where you want the insert to be performed, select the same number of rows that you want to insert.

Example: To insert three rows above row 2, you could select A2:A4, B2:C4, etc.

- **To insert columns**

Starting with the column immediately to the right of the column where you want the insert to be performed, select the same number of columns that you want to insert.

Example: To insert three columns to the left of column B, you could select B2:D4, B10:D20, etc.

2. Press **F4** (INS).
 - This will enter insert standby. If you decide you want to cancel the insert operation at this time, press **EXIT**.
3. Press **F1** (ROW) to insert the applicable number of rows or **F2** (COL) to insert columns.
 - A Range ERROR occurs if an insert operation causes existing cells that contain data to move outside the range of A1:Z999.

• To clear the contents of specific cells

Select the cell or range of cells you want to clear and then press **F5** (CLR).

3. Using Special S • SHT Mode Commands

The **S • SHT** mode has a number of special commands like CellSum(), which returns the sum of a range of cells, and CellIf(), which specifies branching conditions. These special commands can be used inside of formulas.

■ Special S • SHT Mode Command List

“Input Key Operation” operations can be performed during cell input only.

You can omit anything enclosed in brackets ([]) in the Syntax of each command.

Command	Description
CellIf ((Branch Condition)	Returns Expression 1 when the equality or inequality provided as the branch condition is true, and Expression 2 when it is false. Input Key Operation: [F4] (If) Syntax: CellIf(equality, expression 1, expression 2[]) or CellIf(inequality, expression 1, expression 2[]) Example: =CellIf(A1>B1, A1, B1) Returns the value of A1 when {Cell A1 value} > {Cell B1 value}. Otherwise, returns the value of B1.
CellMin ((Cell Minimum Value)	Returns the minimum value in a specified range of cells. Input Key Operation: [F5] (CEL) [F1] (Min) Syntax: CellMin(start cell:end cell[]) Example: =CellMin(A3:C5) Returns the minimum value of the data in cell range A3:C5.
CellMax ((Cell Maximum Value)	Returns the maximum value in a specified range of cells. Input Key Operation: [F5] (CEL) [F2] (Max) Syntax: CellMax(start cell:end cell[]) Example: =CellMax(A3:C5) Returns the maximum value of the data in cell range A3:C5.
CellMean ((Mean of Cells)	Returns the mean value in a specified range of cells. Input Key Operation: [F5] (CEL) [F3] (Mean) Syntax: CellMean(start cell:end cell[]) Example: =CellMean(A3:C5) Returns the mean value of the data in cell range A3:C5.
CellMedian ((Median of Cells)	Returns the median value in a specified range of cells. Input Key Operation: [F5] (CEL) [F4] (Med) Syntax: CellMedian(start cell:end cell[]) Example: =CellMedian(A3:C5) Returns the median value of the data in cell range A3:C5.
CellSum ((Sum of Cells)	Returns the sum of the data in a specified range of cells. Input Key Operation: [F5] (CEL) [F5] (Sum) Syntax: CellSum(start cell:end cell[]) Example: =Cellsum(A3:C5) Returns the sum of the data in cell range A3:C5.

CellProd (Product of Cells)	Returns the product of the data in a specified range of cells. Input Key Operation: [F5] (CEL) [F6] (Prod) Syntax: CellProd(start cell:end cell[]) Example: =CellProd(B3:B5) Returns the product of the data in cell range B3:B5.
---------------------------------------	-------------------------------------------------------------------------------------------------------------------------------------------------------------------------------------------------------------------------------------------------------------------------------------------

■ S • SHT Mode Command Example

This example inputs the special **S • SHT** mode formula CellSum(into cell C1 in order to calculate the sum of all the data in cell range A1:B5. It is assumed that there is already data in the cell range A1:B5.

1. Move the cell cursor to cell C1 and then perform the following operation.

[ALPHA] **[F6]** (SYBL) **[F5]** (=) **[EXIT]** **[EXIT]** **[F5]** (CEL) **[F5]** (Sum)

[ALPHA] **[F1]** (A-E) **[F1]** (A) **[1]** **[EXIT]** **[EXIT]** **[EXIT]**

[F3] (:) **[ALPHA]** **[F1]** (A-E) **[F2]** (b) **[5]** **[SHIFT]** **[÷]** ())

- You can perform the following operation, which uses the GRAB function (page 7-10) and CLIP function (page 7-6) in place of the underlined part in the above operation.

[EXIT] **[F1]** (GRAB) **[F4]** (TOP←) (Enters the GRAB mode and moves the cursor to A1.)

[SHIFT] **[1]** (CLIP) **[▶]** **[▼]** **[▼]** **[▼]** (Specifies the selection range for the CLIP function.)

[EXE] **[SHIFT]** **[÷]** ())

2. Press **[EXE]** to finalize input of the formula.

SHEET	A	B	C	D
1	1	6		
2	2	7		
3	3	8		
4	4	9		
5	5	10		

=CellSum(A1:B5)
[GRAB] **[F4]** **[▶]** **[▼]** **[▼]** **[▼]** **[EXE]** **[SHIFT]** **[÷]** **[)]**

SHEET	A	B	C	D
1	1	6	55	
2	2	7		
3	3	8		
4	4	9		
5	5	10		

[FILE] **[EDIT]** **[DEL]** **[INS]** **[CLR]** **[▶]**

4. Drawing Statistical Graphs, and Performing Statistical and Regression Calculations

When you want to check the correlation between two sets of data (such as temperature and the price of some product), trends become easier to spot if you draw a graph that uses one set of data as the *x*-axis and the other set of data as the *y*-axis.

With the spreadsheet you can input the values for each set of data and draw a scatter plot or other types of graphs. Performing regression calculations on the data will produce a regression formula and correlation coefficient, and you can overlay a regression graph over the scatter plot.

S • SHT mode graphing, statistical calculations, and regression calculations use the same functions as the **STAT** mode. The following shows an operation example that is unique to the **S • SHT** mode.

■ Example of Statistical Graph Operations (GRPH Menu)

Input the following data and draw a statistical graph (scatter plot in this example).

0.5, 1.2, 2.4, 4.0, 5.2 (x-axis data)
 -2.1, 0.3, 1.5, 2.0, 2.4 (y-axis data)

● To input data and draw a statistical graph (scatter plot)

1. Input the statistical calculation data into the spreadsheet.
 - Here we will input the x -axis data into column A, and the y -axis data into column B.
2. Select the range of cells you want to graph (A1:B5).

SHEET	A	B	C	D
1	0.5	-2.1		
2	1.2	0.3		
3	2.4	1.5		
4	4	2		
5	5.2	2.4		

A1:B5
 FILE EDIT DEL INS CLR ▸

3. Press **F6** (▸) **F1** (GRPH) to display the GRPH menu, and then press **F1** (GRPH1).

- This will produce a scatter plot of the data in the range of cells you selected in step 2 of this procedure.
- The graph shown here is what is produced under initial default **S•SHT** mode settings. You can change the configuration of graph settings on the screen that appears when you press **F6** (SET) on the GRPH menu. For details see “General Graph Settings Screen Operations” below.



■ General Graph Settings Screen Operations

You can use the general graph setting screen to specify the range of data to be used for graphing, and to select the type of graph to be drawn.

● To configure statistical graph settings

1. Input the statistical calculation data into the spreadsheet and then select the range of cells you want to graph.
 - Actually, the above step is not necessary at this point. You also could configure settings first before inputting data and selecting the range of cells to be graphed.
2. Press **F6** (▸) **F1** (GRPH) **F6** (SET).
 - This will display the general graph settings screen (StatGraph1 in this example).

StatGraph1
Graph Type: Scatter
XCellRange: A1:A5
YCellRange: B1:B5
Frequency : 1
Mark Type : □
GFPH1 GFPH2 GFPH3

You can configure the setting for the item that is highlighted on the screen.

A function menu will appear when certain setting items are selected.

- The number of columns you select in step 1 will determine what information is input automatically on the general graph settings screen.

If you select this number of columns:	This information will be input automatically:
1	XCellRange
2	XCellRange, YCellRange
3	XCellRange, YCellRange, Frequency

- The following describes each of the setting items for this screen.

Item	Description
StatGraph1	Select the name of the setup you want. You can have up to three different setups registered, named StatGraph 1, 2, or 3.
Graph Type	Select the graph type. The initial default setting is Scat (scatter plot).
XCellRange	Specifies the cell range assigned to the graph <i>x</i> -axis (XCellRange). Only XCellRange is displayed for some Graph Types.
YCellRange	Specifies the cell range assigned to the graph <i>y</i> -axis (YCellRange). The YCellRange is not displayed for some Graph Types.
Frequency	Specifies the range cells that contain values indicating the frequency of each graph data item. Select [F1] (1) if you do not want to use frequency values.
Mark Type	Specify the type of mark (<input type="checkbox"/> , ×, or •) to use as the mark on the scatter plot.

- Use **[▲]** and **[▼]** to move the highlighting to the setting item you want to change. On the function menu that appears, select the setting you want.
 - For details about the StatGraph1, Graph Type, and Mark Type settings, see “To display the general graph settings screen” (page 5-2).
 - If you want to change the XCellRange, YCellRange, or Frequency setting, move the highlighting to the item you want to change and then input the cell range directly, or select **[F1]**(CELL) (**[F2]**(CELL) for Frequency) and then edit the currently input range. When inputting a cell range manually, use **[F1]**(:) to enter a colon (:) between two cells that define the range.
- After configuring the required settings, press **[EXIT]** or **[EXE]**.

■ Example of Statistical Calculation Operation (CALC Menu)

This example uses the data from the “Drawing a Scatter Diagram and *xy* Line Graph” (page 5-9) to perform paired-variable statistical calculations.

0.5, 1.2, 2.4, 4.0, 5.2 (x-data)
 -2.1, 0.3, 1.5, 2.0, 2.4 (y-data)

• To perform paired-variable statistical calculations and regression calculations

1. Input the above *x*-data into cells A1:A5 of the spreadsheet and the *y*-data into cells B1:B5, and then select the range of the cells where you input the data (A1:B5).



2. Press **F6** (▷) **F2** (CALC) to display the CALC menu, and then press **F2** (2VAR).

- This will display a screen of paired variable calculation results based on the data you selected in step 1. Use **▶** and **◀** to scroll the result screen. To close the screen, press **EXIT**.
- For information about the meaning of each of the values on the result screen, see “Displaying the Calculation Results of a Drawn Paired-Variable Graph” on page 5-14.

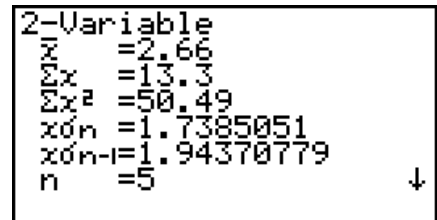

3. To return to the spreadsheet screen, press **EXIT**.

■ Using the Statistical Calculation Data Range Specification Screen

You can use a special setting screen to specify the range of data to be used for statistical calculation.

• To specify the data range for statistical calculation

1. Input the statistical calculation data into the spreadsheet and then select its range of cells.
 2. Press **F6** (▷) **F2** (CALC) **F6** (SET).

- This will display a setting screen like the one shown to the right.

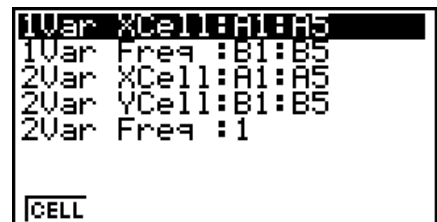

- The number of columns you select in step 1 will determine what information is input automatically on the statistical calculation data range specification screen.

If you select this number of columns:	This information will be input automatically:
1	1Var XCell and 2Var XCell
2	1Var Freq and 2Var YCell
3	2Var Freq

- The following describes each of the setting items for this screen.

Item	Description
1Var XCell 1Var Freq	The cell range data specified here is used for variable x and Frequency values when performing single-variable statistical calculations.
2Var XCell 2Var YCell 2Var Freq	The cell range data specified here is used for variable x , variable y , and Frequency values when performing paired-variable statistical calculations.

3. If you want to change the cell range, use \blacktriangle and \blacktriangledown to move the highlighting to the item you want to change and the input the new cell range.

- To input the colon (:), press $\boxed{F1}$ (:).
- To edit the currently input cell range, press $\boxed{F1}$ (CELL) (in the case of 1Var XCell, 2Var XCell, and 2Var YCell) or $\boxed{F2}$ (CELL) (in the case of 1Var Freq and 2Var Freq).

4. After configuring the required settings, press \boxed{EXIT} or \boxed{EXE} .

■ STAT Mode and S • SHT Mode Function Menu Correspondence Table

In both the **STAT** mode and the **S • SHT** mode, statistical graph functions are on the GRPH function menu and statistical/regression calculation functions are on the CALC function menu. The structures of these menus and their submenus are the same in the **STAT** mode and the **S • SHT** mode. For details about each menu item, refer to the pages referenced in the table below.

For information about this menu item:	Refer to:
{GRPH} - {GPH1}	"Changing Graph Parameters" (page 5-1)
{GRPH} - {GPH2}	
{GRPH} - {GPH3}	
{GRPH} - {SEL}	"Graph draw/non-draw status" (page 5-3)
{GRPH} - {SET}	"Changing Graph Parameters" (page 5-1) "General graph settings"(page 5-1) "To display the general graph settings screen"(page 5-2) "General Graph Settings Screen Operations" (page 7-17)
{CALC} - {1VAR}	"Single-Variable Statistical Calculations" (page 5-20)
{CALC} - {2VAR}	"Paired-Variable Statistical Calculations" (page 5-20)
{CALC} - {REG}	"Regression Calculation" (page 5-21)
{CALC} - {SET}	"Using the Statistical Calculation Data Range Specification Screen" (page 7-19)

5. S • SHT Mode Memory

You can use the calculator's different types of memory (variables, list memory, file memory, matrix memory) to store data, and recall data from a memory into the spreadsheet.

■ Saving Spreadsheet Data to a Memory

The following table shows an overview of the store operations for each type of memory. For details about each operation, see the example operations following the table.

Memory Type	Store Operation
Variables (A ~ Z, r, θ)	You can assign the content of a single cell to a variable. While a single cell is selected, press F6 (\triangleright) F3 (STO) F1 (VAR), and then specify the variable name on the screen that appears.
List Memory (List 1 ~ List 26)	You can store data in a range of cells in a single row or a single column in list memory. While a range of cells in a single row or single column is selected, press F6 (\triangleright) F3 (STO) F2 (LIST), and then specify the list number on the screen that appears.
File Memory (File 1 to File 6)	You can store data in a range of cells that spans a multiple rows and columns in file memory. While a range of cells is selected, press F6 (\triangleright) F3 (STO) F3 (FILE), and then specify the file number on the screen that appears. The first column of the selected range is stored in the specified file as List 1, the second column is saved as List 2, and so on.
Matrix Memory (Mat A ~ Mat Z)	You can store data in a range of cells that spans a multiple rows and columns in matrix memory. While a range of cells is selected, press F6 (\triangleright) F3 (STO) F4 (MAT), and then specify the matrix name on the screen that appears. The first column of the selected range is stored in the specified matrix as List 1, the second column is saved as List 2, and so on.

Important!

The following describes what happens if you try to store data in memory when a cell does not contain any data, when a cell contains text, or when ERROR is displayed for a cell.

- If you are assigning data to a variable, an error occurs.
- If you are storing data in list memory, file memory, or matrix memory, 0 is written into the applicable cell(s).

● Example: To store column data in list memory

1. In a single column, select the range of cells you want to store in list memory.

- For example, you could select A1:A10.

2. Press **F6** (\triangleright) **F3** (STO) **F2** (LIST).

- This will display a screen like the one shown to the right.
The "Cell Range" setting will show the range of cells you selected in step 1.

```
Store In List Memory
Cell Range: A1:A10
List[1~26]: 1
```

3. Press \blacktriangledown to move the highlighting to "List[1-26]".

4. Input the List number (1 to 26) of the list memory where you want to store the data and then press **[EXE]**.
 - Performing the next step will overwrite any data currently stored under the list memory number you specified here with the data in the range of cells specified by “CellRange”.
5. Press **[F6]** (EXE) or the **[EXE]** key to store the data.

■ Recalling Data from Memory to a Spreadsheet

The following table shows an overview of the recall operations for each type of memory. For details about each operation, see the example operations following the table.

Memory Type	Recall Operation
List Memory (List 1 ~ List 26)	You can recall data from a specified list memory to a range of cells in a single row or a single column. While the first cell of the range in a single row or single column is selected, press [F6] (▷) [F4] (RCL) [F1] (LIST), and then specify the list number on the screen that appears. Whether the data is recalled in a column direction or row direction depends on the Setup screen’s “Move” setting (page 2-16).
File Memory (File 1 ~ File 6)	You can recall data from a specified file memory to the spreadsheet. Select the cell you want to be the upper left corner of the recalled data and then press [F6] (▷) [F4] (RCL) [F2] (FILE). Next, specify the file memory number on the screen that appears.
Matrix Memory (Mat A ~ Mat Z)	You can recall data from a specified matrix memory to the spreadsheet. Select the cell you want to be the upper left corner of the recalled data and then press [F6] (▷) [F4] (RCL) [F3] (MAT). Next, specify the matrix name on the screen that appears.

● Example: To recall data from a matrix memory to a spreadsheet

1. On the spreadsheet, select the upper left cell of the range where you want the recalled data to be input.
2. Press **[F6]** (▷) **[F4]** (RCL) **[F3]** (MAT).
 - This will display a screen like the one shown to the right. The “1st Cell” setting will show the name of the cell you selected in step 1.
3. Input the name (A to Z) of the matrix memory whose data you want to recall and then press **[EXE]**.
4. Press **[F6]** (EXE) or **[EXE]** to recall the data.

Recall From Mat. Mem	
Mat Name	:H
1st Cell	:A1

Important!

When recalling list memory, file memory, or matrix memory data, an error will occur if the recalled data runs outside the allowable range of the spreadsheet (A1:Z999).

Chapter 8 Memory Manager

Your calculator has two memory areas: Main Memory and Storage Memory.

The main memory is a work area where you can input data, perform calculations, and run programs. Data in the main memory is relatively safe, but it can be deleted by batteries going dead or when you perform a full reset.

The storage memory uses “flash memory,” so data is safe even when power is interrupted. Normally, you should use the storage memory for data you need to store securely for long periods, loading data into the main memory only when you need it.

You can also load an SD card into the calculator's card slot and use SD card memory as well.

1. Using the Memory Manager

From the Main Menu, select the **MEMORY** icon to enter the **MEMORY** mode.

- {**MAIN**} ... {displays main memory information}
- {**SMEM**} ... {displays storage memory information}
- {**SD**} ... {displays SD card memory information}
- {**BKUP**} ... {main memory backup}
- {**OPT**} ... {storage memory, SD card optimization}



Memory Information Screen

The memory information screen shows information about one memory at a time: the calculator's main memory or storage memory, or the SD card memory.

When this memory information screen is displayed:	Press this key:
Main memory	[F1] (MAIN)
Storage memory	[F2] (SMEM)
SD card memory	[F3] (SD)

- Use the cursor \blacktriangle and \blacktriangledown keys to move the highlighting and check the number of bytes used by each type of data.
- Line 7 shows how many bytes of memory are currently unused in the currently selected memory (main, storage, or SD card).
- On the main memory screen, < > indicates a data group. On the storage memory and SD card screens, [] indicates folders.
- If the name of a file transferred to storage memory from your computer or other source has a file name that is more than eight characters long, its name will be abbreviated to eight characters when displayed on the storage memory information screen (Example: AAAABBBBCC.txt > AAAABB~1.txt). Also, if a file name extension has more than three characters, everything after the third character of the file name extension will be trimmed off.
- Up to 200 files per folder can be displayed on the storage memory screen or the SD card screen. If a folder has more than 200 files and you need to display them all, divide them among multiple folders so the total number of files in a single folder is not greater than 200.
- When a Storage Memory or SD card memory folder contents are displayed, the applicable path will be shown in brackets ([]) in the top line.

Moving the highlighting to a data group or folder and pressing **[EXE]** will display the data group or folder contents. Pressing **[EXIT]** will return to the previous screen.

When the contents of a storage memory or SD card folder are displayed, the first line of the screen shows the name of the folder.

The following data can be checked.

Main Memory

Data Name	Contents
ALPHA MEM	Alpha letter variables
<F-MEM>	Function memory group
F-MEM n ($n = 1$ to 20)	Function memory
<LISTFILE>	List file group
LIST n ($n = 1$ to 26, and Ans)	List memory contents
LIST FILE n ($n = 1$ to 6)	List file
<MATRIX>	Matrix group
MAT n ($n = A$ to Z, and Ans)	Matrix
<PICTURE>	Picture memory group
PICT n ($n = 1$ to 20)	Picture memory
<PROGRAM>	Program group
Each program name	Programs
SETUP	Setup data
STAT	Stat result data
<STRING>	String memory group
STR n ($n = 1$ to 20)	String memory
SYSTEM	OS and data shared by applications (clipboard, replay, history, etc.)

Data Name	Contents
<S-SHEET>	Spreadsheet group
Each spreadsheet name	Spreadsheet data
<V-WIN>	V-Window memory group
V-WIN n ($n = 1$ to 6)	V-Window memory

Storage Memory, SD Card*¹

Data Name	Contents
*.g1m or .g2m file names	Data items listed in the Main Memory table that has been copied to storage memory or an SD card. The names of these files have the extension “.g1m” or “.g2m”.
Folder names	Enclosed in square brackets ([]).
Unknown	Area that is unusable due to writing error, etc.

*¹ “No Data” is displayed when there is no data in storage memory or on the SD card. The message “No Card” indicates there is no SD card loaded in the calculator.

■ Creating a Folder in Storage Memory or on an SD Card

• To create a new folder

1. While storage memory or SD card memory data is on the display, press **[F4]** (MK • F) to display the folder name input screen.

2. Input up to eight characters for the name you want to give to the folder.

- Only the following characters are supported: A through Z, ', ~, 0 through 9

Inputting any invalid character will cause an “Invalid Name” error.

- An “Invalid Name” also occurs if the name you input is already being used by an existing file.

- To cancel folder creation, press **[EXIT]**.

3. Press **[EXE]** to create the folder and return to the storage memory or SD card memory information screen.

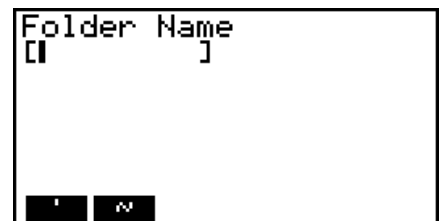

- This calculator supports nesting of folders up to three levels only.
- Though you can create folders on your computer nested to more than three levels in storage memory or on the SD card, this calculator will display only up to the third level. In this case you will be able to see folders stored in a level three folder, but you will not be able to open them.

- Selecting a folder stored in a level three folder and then performing the delete operation (page 8-7) will delete the selected (level 4) folder and everything inside it.

• To rename a folder

1. On the storage memory or SD card memory information screen, select the folder you want to rename.
2. Press **[F5]** (RN•F) to display the rename folder screen.
 - From here, perform the procedure from step 2 under “To create a new folder”.

■ Selecting Data

- Press **[F1]** (SEL) to select the currently highlighted item, which is indicated by the black selection pointer (▶) appearing next to it. Pressing **[F1]** (SEL) again will deselect the item, causing the selection pointer to disappear.
- You can select multiple files, if you want.

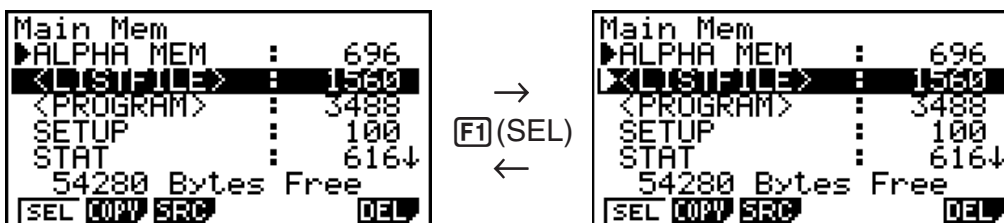

- Selecting a group or folder also selects everything inside of it. Deselecting a group or folder deselects all of its contents.

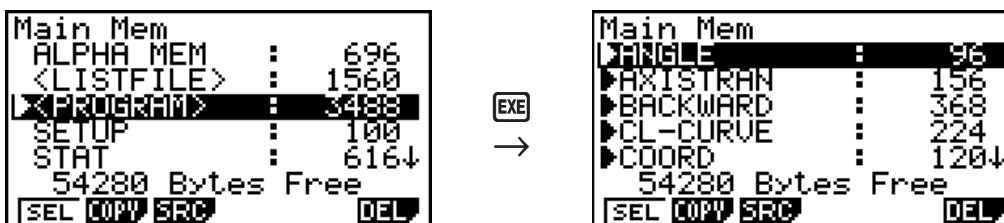

- If you select one or more individual items inside of a data group or folder, the black selection pointer (▶) appears next to each item, while a white selection pointer (▷) appears next to the group or folder name.

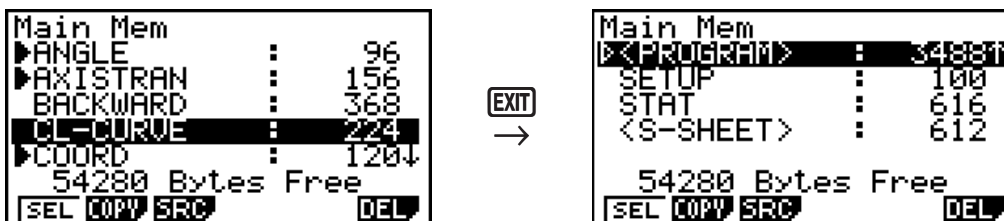

- Returning to the **MEMORY** mode initial screen deselects all currently selected items.

■ Copying Data

• To copy from main memory to storage memory

Note

- The following procedure saves the selected data into a single file. You assign a name to the file, which is stored in storage memory.

1. On the main memory data information screen, select the data you want to copy.
2. Press **F2** (COPY).

- This displays the storage memory/SD card selection screen.*1



3. Press **1** to select storage memory or **2***2 to select SD card.

- This displays the folder selection screen.

4. Use **▲** and **▼** to select the folder where you want to copy the data and then press **F1** (OPEN).



5. Press **F1** (SV•AS).

- This displays the file name input screen.

6. Input the file name you want to give to the file.

- To cancel the copy operation, press **EXIT**.

7. Press **EXE**.

- This copies the data.

8. The message "Complete!" appears when the copy operation is complete.

- Press **EXIT** to return to the screen displayed in step 1.

*1 Copying data from the storage memory or an SD card causes one of the screens shown below to appear.

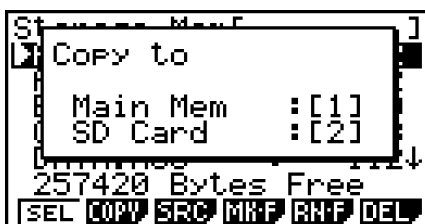

Pressing **1** selects main memory and copies the data, without displaying the folder selection screen.

The file name input screen does not appear when you copy data from storage memory or/and SD card to main memory.

*2 The "No Card" error message will appear if there is no SD card loaded in the calculator.

Note

Copying a file from storage memory to an SD card or from an SD card to storage memory will automatically change the file name to 8.3 format (<up to 8 alpha characters>.<up to 3 alpha characters>).

■ Error Checks During Data Copy

The following error checks are performed while a data copy operation is being executed.

Low battery check

The calculator performs low battery check before starting the data copy operation. If the battery is at Level 1, a low battery error occurs and the copy operation is not performed.

Available memory check

The calculator checks to see if there is enough free memory available to store the copied data. A “Memory Full” error occurs if there is not enough memory available.

Overwrite check

The calculator checks to see if there is any existing data at the copy destination with the same name as the data being copied.

An overwrite confirmation message appears if there is data with the same name.

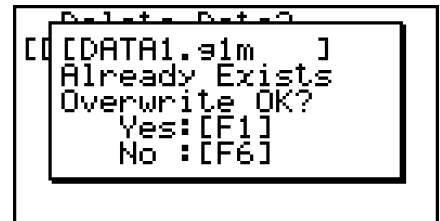

- **[F1]** (Yes) ... overwrites the existing data with the new data
- **[F6]** (No) ... advances to the next data item without copying the data with the same name
- Pressing **[AC]** will cancel the copy operation and return to the **MEMORY** mode initial screen.

Overwrite check is performed for the following types of data only. All other types of data are copied, without checking for data files with the same name.

- Programs
- Matrices
- List files
- Spreadsheet data

Overwrite check is performed for data of the same type only. If different types of data have the same name, the copy operation is performed without regard to the data with the same name.

Overwrite check applies only to the destination of the copy operation.

Type mismatch error check

Only files whose names have the extension .g1m or .g2m can be copied from storage memory to main memory. Any other type of file will cause an Invalid Type error.

■ Deleting Files

● To delete a main memory file

1. Display the main memory information screen.
 - See “Memory Information Screen” on page 8-1.
2. Select the file(s) you want to delete. You can select multiple files, if you want.
3. Press **[F6]** (DEL).
 - Press **[F1]** (Yes) to delete the file.
 - Press **[F6]** (No) to cancel the delete operation.

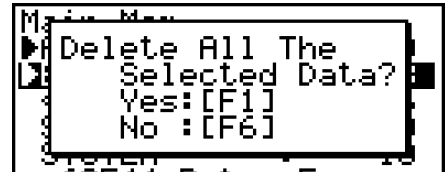

● To delete a storage memory file

1. Display the storage memory information screen.
 - See “Memory Information Screen” on page 8-1.
2. Select the file(s) you want to delete. You can select multiple files, if you want.
3. Press **[F6]** (DEL).
 - Press **[F1]** (Yes) to delete the file.
 - Press **[F6]** (No) to cancel the delete operation.

● To delete SD card files

1. Display the SD card memory information screen.
 - See “Memory Information Screen” on page 8-1.
2. Select the file(s) you want to delete. You can select multiple files, if you want.
3. Press **[F6]** (DEL).
 - Press **[F1]** (Yes) to delete the file.
 - Press **[F6]** (No) to cancel the delete operation.

■ Searching for a File

● To search for a file in the main memory

Example **To search for all files in the main memory whose names begin with the letter “S”**

1. Display the main memory information screen.
 - See “Memory Information Screen” on page 8-1.
2. Press **[F3]** (SRC).
 - Input the letter “S” for the keyword.

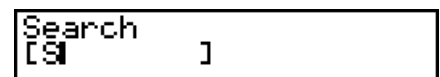

- The first file name that begins with the letter “S” appears highlighted on display.

Main Mem		
SETUP	:	1007i
STAT	:	616
<STRING>	:	24
SYSTEM	:	32
<S-SHEET>	:	1084

- You can input up to eight characters for the keyword.

• **To search for a file in the storage memory**

Example **To search for all files in the storage memory whose names begin with the letter “S”**

1. Display the storage memory information screen.
 - See “Memory Information Screen” on page 8-1.
2. Press **[F3]** (SRC).
 - Input the letter “S” for the keyword.
 - The first file name that begins with the letter “S” appears highlighted on display.

SMEMC		
SHADE.91m	:	4007i
TRIG.91m	:	348
VENN.91m	:	236

• **To search for a file in the SD card**

Example **To search for all files in the SD card whose names begin with the letter “R”**

1. Display the SD card memory information screen.
 - See “Memory Information Screen” on page 8-1.
2. Press **[F3]** (SRC).
 - Input the letter “R” for the keyword.
 - The first file name that begins with the letter “R” appears highlighted on display.

SD	[]
REF.91m	:	3727i	
SHADE.91m	:	336	
TRIG.91m	:	284	

- The message “Not Found” appears if there are no file names that match your keyword.

■ Backing Up Main Memory Data

• To back up main memory data

1. On the initial **MEMORY** mode screen press **[F4]**(BKUP).



2. Press **[F1]**(SAVE).

This displays the save location selection screen.

- **[1]** ... storage memory
- **[2]** ... SD card



3. Press **[1]** or **[2]**.

This displays a folder selection screen.

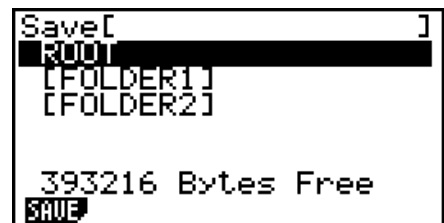

4. Use **[▲]** and **[▼]** to select the folder where you want to save the data and then press **[F1]**(OPEN).

5. Press **[F1]**(SAVE) to start the backup.

- Backup data is saved in a file named BACKUP.g2m.

The message “Complete!” appears when the backup operation is finished.

Press **[EXIT]** to return to the screen displayed in step 1.

The following message appears if there is already backup data in the storage memory.

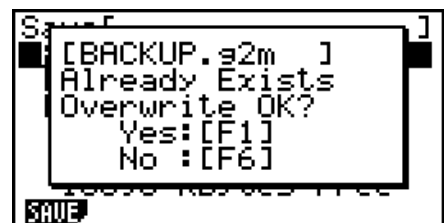

Press **[F1]**(Yes) to back up the data, or **[F6]**(No) to cancel the backup operation.

A “Memory Full” occurs when there is not enough space available in the storage memory to complete the backup operation.

• To restore backup data to the main memory

1. On the initial **MEMORY** mode screen press **[F4]**(BKUP).

- On the screen that appears, you can confirm whether or not there is backup data in the storage memory.

2. Press **F2**(LOAD).

This displays the restore source data selection screen.

- **1** ... Restore from storage memory
- **2** ... Restore from SD card



3. Press **1** or **2**.

This displays the folder selection screen.



4. Use **▲** and **▼** to select a folder and then press **F1**(OPEN).

5. Press **F1**(LOAD).^{*1}

- A message appears to confirm whether or not you really want to restore the backed up data.

^{*1} The message "No Data" will appear if there is no backup data stored in memory. Pressing **EXIT** will return the screen in step 1.

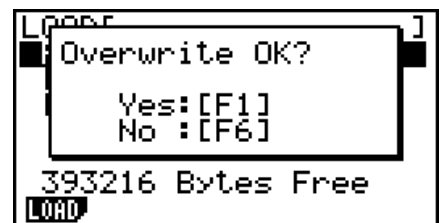

Press **F1**(Yes) to restore the data and delete any data currently in the area.

Press **F6**(No) to cancel the data backup operation.

The message "Complete!" appears when the restore operation is finished.

Press **EXIT** to return to the screen displayed in step 1.

■ Optimizing the Storage Memory or SD Card Memory

Storage memory or SD card memory can become fragmented after many store and load operations. Fragmentation can cause blocks of memory to become unavailable for data storage. Because of this, you should periodically perform the storage memory or SD card optimization procedure, which rearranges the data in the storage memory or SD card and makes memory usage more economical.

• To optimize the storage memory

1. On the initial **MEMORY** mode screen press **F5**(OPT).

2. Select the memory you want to optimize.

- **1** ... storage memory
- **2** ... SD card

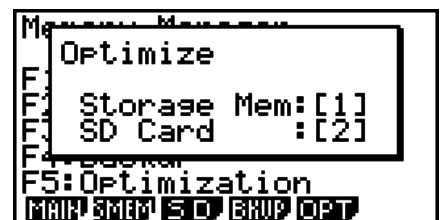

3. Press **[1]** or **[2]** to start optimization.



The message "Complete!" appears when the optimize operation is complete.

Press **[EXIT]** to return to the initial **MEMORY** mode screen.

- In some cases, the amount of free memory capacity may be unchanged when you check it after performing the optimization procedure. This does not indicate any problem with the calculator.

Chapter 9 System Manager

Use the System Manager to view system information and make system settings.

1. Using the System Manager

From the Main Menu, enter the **SYSTEM** mode and display the following menu items.

- **F1** (◀▶) ... {display contrast adjustment}
- **F2** (⏻) ... {Auto Power Off time setting}
- **F3** (LANG) ... {system language}
- **F4** (VER) ... {version}
- **F5** (RSET) ... {system reset operations}
- **F6** (▶) **F1** (BATT) ... {battery settings}
- **F6** (▶) **F5** (OS) ... {OS update}

```
System Manager
F1: Contrast
F2: Power Properties
F3: Language
F4: Version
F5: Reset
F6: Next Page
◀▶ ⏻ LANG VER RSET ▶
```

```
System Manager
F1: Battery Settings

F5: OS Update
F6: Next Page
BATT OS ▶
```

2. System Settings

■ Contrast Adjustment

While the initial **SYSTEM** mode screen is displayed, press **F1** (◀▶) to display the Contrast Adjustment screen.

- The ▶ cursor key makes display contrast darker.
- The ◀ cursor key makes display contrast lighter.
- **F1** (INIT) returns display contrast to its initial default.

Press **EXIT** or **SHIFT** **EXIT** (QUIT) to return to the initial **SYSTEM** mode screen.

You can adjust contrast while any screen is on the display by pressing **SHIFT** and then ▶ or ◀. To exit contrast adjustment, press **SHIFT** again.

■ Power Properties Settings

• To specify the Auto Power Off trigger time

While the initial **SYSTEM** mode screen is displayed, press **F2** (⏻) to display the Power Properties setting screen.

- **F1** (10) ... {10 minutes} (initial default setting)
- **F2** (60) ... {60 minutes}

```
Power Properties
Auto Power Off :10 Min.
Backlight Setting :Any key
Backlight Duration :30 Sec.
10 60
```

Press **EXIT** or **SHIFT** **EXIT** (QUIT) to return to the initial **SYSTEM** mode screen.

• To specify the backlight key

1. While the initial **SYSTEM** mode screen is displayed, press **F2** (**+ -**) to display the Power Properties setting screen.
2. Use **▲** and **▼** to select "Backlight Setting".
 - **F1** (LIGHT) ... {Backlight on/off: **SHIFT** **ALPHA** (LIGHT)}
 - **F2** (ANY) ... {Backlight on: Any key}
3. Press **EXIT** or **SHIFT** **EXIT** (QUIT) to return to the initial **SYSTEM** mode screen.

• To specify the backlight duration

1. On the initial **SYSTEM** mode screen, press **F2** (**+ -**) to display the Power Properties setting screen.
2. Use **▲** and **▼** to select "Backlight Duration".



- **F1** (10) ... {turns off the backlight 10 seconds after the last key operation is performed}
 - **F2** (30) ... {turns off the backlight 30 seconds after the last key operation is performed} (initial default setting)
 - **F3** (Always) ... {leaves the backlight turned on until the backlight key is pressed or until the calculator is turned off}
3. Press **EXIT** or **SHIFT** **EXIT** (QUIT) to return to the initial **SYSTEM** mode screen.

■ System Language Setting

Use LANG to specify the display language for built-in applications.

• To select the message language

1. From the initial **SYSTEM** mode screen, press **F3** (LANG) to display the Message Language selection screen.
2. Use the **▲** and **▼** cursor keys to select the language you want, and then press **F1** (SEL).
3. The pop up window appears using the language you selected. Check the contents and then press **EXIT**.
4. Press **EXIT** or **SHIFT** **EXIT** (QUIT) to return to the initial **SYSTEM** mode screen.

■ Version List

Use VER (version) to display the operating system version. You can also register the user name you want.

• To display version information



1. On the initial **SYSTEM** mode screen, press **F4** (VER) to display the Version list.

2. Use  and  to scroll the screen. The contents of the list are shown below.

- Operating system version
- Message languages and versions
- User name







3. Press  or   (QUIT) to return to the initial **SYSTEM** mode screen.

● To register a user name

1. While the Version list is displayed, press  (NAME) to display the user name input screen.
2. Input up to eight characters for the user name you want.
3. After inputting the name, press  to register it, and return to the Version list.
 - If you want to cancel user name input and return to the Version list without registering a name, press .







■ Reset



1. While the initial **SYSTEM** mode screen is displayed, press  (RSET) to display the Reset Screen 1.
 -  (STUP) ... {setup initialization}
 -  (MAIN) ... {main memory data clear}*1
 -  (SMEM) ... {storage memory data clear}
 -  (ALL) ... {return of all memories to factory defaults}*1
 -  (SD) ... {SD card format}





The following table shows the functions of the function keys. You can use the function keys to delete the specific data you want.

Function Key Functions

	Initialize Setup Information	Delete Main Memory Data	Delete Storage Memory Data	Format SD Card
 (STUP)	<input type="radio"/>			
 (MAIN)	<input type="radio"/>	<input type="radio"/> *1		
 (SMEM)			<input type="radio"/>	
 (ALL)	<input type="radio"/>	<input type="radio"/> *1	<input type="radio"/>	
 (SD)				<input type="radio"/>

*1  (MAIN) clears all preset program data in main memory.  (ALL) clears all data in main memory and then restores preset program data to its initial factory default state.

2. Press the function key that corresponds to the reset operation you want to perform.
3. In response to the confirmation message that appears, press  (Yes) to perform the reset operation you specified, or  (No) to cancel.

4. A message appears to let you know when the reset operation is complete.

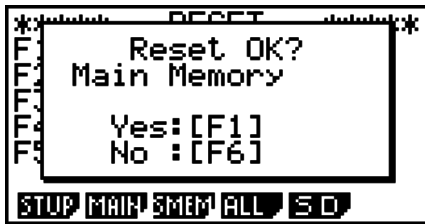

Screen produced when
[F2] (MAIN) is pressed in step 2.



Screen produced when
[F2] (MAIN) is pressed in step 2.

■ Battery Settings

Important!

Whenever you replace batteries, be sure to perform the operation below to specify the type of batteries you are loading.

• To change the battery type

1. From the initial **SYSTEM** mode screen, press
[F6] (▷) [F1] (BATT).

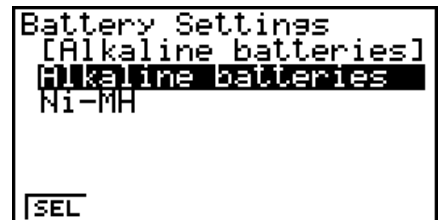

2. Use ▲ and ▼ to move the highlighting to the battery type that matches the batteries you are using and then press [F1] (SEL).

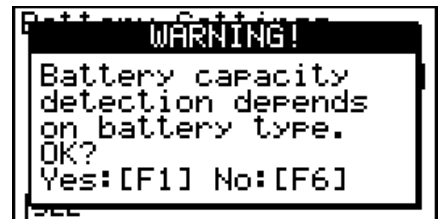

3. Press [F1] (Yes) to change the setting, or [F6] (No) to cancel without changing anything.

■ OS Update

You can update the operating system by connecting the calculator to a computer. For details, see the text of releases that are issued when a new operating system version is released.

Chapter 10 Data Communication

This chapter explains how to transfer data between a calculator and a computer.

1. Establishing a Connection between the Calculator and a Personal Computer

Establishing a USB connection between the calculator and a computer will cause the computer to recognize the calculator's storage memory as a mass storage drive. After a connection is established, data can be transferred between the calculator and computer using computer operations only.

■ Minimum Computer System Requirements

The following are the minimum requirements for a computer to exchange data with the calculator.

- USB port
- Running one of the following operating systems.

Windows® XP Home Edition (SP3)

Windows® XP Professional (32-bit, SP3)

Windows Vista® (32-bit, SP1 or later)

Windows® 7 (32-bit, 64-bit)

Windows® 8/8.1 (32-bit, 64-bit)

Mac OS X (10.6, 10.7, 10.8, 10.9)

■ Connecting and Disconnecting with a Computer in the Mass Storage Mode

Use the USB cable that comes with the calculator to connect to your computer.

Important!

Never touch the USB cable plugs and screen while a data communication operation is in progress. Static electricity from your fingers can cause data communication to be terminated.

● To establish a connection between the calculator and a computer

1. If there is removable media (USB flash drive, etc.) connected to the computer, disconnect it.
2. Start up your computer.
3. Open the calculator's USB port cap.

Important!

- Splash resistance, dust resistance, and shock resistance are maximized while the USB port cap is fully and securely closed.
- Even a slight amount of foreign matter (a single hair, speck of dust, etc.) on the contact surface of the USB port cap can allow moisture and/or dust to get into the interior of the calculator.

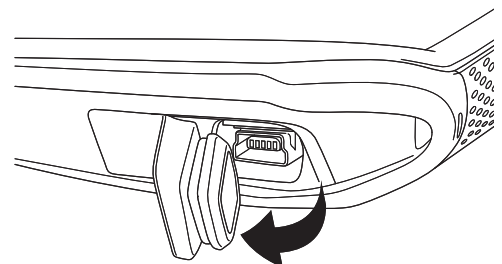

4. After starting up your computer, use the USB cable to connect it to the calculator.

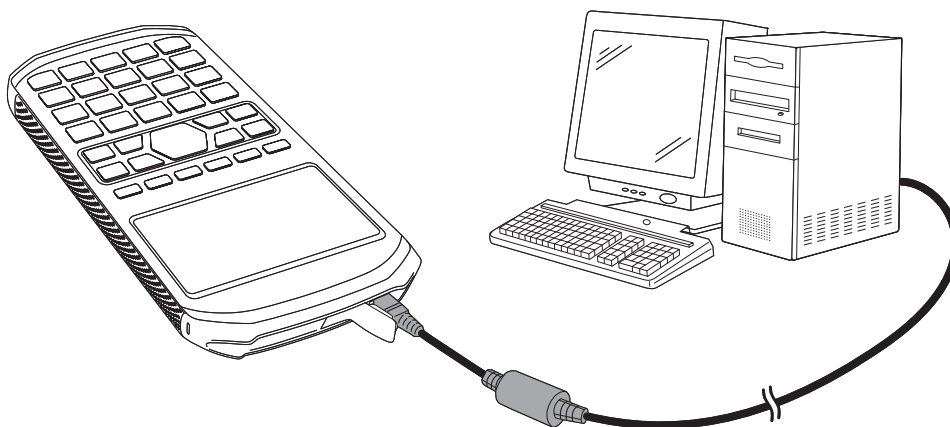

- The calculator will turn on automatically and the “Select Connection Mode” screen will appear.



5. Press **[F1]** (USB Flash).

- The message “Preparing USB” will appear on the calculator screen. Stand by and do not perform any operation on the calculator. Establishing a connection between the calculator and a computer will cause the screen shown nearby to appear.

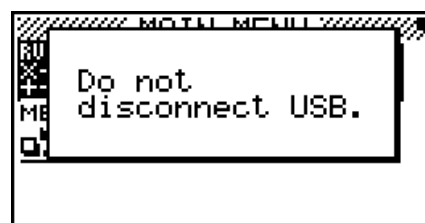

6. On the computer, open the “Removable disk” drive (referred to here as the “calculator drive”).

- The calculator drive will appear inside My Computer under Windows XP, and inside Computer under Windows Vista or Windows 7, 8, or 8.1. Use Windows Explorer to open the calculator drive.
- If you are using a computer running Mac OS X, an “Untitled” drive icon will appear on the Mac desktop. Double-click the icon to open it.
- The calculator drive represents calculator storage memory.

7. Perform the required operation on your computer to transfer the data.

- For details about data transfer operations, see “Transferring Data between the Calculator and a Personal Computer” (page 10-3).

• To terminate the connection between the calculator and a computer

1. If the calculator is connected to a Windows computer, note the drive letter (E, F, G, etc.) assigned to the calculator drive.
2. Depending on the type of operating system your computer is running, perform one of the following operations.
 - Windows: Click the “Safely Remove Hardware” icon in the task tray in the lower right corner of the display. On the menu that appears, select “USB mass storage device” whose letter matches the calculator drive letter you noted in step 1 above. Check to make sure the “Safe To Remove Hardware” message is displayed.

- Mac OS: Drag the “Untitled” drive icon to the Eject icon (Trash icon). Check to make sure that the “Untitled” drive icon is no longer on your desktop.
3. The message “Updating Main Memory” will appear on the calculator screen. Stand by and do not perform any operation on the calculator. The message “Complete!” will appear after updating of main memory is complete. To close the message dialog box, press **[EXIT]**.
 4. Disconnect the USB cable from the calculator.

2. Transferring Data between the Calculator and a Personal Computer

- **To transfer data between the calculator and a computer**

1. Before transferring the data to a computer, use the calculator’s **MEMORY** mode (page 8-1) to copy it from the calculator’s main memory to its storage memory.
2. Connect the calculator and computer, and open the calculator drive on the computer.
 - See “To establish a connection between the calculator and a computer” (page 10-1).

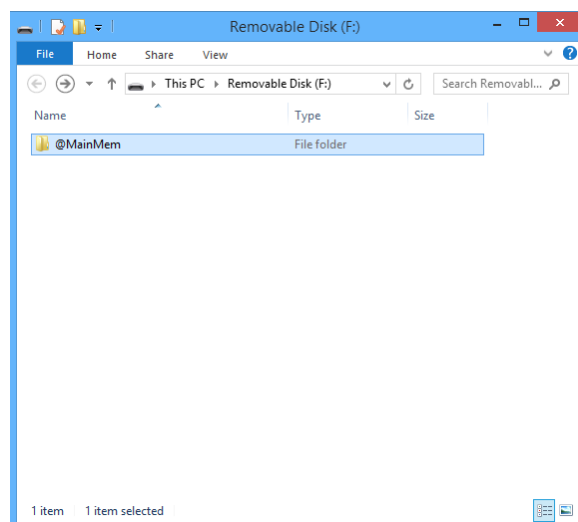

3. Copy, edit, delete, or add files as desired.
 - Use the same file operations that you normally do on your computer.
 - The @MainMem folder of the calculator drive is used to transfer calculator program data between the calculator and computer. For more information, see the following section titled “Editing Program Data on a Computer”.
 - When copying a calculator data file (filename extension g1m or g2m) from the computer to the calculator drive, do note copy it to the @MainMem folder. Copy it to a different location.
4. After you finish all the operations you want to perform, terminate the connection between the calculator and a computer.
 - See “To terminate the connection between the calculator and a computer” (page 10-2).
5. If you copied calculator data files from the computer to the calculator in step 3 of this procedure, copy those files to calculator main memory.
 - Use the calculators **MEMORY** mode (page 8-1) to copy the files to main memory.

Note

- Copying a file to the storage memory can cause the connection between the calculator and computer to be dropped. If this happens, enter the **MEMORY** mode and execute an Optimize operation (page 8-10), and then re-establish a connection between the calculator and computer.

■ Editing Program Data on a Computer

You can perform an operation on the calculator to convert programs you create with it to text file data, which you can then edit on a computer. After you finish editing the text file, you can then place it into the @MainMem\PROGRAM\ on the removable disk drive. Then when you terminate the USB connection between the calculator and computer, the text file will automatically be converted to a program file, which will be stored in the PROGRAM group in calculator main memory. After conversion, the text file will automatically be moved to the calculator storage memory folder named SAVE-F.

For details about the rules that govern file names and other conversion issues, see “Program and Text File Conversion Rules” (page 6-7).

● To use your computer to edit a program created on the calculator

1. Convert a program you created with the **PRGM** mode to a text file (“To convert a program to a text file”, page 6-8).
2. Connect the calculator and computer, and open the calculator drive on the computer.
3. Display the contents of the @MainMem\PROGRAM folder, and then use a text editor to open the text file you converted from a program in step 1 of this procedure.
 - If you are running Windows you could use Notepad, etc. With the Mac OS, you can use TextEdit, etc.
4. Perform the required edits.
 - For information about calculator commands and their corresponding special character strings, see “CASIO Scientific Function Calculator Special Commands ⇔ Text Conversion Table” (page 6-34).
5. After you are finished editing, save and close the text file.
 - Save the edits under a different file name, as required. If you use Save As to save your edits, be sure to save the new file in @MainMem\PROGRAM\.
 - Be sure to save the file in ASCII or ANSI code txt format.
6. Terminate the connection between the calculator and a computer
 - See “To terminate the connection between the calculator and a computer” (page 10-2).

■ USB Connection Precautions

- Depending on the operating system your computer is running, perform one of the following operations on the computer to terminate a connection with the calculator.
 - Windows: Click the “Safely Remove Hardware” icon in the task tray in the lower right corner of the display. On the menu that appears, select “USB mass storage device”. Check to make sure the “Safe To Remove Hardware” message is displayed.
 - Mac OS: Drag the “Untitled” drive icon to Trash. Check to make sure that the “Untitled” drive icon is no longer on your desktop.
- Never use a computer operation to format the calculator drive. Doing so will cause a “File System ERROR” message to appear on the calculator screen after you terminate the USB connection between the calculator and computer. When this happens, you will not be able to start up the calculator unless you perform an Initialize All operation, which deletes all data currently in calculator memory. For details, see “File System ERROR” (page α -7).
- When copying a file from your computer’s local disk to the calculator drive, it may take several minutes before copying starts. This is because copying automatically performs optimization of the calculator’s storage memory. It does not indicate malfunction. For information about storage memory optimization, see “Optimizing the Storage Memory or SD Card Memory” (page 8-10).
- A USB connection between the calculator and a computer may be terminated automatically if the computer enters a power save mode, sleep mode, or any other standby state.

Chapter 11 Using SD Cards and SDHC Cards

This calculator supports use of SD memory cards and SDHC memory cards. In this manual, all mentions of “SD card” refer to both SD memory cards and SDHC memory cards.



You can use SD cards to store calculator data. You can copy main memory and storage memory data to and from an SD card.

Important!

- Use only an SD memory card or SDHC memory card. Operation is not guaranteed when another type of memory card is used.
- Be sure to read the user documentation that comes with an SD card before using it.
- Certain types of SD cards can slow down processing speeds.
- Certain types of SD cards and operating conditions can shorten battery life.
- SD cards have a write protect switch, which protects against accidental erasure of data. Note, however, that you need to remove write protection before you can copy data to or delete data from, or format a disk that is write-protected.
- Static electric charge, electric noise, and other phenomena can delete or corrupt card data unexpectedly. Because of this you should always backup valuable data to other media (CD-R, CD-RW, hard disk, etc.)

1. Using an SD Card

Important!

- Always turn off the calculator before inserting or removing an SD card.
- Note that a card needs to be oriented correctly (proper side must be facing upwards, the proper end must be inserted) when inserting it into the calculator. Trying to force card into the slot while it is oriented incorrectly can damage the card and slot.

• To insert an SD card

1. Open the SD card cap on the right side of the calculator.

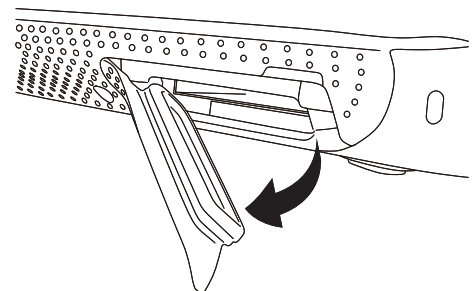

2. With the front of the SD card facing upwards (in the direction of the display side of the calculator), slide the card into the calculator's slot as shown in the illustration below.

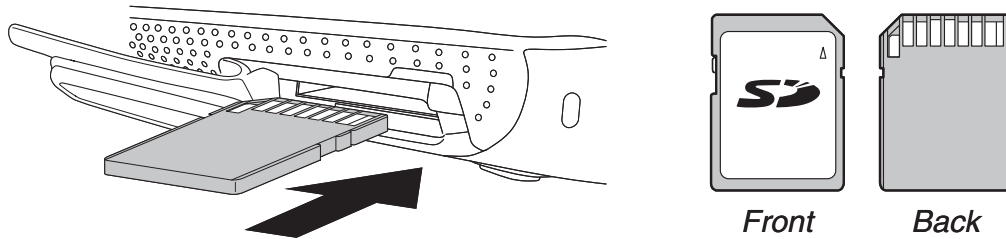

3. Replace the SD card cap and close it securely.

Important!

- Splash resistance, dust resistance, and shock resistance are maximized while the SD card cap is fully and securely closed.
- Even a slight amount of foreign matter (a single hair, speck of dust, etc.) on the contact surface of the SD card cap can allow moisture and/or dust to get into the interior of the calculator.
- Never insert anything other than SD cards into the card slot. Doing so can damage the calculator.
- Should water or any foreign matter ever get into the card slot, immediately turn off the calculator, remove its batteries, and contact your original retailer or nearest CASIO authorized service center.

• To remove the SD card

1. Open the SD card cap on the right side of the calculator.
2. Press in on the SD card and then release it.
 - This will cause the card to pop part way out of the slot.
3. Grasp the SD card with your fingers and pull it out of the slot.

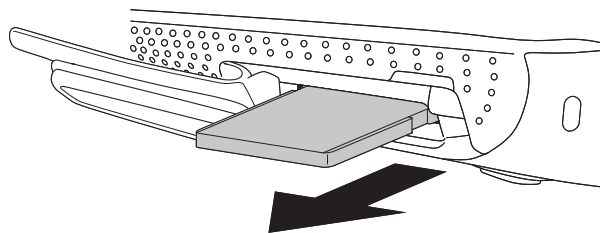

4. Replace the SD card cap and close it securely.

Important!

- Never remove the SD card while data is being transferred to it. Doing so not only stops the data you are transferring to the card from being saved, it can also corrupt SD card contents.
- Exerting undue force when removing an SD card can damage the card slot or the card.

2. Formatting an SD Card

- Use the procedure under “Reset” (page 9-3) to format an SD card.

3. SD Card Precautions during Use

- SD card problems can normally be corrected by reformatting the card. However, it is always a good idea to take along more than one SD card to avoid data storage problems.
- Card formatting (initialization) is recommended before using a new SD card for the first time.
- If an SD card has been formatted on a computer or other device, you can use it as-is without reformatting. A computer or other device also will be able to use an SD card that has been formatted with the calculator.
- Never perform any of the following operations while the SD card is being accessed.
 - Removing the SD card
 - Connecting or disconnecting a USB cable
 - Turning off the calculator
- Note that an SD card needs to be oriented correctly (proper side must be facing upwards, the proper end must be inserted) when inserting it into the calculator. Trying to force an SD card into the slot when it is oriented incorrectly can damage the card and slot.
- Use of certain SD cards while calculator battery power is low can cause the display to go blank without displaying the low battery warning message. If this happens, replace the batteries.

■ Supported SD Cards

SD Memory Cards	Maximum capacity: 2 GB
SDHC Memory Cards	Maximum capacity: 32 GB

Important!

The time required for data writing and reading depends on the type of the SD card being used.

For detailed information (specifications, features, etc.) about the SD card, contact the SD card manufacturer.

Appendix

1. Power Supply

This calculator is powered by four AAA-size alkaline batteries LR03 (AM4), or four nickel-metal hydride batteries.

If the following message appears on the display, immediately turn off the calculator and replace the batteries as instructed.

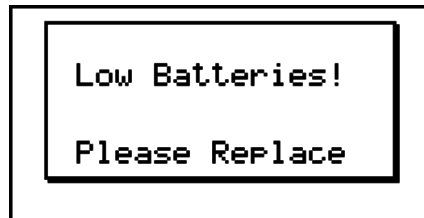

If you try to continue using the calculator, it will automatically turn off in order to protect memory contents. You will not be able to turn power back on until you replace batteries.

Be sure to replace the batteries at least once every one year, no matter how much you use the calculator during that time.

The batteries that come with this calculator discharge slightly during shipment and storage. Because of this, they may require replacement sooner than the normal expected battery life.

■ Replacing Batteries

Precautions:

Incorrectly using batteries can cause them to burst or leak, possibly damaging the interior of the calculator. Note the following precautions:

- Use only the batteries that are specifically listed in “Recommended Batteries” (page α -2). Never use any other type of batteries.
- Be sure that the positive (+) and negative (-) poles of each battery are facing in the proper directions.
- Never mix batteries of different brands or models.
- When using nickel-metal hydride batteries, make sure to fully charge the batteries before use.
- For details about how to charge nickel-metal hydride batteries, see the user documentation that comes with the batteries.
- Note that the amount of operation between charges provided by nickel-metal hydride batteries may be shorter than the life of alkaline batteries.
- Never mix batteries of different types.
- Never mix old batteries and new ones.
- Never leave dead batteries in the battery compartment.
- Remove the batteries if you do not plan to use the calculator for long periods.
- Never try to recharge the batteries supplied with the calculator.

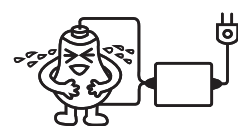
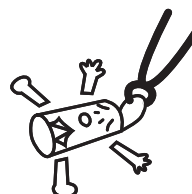

α

- Do not expose batteries to direct heat, let them become shorted, or try to take them apart. (Should a battery leak, clean out the battery compartment of the calculator immediately, taking care to avoid letting the battery fluid come into direct contact with your skin.)

Keep batteries out of the reach of small children. If swallowed, consult with a physician immediately.

• Recommended Batteries

AAA-size alkaline batteries:

LR03 (AM4)

AAA-size nickel-metal hydride batteries:

Duracell rechargeable

Energizer rechargeable

SANYO eneloop

• To replace the batteries

- Never turn on the calculator while the batteries are removed or not loaded correctly. Doing so can cause memory data to be deleted and malfunction of the calculator. If mishandling of batteries causes such problems, correctly load batteries and then perform the restart operation to resume normal operation.
- Be sure to replace all four batteries with new ones.

1. Press **SHIFT** **AC/ON** (OFF) to turn off the calculator.

Warning!

- Be sure to turn the calculator off before replacing batteries. Replacing batteries with power on will cause data in memory to be deleted.
 - During the remainder of this procedure, take care that you do not accidentally press the **AC/ON** key.
2. Turn over the calculator and rotate the center knob to the left.
 3. Lift up the battery compartment cover (①) and remove it (②).

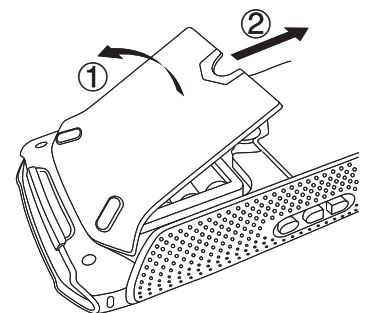

4. Remove all four of the old batteries.

- Pull on the ribbon inside the battery compartment to remove the top battery. Next, remove the remaining batteries.

5. Load a new set of four batteries, making sure that their positive (+) and negative (-) ends are facing in the proper directions.

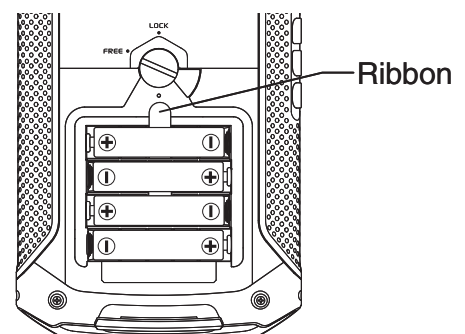

6. Replace the battery compartment cover. While pressing down on the cover, rotate the center knob to the right.

Important!

- You may not be able to rotate the center knob if you do not press down on the battery compartment cover as you do.
- Splash resistance, dust resistance, and shock resistance are maximized while the battery compartment cover is fully and securely closed.
- Even a slight amount of foreign matter (a single hair, speck of dust, etc.) on the contact surface of the battery compartment cover can allow moisture and/or dust to get into the interior of the calculator.

7. Press  to turn on power.

- If the figures on the display appear too light and hard to see after you turn on power, adjust the contrast.

■ About the Auto Power Off Function

Calculator power turns off automatically if you do not perform any operation within the Auto Power Off trigger time you specify. You can specify either 10 minutes or 60 minutes as the trigger time (see “Power Properties Settings” on page 9-1). To restore power, press .

2. Error Message Table

Message	Meaning	Countermeasure
Syntax ERROR	<ul style="list-style-type: none"> Illegal syntax Attempt to input an illegal command 	<ul style="list-style-type: none"> Press [EXIT] to display the error and make necessary corrections.
Ma ERROR	<ul style="list-style-type: none"> Calculation result exceeds the display range. Calculation is outside the input range of a function. Mathematical error (division by zero, etc.) Sufficient precision could not be obtained for Σ calculation, differential calculation, etc. Solution could not be obtained for equation calculation, etc. 	<ul style="list-style-type: none"> Check input values and make corrections to ensure that values are within allowable limits.
Go ERROR	<ul style="list-style-type: none"> ① No corresponding Lbl n for Goto n. ② No program stored in program area Prog "file name". 	<ul style="list-style-type: none"> ① Correctly input a Lbl n to correspond to the Goto n, or delete the Goto n if not required. ② Store a program in program area Prog "file name", or delete the Prog "file name" if not required.
Nesting ERROR	<ul style="list-style-type: none"> Nesting of subroutines by Prog "file name" exceeds 10 levels. 	<ul style="list-style-type: none"> Ensure that Prog "file name" is not used to return from subroutines to main routine. If used, delete any unnecessary Prog "file name". Trace the subroutine jump destinations and ensure that no jumps are made back to the original program area. Ensure that returns are made correctly.
Stack ERROR	<ul style="list-style-type: none"> Execution of calculations that exceed the capacity of the stack for numeric values or stack for commands. 	<ul style="list-style-type: none"> Simplify the formulas to keep stacks within 10 levels for the numeric values and 26 levels for the commands. Divide the formula into two or more parts.
Memory ERROR	<ul style="list-style-type: none"> Operation or memory storage operation exceeds remaining memory capacity. 	<ul style="list-style-type: none"> Simplify the data you are trying to store to keep it within the available memory capacity. Delete no longer needed data to make room for the new data.
Argument ERROR	<ul style="list-style-type: none"> Incorrect argument specification for a command that requires an argument. 	<ul style="list-style-type: none"> Correct the argument.
Dimension ERROR	<ul style="list-style-type: none"> Illegal dimension used during matrix or list calculations. 	<ul style="list-style-type: none"> Check the matrix or list dimension.

Message	Meaning	Countermeasure
Range ERROR	<ul style="list-style-type: none"> The spreadsheet cell range was exceeded by paste, recall, or other cell operation. 	<ul style="list-style-type: none"> Repeat the procedure taking care that the cell range is not exceeded.
Condition ERROR	<ul style="list-style-type: none"> Execution of a calculation or function before all conditions required for execution are met. 	<ul style="list-style-type: none"> Check the conditions and make any necessary corrections.
Non-Real ERROR	<ul style="list-style-type: none"> Calculation that produces a complex number when Real is specified for the Complex Mode setting on the Setup screen, even though the argument is a real number. 	<ul style="list-style-type: none"> Change the Complex Mode setting to something other than Real.
Complex Number In List	<ul style="list-style-type: none"> List containing complex number used in a calculation or operation for which complex number data is invalid. 	<ul style="list-style-type: none"> Change all data in the list to real numbers.
Complex Number in Matrix	<ul style="list-style-type: none"> Matrix containing complex number used in a calculation or operation for which complex number data is invalid. 	<ul style="list-style-type: none"> Change all data in the matrix to real numbers.
Can't Simplify	<ul style="list-style-type: none"> Fraction simplification was attempted using the ►Simp function (page 3-19), but simplification could not be performed using the specified divisor. Example: Specifying a divisor of 3 to simplify the fraction 4/8. 	<ul style="list-style-type: none"> Specify a different divisor or execute ►Simp without specifying any divisor.
Can't Solve! Adjust initial value or bounds. Then try again	<ul style="list-style-type: none"> A Solve calculation could not obtain a solution within the specified range. 	<ul style="list-style-type: none"> Change the specified range. Correct the input expression.
No Variable	<ul style="list-style-type: none"> No variable within a Solve equation. 	<ul style="list-style-type: none"> Input a Solve equation that includes a variable.
Conversion ERROR	<ul style="list-style-type: none"> Attempting to use the unit conversion command to convert between two units in different categories. Executing a conversion calculation using the same command twice in a conversion expression. 	<ul style="list-style-type: none"> In a conversion expression, specify two different commands that are in the same category.
USB Connect ERROR	<ul style="list-style-type: none"> USB cable connection broken during data communication. 	<ul style="list-style-type: none"> Use the USB cable to correctly connect the calculator and computer (or other device).
Memory Full	<ul style="list-style-type: none"> Calculator memory became full while data was being received. 	<ul style="list-style-type: none"> Delete some data stored in calculator memory and try again.

Message	Meaning	Countermeasure
Time Out	<ul style="list-style-type: none"> A Solve calculation or integration calculation was unable to satisfy convergence conditions. 	<ul style="list-style-type: none"> If you are performing a Solve calculation, try changing to the initial default estimated value. If you are performing an integration calculation, try changing to a larger <i>tol</i> value.
Circular ERROR	<ul style="list-style-type: none"> There is a circular reference (such as “=A1” in cell A1) in the spreadsheet. 	<ul style="list-style-type: none"> Change cell contents to remove the circular references.
Invalid Name	<ul style="list-style-type: none"> The file name you input includes invalid characters. 	<ul style="list-style-type: none"> Use the correct characters to input a valid file name.
Invalid Type	<ul style="list-style-type: none"> An illegal data type is specified. 	<ul style="list-style-type: none"> Specify valid data.
Storage Memory Full	<ul style="list-style-type: none"> The storage memory is full. 	<ul style="list-style-type: none"> Delete unneeded data.
No Card	<ul style="list-style-type: none"> There is no SD card loaded in the calculator. 	<ul style="list-style-type: none"> Load an SD card.
SD Card Full	<ul style="list-style-type: none"> The SD card is full. 	<ul style="list-style-type: none"> Delete unneeded data.
Invalid file name or folder name.	<ul style="list-style-type: none"> Data or folders that are supported by this calculator cannot be found on the SD card. 	<ul style="list-style-type: none"> Replace the card with one that contains data/folders that are supported by this calculator.
Invalid Card	<ul style="list-style-type: none"> A card that is not compatible with the calculator is loaded. 	<ul style="list-style-type: none"> Replace the card with a compatible card.
Card is protected	<ul style="list-style-type: none"> The SD card is write protected. 	<ul style="list-style-type: none"> Remove write protection.
Data ERROR	<ul style="list-style-type: none"> A data error occurred. 	<ul style="list-style-type: none"> Check to make sure you are writing correct type of data and try again.
Card ERROR	<ul style="list-style-type: none"> An SD card error occurred. 	<ul style="list-style-type: none"> Remove and correctly insert the SD card and try again. If this error occurs again, re-format the SD card.
Data is protected	<ul style="list-style-type: none"> The Read Only attribute of the SD card loaded in the calculator has been turned on using a computer, etc. 	<ul style="list-style-type: none"> Turn off the SD card's Read Only attribute.
CSV error in row [A] or column [B]	<ul style="list-style-type: none"> The imported CSV file included data that cannot be converted. 	<ul style="list-style-type: none"> Use your computer to check the row A, column B data in the file and change it to data that can be converted.

Message	Meaning	Countermeasure
Sub-folders in this folder cannot be displayed	<ul style="list-style-type: none"> In the MEMORY mode, a level 3 nested storage memory folder is displayed, and it contains a level 4 nested folder. (The level 4 folder will be displayed, but it cannot be opened.) 	<ul style="list-style-type: none"> Use your computer*¹ to store all files you want to access in the top three folder nesting levels.
File System ERROR	<ul style="list-style-type: none"> The calculator memory file system is corrupted or the storage memory format is one that cannot be read by the calculator. 	<ul style="list-style-type: none"> After reading the information under “Important!” below, perform an Initialize All operation as described in “Reset” (page 9-3). <p>Important! Performing an Initialize All operation will delete all data in calculator memory, including language data. If you need the data in calculator memory, use the USB cable to connect the calculator to a computer and copy all of the data you want to keep to your computer’s hard disk*¹ before performing the Initialize All operation.</p>

*¹ For details about using a computer to perform storage memory file and folder operations, see “To transfer data between the calculator and a computer” (page 10-3).

3. Input Ranges

Function	Input range for real number solutions	Internal digits	Precision	Notes
$\sin x$ $\cos x$ $\tan x$	(DEG) $ x < 9 \times (10^9)^\circ$ (RAD) $ x < 5 \times 10^7 \pi \text{rad}$ (GRA) $ x < 1 \times 10^{10} \text{grad}$	15 digits	As a rule, precision is ± 1 at the 10th digit.*	However, for $\tan x$: $ x \neq 90(2n+1)$: DEG $ x \neq \pi/2(2n+1)$: RAD $ x \neq 100(2n+1)$: GRA
$\sin^{-1}x$ $\cos^{-1}x$	$ x \leq 1$	"	"	
$\tan^{-1}x$	$ x < 1 \times 10^{100}$	"	"	
$\sinh x$ $\cosh x$	$ x \leq 230.9516564$	"	"	
$\tanh x$	$ x < 1 \times 10^{100}$	"	"	
$\sinh^{-1}x$ $\cosh^{-1}x$	$ x < 1 \times 10^{100}$	"	"	
	$1 \leq x < 1 \times 10^{100}$	"	"	
$\tanh^{-1}x$	$ x < 1$	"	"	
$\log x$ $\ln x$	$1 \times 10^{-99} \leq x < 1 \times 10^{100}$	"	"	• Complex numbers can be used as arguments.
10^x	$-1 \times 10^{100} < x < 100$	"	"	
e^x	$-1 \times 10^{100} < x \leq 230.2585092$	"	"	• Complex numbers can be used as arguments.
\sqrt{x}	$0 \leq x < 1 \times 10^{100}$	"	"	• Complex numbers can be used as arguments.
x^2	$ x < 1 \times 10^{50}$	"	"	
$1/x$	$ x < 1 \times 10^{100}, x \neq 0$	"	"	• Complex numbers can be used as arguments.
$\sqrt[3]{x}$	$ x < 1 \times 10^{100}$	"	"	
$x!$	$0 \leq x \leq 69$ (x is an integer)	"	"	
nPr nCr	Result $< 1 \times 10^{100}$ n, r (n and r are integers) $0 \leq r \leq n, n < 1 \times 10^{10}$	"	"	
Pol (x, y)	$\sqrt{x^2 + y^2} < 1 \times 10^{100}$	"	"	
Rec (r, θ)	$ r < 1 \times 10^{100}$ (DEG) $ \theta < 9 \times (10^9)^\circ$ (RAD) $ \theta < 5 \times 10^7 \pi \text{rad}$ (GRA) $ \theta < 1 \times 10^{10} \text{grad}$	"	"	However, for $\tan \theta$: $ \theta \neq 90(2n+1)$: DEG $ \theta \neq \pi/2(2n+1)$: RAD $ \theta \neq 100(2n+1)$: GRA

Function	Input range for real number solutions	Internal digits	Precision	Notes
$\circ, ', ''$ \leftarrow $\circ, ', ''$	$ a , b, c < 1 \times 10^{100}$ $0 \leq b, c$	15 digits	As a rule, precision is ± 1 at the 10th digit.*	
	$ x < 1 \times 10^{100}$ Sexagesimal display: $ x < 1 \times 10^7$			
$\wedge(x^y)$	$x > 0$: $-1 \times 10^{100} < y \log x < 100$ $x = 0$: $y > 0$ $x < 0$: $y = n, \frac{m}{2n+1}$ (m, n are integers) However; $-1 \times 10^{100} < y \log x < 100$	"	"	<ul style="list-style-type: none"> Complex numbers can be used as arguments.
$\sqrt[x]{y}$	$y > 0$: $x \neq 0$ $-1 \times 10^{100} < \frac{1}{x} \log y < 100$ $y = 0$: $x > 0$ $y < 0$: $x = 2n+1, \frac{2n+1}{m}$ ($m \neq 0$; m, n are integers) However; $-1 \times 10^{100} < \frac{1}{x} \log y < 100$	"	"	<ul style="list-style-type: none"> Complex numbers can be used as arguments.
$a^{b/c}$	Total of integer, numerator and denominator must be within 10 digits (includes division marks).	"	"	

* For a single calculation, calculation error is ± 1 at the 10th digit. (In the case of exponential display, calculation error is ± 1 at the last significant digit.) Errors are cumulative in the case of consecutive calculations, which can also cause them to become large. (This is also true of internal consecutive calculations that are performed in the case of $\wedge(x^y)$, $\sqrt[x]{y}$, $x!$, $\sqrt[3]{x}$, nPr , nCr , etc.)

In the vicinity of a function's singular point and point of inflection, errors are cumulative and may become large.

Function	Input range
Binary, octal, decimal, hexadecimal calculation	Values fall within following ranges after conversion: DEC: $-2147483648 \leq x \leq 2147483647$ BIN: $1000000000000000 \leq x \leq 1111111111111111$ (negative) $0 \leq x \leq 1111111111111111$ (0, positive) OCT: $20000000000 \leq x \leq 37777777777$ (negative) $0 \leq x \leq 17777777777$ (0, positive) HEX: $80000000 \leq x \leq FFFFFFFF$ (negative) $0 \leq x \leq 7FFFFFFF$ (0, positive)

4. Specifications

Variables: 28

Calculation range:

$\pm 1 \times 10^{-99}$ to $\pm 9.999999999 \times 10^{99}$ and 0. Internal operations use 15-digit mantissa.

Exponential display range: Norm 1: $10^{-2} > |x|, |x| \geq 10^{10}$

Norm 2: $10^{-9} > |x|, |x| \geq 10^{10}$

Program capacity: 62,000 bytes (max.)

Storage memory capacity: 1MB (max.)

Power supply: Four AAA-size batteries (LR03 (AM4)), or four nickel-metal hydride batteries

Power consumption: 0.8 W

Approximate battery life:

- New alkaline batteries or fully-charged new nickel-metal hydride batteries used in an ambient temperature of 25°C.
- Operating Conditions
 - (a) Continuous main menu display
Backlight lit for the first 30 seconds of each hour, and then turned off after that.
 - (b) Repeat of one-hour cycle of (1), (2), and (3) below.
 - (1) Main Menu display for 5 minutes
 - (2) **PRGM** mode calculation for 5 minutes
 - (3) 50 minutes of **PRGM** mode display
 Backlight lit for the first 30 seconds of the three-step operation, and then turned off after that.
 - (c) Repeat of one-hour cycle of (1), (2), and (3) below.
 - (1) Main Menu display for 5 minutes
 - (2) Five minutes of SD card use
 - (3) 50 minutes of **PRGM** mode display
 Backlight lit for the first 30 seconds of the three-step operation, and then turned off after that.
 - (d) Power off

Operating Conditions Batteries	(a)	(b)	(c)	(d)
Four AAA-size alkaline batteries LR03 (AM4)	280 hours	200 hours	65 hours	1 year
Four nickel-metal hydride batteries (recommended type only)	170 hours (Reference)	120 hours (Reference)	35 hours (Reference)	/

* Battery life can be reduced dramatically by the conditions described below.

- Continuous program calculation execution
- Manufacturer and type of battery used, differences between individual batteries
- Operating conditions (applications used)
- Calculator settings (backlight duration)
- SD memory card manufacturer, type, and usage conditions (SD memory card access frequency)

Auto power off:

Power is automatically turned off approximately 10 minutes or 60 minutes after last operation.

Ambient temperature range: -5°C to 45°C (23°F to 113°F)

Data Communications: USB port (USB 1.1 standards)

Dimensions: 21.0 mm (H) \times 88.5 mm (W) \times 177.5 mm (D)
 $7/8$ " (H) \times $3\ 1/2$ " (W) \times 7" (D)

Approximate weight: 250 g (8.8 oz) (including batteries)

5. Preset Programs

Your calculator includes preset programs for performing civil engineering and surveying calculations. These preset programs can be run, edited, and deleted, the same way as programs created by you.

Note

- For information about the procedures required to run, edit, and delete programs, refer to Chapter 6 of this manual.
- Each program uses variables (A through Z) when running. Note that running a program may replace the value currently assigned to a variable with a different one.
- When running a program, refer to the figures and formulas in the following section (Preset Program List), and enter the required values for calculation. Note that you will not be able to obtain correct results if you enter a value that is not consistent with the illustration shown for the applicable program.

■ Preset Program List

Program name: AXISTRAN

Function: Axis Transformation

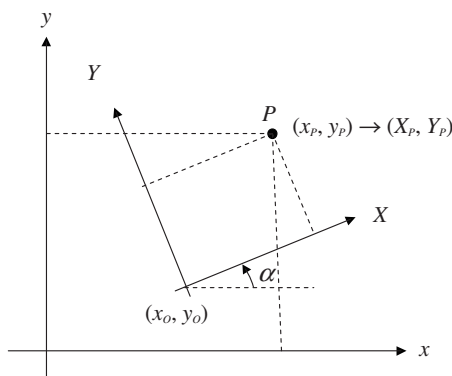

Input: $(x_P, y_P), (x_O, y_O), \alpha$

Output: (X_P, Y_P)

Formula: $X_P = (x_P - x_O) \cos \alpha + (y_P - y_O) \sin \alpha$

$Y_P = (y_P - y_O) \cos \alpha - (x_P - x_O) \sin \alpha$

Program name: R-TRIG

Function: Right Triangle Trigonometry

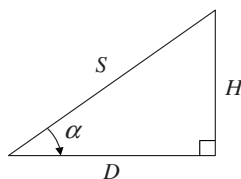

Input: S, α

Output: D, H

Formula: $D = S \cos \alpha$

$H = S \sin \alpha$

Program name: PYTHAGOR

Function: Pythagorean

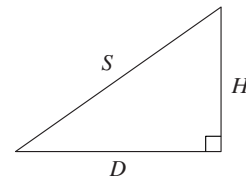

Input: D, H

Output: S

Formula: $S = \sqrt{D^2 + H^2}$

Program name: COORD

Function: Coordinate Calculation

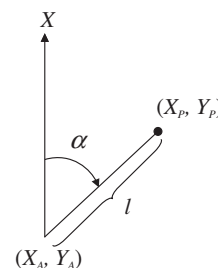

Input: $(X_A, Y_A), \alpha, l$

Output: (X_P, Y_P)

Formula: $X_P = l \cos \alpha + X_A$

$Y_P = l \sin \alpha + Y_A$

Program name: ANGLE

Function: Bearing Angle

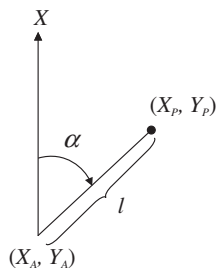

Input: $(X_A, Y_A), (X_P, Y_P)$

Output: α, l

Formula: $(l, \alpha) = Pol(X_P - X_A, Y_P - Y_A)$

Program name: TRAVERSE

Function: Traverse Calculation

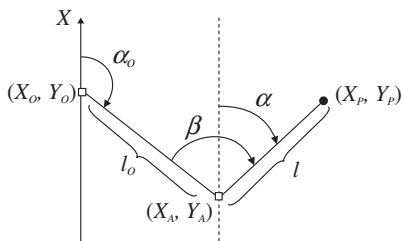

Input: $(X_A, Y_A), \alpha_O, \beta, l$

Output: $(X_P, Y_P), \alpha$

Formula: $\alpha = \alpha_O - 180^\circ + \beta$

$$X_P = l \cos \alpha + X_A$$

$$Y_P = l \sin \alpha + Y_A$$

Program name: INVERSE

Function: Inverse Calculation

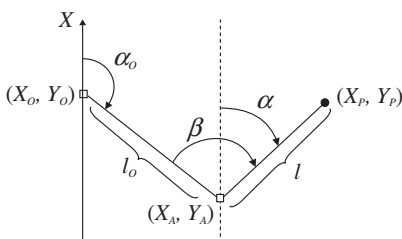

Input: $(X_A, Y_A), (X_O, Y_O), (X_P, Y_P)$

Output: $l_O, \alpha_O, l, \alpha, \beta$

Formula: $(l_O, \alpha_O) = Pol(X_A - X_O, Y_A - Y_O)$

$$(l, \alpha) = Pol(X_P - X_A, Y_P - Y_A)$$

$$\beta = \alpha - \alpha_O + 180^\circ$$

Program name: DECENTER

Function: Decentering

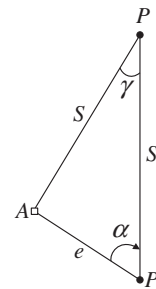

Input: α, e, S'

Output: γ, S

$$\text{Formula: } \gamma = \tan^{-1} \left(\frac{e \sin \alpha}{S' - e \cos \alpha} \right)$$

$$S = \sqrt{S'^2 + e^2 - 2S'e \cos \alpha}$$

Program name: MID-ORD

Function: Middle Ordinate

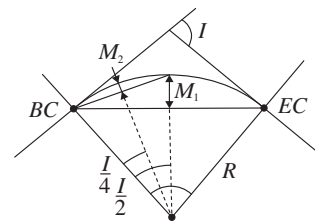

Input: I, R

Output: M_1, M_2

$$\text{Formula: } M_1 = R \left(1 - \cos \frac{I}{2} \right)$$

$$M_2 = R \left(1 - \cos \frac{I}{4} \right)$$

Program name: S-CURVE

Function: Single Curve

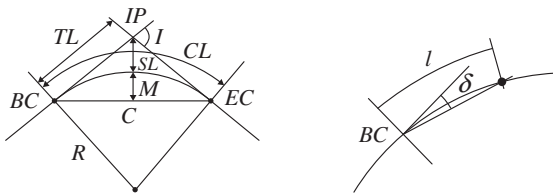

Input: I, R, l

Output (and Function):

$$TL = R \tan \frac{I}{2}$$

$$\delta = \frac{l}{2R} \cdot \frac{180^\circ}{\pi}$$

$$CL = R \cdot I \cdot \frac{\pi}{180^\circ}$$

$$C = 2R \cdot \sin \frac{I}{2}$$

$$SL = R \left(\sec \frac{I}{2} - 1 \right)$$

$$M = R \left(1 - \cos \frac{I}{2} \right)$$

Program name: CL-CURVE

Function: Clothoid Curve

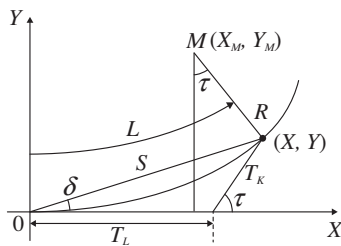

Input: R : Curve radius

A : Parameter

Output: $L, \tau, (X, Y), (X_M, Y_M), T_L, T_K, S, \delta$

Formula:

$$L = \frac{A^2}{R}$$

$$\tau = \frac{L}{2R}$$

$$X = \frac{A}{\sqrt{2}} \int_0^\tau \frac{\cos \tau}{\sqrt{\tau}} d\tau$$

$$Y = \frac{A}{\sqrt{2}} \int_0^\tau \frac{\sin \tau}{\sqrt{\tau}} d\tau$$

$$X_M = X - R \sin \tau$$

$$Y_M = Y + R \cos \tau$$

$$T_K = Y \operatorname{cosec} \tau$$

$$T_L = X - Y \cot \tau$$

$$S = \sqrt{X^2 + Y^2}$$

$$\delta = \tan^{-1} \frac{Y}{X}$$

Program name: V-CURVE

Function: Vertical Curve

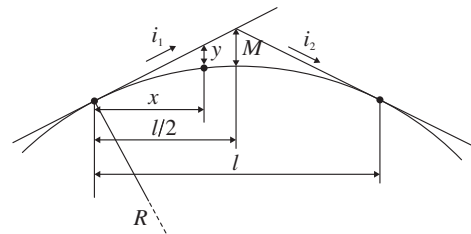

Input: i_1, i_2, R, x

Output (and Function):

$$l = \frac{R}{100} |(i_1) - (i_2)|$$

$$M = \frac{|(i_1) - (i_2)|}{800} l$$

$$y = \frac{|(i_1) - (i_2)| x^2}{200l}$$

Program name: FORWARD

Function: Forward Intersection

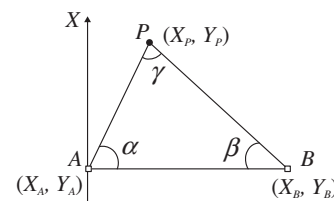

Input: $(X_A, Y_A), \alpha, (X_B, Y_B), \beta$

However, you need to input a value in the following range: $0^\circ < \gamma < 180^\circ$

Output: (X_P, Y_P)

$$\text{Formula: } X_P = \frac{X_A \cot \beta + X_B \cot \alpha + (Y_B - Y_A)}{\cot \alpha + \cot \beta}$$

$$Y_P = \frac{Y_A \cot \beta + Y_B \cot \alpha + (X_A - X_B)}{\cot \alpha + \cot \beta}$$

Program name: BACKWARD

Function: Backward Intersection

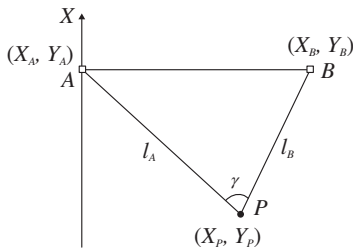
Input: $(X_A, Y_A), l_A, (X_B, Y_B), l_B$ However, you need to input a value in the following range: $0^\circ < \gamma < 180^\circ$ Output: (X_P, Y_P)

Formula:

$$X_P = \frac{X_A \cot \beta + X_B \cot \alpha + (Y_A - Y_B)}{\cot \alpha + \cot \beta}$$

$$Y_P = \frac{Y_A \cot \beta + Y_B \cot \alpha + (X_B - X_A)}{\cot \alpha + \cot \beta}$$

$$\alpha = \cos^{-1} \left(\frac{l_A^2 + (X_B - X_A)^2 + (Y_B - Y_A)^2 - l_B^2}{2l_A \sqrt{(X_B - X_A)^2 + (Y_B - Y_A)^2}} \right)$$

$$\beta = \cos^{-1} \left(\frac{l_B^2 + (X_B - X_A)^2 + (Y_B - Y_A)^2 - l_A^2}{2l_B \sqrt{(X_B - X_A)^2 + (Y_B - Y_A)^2}} \right)$$

Program name: INTSEC1

Function: Coordinates of intersection

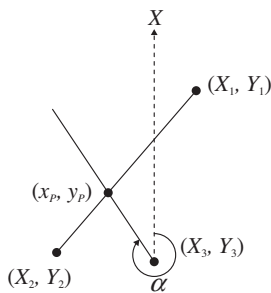
Input: $(X_1, Y_1), (X_2, Y_2), (X_3, Y_3), \alpha$ Output: (x_P, y_P) Formula: $x_P = \frac{nX_3 - mX_1 + Y_1 - Y_3}{n - m}$

$$y_P = m(x_P - X_1) + Y_1$$

$$m = \frac{Y_2 - Y_1}{X_2 - X_1}$$

$$n = \tan \alpha$$

Program name: INTSEC2

Function: Coordinates of intersection

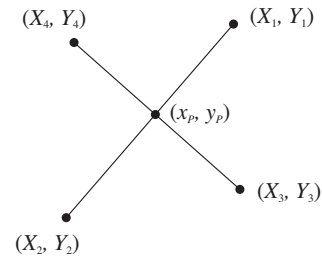
Input: $(X_1, Y_1), (X_2, Y_2), (X_3, Y_3), (X_4, Y_4)$ Output: (x_P, y_P) Formula: $x_P = \frac{nX_3 - mX_1 + Y_1 - Y_3}{n - m}$

$$y_P = m(x_P - X_1) + Y_1$$

$$m = \frac{Y_2 - Y_1}{X_2 - X_1}$$

$$n = \frac{Y_4 - Y_3}{X_4 - X_3}$$

Program name: V-LINE

Function: Calculation of Vertical Line and Distance

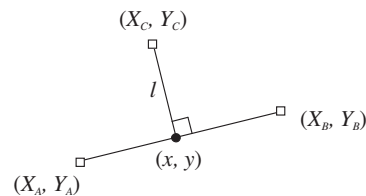
Input: $(X_A, Y_A), (X_B, Y_B), (X_C, Y_C)$ Output: $(x, y), l$

Formula:

$$x = \frac{mX_A + \frac{1}{m}X_C - Y_A + Y_C}{m + \frac{1}{m}} \quad \left(m = \frac{Y_A - Y_B}{X_A - X_B} \right)$$

$$y = Y_A + m(x - X_A)$$

$$l = \sqrt{(X_C - x)^2 + (Y_C - y)^2}$$

Program name: TRIANGLE

Function: Area of Triangle

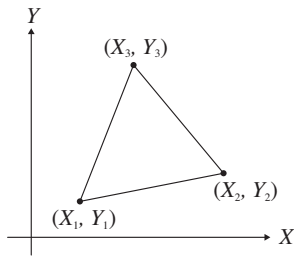

Input: $(X_1, Y_1), (X_2, Y_2), (X_3, Y_3)$

Output: S

Formula:

$$S = \left| \frac{(X_1 - X_2)(Y_3 - Y_1) + (X_1 - X_3)(Y_1 - Y_2)}{2} \right|$$

Program name: QUADRANG

Function: Area of Quadrangle

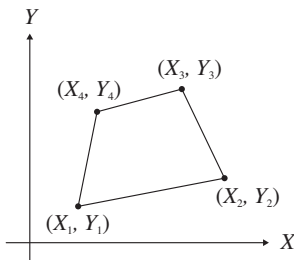

Input: $(X_1, Y_1), (X_2, Y_2), (X_3, Y_3), (X_4, Y_4)$

Output: S

Formula:

$$S = \left| \frac{(X_1 - X_2)(Y_3 - Y_1) + (X_1 - X_3)(Y_4 - Y_2) + (X_1 - X_4)(Y_1 - Y_3)}{2} \right|$$

Program name: HERON

Function: Heron Formula

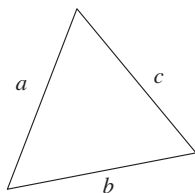

Input: a, b, c

Output: S

Formula: $S = \sqrt{s(s-a)(s-b)(s-c)}$

$$s = \frac{a+b+c}{2} \quad \begin{pmatrix} a+b > c > 0 \\ b+c > a > 0 \\ c+a > b > 0 \end{pmatrix}$$

Program name: STADIA

Function: Stadia Calculation

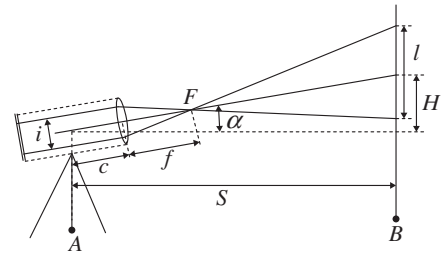

Input: $K \left(= \frac{f}{i} \right), C (= c + f), l, \alpha$

Output: S, H

Formula: $S = Kl \cos^2 \alpha + C \cos \alpha$

$$H = \frac{1}{2} Kl \sin 2\alpha + C \sin \alpha$$

However, $0^\circ \leq \alpha \leq 90^\circ$

Canadian Regulatory Information
Information concernant la Réglementation Canadienne

This Class B digital apparatus complies with Canadian ICES-003.

Cet appareil numérique de la classe B est conforme à la norme NMB-003 du Canada.



Manufacturer:
CASIO COMPUTER CO., LTD.
6-2, Hon-machi 1-chome, Shibuya-ku, Tokyo 151-8543, Japan
Responsible within the European Union:
CASIO EUROPE GmbH
Casio-Platz 1, 22848 Norderstedt, Germany



This mark applies in EU countries only.



CASIO®

CASIO COMPUTER CO., LTD.

6-2, Hon-machi 1-chome
Shibuya-ku, Tokyo 151-8543, Japan

One or more of the following patents may be used in the product.
U.S.Pats. 5,539,867

SA1403-B

© 2014 CASIO COMPUTER CO., LTD.

Download from www.Somanuals.com. All Manuals Search And Download.

Free Manuals Download Website

<http://myh66.com>

<http://usermanuals.us>

<http://www.somanuals.com>

<http://www.4manuals.cc>

<http://www.manual-lib.com>

<http://www.404manual.com>

<http://www.luxmanual.com>

<http://aubethermostatmanual.com>

Golf course search by state

<http://golfingnear.com>

Email search by domain

<http://emailbydomain.com>

Auto manuals search

<http://auto.somanuals.com>

TV manuals search

<http://tv.somanuals.com>