

ISOTOPE[®] Owner's Manual

READ AND SAVE THESE INSTRUCTIONS!

Safety and the proper operation of your Casablanca fan both require a thorough knowledge of the product and proper installation. Therefore, before attempting to install and operate your Casablanca fan, read this Owner's Manual completely and carefully. Retain this manual and other included documentation for future reference.

CAUTION: To avoid possible electrical shock, make certain that electricity is turned off at the circuit breaker or fuse box before attempting any installation procedure.

CONTENTS

INTRODUCTION	4
Before You Start	4
Safe Use	4
MOUNTING RECOMMENDATIONS	5
General Guidelines	5
Getting Started	5
FAN INSTALLATION	6
Ceiling Mounting PLATE Installation	6
MOTOR HOUSING INSTALLATION	7
Blade Installation	11
Light bulb and GLASS Installation	12
W-74 CONTROL INSTALLATION	13
W-74 OPERATION	15
TROUBLESHOOTING TIPS	19
CARE RECOMMENDATIONS	20
PRODUCT SPECIFICATIONS	20



PLEASE INSPECT ALL PACKAGING PRIOR TO DISCARDING!

Your Casablanca fan was crafted with pride and care and inspected thoroughly prior to shipment. Before you begin to assemble and install your Casablanca fan, remove all parts from the carton and check them against the Parts Guide in this manual.

Make sure all parts are included in the box using the Parts Guide on the following pages.

If there are missing or broken parts:

Call 1-888-227-2178 Monday through Friday, 7 a.m. to 4 p.m. PST. Your request will be handled immediately. Replacement parts will be sent to you via Federal Express.

Proper Parts Handling

Do not remove lightbulbs from their packaging until you are ready to install them.

Before discarding packaging materials, be certain that all parts have been removed.

Use a clean, dry paintbrush to remove small Styrofoam pieces that may remain after unpacking.

Do not brush Styrofoam into wiring cavities.

The blades in each pack are matched for equal weight to assure smooth fan operation. If more than one fan is being installed, do not mix blades from different cartons.

When cleaning, painting, or working near your fan, be cautious of the fan and blades.

Always turn power to the ceiling fan OFF before replacing lightbulbs or working on your fan.

Never insert anything into the path of the fan blades while the fan is in operation.

Never install a fan over a pool or spa.

Never operate a fan that has been damaged in any way.

Install the fan according to the instructions in this manual.

If the fan does not work:

Refer to the Troubleshooting Tips in this Owner's Manual.

Call Technical Support at 1-888-227-2178.

Contact your local Authorized Service Center.

Our Web site at www.casablancafanco.com contains additional information on Casablanca products, troubleshooting, and Authorized Dealer or Service Centers. Please do not return this product to the store.

RECORD MODEL AND SERIAL NUMBERS BEFORE INSTALLATION!

Please take a moment to locate the model number and serial number from your fan (see below) and record this information on the Warranty page inside the front cover of your Owner's Manual if it does not appear there already. These numbers are found on the motor identification plate affixed to the fan motor in the location shown below:

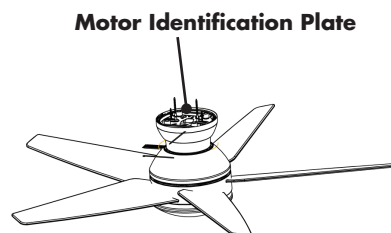



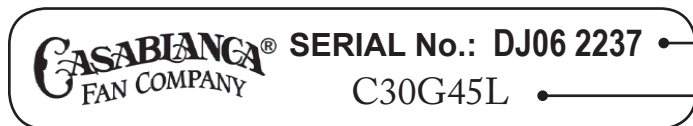
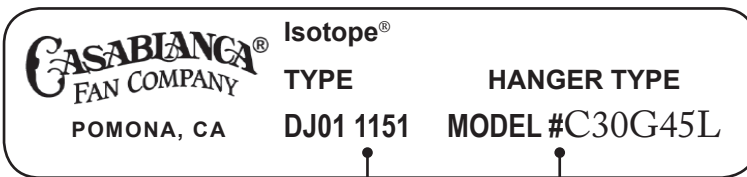









Motor Identification Plate



Serial Number

Model Number

Parts Guide

Item #	Description	Picture (not to scale)	Quantity
1.	Motor Housing		1
2.	Ceiling Mounting Plate		1
3.	Phillips Screwdriver		1
4.	1" x 8-32 Roundhead screws and Washers		2 EA
5.	1 1/2" Wood Screws and Washers		2 EA
6.	3" Wood Screws and Washers		2 EA
7.	Fan Mounting Screws		4
8.	Blades		5
9.	Blade Screws and Washers		16 EA
10.	Glass Shade		1
11.	50-watt Halogen Bulbs		2
12.	Direct•Touch W-74SL Remote Control and Hardware		1

INTRODUCTION BEFORE YOU START

- **CAUTION: RISK OF ELECTRICAL SHOCK!** Installation is to be in accordance with the National Electrical Code, ANSI/NFPA 70-1999, and local codes. If you are unfamiliar with the wiring codes, you should use a qualified electrician. To avoid overheating and possible damage to other equipment, do not install control to a receptacle, fluorescent light fixture, motor-operated appliance, or transformer-supplied appliance.
- This fan is designed to be installed on an existing electrical outlet box. The outlet box must be UL Listed for ceiling fan installations. If it is not, a new box must be installed.
- This ceiling fan requires a grounded electrical supply of 120 VAC, 60 Hz and a minimum 15 amp circuit. The maximum current requirement for the fan with light fixture is 1.67 amps. The fan uses about .83 amp or 100 watts. Maximum light current is about .83 amps or 100 watts of lighting.
- Where wire nuts are employed, be sure all bare wires are within the connectors. When installing the canopy, make sure all wires are within the canopy and that no wires are being pinched.
- **WARNING:** Do not bend the blade brackets when installing the brackets, balancing the blades, or cleaning the fan. Do not insert foreign objects in between the rotating fan blades.

Unpacking

Before assembling and installing your ceiling fan, remove all parts from the shipping cartons and check them against the parts listed in the Parts Guide. Before discarding packaging materials, be certain that all parts have been removed.

**For best performance and for your warranty to be valid,
use only genuine Casablanca blades, light fixtures, and accessories.**

SAFE USE

- The blades in each pack are matched for equal weight to assure smooth fan operation. If more than one fan is being installed, be careful not to mix blades from different cartons.
- Inspect the contents of your carton for possible shipping or handling damage. If parts are missing or damaged, call 1-888-227-2178.
- It is always a good idea to have an assistant to help with the installation.
- When cleaning, painting, or working near your fan, be very careful of the fan and blades. Always turn the power OFF to the ceiling fan before working on it or replacing lightbulbs.
- Never insert anything into the path of the fan blades while the fan is in operation.
- Never install a fan over a pool or spa.
- Never operate a fan that has been damaged in any way. For assistance in obtaining service, call Casablanca Fan Company at 1-888-227-2178 or contact your local authorized Casablanca dealer.

Fuse Box
(Remove fuse for the circuit you will be working on)

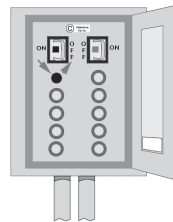

Circuit Breaker
(Trip breaker for the circuit you will be working on)

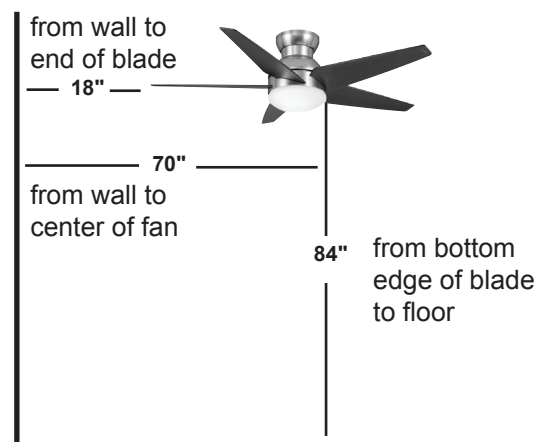
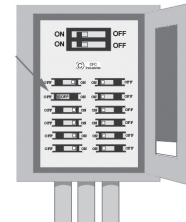

Dimensions indicated are the minimum allowable for proper installation.



MOUNTING RECOMMENDATIONS

GENERAL GUIDELINES

Before mounting your Casablanca fan, read the following helpful recommendations. The location of the fan, air circulation, and fan size are all important factors to consider before installation.

Location

Ceiling fans have practical uses in almost every room in your home. We suggest you follow these mounting recommendations as you decide where to install your Casablanca fan.

- This fan is not suitable for installation on a sloped ceiling.
- For safety reasons, the fan blades must be a minimum of 7' above the floor.
- Do not locate the fan in a doorway or above a swinging door.
- In any installation, the tips of the blades must be at least 18" from the wall in order to provide sufficient clearance for the blades.
- In bedrooms, fans work best when mounted above the foot of the bed.
- Over pool tables, be sure to provide plenty of clearance to avoid damage from pool cues.
- In kitchens be sure to allow for open cupboard doors to clear the fan blades.
- Do not install a fan close to, or over, a pool or spa. High humidity combined with corrosive gases will destroy the finish and warp the blades.

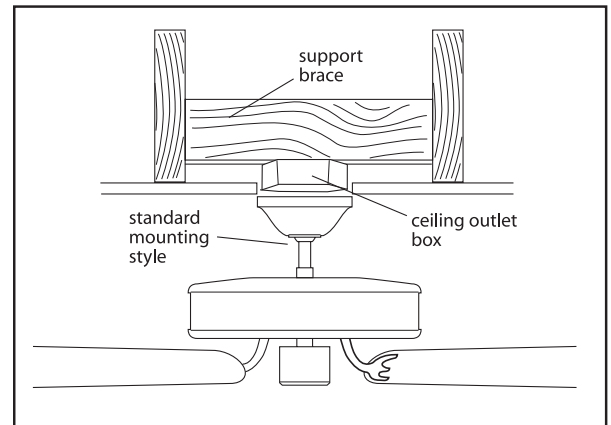
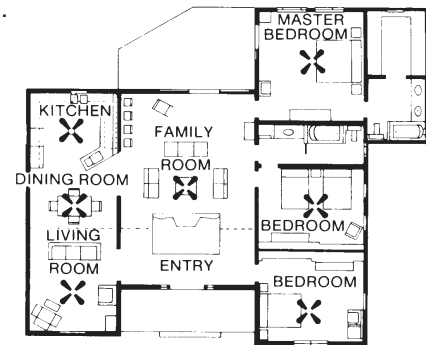

Fan Size

Variable fan speed capability permits the use of a full-size 52" fan even in smaller rooms. For very large rooms, two fans may be needed.

GETTING STARTED

Installing a New Ceiling Fixture Outlet Box

If you do not have an existing fixture located where you wish to place your Casablanca fan, an approved ceiling fixture outlet box must be installed and wired.

WARNING!

To reduce the risk of fire, electrical shock, or personal injury, mount to outlet box marked "Acceptable Fan Support of 22.7 kg (50 lbs.) Or less" using the mounting hardware provided with the outlet box.

Using Existing Ceiling Fixture Outlet Box

After turning the power OFF at its source (either the circuit breaker or fuse box), lower the old fixture and disconnect the wiring. Check the ceiling fixture outlet box to be sure it is marked "Approved for Ceiling Fan Mounting." If it is not, a new box must be installed.

Note: The weight of this fan is 28 pounds.

FAN INSTALLATION CEILING MOUNTING PLATE INSTALLATION

CEILING HARDWARE (not to scale)

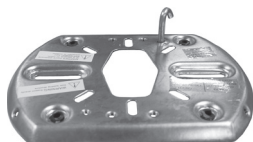

Ceiling Mounting Plate



1 1/2" Wood Screws (2) and Washers (2)



1" x 8-32 Roundhead Screws (2) and Washers (2)



Wire Nuts (3)



3" Wood Screws (2) and Washers (2)



Phillips Screwdriver

Note: After removing the old fixture, check the outlet box to ensure that it is supported by a joist or beam across its upper surface. If not, a 2 x 4 stud must be installed.

Step 1a. Carefully feed the ceiling wires through the center hole of the ceiling mounting plate. Attach the plate, as shown with ground wire down, to the ceiling fixture outlet box with the screws provided. Ensure that the outlet box wires are not pinched by the washers or between the mounting plate and the ceiling.

CAUTION:

To reduce the risk of personal injury, use only the mounting hardware provided with the approved outlet box to install the crossbar mounting plate.

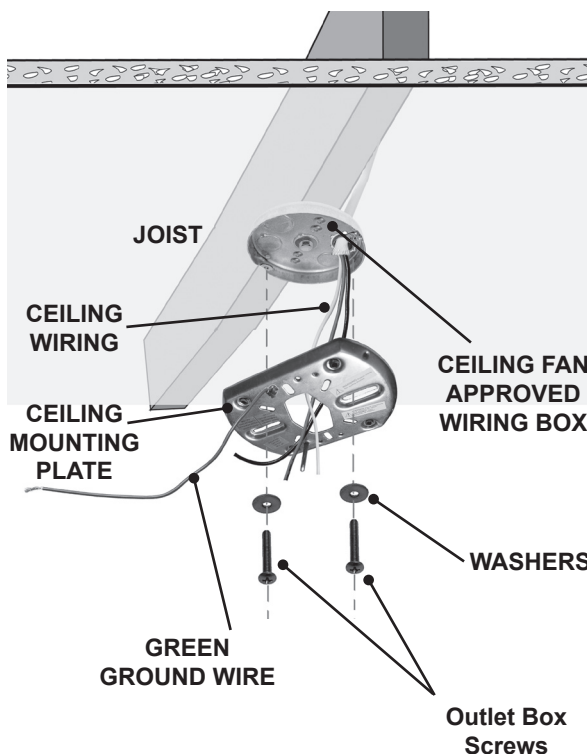



MOTOR HOUSING INSTALLATION

CEILING HARDWARE (not to scale)



Fan Body



Fan Mounting Screws (4)



Wire Nuts (3)

Step 2a. Unlock the canopy cover from the canopy ring tabs to loosen and bring down to fan body as shown in Figure #1.

Step 2b. Remove the fan mounting screws from the fan body and set aside. You will use these later.

Step 2c. Remove the shipping plate from the top of the canopy. Figure #2.

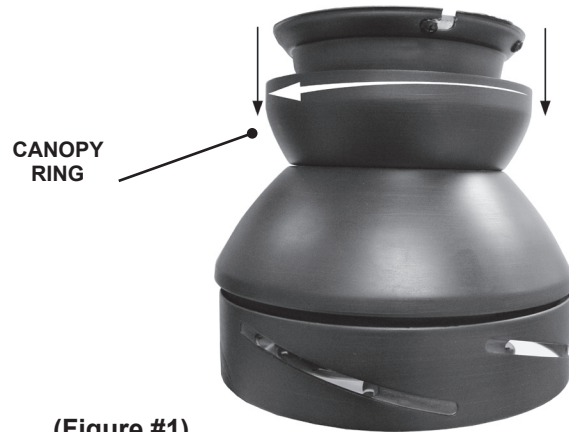

(Figure #1)

Step 2d. Use the hanging hole on the body of the fan to hang the fan on the hook of the ceiling mounting plate. This will help you in making the electrical connections as shown in Figure #3 and Figure #4.



(Figure #2)

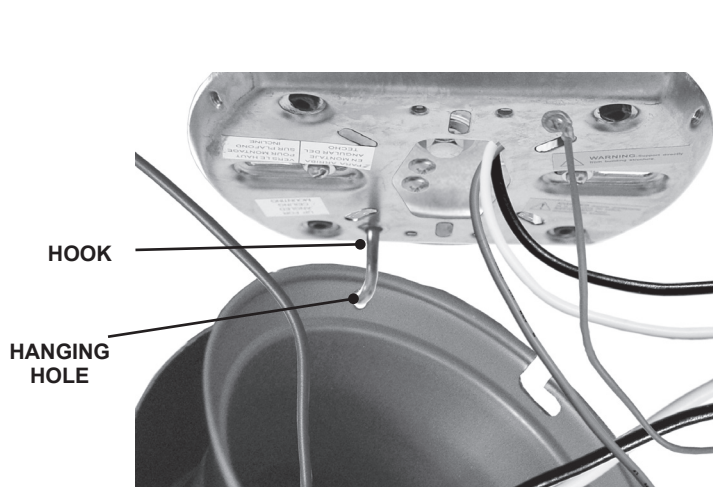

(Figure #4)

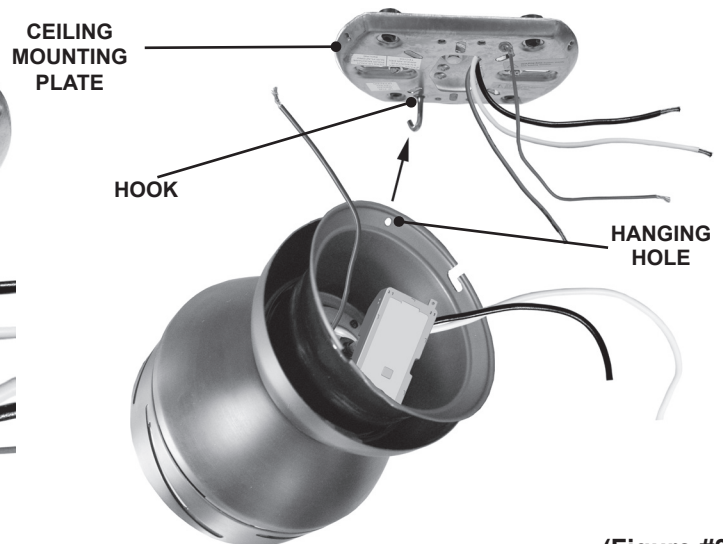

(Figure #3)

Step 2e. Attach the fan remote wires to the ceiling bracket wiring by placing the bare end of the wires side by side and then securing with a wire nut. Test that the connection is secure by pulling on the wire nut. Connect in this order:

- GREEN leads from ceiling bracket and motor to GROUND conductor of power source. Secure with wire nut as shown in Figure #4.
- WHITE wire from receiver to the WHITE NEUTRAL conductor wire from the power source. Secure with wire nut as shown in Figure #4.
- BLACK wire from receiver to the BLACK conductor wire from the power source. Secure with wire nut as shown in Figure #4.

Step 2f. After making the wire connections, the wires should be tucked in to the body of the fan as shown in Figure #5. The wires should be spread apart, with the three grounded conductor wires being placed on one side of the fan body and the power conductor wires being placed onto the other side of the fan body separating the connections.

Step 2g. Install 2 fan mounting screws on the left side of each side of the mounting plate #6.

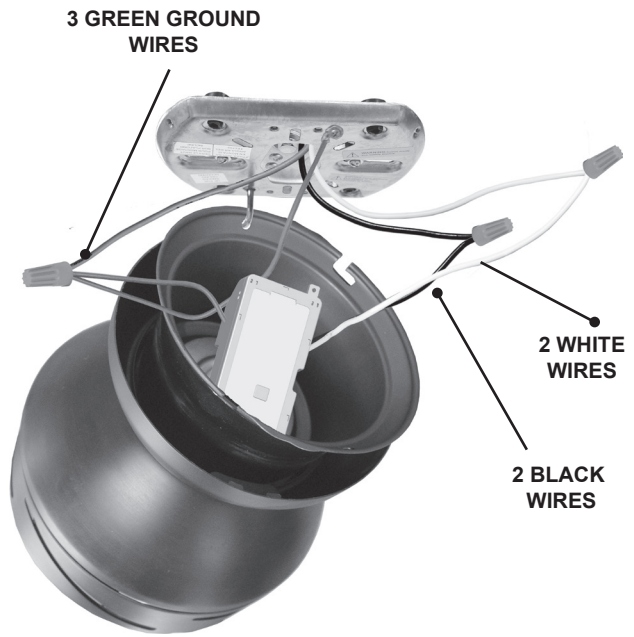

(Figure #4)



(Figure #5)

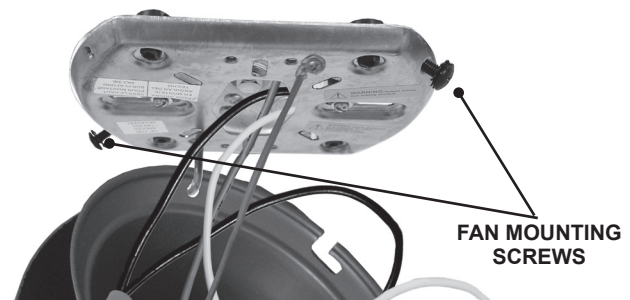

(Figure #6)



Step 2h. Using both hands, lift the fan body from the hook and position the hanging slots on both sides of the fan body, using the two fan mounting screws located on the ceiling mounting plate. Slide the two slots on both sides of the fan body between the head of the screws and rotate the fan body clockwise into the elongated slots as shown in Figure #7.



(Figure #7)

Step 2i. Install the other two fan mounting screws by holding the fan body cover to the ceiling mounting plate as shown in Figure #8. Tighten all four screws until hand tight.

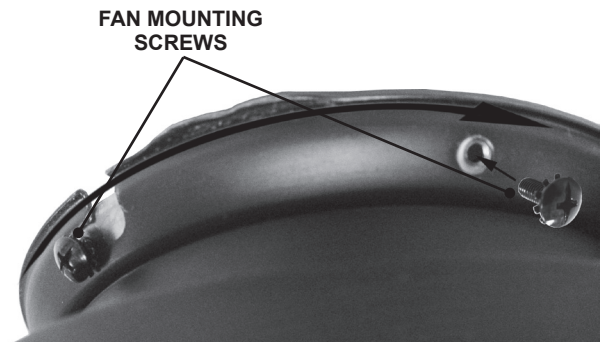

(Figure #8)

Step 2j. Before going to the next step, locate the two sets of canopy ring tabs that are on the top edge of the canopy as shown in Figure #9. Now locate the two sets of canopy tab holders found at the top of the fan body near the ceiling as shown in Figure #10.

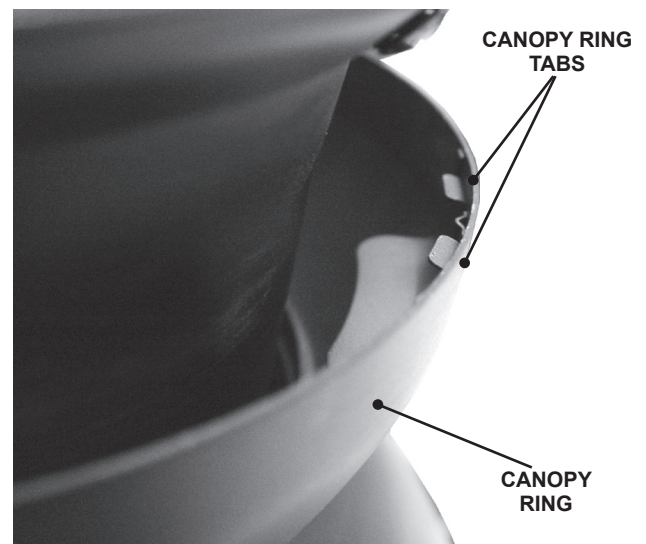

(Figure #9)

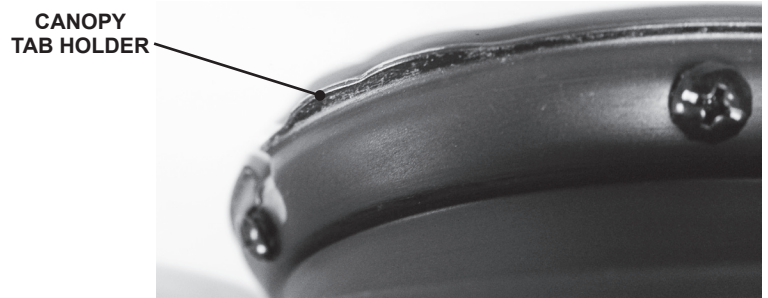

(Figure #10)

Step 2k. To install the canopy ring you will need to lift straight up on the canopy ring. Lock the **CANOPY RING TABS** and the **CANOPY TAB HOLDERS** by rotating the canopy cover clockwise as shown in Figure # 11, locking the canopy ring in to place.

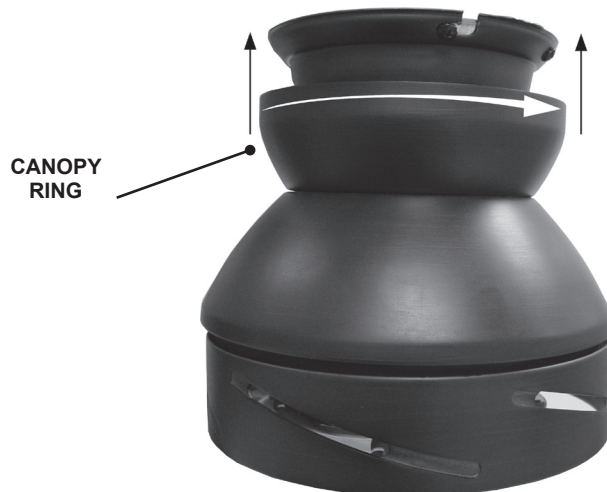

Step 2l. Check your work by making sure the canopy cover has an even gap between the ceiling and canopy ring as shown in Figure #12.

(Figure #11)



(Figure #12)



BLADE INSTALLATION

BLADE HARDWARE (not to scale)



Blades (5)



Blade Screws and Washers (16)



Phillips Screwdriver

Blade Installation

Step 3a. Slide the end of the blade with the three holes into the slot located on the blade ring. (The blades will only fit properly over the screws holes one way. If the holes do not line up, remove the blade and turn it over). Using three blade screws and washers, attach the blade to the blade ring, as shown in Figure #1. Install three screws and washer one by one using the provided screwdriver. Tighten securely *by hand only*. Repeat until all five blades have been installed on to the fan as shown in Figure #2.

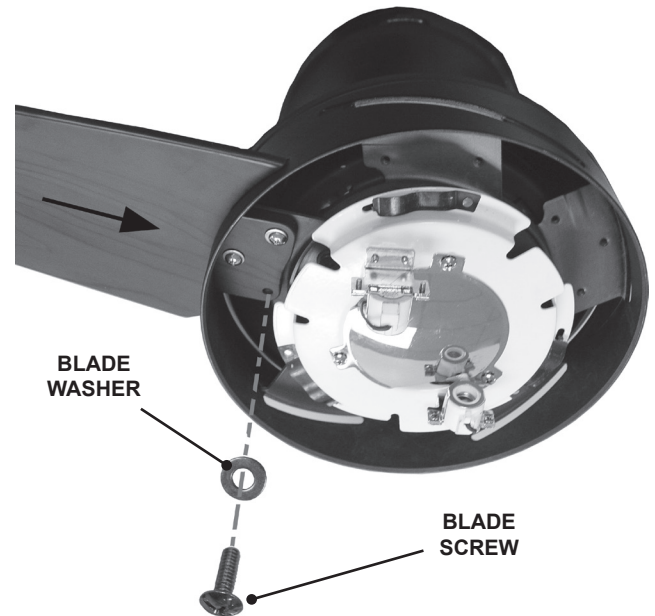

(Figure #1)



(Figure #2)

LIGHT BULB AND GLASS INSTALLATION

HARDWARE (not to scale)



Glass Shade



50 -watt
Halogen Bulbs (2)

Install Halogen Bulbs

Step 4. Screw the two bulbs into the light fixture as shown in Figure #1.

IMPORTANT! When installing a halogen bulb, carefully cut off the end of the plastic sleeve the bulb comes in and hold the bulb by the plastic sleeve to screw it into the socket.

NOTE: When replacing the bulbs, be sure to use only 50-watt maximum.

Glass Installation

Step 5a. Align the glass shade up with the bottom of the fan as shown in Figure #2 and locate the three glass holding slots. Then locate the three glass holding tabs, located on the light fixture plate.

Step 5b. Carefully lift the glass globe up inside the light fixture as far as it will go. Rotate the shade in a counter clockwise direction as shown in Figure #3, until the glass globe is held tightly in place by the three tabs.

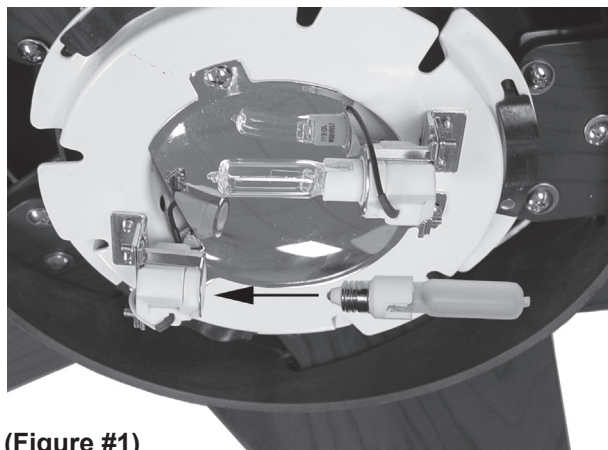

(Figure #1)

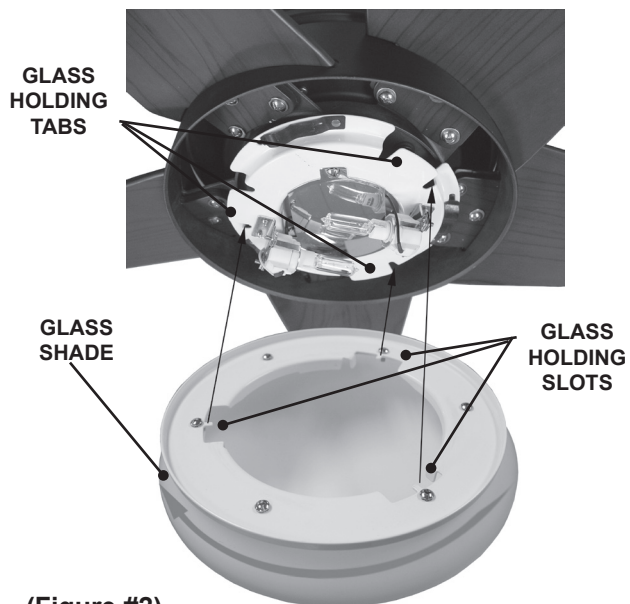

(Figure #2)

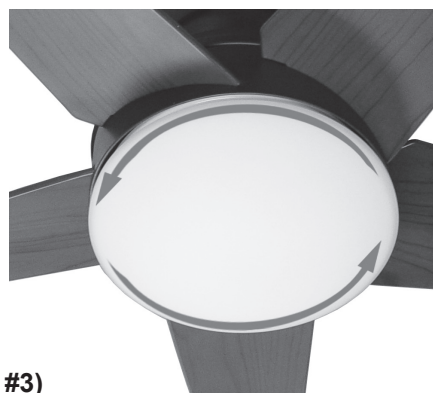

(Figure #3)



W-74 CONTROL INSTALLATION

W-74 WALL CONTROL PREPARATION



W-74
Wall Control



Cover Plate



Switch
Mounting
Screws (2)



Wall Plate
Screws (2)



(4) Wire Cap

W-74 WALL CONTROL PREPARATION

WARNING! To avoid possible electrical shock, make certain that electricity is turned off at the circuit breaker or fuse box before attempting any installation or repair procedure

Fuse Box
(Remove fuse for the circuit you will be working on)

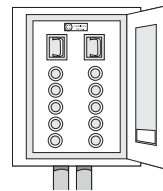

Circuit Breaker
(Trip breaker for the circuit you will be working on)

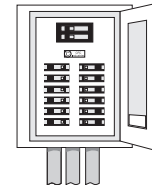

CAUTION! NOT turning the power OFF at the circuit breaker or fuse box may cause damage to the electronics within the wall control and/or the PC board on the fan.

INSTALLING THE W-74 WALL CONTROL

NOTE: W-74 Wall Control should only be installed on Casablanca's Direct-Touch™ Fans.

The wall control installs in the same manner as an ordinary light switch, using an existing wall box and wiring. This controller is designed to signal the fan microcomputer as well as perform normal switching operations. For this reason the following precautions must be observed:

1. Use only the Casablanca W-74 wall control.
2. Do not use any additional control with your Direct-Touch™ fan (for example, dimmer, or fan speed control).
3. Do not use more than one fan per wall control.
4. No other light fixtures or electrical appliances may be connected on the circuit controlled by the W-74 wall control.

SINGLE W-74 INSTALLATION

CAUTION!

Ensure power is turned OFF at the breaker or fuse panel before starting installation.

1. If you have multiple Direct-Touch™ fans, refer to the section "changing frequency setting" on page 20.
2. Remove the screws and switch plate from the existing switch box.
3. Remove the screws holding the switch in the switch box.
4. Pull the existing switch from the switch box to expose the wire connections.
5. Remove the two wires from the switch.
6. Connect the BLACK wire from the POWER SOURCE that you just removed from the switch to the BLACK/WHITE STRIP wire on the W-74 wall control. Secure this connection with a wire nut.
7. Connect the second BLACK wire that you just removed from the switch to the second BLACK wire on the located on the back of the W-74 wall control. Secure this connection with a wire nut.

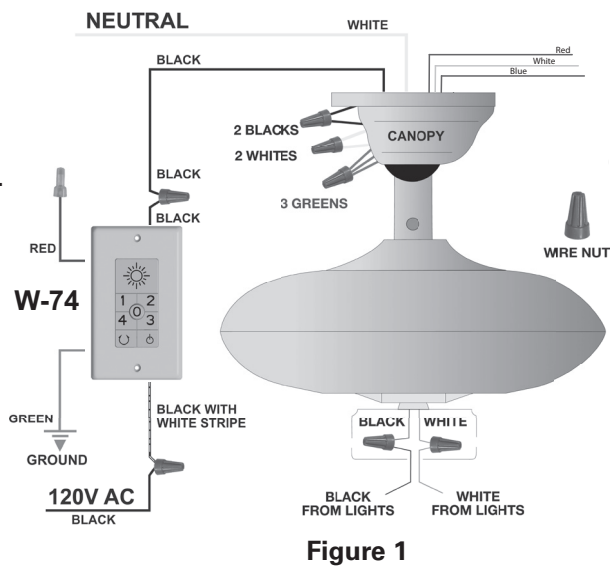

Figure 1

NOTE: The RED wire is not used in this application. DO NOT remove the crimped cap from the wire.

1. Connect the green ground wire coming from the back of the W-74 control to the ground wire in the switch box. Secure the splice with a wire nut.
2. Check your work by using the wiring diagrams as shown in Figures # 1 and #2.
3. Install the W-74 in the wall box with the two long screws provided.
4. Install the wall plate with the two white screws.

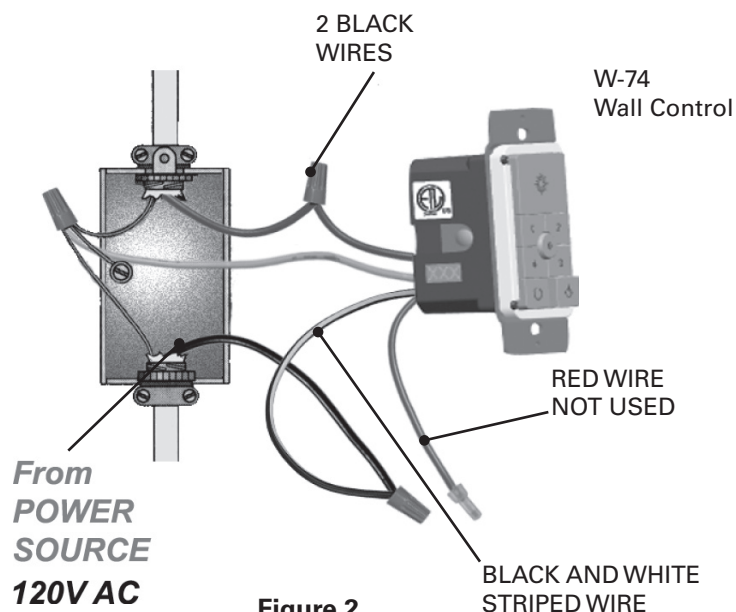

Figure 2

DUAL W-74 INSTALLATION

To control the fan and lights from two locations (a three-way circuit), use two W-74 wall controls as shown in the wiring diagram in Figure #4. Before installing the two switches into the wall, place both switches side by side, then locate the 6 dip switches on the side of the two switches as shown in Figure #3. Then make sure that the dip switches are set to the same address on both switches as shown in Figure #3. When setting these dip switches you are setting the channel number that is required to control both your fan and lights from both sides of the room. If you are installing other Direct-Touch™ 3 fans within your home you may need to reset the dip switches on these other fans to a different channel before installing your W-74 wall control into the wall. Please review the section on channel changing within this part of the operation manual as shown on page #22.

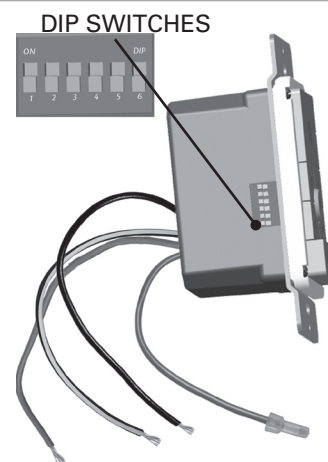

Figure 3

CAUTION!

Ensure power is turned OFF at the breaker or fuse panel before starting installation.

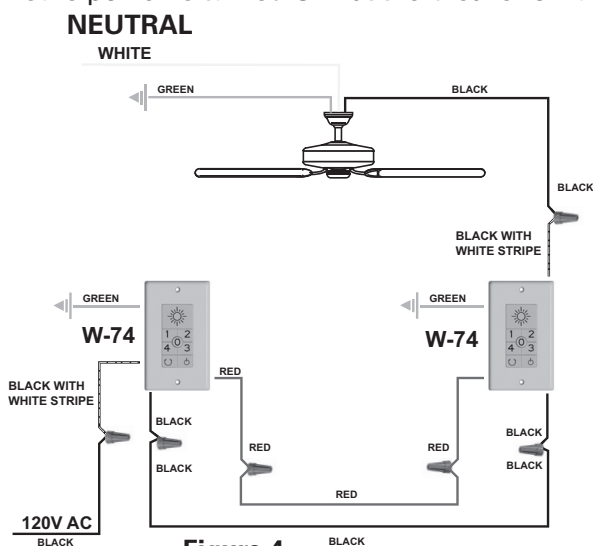

Figure 4

1. To control the fan and lights from two locations (a three-way circuit), use two W-74 wall controls.
2. Remove the screws and switch plate from the existing switch box and the screws holding the switch in the switch box. Figure #5
3. Pull the existing switch from the switch box to expose the wire connections.
4. Determine which wire is connected to the common terminal from the power source (120V AC) of the three-way switch. (The terminal will be marked on switch).
5. Remove the wire from the common terminal of the three-way switch. Connect this wire to the remaining black/white striped wire on the W-74 control. Secure this splice with a wire nut. Figure 4

Direct - Touch



6. Remove the two remaining wires from the three-way switch. Connect one black wire of these wires to the black wire on the W-74 control. Secure the splice with a wire nut.
7. The remaining wire is to be connected to the red wire on the W-74. Secure the splice with a wire nut. Note: Cut and strip the red wire to remove the crimped connector.
8. Connect the green ground wire coming from the back of the W-74 control to the ground wire in the switch box. Secure the splice with a wire nut.
9. Check your work by using the wiring diagrams as shown in Figures # 4 and #5 on this page.
10. Install the W-74 in the wall box with the two long screws provided.
11. Install the wall plate with the two short color-matched screws provided.
12. Installation of the second W-74 control is identical. Repeat steps 1 through 7.

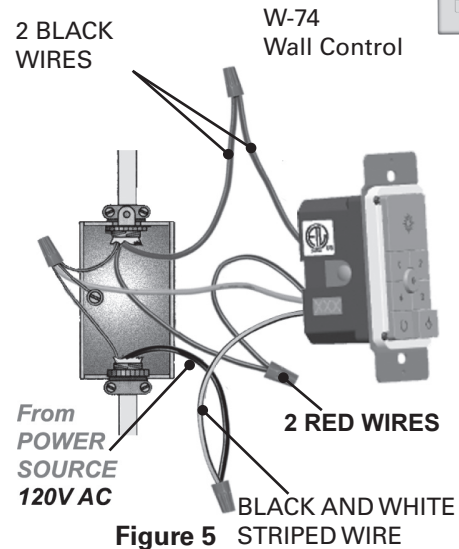



Figure 5

W-74 OPERATION OPERATION POWER

The  power button is normally left in the on position. Always turn the power off during cleaning or servicing the fan and during thunderstorms. It is also used to exit or enter additional programs.

The  power button must be left on to retain a previously set fan speed or light level.



OPERATION SPEED CONTROL

There are five individual speed settings for the fan. Each speed is indicated by the number on the controller and an audible tone for each speed.

To select the desired fan speed:

Press the number on the controller corresponding to the speed desired. 4 is high, 3 medium, 2 low, 1 ultra-low, and 0 is off.



Note: It is normal for the fan to start in the "High" position from "Off" before changing to the selected speed.

OPERATION REVERSING AIRFLOW

The direction of airflow can be changed from downward to upward or from upward to downward.

To reverse the airflow:

1. Make sure the fan is on and blades are turning.
2. Press the  reverse button. You will hear a series of clicks from the fan as it speeds up before coming to a stop and changing direction.



OPERATION LIGHTS

To turn the lights off and on, press and release the  button for less than one second.

Note: With CFL mode active, the lights will not dim.

To dim the down light, Press and hold the  button for more than 1 second. The light will come on at the last brightness setting and increase in brightness until full power is reached, then start dimming until the lowest setting is reached. This cycle will repeat until you release the light button.

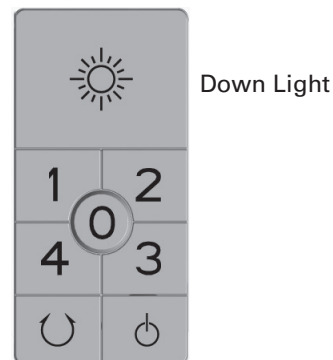



OPERATION CFL MODE



Note: The control with this fan has been shipped with CFL mode active.

Your fan has the ability to disable the dimming feature to allow the use of CFL bulbs.

To activate CFL mode:

1. Turn the fan off by pressing the  power button.
2. Allow the fan to remain off for at least 5 seconds.
3. Press the  power button again to restore power to the fan.
4. Immediately press and hold the "1" and "3" buttons for at least 5 seconds. The fans lights will go to 100% brightness and the dimming function will be disabled.

To cancel CFL mode:

5. Turn the fan off by pressing the  power button.
6. Allow the fan to remain off for at least 5 seconds.
7. Press the  power button again to restore power to the fan.
8. Immediately press and hold the "2" and "4" buttons for at least 5 seconds. The fans lights will dim to 50% brightness and the dimming function will be enabled. Press and hold the light buttons until the desired dimmer setting is reached.

Caution: CFL bulbs will not function properly when dimmed, which may result in flickering or reduced bulb life.

CHANGING FREQUENCY SETTING

You will only have to change the dip switch settings in the remote if you are using more than one fan in the same area and want to control them separately.

NOTE: DO NOT set dip switch setting in the remote to '000000', this may cause frequency interference from other Casablanca Products. All fans leave the factory set to "111111"

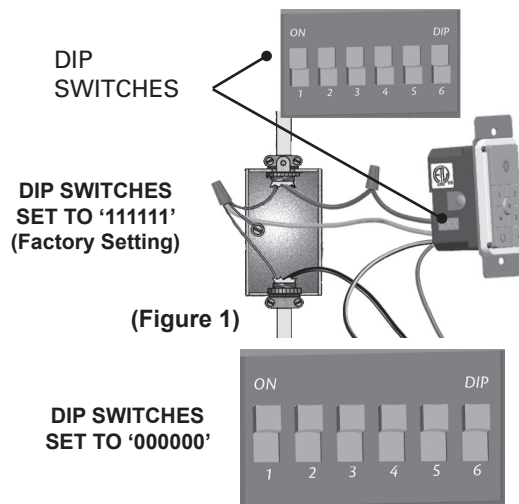



To change frequency:

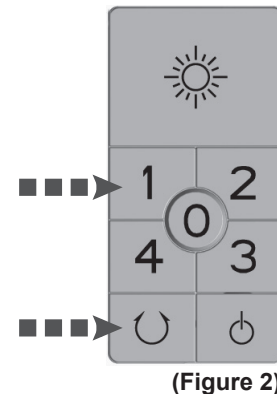

1. Turn power OFF at the circuit breaker or fuse box and at the toggle switch, for the fan you want to change.
2. Remove the screws and switch plate from the existing switch box.
3. Remove the screws holding the switch in the switch box.
4. Pull the existing W-74 switch from the switch box to expose the dip switches located on the side of the control as shown in Figure #1.
5. Change the dip switch settings, assuring that they are different from the previously installed Direct-Touch fan.
6. Mount the W-74 Wall Control unit back into the wall electrical box.
7. At the circuit breaker or fuse box and at the toggle switch, turn the power on for the fan whose frequency you are changing.
8. Within 20 seconds of restoring power to the ceiling fan and the W-74 Wall Control press and hold both the "1" and  reverse buttons as shown in Figure #2. For 3 seconds, you will hear an audible tone indicating the command has been accepted. The Fan and Lights will be off. The frequency is now changed.



AUTOMATIC DEMONSTRATION PROGRAM

Programmed into every Direct-Touch fan is an Automatic Demonstration Program. It can be used to fully demonstrate and test the operation of the fan.

To enter the demonstration program:



1. Turn the  power button off for at least 5 seconds. This will clear the fan memory making it ready for programming.
2. Turn the  power button on.
3. Immediately hold the "0" button for at least 5 seconds.

A multi-tone signal will verify the start of the test program. The fan and lights will go through a series of changing fan speeds, reversing the fan operation mode, turning off/on, and dimming the lights.

The complete cycle lasts slightly over one minute. It will continue to repeat until the  is turned off for more than five seconds, cancelling the program.

OPERATION SAFE-EXIT®

The Safe-Exit Program gives you about thirty seconds of light when you turn the lights off, enabling you to exit your home before the lights go out. To enter the Safe-Exit Program:

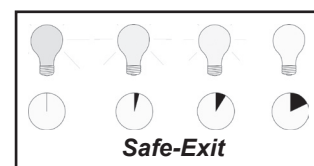

1. Press the  power button off for at least five seconds.
2. Turn the Power on. Immediately press and hold the "4" button for 5 seconds. When a light button is pressed, an audio tone and series of lights blinking will indicate the program is active. When CFL mode is disabled, the Lights will stay on at 50% brightness for 20 seconds then decrease in intensity for 30 seconds then turn off.
3. With CFL mode active, the lights will turn off after 30 seconds.
4. To cancel the Safe-Exit Program, press the  power button and leave off for five seconds.



LIGHT-MINDER® PROGRAM

The Light-Minder Program automatically turns OFF the fan mounted lights after two hours.

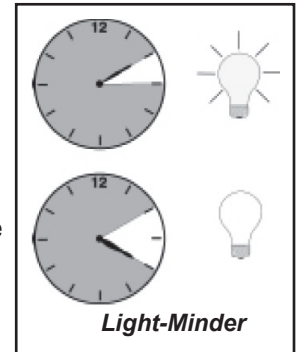

To activate the Light-Minder Program:

1. Turn the  power button off for at least 5 seconds.
2. Turn the  on. Immediately press and hold the "1" button for 5 seconds. A series of tones will be heard indicating the command has been accepted. Once the lights turn on, they will automatically turn off after 2 hours.
3. Light operation still remains normal, if you leave the room and turn OFF the lights, the lights will blink to indicate the Light Minder command has been accepted. The lights will stay on for 2 hours and then begin to dim. After thirty seconds have elapsed, the lights will turn completely off. In CFL Mode, the lights will not dim, but shut off after 2 hours.
4. To cancel the Light Minder Program, press the  power button and leave off for five seconds.



OPERATION HOME-SAFE® PROGRAM

To operate the Home-Safe Program:

1. Turn the  power button off for at least 5 seconds.
2. Turn the  on. Immediately press and hold the "3" button for 5 seconds. A series of tones will be heard indicating the command has been accepted.



Note: This program overrides all manual control of lights and fan.



3. The lights will automatically cycled on and off in a controlled sequence as follows: ON 1 hour, OFF ½ hour, ON 2 hours, OFF 1 hour, ON ½ hour then OFF 2 hours. This seven hour pattern will repeat continuously so that a different pattern of lighting is seen each day of the week.
4. To cancel the Home-Safe Program, press the  Button OFF for five seconds.

OPERATION FAN-MINDER™ PROGRAM

The Fan-Minder feature will add to your comfort when used in the bedroom. The program reduces the speed of the fan each two-hour interval to compensate for cooling night air.

1. To operate the lights for Light Minder Program – Turn the  power button off for at least 5 seconds.
2. Turn the  on. Immediately press and hold the "2" button for 5 seconds. A series of tones will be heard indicating the command has been accepted. Once the lights turn on, they will automatically turn off after 2 hours.
3. The fan will respond with three descending tones. A timer is now initiated and the fan will reduce one speed for each two-hour interval. The fan will not, however, descend below the first or the lowest speed.
4. You may increase the fan speed by pressing and holding any of the fan speed buttons until the desired speed is reached, then release it. The fan will again reduce one speed for each 2 hour interval.
5. To cancel the Fan-Minder Program, turn the  OFF for 5 seconds.

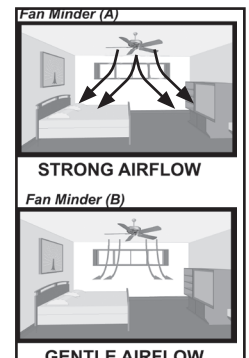

TROUBLESHOOTING TIPS

Please refer to this troubleshooting guide before requesting service or contacting your dealer for assistance.

Fan will not start

- Check the main circuit fuses, circuit breakers, and wall switch position. Check all wire connections. Make sure the power is turned off during this inspection.
- Pin connectors are not making good contact. Check all connections.
- The fan receiver is defective. Replace the fan receiver.
- Reset the frequency setting: See Page 20-21.

Fan wobbles or shakes excessively

- Be sure the canopy pin is set properly into the slot on the ball.
- Check that the blade holders have not been bent during installation and the blades are balanced.
- The hanger bracket and/or the ceiling outlet are attached too loosely. Make sure the hanger bracket is attached tightly to the ceiling outlet box and the downrod assembly is secured firmly.
- The downrod is attached to the downrod base too loosely. Make sure all the screws are securely tightened.
- A balancing kit is supplied with the fan to remedy slight wobble problems. Check all previous steps before using this kit.

Fan is noisy during operation

- When changing fan speeds or reversing the fan, you may hear several audible clicks. This is normal operation.
- Check and tighten the light fixture retaining screws, glass shade screws, and/or light bulb(s).
- Tighten the canopy screws and mounting plate assembly. Make sure the wire nuts inside the canopy and switch housing are not touching the metal parts and that they have not fallen off the wire splices. Tighten as necessary.
- Tighten the blade holders to the flywheel (or Direct Drive motor) and the blades to the bladeholder screws.
- Make sure all the screws in the motor housing are snug but not overly tight.

Fan does not run on low speed

- If fan is new, it may need to be "broken in." Run at high speed for several days.

Light is too dim

- Make sure the dimmer setting is at the desired level. Hold the  light button to activate the dimmer of the fan. Release the button when the desired luminosity is reached.

This device complies with RSS-210 of Industry Canada. Operation is subject to the following two conditions: (1) this device may not cause interference, and (2) this device must accept any interference, including interference that may cause undesired operation of the device.

1. This device complies with part 15 of the FCC Rules. Operation is subject to the following two conditions: (1) this device may not cause harmful interference, and (2) this device must accept any interference received, including interference that may cause undesired operation.

2. This equipment has been tested and found to comply with the limits for a Class B digital device, pursuant to Part 15 of the FCC Rules. These limits are designed to provide reasonable protection against harmful interference in a residential installation. This equipment generates, uses and can radiate radio frequency energy and, if not installed and used in accordance with the instructions, may cause harmful interference to radio communications. However there is no guarantee that interference will not occur in a particular installation. If this equipment does cause harmful interference to radio or television reception, which can be determined by turning the equipment off and on, the user is encouraged to try to correct the interference by one or more of the following measures: Reorient or relocate the receiving antenna, Increase the separation between the equipment and receiver, Connect the equipment into an outlet on a circuit different from that to which the receiver is connected. Consult the dealer or an experienced radio/TV technician for help. Note: Any changes or modifications to the transmitter or receiver not expressly approved by Casablanca Fan Company may void one's authority to operate this remote control.

CARE RECOMMENDATIONS

Fan Finishes

- For cleaning, a soft brush or lint-free cloth should be used to prevent scratching the finish.
- A vacuum cleaner brush nozzle can remove heavier dust.
- Surface smudges or an accumulation of dirt and dust can be removed easily using a mild detergent and slightly dampened soft cloth. An antistatic agent may be used, but *never use abrasive cleaning agents* as these will damage the finish.

Blades

- Wood-finish blades should be cleaned with a furniture polishing cloth. Occasionally, a light coat of furniture polish may be applied for added protection and luster.
- For painted and high-gloss blades, surface smudges or an accumulation of dirt and dust can be removed easily using a mild detergent and slightly dampened soft cloth. An antistatic agent may be used, but *never use abrasive cleaning agents* as these will damage the finish.
- Warning: To reduce the risk of personal injury, do not bend the blade brackets when installing the brackets, balancing the blades, or cleaning the fan. Do not insert foreign objects in between rotating fan blades.

No Need for Lubrication

- *Never lubricate this fan!* The precision motor at the heart of your Casablanca fan features sealed bearings that are lubricated for life.
- Do not attempt to oil the motor.

Changing Lightbulbs

- Be sure to turn the power to OFF at the wall switch or circuit breaker before changing lightbulbs.
- Replace bulbs with the same type as you removed from the light fixture.
- The maximum wattage rating for this fan's light kit is 100 watts for the light.

**For questions or to locate the nearest Casablanca Authorized Service Center,
call toll-free 1-888-227-2178 or visit us on the Web at www.casablancafanco.com**

This device complies with RSS-210 of Industry Canada. Operation is subject to the following two conditions: (1) this device may not cause interference, and (2) this device must accept any interference, including interference that may cause undesired operation of the device.

1. This device complies with part 15 of the FCC Rules. Operation is subject to the following two conditions: (1) this device may not cause harmful interference, and (2) this device must accept any interference received, including interference that may cause undesired operation.

2. This equipment has been tested and found to comply with the limits for a Class B digital device, pursuant to Part 15 of the FCC Rules. These limits are designed to provide reasonable protection against harmful interference in a residential installation. This equipment generates, uses and can radiate radio frequency energy and, if not installed and used in accordance with the instructions, may cause harmful interference to radio communications. However there is no guarantee that interference will not occur in a particular installation. If this equipment does cause harmful interference to radio or television reception, which can be determined by turning the equipment off and on, the user is encouraged to try to correct the interference by one or more of the following measures: Reorient or relocate the receiving antenna, increase the separation between the equipment and receiver, connect the equipment into an outlet on a circuit different from that to which the receiver is connected. Consult the dealer or an experienced radio/TV technician for help. Note: Any changes or modifications to the transmitter or receiver not expressly approved by Casablanca Fan Company may void one's authority to operate this remote control.

PRODUCT SPECIFICATIONS

Model Name: Isotope®

Model Number: C35GxxL (44")
C30GxxL (52")

Dimensions: A = 9.5"
B = 12.8"
C = N/A"
D = 10.2"
E = 7.7"

NOTE: Dimension B includes light fixture and glass.

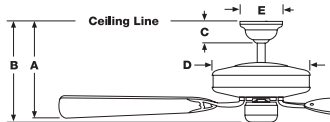

Weight: 28 lbs.

Motor: 188mm x 20mm Direct Drive™

Blade Span: 44" And 52"

Blade Pitch: 14°

No. of Blades: 5

Technology: Direct Touch® W-74SL

Lightbulbs: (2) 50-watt halogen

Airflow: 3,135 cfm

Electricity Use*: 71 watts

Airflow Efficiency*: 43.8 cfm/watt

* Performance data is for fan only. No lighting wattage is included. Measurements taken with 52" model.

Free Manuals Download Website

<http://myh66.com>

<http://usermanuals.us>

<http://www.somanuals.com>

<http://www.4manuals.cc>

<http://www.manual-lib.com>

<http://www.404manual.com>

<http://www.luxmanual.com>

<http://aubethermostatmanual.com>

Golf course search by state

<http://golfingnear.com>

Email search by domain

<http://emailbydomain.com>

Auto manuals search

<http://auto.somanuals.com>

TV manuals search

<http://tv.somanuals.com>