

---

# Twain™ Ceiling Fan Owner's Manual

## **Congratulations on your purchase of a Casablanca ceiling fan!**

Your new fan will be a beautiful addition to your home, keeping you comfortable throughout the year. The true appreciation of a Casablanca ceiling fan is only complete when put into actual use. Great time and care have been taken to construct and enhance what are otherwise functional appliances. Beauty is found in the integrity, craftsmanship, and attention to detail. Thank you for looking for the  nameplate that defines ceiling fans.

## Contents

---

<b>Parts Guide</b> .....	3
<b>Product Specifications</b> .....	5
<b>Safety Considerations</b> .....	6
<b>Mounting Guidelines</b> .....	7
Location .....	7
Fan Size .....	7
Structural Support .....	7
Sloped Ceiling Installations .....	8
<b>Installing the Mounting Hardware</b> .....	9
Assembling .....	9
Attaching the Crossbar Mounting Bracket .....	9
Attaching the Canopy .....	10
<b>Installing the Fan</b> .....	11
Assembling .....	11
Hanging the Fan .....	13
Connecting the Wires .....	13
<b>Installing the W-81 Wall Control</b> .....	14
Operating the W-81 Wall Control .....	16
Attaching the Canopy Hatch .....	16
<b>Installing the Blades</b> .....	17
Assembling .....	17
Attaching .....	17
<b>Installing the Light Fixture</b> .....	18
Attaching the Light Fixture .....	18
Attaching the Halogen Bulbs .....	19
Attaching the Glass Shade .....	20
<b>Troubleshooting Tips</b> .....	21
Problems and Possible Remedies .....	21
<b>Care Recommendations</b> .....	21



**PLEASE INSPECT ALL PACKAGING PRIOR TO DISCARDING!**

Your Casablanca fan was crafted with pride and care and inspected thoroughly prior to shipment. Before you begin to assemble and install your Casablanca fan, remove all parts from the carton and check them against the Parts Guide in this manual.

**Make sure all parts are included in the box using the Parts Guide on the following pages.**

If there are missing or broken parts:

- Call 1-888-227-2178 Monday through Friday, 7 a.m. to 4 p.m. PST. Your request will be handled immediately. Replacement parts will be sent to you via Federal Express.

**Proper Parts Handling**

- Do not remove lightbulbs from their packaging until you are ready to install them.
- Before discarding packaging materials, be certain that all parts have been removed.
- Use a clean, dry paintbrush to remove small Styrofoam pieces that may remain after unpacking.
- Do not brush Styrofoam into wiring cavities.
- The blades in each pack are matched for equal weight to assure smooth fan operation. If more than one fan is being installed, do not mix blades from different cartons.
- When cleaning, painting, or working near your fan, be cautious of the fan and blades.

- Always turn power to the ceiling fan OFF before replacing lightbulbs or working on your fan.
- Never insert anything into the path of the fan blades while the fan is in operation.
- Never install a fan over a pool or spa.
- Never operate a fan that has been damaged in any way.

**Install the fan according to the instructions in this manual.**

If the fan does not work:

- Refer to the Troubleshooting Tips in this Owner’s Manual.
- Call Technical Support at 1-888-227-2178.
- Contact your local Authorized Service Center.







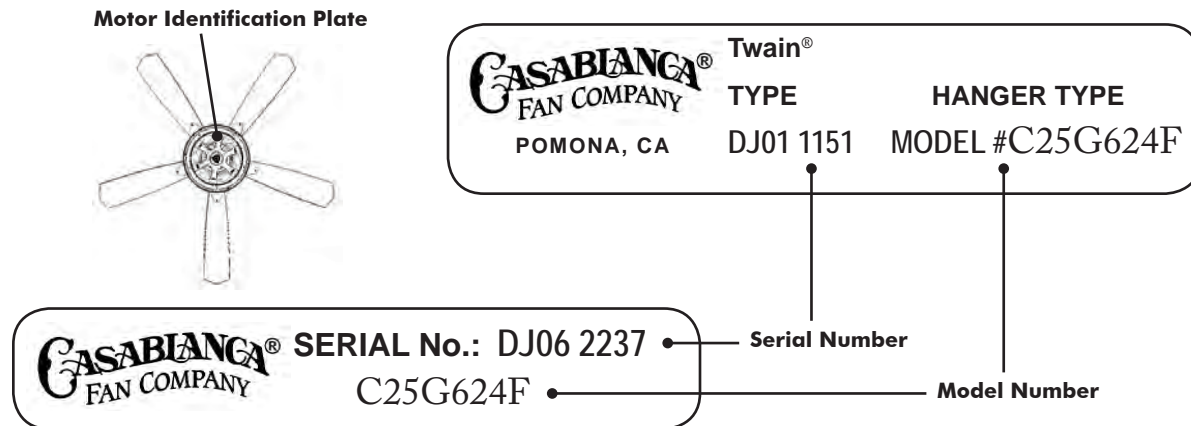







Our Web site at [www.casablancafanco.com](http://www.casablancafanco.com) contains additional information on Casablanca products, troubleshooting, and Authorized Dealer or Service Centers. Please do not return this product to the store.









**RECORD MODEL AND SERIAL NUMBERS BEFORE INSTALLATION!**

Please take a moment to locate the model number and serial number from your fan (see below) and record this information on the Warranty page inside the front cover of your Owner’s Manual if it does not appear there already. These numbers are found on the motor identification plate affixed to the fan motor in the location shown below:

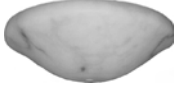

# Parts Guide

Item #	Description	Picture (not to scale)	Quantity
1.	Motor Housing		1
2.	Crossbar Mounting Bracket		1
3.	Right-Angle Screwdriver		1
4.	Lag Screw and Washer		1
5.	1" x 8-32 Round-Head Screws and Washers		2
6.	Canopy and Hatch		1
7.	2½" x 8-32 Canopy Screws and Lock Washers		5
8.	2¼" Perma•Lock™ Downrod and Ball Assembly		1
9.	Allen Wrench		1
10.	Wire Nuts		4
11.	Light Fixture		1
12.	Light Fixture Screws		4
13.	Halogen Downlight Bulbs, 50W		2
14.	Blades		5
15.	Blade Iron Plate Screws		21

Item #	Description	Picture (not to scale)	Quantity
16.	Blade Iron Plates		5
17.	Blade Irons		5
18.	Blade Iron Screws		11
19.	Balance Kit		1
20.	Light Adapter Plate		1
21.	Light Adapter Screws		3
22.	Incandescent Uplight Bulbs, 25W		6
23.	Glass Shade		1
24.	Finial		1
25.	W-81 Wall Control		1

# Product Specifications

**Model name:** Twain®  
**Model number:** C25GXXXF  
**ETL Rating:** Damp  
**Dimensions:**

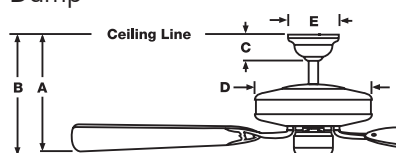

A = 11.9"  
 B = 16.7" **NOTE:** Dimension B includes light  
 C = 3" fixture and glass.  
 D = 16.2"  
 E = 5.6"

**Weight:** 45 lbs.  
**Motor Type:** XTR200™  
**Motor Size:** 200mm x 30mm  
**Blade Span:** 60"  
**Blade Iron Pitch:** 14°  
**No. of Blades:** 5  
**Technology:** W-81 wall control  
**Lightbulbs:** (6) 25-watt B10 incandescent  
 (2) 50-watt T4 halogen  
**Airflow:** 8,173 cfm  
**Electricity Use\*:** 97 watts  
**Airflow Efficiency\*:** 84.3 cfm/watt  
**\*Performance data is for fan only. No lighting wattage is included.**

This device complies with Part 15 of the FCC rules. Operation is subject to the following two conditions:

- This device may not cause harmful interference.
- This device must accept any interference received, including interference that may cause undesired operation.

This equipment has been tested and found to comply with the limits for a class B digital device, pursuant to Part 15 of the FCC rules. These limits are designed to provide reasonable protection against harmful interference in a residential installation. This equipment generates, uses, and can radiate radio frequency energy and, if not installed and used in accordance with the instructions, may cause harmful interference to radio communication. However, there is no guarantee that the interference will not occur in a particular installation. If this equipment does cause harmful interference to radio or television reception, which can be determined by turning the equipment off and on, the user is encouraged to try to correct the interference by one or more of the following measures:

- Reorient or relocate the receiving antenna.
- Increase the separation between the equipment and receiver.
- Connect the equipment into an outlet on a circuit different from that to which the receiver is connected.
- Consult the dealer or an experienced radio/TV technician for help.

## Safety Considerations

Safety and the proper operation of your Casablanca fan both require a thorough knowledge of the product and proper installation; therefore, before attempting to install and operate your Casablanca fan, read this Owner's Manual completely and carefully. Retain this manual for future reference.

⚠ **CAUTION: RISK OF ELECTRICAL SHOCK!** Turn off all electricity at the circuit breaker or fuse box before attempting any installation procedure. Installation is to be in accordance with the National Electrical ANSI/NFPA 70-1999 and local codes. If you are unfamiliar with the wiring codes, contact a qualified electrician. To avoid overheating and possible damage to other equipment, do not install control to a receptacle, fluorescent light fixture, operating appliance, or transformer-supplied appliance.

- This ceiling fan requires a grounded electrical supply of 120 VAC, 60 Hz and a minimum of 15-amp circuit. The maximum current required for the fan with light fixture is 3.2 amps (382 watts). The fan uses about 1.1 amps (132 watts). Maximum light current is about 2.1 amps (190 watts) of lighting.
- Where wire nuts are employed, be sure all bare wires are fully inserted into the metal wire connectors inside the plastic wire nut covering.
- When installing the canopy, light kit, and wall controls, make sure all wires are carefully tucked away and that no wires are pinched.
- The fan must be supplied with three independent 120V AC supply wires to provide power for the fan, the light, and neutral.

⚠ **WARNING:** To reduce the risk of personal injury or damage to the fan, do not bend the blade brackets or insert foreign objects in between the rotating fan blades.

⚠ **WARNING:** To reduce the risk of fire or electric shock, do not use this fan with any solid-state control device. Use only the control provided with or recommended for this fan.

**Fuse Box**  
(Remove fuse for the circuit you will be working on)

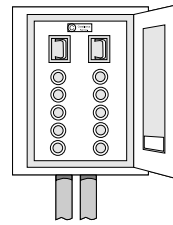

**Circuit Breaker**  
(Trip breaker for the circuit you will be working on)

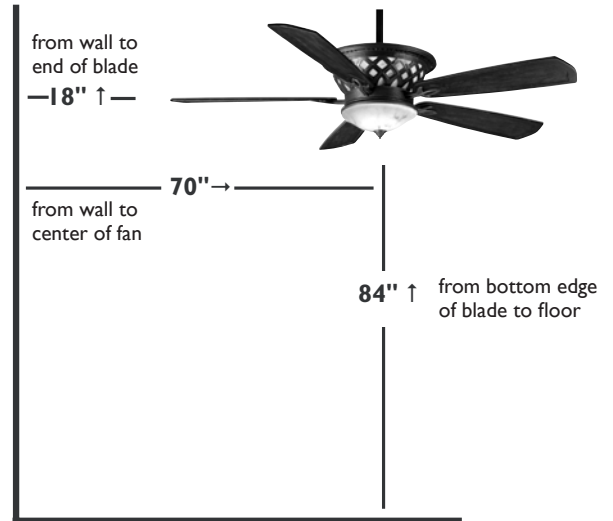
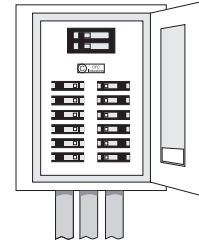

Dimensions indicated are the minimum allowable for proper installation.

## Mounting Guidelines

Before mounting your Casablanca fan, read the following helpful recommendations. Location, fan size, and structural support are important factors to consider before installation.

### Location

Ceiling fans have practical uses in almost every room in your home. We suggest you follow these mounting recommendations as you decide where to install your Casablanca fan.

- For safety reasons, the fan blades must be a minimum of 7' above the floor.
- Do not locate the fan in a doorway or above a swinging door.
- In bedrooms, fans work best when mounted above the foot of the bed.
- Over pool tables, be sure to provide plenty of clearance to avoid damage from pool cues.
- In kitchens be sure to allow for open cupboard doors to clear the fan blades.
- Do not install a fan close to or over a pool or spa. High humidity combined with corrosive gases will destroy the finish and warp the blades.

### Fan Size

Variable fan speed capability permits the use of a full-size fan even in smaller rooms. For very large rooms, two fans may be needed.

## Structural Support

### Installing a New Ceiling Fixture Outlet Box

If you do not have an existing fixture located where you wish to place your Casablanca fan, an approved ceiling fixture outlet box must be installed and wired.

### Using Existing Ceiling Fixture Outlet Box

After turning the power OFF at its source (either the circuit breaker or fuse box), lower the old fixture and disconnect the wiring. Check the ceiling fixture outlet box to be sure it is marked "Approved for Ceiling Fan Mounting." If it is not, a new box must be installed. For new construction, use an approved ceiling fixture outlet box with the rating "50 lbs. or less". Ensure that outlet box is mounted to a joist or stud beam. If not, a 2x4 stud must be installed.

⚠ **WARNING!** To reduce the risk of fire, electrical shock, or personal injury, mount to outlet box marked "Acceptable Fan Support of 22.7 kg (50 lbs.) or less" using the mounting hardware provided with the outlet box.

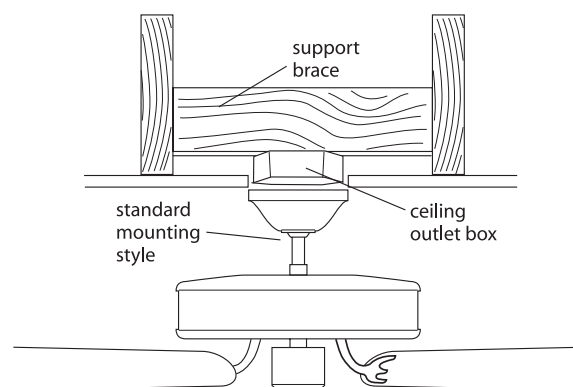

### When to Use a Lag Screw

A lag screw is required under two conditions: the fan weighs 36 lbs. or more or the existing ceiling fixture outlet box needs to be modified for a ceiling fan application (for example, you are replacing an existing light fixture). We recommend that the ceiling box be of sufficient capacity to support the weight of the fan and light fixture under any conditions.

**NOTE:** The Twain weighs 45 lbs., so use of a lag screw is required.

## Sloped Ceiling Installations

### When to Use an Extension Downrod

For optimum performance and appearance, use an extension downrod with your Casablanca fan when installing on high (cathedral) ceilings or sloped ceilings. Casablanca offers accessory downrods in increments of 6" up to 5'. See your Authorized Casablanca Dealer for details.

### Calculation of Ceiling Angle

Use the tear-off Ceiling Angle Template card inserted in this manual. It provides you with a simple "go" or "no go" for installing your fan on a sloped ceiling.

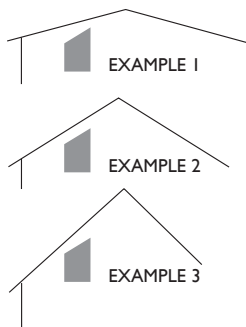
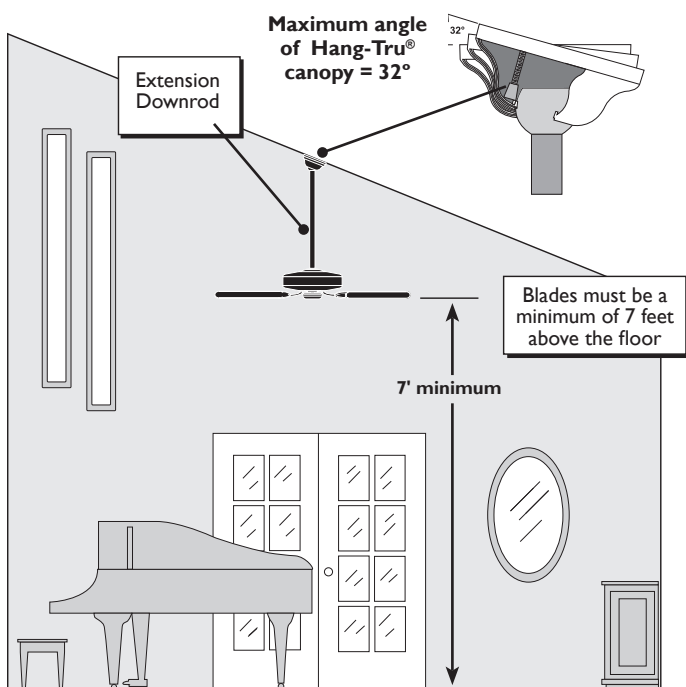

**EXAMPLE 1**  
This slope is less than 32°. It is OK to install your fan.

**EXAMPLE 2**  
This slope is 32°. This is the maximum slope that will allow the fan to hang straight down. It is OK to install your fan.

**EXAMPLE 3**  
This slope is more than 32°. Your fan will not hang straight down, so an adaptor is necessary. Contact your local Authorized Casablanca Dealer to purchase a Sloped Ceiling Adapter.

**NOTE:** The fan may wobble or vibrate if the downrod length is not long enough and the inside blade is too close to the downslope or side wall. Extending the downrod length usually will solve this problem.

Suggested Extension Downrod Lengths	
Ceiling Height	Downrod Length
8' 0"	standard
8' 6"	standard
9' 0"	6"
9' 6"	12"
10' 0"	12"
11' 0"	18"
12' 0"	24"
13' 0"	36"
14' 0"	48"
15' 0"	60"



# Installing the Mounting Hardware

## Hardware (not to scale)



Crossbar Mounting Bracket (1)



Lag Screw and Washer (1)



1" x 8-32 Round-Head Screws and Washers (2)



Right Angle Screwdriver



Canopy Hatch (1)



Canopy (1)



2 1/2" x 8-32 Canopy Screws (4) and Lock Washers (5)

## Assembling

**1** Determine the need for a lag screw based on the Mounting Guidelines previously described. If in doubt whether you need to install the lag screw, consult a qualified electrician.

**2** If a lag screw is required, remove the plug in the center of the ceiling fixture outlet box. If the outlet box does not have a plug, drill a 1/2 inch hole for the lag screw. After drilling a hole for the lag screw, drill a 1/4 inch hole 3 inches deep through the beam supporting the ceiling fixture outlet box.

## Attaching the Crossbar Mounting Bracket

**3** To install the crossbar mounting bracket, route the outlet box wires along side of the crossbar mounting bracket. (see Step 5 image) Attach the crossbar mounting bracket to the outlet box with the set of two round-head screws and washers. Use caution when installing the screws and washers. Do not pinch the outlet box wires in the washers.

⚠ **CAUTION:** To reduce the risk of personal injury, use only the mounting hardware provided with an approved outlet box (not included) to install the crossbar mounting bracket.

### STEPS 3-4

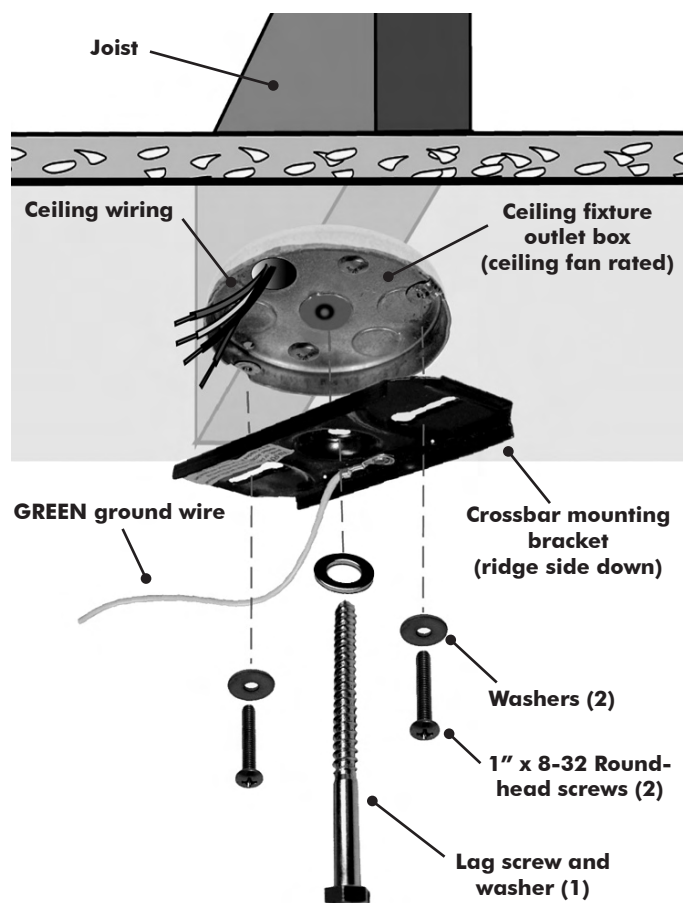

**4** To install the lag screw (if needed), slide the remaining washer onto the lag screw. Pass the lag screw through the center hole in the crossbar mounting bracket. Secure the lag screw into the guide hole, tightening until the ceiling fixture outlet box is firmly mounted to the support beam.

## Attaching the Canopy

**5** To install the canopy hardware, set aside the canopy hatch and attach the canopy to the crossbar mounting bracket with three of the canopy screws and lock washers. Using the right-angle screwdriver provided, tighten each screw until the canopy hardware is firmly mounted to the crossbar mounting bracket.

**NOTE:** On a sloped ceiling, align the canopy opening with the top or peak of the room.

### STEP 5

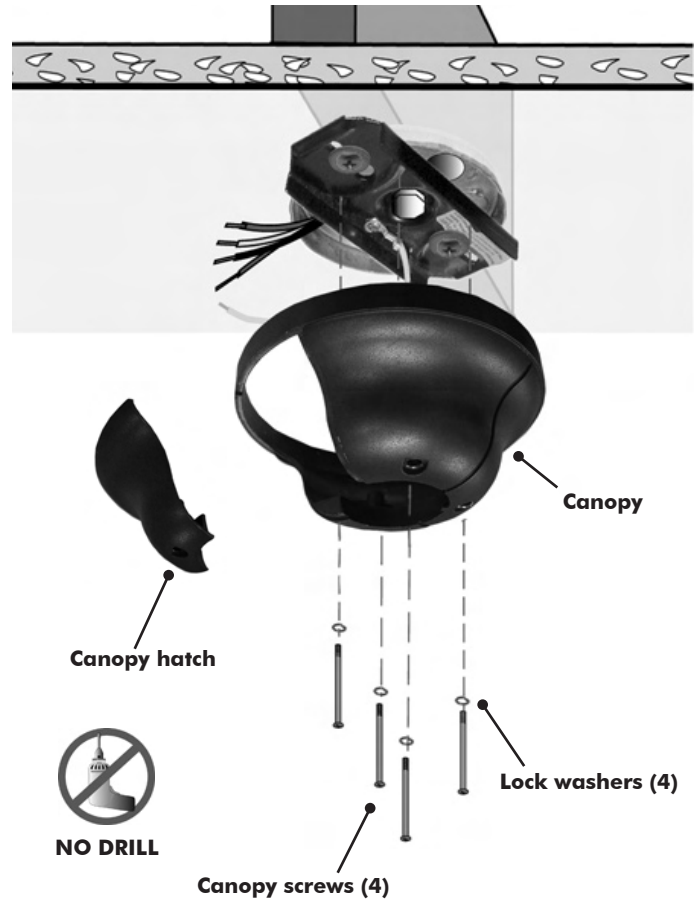

# Installing the Fan

## Hardware (not to scale)



Perma-Lock™ Downrod and Ball Assembly (1)



Allen Wrench (1)



Wire Nuts (4)



2 1/2" x 8-32 Canopy Screw (1) and Lock Washer (1)



Canopy Hatch (1)



Canopy (1)



Incandescent Uplight Bulbs, 25W (6)

## Assembling

**1** Remove the paper shield from the motor.

### STEP 1

Paper motor shield



**2** Examine the interior of the motor coupling. If the end of the set screw is inside the motor coupling space, use the Allen wrench to loosen the screw.

### STEP 2

Set screw - CORRECT PLACEMENT

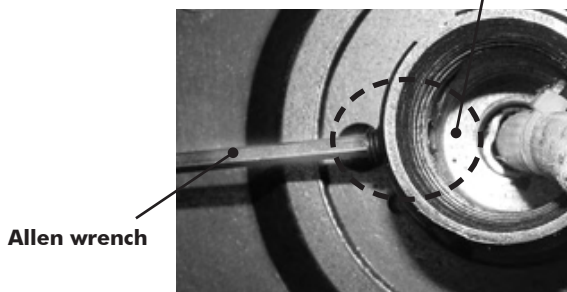

Set screw - INCORRECT PLACEMENT

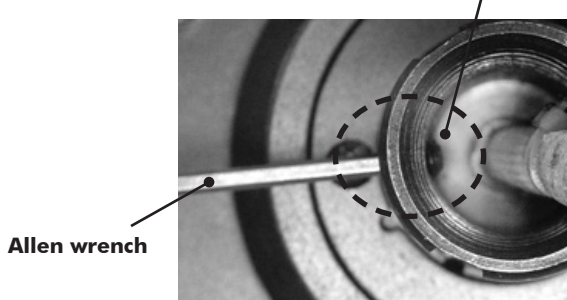

**3** Route the fan wires through the downrod and ball assembly.

**4** Insert the downrod into the motor coupling and turn clockwise. When the downrod is securely in place, re-tighten the set screw with the Allen wrench until it will not turn any further. Test the stability of the downrod assembly by attempting to unscrew the downrod from the motor coupling. If the downrod turns in either direction, the set screw should be tightened.

⚠ **CAUTION:** The downrod has a tapered thread designed to lock completely when correctly installed. Failure to fully lock in the downrod before securely tightening the set screw may cause the fan to separate from the downrod and fall during normal operation.

**STEPS 3-4**

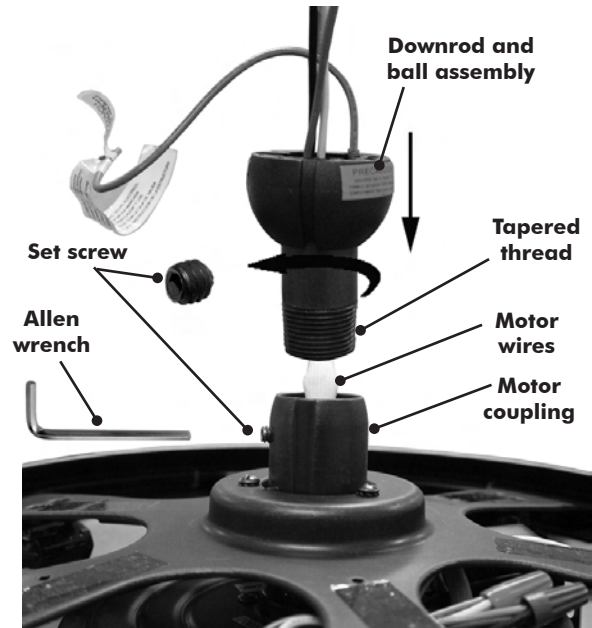

**STEP 5**

**5** Screw in the six light bulbs.



## Hanging the Fan

**8** Hold the motor housing with both hands. Insert the ball of the downrod into the canopy opening. Check to ensure that the wires are not pinched. Rotate the motor housing until the slot in the downrod ball locks into the pin opposite the canopy opening.

### STEP 8

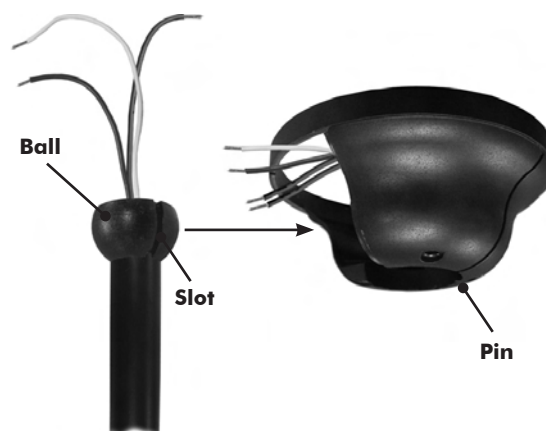

## Connecting the Wires

**9** Trim the extra length from the motor wires. Be certain to leave at least 6 inches of wire above the downrod. Use a wire stripper (not included) to strip ½-inch of insulation from the end of each trimmed wire.

**10** To attach the fan wires to the ceiling fixture wiring, match the wire colors as described below, hold the bare ends of the wires side by side, and fully insert the wires into the wire nut. Secure by rotating the wire nut in a clockwise motion.

Connect wires in the following order:

- GREEN wires from mounting plate and downrod assembly of fan to GROUND wire of power source.
- WHITE fan wire to WHITE neutral wire from ceiling outlet box.
- BLACK power wire from fan to BLACK power wire in ceiling outlet box.
- BLUE D1 optional fan wire to RED power wire (second hot wire) in ceiling outlet box.

**NOTE:** If the color of your ceiling wires differs from that described, consult an electrician.

Inspect each wire nut to ensure that no bare wire is visible. Test the connection by gently pulling on the wires. The wire nuts should stay firmly in place, covering the bare ends.

### STEPS 9-10

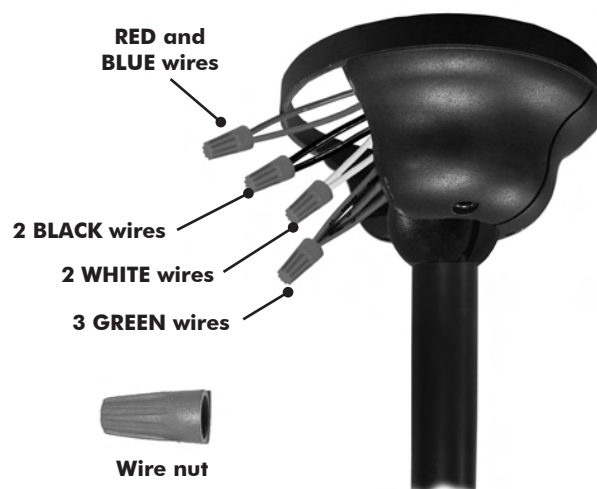

# Installing the W-81 Wall Control

## Hardware (not to scale)



**W-81 Wall Control (assembled)**



**Wall Plate (2 colors included)**



**Wall Control (1)**



**Wire Nuts (4)**



**Wall Plate Screws (4)**



**Switch Box Screws (2)**

The fan must be supplied with three independent 120V AC wires to provide power for the fan, light, and neutral.

**CAUTION:** Ensure power is turned OFF at the breaker or fuse panel before beginning wall control installation.

**NOTE:** The W-81 wall control is designed to replace a standard wall switch and fits wall boxes (metal or plastic) with a depth of more than 2".

**1** Remove the screws and switch plate from the existing wall switch box, and pull the switch away from the box to expose the wire connections.

**2** Disconnect the three wires from the existing switch and remove the switch from the wall box. The ends of the wires in the wall box may need to be stripped before installing the new control.

**NOTE:** The wire nuts provided are only suitable for use with copper wire. Use wire nuts to join one 14-gauge wire with one 16- or 18-gauge wire.

**3** To attach the wires in the wall box to the W-81 wall control wires, match the wire colors as described below, hold the bare ends of the wires side by side, and fully insert the wires into the wire nut. Secure by rotating the wire nut in a clockwise motion.

Connect wires in the following order:

- GREEN GROUND conductor from the wall box to the GREEN wire from wall control (labeled GRD)
- BLACK wire from fan in the wall box to YELLOW wire on wall control (labeled FAN)
- RED wire from fan in the wall box to RED wire on the wall control (labeled LIGHT)

**NOTE:** BLUE D1 optional fan wire can be connected to RED power wire in ceiling outlet box.

- BLACK wire from the source of power (HOT WIRE) wire in the wall box to BLACK wire on wall control (labeled LIVE)

**NOTE:** If the colors of your wiring differ from that described, consult an electrician.

Inspect each wire nut to ensure that no bare wire is visible. Test the connection by gently pulling on the wires. The wire nuts should stay firmly in place, covering the bare ends.

#### STEP 3

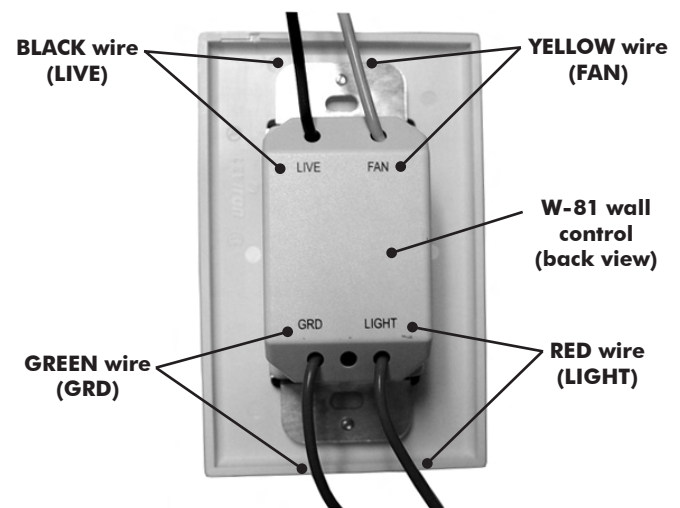
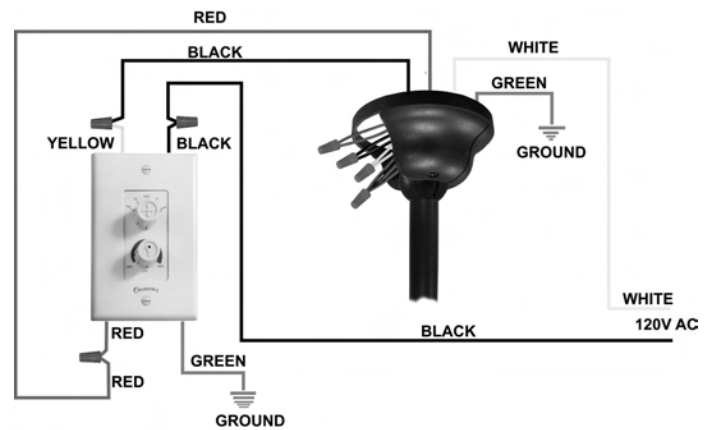

**4** Fasten the W-81 wall control into the wall box with the two switch box screws.

**CAUTION:** Be certain that the wires are not pinched!

#### STEP 4

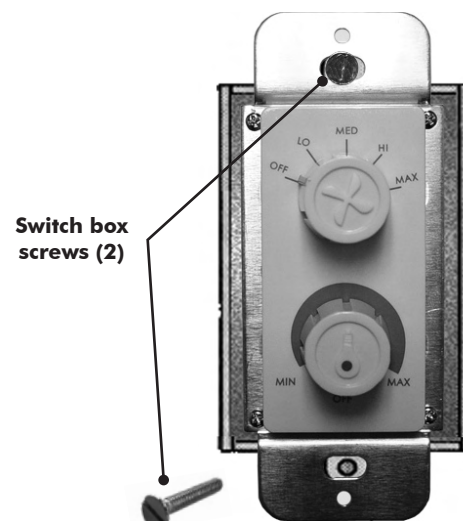



**5** Fasten one of the two wall plates (white or ivory) to the wall control using the two wall plate screws.

**6** Set the fan speed to HIGH on the wall control. Return power to the panel and test the controller.

**CAUTION: Failure to set the fan speed to HIGH can result in faulty operation of the fan and damage to the wall control.**

## Operating the W-81 Wall Control

- Turn the upper knob to the desired fan speed.
- Turn the lower knob to the desired light setting.

## Attaching the Canopy Hatch

**7** Tuck the wires into the canopy with the wire nuts pointed toward the ceiling. Place the BLACK and WHITE/GREEN wires on opposite sides of the canopy. All wires should be clear of the canopy opening. Tilt the motor housing and downrod to install the canopy hatch.

**8** Use the last remaining canopy screw and lock washer to secure the canopy hatch. Straighten the fan and ensure all parts are tightly secured. Check for movement at the following joints:

- Between the canopy and the ceiling
- Between the canopy and the downrod and ball assembly

### STEP 5

Wall plate screws (2)



### STEPS 7-8

Canopy hatch

Canopy

Canopy screw and washer



**NO DRILL**

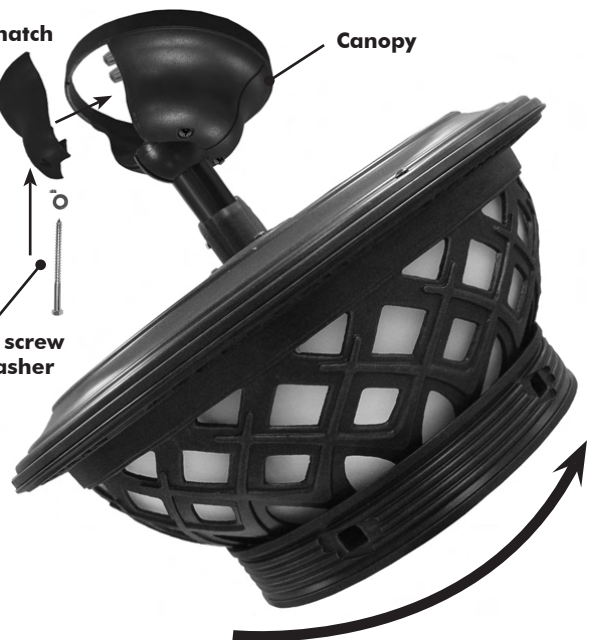



# Installing the Blades

## Hardware (not to scale)



Blades (5)



Blade Iron Plate  
Screws (21)



Blade Iron Plates (5)



Blade Irons (5)



Blade Iron Screws (11)

## Assembling

**1** Place the blade iron plate on top of the blade and the blade iron underneath the blade. Use a manual screwdriver to secure the blade iron and plate with the blade iron plate screws. Use four screws per blade. Repeat this process for each fan blade.

⚠ **CAUTION: Do not use an electric screwdriver to assemble fan blades!**

### STEP 1

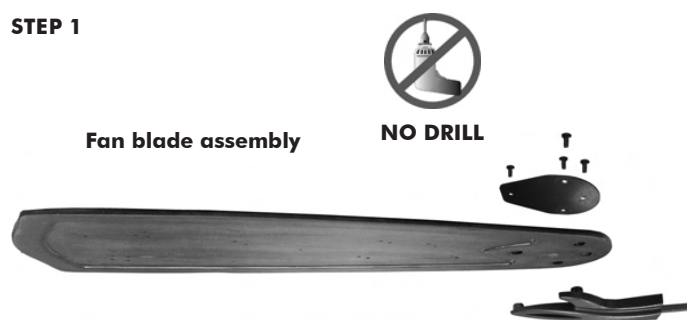

### STEP 2

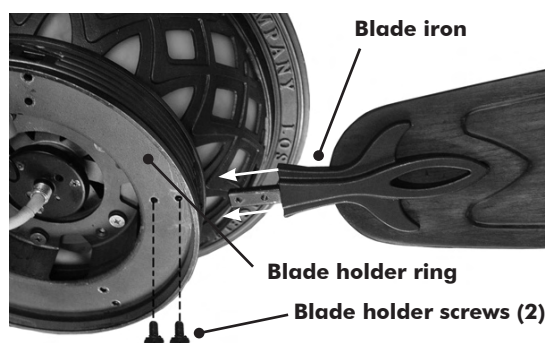

## Attaching

**2** Install the assembled blades to the blade holder ring using the blade iron screws. Use two screws for each blade. Insert the end of the blade holder into the slot on the blade holder ring. Tighten the screws with a manual screwdriver.

⚠ **CAUTION: Do not operate the fan at this point. Installation must be completed before turning on the fan.**

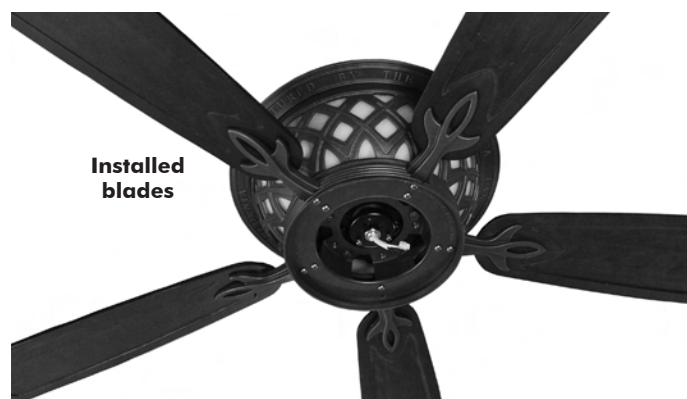

# Installing the Light Fixture

## Hardware (not to scale)



Light Adapter Plate (1)



Light Adapter Screws (3)



Light Fixture Screws (4)



Halogen Downlight Bulbs, 50W (2)

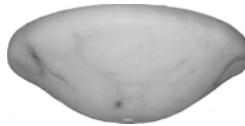

Glass Shade (1)



Finial (1)



Light Fixture (1)

## Attaching the Light Fixture

- 1** Before getting started, remove the rubberband from the plug connector.
- 2** Install two of the three light adapter screws into the light adapter plate. Thread the plug connector through the hole in the center of the light adapter plate.
- 3** Align the two key slot holes with the two screws and rotate the light adapter plate clockwise. Install the third light adapter screw and securely tighten all three screws.
- 4** Connect the light fixture plug to the plug from the bottom of the fan.

### STEPS 2-3

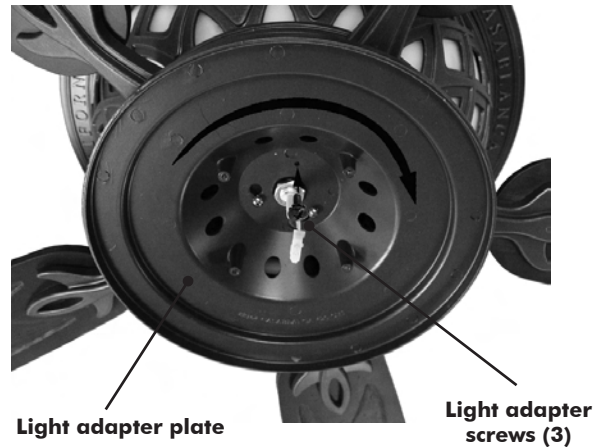

### STEP 4

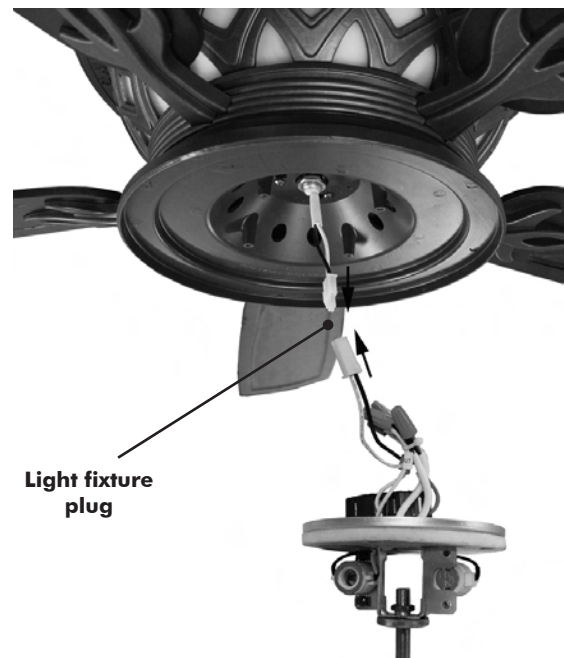

**5** Align the light fixture to the four posts on the light adapter plate using the light fixture screws.

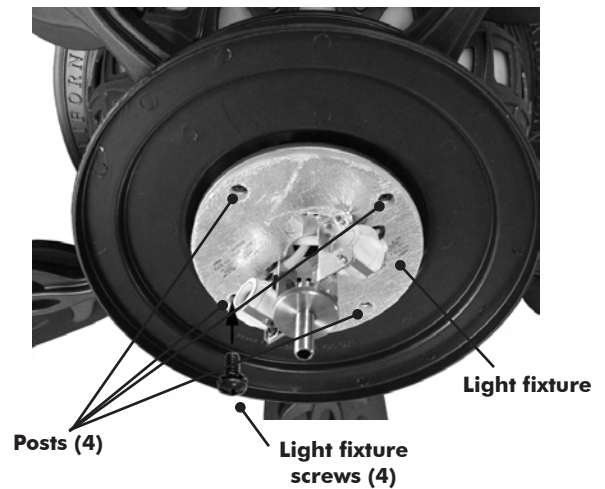
**STEP 5**

## Attaching the Halogen Bulbs

**NOTE:** Do not remove the protective sleeve on the halogen bulb. Touching the glass casing of the bulb may damage or break the glass.

**6** Cut the sleeve to expose the connection end of the bulb. Continue to hold the bulb by the sleeve during installation. Screw both halogen bulbs into the light fixture.

⚠ **CAUTION: Only use maximum 50-watt halogen bulbs!**

**NOTE:** In compliance with US Federal Energy Regulations, this ceiling fan contains a device that restricts the light fixture to a maximum of 190 watts. Exceeding that limit or the marked limit on this product may result in a fire hazard or improper operation.

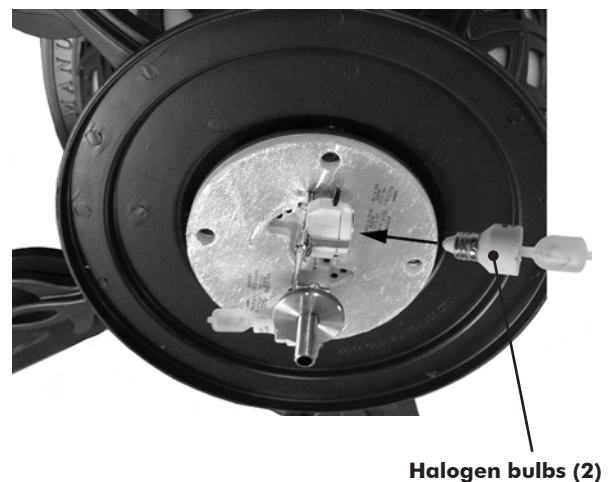
**STEP 6**

## Attaching the Glass Shade

**7** Insert the threaded rod from the light assembly through the hole in the center of the glass shade.

**8** Thread both pieces of the finial onto the threaded rod. Screw the finial into place securely.

### STEP 7

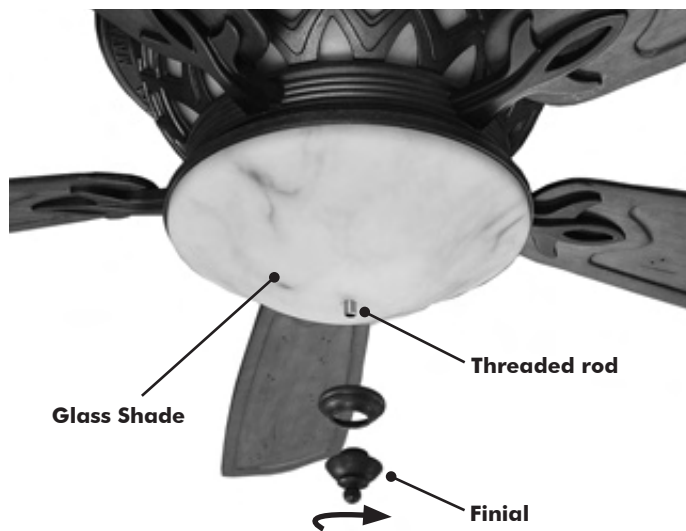

### STEP 8



## Troubleshooting Tips

---

Please refer to this troubleshooting guide before requesting service or contacting your dealer for assistance.

### Problems and Possible Remedies

---

#### Fan will not start

- Check the main circuit fuses, circuit breakers, and wall control position. Check all wire connections. Make sure the power is turned off during this inspection.

#### Fan wobbles or shakes excessively

- Be sure the canopy pin is set properly into the slot on the ball.
- The crossbar mounting bracket may be attached too loosely. Make sure the hanger bracket is attached tightly to the ceiling and the downrod assembly is secured firmly.
- The downrod may be attached to the downrod base too loosely. Make sure all the screws are securely tightened.

#### Fan is noisy during operation

- Tighten the canopy screws and mounting plate assembly. Make sure the wire nuts inside the canopy and switch housing are not touching the metal parts and that they have not fallen off the wire splices. Tighten as necessary.
- Tighten the blade irons to the flywheel (or Direct Drive motor) and the blades to the blade iron screws.
- Make sure all the screws in the motor housing are snug but not overly tight.

#### Fan does not run on low speed

- If the fan is new, it may need to be "broken in." Run at high speed for several days.

## Care Recommendations

---

#### Fan Finishes

- For cleaning, use a soft brush or lint-free cloth to prevent scratching the finish.
- Surface smudges or an accumulation of dirt and dust can be removed easily using a mild detergent and slightly dampened soft cloth. An antistatic agent may be used (on the fan base and blades only), but never use abrasive cleaning agents as these will damage the finish.

#### Blades

- Wood-finish blades should be cleaned with a furniture polishing cloth. Occasionally, a light coat of furniture polish may be applied for added protection and beauty.
- For painted and high-gloss blades, surface smudges or an accumulation of dirt and dust can be removed easily using a mild detergent and slightly dampened soft cloth. An antistatic agent may be used, but never use abrasive cleaning agents as these will damage the finish.

#### No Need for Lubrication

- Never lubricate this fan! The precision motor at the heart of your Casablanca fan features sealed bearings that are lubricated for life.
- Do not attempt to oil the motor.

#### Changing Lightbulbs

- Be sure to turn the power to OFF at the wall control or circuit breaker before changing lightbulbs.
- Replace bulbs with the same type as you removed from the light fixture.
- In compliance with US Federal Energy Regulations, this ceiling fan contains a device that restricts the light kit to a maximum of 190 watts. Exceeding that limit or the marked limit on this product may result in a fire hazard or improper operation.



## Free Manuals Download Website

<http://myh66.com>

<http://usermanuals.us>

<http://www.somanuals.com>

<http://www.4manuals.cc>

<http://www.manual-lib.com>

<http://www.404manual.com>

<http://www.luxmanual.com>

<http://aubethermostatmanual.com>

Golf course search by state

<http://golfingnear.com>

Email search by domain

<http://emailbydomain.com>

Auto manuals search

<http://auto.somanuals.com>

TV manuals search

<http://tv.somanuals.com>