

Contents

Introduction	2
Limited warranty.....	3
Safety precautions	3
Important safety instructions	4
Rear panel connections.....	5
Front panel controls.....	6
Front panel display.....	6
Remote control.....	7
Audio connections.....	8
Analog video connections.....	9
HDMI connections.....	9
Surround-sound formats	10
Video formats	10
DVD player setup	11
Video Setup menu	11
Audio Setup menu	13
Dolby Digital Setup menu.....	14
Preference menu	15
Basic operating instructions	16
DivX/MP4 playback	16
Custom installation use.....	17
Technical Specifications	17
Troubleshooting	17

Introduction

Thank you for purchasing this Cambridge Audio Azur range DVD player. We hope that you enjoy many years of pleasure from it.

The new 540D V2 was designed from the ground up for the Azur range based on a new and highly evolved DVD chipset which includes the ability to reproduce a progressive scan image in both PAL and NTSC formats via either analog component video or the new digital HDMI output. Great care has been taken with both the digital and analog video circuitry to achieve the best possible video performance whichever connection you use. The HDMI output is also capable of up-scaling to 720p or 1080i video formats for use with HD TV sets.

A newly developed proprietary Phase Locked Loop (PLL) system generates very low jitter audio clocks locked to the master video clock fed to the MPEG decoder. This PLL scheme and our normal attention to the DAC and anti-alias filtering circuits ensure the 540D V2 has audio performance equivalent to a dedicated CD player, a rare thing in a DVD player.

The jitter at the SPDIF digital output is also very low for best possible performance when using this connection with an AV receiver for surround-sound use.

Your 540D V2 can only be as good as the system it is connected to. Please do not compromise on your partnering equipment. Naturally we particularly recommend equipment from the Cambridge Audio Azur range, which have been designed to the same exacting standards as this product. Your dealer can also supply excellent quality Cambridge Audio interconnects to ensure your system realises its full potential.

Thank you for taking the time to read this manual, we do recommend you keep it for future reference.

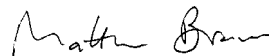

Matthew Bramble,
Cambridge Audio Technical Director
and the DVD player design team.

Visit www.cambridge-audio.com and register to receive notification of future hardware and software releases.

This guide is designed to make installing and using this product as easy as possible. Information in this document has been carefully checked for accuracy at the time of printing; however, Cambridge Audio's policy is one of continuous improvement, therefore design and specifications are subject to change without prior notice. If you notice any errors please feel free to email us at: support@cambridgeaudio.com

This document contains proprietary information protected by copyright. All rights are reserved. No part of this manual may be reproduced by any mechanical, electronic or other means, in any form, without prior written permission of the manufacturer. All trademarks and registered trademarks are the property of their respective owners.

© Copyright Cambridge Audio Ltd 2007

"Dolby", "Pro Logic", "Surround EX" and the double-D symbol are trademarks of Dolby Laboratories.

"DTS", "DTS Digital Surround", "DTS-ES" and "Neo:6" are trademarks of Digital Theater Systems, Inc.

DivX and the DivX logo are registered trademarks of DivX, Inc.

Limited warranty

Cambridge Audio warrants this product to be free from defects in materials and workmanship (subject to the terms set forth below). Cambridge Audio will repair or replace (at Cambridge Audio's option) this product or any defective parts in this product. Warranty periods may vary from country to country. If in doubt consult your dealer and ensure that you retain proof of purchase.

To obtain warranty service, please contact the Cambridge Audio authorised dealer from which you purchased this product. If your dealer is not equipped to perform the repair of your Cambridge Audio product, it can be returned by your dealer to Cambridge Audio or an authorised Cambridge Audio service agent. You will need to ship this product in either its original packaging or packaging affording an equal degree of protection.

Proof of purchase in the form of a bill of sale or receipted invoice, which is evidence that this product is within the warranty period, must be presented to obtain warranty service.

This Warranty is invalid if (a) the factory-applied serial number has been altered or removed from this product or (b) this product was not purchased from a Cambridge Audio authorised dealer. You may call Cambridge Audio or your local country Cambridge Audio distributor to confirm that you have an unaltered serial number and/or you purchased from a Cambridge Audio authorised dealer.

This Warranty does not cover cosmetic damage or damage due to acts of God, accident, misuse, abuse, negligence, commercial use, or modification of, or to any part of, the product. This Warranty does not cover damage due to improper operation, maintenance or installation, or attempted repair by anyone other than Cambridge Audio or a Cambridge Audio dealer, or authorised service agent which is authorised to do Cambridge Audio warranty work. Any unauthorised repairs will void this Warranty. This Warranty does not cover products sold AS IS or WITH ALL FAULTS.

REPAIRS OR REPLACEMENTS AS PROVIDED UNDER THIS WARRANTY ARE THE EXCLUSIVE REMEDY OF THE CONSUMER. CAMBRIDGE AUDIO SHALL NOT BE LIABLE FOR ANY INCIDENTAL OR CONSEQUENTIAL DAMAGES FOR BREACH OF ANY EXPRESS OR IMPLIED WARRANTY IN THIS PRODUCT. EXCEPT TO THE EXTENT PROHIBITED BY LAW, THIS WARRANTY IS EXCLUSIVE AND IN LIEU OF ALL OTHER EXPRESS AND IMPLIED WARRANTIES WHATSOEVER INCLUDING, BUT NOT LIMITED TO, THE WARRANTY OF MERCHANTABILITY AND FITNESS FOR A PRACTICAL PURPOSE.

Some countries and US states do not allow the exclusion or limitation of incidental or consequential damages or implied warranties so the above exclusions may not apply to you. This Warranty gives you specific legal rights, and you may have other statutory rights, which vary from state to state or country to country.

Plug Fitting Instructions (UK Only)

The cord supplied with this appliance is factory fitted with a UK mains plug fitted with a 3 amp fuse inside. If it is necessary to change the fuse, it is important that a 3 amp one is used. If the plug needs to be changed because it is not suitable for your socket, or becomes damaged, it should be cut off and an appropriate plug fitted following the wiring instructions below. The plug must then be disposed of safely, as insertion into a mains socket is likely to cause an electrical hazard. Should it be necessary to fit a 3-pin BS mains plug to the power cord the wires should be fitted as shown in this diagram. The colours of the wires in the mains lead of this appliance may not correspond with the coloured markings identifying the terminals in your plug. Connect them as follows:

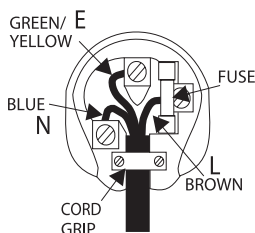

The wire which is coloured BLUE must be connected to the terminal which is marked with the letter 'N' or coloured BLACK.

The wire which is coloured BROWN must be connected to the terminal which is marked with the letter 'L' or coloured RED.

The wire which is coloured GREEN/YELLOW must be connected to the terminal which is marked with the letter 'E' or coloured GREEN.

If your model does not have an earth wire, then disregard this instruction.

If a standard 13 amp (BS 1363) plug is used, a 3 amp fuse must be fitted, or if any other type of plug is used a 3 amp fuse must be fitted, either in the plug or adaptor, or on the distribution board.

Safety precautions

Checking the Power Supply Rating

For your own safety please read the following instructions carefully before attempting to connect this unit to the mains.

Check that the rear of your unit indicates the correct supply voltage. If your mains supply voltage is different, consult your dealer.

This unit is designed to operate only on the supply voltage and type that is indicated on the rear panel of the unit. Connecting to other power sources may damage the unit.

This equipment must be switched off when not in use and must not be used unless correctly earthed. To reduce the risk of electric shock, do not remove the unit's cover (or back). There are no user serviceable parts inside. Refer servicing to qualified service personnel. If the power cord is fitted with a moulded mains plug the unit must not be used if the correct fuse carrier is not in place. Should you lose the fuse carrier the correct part must be reordered from your Cambridge Audio dealer.

 The symbol on this product indicates that it is of CLASS II (double insulated) construction.

The lightning flash with the arrowhead symbol within an equilateral triangle is intended to alert the user to the presence of un-insulated 'dangerous voltage' within the product's enclosure that may be of sufficient magnitude to constitute a risk of electric shock to persons. 

 The exclamation point within an equilateral triangle is intended to alert the user to the presence of important operating and maintenance instructions in the service literature relevant to this appliance.

The crossed-out wheeled bin is the European Union symbol for indicating separate collection for electrical and electronic equipment. This product contains electrical and electronic equipment which should be reused, recycled or recovered and should not be disposed of with unsorted regular waste. Please return the unit or contact the authorised dealer from whom you purchased this product for more information. 

Approvals

 This product complies with European Low Voltage (73/23/EEC) and Electromagnetic Compatibility (89/336/EEC) Directives when used and installed according to this instruction manual. For continued compliance only Cambridge Audio accessories should be used with this product and servicing must be referred to qualified service personnel.

NOTE: THE MANUFACTURER IS NOT RESPONSIBLE FOR ANY RADIO OR TV INTERFERENCE CAUSED BY UNAUTHORIZED MODIFICATIONS TO THIS EQUIPMENT. SUCH MODIFICATIONS COULD VOID THE USER AUTHORITY TO OPERATE THE EQUIPMENT.

This equipment has been tested and found to comply with the limits for a Class B digital device, pursuant to Part 15 of the FCC Rules. These limits are designed to provide reasonable protection against harmful interference in a residential installation. This equipment generates, uses and can radiate radio frequency energy and, if not installed and used in accordance with the instructions, may cause harmful interference to radio communications. However, there is no guarantee that interference will not occur in a particular installation.

If this equipment does cause harmful interference to radio or television reception, which can be determined by turning the equipment off and on, the user is encouraged to try to correct the interference by one or more of the following measures:

- Re-orient or relocate the receiving antenna.
- Increase the separation between the equipment and receiver.
- Connect the equipment into an outlet on a circuit different from that to which the receiver is connected.
- Consult the dealer or an experienced radio/TV technician for help.

Important safety instructions

Please take a moment to read these notes before installing your 540D V2, as they will enable you to get the best performance and prolong the life of the unit. We advise you follow all instructions, heed all warnings and keep the instructions for future reference.

Ventilation

IMPORTANT - The unit will become hot when in use.

Please ensure there is ample ventilation (at least 10cm clearance all round). Do not put any objects on top of this unit. Do not situate it on a rug or other soft surface and do not obstruct any air inlets or outlet grilles. Do not install near any heat sources such as radiators, heat registers, stoves, or other apparatus (including amplifiers) that produce heat. Do not stack multiple units on top of each other. Do not place in an enclosed area such as a bookcase or in a cabinet without sufficient ventilation.

Ensure that small objects do not fall through any ventilation grille. If this happens, switch off immediately, disconnect from the mains supply and contact your dealer for advice.

Positioning

Choose the installation location carefully. Avoid placing it in direct sunlight or close to a source of heat. Also avoid locations subject to vibration and excessive dust, cold or moisture. Do not place the unit on an unstable surface or shelf. The unit may fall, causing serious injury to a child or adult as well as serious damage to the product. Do not place other equipment on top of the unit.

This unit must be installed on a sturdy, level surface. Do not place in a sealed area such as a bookcase or in a cabinet. Any space open at the back (such as a dedicated equipment rack) is fine however. When a cart is used, use caution when moving the cart to avoid injury from tip-over.



WARNING - To reduce the risk of fire or electric shock, do not expose this unit to rain or moisture. This unit must not be used near water or exposed to dripping or splashing water or other liquids. No objects filled with liquid, such as vases, shall be placed on the unit. In the event, switch off immediately, disconnect from the mains supply and contact your dealer for advice.

Electronic audio components have a running in period of around a week (if used several hours per day). This will allow the new components to settle down, the sonic properties will improve over this time.

Grounding and polarisation

Do not defeat the safety purpose of the polarized or grounding type plug. A polarized plug has two blades with one wider than the other. A grounding type plug has two blades and a third grounding prong. The wide blade or third prong are provided for your safety. If the provided plug does not fit your outlet, consult an electrician for replacement of the obsolete outlet.

Power sources

The unit is of Class 1 construction and must be connected to a Mains socket outlet with a protective earthing connection.

The unit should be operated only from the type of power source indicated on the marking label. If you are not sure of the type of power-supply to your home, consult your product dealer or local Power Company.

This unit has been designed to be left in Standby mode when not in use, this will increase the life of the amplifier (this is true with all electronic equipment). To turn the unit off completely switch off on the rear panel. If you do not intend to use this unit for a long period of time, unplug it from the mains socket.

Power cord protection

The unit must be installed in a manner that makes disconnection of the mains plug from the mains socket outlet (or appliance connector from the rear of the unit) possible. Where the mains plug is used as the disconnect device, the disconnect device shall remain readily operable. Protect the power cord from being walked on or pinched particularly at plugs, convenience receptacles, and the point where they exit from the unit.

Be sure to insert each power cord securely. To prevent hum and noise, do not bundle the interconnect leads with the power cord or speaker leads.

Overloading

Do not overload wall outlets or extension cord as this can result in a risk of fire or electric shock. Overloaded AC outlets, extension cords, frayed power cords, damaged or cracked wire insulation, and broken plugs are dangerous. They may result in a shock or fire hazard.

Lightning

For added protection during a thunderstorm, or when it is left unattended and unused for long period of time, unplug the unit from the wall outlet and disconnect the antenna or cable system. This will prevent damage to the unit from lightning and power-line surges.

Cleaning

To clean the unit, wipe its case with a dry, lint-free cloth. Do not use any cleaning fluids containing alcohol, ammonia or abrasives. Do not spray an aerosol at or near the unit. The use of a lens cleaning disc at least once a month can also prolong unit life.

Attachments

Do not use attachments not recommended by your dealer as they may cause harm to the unit. Only use the specified attachments/accessories with this unit.

Servicing

These units are not user serviceable, never attempt to repair, disassemble or reconstruct the unit if there seems to be a problem. A serious electric shock could result if this precautionary measure is ignored. In the event of a problem or failure, please contact your dealer.

Contact the service department should any of these conditions occur:

- When the power-supply cord or plug is damaged.
- If liquid has been spilled, or objects have fallen into the unit.
- If the unit has been exposed to rain or water.
- If the unit does not operate normally after following the operation instructions, adjust only those controls that are covered by the operation instructions.
- If the unit has been dropped or damaged in any way.
- When the unit exhibits a distinct negative change in performance.

Important Note



This unit has been designed to play video DVDs, compact discs, recordable CDs (CD-R) and re-writable CDs (CD-RW) bearing the identification logo shown here. No other discs can be used. The CD-R/CD-RW discs should contain properly recorded TOC (Table of Contents) information so that they can be played back. This unit can play only the discs recorded in the CD-DA format designed for music reproduction. Do not attempt to play a disc on this unit containing other data, such as a CD-ROM for PCs.

Rear panel connections

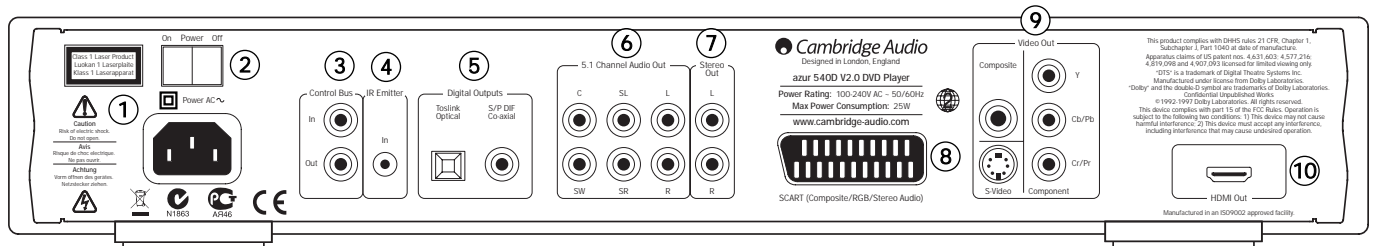

① AC power socket

Once you have made all audio and video connections, plug the IEC type AC power cable into the rear of the unit and an appropriate mains socket then switch on. Your DVD player is now ready for use.

② Power On/Off

Switches the unit on and off.

③ Control Bus

In - Allows un-modulated commands from multi-rooms systems or other components to be received by the unit.

Out - Loop out for Control Bus commands to another unit.

④ IR (Infra-Red) Emitter In

Allows modulated IR commands from multi-room systems or IR repeater systems to be received by the unit. Commands received here are not looped out of the Control Bus. Refer to the 'Custom Installation' section of this manual for more information.

⑤ Digital Outputs

Digital audio outputs are normally used to connect to a suitable Audio/Video Receiver for surround sound decoding (output must be set for 'RAW Bitstream' - refer to the 'Audio setup' section). These outputs can also be used to connect to a separate DAC or digital recording device (output must be set for 'PCM Stereo' - refer to the 'Audio setup' section).

Toslink Optical - Use a high quality TOSLINK fibre optic cable.

S/P DIF Co-Axial Digital - Use a high quality 75 ohm digital RCA/Phono interconnect cable designed specifically for digital audio use.

⑥ 5.1 Channel Audio Out

If Downmix is set to 'Off' in the Speaker Setup section of the 540D V2's Setup menus, these sockets provide 5.1 output from the 540D V2's built in Dolby Digital / Pro Logic II decoder. This can be used to connect to the 5.1 audio line-level inputs of an amplifier/AV receiver or amplified speaker package if required.

If Downmix is set to 'On', the Left and Right outputs only are active and provide a stereo downmixed output.

⑦ Stereo Audio Out

A separate permanent Stereo output (or Stereo downmix in the case of multi-channel material) is available for connection to the analog stereo inputs of an amplifier/AV receiver etc. This is the best connection to use for listening to CDs.

⑧ RGB/SCART

Use a SCART/Peritel cable to connect to the 21-pin scart input jack of a TV. SCART carries both audio (stereo) and video (as either Composite, S-Video or RGB) at the same time.

⑨ Analog Video Outputs

Composite - Connect to your television via 75 ohm RCA/phono cable designed specifically for video use.

S-Video - Connect to your television via dedicated S-Video cable.

Component - Connect to the YCbCr or YPbPr terminals of a television set via three 75 ohm RCA/phono cables designed specifically for video use.

⑩ HDMI Out

HDMI (High-Definition Multi-Media Interface) is a purely digital connection that can carry both audio and video. Use a dedicated HDMI cable to connect to a TV/Monitor with a compatible HDMI input.

Note: The preferred connection method for video sources is always HDMI (highest quality, and can also carry audio in some circumstances) then Component Video then RGB/SCART then S-Video then Composite Video (lowest quality). The HDMI and Component outputs also support Progressive Scan which gives better picture quality if supported by your TV.

Front panel controls

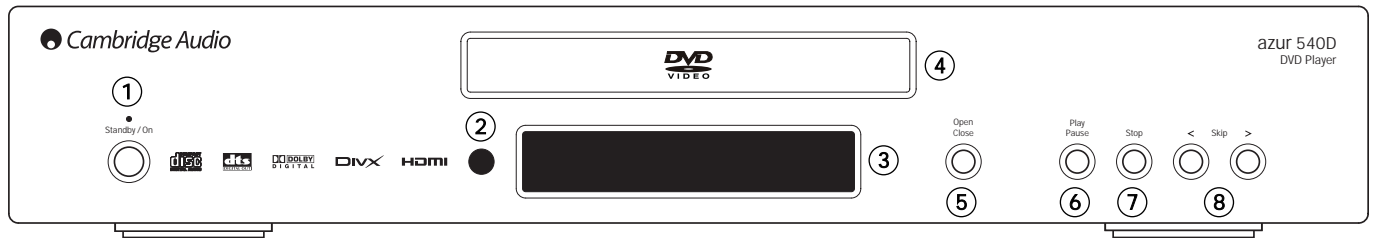

① Standby/On

Switches the unit between Standby mode (indicated by a dim power LED) and On (indicated by a bright power LED). Standby is a low power mode where the power consumption is less than 10 Watts. The unit should be left in Standby mode when not in use.

② IR sensor

Receives IR commands from the supplied Azur remote control. A clear unobstructed line of sight between the remote control and the sensor is required.

③ Display

Used to display the 540D V2's functions and playback state etc. Please refer to the following 'Front Panel Display' section for more information.

④ Disc tray

DVD/Compact Disc tray. Use the *Open/Close* button to activate.

⑤ Open/Close

Allows you to open and close the disc tray for loading of discs. Pressing *Play* will also close the tray and start playing a disc if one is loaded.

⑥ Play/Pause

Plays the disc and pauses (freezes) play when playing.

⑦ Stop

Press once to stop playback. Pressing *Play* will cause the playback be re-started from the same position. Press again to fully stop playback.

⑧ Skip

Press once to skip between tracks/chapters.

Front panel display

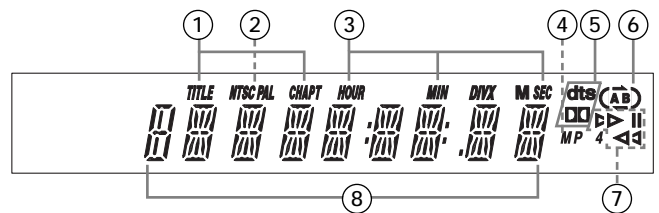

① Title/Chapter

Indicates the chapter title and chapter number fields.

② Video format

Displays the video output format: NTSC or PAL.

③ Time

Shows the hour, minutes and seconds elapsed on the disc.

④ MP4

Indicates a DivX/MP4 encoded disc is playing.

⑤ Decoding mode indicators

Indicate when a Dolby Digital soundtrack is being played back (either decoded internally or output digitally for external decoding) or DTS soundtrack (for external decoding only).

⑥ Repeat

Shows when Repeat (⏮), Repeat All (⏪) and A-B Repeat (⏮⏪) functions are in use.

⑦ Playback

Shows when the disc is being played or paused.

⑧ Main information display

Used to display the various functions of the unit.

Remote control

The 540D V2 is supplied with an Azur Navigator remote control. Insert the 3 supplied AAA batteries to activate. For further details of the various adjustment functions available, refer to the later sections of this manual.

Open/Close

Opens and closes the disc tray.

Standby/On

Switches the unit between On and Standby mode.

Numerical buttons

Press the number of a desired chapter or track to go directly to it. For a number greater than ten, press 10+ followed by the number(s) required.

Go To

Press once to access Chapter Selection then enter the required chapter via the numerical buttons. Press twice to access Disc Time Selection and enter the required time from the start of the disc as H:MM:SS (Hours, Minutes, Seconds). Press three times to access Chapter Time Selection and enter the required time from the start of the chapter.

Repeat

Press to repeatedly play a single chapter/title on a DVD video or a single track/entire disc on a CD. The first press selects chapter/track repeat, the second press selects title/disc repeat, the third press selects all repeat.

A-B

Press to mark a segment between A and B for repeated playback. The first press marks point A, the second press marks point B.

Return

Press to return to the previous operation in any setup menu.

Disc Menu

Press to go to a DVD disc's own setup menu.

Setup

Press to enter the 540D V2's Setup menu. Please refer to the 'DVD player setup' section of this manual for more information.

Info

While playing a DVD, press to cycle through the following information options to be displayed on the screen: Title Elapsed, Title Remain, Chapter Elapsed, Chapter Remain, Info Off.

Disc Title

Press to access the DVDs Title Menu. This is usually the root menu from where the film can be started or where navigation to scene selections, special features etc can be made.

Navigation

Press the directional arrows to move around the Setup menus.

Enter

Press to accept the item/function highlighted in the display menu.

Play / Stop / Pause

Press the relevant button to play, stop or pause playback.

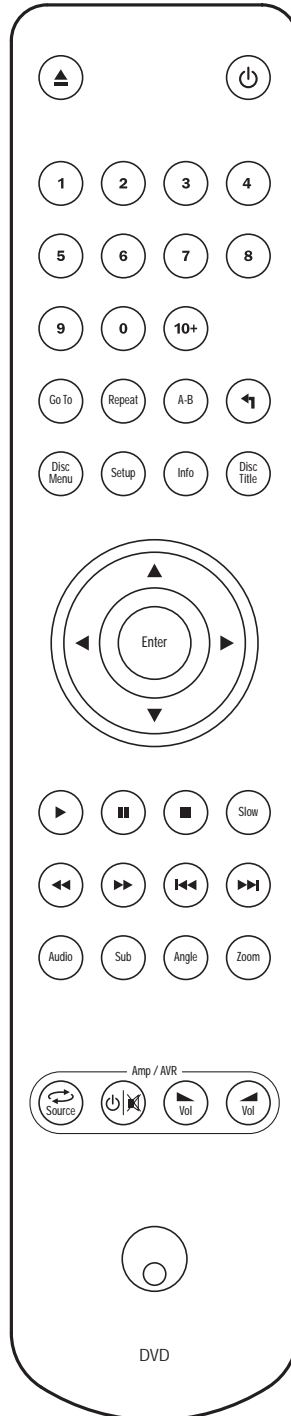

Note: If *Stop* is pressed once playback can be resumed from the same place by pressing *Play*. Press *Stop* twice to completely stop playback. If *Pause* is selected pressing the *Slow* key then allows frame by frame advancement of the paused frame.

Slow

When playing a DVD, press repeatedly to cycle round the various speeds of slow motion, forwards and backwards and back to normal speed).

Search

Press repeatedly to cycle between 2X, 4X, 8X and 16X playback speed (without sound) and back to normal playback. Left button for backwards playback options, right button for forwards playback.

Skip

Right Skip - Press once to skip forward by one track/chapter on the disc. Press and hold to skip forwards through several tracks.

Left Skip - Press once to skip backward by one track/chapter on the disc. Press and hold to skip backwards through several tracks.

Audio

Press to access alternate audio soundtracks on the DVD (if available on the DVD disc).

Sub

Press to enable/disable Subtitles (if available on the DVD disc).

Angle

Press to access various camera angles (if available on the DVD disc).

Zoom

Press to cycle through the various zoom magnifications (and back to normal display).

Amp/AVR buttons

The 540D V2 remote also has buttons that allow control of a Cambridge Audio Azur Amplifier or AV Receiver.

Note: These buttons are default set to transmit codes for our Azur 540R AV Receiver. To set the remote to an Azur 640R instead, simply remove the batteries, leave the remote for a few minutes and then hold down the *Source* button whilst re-inserting the batteries. To control an Azur 540A/640A/740A/840A follow the same steps as before, but hold down the *Standby/On/Mute* button.

The functions relevant to the amplifier or AV Receiver chosen are as follows:

Source

Press repeatedly to scroll round the source inputs one by one.

Standby/On / Mute

Press to switch the amplifier/AV Receiver between Standby mode and On. Press and hold to mute/un-mute the amplifier/AV Receiver.

Volume

Press to decrease or increase the volume of the amplifier/AV Receiver.

Audio connections

Do not plug in the mains power lead or turn the unit on until all connections have been made.

Three types of audio connection can be made between the 540D V2 and your stereo/AV system:

- ① Analog Stereo
- ② Digital Audio
- ③ Analog 5.1

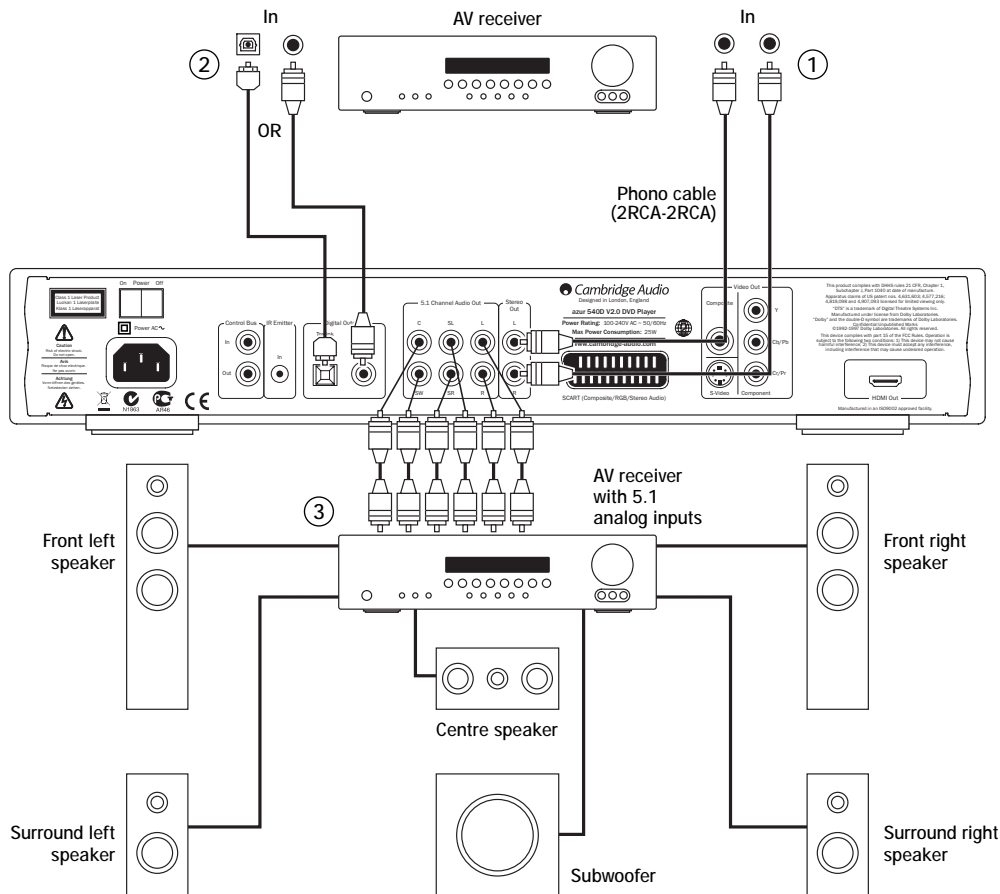

① Analog stereo

The analog stereo outputs should be used play back of CDs, DVDs etc in stereo through a conventional amplifier or AV receiver with analog stereo inputs.

Analog stereo is also usually the best connection method for listening to CDs and other stereo discs for best possible sound quality. It is often a good idea to connect both the analog stereo outputs (for CD playback) and digital audio outputs (for surround sound decoding) at the same time.

To connect an analog stereo system to the 540D V2, use stereo phono cables (stereo 2RCA-2RCA).

② Digital audio

The digital audio outputs should be used to decode the surround-sound soundtracks of DVDs with an external AV Receiver (Note: SPDIF output must be set to 'RAW Bitstream' in the Audio Setup menu). The 540D V2 sends an undecoded audio bitstream to the AV Receiver for decoding into 5.1/6.1/7.1 etc.

Either a 75ohm co-axial cable designed for digital audio or a Toslink fibre optic cable should be used (only one at a time).

Note: It is also possible to output stereo digital audio from the Digital Outputs for recording on conventional CD-R/MD etc. machines, see section on DVD Player setup.

③ Analog 5.1

The 540D V2 is also capable of decoding Dolby Digital 5.1 or Dolby Pro Logic II soundtracks itself and outputting these as Analog 5.1.

Note: Downmix should be set to 'Off' in the Speaker Setup menu for this to work.

To connect to an AV receiver or amplified speaker system, use 6 x phono/RCA cables.

Analog video connections

The 540D V2 can output video in both fully digital (HDMI) and analog (Composite, S-Video, RGB/SCART and Component) formats. If your TV set supports HDMI then this is the preferred format (see next section).

If your TV set supports only analog video the preferred connection is (in declining order of quality) Component, then RGB/SCART, S-Video and finally Composite.

- ① Component - Connect with 75 ohm Component video cables (3RCA-3RCA).
- ② SCART/RGB - Connect with a dedicated Scart Audio/Video cable.
- ③ S-Video - Connect with S-Video cable.
- ④ Composite - Connect with single 75 ohm video phono cable (RCA-RCA).

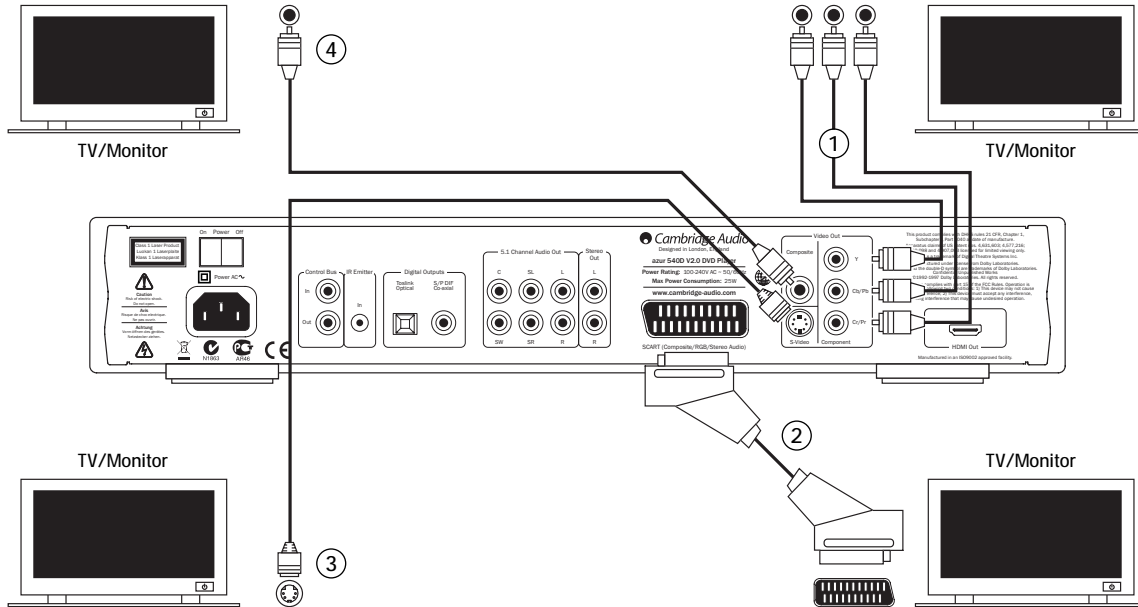

HDMI connections

HDMI (High-Definition Multi-Media Interface) is a digital connection that can carry both audio and video in one cable. Direct digital transfer of video and support for various types of High Definition video content make this the best connection type for picture quality.

DVI output can be supported simply by using DVI to HDMI adaptors as these two connection types are compatible. When using DVI only video will be passed to the TV/Monitor. A Co-axial (SPDIF) or Optical (TOSlink) digital audio connection must be made from the 540D V2 to the AV receiver for it to be able to receive audio and decode surround sound etc.

As HDMI can carry both digital audio and video, HDMI can be used to connect to AV receivers that support this function. If your AV receiver is able to receive audio over HDMI only one cable is required*.

***If your AV receiver can switch HDMI but not receive audio in this way, an additional SPDIF or TOSlink cable will be required.**

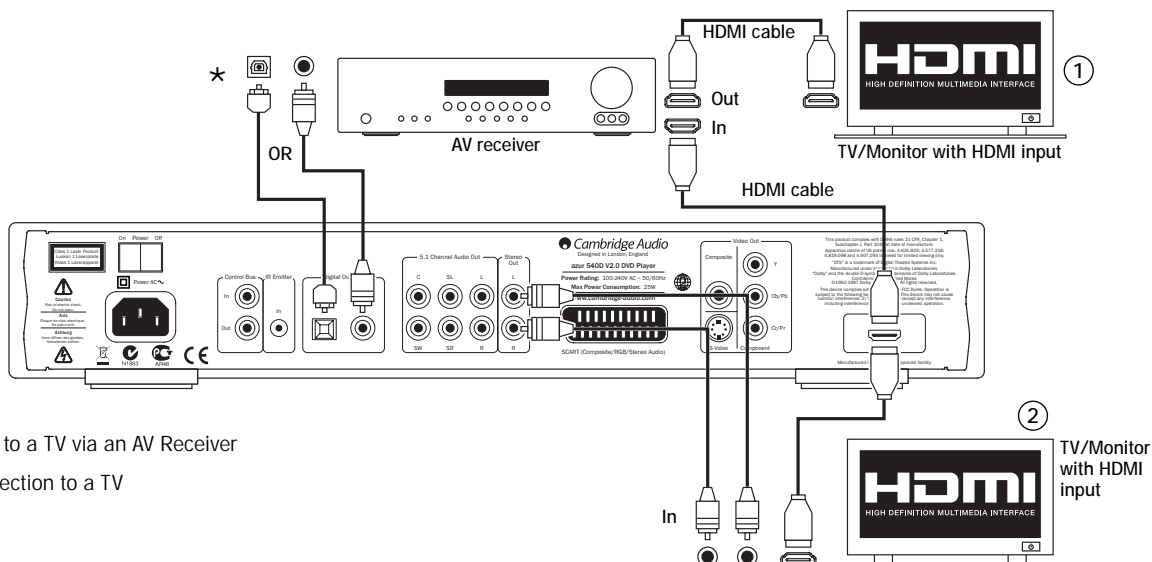

- ① Connection to a TV via an AV Receiver
- ② Direct connection to a TV

Surround-sound formats

Via its analog outputs the 540D V2 can playback CDs in stereo and DVDs in either stereo or up to 5.1 output when they have been encoded with Dolby Digital or Dolby Pro Logic / Pro Logic II formats.

Dolby Digital EX 6.1 discs can also be played back but only 5.1 output will be available (the 6th channel will be shared between the rear surround left and right speakers).

The Stereo outputs of the 540D V2 always output stereo whether the material is a stereo CD/DVD or multi-channel DVD.

The 5.1 outputs can be set for downmix (in which case the front left and right only will be active) or 5.1 output (downmix off).

Note: If Downmix is set to 'Off' the default playback system is Dolby Digital. If Pro Logic II is preferred this needs to be set to 'On' in the 540D V2 Setup menus.

The optional DTS soundtracks on some discs cannot be decoded by the 540D V2, however the machine is able to send a raw bitstream version of any soundtrack via its digital outputs for decoding by an external AV Receiver and this is actually the preferred setup even if just Dolby Digital decoding is required. This allows the decoding of the many other surround-sound formats available in 5.1/6.1/7.1 and beyond.

We naturally recommend our own AV Receivers which offer many decoding options and other facilities for the processing of surround sound.

Below is a brief guide to common surround-sound formats you may encounter:

Dolby Digital (5.1)

The mandatory soundtrack encoding for DVD movies. Known also as DD (3/2) or DD 5.1, DD provides (up to) 5.1 output from suitable encoded Dolby Digital DVD's. There are 5 main channels (Front Left, Front Right, Centre, Surround Left, Surround Right) and a Low Frequency Effects Channel for the subwoofer, all discretely encoded. Decoding Dolby Digital requires a Dolby Digital encoded DVD disc (nearly all DVDs) and either a digital connection from the 540D V2 to a suitable AV Receiver (preferred method) or the 540D V2's own built in decoder can be used in which case a 5.1 analog connection from the 5.1 Audio outputs to a suitable amplifier/speaker package is required.

Note: Dolby Digital and DTS formats can sometimes carry less channels than their maximum such as Dolby Digital (2/0) which means a Dolby Digital encoded signal which is actually only carrying a two channel stereo signal (other channels inactive).

Pro Logic II

Pro Logic II is a Dolby technology where 5 channels (Front Left, Front Right, Centre, Surround Left, Surround Right) are encoded into a Stereo mix by an analog matrix process.

Dolby Pro Logic II is also compatible with the earlier 4 channel (Left, Centre, Right and mono Surround) Dolby Pro Logic system (which was the decoding counterpart to Dolby Surround encoding) which was used widely on TV material and earlier films. PL and PLII are present on many early films and often also in the stereo soundtrack available as alternative alongside the DD 5.1 on many newer films.

The 540D V2 can decode PLII via its own decoder or an external AV Receiver can be used. Because the encoding process is analog an AV Receiver can usually decode PLII from either an Analog Stereo or Digital connection from the 540D V2 to the AV Receiver. Consult your receivers manual.

If it is desired to use the 540D V2's own built in PLII decoder a 5.1 analog connection from the 540D V2's 5.1 Audio outputs to a suitable amplifier/speaker package should be made, downmix should be set to 'Off' and Pro logic II decoding set to 'On' in the 540D V2 Setup menus.

Dolby Digital EX

Known also as DD (3/3) or DD 6.1, an enhanced form of Dolby Digital. On top of the discretely encoded 5.1 channels DD EX provides an extra 6th channel (Surround Back, giving 6.1 or 7.1 with mono rear surrounds) matrix encoded into the rear surrounds. Decoding Dolby Digital EX requires a Dolby Digital EX encoded DVD disc and a digital connection from the 540D V2 to a suitable AV Receiver that can decode this format as the 540D V2 itself cannot decode DD EX. If a DD EX encoded disc is played back on the 540D V2 however 5.1 output will still be created as DD EX is backwards compatible with DD 5.1 decoding. The 6th Surround Back signal will be present in both Left and Right Rear Surrounds (forming a phantom rear centre).

DTS 5.1, DTS-ES 6.1 Matrix, DTS-ES 6.1 Discrete, DTS Neo:6, DTS 96/24

Various DTS technologies that provide (up to) 5.1/6.1 (and 7.1 with mono rear surrounds) output from suitable encoded DTS material.

Some newer DVDs carry both the mandatory DD and an optional DTS surround encoding on alternative audio tracks.

The 540D V2 cannot decode these optional DTS formats itself but can pass them via its digital outputs for decoding externally by a suitable AV Receiver. Decoding DTS requires a suitably encoded DTS disc and a digital connection from the 540D V2 to an AV Receiver capable of decoding the appropriate DTS encoding type.

Video formats



DVDs are encoded using the MPEG 2 lossy video format giving over 2 hours of high-quality digital video on single layer discs or over 4 hours on dual-layer discs.

Note: Dual layer discs always exhibit a small pause or delay in playback when the layer transition is made.

As well as the video itself DVDs are also capable of storing up to 8 alternative tracks of digital audio, 32 subtitle tracks and 9 camera angles (where used by the film producers).

DivX is an even more compressed (than normal DVD) digital video format a bit like MP3 for video. DivX compresses the video data to a fraction of its original size using the more lossy MPEG 4 Part 2 compression. DivX enhances the basic MP4 encoding by allowing extra features on the disc and various levels of quality/compression to be applied at the encoding stage.

DivX or straight forward raw MPEG 4 files are supported by the 540D V2 on either CD or DVD discs.



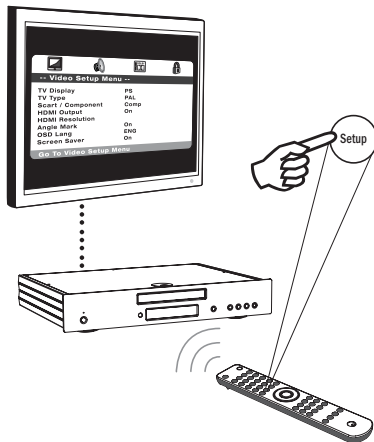

The 540D V2 MAY also be able to play MP4 type files created with other CODEC programs (such as Xvid®) but playback of these is not guaranteed.

DVD player setup

Press the *Setup* button on the remote to enter the 540D V2 Setup menus:



Running along the top of the screen are four icons that represent the four main menu sections:

-  Video Setup
-  Audio Setup
-  Dolby Digital Setup
-  Preference Setup*

* **Note:** To enter the Preferences menu the unit must first be in stop mode with the disc drawer out.

Press *Setup* to enter the menu system. Use the *Navigation arrows* (▲▼◀▶) on the remote to highlight the icon at the top of the screen for the main menu you want to select and then either press *Enter* or ▼ to go into that menu and select its first sub-menu. You can now navigate to each sub-menu item you might want to change using ▲▼ and then ◀▶ to select settings.

The yellow highlight always shows the menu or setting you have navigated to, the orange/brown highlight shows the current setting that is being used. Pressing *Enter* stores a highlighted setting as the new one to use. To navigate back out of a sub-menu press ◀ to move to the sub menu list if necessary and ◀ again to move to the top main menu list. You can now use ◀▶ to select a new main menu.

Note: Some setup is inter-related with other setup items, and if enabling a function automatically disables another, the disabled function will appear grey and cannot be set.

All setup is saved on exiting the menus and is saved even if the unit is powered off.

Video Setup menu

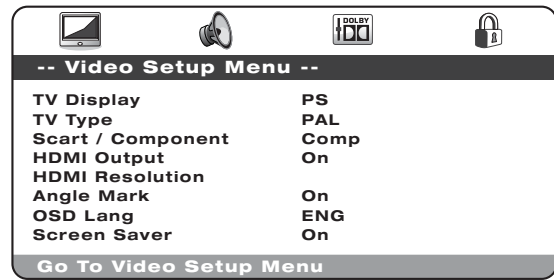

With the Video Setup menu selected, use the ▲ and ▼ arrows to move up/down to the desired sub-menu. Use the *Navigation arrows* (▲▼◀▶) to adjust the settings and press the *Enter* button to confirm your selection. See the following list for the Video Setup menu structure:

<u>Menus</u>	<u>Settings</u>
TV Display	4:3 PanScan 4:3 LettBox 16:9 Wide
TV Type	PAL AUTO NTSC
SCART/Component	Component-p Component-i Scart RGB
HDMI output	On Off
HDMI resolution	480p (60Hz) 576p (50Hz) 720p (50Hz) 1080i (50Hz) 720p (60Hz) 1080i (60Hz)
Angle mark	On Off
OSD Lang	English Español Deutsch Français Italiano Nederlands Русский
Screen Saver	On Off

TV Display

Use to select the screen format to fit your TV screen.

4:3 PanScan - You can select this screen when connected to a normal TV set. The widescreen picture will display on the full screen, but some parts of the video picture will be cut off automatically.

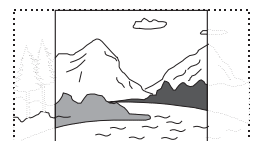

4:3 LettBox - Alternatively you can select this screen when connected to a normal TV set. The full widescreen picture is displayed on the screen with black strips on the top and bottom of the screen.



Video Setup menu continued

16:9 Wide - Select this screen when connected to a widescreen TV set. The full picture will now normally be displayed with no picture cropping (unless the movie itself has black bars recorded into the video).



TV Type

Either select 'NTSC' or 'PAL' to force the analog video outputs of the 540D V2 to the TV system in your area (the 540D V2 will also then automatically convert any PAL DVDs to NTSC playback or vice versa as necessary) or select 'AUTO' to allow the output of the 540D V2 to follow the encoding on the disc.

Note: Some TVs are unable to display both types of system and a blank screen/no picture may appear if the wrong system is selected.

SCART / Component

Note: HDMI output must be set to 'Off' for this menu to be accessible.

Select between the following choices:

Component-p - Enables progressive scan component (YPbPr) using the 3 phono/RCA component outputs on the rear panel.

Component-i - Enables interlaced scan component (YCbCr) using the 3 phono/RCA component outputs on the rear panel.

SCART RGB - Enables interlaced scan RGB + Sync using the SCART/Peritel output on the rear panel.

Note: Not all TV sets can accept Progressive Scan Component and a blank screen may result if the TV set does not support this format.

For Component-p the component outputs will be 480p if the TV type has been set to NTSC, 576p if the TV type has been set to PAL. Similarly for Component-i the component outputs will 480i if the TV type has been set to NTSC, 576i if the TV type has been set to PAL. If the Auto setting is used the format will follow the disc type.

Notes:

- The Composite (CVBS) and S-Video outputs are always present and always output interlaced video whether Component, RGB or HDMI is selected.
- Setting HDMI output to 'On' disables the TV type and SCART/Component menus and in fact always forces the component outputs 'On' in component-p (Progressive Scan) format.
- With HDMI output 'On' all analog video outputs will output PAL if a 50Hz HDMI mode is selected or will output NTSC if a 60Hz HDMI mode is selected.
- With HDMI output 'Off' all analog video outputs follow the TV type for their PAL/NTSC mode choice.

HDMI Setup

The default setting is 'Off'. If you can make an HDMI connection to your TV, turn the HDMI output to 'On' and the HDMI resolution choices will become available. Choose the resolution you desire:

480p (60Hz) - Progressive format PAL

576p (50Hz) - Progressive format NTSC

720p (50Hz) - Upscaled to PAL at 720 lines progressive

1080i (50Hz) - Upscaled to PAL at 1080 lines interlaced

720p (60Hz) - Upscaled to NTSC at 720 lines progressive

1080i (60Hz) - Upscaled to NTSC at 1080 lines interlaced

Note: Selecting a 50Hz format will automatically cause the TV Type menu item to show PAL. Selecting a 60Hz format will automatically cause the TV Type menu item to show NTSC.

Important! If you select an HDMI resolution that your TV does not support you may lose the picture. In this case you may need to make an analog video connection to your TV to be able to see the picture again and select another resolution in the Setup menu.

Angle Mark

For DVDs recorded with multi-angular scenes, you can change the angle of the screen. There are two modes in the Angle Mark setting: 'On' and 'Off'. When set to 'On', the current playing angle number is displayed in the top right hand corner of the TV screen. When set to 'Off', no angle mark number is displayed on the TV screen.

Note: The angle number differs from disc to disc or from scene to scene.

Press the *Angle* button on the remote to switch between multi-angles.

OSD Language

There are seven language modes to select from: English, Spanish, German, French, Italian, Dutch and Russian.

Screen Saver

If you activate the screen saver function, when the unit is stopped, the disc tray is open or there is no disc or the picture is still for about 60 seconds, a screen saver picture will appear. The purpose of this screen saver is to protect the display screen from damage (screen burn) by a static image. Screen burn can affect Plasma TVs but LCD and CRT TVs are largely immune to it.

Note: The default setting is 'On'.

Audio setup menus

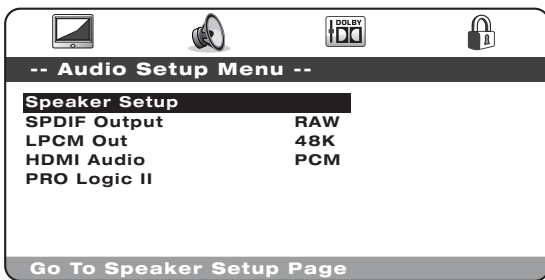

With the Audio setup menu selected, use the **▲** and **▼** arrows to move to the desired sub-menu. Use the *Navigation arrows* (**▲▼◀▶**) to adjust the settings and press the *Enter* button to confirm your selection. See below for the Audio Setup menu structure:

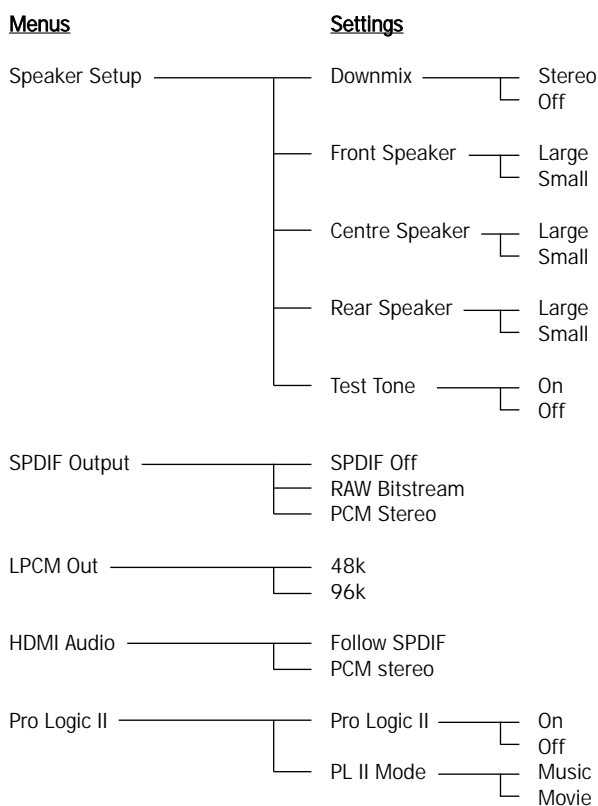

Speaker setup

Downmix

Stereo - When in Stereo mode any DD 5.1 or PLII 5.1 content will be downmixed to Stereo and output from the Front Left and Right sockets of the 5.1 output only.

Off - When Off, full 5.1 output will be available (depending on disc).

Note: The 540D V2 also features a separate set of permanent Stereo Outputs that will always output true Stereo (for Stereo material) or downmixed Stereo from 5.1 regardless of the above setting.

If Downmix is 'On', only the Front Speaker size and Sub On/Off can be selected.

In the next series of menus for each speaker type, select from 'Large' and 'Small' for each speaker ('Large' and 'Small' are used to describe each speaker in terms of bass response and do not necessarily reflect the actual physical size of the speaker).

Large = Speakers with an extended low frequency response of approximately 20-40Hz to 16-20kHz (floorstanders or high quality larger stand-mounted speakers).

Small = Speakers with a less extended low frequency response of approximately 80-100Hz to 16-20kHz (small stand-mounted, bookshelf or satellite speakers).

Setting each speaker allows the 540D V2 to perform what is called Bass Management and to direct low frequency bass from music and the Low Frequency Effects channel of surround sound material away from speakers not able to reproduce it and to the subwoofer channel instead.

Front, Centre and Rear Speakers

These settings allow selection of 'Large' or 'Small' speaker 'size' as described above.

Note: Only the three configurations All speakers Large, Large Fronts / Centre with Small Rears and All speakers Small are supported by the 540D V2.

Test Tone

With the unit in Stop mode, the disc drawer open and Downmix set to 'Off', select 'On' to carry out a test tone procedure. The 540D V2 will then play 'white-noise' sound from each of the 5.1 outputs in turn. They can be used to adjust the levels of your external amplifier/receiver or speaker system so that each channel is at approximately the same level for best surround-sound performance. Listen to each channel in turn as the 540D V2 cycles through them and adjust the level on your amplifier/receiver or speaker system so that each channel sounds the same in terms of loudness (bear in mind smaller speakers and subwoofers etc will sound different in terms of the tone of the sound but the overall level sound be matched).

SPDIF (and TOSlink Optical) Output

Three options are available: **Off, Raw Bitstream and PCM Stereo.**

If PCM Stereo is selected the digital output will always be Digital PCM Stereo (LPCM) for use with a DAC, recording to a MD or CD-R machine etc.

If Raw bitstream is selected the output will either be PCM Stereo for Stereo disc/soundtracks or a surround-sound bitstream from surround-sound soundtracks for decoding by an external AV Receiver, see below:

DISC	SETTING	PCM	Raw
CD		PCM @ 16/44.1	PCM @ 16/44.1
DVD-V		Downmixed PCM @ 16/48 or 16/96*	Raw bitstream for surround sound soundtracks PCM @ 16/48 or 16/96* for stereo soundtracks

* 48kHz or 96kHz depending on soundtrack bit depth and LPCM limit set as below.

LPCM Out

Selects whether the SPDIF LPCM output from DVDs can be at 96kHz maximum sample rate (if the disc supports it) or will be downsampled to 48kHz maximum. Some equipment can only support a 48kHz maximum sample rate and hence it can be useful to set this maximum limit. CDs are 16/44.1 so are unaffected.

Audio Setup menu continued

HDMI Audio

Two options are available PCM Stereo and Follow SPDIF.

When HDMI Audio is set to PCM stereo the HDMI output will be 16/44.1 for CDs and 16/48 or 16/96 stereo/stereo downmix for DVD depending on the soundtrack bit depth.

When the 540D V2 is connected directly to a TV set able to receive Stereo Audio over HDMI PCM Stereo is the best setting to use. Your TV set will now always receive a two channel downmix from CDs or DVDs.

When HDMI Audio is set to Follow SPDIF the HDMI output will exactly follow the SPDIF output as per the previous section and table.

When the 540D V2 is connected to an AV receiver by HDMI there are two possibilities depending whether the receiver accepts HDMI audio directly or switches HDMI video and uses SPDIF for digital audio reception:

1. For AV receivers that can receive HDMI audio set the HDMI Output to Follow SPDIF. Now set the SPDIF Output to RAW/Bitstream. The AV Receiver can now decode the bitstream over HDMI into whichever formats it supports. The TV itself will normally now not receive any audio (unless the receiver has the capability of making a stereo downmix and outputting it over HDMI).
2. For AV receivers that switch HDMI and use SPDIF for audio reception (such as our own Azur 540R V3 and 640R) set the HDMI output to PCM Stereo and SPDIF Output to RAW/Bitstream. The AV receiver now receives and decodes surround-sound via the SPDIF connection. The TV will always also receive a two channel downmix directly from the DVD player over HDMI which can be used if desired.

Pro Logic II

The 540D V2 can decode Stereo soundtracks (that have been suitably encoded) into 5 channel surround-sound using Dolby Pro Logic II. Two modes are available (Music and Movie), optimised for the different Programme types.

To use Pro Logic II first turn it On and then select either Movie or Music mode depending on the programme type.

Note: Enabling Pro Logic II decoding disables Dolby Digital decoding as Pro Logic is used instead as you'd expect.

Dolby Digital Setup menus

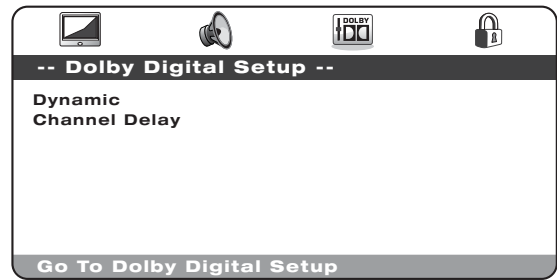

When the Dolby Digital setup menu is selected, use the ▲ and ▼ arrows to move to the desired menu. Use the Navigation arrows (▲▼◀▶) to adjust the settings and press the Enter button to confirm your selection.

Dynamic

Dolby Digital encoded discs allow for the dynamic range (the difference between loud and quiet passages) to be compressed (i.e. for late night listening). The options are:

Full, 7/8, 3/4, 5/8, 1/2, 3/8, 1/4, 1/8, Off

When 'Full' is selected, the peak-to-peak value of the audio signal is compressed by the maximum amount. When 'Off' is selected, no compression is applied.

Channel Delay

For best surround-sound effects it is desirable to adjust the channel delay so that sounds from each speaker arrive at the listener at the same time. This is done by measuring the distance from the listening position to the Left or Right Front speaker (which should be equidistant from the listener), distance from the listening position to the Centre Speaker and similarly to the Right Rear Speaker, Left Rear Speaker and Subwoofer. See diagram below:

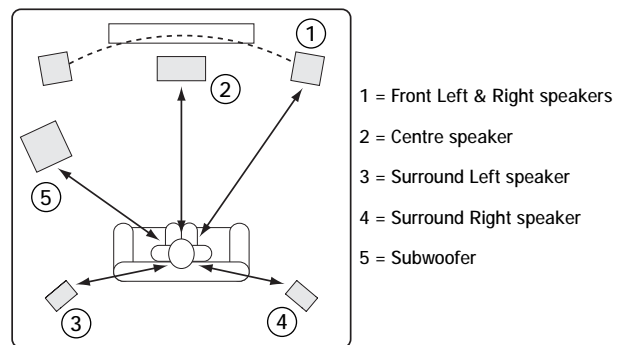

The measurements are not too critical so do not worry if your front speakers are slightly asymmetric or about making very precise measurements (+/- a foot or 30cm or so is fine).

The channel delay to be entered for each speaker is then the difference between the distance to the Front Speakers and the speaker to be configured.

So for instance if the Front Speakers are 5 ½ feet from the listener and the Centre speaker 3 feet from the listener the channel delay to be entered for the Centre Speaker is 2 ½ feet. Similarly if the Right Rear Surround is 3 ½ feet from the listener the channel delay would then be 2 feet.

Note: The distance between the surround speakers and the listener must be shorter than or equal to that between the front speakers and the listener.

The units are feet for units sold in North America / Canada and metres for units sold in Europe / Australasia.

Use ▲▼ to select each speaker in turn and ◀▶ to enter a distance value.

The 540D V2 uses this to calculate and use the correct delay time for each channel so that each channel reaches the listener at the same moment.

Preference menu

Note: To access the Preference menu, the disc tray drawer must be open.

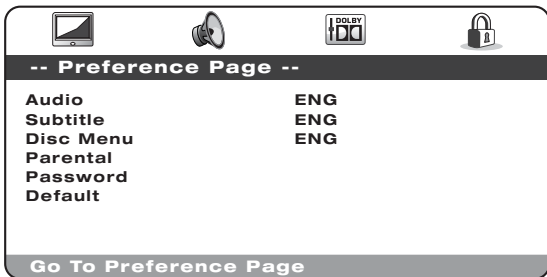

The Preferences menus are used to set the default language tracks the 540D V2 will use for Soundtrack, Subtitles and Disc Menu if they are available on the disc. The 540D V2 will automatically select the appropriate language from those available on the disc where possible.

Also it is possible to restrict the type of disc able to be played back via the Parental control menu item.

When the Preference menu is selected, use the **▲** and **▼** arrows to move to the desired menu. Use the *Navigation arrows* (**▲** **▼** **◀** **▶**) to adjust the settings and press the *Enter* button to confirm your selection. See below for the Preference menu structure:

Menus	Settings
Audio	English French German Spanish Italian Dutch Russian
Subtitle	English French German Spanish Italian Dutch Russian
Disc Menu	English French German Spanish Italian Dutch Russian
Parental	1 KID SAF 2 G 3 PG 4 PG 13 5 PGR 6 R 7 NC 17 8 ADULT
Password	Change
Default	Reset

Audio

Use this to set the default language of the sound output from the speakers.

Subtitle

Use this to set the default language of the subtitles displayed on the TV.

Disc Menu

Use this to set the default language of the menus in the disc top menu.

Parental

Use this to restrict the playback of adult rated DVDs you do not want children to view. Select the rating level you do not want to be accessed and press *Enter*. Discs with this rating and higher will now not be able to be played without a password.

Note: Viewing cannot be restricted unless the restriction level is recorded on the disc. Discs without a restriction level encoded will still be accessible.

Password

Use this to change the password. The unit's default password is 1234.

Default

Select 'Default' and press the *Enter* button to restore the DVD player to its factory default settings.

Note: All settings previously set by the user will be lost!

Basic operating instructions

Getting started

Turn on the power of the TV, amplifier/AV receiver and any other components which are connected to the DVD player. Make sure the TV and the audio receiver are set to the correct input channel.

1. Press the *Open/Close* button to open the disc tray.
2. Place the disc on the tray, label side facing up.
3. Press the *Play/Pause* button. The tray will automatically close and playback will begin.

For CDs playback will begin straight away at track 1. For DVDs, normally the disc will go to the Title Menu which is the main menu recorded on the DVD itself. This is where various disc options will be presented on screen depending on the disc.

DVDs are normally split into one or more Titles, each subdivided into Chapters. Each Title may also have alternative soundtracks and subtitles available. From the Title Menu it is normally possible to start playback of the main film, go directly to different chapters or access special features.

Examples of special features are alternative soundtracks (Stereo or DD 5.1 for instance, perhaps DTS 5.1, also commentaries and different language versions of the soundtrack) and subtitles. Also more than one title may be available (different versions of the film or making-of featurettes for instance). These features are encoded on the disc and the options presented are entirely disc dependant.

Move around the options using the *Navigation arrows* (▲ ▼ ◀ ▶), select the option that starts the film playing in the version you want and press *Enter*.

4. Press the *Stop* button at anytime to stop playback.

Note:

- Do not put anything except a DVD/CD sized disc into the tray, foreign objects may damage the mechanism.
- Do not force the tray by hand during the opening and closing operations.
- To avoid dirt and dust entering the mechanism, keep the disc tray closed when not in use.
- If the disc is seriously scratched or too dirty the player may not be able to read it or play it.
- Never load more than one disc into the disc tray at one time.

Skip playback

1. Press **▶▶** once to skip forward by one track/chapter on the disc. Press and hold to skip forwards through several tracks.
2. Press **◀◀** once to skip backward by one track/chapter on the disc. Press and hold to skip backwards through several tracks.

Go To

Press the *Go To* button on the remote once to access Chapter Selection then enter the required chapter via the numerical buttons. Press twice to access Disc Time Selection and enter the required time from the start of the disc as H:MM:SS (Hours, Minutes, Seconds). Press three times to access Chapter Time Selection and enter the required time from the start of the chapter.

Fast Forward/Rewind search

Press repeatedly to cycle between 2X, 4X, 8X and 16X playback speed (without sound) and back to normal playback. Press **◀◀** button for backwards playback options, or the **▶▶** button for forwards playback.

Slow

When playing a DVD, press repeatedly to cycle round the various speeds of slow motion (1/2, 1/4, 1/8 and 1/16), forwards and backwards and back to normal speed.

Repeat

Note: The Repeat function is available only during playback.

Press the *Repeat* button on the remote to repeatedly play a single chapter/title on a DVD video or a single track/entire disc on a CD.

The first press selects chapter/track repeat, the second press selects title/disc repeat, the third press selects All repeat.

Note: The repeat chapter/title setting will be cleared when moving to other chapter or title.

A-B Repeat

1. Press the *A-B* button at your desired starting point. 'A' appears briefly on the TV screen.
2. Press the *A-B* button at your desired end point. 'A-B' appears briefly on the TV screen, and the repeat sequence begins.
3. To exit the sequence, press the *A-B* button.

Note:

- The A-B repeat section can only be set within the current title (for DVD video) or current track (for DVD audio, Video CD and Audio CD).
- A-B repeat playback is not available with some scenes on DVD.
- A-B repeat playback does not function during title, chapter, track or all repeat playback.

During DVD playback it is also possible to access soundtracks, subtitles and angles (where present on the disc) without having to go back to the Title Menu or stopping playback. Use the following remote control buttons:

Audio

Press to directly access alternate audio soundtracks on the DVD (if available on the DVD disc).

Sub

Press to enable/disable Subtitles (if available on the DVD disc).

Angle

Press to access various camera angles (if available on the DVD disc).

Zoom

Press to cycle through the various zoom magnifications (and back to normal display).

DivX/MP4 playback

If a disc (CD or DVD) with DivX/MP4 files on it is loaded, the 540D V2 will detect these file types and show a special folder navigation screen as below:

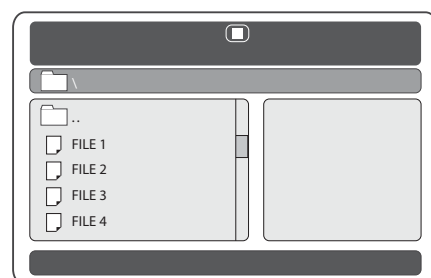

Navigate the folders using the *Navigation arrows* (▲ ▼ ◀ ▶) to highlight the desired movie clip. Press *Play* or *Enter* to start playback of that file.

Note: If there are multiple DivX/MP4 files in one folder you can also select them by using 'Go To' on the remote then pressing the required file number.

Once playing a file you can also use the *Go To* button. Press once for file number entry, press twice to enter a specific time to jump to (as elapsed time since start of that file).

During playback the *Play*, *Pause*, *Stop* and *Forward/Reverse Scan* buttons work as for CD/DVD. *Back* and *Forward Track Skip* select the last/next DivX/MP4 file in folder.

Custom installation (C.I.) use

The 540D V2 features a Control Bus input/output that allow un-modulated remote control commands (positive logic, TTL level) to be received electrically by the unit and looped to another unit if desired. These control commands are typically generated by custom installation (multi-room) systems or remote IR receiver systems. The Control Bus sockets are colour-coded orange.

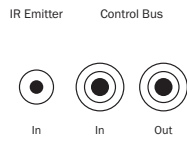

An IR Emitter Input is also provided that allows modulated IR remote control commands to be received electrically by the unit. Commands on this input operate the unit only and are not looped out demodulated on the Control Bus Output. This feature is useful for multi-room systems (such as the Cambridge Audio Incognito multi-room system) which feature routed I.R. emitter outputs. Instead of using window emitters stuck over the CD players front panel IR receiver, a mono 3.5mm mini-jack to 3.5mm mini-jack lead can be used for a more reliable electrical connection.

The 540D V2 also features a 'direct' IR/Control code for On/Off that can be accessed on the supplied remote control for teaching into C.I. systems as follows:

Press and hold the Standby button. The remote first generates it's standby (toggle) command. Keep the button held down, after 12 seconds a DVD player "On" command will be generated. If the button is kept held down for a further 12 seconds, a DVD player "Off" command is generated.

A full code table for this product is available on the Cambridge Audio website at: www.cambridge-audio.com

Technical specifications

Disc types	CD (CD-DA), DVD-V, CD-R/RW, DVD-R/RW, DVD+R/RW, DivX, MP4
DAC architecture	Crystal/Cirrus Logic CS4382 8-channel (5:1 + 2ch Stereo) 24 Bit
Analog audio outputs	<ul style="list-style-type: none"> • Stereo • 5.1 (from DD or PLII)
Analog video outputs	<ul style="list-style-type: none"> • Composite Video (CVBS) • S-Video (SVHS) • RGB/SCART • Component (YCbCr/YPbPr)
HDMI output	Scaling/Deinterlacing to 480p, 576p, 720i/p, 1080i
THD (unweighted)	< 0.002% @ 1kHz < 0.008% @ 20Hz - 20kHz
IMD (19/20kHz) OdBFs	< 0.002%
S/N ratio	< -103dB
Crosstalk @1kHz	< -103dB @ 1kHz
Dynamic Range	> 105dB
Frequency response	5Hz - 20kHz ± 0.2dB
Jitter (correlated)	< 140 psec
Composite Video	1.0V pk-pk (75 ohms)
S-Video	Y: 1.0V pk-pk (75 ohms) C: 0.286V pk-pk (75 ohms)
Component Video	Y: 1.0V pk-pk (75 ohms) Cb/Cr: 0.75V pk-pk (75 ohms) Pb/Pr: 0.75V pk-pk (75 ohms)
Power supply	100-240V AC - 50/60Hz
Max power consumption	25W
Dimensions (H x W x D)	70 x 430 x 310mm
Weight	3.8kg (8.4Lbs)

Troubleshooting

There is no power

- Ensure the AC power cord is connected securely.
- Ensure the plug is fully inserted into the wall socket and is switched on.
- Check fuse in the mains plug or adaptor.

The player will not read the disc

- Check the disc is not loaded upside down.
- Check that the disc is not too scratched or dirty.
- The disc type is unsupported by this unit (e.g. MP3, DVD-A, SACD etc).

There is no sound

- Ensure that the amplifier is set correctly.
- Check that the interconnects are inserted correctly.

The disc is skipping

- Check that the disc is not too scratched or dirty.
- Ensure the player is on a firm surface and not subject to vibrations.

A low hum or buzz sound can be heard

- Power cords or lighting placed near this product.
- Analog inputs not connected securely.

No sound from the rear speakers

- Source being played is not recorded in surround-sound.
- A stereo mode has been selected.

No sound from the centre speaker

- A stereo mode has been selected.

No sound from the subwoofer

- DD PLII mode (which has no LFE channel) has been selected with all speakers set to 'Large'.

Remote control is not working

- The batteries are flat.
- The remote is too far from the unit or out of the effective range.

Cambridge Audio
Gallery Court
Hankey Place
London SE1 4BB
England

www.cambridge-audio.com

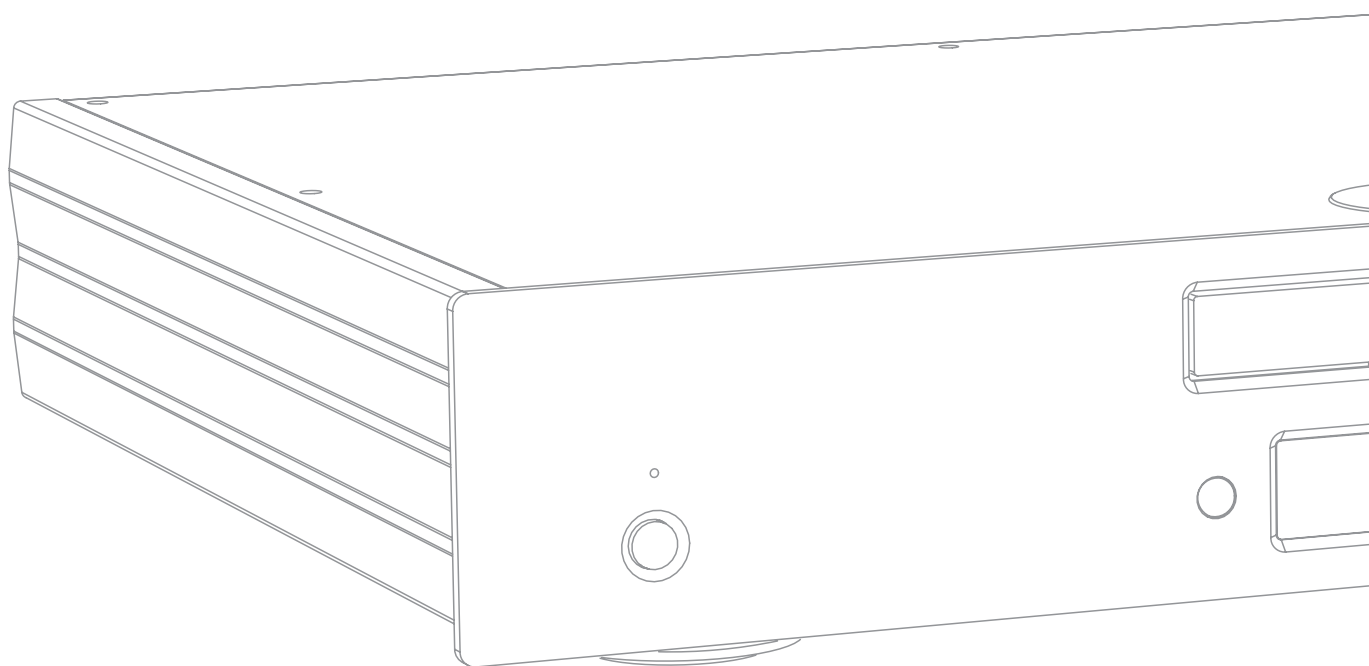

© 2007 Cambridge Audio Ltd

Free Manuals Download Website

<http://myh66.com>

<http://usermanuals.us>

<http://www.somanuals.com>

<http://www.4manuals.cc>

<http://www.manual-lib.com>

<http://www.404manual.com>

<http://www.luxmanual.com>

<http://aubethermostatmanual.com>

Golf course search by state

<http://golfingnear.com>

Email search by domain

<http://emailbydomain.com>

Auto manuals search

<http://auto.somanuals.com>

TV manuals search

<http://tv.somanuals.com>