

Date: 8-4-2010
Revision: 0
Form: 2396



Bryan Steam LLC
Installation and Operating Service Manual

Triple-Flex

High Efficiency Boilers

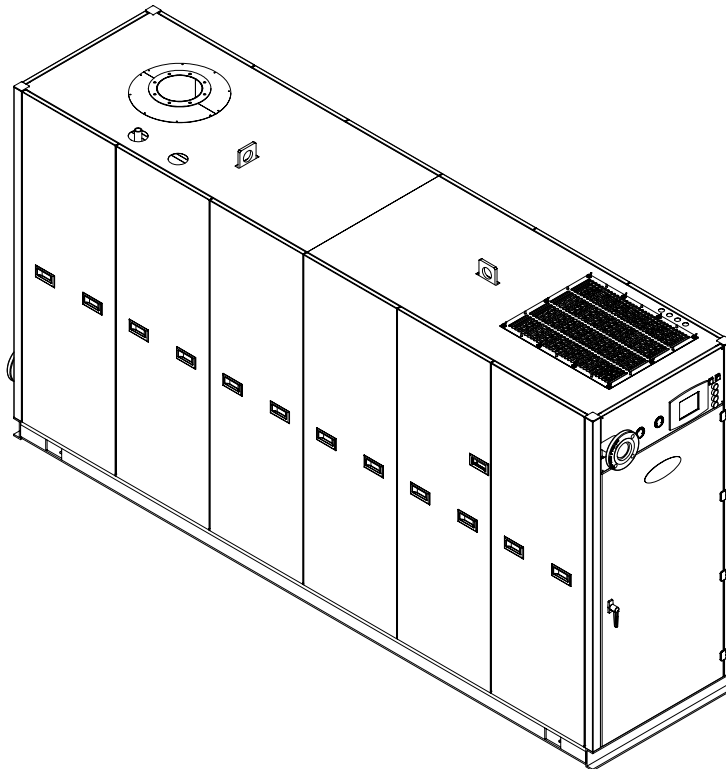

Date: 8-4-2010
Revision: 0
Form: 2396

INSTALLATION AND OPERATION SERVICE MANUAL
Triple-Flex 150, 200, 250, & 300
High Efficiency Boilers

Bryan Steam LLC
783 North Chili Avenue * Peru, IN 46970
Phone 765.473.6651 • Fax 765.473.3074

E-mail: inquiry@bryansteam.com Internet: www.bryanboilers.com

Table of Contents

Bryan Steam LLC	i
Installation and Operating Service Manual.....	i
Table of Contents	iii
Tables	v
Figures.....	v
Section 1 Installation Instructions– Triple-Flex High Efficiency Boilers	1
1.1 Boiler Foundation.....	2
1.2 Clearances.....	2
1.2.1 Minimum Clearances to Combustible Surfaces.....	2
1.3 Receiving The Boiler.....	2
1.4 Boiler Connections.....	3
1.4.1 Flow Connection	3
1.4.2 Safety Relief Valves.....	3
1.4.3 Expansion Tank Connections	3
1.4.4 Drain Connection	3
1.4.5 Condensate Drain Connection.....	3
1.4.6 Gas Supply Connection	3
1.4.7 Drip Leg.....	3
1.4.8 Gas Piping Leak Test.....	3
1.4.9 Venting Of Gas Train Components.....	4
1.5 Electrical Requirements	4
1.6 Combustion Air Supply	4
1.6.1 Combustion Air Openings:	5
1.6.2 Louvers, Grilles, and Screens.....	5
1.7 Flue Gas Venting System	6
1.7.1 Design & Installation	6
1.7.2 Combustion Air and Venting Requirements for Canada.....	7
1.7.3 Marking Of Gas Vents.....	8
1.8 Before Placing Boiler In Operation	8
1.8.1 Hydrostatic Test Of Boilers And System.....	9
1.8.2 Test Of Gas Piping.....	9
Section 2 Start-Up and Operation Triple-Flex High Efficiency Boilers	10
2.1 Boiler Assembly	11
2.1.1 Triple-Flex Front View	11
2.1.2 Triple-Flex Rear View	12
2.1.3 Triple-Flex Left Side View	13
2.1.4 Triple-Flex Right Side View.....	13
2.1.5 Triple-Flex Behind the Cabinet Door.....	13
2.1.6 Pilot Spark Igniter Assembly	15
2.1.7 Triple-Flex Left Flue Collector View	15
2.1.8 Triple-Flex Right Flue Collector View.....	16
2.2 SOLA Hydronic Control System	16
2.2.1 Power-up Validation	16
2.2.2 Home Page	16
2.2.3 Page Navigation.....	17
2.2.4 Keyboard.....	17
2.2.5 Status Page.....	18
2.2.6 Configuration Page	18
2.2.7 Configuration Password.....	19
2.2.8 Change Parameter Settings.....	20
2.2.9 Safety Verification	20
2.2.10 Fault/Alarm Handling	21

2.2.11 Operation Page	22
2.2.12 Annunciation Page	23
2.2.13 Modulation Configuration	23
2.2.14 Firing Rate Control Page	23
2.2.15 Advanced Setup	24
2.2.16 System Time	24
2.2.17 Calibrate Touch Screen	24
2.2.18 Reset / Reboot Display	25
2.2.19 Outdoor Reset	25
2.2.20 Remote Setpoint (4 – 20 mA)	26
2.2.21 Central Heat Configuration	27
2.2.22 Sound Pressure Levels	27
2.2.23 Modbus Communication	29
2.2.24 Alert Codes	29
2.3 Boiler Commissioning	35
2.3.1 Modulation	35
2.3.2 Test Setup	35
2.3.3 Pre Checks And Setup	35
2.3.4 Dry Run	36
2.3.5 Pilot Adjustment	36
2.3.6 Initial Light Off	37
2.3.7 Adjusting Boiler Maximum Input	37
2.3.8 Adjusting Boiler Minimum Input	37
2.3.9 Gas Meter Readings	38
2.4 Troubleshooting	39
Section 3 Care and Maintenance	50
3.1 Cleaning The Boiler And System – New Systems	51
3.1.1 Pre-Boil Out Flushing Of System	51
3.1.2 Boil Out Procedure	51
3.1.3 Draining The System	52
3.2 Replacement Boiler Installations: Protection Against Corrosion And Sediment	52
3.3 Boiler Water Treatment	52
3.4 External “Fire-Side” Cleaning	53
3.5 Suggested Maintenance Schedule	53
Section 4 Lead Lag	55
4.1 General Description Of The Lead Lag Application	56
4.2 Lead Lag (LI) Master General Operation	56
4.3 System Wiring Hookup	58
4.4 Lead-Lag Operation	59
4.5 Slave Operation And Setup	60
4.6 Slave Parameters	60
4.7 LI Master Operation And Setup	61
4.7.1 Overall Control	61
4.7.2 Periodic Data Polling messages	62
4.7.3 Slave Status Manager	62
4.7.4 Master Active Service	65
4.7.5 Modulation Sensor	65
4.7.6 Demand and Rate	66
4.7.7 Rate Adjustment	67
4.7.8 Implementation	67
4.7.9 Rate Allocation	68
4.7.10 Burner Demand	70
4.7.11 Lead Drop-Stage On Error - LDSE:	73

Tables

Table 1 Minimum Clearance.....	2
Table 2 Electrical Requirements.....	4
Table 3 Boiler Draft.....	7
Table 4 Water Flow Switch Settings.....	14
Table 5 Gas Limiting Orifice Rough Settings	15
Table 6 Sound Pressure Readings.....	28
Table 7 Modbus Terminals	29
Table 8 Alert Codes	29
Table 9 Approximate Boiler Settings	38
Table 10 Gas Pressure Correction.....	38
Table 11 Gas Temperature Correction.....	38
Table 12 R7910A Lockout and Hold Codes	39

Figures

Figure 1 Minimum Clearances.....	2
Figure 2 Main Gas Inlet Connection	4
Figure 3 Triple-Flex Front View	11
Figure 4 Triple-Flex Rear View.....	12
Figure 5 Triple-Flex Left Side View	13
Figure 6 Triple-Flex Right Side View	13
Figure 7 Triple-Flex Behind the Cabinet Door.....	13
Figure 8 Air Flow Switch.....	14
Figure 9 Pilot Spark Igniter Assembly	15
Figure 10 Triple-Flex Left Flue Collector View	15
Figure 11 Triple-Flex Right Flue Collector View.....	16
Figure 12 Home Page	16
Figure 13 Keyboard	17
Figure 14 Status Page.....	18
Figure 15 Configuration Menu Page.....	18
Figure 16 Sample Configuration Page	19
Figure 17 Change Parameter Dialog.....	20
Figure 18 Safety Parameter Verification	20
Figure 19 Safety Parameter User Confirmation	21
Figure 20 Safety Parameter Reset.....	21
Figure 21 Home Page Lockout.....	22
Figure 22 Status Page Lockout.....	22
Figure 23 History Dialog.....	22
Figure 24 Lockout History Page	22
Figure 25 Operation Page	22
Figure 26 Annunciation Page	23
Figure 27 Modulation Configuration	23
Figure 28 Firing Rate Control Page.....	23
Figure 29 Advanced Setup	24
Figure 30 System Time	24
Figure 31 Display Diagnostics	24
Figure 32 Reset / Reboot Display.....	25
Figure 33 Outdoor Reset.....	25
Figure 34 Outdoor Reset Curve	26

Date: 8-4-2010
Revision: 0
Form: 2396

Figure 35 Outdoor Reset Sensor Configuration 26
Figure 36 Air / Gas Ratio Tappings 35
Figure 37 LL / Multi-Boiler Field Wiring 58

Date: 8-4-2010
Revision: 0
Form: 2396

Section 1 Installation Instructions– Triple-Flex High Efficiency Boilers

Note:

Please read and save for future reference the entire instruction manual before attempting installation of or starting the unit. Insurance and local or state regulatory codes may contain additional or more stringent requirements than those contained in this manual. Installation must conform to these codes and any other authority having jurisdiction. This instruction manual shall be posted and maintained in a legible condition.

1.1 BOILER FOUNDATION

Before uncrating, the boiler location should be prepared. The boiler should set upon a good level concrete floor. If the boiler is not level or the floor is not in good condition, a concrete foundation should be built, the dimensions being larger than the outside dimensions of the boiler base. A 4" high housekeeping pad is suggested.



WARNING:

Do not install boiler on combustible flooring.

1.2 CLEARANCES

See Table 1 for minimum clearances to walls, ceilings, or obstructions. The clearances in Table 1 are intended as a general recommendation only. Local codes must be applied to specific installations and the minimum clearances established accordingly. Provisions must also be made for service, accessibility and clearance for piping and electrical connections. Do not obstruct combustion air and ventilation openings with piping or any other construction. All boilers must be installed in a space that is large compared to the boiler.

NOTE:

These boilers should be installed in a room that is large compared to the size of the boiler. They are not intended for alcove installation and are suitable for installation on non-combustible flooring only. Adhere to all applicable local codes regarding boiler installation and clearances.

1.2.1 MINIMUM CLEARANCES TO COMBUSTIBLE SURFACES

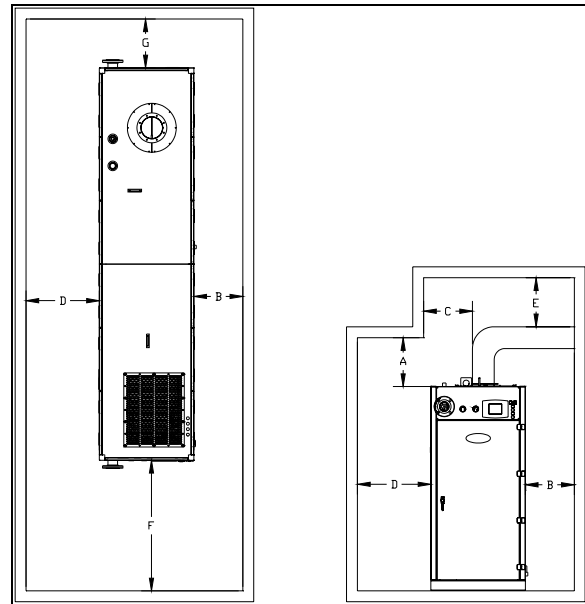

Figure 1 Minimum Clearances

DIM.	Description	Triple-Flex 150 - 300
A	Clearance Above Top of Boiler	18"
B	Right Side	18"
C	From Chimney or Vent Collector Measured Horizontally	18"
D	Left Side – Tube Access Side On Standard Construction	27"
E	From Chimney or Vent Collector Measured Vertically	18"
F	Front of Boiler – Gas Train & Control Panel End	48"
G	Rear of Boiler Opposite Gas Train & Control Panel End	18"

Table 1 Minimum Clearance

1.3 RECEIVING THE BOILER

The boiler is shipped from the factory with (4) shipping feet/legs bolted to the skids. These are provided to facilitate unloading/moving with a forklift. Lifting lugs are also provided to enable over-head lifting. The shipping feet/legs MUST

BE REMOVED after the boiler is set in-place on its concrete foundation before any piping/electrical connections are made. It is recommended that the plastic protective cover be left on as long as possible to reduce finish damage from the installation.

1.4 BOILER CONNECTIONS

Do not run any pipes along the tube access panel side of the boiler. Maintain clearances as shown on the dimensional drawing for servicing of the boiler tubes. Provide at least 48" from the front of the boiler, unless a larger dimension is indicated on the dimensional. All piping should be designed and installed to avoid any loadings on the boiler connections or piping.

1.4.1 FLOW CONNECTION

The system supply and return flow connections are shown on Figure 3 and Figure 4 respectively. A gate valve should be installed on the boiler outlet and inlet lines. This allows the boiler to be isolated from the heating system for draining and servicing.

1.4.2 SAFETY RELIEF VALVES

Safety relief valve(s) are shipped loose. Connections are provided in the top of the boiler for the safety relief valve(s). The safety relief valve discharge piping must be the same size as the safety relief valve discharge opening and run to a point of safe discharge. Avoid over-tightening as this can distort valve seats. All piping from the safety relief valve(s) must be independently supported with no weight carried by the valve.

1.4.3 EXPANSION TANK CONNECTIONS

Connection(s) to an expansion tank are to be provided by others in the system piping separate from the boiler.

1.4.4 DRAIN CONNECTION

A drain valve must be installed on the boiler drain connection, the same pipe size as this connection, to allow draining of the boiler.

1.4.5 CONDENSATE DRAIN CONNECTION

A 1" MPT connection is provided to drain the condensed products of combustion from a trap located beneath the boiler. This must be run to a drain using stainless steel or PVC piping. The condensate temperature should never exceed 212° F and the pH of the condensate should never be greater than 3.5. NO VALVE is to be installed in this line from the boiler to point of discharge.

1.4.6 GAS SUPPLY CONNECTION

The installation must conform completely to the requirements of the authority having jurisdiction, or in the absence of such, requirements shall conform in the U.S. to the current National Fuel Gas Code, ANSI Z223.1-1984, or in Canada to the current Natural gas and propane installation code (CAN/CSA B149.1-05), and applicable regional regulations for the class; which should be followed carefully in all cases. Authorities having jurisdiction should be consulted before installations are made.

1.4.7 DRIP LEG

A drip leg, or sediment trap, must be installed in the gas supply line. See Fig. 1.5A. The gas line must be connected to a supply main at least as large as the gas train connection at the boiler. This connection should be made with a union so that the boiler gas train components and burner may be easily removed for service.

1.4.8 GAS PIPING LEAK TEST

Leaks shall be checked using a soap and water solution.

After completion of the gas-piping hookup, the installation must be checked for leaks. All joints up to the main motorized gas valve shall be checked. A pressure gauge shall be installed down stream of the main motorized gas valve and up stream of the manual gas shutoff valve in the closed position to ensure the main motorized valves are not leaking by. During commissioning, the remainder of the gas train joints down stream of the main motorized gas

valve shall be tested for leaks.

1.4.9 VENTING OF GAS TRAIN COMPONENTS

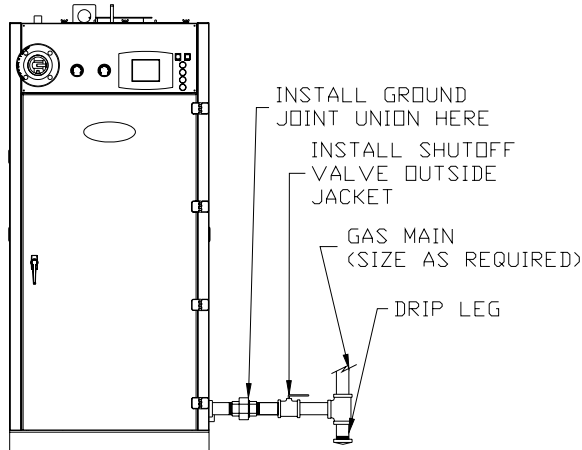

Figure 2 Main Gas Inlet Connection

Normally open vent valves (when supplied) - These valves must be piped to outdoors using pipe no smaller than that of the valve.

Gas pressure switches - All gas pressure switches provided are of the VENTLESS type and do not require venting to atmosphere.

Gas pilot pressure regulator - A vent limiter for the pilot pressure regulator is provided eliminating the need to run a vent line to atmosphere.

NOTE:

Do not use Teflon tape for threaded joints in gas piping.

1.5 ELECTRICAL REQUIREMENTS



WARNING:

All electrical connections must conform to the National Electrical Code and to all other applicable State and Local Codes. See boiler wiring diagram and equipment list for specific voltage requirements.

Model	TF300/250	TF200/150
200 V – 240 V / 60 Hz / 3 Ph		
Blower Motor KW (HP)	3 (4.02)	N/A
Full Load Amps ¹	15.6	N/A
Service Fuse	(3) 20 Amp	N/A
400 V – 480V / 60 Hz / 3 Ph		
Blower Motor KW (HP)	N/A	N/A
Full Load Amps ¹	N/A	N/A
Service Fuse	N/A	N/A
200 V – 240 V / 60 Hz / 1 Ph		
Blower Motor KW (HP)	N/A	1.05 (1.41)
Full Load Amps ¹	N/A	6
Service Fuse	N/A	(2) 7 Amp

Table 2 Electrical Requirements

Equipment Grounding

The boiler must be grounded in accordance with the current American National Standard Electrical Code, ANSI/NFPA #70.

1.6 COMBUSTION AIR SUPPLY

Combustion Air:

For proper combustion it is necessary to provide the boiler room with appropriate openings for fresh air supply. Temporary air intakes such as windows and doors should be avoided since they may be closed. In addition to air needed for combustion, sufficient air must be supplied for ventilation as well as other air consuming equipment that may be present in the boiler room. Often when personnel are working in the boiler room, combustion air openings are closed due to the temperature of the outside air. THIS MUST BE AVOIDED AT ALL COSTS! Provisions should be made to heat the outside combustion air, if necessary, for personnel comfort.

Positive means for supplying an ample amount of outside air, allowing for the complete combustion of the gas, must be provided.

Movable combustion air dampers, automatic or manually adjustable, must be electrically

¹ Full load Amps include blower and control circuit.

interlocked with the boiler to prevent boiler operation if the dampers are closed.

Combustion air openings must never be blocked or obstructed in any manner.

The boiler room must be at a positive or neutral pressure relative to the outdoors. A negative in the boiler room will result in downdraft problems and incomplete combustion due to the lack of air.



WARNING!

Failure to provide an adequate air supply will result in boiler damage and hazardous conditions in the building (fire and asphyxiation hazard as well as equipment damage).

1.6.1 COMBUSTION AIR OPENINGS:

The design of combustion air openings MUST comply with local and/or State codes or the authority having jurisdiction. As a minimum, combustion air openings to the boiler room shall be provided as follows:

Note:

Combustion air provided solely from an indoor source is discouraged. No dimension for a round or rectangular opening shall be less than 3".

Two Permanent Opening Method

One opening starting within 12" of the top of the boiler room and one starting within 12" of the bottom of the boiler room shall be provided. The openings shall be open directly to the outside or ducted directly to the outside.

When directly open to the outside or ducted to the outside by **vertical** ducts, each opening or duct shall have a minimum free open area of 1 in² per 4000 BTU total input rating of the boiler(s) in the room.

If ducted to the outside through **horizontal** ducts, each opening or duct shall have a minimum free area of 1 in² per 2000 BTU total input rating of the boiler(s) in the room.

One Permanent Opening Method

One opening commencing within 12" of the top of the room shall be provided. The opening shall be directly to the outside or shall be ducted to the outside with a horizontal or vertical duct.

The opening or duct shall have a minimum free area of:

1 in² / 3000 BTU /hour of the total input rating of all appliances (boilers) in the room.

Not less than the sum of the areas of all **vent connectors** in the room. A "vent connector" is defined as the pipe or duct that connects a fuel burning appliance to a vent or chimney.

Additional area must be provided for other air consuming equipment in the room.

Mechanical Air Supply Systems

The combustion air supply may be provided by a mechanical air supply system. If utilized, the combustion air must be provided from the outside at a minimum rate of 0.35 ft³/min. for every 1000 Btu/hr. input for all appliances located in the space.

If exhaust fans are utilized, additional air shall be provided to replace the exhausted air.

Each boiler and other appliance must be interlocked to prevent operation when the mechanical air supply system is not in operation.

If the combustion air is provided by a buildings mechanical ventilation system, the system shall be sized to provide the specified combustion air in addition to the ventilation air requirements.

1.6.2 LOUVERS, GRILLES, AND SCREENS

Louvers and Grilles:

The required size of openings for combustion, ventilation, and dilution air shall be based on the net free area of each opening. Where the free area through a design of louver, grille, or screen is known, it shall be used in calculating the size opening required to provide the free area

specified. Where the louver and grille design and free area are not known, it shall be assumed that wood louvers have a 25 percent free area, and metal louvers and grilles have 75 percent free area. Non-motorized louvers and grilles shall be fixed in the open position.

Screens

Minimum Screen Mesh Size:
Screens shall not be smaller than 1/4 " mesh.

Motorized Louvers:

Motorized louvers shall be interlocked with the appliance so they are proven in the full open position prior to main burner ignition and during main burner operation. Means shall be provided to prevent the main burner from igniting should the louver fail to opening during burner startup and to shut down the main burner if the louver close during burner operation.

Combustion Air Ducts

Combustion air ducts shall comply with the following:

Ducts shall be constructed of galvanized steel or a material having equivalent corrosion resistance, strength and rigidity.

Ducts shall terminate in an unobstructed space, allowing free movement of combustion air to the appliances.

Ducts shall serve a single space.

Ducts shall not serve both upper and lower combustion air openings where both such openings are used. The separation between ducts serving the upper and lower combustion air openings shall be maintained to the source of combustion air.

Ducts shall not be screened where terminating in an attic space.

Horizontal upper combustion air ducts shall not slope downward toward the source of combustion air.

For informational purposes, there are several codes that address the amount of air and/or size of the opening(s) in walls for combustion air.

NFPA 54, National Fuel Gas Code (ANSI Z223.1)

ASME CSD-1, Controls and Safety Devices for Automatically Fired Boilers

ASME Section VI, Recommended Rules for Care and Operation of Heating Boilers

BOCA, National Mechanical Code



WARNING:

Do not locate air intakes where petroleum distillates, CFC's, detergents, volatile vapors or any other chemicals are present. Severe boiler corrosion and failure will result.

1.7 FLUE GAS VENTING SYSTEM

Triple-Flex boilers are Category IV appliances that vent with a positive exhaust vent pressure and with a temperature that is likely to cause condensation. Any venting system used with the Triple-Flex boiler must comply with the requirements for Special Gas Vents per UL Category Code (CCN) DGSH, which are UL Listed per UL 1738 or UL Category Code DGSH7, which are cUL Listed (Canada) per UL 1738.



WARNING:

The Triple-Flex boiler is NOT certified for use with other types of venting excepting Special Gas Vents. Use of any other types of venting may cause vent failure resulting in serious injury or death.

1.7.1 DESIGN & INSTALLATION

A qualified venting professional experienced in venting system designs should design the boiler vent system. The vent size must be NO LESS THAN 8" IN DIAMETER and sized such that the pressure drop between the boiler and the point of discharge does not exceed 0.20" WC. While the vent must be UL Listed Special Gas Vent per Category Code DGSH or DGSH7 for Canada, Bryan Steam, LLC recommends the use of venting components fabricated from AL29-4C® material. The vent installation must be in strict compliance with the vent manufacturers requirements. Clearances to combustible materials and supporting requirements, per the vent manufacturers installation instructions, must be maintained.

Horizontal sections of the flue vent system must be pitched back towards the boiler at ¼ inch per foot to avoid condensate pooling and allow for proper drainage. Venting may be horizontal, through the wall installation or vertical, through the roof installation. The vent system, including terminus, must be sized in accordance with the flue gas flow(s) and pressure drop(s) per Table 3.

Note:

An existing masonry chimney may be utilized PROVIDING that the existing chimney is lined with Special Gas Vent material(s), primarily AL29-4C®. There are venting manufacturers that have these products available.

1.7.2 COMBUSTION AIR AND VENTING REQUIREMENTS FOR CANADA

Canadian Standard CAN/CSA-B149.1-05, Natural gas and propane installation code specifies venting systems and air supply for appliances in Section 8. Paragraph 8.1.4 states "Air supply shall be provided in accordance with Clause 8.4 when either an appliance or a combination of appliances has a total input exceeding 400,000 Btuh". Air supply is defined as combustion air, excess air, flue gas dilution air, primary air, secondary air, and ventilation air. The air supply requirements below are a summation of Clause 8.4 specific to the Triple-Flex boiler.

Boiler Model	Flue Gas Flow, ACFM @40% X SA 200°F	Comb Air Req. SCFM @40% XS A60°F	Permissible ΔP Thru Venting
TF-150	452	330	0.2" WC (Max)
TF-200	603	441	0.2" WC (Max)
TF-250	753	550	0.2" WC (Max)
TF-300	904	661	0.2" WC (Max)

Table 3 Boiler Draft

Note:

NFPA 54-2009 (ANSI Z223.1-2009) paragraph 12.7.3.3 states, "The sizing of gas vents for Category II, Category III, and Category IV Appliances shall be in accordance with the appliance manufacturers instructions."

Air Supply Requirements per CAN/CSA-B149.1-05 for Appliances having an input exceeding 400 MBH.

Ventilation Air: an opening for ventilation air at the highest point that opens to the outdoors shall provide Ventilation of the space. The cross sectional area of this opening shall be at least 10% of the area required for combustion air, but in no case shall the cross-sectional area be less than 10 in² (6500mm²).

Combustion Air: For combustion air where the air supply is provided by natural airflow from outdoors, in addition to the opening for ventilation air, there shall be permanent opening having a total cross-sectional free area of not less than 1 in² for each 30,000 BTU/hr. (70 mm² for each kW) of the total rated input of the boiler(s). The location of the opening(s) shall not interfere with the openings for ventilation air. Please refer to CAN/CSA-B149.1-05, Para. 8.4.4, for combustion air openings if there are natural draft, fan assisted or power draft assisted equipment in the space.

When an air supply duct is used to supply combustion air, it's discharge opening shall be located where there is no possibility of cold air affecting steam or water lines or other temperature sensitive equipment.



WARNING:

Do not use a barometric damper with this boiler. This is a positive pressure system. The use of a barometric damper may cause flue gases to leak into the boiler room.

The boiler vent must not be connected to any portion of another vent system without consulting the vent manufacturer. The boiler shall not be connected to any part of a vent system serving a Category I or Category II appliance, nor shall a Category I or Category II appliance be connected to the vent system serving this boiler. Improper connection of venting systems may result in leakage of flue gases into building spaces.

Combustion Air Supply Dampers, Louvers, and Grilles

The free area of the combustion air supply opening shall be calculated by subtracting the blockage area of all fixed louvers, grilles or screens from the gross area of the opening. Openings in a fixed louver, grille, or screen shall have no dimension smaller than 1/4" (6 mm). No manually operated damper or manually operated adjustable louvers are permitted. A motorized damper or louvers shall be interlocked so the burner(s) cannot operate unless the damper or louver is in the fully open position.

Mechanical Combustion Air Supply

When combustion air is supplied by mechanical means, an airflow sensing device shall be installed and wired into the safety limit circuit of the primary safety control to shut off the gas in the event of an air supply failure.

Appliance Venting per CAN/CSA-B149.1-05

Paragraph 8.9 of CAN/CSA-B149.1-05 addresses "Appliance Venting". Paragraphs 8.9 through 8.31 address many facets of flue gas vents, many of which do not apply to the Triple-Flex boiler, which is a Category IV listed appliance requiring the use of special venting systems as previously described.

NOTE:

Please note that the information provided in this manual relative to the Canadian Standard is not meant to be all-inclusive. Reading the entire Standard is strongly suggested. The final approval of all system designs must be acceptable to the authority having jurisdiction.

- Venting for Category IV appliances shall be as specified or furnished by the manufacturer of the listed appliance. The Triple-Flex boiler is a Category IV appliance requiring the use of special vent that is certified.
- A special venting system shall be installed in accordance with the terms of its listing and the vent manufacturers certified installation manual.
- A flue gas vent or a vent connector shall not be installed in either a duct or a

shaft used for return air, hot air, ventilating air, or combustion air.

- An appliance that operates at a positive vent pressure shall not be connected to a venting system serving any other appliance. The Triple-Flex boiler operates at a positive vent pressure.
- A factory-built chimney used for venting an appliance shall be certified.

Vent Sizing

- A vent or chimney serving a single appliance shall provide effective venting and shall be sized so that its effective area is not less than that of the flue outlet diameter of the boiler and in accordance with engineering venting tables acceptable to the authority having jurisdiction.
- A vent or chimney serving more than one appliance shall provide effective venting and shall be sized in accordance with good engineering practice, such as by the use of engineering venting tables acceptable to the authority having jurisdiction.

1.7.3 MARKING OF GAS VENTS

Where solid and liquid fuels are used, gas vents, must be plainly and permanently identified by a label. The label should read, "This gas vent is for appliances that burn gas only. Do not connect to incinerators or solid or liquid fuel burning appliances."

This label must be attached to the wall or ceiling at a point near where the gas vent connector enters the wall, ceiling or chimney.

The authority having jurisdiction must determine whether their area constitutes such a locality.

Solid Fuel Appliance Vents

Gas appliances shall not be vented to a vent or a chimney that serves a solid-fuel burning appliance.

1.8 BEFORE PLACING BOILER IN OPERATION

1.8.1 HYDROSTATIC TEST OF BOILERS AND SYSTEM

After completing the boiler and burner installation, the boiler connections, fittings, attachments and adjacent piping must be inspected for leaks by filling the unit with water. The pressure should be gradually increased to a pressure just below the setting of boiler safety relief valve(s).

Remove the boiler tube access panels (see dimensional drawing in the boiler manual). Inspect the tube to header joints to be certain that all tube fittings are sealed. This is necessary because, although the boiler is hydrostatically tested at the factory, minor leaks in fittings and at attachments can develop from shipping vibration or from installation procedures. It is often necessary to retighten such fittings after installation and after the boiler has been operated for some time. Replace tube access panels before proceeding to start boiler.

1.8.2 TEST OF GAS PIPING

Reference the gas system test under paragraph Gas Supply Connection, in this manual.

Date: 8-4-2010
Revision: 0
Form: 2396

Section 2 Start-Up and Operation Triple-Flex High Efficiency Boilers



WARNING:

Improper servicing and start-up of this equipment may create a potential hazard to equipment, operators, or persons in the building.

Only fully trained and qualified personnel should do servicing and start-up.



WARNING:

Before disconnecting or opening any fuel line, cleaning or replacing parts of any kind take the following precautions.

Turn OFF the main fuel shutoff valves, including the pilot gas cock if applicable.

Turn OFF all of the electrical disconnects to the burner, boiler and any other equipment or systems electrically interlocked with the burner or boiler.

All cover plates, enclosures, and guards must be in place at all times except during maintenance and servicing.

2.1 BOILER ASSEMBLY

The Triple-Flex boiler is a fully integrated assembly consisting of a Metal Fiber Pre-Mix Burner Head and the necessary fittings, valves, and safety devices. The boiler equipment list provided in the boiler manual lists the components supplied for the boiler assembly. Refer to the boiler dimensional for location dimensions. A description of the major components follows. For additional information refer to the manufactures literature provided in the boiler manual.

2.1.1 TRIPLE-FLEX FRONT VIEW

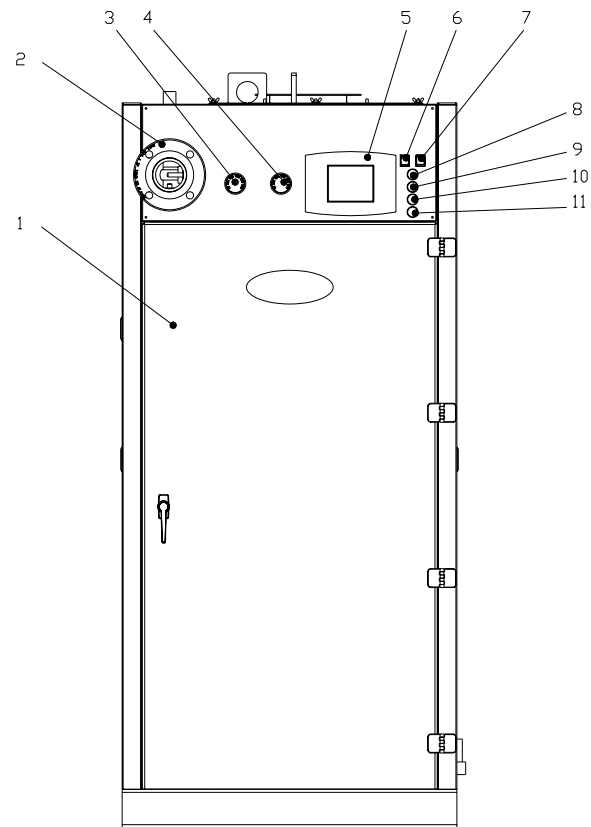

Figure 3 Triple-Flex Front View

1. The boiler cabinet door provides easy access to boiler and burner components. This door should remain closed during normal operation to ensure proper flow of air around the boiler flue collector.
2. The boiler supply water connection provides heated water to the system. This connection is a standard ANSI 150# class 3" flange.
3. The boiler water pressure gauge is 2" diameter and will have a range not less than 1-1/2 nor more than 3-1/2 times the pressure setting of the boiler safety relief valve.
4. The boiler water temperature gauge is 2" diameter and is located so that it will indicate the boiler water temperature at the supply water connection of the boiler.
5. The boiler touch panel display provides a human interface for controlling the boiler. Controlling the boiler with the touch panel display will be explained in section 2.2.
6. The boiler on / off switch will turn on or off the 120 volt ac control voltage for every electrically connected device. This includes

the touch panel display. There is a soft switch (paragraph 2.2.11) provided with the SOLA hydronic control that will put the boiler into standby for an indefinite period of time.



WARNING:

The boiler on / off switch will not turn off the 3 phase high voltage power to the motor.

7. The boiler lockout reset button is a push button used to reset the hydronic control after a boiler failure.
8. The power on light will be white in color and indicates that there is 120 volts ac being supplied to electrically connected devices.
9. The enabled light will be green in color and indicates that the boiler is enabled. Enabled is a state in which the boiler is allowed to operate within the boiler's predefined parameters.
10. The fuel on light will be amber in color and indicates that the boiler is firing and producing heated water.
11. The boiler lockout light will be red in color and indicates that the boiler has failed. The SOLA control will have additional information displayed on the touch panel display. These failures will be explained in section 2.3.9.

2.1.2 TRIPLE-FLEX REAR VIEW

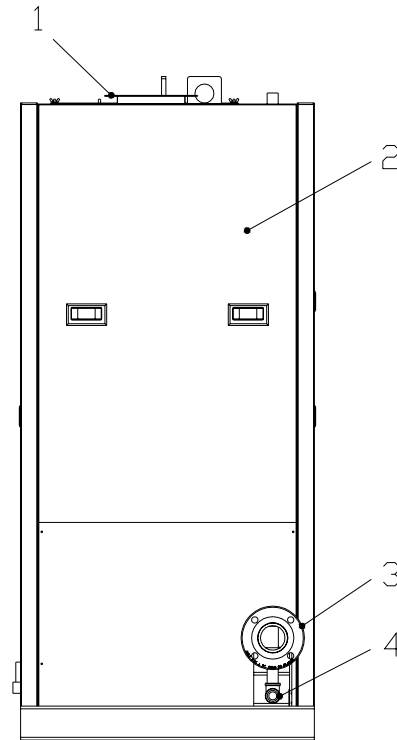

Figure 4 Triple-Flex Rear View

1. The flue gas vent is 8" diameter and exhausts products of combustion. Refer to section 1.7 for installation details.
2. The rear jacket access panel provides access to the combustion air blower for servicing.
3. The boiler return water connection receives cooled water from the system. This connection is a standard ANSI 150# class 3" flange.
4. The drain connection is 1" NPT and provides a means for draining water from the boiler. For installation details refer to paragraph 1.4.4.

2.1.3 TRIPLE-FLEX LEFT SIDE VIEW

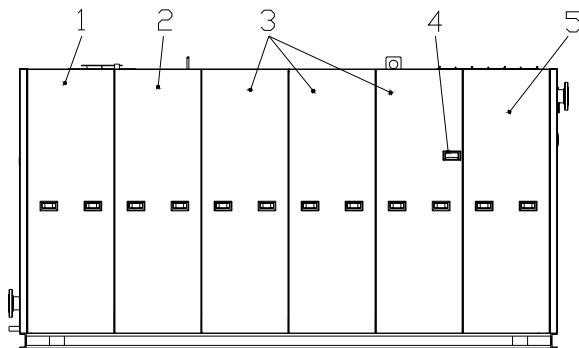

Figure 5 Triple-Flex Left Side View

1. This jacket access panel will permit access to the primary air-to-air exchanger.
2. This jacket access panel will permit access to the primary air-to-air exchanger and the boiler convection tube access panels.
3. These jacket access panels will permit access to the convection and furnace tube access.
4. Flame observation port. This port provides visual access to observe the pilot and main flame during operation and service.
5. This jacket access panel will permit access to the majority of the boiler devices.

! WARNING:

The flame observation port will become very hot during normal operation. Burn injuries can occur if come in contact with the skin.

2.1.4 TRIPLE-FLEX RIGHT SIDE VIEW

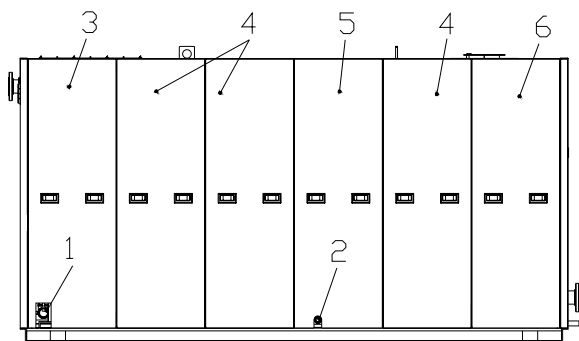

Figure 6 Triple-Flex Right Side View

1. Main gas inlet connection. This connection is a 2" male national pipe thread.
2. Condensate Drain Connection. This connection is a 1" male national pipe thread. For installation details refer to paragraph 1.4.5.
3. This jacket access panel will permit access to the majority of the boiler devices.
4. These jacket access panels will permit access to the flue collector. There is no practical reason for the removal of these panels.
5. This jacket access panel will permit access to the condensate trap. The condensate trap is provided with a 1/2" NPT plugged connection for cleanout purposes.
6. This jacket access panel will permit access to the primary air-to-air exchanger.

2.1.5 TRIPLE-FLEX BEHIND THE CABINET DOOR

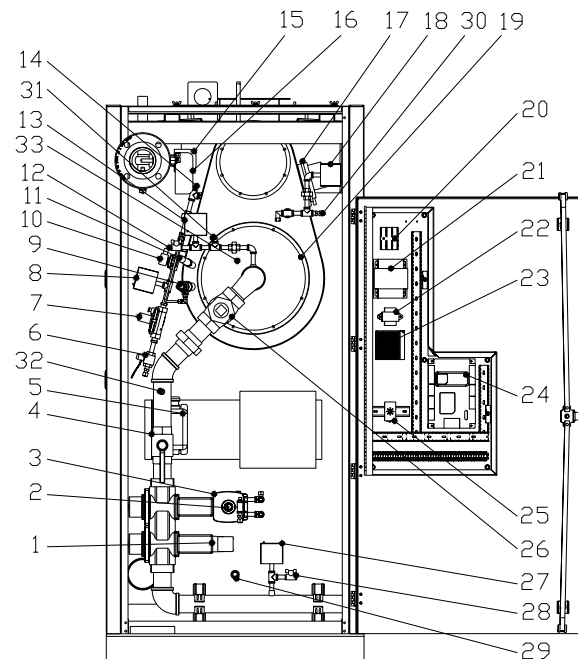

Figure 7 Triple-Flex Behind the Cabinet Door

1. Auxiliary gas shutoff valve actuator.
2. Low fire displacement adjustment that can be adjusted by removing the cap and rotating the slotted screw clockwise to increase gas flow and counter-clockwise to decrease gas flow.

Fig. 2.1.2 Triple-Flex Rear View

NOTE:

The low fire displacement final adjustment should be made at low fire only.

3. Main gas pressure regulating and shutoff valve actuator. The pressure regulating actuator provides slow opening fast closing safety shutoff and air/gas ratio control. The actuator controls the pressure difference across the gas limiting orifice valve (Figure 7 item 26) as a function of the pressure difference across the furnace section so that the air to gas ratio remains constant irrespective of air volume changes. There is no need for an upstream constant pressure regulator when the supply gas pressure does not exceed 56 inches of water column. A minimum of 14 inches of water column must be supplied at the gas inlet connection (Figure 6 item 1). The supply pressure can be measured at the test port (Figure 7 item 28).

NOTE:

The supply pressure is not static. The supply pressure is at the maximum full flow of gas through the burner.

4. Manual main gas shutoff valve.
5. Pilot ignition transformer.
6. Manual pilot gas shutoff valve.
7. Pilot gas pressure regulator. This regulator provides a constant gas pressure to the pilot when the solenoid valve is energized. The pressure can be adjusted by removing the cap and adjusting the slotted screw clockwise to increase the pressure and counter-clockwise to decrease the pressure. The pilot gas supply is taken upstream of the main gas cock so the pilot may be lighted and adjusted with the main gas cock closed.
8. Low pilot gas pressure switch (Manual Reset)
9. Pilot spark igniter assembly. For further detail see Figure 9.
10. Pilot gas solenoid valve.
11. Flame scanner.
12. Main gas manifold pressure test port (1/4" NPT).
13. Main high gas pressure switch (Manual Reset). This switch should be set 1" of water column above the maximum gas manifold pressure.
14. Pilot gas pressure test port (1/4" NPT). This

port is also used to record the furnace pressure.

15. Boiler water flow switch. The boiler water flow switch is adjustable within the parameters listed in the table.

Settings	Mode Of Operation	
	Switch Closed	Switch Open
Minimum	30 gpm	12 gpm
Maximum	52.1 gpm	46.1 gpm

Table 4 Water Flow Switch Settings

16. Low Water Cutoff (Manual Reset Probe Type).
17. Combustion air-flow switch. An airflow switch is provided to prove that air is being provided to the burners before main flame can be established. The airflow switch can be adjusted by turning the screw (Figure 8 item A) clockwise to increase the pressure setting and counter-clockwise to decrease the pressure setting. The switch will open on pressure drop. When the blower is running there should be continuity between the common and the normally open contacts (Figure 8 item B and C). When the blower is interrupted the switch should open and cause a safety shutdown.

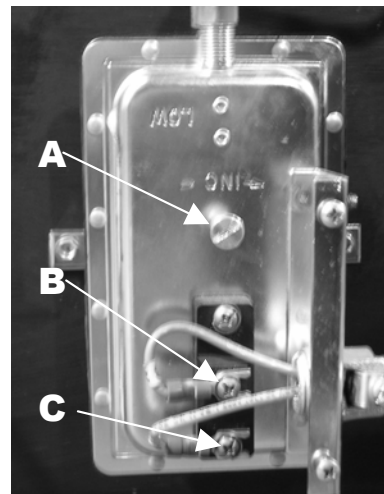

Figure 8 Air Flow Switch

18. High burner air pressure switch manual reset. This switch will trip when the air pressure in the burner rises above the set-point, indicating that the burner has become plugged with dust or other foreign matter.
19. Gas and air mixer assembly.
20. Main 3-phase power connection and fuse

block.

21. Control circuit transformer.
22. 24 volt ac transformer.
23. 12 volt dc power supply.
24. SOLA hydronic and flame supervision control.
25. Repeat cycle timer. This timer will ensure that a forced shut down and pre-start safety check is performed at least once in a 24 hour period. This timer has been incorporated into the SOLA control for newer boilers.
26. Gas limiting orifice valve. This valve is used to increase or decrease the gas / air ratio for combustion. Adjustments are made by removing the cap and using a flathead screwdriver. Clockwise rotation will increase the flue outlet % O₂ levels and counter-clockwise will decrease the flue outlet % O₂ level. Starting point adjustments are listed in the table. This valve is factory set and the number of turns out is written in black adjacent to the adjustment cap.

Boiler Model	Turns Out From Bottom
TF300	8-1/2 to 9
TF250	8-1/2 to 9
TF200	6-1/2 to 7
TF150	6-1/2 to 7

Table 5 Gas Limiting Orifice Rough Settings

27. Main low gas pressure switch (Manual Reset). This switch should be set 2 – 3 inches of water column below the minimum required supply gas pressure.
28. Supply gas pressure test port (1/4" NPT).
29. (-) Air pressure sensing line connection.
30. (+) Air pressure sensing line connection.
31. (-) Gas pressure sensing line connection.
32. (+) Gas pressure sensing line connection.
33. Burner internal temperature fuse. This fuse senses the internal burner temperature and will open at a temperature greater than 425°F.

2.1.6 PILOT SPARK IGNITER ASSEMBLY

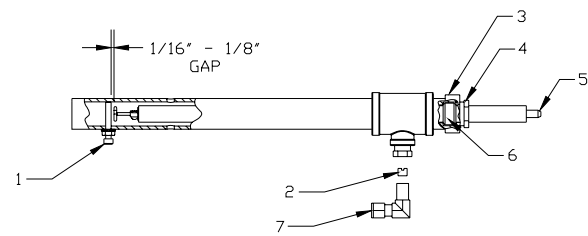

Figure 9 Pilot Spark Igniter Assembly

1. Spark grounding screw.
2. Pilot igniter gas orifice (#49 Drill)
3. Shell body 3/4".
4. Gland nut.
5. Igniter electrode.
6. Brass bushing.
7. Gas inlet fitting.

2.1.7 TRIPLE-FLEX LEFT FLUE COLLECTOR VIEW

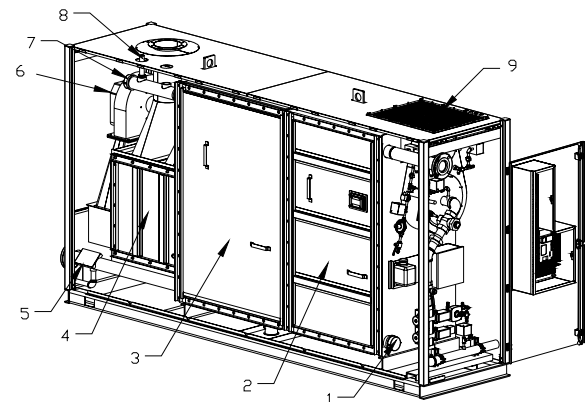

Figure 10 Triple-Flex Left Flue Collector View

1. 3" Lower drum cleanout and inspection opening.
2. Furnace tube access panel.
3. Convection tube access panel.
4. Primary air-to-air exchanger access cover.
5. ASME name-plate stamping.
6. Combustion air blower.
7. 3" Upper drum cleanout and inspection.
8. ASME Safety relief valve.
9. Air filter 20" x 25". This filter is a polyester coated fiberglass. The frame is made of fiberboard and has two tin-plated steel grills (one bonded to each side) as well as sealed corners to prevent dust leakage. Filters are marked with size and airflow direction.

Actual length and width are 3/8" less than trade size shown. Filters meet UL Class 2 flame retardance requirements. Maximum temperature is 180° F.

2.1.8 TRIPLE-FLEX RIGHT FLUE COLLECTOR VIEW

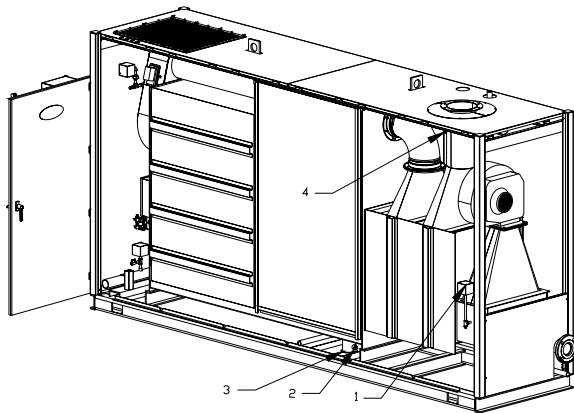

Figure 11 Triple-Flex Right Flue Collector View

1. High primary air-to-air exchanger pressure. This switch will trip when the air pressure in the primary air-to-air exchanger rises above the set-point, indicating that the primary air-to-air exchanger has become plugged with dust or other foreign matter.
2. Condensate trap cleanout. This connection is 1/2" NPT.
3. Condensate trap. The condensate trap is welded and fixed into place.
4. Flue vent temperature sensor.

2.2 SOLA HYDRONIC CONTROL SYSTEM

The Triple-Flex is equipped with a Honeywell SOLA control system (Figure 3 item 5). This section will explain navigation, configuration, history, and diagnostics.

2.2.1 POWER-UP VALIDATION

Flip the power button, (Figure 3 item 6), to the on position. After a few seconds the Home page will appear and the POWER LED will be blinking when the device is properly powered. Select the Setup button to adjust the contrast as desired.

2.2.2 HOME PAGE

Make sure a screen similar to Figure 12 appears after the system is completely powered up. The directional map shown before each page description in this manual will start with this

symbol . Pressing this symbol will return you to the home page.

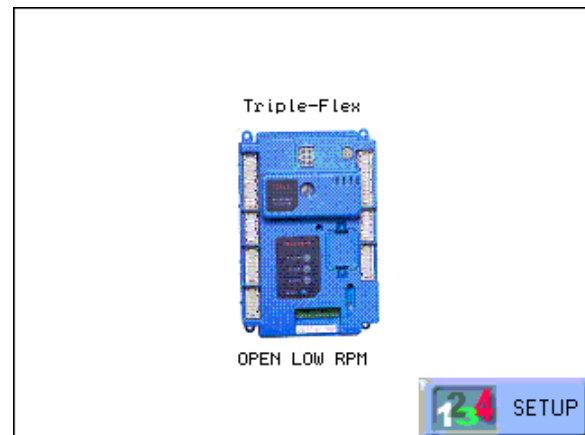

Figure 12 Home Page

On multi-boiler applications, each boiler in the hydronic system is represented on the Home page by an icon and name. Pressing the boiler icon allows the user to zoom in on that boiler and see specific details about it. These details are provided on a new page, which can include additional buttons that display additional detail and operation information, which itself leads to other pages. The pages are traversed in a tree structure method. The boiler icon button will appear in one of four colors indicating the boiler status.

- **Blue:** Normal operation
- **Red:** Lockout condition
- **Gray:** Standby mode (burner switch off)
- **Gray and crossed out:** Hydronic control communication error (disconnected or powered off)

Up to 8 boilers can be displayed on the System Home page.

The name of each boiler is displayed next to the boiler icon. When Lead Lag is enabled, the system header temperature and firing rate are displayed for each boiler. When the burner is in standby or not firing the firing rate is not displayed.

NOTE:

The boiler name may be cut off on the Home page when all boilers are present for the hydronic system.



The Home page also includes a System Analysis button that allows the user to view status information on a system-wide (that is, multiple boiler) basis. The user can choose which status information to compare from the boilers in the system. Pressing the Setup button on the Home page displays miscellaneous display setup and diagnostic functions.

2.2.3 PAGE NAVIGATION

The System Display, (Figure 3 item 5), presents information and options in a paged manner. Pages are displayed in a tree structure in which the user navigates up and down to arrive at the desired function. The page descriptions are provided below so that you can understand the purpose of each and view the selections, parameters, and information that are available or required on each. Most pages have a Home

button  in the top-left corner of the screen and a Back button in the top-right corner of the screen. The Home button returns the user to the Home page and terminates any operation in

progress. The Back button  returns the user to the previous page. Two other icons may be

noticed near the boiler name. A bell  will be displayed if the system is in lockout that reset will be required. A padlock  will be shown on screens that a password is needed to change

the parameter. An unlocked padlock  indicates the password has been entered to change the parameter (either the installer or OEM), depending on the security level entered.

2.2.4 KEYBOARD



Figure 13 Keyboard

Some pages request user entry of characters. When this type of input is required, a keyboard page appears, as shown in Figure 13.

The text box at the top of the screen displays the current (or default) setting of the user input. The user can add to this text, clear it, or change it. The Shift key on the left side of the screen shifts between upper- and lowercase characters. Pressing the Shift key toggles the keyboard from one mode to the other (continuous pressing of the Shift button is not required). The OK button should be pressed when the user is done entering the text input. The Cancel button on the bottom of the screen allows the user to ignore any text changes that have been made and keep the original text value. Pressing the OK or Cancel buttons returns the user to the page displayed prior to the keyboard page.

2.2.5 STATUS PAGE

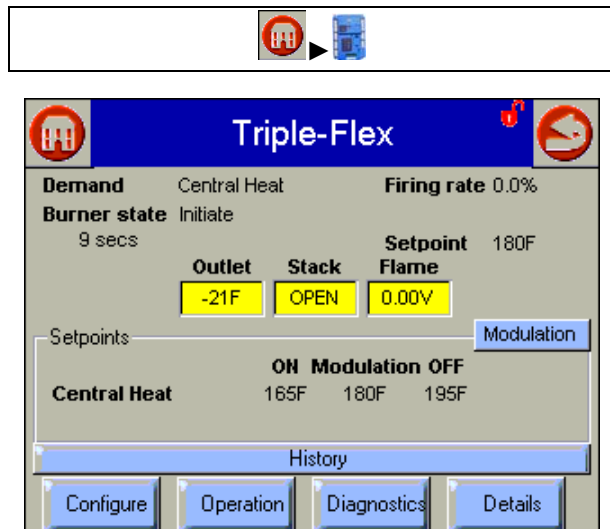

Figure 14 Status Page

The status page (Figure 14) is displayed when a boiler is selected on the Home page. The status page displays the current condition of the boiler and displays some of the more important configuration settings. The boiler name is displayed in the title bar of the status page.

NOTE:

When the boiler has no name defined, the display will use the Modbus address to identify the boiler.

The standard status page displayed for the Triple-flex boiler contains summary status information as shown in Figure 14. Any status information not applicable for the installation is blanked out on the screen. Buttons on this screen include:

Configure:

Used to configure the R7910 (see "Configuration Page" 2.2.6 page 18 for more details).

Operation:

Used to perform daily/frequent functions with the R7910, such as setpoint adjustment, etc. (See "Operation Page" 2.2.11 page 22 for more details.)

Diagnostic:

Used to view R7910 diagnostic information.

Details:

Used to view boiler detail status information.

History:

Used to view R7910 history.

Modulation:

Used to toggle between two different status displays: modulation, and setpoints.

2.2.6 CONFIGURATION PAGE



Figure 15 Configuration Menu Page

The configuration page allows the user to view and set parameters that define how the boiler functions in the hydronic heating system. Configuration parameters for any boiler connected in the Global Modbus™ network can be accessed from the display. Press the boiler's button on the Home page to access the Status page. Pressing the Configure button on the status page starts a configuration session. The configuration page contains a menu of parameters grouped into functional areas that the user selects for configuration (see Figure 15).

No specific order for configuring the boiler is required. All parameters are enabled for editing, though some may not be applicable (e.g., a configuration parameter may disable a boiler feature). Selecting a parameter group from the menu displays parameters exclusively

applicable for the functional group on the page (Figure 16).

Parameter	Setting
CH enable	Enabled
CH demand switch	LCI
CH setpoint	180F
CH time of day setpoint	160F
CH off hysteresis	15F
CH on hysteresis	15F
CH hysteresis step time	1 min
CH outdoor reset	Disabled

Figure 16 Sample Configuration Page

These parameters can be edited, and when the user is finished, control returns back to the configuration menu page. Each parameter is displayed in its group. If there are more parameters than will fit on the screen, a vertical scroll bar allows the user to scroll up and down to view all parameters. The parameter name is displayed on the left and the current setting is displayed in the text box on the right.

2.2.7 CONFIGURATION PASSWORD

Any user can view the configuration parameters (default mode). No access-level password is required to view the parameters. A valid configuration password for the parameter's level must be entered before the parameter can be changed. The password need only be entered once while the user remains on the configuration pages. Leaving the configuration pages ends the scope of the password entry. The user is notified that a new password is needed upon the first attempt to change a parameter (or until a password is entered successfully). The user can continue viewing the configuration parameters regardless of whether a password is entered successfully.

The boiler also maintains a password timeout that limits the scope of the password entry. Once a password is successfully entered the boiler starts an internal timer that expires after 10 minutes of inactivity. After the timer expires, the user is required to re-enter a password before a parameter can be changed. The user is not required to enter a configuration password

for a parameter that has a lower access level than the access level achieved by an earlier password entry for any configuration group (as long as the user stays in the configuration pages). The user only needs to enter a password once until a parameter that has a higher access level is selected.

The user enters the password from a keyboard as shown in Figure 13. After the password is entered, select the OK button. The Cancel button aborts the password login.



WARNING:

Explosion Hazard.

Improper configuration can cause fuel buildup and explosion. Improper user operation may result in PROPERTY LOSS, PHYSICAL INJURY or DEATH. Changing parameters, must be attempted by only experienced and/or licensed burner / boiler operators and mechanics.

Three levels of write access to boiler parameters are permitted. Each access level has defined rights when interfacing with configuration and status parameters in the Boiler.

- **End user:** The lowest access rights (no password login). The end user can, in most cases, only read or view boiler parameters. In some instances the end user can change boiler parameters, e.g., change the CH, central heat, setpoint.
- **Installer:** The next highest level. The installer can read all boiler parameters and change most boiler parameters. This access level is used to customize the boiler for a particular installation. The default installer password is 'bryan'.
- **OEM:** The highest access level. The OEM can read and change all R7910 parameters, as well as change sensor limits and burner control safety parameters.

Different passwords exist in the boiler for each access level. The end user level requires no password, but the installer and OEM levels have unique passwords defined for them. The display

validates all password entry attempts with the boiler, but doesn't conduct the validation itself. The boiler has sole responsibility to accept a password entry.

The display gets information from each boiler about the access level settings for the status and configuration parameters.

The installer and OEM passwords can be changed in the boiler after logging in with the current password. When the password is changed at the S7999B1026 it is saved in the R7910 and effective for all future logins.

NOTE:

Each boiler in a multi-boiler configuration has its own set of installer and OEM passwords. To avoid user confusion the passwords should be changed to the same setting in all the boilers, but there is no requirement to do so.

2.2.8 CHANGE PARAMETER SETTINGS

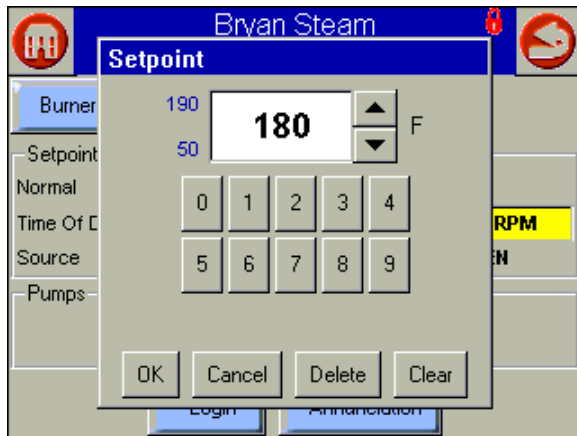

Figure 17 Change Parameter Dialog

Change parameter settings by selecting the parameter on the page. A dialog box displays for the parameter with controls allowing the user to change the value (Figure 17).

After changing the setting to a new value, press the OK button. Pressing the Cancel button leaves the parameter unchanged.

The changed setting is reflected on the screen and sent to the boiler when the OK button is pressed.

There are two classes of parameters.

Non-Safety: Non-safety parameters can be changed without placing the boiler in a dangerous state. These parameters typically do not require a password to modify.

Safety: Safety parameters can be viewed the same way non-safety parameters can be viewed. If the user makes no attempt to change a safety parameter, the user isn't required to enter safety verification mode.

Safety parameters are grouped into blocks that include only safety parameters, not a mixture of safety data and non-safety data. All parameters within the safety group undergo a verification process, (see paragraph 2.2.9 Safety Verification). A safety parameter group is identified on the display to indicate when the configuration parameters are safety-related.

2.2.9 SAFETY VERIFICATION

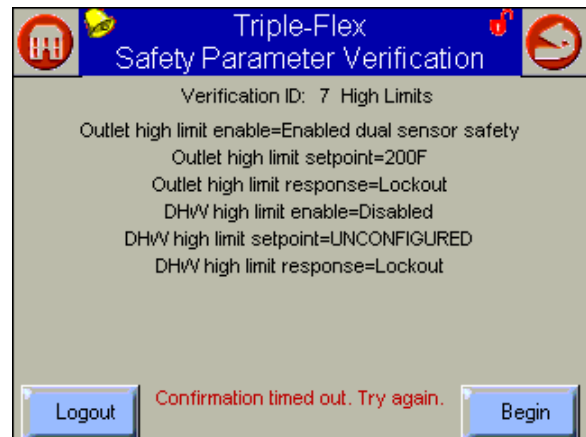

Figure 18 Safety Parameter Verification

For safety configuration parameters, safety verification is required to commit the changes.

All safety configuration parameters in the group should have the same access level. If this condition isn't so, the user is asked to enter another password when a higher access level is needed.

Each safety parameter group is verified one at a time until all have been verified (Figure 18).

A verification step is required for each safety parameter block that is changed. The verification steps do not have to be completed immediately; the user can traverse between parameter groups before the verifications are done. If the user is logged in with the appropriate password and has changed a safety configuration parameter, a verify button is enabled that allows the user to conduct verification sessions.

If the user terminates the safety configuration session after it has started, the boiler is left in an un-configured (boiler will not operate) state.

The user can terminate the session by pressing the Menu button or by attempting to leave the Verification page with the Home or Back buttons (top-left and -right screen corners, respectively). The user is warned that leaving the session at this point leaves the boiler in an un-configured state and confirms whether the user still wants to do so.

The settings of all parameters in each safety block must be confirmed to commit them to the boiler.

Selecting the begin button will start the verification process. The settings for all safety parameters in each changed block are presented and confirmed by the user (Figure 19).

Press the **Yes** button to confirm each safety parameter block. If the user selects the No button, the safety parameter block remains unconfirmed and the configuration menu page is displayed. The boiler remains in an un-configured state in this case.



Figure 19 Safety Parameter User Confirmation

After all safety parameter blocks have been confirmed, the user is asked to press and hold the reset button, (Figure 3 item 7), on the boiler to complete the safety configuration session (Figure 20).

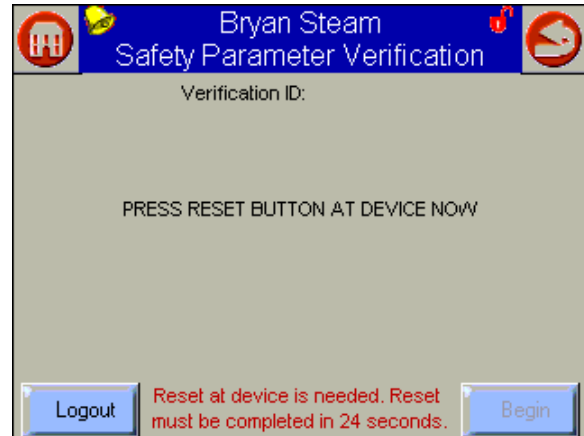

Figure 20 Safety Parameter Reset

When the Reset button is pressed and held for 3 seconds the confirmed safety parameters are committed in the boiler. The above reset dialog box automatically closes when this step is completed.

NOTE:

If the user doesn't perform this step, the boiler remains in a locked state until the user resolves the unconfirmed safety parameters.

2.2.10 FAULT/ALARM HANDLING

Each boiler reports a fault code when a lockout condition occurs for one of the following annunciations:

- Burner control
- Lockout
- Lead/Lag control

A less serious alarm condition may also occur that is treated as a warning instead of a fault. Each boiler can report active fault and warning codes for each annunciation.

Any new fault code detected in a boiler is indicated as a lockout condition at the display. The notification method used depends on the page that is displayed. On the Home page the button for the boiler with the fault turns red (Figure 21). On a boiler status page the History

button turns red (Figure 22). On all other pages and when the user is looking at a different boiler, a notification dialog box displays indicating which boiler just locked out.

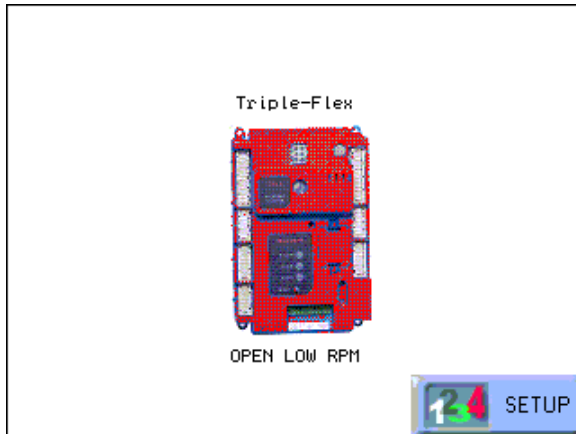

Figure 21 Home Page Lockout

Figure 23 History Dialog

The lockout history can be displayed for each boiler. The state information about each lockout is displayed along with the date/time that the lockout occurred.

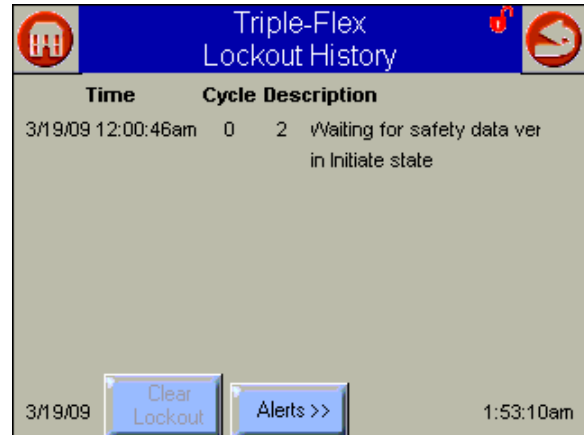

Figure 24 Lockout History Page

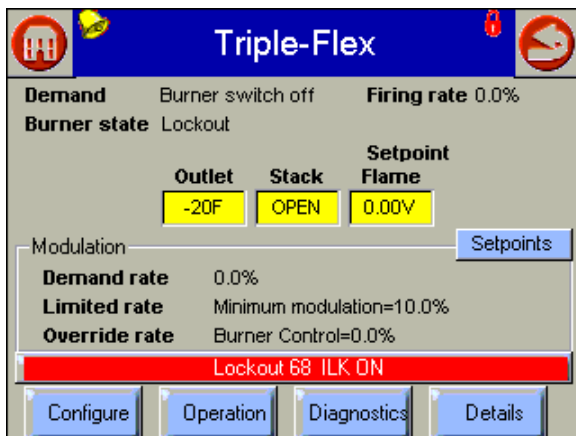

Figure 22 Status Page Lockout

Use the following to clear a lockout and reset the boiler.



2.2.11 OPERATION PAGE



Selecting the info bar will display the history dialog. If none of the buttons are selected the dialog box closes after 30 seconds.

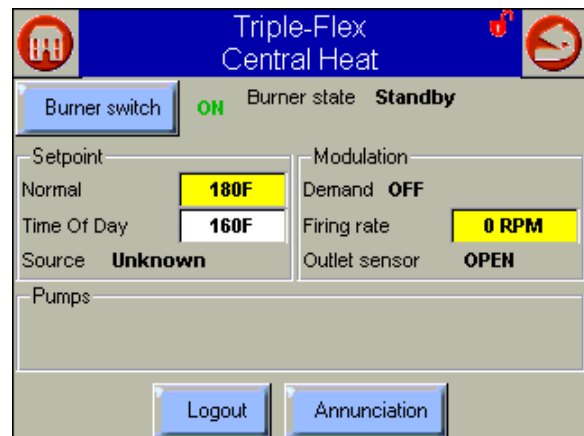
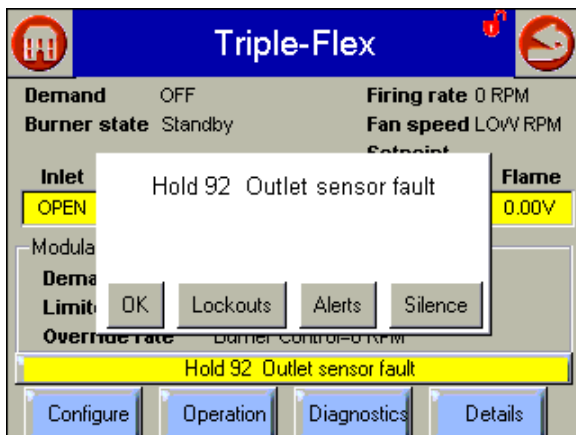

Figure 25 Operation Page

The operation page displays the boiler running operation, including set point and firing rate values expressed in rpm. From this page the user can change set points, manually control the boiler's firing rate, manually turn pumps on, view

annunciation information, and switch between heating loops (Central Heat and Domestic Hot Water), as shown in Figure 25. If a password is required to change any of the settings on this page, the user can press the Login button to enter the password.

2.2.12 ANNUNCIATION PAGE

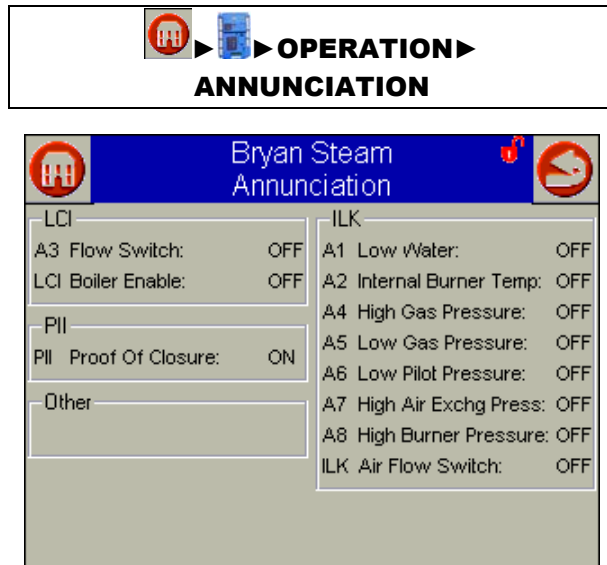

Figure 26 Annunciation Page

The annunciation page shows the status of the load control input (call for heat), pre-ignition interlock (proof of gas valve closure), and the running interlock strings. The components are listed in the order they are wired. This page can be called up at any time from the operation page (Figure 25). This page is very helpful for troubleshooting a lockout 67 (ILK off). All components for a given string are wired in series. The first component that indicates off will be the safety device to check.

2.2.13 MODULATION CONFIGURATION

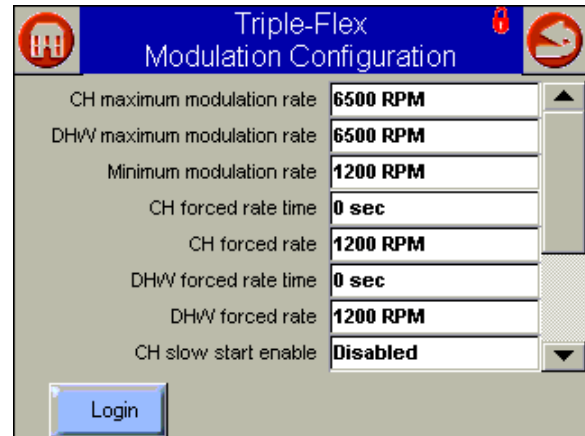

Figure 27 Modulation Configuration

The modulation configuration page is used to set the modulation range of the boiler. The recommended maximum and minimum rpm values can be found in

2.2.14 FIRING RATE CONTROL PAGE

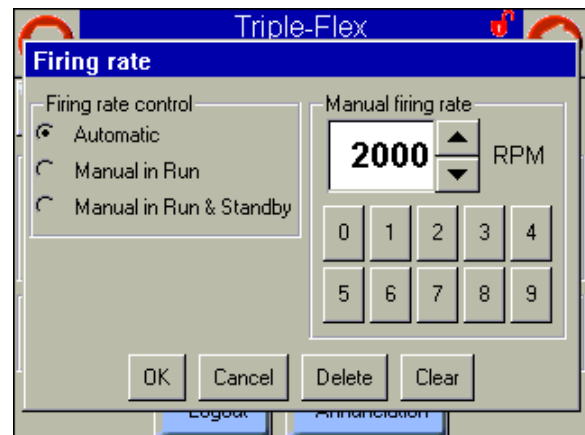

Figure 28 Firing Rate Control Page

The firing rate control page enables the user to change how the firing rate is controlled. The first option is for automatic control based on the current set point. The second option enables

the user to manually control the firing rate while the boiler is firing. The third option can be selected to change the rpm of the blower while the boiler is off or in standby. The manual firing rate can be changed by pressing the clear button and entering the new value or by using the up and down arrows. To accept the new value press the ok button and the boiler will change the firing rate to the new value. An error message will display if the value entered exceeds the maximum firing rate or falls below the minimum firing rate.

Note:

The firing rate control should come from the factory set to 'Manual in Run' with the manual firing rate value set to the light off rpm.

2.2.15 ADVANCED SETUP

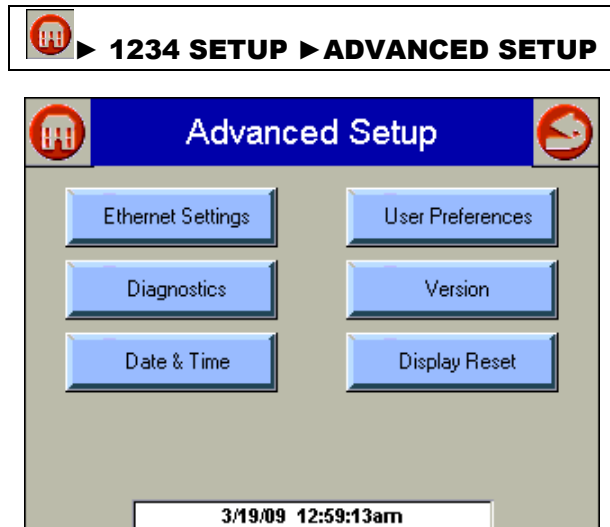

Figure 29 Advanced Setup

The advanced setup page displays many more options that can be changed by the user.

2.2.16 SYSTEM TIME



Figure 30 System Time

Set the date and time by adjusting the appropriate boxes using the up and down arrow keys. Select the OK button when finished.

Note:

Currently the date and time will need to be reset when a loss of power to the display occurs.

2.2.17 CALIBRATE TOUCH SCREEN

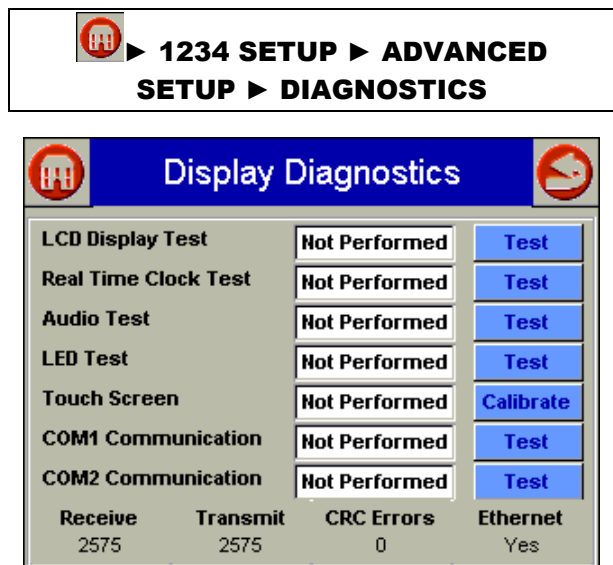

Figure 31 Display Diagnostics

Occasionally the touch screen will need to be

calibrated. When the screen is touched in a spot and unexpected results occur this is a good indication that the display needs to be calibrated. To calibrate the touch screen select the 'Calibrate' button and follow the on screen directions. Try using a stylus of some kind if the problem persists. The eraser end of a pencil or the blunt end of a pen can be used as a good stylus.

2.2.18 RESET / REBOOT DISPLAY

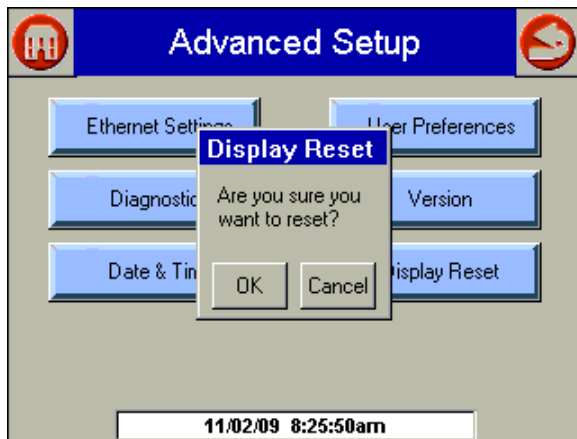
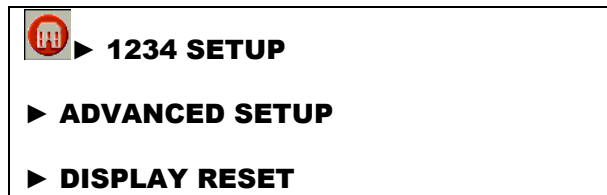

Figure 32 Reset / Reboot Display

The display can be reset or rebooted without powering down the boiler. Select the 'OK' button and the display will reboot as shown in paragraph Power-up Validation 2.2.1.

2.2.19 OUTDOOR RESET

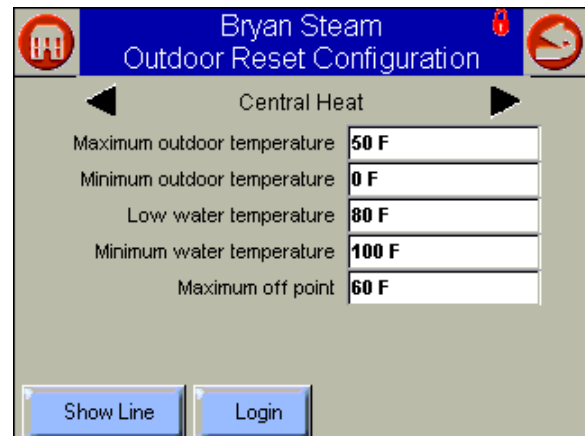
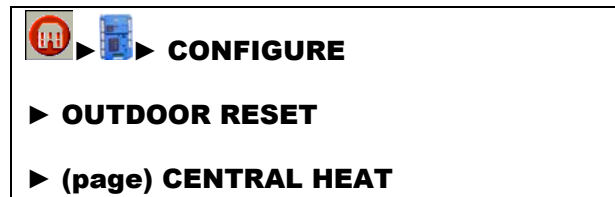

Figure 33 Outdoor Reset

Max outdoor temp (x ₂)	When the outdoor temperature is equal or greater than this value the boiler setpoint will be set to the low water temperature.
Min outdoor temp (x ₁)	When the outdoor temperature is equal or less than this value the boiler setpoint will be set to the Central Heat Setpoint value (y ₂) see 2.2.21.
Low water temp (y ₂)	This value represents the water temperature setpoint when the maximum outdoor temperature is reached.
Min water temp	This value is used to override the low water temperature of the curve created with the above points without changing the slope.
Max off point	Undefined / Not Used

Select the 'Show Line' button to display a graphical representation for the inputted data

(Figure 34). The normal reset curve is shown in green and the time of day is red.

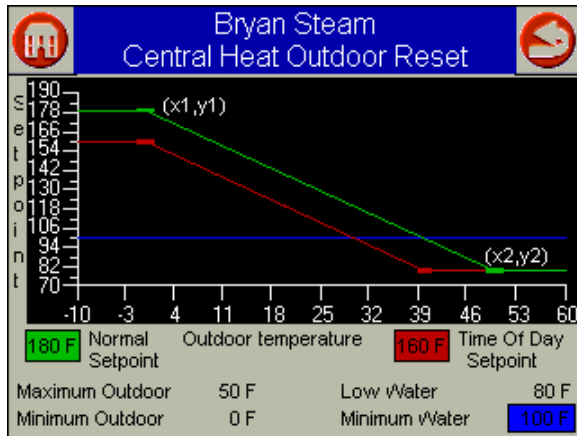

Figure 34 Outdoor Reset Curve

CONFIGURE

- ▶ **CH - CENTRAL HEAT CONFIGURATION**
- ▶ (page) **CENTRAL HEAT**
- ▶ **(Outdoor Reset) ENABLED**

Note:

y1 is the maximum water setpoint value found in 'CH – Central heat Configuration' on the 'Setpoint' page.

2.2.20 REMOTE SETPOINT (4 – 20 MA)

CONFIGURE

- ▶ **SENSOR CONFIGURATION**
- ▶ **(Sensor) S5 (J8-11) sensor**
- ▶ **(Connector type) 10K NTC single non-safety**
- ▶ **(Outdoor temperature source) S5 (J8-11) sensor**

CONFIGURE

- ▶ **SENSOR CONFIGURATION**
- ▶ **(Sensor) S2 (J8-6) sensor**
- ▶ **(Connector type) 4-20mA**
- ▶ **SAFETY VERIFICATION 2.2.9**

Figure 35 Outdoor Reset Sensor Configuration

CONFIGURE

- ▶ **CH - CENTRAL HEAT CONFIGURATION**
- ▶ (page) **SETPOINT**
- ▶ **(Setpoint Source) S2 (J8-6) 4-20mA**
- ▶ **(4 mA water temperature) MIN**
- ▶ **(20 mA water temperature) MAX**

Note:

Update the sensor name to 'Outdoor Sensor' by selecting a different sensor then reselecting the S5 (J8-11) sensor.

2.2.21 CENTRAL HEAT CONFIGURATION

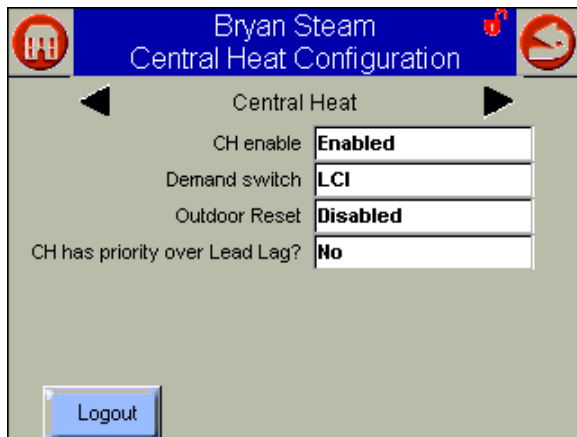
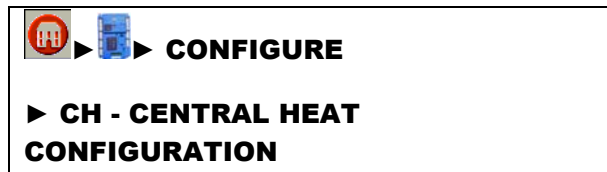

Figure 36 Central Heat Configuration (Central Heat Page)

CH enable	Disable or Enable Central Heating Loop
Demand switch	Sensor for Central Heat demand: Sensor only Sensor & STAT terminal Sensor & Remote Stat LCI & Sensor
Outdoor reset	Enabled Disabled
CH has priority over Lead Lag	Yes, No, Cancel

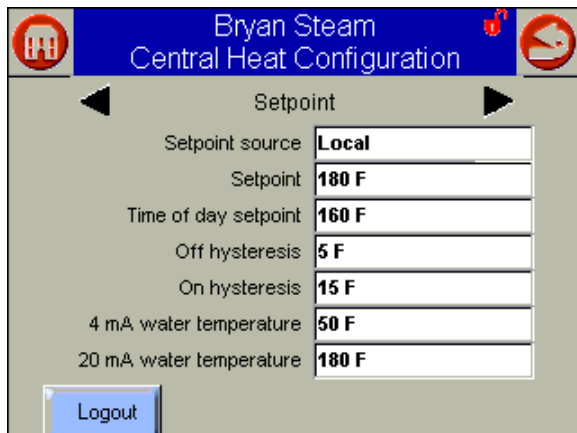

Figure 37 Central Heat Configuration (Setpoint Page)

Setpoint source	Local S2 (J8-6) 4-20mA
Setpoint	Setpoint for normal Central Heat modulation: 50 °F to 190 °F
Time of day setpoint	Setpoint when Time Of Day switch is on. 50 °F to 190 °F
Off hysteresis	Differential above setpoint when boiler is turned off. 2 °F to 5 °F
On hysteresis	Differential from setpoint when boiler is turned on. 2 °F to 30 °F
4 mA water temperature	50 °F to 190 °F
20 mA water temperature	50 °F to 190 °F

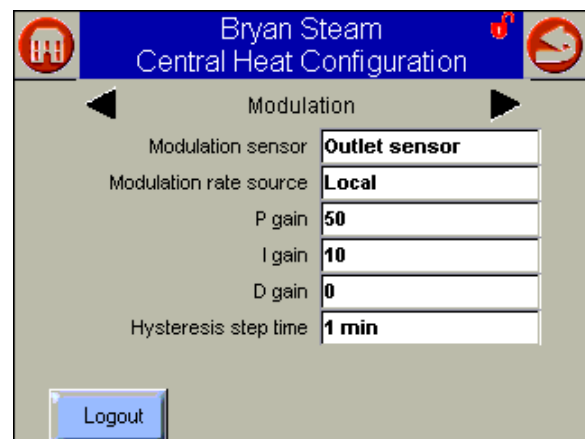

Figure 38 Central Heat Configuration (Modulation Page)

Modulation sensor	Outlet sensor, Inlet sensor, S5 (J8-11)
Modulation Rate Source	Local
P-gain Gain	applied for the P portion of the PID equation 0-400
I-gain Gain	applied for the I portion of the PID equation 0-400
D-gain	Gain applied for the D portion of the PID equation 0-400
Hysteresis step time (0=Disable hysteresis stepping)	Time between hysteresis step changes: 0-600 seconds

2.2.22 SOUND PRESSURE LEVELS

Sound pressure levels were measured at 4-1/2' above the floor and 3' from the boiler at the front, rear and two sides. See Table 6 for decibel readings.

Model	Decibel Readings			
	Front	Rear	Tube Side	Right Side

Date: 8-4-2010
Revision: 0
Form: 2396

	Decibel Readings			
Model	Front	Rear	Tube Side	Right Side
TF150	55.5	58.0	59.5	58.5
TF200	62.1	65.1	66.3	65.4
TF250	77.7	82.8	82.7	82.8
TF300	77.7	82.8	82.7	82.8

Table 6 Sound Pressure Readings

2.2.23 MODBUS COMMUNICATION

The hydronic control Global Modbus port is a 3-pin connector that interfaces to the following RS-485 signals:

Table 7 Modbus Terminals

Signal	Terminal
Data +	a
Data -	b
Common	c

Modbus connections can be made at the display (Figure 3 item 5) or the hydronic control (Figure 7 item 24).

For the modbus register map and other related information please download Honeywell's R7910A product manual at:

<http://customer.honeywell.com/TechLit/pdf/66-0000s/66-1171.pdf>

2.2.24 ALERT CODES

Table 8 Alert Codes

Code	Description
0	None (No alert)
1	Alert PCB was restored from factory defaults
2	Safety configuration parameters were restored from factory defaults
3	Configuration parameters were restored from factory defaults
4	Invalid Factory Invisibility PCB was detected
5	Invalid Factory Range PCB was detected
6	Invalid range PCB record has been dropped
7	EEPROM lockout history was initialized
8	Switched application annunciation data blocks
9	Switched application configuration data blocks
10	Configuration was restored from factory defaults
11	Backup configuration settings was restored from active configuration
12	Annunciation configuration was restored from factory defaults

13	Annunciation configuration was restored from backup
14	Safety group verification table was restored from factory defaults
15	Safety group verification table was updated
16	Invalid Parameter PCB was detected
17	Invalid Range PCB was detected
18	Alarm silence time exceeded maximum
19	Invalid safety group verification table was detected
20-26	RESERVED
27	Safety processor was reset
28	Application processor was reset
29	Burner switch was turned OFF
30	Burner switch was turned ON
31	Program Module (PM) was inserted into socket
32	Program Module (PM) was removed from socket
33	Alert PCB was configured
34	Parameter PCB was configured
35	Range PCB was configured
36	Program Module (PM) incompatible with product was inserted into socket
37	Program Module application parameter revision differs from application processor
38	Program Module safety parameter revision differs from safety processor
39	PCB incompatible with product contained in Program Module
40	Parameter PCB in Program Module is too large for product
41	Range PCB in Program Module was too large for product
42	Alert PCB in Program Module was too large for product
43	IAS start check was forced on due to IAS enabled
44	Low voltage was detected in safety processor
45	High line frequency occurred
46	Low line frequency occurred
47	Invalid subsystem reset request occurred
48	Write large enumerated Modbus register value was not allowed
49	Maximum cycle count was reached
50	Maximum hours count was reached
51	Illegal Modbus write was attempted
52	Modbus write attempt was rejected (NOT ALLOWED)

53	Illegal Modbus read was attempted
54	Safety processor brown-out reset occurred
55	Application processor watchdog reset occurred
56	Application processor brown-out reset occurred
57	Safety processor watchdog reset occurred
58	Alarm was reset by the user at the control
59	Burner control firing rate was > absolute max rate
60	Burner control firing rate was < absolute min rate
61	Burner control firing rate was invalid, % vs. RPM
62	Burner control was firing with no fan request
63	Burner control rate (nonfiring) was > absolute max rate
64	Burner control rate (nonfiring) was < absolute min rate
65	Burner control rate (nonfiring) was absent
66	Burner control rate (nonfiring) was invalid, % vs. RPM
67	Fan off cycle rate was invalid, % vs. RPM
68	Setpoint was overridden due to sensor fault
69	Modulation was overridden due to sensor fault
70-74	RESERVED
75	Absolute max fan speed was out of range
76	Absolute min fan speed was out of range
77	Fan gain down was invalid
78	Fan gain up was invalid
79	Fan minimum duty cycle was invalid
80	Fan pulses per revolution was invalid
81	Fan PWM frequency was invalid
82-89	RESERVED
90	Modulation output type was invalid
91	Firing rate control parameter was invalid
92	Forced rate was out of range vs. min/max modulation
93	Forced rate was invalid, % vs. RPM
94	Slow start ramp value was invalid
95	Slow start degrees value was invalid
96	Slow start was ended due to outlet sensor fault

97	Slow start was end due to reference setpoint fault
98	CH max modulation rate was invalid, % vs. RPM
99	CH max modulation rate was > absolute max rate
100	CH modulation range (max minus min) was too small (< 4% or 40 RPM)
101	DHW max modulation rate was invalid, % vs. RPM
102	DHW max modulation rate was > absolute max rate
103	DHW modulation range (max minus min) was too small (< 4% or 40 RPM)
104	Min modulation rate was < absolute min rate
105	Min modulation rate was invalid, % vs. RPM
106	Manual rate was invalid, % vs. RPM
107	Slow start enabled, but forced rate was invalid
108	Analog output hysteresis was invalid
109	Analog modulation output type was invalid
110	IAS open rate differential was invalid
111	IAS open step rate was invalid
112-114	RESERVED
115	Fan was limited to its minimum duty cycle
116	Manual rate was > CH max modulation rate
117	Manual rate was > DHW max modulation rate
118	Manual rate was < min modulation rate
119	Manual rate in Standby was > absolute max rate
120	Modulation commanded rate was > CH max modulation rate
121	Modulation commanded rate was > DHW max modulation rate
122	Modulation commanded rate was < min modulation rate
123	Modulation rate was limited due to outlet limit
124	Modulation rate was limited due to Delta-T limit
125	Modulation rate was limited due to stack limit
126	Modulation rate was limited due to anti- condensation
127	Fan Speed out of range in RUN
128	Modulation rate was limited due to IAS was open

129	Slow start ramp setting of zero will result in no modulation rate change
130	RESERVED
131	CH demand source was invalid
132	CH P-gain was invalid
133	CH I-gain was invalid
134	CH D-gain was invalid
135	CH OFF hysteresis was invalid
136	CH ON hysteresis was invalid
137	CH sensor type was invalid
138	CH hysteresis step time was invalid
139	CH remote control parameter was invalid
140	CH ODR not allowed with remote control
141-145	RESERVED
146	CH control was suspended due to fault
147	CH header temperature was invalid
148	CH outlet temperature was invalid
149	CH steam pressure was invalid
150-156	RESERVED
157	DHW demand source was invalid
158	DHW P-gain was invalid
159	DHW I-gain was invalid
160	DHW D-gain was invalid
161	DHW OFF hysteresis was invalid
162	DHW ON hysteresis was invalid
163	DHW hysteresis step time was invalid
164	DHW sensor type was invalid
165	Inlet sensor type was invalid for DHW
166	Outlet sensor type was invalid for DHW
167-170	RESERVED
171	DHW control was suspended due to fault
172	DHW temperature was invalid
173	DHW inlet temperature was invalid
174	DHW outlet temperature was invalid
175-182	RESERVED
183	Lead Lag P-gain was invalid
184	Lead Lag I-gain was invalid
185	Lead Lag D-gain was invalid
186	Lead Lag OFF hysteresis was invalid
187	Lead Lag ON hysteresis was invalid
188	Lead Lag slave enable was invalid
189	Lead Lag hysteresis step time was invalid
190-203	RESERVED

204	Lead Lag master was suspended due to fault
205	Lead Lag slave was suspended due to fault
206	Lead Lag header temperature was invalid
207	Lead Lag was suspended due to no enabled Program Module installed
208	Lead Lag slave session has timed out
209-221	RESERVED
222	CH frost protection temperature was invalid
223	CH frost protection inlet temperature was invalid
224	DHW frost protection temperature was invalid
225-230	RESERVED
231	LL setpoint was invalid
232	LL time of day setpoint was invalid
233	LL outdoor temperature was invalid
234	LL ODR time of day setpoint was invalid
235	LL ODR time of day setpoint exceeded normal setpoint
236	LL max outdoor setpoint was invalid
237	LL min outdoor setpoint was invalid
238	LL min water setpoint was invalid
239	LL outdoor temperature range was too small (minimum 12 C / 22 F)
240	LL water temperature range was too small (minimum 12 C / 22 F)
241-245	RESERVED
246	CH setpoint was invalid
247	CH time of day setpoint was invalid
248	CH outdoor temperature was invalid
249	CH ODR time of day setpoint was invalid
250	CH ODR time of day setpoint exceeds normal setpoint
251	CH max outdoor setpoint was invalid
252	CH min outdoor setpoint was invalid
253	CH min water setpoint was invalid
254	CH outdoor temperature range was too small (minimum 12 C / 22 F)
255	CH water temperature range was too small (minimum 12 C / 22 F)
256-260	RESERVED
261	DHW setpoint was invalid
262	DHW time of day setpoint was invalid

263-271	RESERVED
272	Abnormal Recycle: Pressure sensor fault
273	Abnormal Recycle: Safety relay drive test failed
274	Abnormal Recycle: Demand off during Pilot Flame Establishing Period
275	Abnormal Recycle: LCI off during Drive to Purge Rate
276	Abnormal Recycle: LCI off during Measured Purge Time
277	Abnormal Recycle: LCI off during Drive to Lightoff Rate
278	Abnormal Recycle: LCI off during Pre-Ignition test
279	Abnormal Recycle: LCI off during Pre-Ignition time
280	Abnormal Recycle: LCI off during Main Flame Establishing Period
281	Abnormal Recycle: LCI off during Ignition period
282	Abnormal Recycle: Demand off during Drive to Purge Rate
283	Abnormal Recycle: Demand off during Measured Purge Time
284	Abnormal Recycle: Demand off during Drive to Lightoff Rate
285	Abnormal Recycle: Demand off during Pre-Ignition test
286	Abnormal Recycle: Demand off during Pre-Ignition time
287	Abnormal Recycle: Flame was on during Safe Start check
288	Abnormal Recycle: Flame was on during Drive to Purge Rate
289	Abnormal Recycle: Flame was on during Measured Purge Time
290	Abnormal Recycle: Flame was on during Drive to Lightoff Rate
291	Abnormal Recycle: Flame was not on at end of Ignition period
292	Abnormal Recycle: Flame was lost during Main Flame Establishing Period
293	Abnormal Recycle: Flame was lost early in Run
294	Abnormal Recycle: Flame was lost during Run
295	Abnormal Recycle: Leakage test failed
296	Abnormal Recycle: Interrupted air flow switch was off during Drive to Purge Rate

297	Abnormal Recycle: Interrupted air flow switch was off during Measured Purge Time
298	Abnormal Recycle: Interrupted air flow switch was off during Drive to Lightoff Rate
299	Abnormal Recycle: Interrupted air flow switch was off during Pre-Ignition test
300	Abnormal Recycle: Interrupted air flow switch was off during Pre-Ignition time
301	Abnormal Recycle: Interrupted air flow switch was off during Main Flame Establishing Period
302	Abnormal Recycle: Ignition failed due to interrupted air flow switch was off
303	Abnormal Recycle: ILK off during Drive to Purge Rate
304	Abnormal Recycle: ILK off during Measured Purge Time
305	Abnormal Recycle: ILK off during Drive to Lightoff Rate
306	Abnormal Recycle: ILK off during Pre-Ignition test
307	Abnormal Recycle: ILK off during Pre-Ignition time
308	Abnormal Recycle: ILK off during Main Flame Establishing Period
309	Abnormal Recycle: ILK off during Ignition period
310	Run was terminated due to ILK was off
311	Run was terminated due to interrupted air flow switch was off
312	Stuck reset switch
313	Run was terminated due to fan failure
314	Abnormal Recycle: Fan failed during Drive to Purge Rate
315	Abnormal Recycle: Fan failed during Measured Purge Time
316	Abnormal Recycle: Fan failed during Drive to Lightoff Rate
317	Abnormal Recycle: Fan failed during Pre-Ignition test
318	Abnormal Recycle: Fan failed during Pre-Ignition time
319	Abnormal Recycle: Fan failed during Ignition period
320	Abnormal Recycle: Fan failed during Main Flame Establishing Period
321	Abnormal Recycle: Main Valve off after 10 seconds of RUN
322	Abnormal Recycle: Pilot Valve off after 10 seconds of RUN

323	Abnormal Recycle: Safety Relay off after 10 seconds of RUN
324	Abnormal Recycle: Hardware flame bias
325	Abnormal Recycle: Hardware static flame
326	Abnormal Recycle: Hardware flame current invalid
327	Abnormal Recycle: Hardware flame rod short
328	Abnormal Recycle: Hardware invalid power
329	Abnormal Recycle: Hardware invalid AC line
330	Abnormal Recycle: Hardware SLO flame ripple
331	Abnormal Recycle: Hardware SLO flame sample
332	Abnormal Recycle: Hardware SLO flame bias range
333	Abnormal Recycle: Hardware SLO flame bias heat
334	Abnormal Recycle: Hardware SLO spark stuck
335	Abnormal Recycle: Hardware SLO spark changed
336	Abnormal Recycle: Hardware SLO static flame
337	Abnormal Recycle: Hardware SLO rod shorted
338	Abnormal Recycle: Hardware SLO AD linearity
339	Abnormal Recycle: Hardware SLO bias not set
340	Abnormal Recycle: Hardware SLO bias shorted
341	Abnormal Recycle: Hardware SLO electronics
342	Abnormal Recycle: Hardware processor clock
343	Abnormal Recycle: Hardware AC phase
344	Abnormal Recycle: Hardware A2D mismatch
345	Abnormal Recycle: Hardware VSNSR A2D
346	Abnormal Recycle: Hardware 28V A2D
347	Abnormal Recycle: Hardware HFS IAS shorted
348	Abnormal Recycle: Hardware PII INTLK shorted
349	Abnormal Recycle: Hardware HFS LCI shorted

350	Abnormal Recycle: Hardware HFS LFS shorted
351	Abnormal Recycle: Invalid zero crossing
352	Abnormal Recycle: fault stack sensor
353	Abnormal Recycle: stack limit
354	Abnormal Recycle: delta T limit
355	Abnormal Recycle: fault outlet sensor
356	Abnormal Recycle: outlet high limit
357	Abnormal Recycle: fault DHW sensor
358	Abnormal Recycle: DHW high limit
359	Abnormal Recycle: fault inlet sensor
360	Abnormal Recycle: Check Parameters Failed
361	Internal error: No factory parameters were detected in control
362	Internal error: PID iteration frequency was invalid
363	Internal error: Demand-Rate interval time was invalid
364	Internal error: Factory calibration parameter for modulation was invalid
365	Internal error: CH PID P-scaler was invalid
366	Internal error: CH PID I-scaler was invalid
367	Internal error: CH PID D-scaler was invalid
368	Internal error: DHW PID P-scaler was invalid
369	Internal error: DHW PID I-scaler was invalid
370	Internal error: DHW PID D-scaler was invalid
371	Internal error: Lead Lag master PID P-scaler was invalid
372	Internal error: Lead Lag master PID I-scaler was invalid
373	Internal error: Lead Lag master PID D-scaler was invalid
374-459	RESERVED
460	LCI demand lost in run
461	Demand lost in run
462	STAT demand lost in run
463	Demand lost in run due to no flame
464-466	RESERVED
467	Internal error: EEPROM write was attempted before EEPROM was initialized
468	Internal error: EEPROM cycle count address was invalid

469	Internal error: EEPROM days count address was invalid
470	Internal error: EEPROM hours count address was invalid
471	Internal error: Lockout record EEPROM index was invalid
472	Internal error: Request to write PM status was invalid
473	Internal error: PM parameter address was invalid
474	Internal error: PM safety parameter address was invalid
475	Internal error: Invalid record in lockout history was removed
476	Internal error: EEPROM write buffer was full
477	Internal error: Data too large was not written to EEPROM
478	Internal error: Safety key bit 0 was incorrect
479	Internal error: Safety key bit 1 was incorrect
480	Internal error: Safety key bit 2 was incorrect
	481 Internal error: Safety key bit 3 was incorrect
	482 Internal error: Safety key bit 4 was incorrect
483	Internal error: Safety key bit 5 was incorrect
484	Internal error: Safety key bit 6 was incorrect
485	Internal error: Safety key bit 7 was incorrect
486	Internal error: Safety key bit 8 was incorrect
487	Internal error: Safety key bit 9 was incorrect
488	Internal error: Safety key bit 10 was incorrect
489	Internal error: Safety key bit 11 was incorrect
490	Internal error: Safety key bit 12 was incorrect
491	Internal error: Safety key bit 13 was incorrect
492	Internal error: Safety key bit 14 was incorrect
493	Internal error: Safety key bit 15 was incorrect
494	Internal error: Safety relay timeout
495	Internal error: Safety relay commanded off
496	Internal error: Unknown safety error occurred

497	Internal error: Safety timer was corrupt
498	Internal error: Safety timer was expired
499	Internal error: Safety timings
500	Internal error: Safety shutdown

2.3 BOILER COMMISSIONING

NOTE:

All of the installation instructions found in section 1 must be completed before commissioning the boiler.



WARNING:

The following procedures must be followed carefully before putting the boiler in operation. Failure to do so will present severe hazards to equipment, operating personnel and building occupants.

2.3.1 MODULATION

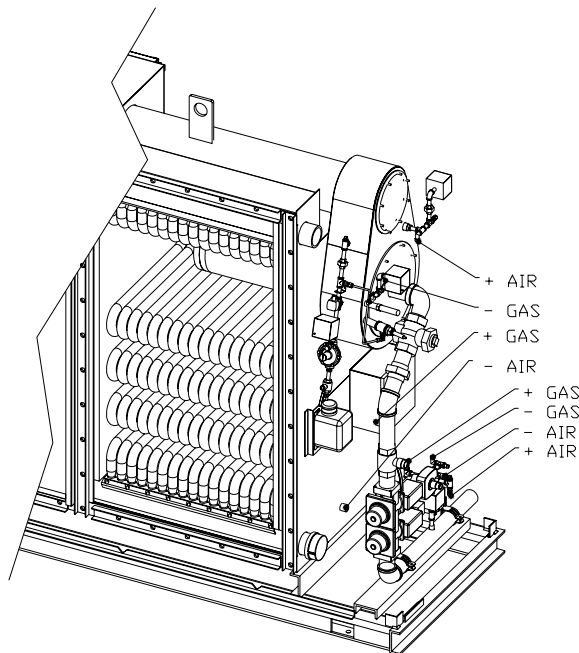

Figure 39 Air / Gas Ratio Tappings

Modulation on the Triple-flex boiler is accomplished with air / gas ratio control. The system consists of two major components, a blower (Figure 10 item 6) and a regulating gas valve (Figure 7 item 3). The blower is variable speed and provides combustion air to the burner. The blower rpm is controlled by a PWM (pulse width modulation) signal. The PWM signal increases or decreases as the load increases or decreases in the hydronic system.

The regulating gas valve is a 1:1 differential pressure air / gas ratio controller. This means that the control adjusts the same pressure difference on the gas side as it senses on the airside. The airside pressure is the difference between the pressure in the burner housing and the pressure downstream of the furnace section. The gas side pressure is the difference between the pressure upstream and downstream of the gas limiting orifice valve. For the locations of the +/- gas and air connections see (Figure 39). Air to gas ratios are adjusted with the gas limiting orifice valve (Figure 7 item 26).

During the burner pre-purge period, when the gas valve is closed, only the air pressure difference acts on the regulator causing the air diaphragm to move to the left and closes the regulating hydraulic bypass valve. When the actuator is powered, the gas valve begins to open. The downstream gas pressure difference immediately begins to increase until the gas pressure difference is in balance with the air pressure difference.

2.3.2 TEST SETUP

Connect a u-tube manometer to the gas manifold pressure tapping (Figure 7 item 12).

Connect a 0 – 5 psi gauge in the port provided in the low gas pressure switch connection (Figure 7 item 28).

Connect a u-tube manometer to the pilot gas pressure port provided (Figure 7 item 14).

A suitable combustion analyzer shall be used for measuring O₂, CO, and No_x levels. The analyzer probe should be inserted in the stack above the boiler outlet and before any draft controls. Calibration is required for the No_x and CO cells at the time of commissioning.

2.3.3 PRE CHECKS AND SETUP

Close the manual gas cock (Figure 7 item 4).



WARNING:

Do not open the manual main gas cock (Figure 7 item 4) before all pre checks, setups, and dry runs have been successfully completed.

With a voltmeter check for the proper incoming main voltage and the proper control voltage from the control circuit transformer. Refer to the electrical wiring diagram and boiler-rating label for proper voltages.

Make sure the boiler is full of water and proper flow has been established.

Power up the boiler see (paragraph 2.2.1).

Navigate to the 'Operation Screen' (paragraph 2.2.11). Select the burner switch to toggle the burner to the off state.

Navigate to the 'Firing Rate Control Page' (paragraph 2.2.14). Select the 'Manual in Run' option and enter the light off RPM from (Table 9 Approximate Boiler Settings) in the Manual Firing Rate box. This will prevent the burner from ramping up to high fire after the flame stabilization period.

Navigate to the 'Annunciation Page' (paragraph 2.2.12). All load control inputs and interlocks should be in the on state with the exception of the air flow switch. The air flow switch will close when the burner is commanded to start. Correct any problem indicated. Refer to trouble shooting (paragraph 0) for further help.

Navigate to the 'Operation Screen' (paragraph 2.2.11). The boiler is now prepared to be placed in the on state by toggling the burner switch to on.

2.3.4 DRY RUN

Navigate to the 'Operation Screen' (paragraph 2.2.11). Toggle the burner switch to on.

Navigate to the 'Status Page' (paragraph 2.2.5). If there is demand for hot water the burner state will display driving to purge. When the fan speed is within +/- 3% of the firing rate for 3

seconds the purge timer will start and count to 30. After 30 seconds the fan speed is reduced to the light off rate. When the fan speed is within +/- 3% of the firing rate for 3 seconds the ignition transformer and the pilot valve are energized. The pilot will light and can be observed from the observation port (Figure 5 item 4). After a duration of 5 seconds the ignition transformer will de-energize. The pilot valve will stay energized for another 5 seconds before the main gas valves are energized. During this 10 second period the pilot should be adjusted according to paragraph 2.3.5.

The main gas valves will energize for 10 seconds. After this 10 second duration the pilot valve is de-energized. The control will lockout with a code of 106, Flame lost in Main Flame Establishing Period.



WARNING:

During the first 10 seconds of this process the automatic gas valves should not have opened or been energized. If any of the automatic gas valves are energized or open at this point correct the problem immediately.

2.3.5 PILOT ADJUSTMENT

Adjust the pilot gas pressure between 3.5 iwc and 4 iwc. The pilot flame signal can be observed from the status page (paragraph 2.2.5). The minimum flame signal is .8 volts. The flame signal can vary between 4 volts and 15 volts. A flame signal closer to 15 volts is preferred. Observe the pilot flame through the flame observation port (Figure 5 item 4). The pilot should appear stable. A stable pilot will not flicker on and off. Recycle the boiler as many times as needed to establish a good pilot. If the pilot fails to light refer to trouble shooting (paragraph 1.1.1) for further help.

 **WARNING:**
During pilot adjustment leave the manual main gas cock (Figure 7 item 4) closed.

NOTE:
Pilot gas pressures in excess of the recommended will lead to the formation of carbon hairs that will ground out the pilot igniter causing a safety shutdown.

2.3.6 INITIAL LIGHT OFF

Open the manual main gas cock (Figure 7 item 4). Clear the lockout fault (paragraph 2.2.10) and allow the burner to cycle and attempt to light off. If the main flame fails to light, the low fire displacement of the pressure regulating actuator (Figure 7 item 2) may need to be increased.

 **WARNING:**
Do not adjust the low fire displacement more than 1/4 to 1/2 turn for each main flame-establishing period.

The boiler will light off at approximately 1.5 times the minimum firing rate rpm. The boiler will hold in this position for no less than 5 minutes to establish a stable flame before releasing the boiler to full modulation. Observe combustion readings and make small adjustments to the low fire displacement of the pressure regulating actuator (Figure 7 item 2) when the O2 is not within 6% to 10%. Allow sufficient time for combustion to stabilize after each 1/4 to 1/2 turn of the low fire displacement (Figure 7 item 2).

2.3.7 ADJUSTING BOILER MAXIMUM INPUT

After the flame stabilization period increase the firing rate in 500 rpm increments until the maximum modulation rate (paragraph 2.2.13) is reached. For each 500 rpm increment observe combustion readings and make adjustments to the gas limiting orifice (Figure 7 item 26) if the O2 is not within 6% to 10%. Final adjustments

for NOx, O2, and CO should be made at the maximum firing rate. No further adjustments are required of the gas limiting orifice valve. Return to the minimum low fire rate (paragraph 2.2.13) in increments of 500 rpm. For each increment verify combustion readings. Refer to trouble shooting (paragraph 0) for further help.

NOTE:
Use rpm values that fall between the rpm values used going to high fire. This will give more points to verify on the modulation curve.

2.3.8 ADJUSTING BOILER MINIMUM INPUT

NOTE:
The boiler maximum input must be adjusted before final adjustments can be made for minimum input.

Decrease the boiler firing rate to the minimum modulation rate (paragraph 2.2.13). Adjust the O2 level to obtain Nox levels desired by adjusting the low fire displacement on the gas pressure regulating actuator to obtain appropriate NOx, O2, and CO levels. Allow sufficient time for combustion to stabilize after each 1/4 to 1/2 turn of the low fire displacement (Figure 7 item 2).

 **WARNING:**
O2 levels below 6% will overheat the metal fiber burner and cause the fuel / air mixture to ignite inside the burner. An internal temperature fuse is provided to open when the internal burner temperature reaches 425 °F.

	Boiler Model			
	TF300	TF250	TF200	TF150
Pilot Gas Pressure (IWC)	3.5 - 4	3.5 - 4	3.5 - 4	3.5 - 4
Light Off RPM	1800	1800	1200	1200
High Fire				

Gas Manifold Pressure (IWC)	4.4	3.6	4.0	2.0
Max RPM	6000-7000	5100-5500	3550-4200	2700-2850
Low Fire				
Gas Manifold Pressure (IWC)	.3	.3	.2	.2
Min RPM	1200-1600	1200-1600	800-950	800-950

Table 9 Approximate Boiler Settings

2.3.9 GAS METER READINGS

Burner input rate can be checked by taking readings from the gas meter. Please note checking the rate with a meter is the only way to be sure of input. Manifold readings are only an approximate value and may vary from unit to unit.

In order to obtain accurate data, there must be no other appliances using gas from the same meter while the burner input rate is being checked.

A stopwatch or a watch with a second hand is required to obtain a meter reading. Clock the amount of time it takes for the smallest dial to complete one revolution in seconds. Use the following formula to obtain the cubic feet per hour throughput of the unit.

$$CFH = \frac{3600V_c}{g_c}$$

$$CFH = ft^3 hr^{-1} \text{ of gas}$$

$$V_c = ft \text{ clocked}$$

$$g_c = \text{time in seconds}$$

To obtain the Btu per hour throughput of the unit use the following formula.

$$Q = CFH(h_v)$$

$$h_v = \text{heating value of fuel in Btu ft}^{-3}$$

If the meter is not calibrated for gas temperature and pressure, correction factors must be applied to determine correct rate in SCFH (standard

cubic feet per hour). Consult the National Fuel Gas Code (ANSI Z223.1, NFPA 54) or the local gas utility for further information. Refer to Table 10 for correction factors for the gas pressure at the meter. Refer to Table 11 for the gas temperature correction factors.

Gas Pressure at Meter	Corr. Factor
14" w.c.	1.034
21" w.c.	1.051
1 psig	1.061
2 psig	1.136
5 psig	1.340

Table 10 Gas Pressure Correction

Gas Temp. at Meter	Corr. Factor
40 °F	1.04
50 °F	1.02
60 °F	1.0
70 °F	.981
80 °F	.963
90 °F	.945

Table 11 Gas Temperature Correction

To correct for pressure and temperature use the following formula.

$$Q_c = Q t_p t_t$$

$$t_p = \text{pressure correction table 2.2A}$$

$$t_t = \text{temperature correction table 2.2B}$$

2.4 TROUBLESHOOTING

To support the recommended Troubleshooting, the R7910 has an Alert File. Review the Alert history for possible trends that may have been occurring prior to the actual lockout.

Note Column:

H = Hold message

L = Lockout message

H or L = either Hold or Lockout depending on Parameter Configuration

Table 12 R7910A Lockout and Hold Codes

Code	Description	Recommended Troubleshooting of Lockout Codes	Code
1	Unconfigured safety data	1.New Device, complete device configuration and safety verification. 2. If fault repeats, replace module.	L
2	Waiting for safety data verification	1. Device in Configuration mode and safety parameters need verification and a device needs reset to complete verification. 2. Configuration ended without verification, re enter configuration, verify safety parameters and reset device to complete verification. 3. If fault repeats, replace module	L
3	Internal fault: Hardware fault	Internal fault 1. Reset module 2. If fault repeats, replace module.	H
4	Internal fault: Safety Relay key feedback error		H
5	Internal fault: Unstable power (DCDC) output		H
6	Internal fault: Invalid processor clock		H
7	Internal fault: Safety relay drive error		H
8	Internal fault: Zero crossing not detected		H
9	Internal fault: Flame bias out of range		H
10	Internal fault: Invalid Burner control state		L
11	Internal fault: Invalid Burner control state flag		L
12	Internal fault: Safety relay drive cap short		H
13	Internal fault: PII shorted to ILK		H OR L
14	Internal fault: HFS shorted to LCI		H OR L

Code	Description	Recommended Troubleshooting of Lockout Codes	Code
15	Internal fault: Safety relay test failed due to feedback ON		L
16	Internal fault: Safety relay test failed due to safety relay OFF		L
17	Internal fault: Safety relay test failed due to safety relay not OFF		L
18	Internal fault: Safety relay test failed due to feedback not ON		L
19	Internal fault: Safety RAM write		L
20	Internal fault: Flame ripple and overflow		H
21	Internal fault: Flame number of sample mismatch		H
22	Internal fault: Flame bias out of range		H
23	Internal fault: Bias changed since heating cycle starts		H
24	Internal fault: Spark voltage stuck low or high		H
25	Internal fault: Spark voltage changed too much during flame sensing time		H
26	Internal fault: Static flame ripple		H
27	Internal fault: Flame rod shorted to ground detected		H
28	Internal fault: A/D linearity test fails		H
29	Internal fault: Flame bias cannot be set in range		H
30	Internal fault: Flame bias shorted to adjacent pin		H
31	Internal fault: SLO electronics unknown error		H

Code	Description	Recommended Troubleshooting of Lockout Codes	Code
32-46	Internal fault: Safety Key 0 through 14		L
47	Flame Rod to ground leakage		H
48	Static flame (not flickering)		H
49	24VAC voltage low/ high	1. Check the Module and display connections. 2. Check the Module power supply and make sure that both frequency, voltage and VA meet the specifications.	H
50	Modulation fault	Internal sub-system fault. 1. Review alert messages for possible trends. 2. Correct possible problems.	H
51	Pump fault		H
52	Motor tachometer fault		H
53	AC inputs phase reversed	1. Check the Module and display connections. 2. Check the Module power supply and make sure that both frequency and voltage meet the specifications. 3. On 24Vac applications, assure that J4 terminal 10 and J8 terminal 2 are connected together.	L
54-57	RESERVED		
58	Internal fault: HFS shorted to IAS	Internal Fault. 1. Reset Module. 2. If fault repeats, replace module	L
59	Internal Fault: Mux pin shorted		L
60	Internal Fault: HFS shorted to LFS		L
61	Anti short cycle	Will not be a lockout fault. Hold Only.	H
62	Fan speed not proved		H
63	LCI OFF	1. Check wiring and correct any faults. 2. Check Interlocks connected to the LCI to assure proper function. 3. Reset and sequence the module; monitor the LCI status. 4. If code persists, replace the module	H
64	PII OFF	1. Check wiring and correct any faults. 2. Check Preignition Interlock switches to assure proper functioning. 3. Check the valve operation. 4. Reset and sequence the module; monitor the PII status. 5. If code persists, replace the module.	L
65	Interrupted Airflow Switch OFF	1. Check wiring and correct any possible shorts. 2. Check airflow switches to assure proper functioning. 3. Check the fan/blower operation. 4. Reset and sequence the module; monitor the airflow status. 5. If code persists, replace the module.	H or L
66	Interrupted Airflow Switch ON		H or L
67	ILK OFF	1. Check wiring and correct any possible shorts. 2. Check Interlock (ILK) switches to assure proper function. 3. Verify voltage through the interlock string to the interlock input with a voltmeter. 4. If steps 1-3 are correct and the fault persists, replace the module.	L

Code	Description	Recommended Troubleshooting of Lockout Codes	Code
68	ILK ON	This lockout occurs when the interlock string is closed before the blower starts. The airflow switch is the only device in the interlock string that will open when in standby. Probable causes are. <ol style="list-style-type: none"> 1. Air pressure in the boiler room has become negative. 2. Excessive downdraft in the stack. 3. Blower is spinning before being commanded by the hydronic control. Make sure blower is not running in standby. 4. Airflow switch is stuck closed. 	L
69	Pilot test hold	<ol style="list-style-type: none"> 1. Verify Run/Test is changed to Run. 2. Reset Module. 3. If fault repeats, replace module. 	H
70	Wait for leakage test completion	<ol style="list-style-type: none"> 1. Internal Fault. Reset Module. 2. If fault repeats, replace module. 	H
71-77	RESERVED		
78	Demand Lost in Run	<ol style="list-style-type: none"> 1. Check wiring and correct any possible errors. 2. If previous steps are correct and fault persists, replace the module. 	H
79	Outlet high limit	<ol style="list-style-type: none"> 1. Check wiring and correct any possible errors. 2. Replace the Outlet high limit. 3. If previous steps are correct and fault persists, replace the module. 	H or L
80	DHW high limit	<ol style="list-style-type: none"> 1. Check wiring and correct any possible errors. 2. Replace the DHW high limit. 3. If previous steps are correct and fault persists, replace the module. 	H or L
81	Delta T limit	<ol style="list-style-type: none"> 1. Check Inlet and Outlet sensors and pump circuits for proper operation. 2. Recheck the Delta T Limit to confirm proper setting. 3. If previous steps are correct and fault persists, replace the module. 	H or L
82	Stack limit	<ol style="list-style-type: none"> 1. Check wiring and correct any possible errors. 2. Replace the Stack high limit. 3. If previous steps are correct and fault persists, replace the module. 	H or L
83-90	RESERVED		
91	Inlet sensor fault	<ol style="list-style-type: none"> 1. Check wiring and correct any possible errors. 2. Replace the Inlet sensor. 3. If previous steps are correct and fault persists, replace the module. 	H
92	Outlet sensor fault	<ol style="list-style-type: none"> 1. Check wiring and correct any possible errors. 2. Replace the Outlet sensor. 3. If previous steps are correct and fault persists, replace the module. 	H
93	DHW sensor fault	<ol style="list-style-type: none"> 1. Check wiring and correct any possible errors. 2. Replace the DHW sensor. 3. If previous steps are correct and fault persists, replace the module. 	H
94	Header sensor fault	<ol style="list-style-type: none"> 1. Check wiring and correct any possible errors. 2. Replace the header sensor. 3. If previous steps are correct and fault persists, replace the module. 	H
95	Stack sensor fault	<ol style="list-style-type: none"> 1. Check wiring and correct any possible errors. 	H

Code	Description	Recommended Troubleshooting of Lockout Codes	Code
		2. Replace the stack sensor. 3. If previous steps are correct and fault persists, replace the module	
96	Outdoor sensor fault	1. Check wiring and correct any possible errors. 2. Replace the outdoor sensor. 3. If previous steps are correct and fault persists, replace the module.	H
97	Internal Fault: A2D mismatch.	Internal Fault. 1. Reset Module.	L
98	Internal Fault: Exceeded VSNSR voltage tolerance	2. If fault repeats, replace module.	L
99	Internal Fault: Exceeded 28V voltage tolerance		L
100	Pressure Sensor Fault	1. Verify the Pressure Sensor is a 4-20ma source. 2. Check wiring and correct any possible errors. 3. Test Pressure Sensor for correct operation. 4. Replace the Pressure sensor. 5. If previous steps are correct and fault persists, replace the module.	H
101-104	RESERVED		
105	Flame detected out of sequence	1. Check that flame is not present in the combustion chamber. Correct any errors. 2. Make sure that the flame detector is wired to the correct terminal. 3. Make sure the F & G wires are protected from stray noise pickup. 4. Reset and sequence the module, if code reappears, replace the flame detector. 5. Reset and sequence the module, if code reappears, replace the module.	H or L
106	Flame lost in MFEP	1. Check pilot valve (Main Valve for DSI) wiring and operation - correct any errors. 2. Check the fuel supply. 3. Check fuel pressure and repeat turndown tests. 4. Check ignition transformer electrode, flame detector, flame detector setting or flame rod position. 5. If steps 1 through 4 are correct and the fault persists, replace the module.	L
107	Flame lost early in run		L
108	Flame lost in run		L
109	Ignition failed		L
110	Ignition failure occurred	Hold time of recycle and hold option. Will not be a lockout fault. Hold Only. Internal hardware test. Not a lockout.	H
111	Flame current lower than WEAK threshold		H
112	Pilot test flame timeout	Interrupted Pilot or DSI application and flame lost when system in "test" mode. 1. Reset the module to restart.	L
113	Flame circuit timeout	Flame sensed during Initiate or off cycle, hold 240 seconds, if present after 240 seconds, lockout.	L
114-121	RESERVED		

Code	Description	Recommended Troubleshooting of Lockout Codes	Code
122	Lightoff rate proving failed	1. Check wiring and correct any potential wiring errors. 2. Check VFDs ability to change speeds. 3. Change the VFD 4. If the fault persists, replace the module.	L
123	Purge rate proving failed		L
124	High fire switch OFF		H
125	High fire switch stuck ON		H
126	Low fire switch OFF	3. Manually drive the motor to the High Fire position and adjust the HF switch while in this position and verify voltage through the switch to the HFS input with a voltmeter. 4. If steps 1-3 are correct and the fault persists, replace the module.	H
127	Low fire switch stuck ON		H or L
128	Fan speed failed during prepurge		H or L
129	Fan speed failed during preignition	1. Check wiring and correct any potential wiring errors. 2. Check VFDs ability to change speeds. 3. Change the VFD 4. If the fault persists, replace the module.	H or L
130	Fan speed failed during ignition		H or L
131	Fan movement detected during standby		H
132	Fan speed failed during run		H
133-135	RESERVED		
136	Interrupted Airflow Switch failed to close	1. Check wiring and correct any possible wiring errors. 2. Check Interrupted Airflow switch(es) to assure proper function. 3. Verify voltage through the airflow switch to the IAS input with a voltmeter. 4. If steps 1-3 are correct and the fault persists, replace the module.	H
137	ILK failed to close	1. Check wiring and correct any possible shorts. 2. Check Interlock (ILK) switches to assure proper function. 3. Verify voltage through the interlock string to the interlock input with a voltmeter. 4. If steps 1-3 are correct and the fault persists, replace the module.	H
138-148	RESERVED		
	FAULT CODES 149 THROUGH 165 ARE OEM SPECIFIC FAULT CODES.		
149	Flame detected	OEM Specific 1. Holds if flame detected during Safe Start check up to Flame Establishing period.	H or L
150	Flame not detected	OEM Specific 1. Sequence returns to standby and restarts sequence at the beginning of Purge after the HF switch opens. if flame detected during Safe Start check up to Flame Establishing period.	H
151	High fire switch ON	OEM Specific	H or L

Code	Description	Recommended Troubleshooting of Lockout Codes	Code
		<ol style="list-style-type: none"> 1. Check wiring and correct any potential wiring errors. 2. Check High Fire Switch to assure proper function (not welded or jumpered). 3. Manually drive the motor to the High Fire position and adjust the HF switch while in this position and verify voltage through the switch to the HFS input with a voltmeter. 4. If steps 1-3 are correct and the fault persists, replace the module. 	
152	Combustion pressure ON	OEM Specific	H or L
153	Combustion Pressure Off	<ol style="list-style-type: none"> 1. Check wiring and correct any errors. 2. Inspect the Combustion Pressure Switch to make sure it is working correctly. 3. Reset and sequence the relay module. 4. During STANDBY and PREPURGE, measure the voltage between J6 terminal 5 and L2 (N). Supply voltage should be present. If not, the lockout switch is defective and needs replacing. 5. If the fault persists, replace the relay module. 	H or L
154	Purge Fan switch On	OEM Specific	H or L
155	Purge fan switch OFF	<ol style="list-style-type: none"> 1. Purge fan switch is on when it should be off. 2. Check wiring and correct any errors. 3. Inspect the Purge Fan switch J6 terminal 3 and its connections. Make sure the switch is working correctly and is not jumpered or welded. 4. Reset and sequence the relay module. 5. If the fault persists, replace the relay module. 	H or L
156	Combustion pressure and Flame ON	OEM Specific	H or L
157	Combustion pressure and Flame OFF	<ol style="list-style-type: none"> 1. Check that flame is not present in the combustion chamber. Correct any errors. 2. Make sure that the flame detector is wired to the correct terminal. 3. Make sure the F & G wires are protected from stray noise pickup. 4. Reset and sequence the module, if code reappears, replace the flame detector. 5. Reset and sequence the module, if code reappears, replace the module. 	L
158	Main valve ON	OEM Specific	L
159	Main valve OFF	<ol style="list-style-type: none"> 1. Check Main Valve terminal wiring and correct any errors. 2. Reset and sequence the module. If fault persist, replace the module. 	L
160	Ignition ON	OEM Specific	L
161	Ignition OFF	<ol style="list-style-type: none"> 1. Check Ignition terminal wiring and correct any errors. 2. Reset and sequence the module. If fault persist, replace the module. 	L
162	Pilot valve ON	OEM Specific	L
163	Pilot valve OFF	<ol style="list-style-type: none"> 1. Check Pilot Valve terminal wiring and correct any errors. 2. Reset and sequence the module. If fault persist, replace the module. 	L
164	Block intake ON	OEM Specific	L

Code	Description	Recommended Troubleshooting of Lockout Codes	Code
165	Block intake OFF	1. Check wiring and correct any errors. 2. Inspect the Block Intake Switch to make sure it is working correctly. 3. Reset and sequence the module. 4. During Standby and Purge, measure the voltage across the switch. Supply voltage should be present. If not, the Block Intake Switch is defective and needs replacing. 5. If the fault persists, replace the relay module.	L
166-171	RESERVED		
172	Main relay feedback incorrect	Internal Fault. 1. Reset Module.	L
173	Pilot relay feedback incorrect	2. If fault repeats, replace module.	L
174	Safety relay feedback incorrect		L
175	Safety relay open		L
176	Main relay ON at safe start check		L
177	Pilot relay ON at safe start check		L
178	Safety relay ON at safe start check		L
179-183	RESERVED		
184	Invalid BLOWER / HSI output setting	1. Return to Configuration mode and recheck selected parameters, reverify and reset module.	L
185	Invalid Delta T limit enable setting	2. If fault repeats, verify electrical grounding.	L
186	Invalid Delta T limit response setting	3. If fault repeats, replace module.	L
187	Invalid DHW high limit enable setting		L
188	Invalid DHW high limit response setting		L
189	Invalid Flame sensor type setting		L
190	Invalid interrupted air switch enable setting		L
191	Invalid interrupted air switch start check enable setting		L
192	Invalid igniter on during setting		L
193	Invalid ignite failure delay setting		L
194	Invalid ignite failure response setting		L
195	Invalid ignite failure retries setting		L

Code	Description	Recommended Troubleshooting of Lockout Codes	Code
196	Invalid ignition source setting		L
197	Invalid interlock open response setting		L
198	Invalid interlock start check setting		L
199	Invalid LCI enable setting		L
200	Invalid lightoff rate setting		L
201	Invalid lightoff rate proving setting		L
202	Invalid Main Flame Establishing Period time setting		L
203	Invalid MFEP flame failure response setting		L
204	Invalid NTC sensor type setting		L
205	Invalid Outlet high limit response setting		L
206	Invalid Pilot Flame Establishing Period setting		L
207	Invalid PII enable setting		L
208	Invalid pilot test hold setting		L
209	Invalid Pilot type setting		L
210	Invalid Postpurge time setting		L
211	Invalid Power up with lockout setting		L
212	Invalid Preignition time setting		L
213	Invalid Prepurge rate setting		L
214	Invalid Prepurge time setting		L
215	Invalid Purge rate proving setting		L
216	Invalid Run flame failure response setting		L
217	Invalid Run stabilization time setting		L
218	Invalid Stack limit enable setting		L

Code	Description	Recommended Troubleshooting of Lockout Codes	Code
219	Invalid Stack limit response setting		L
220	Unconfigured Delta T limit setpoint setting		L
221	Unconfigured DHW high limit setpoint setting		L
222	Unconfigured Outlet high limit setpoint setting		L
223	Unconfigured Stack limit setpoint setting		
224	Invalid DHW demand source setting		L
225	Invalid Flame threshold setting		L
226	Invalid Outlet high limit setpoint setting		L
227	Invalid DHW high limit setpoint setting		L
228	Invalid Stack limit setpoint setting		L
229	Invalid Modulation output setting		L
230	Invalid CH demand source setting		L
231	Invalid Delta T limit delay setting		L
232	Invalid Pressure sensor type setting		L
233	Invalid IAS closed response setting		L
234	Invalid Outlet high limit enable setting		L
235	Invalid Outlet connector type setting		L
236	Invalid Inlet connector type setting		L
237	Invalid DHW connector type setting		L
238	Invalid Stack connector type setting		L
239	Invalid Header connector type setting		L
240	Invalid Outdoor connector type setting		L

Date: 8-4-2010
Revision: 0
Form: 2396

Code	Description	Recommended Troubleshooting of Lockout Codes	Code
241-255	RESERVED		

Section 3 Care and Maintenance



WARNING:

The boiler area should be kept free of combustibile materials, gasoline and other flammable liquids.

The boiler and venting system must be kept free of obstructions of the air louvers.

The following procedures must be conducted as outlined to prevent damage to and assure safe operation of the boiler.

All cover plates, enclosures, and guards must be in place at all times, except during maintenance and servicing.

3.1 CLEANING THE BOILER AND SYSTEM – NEW SYSTEMS

3.1.1 PRE-BOIL OUT FLUSHING OF SYSTEM

Much of the dirt and contamination in a new hot water system can be flushed out before the boil out of the system. First, flush the system of waste with clear water. The boiler and circulating pumps must be isolated through the successive zones of the system to waste, carrying metal shavings, dirt, pipe joint compound, etc. with it. Follow with a chemical flush. NOTE! Be CERTAIN that the chemicals used to flush and boil-out the boiler and system contain NO CHLORIDES. The boiler is fabricated with austenitic stainless steels that can be severely damaged when exposed to chlorides. The removal of pipe chips and other debris from the system before opening the isolation valves to the boiler and pumps will help to protect this equipment from damage by such debris.

In combination with system contamination, bacteria from ground water boiler water may produce objectionable odors, sometimes resembling the odorant used in natural gas. It is

important to keep these fumes from air intakes that would distribute them throughout the building.

3.1.2 BOIL OUT PROCEDURE

The boil out of the boiler and system is neither difficult nor expensive. The chemicals needed for cleaning are readily available. Tri-sodium phosphate, and sodium hydroxide (lye) are the most commonly used chemicals. Be certain the chemicals used contain NO CHLORIDES. Use only one type of solution in the system. The amount of chemical required will vary according to conditions, but one pound per fifty gallons of water is suggested.

Fill the system with this solution, venting all air. Then, with the circulating pump running, bring the system to design or operating temperature. After circulating water for two to three hours, the system should be drained completely, and refilled with fresh, softened water. Usually enough of the cleaning solution will adhere to the piping to result in an alkaline solution satisfactory for operation. A pH reading between 7 and 8 is preferred. If necessary, to increase the pH, a small amount of cleaner may be added.



WARNING:

The boil out procedure outlined must be performed by, or under the direct supervision of, a qualified technician. The chemicals used present a hazard of burns and physical injury if mishandled. Always use a suitable facemask, goggles, protective gloves, and garments when handling caustic chemicals. Do not permit the chemical to come into contact with skin or clothing. Always follow the safety precautions on the container's label. Add chemicals slowly and in small amounts to prevent excessive heat and agitation.

3.1.3 DRAINING THE SYSTEM

A clean neutral hot water system should not be drained, except for an emergency or when unavoidable for servicing of equipment. See Section 3.3 for water treatment required when refilling.

3.2 REPLACEMENT BOILER INSTALLATIONS: PROTECTION AGAINST CORROSION AND SEDIMENT

Clean or replace all system piping and heating units

Arrange for chemical or mechanical cleaning of the entire system. A chemical treatment company should be consulted for the proper means of any chemical cleaning.

Replace any piping that is deteriorated beyond safe or cleanable condition.

Flush the system clean, being certain to isolate the boiler.



WARNING:

**DO NOT FLUSH THE SYSTEM
THROUGH THE BOILER.**

For some old systems, there is a reluctance to clean the piping because of possible leaks occurring in badly corroded lines. Should the customer refuse cleaning, it is necessary to install filtration equipment. Install either a fibrous filter or a centrifugal filter in the boiler return piping. This will collect and remove sediment from the system. A booster pump may be required to overcome the additional pressure drop introduced in the line by the filter. When filling the system, provide chemical treatment as outlined in Section 3.3.

Failure to properly clean the system or to install mechanical sediment removal equipment can result in tube blockage and severe corrosion plus damage to pumps, controls, and air removal devices.

Inspect, repair as necessary, or replace system air control devices.

Install gauge glasses on air expansion tanks and install a tank fitting in the system connection to

the tank.

Install a strainer in the boiler return piping.

3.3 BOILER WATER TREATMENT

Purpose of water treatment

Water treatment is required for satisfactory operation of the boiler. It must be devised to prevent depositing of scale and corrosion from acids, oxygen and other such harmful elements that may be in the water supply. A qualified water treatment chemist should be consulted and the water systematically treated.

Objectives

The basic objectives of water treatment are:

Prevent the accumulation of scale and deposits in the boiler.

Remove dissolved gases from the water.

Protect the boiler against corrosion.

Maintain the highest possible boiler fuel efficiency.

Decrease the amount of boiler down time from cleaning.

Water softener

It is highly recommended that a zeolite water softener be used for all make-up to the boiler. It is intended that this be used in addition to the chemical treatment of the boiler. Water softening removes calcium and magnesium, the primary causes of hard boiler scale.

Continuous monitoring required

Water treatment should be checked and maintained whenever the boiler is operating. The boiler operator should be sure that the boiler is not operating for long periods without proper water treatment.

Water treatment may vary from season to season or over a period of time. Therefore, the water treatment procedure should be checked not less than four times a year, and possibly more frequently as the local water conditions may indicate.

It should be noted that water boilers may well need chemical treatment for the first filling plus additional periodic chemical treatment, depending on system water losses and the makeup requirements.

Water treatment may vary from season to season or over a period of time. Therefore, the water treatment procedure should be checked

not less than four times a year, and possibly more frequently as the local water conditions may indicate. All water introduced into the boiler should be softened and should include an oxygen scavenger like sodium sulfite. This is required to remove dissolved oxygen from the water. Dissolved oxygen will cause severe boiler tube corrosion.

Draining and refilling the boiler & system

If the system is drained and then refilled, chemical treatment is essential to treat the raw water. Use only clean, softened water.

3.4 EXTERNAL “FIRE-SIDE” CLEANING

Purpose

Carbon (soot) is an insulator and corrosive. The heating surfaces of a boiler must be kept free from soot accumulation to keep the boiler operating at its highest efficiency and to avoid damage from corrosion.

Soot removal

If the yearly inspection of the boiler tube surfaces reveals a build-up of soot or rust (usually due to condensation), the tubes should be thoroughly brushed. (Tube cleaning brushes are available from Bryan Steam) To inspect and, if necessary, clean the tube surfaces and flue collector, first remove the tube access panels. Examine the exterior of the tubes for evidence of soot or rust. Using a flashlight, carefully look between the tubes. There should be an unobstructed opening between all tubes, and the top surfaces of the tube must be free from soot accumulation. Also inspect the interior of the flue collector. Brush or vacuum the soot from all surfaces. Be sure to cover Triple-Flex burner with a protective cover during cleaning to prevent soot from falling onto it.

If the buildup of soot is appreciable, the flue gas venting system must be thoroughly inspected internally as well, and cleaned as necessary.



WARNING:

If soot or condensation is apparent, a boiler service technician should be consulted. The presence of soot indicates poor combustion and possibly hazardous boiler operation. Failure to do so may result in fire, explosion potential, or asphyxiation. A combustion test and burner adjustments should be undertaken at once.

3.5 SUGGESTED MAINTENANCE SCHEDULE

Daily

1. Make visual inspection of gauges, monitors, and indicators and record readings in boiler log.
2. Make visual check of instrument and equipment settings against factory recommended specifications.
3. Check operation of probe type low water cutoff(s) to ensure control is functioning.

Weekly

1. Confirm boiler area is free of combustible materials and that there is nothing obstructing air openings, draft hood relief openings, etc.
2. Check combustion safety controls for flame failure and flame signal strength as specified in manufacturer's instructions located at the back of this manual.
3. Check all limit controls.
4. Check low water cutoff as described above.

Monthly

1. Check high and low gas pressure interlocks. Refer to manufacturer's instructions for correct procedure.

Annually

1. The flue gas passages and the exterior surfaces of the boiler tubes should be

inspected at least annually. Any accumulation of soot or debris should be thoroughly cleaned out.

2. If the yearly inspection of the boiler tube surfaces reveals a build-up of soot (carbon), the tubes surfaces should be thoroughly brushed. Failure to do so may result in fire or asphyxiation hazards.
3. The boiler pressure vessel and piping should be checked annually.

Date: 8-4-2010
Revision: 0
Form: 2396

Section 4 Lead Lag

There are parameters that are available to set the features for Lead Lag.

Many of the descriptions used are internal functions or tables. The names help define the functions but are not controlled or selectable outside Sola, unless noted as a parameter.

4.1 GENERAL DESCRIPTION OF THE LEAD LAG APPLICATION

Sola devices contain the ability to be a stand alone control, operate as a Lead Lag Master control which also uses the Sola control function as one of the slaves or to operate solely as a slave to the lead lag system. Conceptually it is not a part of that specific control, but is an entity that is "above" all of the individual Sola controls (including the one that hosts it). The master sees each slave (including the one that hosts it) as a set of Modbus devices, each having certain registers, and in this regard it is entirely a communications bus device, talking to the slave Sola controls via Modbus.

Sola devices utilize two 'ModBus™' ports (MB1 and MB2) for communications. One port will be designated to support a system S7999B display and the other port will support communications from the LL Master with its slaves. The diagram on page 4 shows a simplified wiring diagram connecting the system display with a 4 system Lead Lag arrangement.

The Lead Lag master is a software service that is hosted by a Sola control.

The LL master uses a few of the host Sola's sensors (header temperature and outdoor temperature) and also the STAT electrical inputs in a configurable way, to provide control information.

4.2 LEAD LAG (LL) MASTER GENERAL OPERATION

The LL master coordinates the firing of its slave Solas. To do this it must add stages and drop them to meet changes in load, and it sends firing rate commands to those that are firing.

The LL master turns the first stage on and eventually turns the last stage off using the same criteria as for any modulation control loop. When the operating point reaches the Setpoint minus the On hysteresis, then the first Sola is turned on. When the operating point reaches the Setpoint plus the Off hysteresis then the last slave Sola (or all slave Solas) are turned off.

The LL master PID operates using a percent rate that is, 0% is a request for no heat at all, and 100% means firing at the maximum modulation rate.

This firing rate sent to the slaves as a percentage, but this is apportioned to the slave Solas according to the rate allocation algorithm selected by the **Rate allocation method** parameter.

For some algorithms this rate might be common to all slave Solas that are firing. For others it might represent the total system capacity and be allocated proportionally.

For example, if there are 4 slaves and the LL master's percent rate is 30%, then it might satisfy this by firing all four slaves at 30%,
Or
by operating the first slave at 80% (20% of the system's capacity) and a second slave at 40% (10% of the system's capacity).

The LL master may be aware of slave Sola's minimum firing rate and use this information for some of its algorithms, but when apportioning rate it may also assign rates that are less than this. In fact the add-stage and drop-stage algorithms may assume this and be defined in terms of theoretical rates that are possibly lower than the actual minimum rate of the Sola control. In any case a Sola that is firing and is being commanded to fire at less than its minimum modulation rate will operate at its minimum rate: this is a standard behavior for a Sola control in stand-alone (non-slave) mode.

If any slave under LL Master control is in a Run-Limited condition, then for some algorithms the LL master can apportion to that stage the rate that it is actually firing at.

Additionally when a slave imposes its own Run-limited rate this may trigger the LL

Master to add a stage, if it needs more capacity,

or drop a stage if the run-limiting is providing too much heat (for example if a stage is running at a higher-than commanded rate due to anti-condensation).

By adjusting the parameters in an extreme way it is possible to define add-stage and drop-stage conditions that overlap or even cross over each other. Certainly it is incorrect to do this, and it would take a very deliberate and non-accidental act to accomplish it. But there are two points in this:

LL master does not prevent it, and more important;

it will not confuse the LL master because it is implemented as a state machine that is in only one state at a time; for example:

- if its add-stage action has been triggered, it will remain in this condition until either a stage has been added, or
- the criteria for its being in an add-stage condition is no longer met; only then will it take another look around to see what state it should go to next.

Assumptions:

Modulating stage The modulating stage is the Sola that is receiving varying firing rate requests to track the load.

First stage This is the Sola that was turned on first, when no slave Solas were firing.

Previous stage The Sola that was added to those stages that are firing. Just prior to the adding of the Sola that is under discussion.

Next stage The Sola that will or might be added as the next Sola to fire.

Last stage The Sola that is firing and that was added the most recently to the group of slaves that are firing. Typically this is also the modulating stage, however as the load decreases then the last-added stage will be at its minimum rate and the previous stage will be modulating.

Lead boiler The Lead boiler is the Sola that is the first stage to fire among those stages which are in the equalize runtime (Lead/Lag) group. If a boiler is in the "Use first" group it may fire before the Lead boiler fires.

First boiler A Sola may be assigned to any of

three groups: "Use First", "Equalize Runtime", or "Use Last". If one or more Solas are in the "Use First" category, then one of these (the one with the lowest sequence number) will always be the first boiler to fire. If there is no Sola in the "Use First" category and one or more are in the "Equalize Runtime" category, then the First boiler is also the Lead boiler.

Add-stage method

Add-stage detection timing

Add-stage request An **Add-stage method** implements the criteria for adding another stage. Criteria that may apply are the firing rate of a stage or stages vs. a threshold, the amount of operating point versus setpoint error seen by the master, the rate at which setpoint error is developing, and the rate at which a stage or stages are approaching their maximum or baseload firing rate.

Typically these use **Add-stage detection timing** to determine how long these things have persisted. When all criteria have been met for a sufficient time, then an **Add-stage request** is active.

Drop-stage method

Drop-stage detection timing

Drop-stage request A **Drop-stage method** implements the criteria for dropping a stage. Criteria that may apply are the firing rate of a stage (or stages) vs. a threshold, the amount of operating point versus setpoint error seen by the master, the rate at which setpoint error is developing, and the rate at which a stage or stages are approaching their minimum firing rate.

Typically these use **Drop-stage detection timing** to determine how long these things have persisted. When all criteria have been met for a sufficient time, then an **Drop-stage request** is active.

4.3 SYSTEM WIRING HOOKUP

LEAD LAG MODBUS ————
 ENHANCED MODBUS - - - - -
 FACTORY WIRING _____

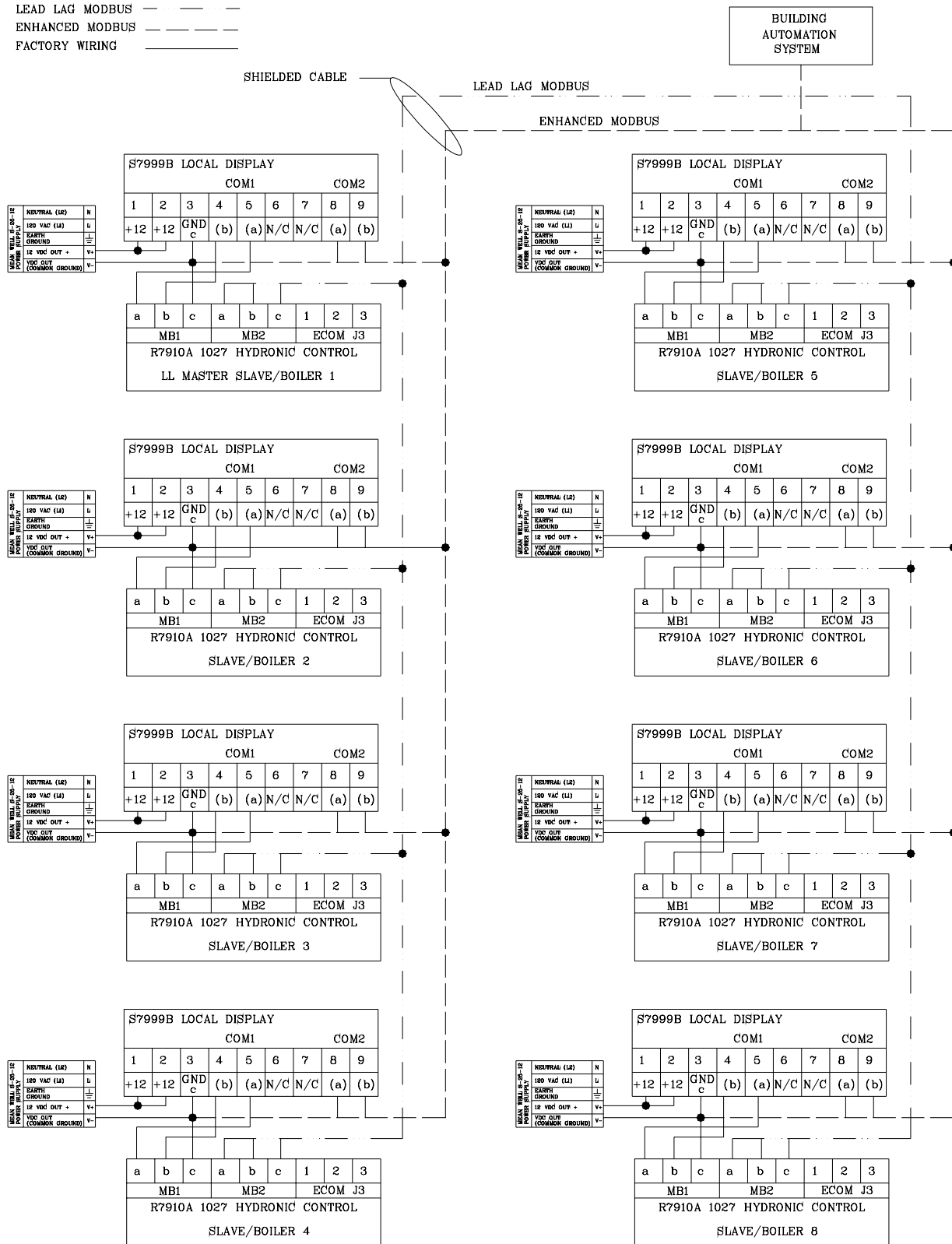

Figure 40 LL / Multi-Boiler Field Wiring

4.4 LEAD-LAG OPERATION

This is a summary of the functional capability of the embedded lead-lag on the Sola control. OEM Configurable parameters may be adjusted as part of the OEM factory configuration and in the field using the System Display with appropriate password permissions. Specific parameters may also be configured in the field by the local display.

1. Field Installation Configuration

a. The master and slave controllers are enabled via the S7910 or S7999 display.

b. All Sola controllers are programmed with a default address of 1. Assuming the Master Sola controller remains address 1, the address of the slave controllers in the system must have a unique address (1..8) via the local display.

2. Basic Operation

a. Firing rate determination – Parallel common-base limited

(1) All boilers have a single assignable base load firing rate.

(2) Allocation

(a) As load increases:

(i) Until all stages are Firing - No stage is requested to exceed the common base load rate.

(ii) After all stages are Firing - There is no restriction on the slave's commanded firing rate.

(b) As load decreases:

(i) As long as all available stages are firing - There is no restriction on the slave's commanded firing rate.

(ii) When at least one stage has been dropped - No stage is requested to exceed the common base load rate.

b. Rotation

(1) The lead boiler is rotated based sequence order. The lead boiler rotation time is a configurable OEM assigned parameter. Rotation is sequential by address (1-2-3-4; 2-3-4-1; etc.)

(2) Rotation trigger occurs at the start of each new heat cycle.

c. Source of heat for call – The call for heat originates at the master boiler. This source may be configured to be an external thermostat or via EnviraCOM Remote Stat.

d. Slave boiler lockout – If any slave is in lockout the master boiler will cause it to be skipped and all system load setting calculation settings will be based only on available boilers.

e. Master boiler lockout – If the master boiler is in lockout then its burner control function will be skipped in the rotation the same as the slave controllers. However, the master boiler function will continue to operate.

3. System Component Failure Responses

a. If the system header sensor becomes disconnected from the master boiler then the master boiler will control off of one of the following OEM configurable actions

(1) Disable - No backup will

be used

(a) Lead Outlet - Outlet temperature of the lead boiler will be used as the backup during firing

(i) Slave Outlet Average - Average of the outlet temperatures of all slave boilers that are firing will be used as a backup

(b) If the sensor chosen by the above parameter is faulty then the backup sensor provided may be used. When burner demand is off and no burners are firing then, for either "Lead Outlet" or "Slave Outlet Average", the lead boiler's outlet temperature is used to monitor for burner demand.

4. Local Display Configuration and Operation

a. The configuration parameters available on the local display are edited in the Service Mode

b. Access to the Service Mode is accomplished by pressing both up/down buttons for 3 seconds.

c. Status and Operation

(1) Slave status

(a) "Rmt" and "Adr" icons are on to show slave (follower) has been enabled.

(b) Current burner status is shown

(c) To show slave CFH

(i) Alternate "%" firing rate and actual (slave) Outlet temp to indicate slave CFH otherwise show the Home screen.

(2) Master status

(a) Rmt icon is on, Adr icon is off to show Master (Leader) has been enabled.

(b) Current burner status is shown

(c) Actual temperature LL (Header) temperature is shown as described in 4e below.

(d) Pressing the up/down buttons allows setpoint adjustment for LL-CH only (not LL-DHW or LL-Mix or others).

(i) All pump configurations must be done using the PC Configuration tool in the OEM factories.

(e) To show Master CFH

(i) Alternate "CH" or "LL" or "Hdr" in numbers field with the actual temperature to indicate LL CH CFH.

d. Configuration

(1) Continue scrolling through set-up screens until "Remote Firing Control" screen is reached.

(2) Rmt On/Off selection chooses to navigate the user through the Master/Slave configuration as existing today

(3) Set master/slave remote address as is done on currently on the local display.

(4) The following parameters are mapped to Modbus addresses.

LEAD LAG 5 66—A1171

(a) "LL" = LL Operation (3 user selections available)

(i) "Ldr"

(i-a) Master Enable

(i-b) Slave Enable

(ii) "SLA"

(ii-a) Slave Only Enable

(ii-b) Master Disable

(i) "OFF"

(iii-a) Master Disable

(iii-b) Slave Disable

(b) HS = On/Off Hysteresis (One value used for all LL boilers)

(i) "HS" for on and off hysteresis values.

(i-a) Only allow 1 setting for both on and off hysteresis values.

(a-1) Must adhere to the strictest of either the HS On or Off limits.

• Highest value of the "low" range limit in Sola control

• Lowest value of the "high" range limit in Sola control

(a-2) See Sola Modbus specification for details.

• Typical values: 2-15

(c) BL =

Baseload common (i) "BL" for baseload (ii) User selection 0 – 100 % (d) Use existing timeout, Done button, and Next button functionality to enter these parameters. (e) User selections will be selected by MMI. (i) The local display does not adhere to the PCB (OEM parameter selections used by S7999). (5) In normal display operation the display allows a user to scroll through a list of temperatures with associated icons (CH, Inlet, Delta, DHW, Stack, Outdoor) using the Next button. With LL active the display will show the header temperature at the end of the list of temperatures as follows: (a) The characters "LL" are displayed in the number field (b) When the next button is pressed again the temperature is displayed. (c) If the Up or Down buttons are pressed then the LL set-point is changed.

5. System Display Configuration – The following parameters are available for OEM configuration and may be adjusted through a System Display or programmed at the OEM production facility. **Master Sola Slave Sola** LL frost protection enable Slave mode LL frost protection rate Base load rate Base load rate Slave sequence order LL CH demand switch LL Demand to firing delay LL CH set point source LL Modulation sensor LL Base load common LL Modulation backup sensor LL CH 4mA water temperature LL Lead selection method LL CH 20mA water temperature LL Lag selection method LL Add stage method 1 LL Add stage detection time 1 LL Add stage error threshold LL Add stage rate offset LL Add stage inter-stage delay LL Drop stage method 1 LL Drop stage detection time 1 LL Drop stage error threshold LL Drop stage rate offset LL Lead rotation time LL Force lead rotation time LL Drop stage inter-stage delay

4.5 SLAVE OPERATION AND SETUP

Slave Data Supporting Lead Lag

This data is provided by each slave Sola control to support operation when a LL master exists. The illustration below summarizes the slave's registers and data:

LL Slave

Some slave changes relate to pump control, frost protection, and also are available to 3rd party (non Sola) LL master devices. The generic LL slave is updated to operate as shown by the

diagram below:

Frost protection requests

The frost protection in this status register will be set or cleared to match the status generated by the frost protection detection functions.

Firing for local frost protection This provides indication to the LL master that although the burner is firing independently, it is doing so for frost protection and thus is still available as a lead/lag slave. This is set when 1) frost protection is controlling the Sola per the priority scheme (which occurs only if frost protection is enabled), and 2) burner demand is true and the burner is currently firing or preparing to fire to serve that demand. Otherwise it will be clear.

Aux Pump X, Y, and Z The pump control in the Slave can be used by previously existing command devices to create the same behavior. However before these bits controlled actions is specific pump blocks, they are now more general. The pump X, Y, and Z bits control actions in any pump block defined to handle them (see the pump control block definition).

4.6 SLAVE PARAMETERS

SLAVE ENABLE: DISABLE, ENABLE VIA MODBUS, ENABLE FOR SOLA MASTER

It enables or disables the "LL Slave" Demand and Rate module. If the slave mode is set to Disable then: none of the slave functions are active, **Slave Status** register is zero, the **LL – Master Service Status** register is not writable and is held at zero (this is important for pump control which might otherwise use values in this location). The **Slave Command** register is writable but it is mostly ignored, however the Aux pump X, Y, and Z are effective for any setting of the **Slave enable** parameter. The **Enable for Sola Master** option **Slave write** and **Slave read** parameters; if "Enable for Sola Master" is not selected, then these parameters are disabled.

SLAVE MODE: USE FIRST, EQUALIZE RUNTIME, USE LAST

If set to Use First, then this Sola will be used prior to using other Solas with other values. If set to Equalize Runtime, then this Sola will be staged according to a run time equalization

algorithm. (Any Solas set to Use First will precede any that are set to Equalize Run time.) If set to Use Last, then this burner will be used only after all Use First and Equalize Runtime Solas have been brought online.

SLAVE SEQUENCE ORDER: 0-255

Slave sequence order is used to determine the order in which Solas will be used (staged on) for those Solas which the same Slave mode setting. Numbers may be skipped, that is 3 will be first if there is no 1 or 2. Note: For Equalize Runtime purposes, 1 does not mean the Sola will be used first every time; that will vary over time based on the master's run time equalization scheme. In this case the sequence number determines the relative order in which Sola controls will be used in a round-robin scheme. If the slave sequence number value is zero, then the slave Sola's ModBus address will be used instead. If two Solas which are set the same mode both have the same sequence number then an alert will occur and the order in which they are used will be arbitrary and is not guaranteed to be repeatable.

DEMAND-TO-FIRING DELAY: MM:SS OR NONE

This delay time is needed by the LL master to determine the length of time to wait between requesting a slave Sola to fire and detecting that it has failed to start. It should be set to the total time normally needed for the burner to transition from Standby to Run, including such things as transition to purge rate, prepurge time, transition to lightoff rate, all ignition timings, and some extra margin.

BASE LOAD RATE: RPM OR %

This specifies the preferred firing rate of a burner, which is used for some types of control algorithms.

FAN DURING OFF-CYCLE RATE: RPM OR % (0=DISABLE)

This determines if or where the fan is to be operating during the standby period.

4.7 LL MASTER OPERATION AND SETUP

LL master operation is subdivided into the following functions:

- **Overall control** - The LL master has

parameters that enable and disable its operation.

- **Periodic data polling** - The LL master uses polling to discover new slave Sola devices and to periodically refresh the information it has about a known slave Sola devices.

- **Slave control** - the LL master sends each active slave a command and also performs a slave status read for each known slave device. It also sends a Master status broadcast that is heard by all slaves.

- **Slave status manager** - The LL master keeps track of slave status for each Sola that is enabled as a slave device.

- **Demand and priority** - different sources of demand can cause the LL master to operate in different ways. These sources have a priority relationship.

- **Modulation** - each demand source has one or more setpoints that may be active and an operation sensor. These are used to detect turn-on and turn-off conditions. The difference between operating point and setpoint determines the LL master's firing rate.

- **Stager** - the stager determines when slave Solas should turn on as the need for heat increases, and when they should turn off as the need for heat decreases.

Rate allocation - the PID block's output is used to determine the firing rate of each slave Sola using various rate allocation techniques.

- **Add-stage methods** - various methods can be used to determine when a new stage should be added.

- **Drop-stage methods** - various methods can be used to determine when a stage should be dropped

- **Sequencer** - the Sola sequencer determines which Sola will be the next one to turn on or turn off.

4.7.1 OVERALL CONTROL

LL MASTER ENABLE: DISABLE, ENABLE, LL MASTER MODBUS PORT: MB1, MB2 If

Disable is selected then all LL master functions are inactive. If Enable is selected then it acts as the active bus master on the ModBus port it is assigned. **LL OPERATION SWITCH: OFF, ON**

This controls the LL master in the same way that the Burner switch controls a stand-alone Sola. If "On" then the LL master is enabled to operate. If this parameter is "Off" then the LL master turns

off all slaves and enters an idle or standby condition.

4.7.2 PERIODIC DATA POLLING MESSAGES

The LL master uses polling to discover new slave Sola devices and to periodically refresh the information it has about a known slave Sola devices. Thereafter it polls the known devices to make sure they are still present and to obtain updated status information. It also periodically polls the entire slave address range to discover any new slave devices. A polled Sola is read to determine the values of the following data items:

- The slave's type (compatibility) as indicated by the **Slave type**
- The slave enable status **Slave enable**
- The slave mode as set in **Slave mode**
- The slave sequence order as set in **Slave sequence order**
- Demand-to-firing delay: mm:ss or None** This delay time is needed by the LL master to determine the length of time to wait between requesting a slave Sola to fire and detecting that it has failed to start. It should be set to the total time normally needed for the burner to transition from Standby to Run, including such things as transition to purge rate, prepurge time, transition to lightoff rate, all ignition timings, and some extra margin.
- CT - Burner run time** This parameter will be needed if measured run-time equalization is being used.

Slave Control

The LL master sends each active slave a command and also performs a slave status read for each known slave device. It also sends a Master status broadcast that is heard by all slaves. There are 5 commands that might be sent:

- All slaves are commanded to turn off and remain off.
- The LL master sends message to Solas that are off, to turn their fans on.
- The LL master suspends operation which request a burner to recycle and remain in Standby if it has not yet opened its main valve (e.g. it is in Prepurge or PFEP) but to keep firing if it has reached MFEP or Run. This suspend may be for the fan to be on or off in standby. This message is used to abort the startup of a slave that is not yet firing (because demand went away just before it was firing), but to keep it on if it actually is firing (the LL master will

discover what happened in a subsequent status response). The LL master also sends this message to a slave that is OnLeave. (This ensures that if the slave is firing when it returns to LL master control, it will stay that way until the master has decided whether to use it; or conversely, if the slave stops firing for some reason that it will not start up again until the LL master has requested this. In either case, the command will be to turn on the off cycle fan if any other slave burners are firing, or to turn the fan off if the slave is the only slave that might (or might not) be firing.

- The LL master sends message to turn the burner on and to assign the burner's firing rate. If the commanded modulation rate is less than the burner's minimum modulation rate, then the burner should always operate at its minimum rate.

4.7.3 SLAVE STATUS MANAGER

The LL master keeps track of slave status for each Sola that is enabled as a slave device. The slave status manager operates internally for each slave Sola devices (up to 8). There is a table entry for each device containing the following data:

- **SlaveState:**
 - Unknown - indicates the table entry is unused and empty
 - Available - indicates the slave is OK and ready to use, but is not currently firing as a slave
 - AddStage - stage is getting ready to fire
 - SuspendStage - stage was getting ready but is not needed
 - Firing - indicates the slave is currently firing
 - OnLeave - indicates the slave is operating for some other demand source within it that has higher priority than slave demand.
 - Disabled - indicates the slave is locked out or disabled in some way
 - Recovering - indicates the slave is in a time delay to ensure that it is OK before it is again considered to be available.
- **RecoveryTime:** Saves how long the slave must be OK to recover.
- **RecoveryTimer:** Used to measure the slaves recovery time
- **RecoveryLimitTimer:** Enforces a maximum slave recovery time
- **DataPollFaultCounter:** Used to tolerate

momentary communication problems and to act on these if they are excessive. • **StatusReadFaultCounter**: Used to tolerate momentary communication problems and to act on these if they are excessive.

- **AbnormalFaultCounter**: Used to tolerate momentary abnormality
- **StagingOrder**: Used to record the stage-on order, for use by the sequencer when it needs to drop a stage.
- Storage for each item described in the Periodic data polling section
- Storage for each item described in the Slave status read response section
- Slave Command - the command word from the master to the slave.

Features common to all states

- Whenever a slave Sola device is not in an expected condition then a recovery function is used to set up timers to give a faulty slave: — minimum time that it must appear to be OK, and — limit how long a slave has to recover from any error.
- If the slave status read was bad then the slave's **FaultCounter** is incremented and if it reaches the fault value tries, then a recovery action is invoked. This action does nothing else if the status read was Bad. If the slave status read was OK then the status function puts the slave read response data in a slave status table. If a transition to another state is indicated then the **SlaveState** is simply set to the indicated state.

Data poll response handling

Valid Response Message

When a slave Sola responds with a properly formatted message it is examined to see if **Slave enable** value is "Enable for Sola Master".

- If the "Enable for Sola Master" value is not present then the slave status table is checked and if the slave is not in the table then the message is ignored (this is normal). However if the slave is in the table then the message is stored as usual and the slave will invoke the action as a disabled slave and cause recovery action to occur.
- If the "Enable for Sola Master" value is present then the slave status table is checked and if the slave is not in the table then the slave data is stored in an empty position in the table. However if the slave is in the table then the message is stored as usual (this is the normal case).

INVALID RESPONSE OR NO RESPONSE

When a Sola responds to a data poll with an improperly formatted message or it does not respond then the slave status table is checked and: If the polled slave device is in the table then the **Data Poll Fault** is noted. If this causes a fault counter to exceed the fault value then the SetRecovering handling is invoked.

SlaveState states

Recovering A slave that is recovering is checked once per second. If the slave has recovered the **SlaveState** table is changed to Available. If the slave has not yet recovered when its recovery timer reaches the **RecoveryTimeLimit** then: If the slave is not enabled for the Sola LL master its **SlaveState** table is Set to Unknown (which logically removes it from the slave table). Otherwise the **Recovery- LimitTimer** is cleared which starts a new recovery measurement and the slave remains in recovery (indefinitely).

Available A slave in the Available state remains that way until the Stager moves it into the AddStage state or the ProcessSlaveStatus action moves it to some other state.

AddStage A slave in the AddStage state remains that way until the ProcessSlaveStatus moves it to Firing or some other state, or the Stager times out and moves it into the Recovering state if it fails to fire.

SuspendStage A slave in the SuspendStage state remains that way until the ProcessSlaveStatus moves it to some other state, or the Stager times out and moves it into either the Firing or the Available state.

Firing A slave in the Firing state remains that way until the ProcessSlaveStatus moves it to some other state, or the Stager drops the stage and moves it into the Available state.

OnLeave A slave in the OnLeave state remains that way until the ProcessSlaveStatus moves it to some other state.

Disabled A slave in the Disabled state remains that way until the ProcessSlaveStatus moves it to Recovering.

Demand and Priority

Different sources of demand can cause the LL master to operate in different ways. These sources have a priority relationship.

CH Demand

LL CH DEMAND SWITCH: DISABLE, STAT, ENVIRONCOM REMOTE STAT

The inputs that can function as the CH demand switch are: STAT, EnvironCOM Remote Stat. If the CH demand switch value is Disable, the LL master does not respond to CH demand.

Warm Weather Shutdown

WARM WEATHER SHUTDOWN ENABLE: DISABLE, SHUTDOWN AFTER DEMANDS

HAVE ENDED, SHUTDOWN IMMEDIATELY
WARM WEATHER SHUTDOWN SETPOINT:

TEMPERATURE OR NONE

When warm weather shutdown is Disabled then it has no effect (i.e. the Warm Weather Shutdown (WWSD) status shown on the priority diagram is false).

These two parameters are shared by the stand-alone Sola control and the LL master and have the same effect for either control.

This function requires the outdoor temperature. This temperature may be obtained from either a local sensor or a LL slave. If WWSD is enabled but the outdoor temperature is invalid and unknown, then the WWSD function acts as if it is disabled and has no effect and an alert is issued indicating an invalid outdoor temperature.

If it is enabled then it uses a 4°F (2.2°C) hysteresis:

If WWSD is false, then when the Outdoor temperature is above the value provided by **Warm weather shutdown setpoint** then:

If "**Shutdown after demands have ended**" is selected then any current CH demand that is present prevents WWSD from becoming true; that is if CH demand is false then WWSD becomes true.

Otherwise if "**Shutdown immediately**" is selected then WWSD becomes true, it immediately causes CH demand to end.

If WWSD is true, then when the Outdoor temperature is below the value provided by **Warm weather shutdown setpoint** minus 4°F (2.2°C) then WWSD becomes false.

When warm weather shutdown is true then:

New occurrences of CH demand is inhibited.
DHW demand is not affected.

Frost protection

LL master frost protection is enabled with **Frost protection enable: Disable, Enable**

The need for frost protection is actually detected independently by each slave which notifies the master whether frost detection occurred in CH frost detection, and/or its DHW frost detection, and whether it is severe enough to require burner firing as well as pump operation. This is done via its **Slave status** parameter.

If **Frost protection enable** is Enable then the master's **Slave write** message, will indicate CH or DHW frost protection or both as read from each slave's **Slave Status**. This will cause any slave pumps which are enabled to follow this status to turn on without any other action required from the master.

If any slave is indicating CH or DHW frost protection, and additionally that slave's **Slave status** register indicates burner firing is requested then the LL master's frost protection burner demand will be true.

If the priority scheme allows the master to honor this demand, then it will fire a single burner (the current lead burner as specified by the sequencer) at the rate indicated by **Frost protection rate: 0-100%**. (100% represents 100% firing of this boiler, and where 0% or any value less than the boiler's minimum firing rate represents the minimum firing rate).

Priority Control

CH heat demand is a simple signal such as STAT, Enviro- COM remote stat, or Warm Weather Shutdown.

Frost protection input to the priority logic is not a heat demand, it is a burner demand (because frost protection always turns on pumps without regard to the priority control - it is a priority item only if it also wants to fire).

Master Status

MASTER HEAT DEMAND

Is a data item which contains the status for the

following sources of demand. All sources that are currently calling for heat will be true (multiple items may be true at the same time) except when WWSD is active, then CH demand is inhibited.

CH Demand

CH Frost demand – true if any slave is calling for CH frost protection and **Frost protection enable** is true.

4.7.4 MASTER ACTIVE SERVICE

Is a data item which contains the identity of a single source of demand that the LL Master is currently serving according to its priority:

- None – no active service, LL master is idle
- CH
- Frost – burner demand is true for frost protection
- WWSD – no high priority demand is active, and WWSD is inhibiting CH demand (if any).

MASTER SERVICE STATUS

Is a data item used by pump control logic that combines the Master Heat Demand and Master Active Service data. It is implemented as described by the Pump Control Block diagram.

Outdoor Temperature

For a Sola that hosts a LL master, the outdoor temperature may be known from either of two sources. If the host Sola has an outdoor sensor that is reporting a valid temperature then this sensor reading is used. Otherwise, if any slave Sola is reporting a valid temperature as part of its Data Poll message, then this temperature is used.

The resulting outdoor temperature provides all outdoor temperature needs for both stand-alone and LL master purposes. If neither source has a valid temperature then the outdoor temperature is simply invalid and unknown, and the functions which need this information handle it accordingly per their individual definitions.

Modulation

Each demand source has one or more setpoints that may be active and an operation sensor.

These are used to detect turn-on and turn-off conditions. The difference between operating point and setpoint determines the LL master's firing rate

4.7.5 MODULATION SENSOR

LL MODULATION SENSOR: S5

The LL master's modulation sensor uses the S5 sensor (connector J8 terminal 11 and 12). If the LL master is enabled and its sensor is faulty then an alert will be issued.

LL MODULATION BACKUP SENSOR: DISABLE, LEAD OUTLET, SLAVE OUTLET AVERAGE

If the sensor chosen by the **LL Modulation sensor** is faulty then the backup sensor provided here may be used.

If **Disable** is selected then no backup will be used.

If **Lead Outlet** is selected then the outlet temperature of the lead boiler will be used as the backup during firing.

If **Slave Outlet Average** is selected then average of the outlet temperatures of all slave boilers that are firing will be used as a backup. When the burner demand is off and no burners are firing then, for either **Lead Outlet** or **Slave Outlet Average**, the lead boiler's outlet temperature is used to monitor for burner demand.

Setpoints

LL CH SETPOINT SOURCE: LOCAL, S2 4-20MA

If the setpoint source is **Local** then the Sola control's local setpoint system is used. This setting enables the normal use of the CH setpoint, CH TOD setpoint, and the CH outdoor reset parameters and functions.

If the setpoint source is **S2 4-20mA** then the setpoint is determined by the 4-20mA input on S2, and the two parameters described below. If the 4-20mA signal goes out of range or is invalid, and this persists for a specified time, then the setpoint source reverts to "Local". In this case once it has gone to "Local", it remains

that way until the 4- 20mA signal is stable again.

LL CH 20MA WATER TEMPERATURE:
TEMPERATURE OR NONE

CH 4MA WATER TEMPERATURE:
TEMPERATURE OR NONE

These provide the 20mA and 4mA temperatures for the interpolation curve. If either of these have the None value, are invalid, are out of range, or are too close for interpolation, an alert is issued and the setpoint reverts to "Local" when it is selected as 4-20mA.

LL CH SETPOINT: DEGREES OR NONE

This setpoint is used when the time-of-day input is off. If the ODR function is inactive then the setpoint is used as-is. If the ODR function is active then this setpoint provides one coordinate for the outdoor reset curve.

LL CH TOD SETPOINT: DEGREES OR NONE

This setpoint is used when the time-of-day input is on. If the ODR function is inactive then the setpoint is used as-is.

If the ODR function is active then this setpoint provides one coordinate for the shifted (because TOD is on) outdoor reset curve.

TIME OF DAY

The Time of Day has one sources of control: a switch contact. Closed TOD is an on condition; open, then TOD is off.

OUTDOOR RESET AND BOOST (BOOST IS FUTURE)

The outdoor reset and boost functions for the LL CH functions will be implemented as described for a stand-alone CH loop.

Each of the loops which implements outdoor reset and boost has its own parameters. The parameters used by the LL master are:

- LL setpoint
- LL CH TOD Setpoint
- LL Outdoor reset enable: Disable, enable
- LL CH ODR minimum outdoor degrees or None
- temperature:
- LL CH ODR maximum outdoor degrees or None temperature:
- LL CH ODR low water temperature: degrees or None
- LL CH ODR boost time: mm:ss or None
- LL CH ODR boost max setpoint: degrees or

None

- LL CH ODR boost step: degrees or None
- LL CH ODR boost recovery step time:mm:ss or None

The outdoor reset function requires the outdoor temperature. This temperature may be obtained from either a local sensor or a LL slave as described earlier. If the outdoor temperature is invalid and unknown, then no outdoor reset action occurs and an alert is issued indicating an invalid outdoor temperature.

LL CH ODR MINIMUM WATER
TEMPERATURE: DEGREES OR NONE

This specifies the minimum outdoor reset setpoint for the LL master. If the outdoor reset function calculates a temperature that is below the temperature specified here, then this parameter's temperature will be used. If this parameter is invalid or None then the outdoor reset function will be inhibited and will not run: if it is enabled then an alert is issued.

4.7.6 DEMAND AND RATE

On/Off Hysteresis Includes hysteresis shifting at turn-on, turn-off

LL OFF HYSTERESIS: DEGREES OR NONE

LL ON HYSTERESIS: DEGREES OR NONE

The LL hysteresis values apply to all setpoint sources. The behavior of the hysteresis function is identical to the behavior of the stand-alone CH hysteresis function, except:

- where stand-alone CH hysteresis uses the on/off status of a single burner, the LL hysteresis uses the on/off status of all slave burners: this status is true if any slave burner is on, and false only if all are off.
- where stand-alone CH hysteresis uses time of turn-on and turn-off of a single burner, the LL hysteresis uses the turn-on of the first slave burners and the turn-off of the last slave burner.

LEAD LAG PID

The behavior of the Lead Lag PID function is identical to the behavior of the stand-alone CH PID function. The same gain scalars and

algorithms are used. Additionally:

4.7.7 RATE ADJUSTMENT

When the **Slave dropout/return compensation** parameter specifies a rate adjustment and a rate compensation event occurs (a slave leaves while firing, or a slave returns) then rate adjustment will alter the integrator value so that the commanded rate compensates for the added or lost capacity.

INTEGRATOR COMPENSATION

A stand-alone Sola includes a feature to smooth the response when a rate override has occurred (such as delta-T rate limit) causing the PID output to be ignored.

Whenever an override has occurred then, at the moment the override ends, the integrator is loaded with a value that causes the PID output to match the current rate, whenever this is possible within the integrator's limits. The Lead Lag PID will implement similar behavior: The rate allocator will provide a trigger that causes the integrator's value to be recomputed and this trigger will activate whenever a rate allocation limit is released; that is, this event will occur any time the system transitions from the condition in which it is not free to increase the total modulation rate, to the condition where this rate may increase.

4.7.8 IMPLEMENTATION

The examples below are ways in which this may occur, but in implementation what is necessary, first of all, is to use a rate allocator that assigns rate to each slave and can detect when all of the assigned rate is absorbed, or if there is excess requested rate that the firing stages could not absorb.

Then:

Whenever the system is rate limited, that is, when A) all firing stages are commanded to their respective maximums and also B) the PID is asking for more heat than that, note that this has occurred by setting a flag and also record total rate that the system absorbed (the total of the commanded maximums, not the PID's requested rate which might include excess).

Whenever the rate allocator completes an execution pass and detects that both conditions

of step 1 are no longer true (demand has decreased) then it clears the flag.

Whenever the rate allocator completes an execution pass and detects both conditions of step 1 are true, and it also detects that the total rate potentially absorbed by the system (the commands have not yet been sent) has increased from the value that was saved when the flag was set, then it re-computes the integrator value based on the old commanded maximum, clears the flag, and actually allocates the old rate that was saved when the flag was set.

Examples include:

- The rate allocator has encountered a limit such as base load (for a "limited" rate allocation scheme) and this limit is released.

- All stages are at their maximum (base load, or max modulation) and one or more stages are rate-limited (such as due to slow-start or stepped modulation limiting due to high stack temperature, etc.) and the rate limited stage recovers, changing from rate-limited to free to modulate.

(This is indicated by the Slave Status "slave is modulating": the changing from false to true is not, itself, a trigger, but while it is true the rate allocator can assign to the slave only the firing rate that it is reporting; thus the release of this might allow more rate to be absorbed by the system. It also might not do this, if for example the slave was in anticondensation and thus the rate limit was maximum modulation rate.)

- All firing stages are at their maximum (base load, or max modulation) and a stage which was OnLeave returns in the firing state and is available for modulation.

- An add-stage is in-progress and all firing burners are at their limits (max modulation rate or base load) and then the new stage becomes available.

This also applies when the system is first starting up, that is, all firing burners are at their limits (zero) because none are firing, and thus when the add-stage is finished the system transitions from no modulation at all, to modulating the first stage.

Lead Lag Burner Demand

Lead Lag burner demand will be present when Frost protection burner demand is true, as described in the section on Frost protection. For the CH, and DHW demand sources, Lead Lag burner demand will be true when one of these is true and also setpoint demand from the hysteresis block is true.

4.7.9 RATE ALLOCATION

The PID block's output is used to determine the firing rate of each slave Sola using various rate allocation techniques.

Common Features

All rate allocation methods share certain features. The rate allocator first generates the **Slave Command**. Except for the Firing state, the value ultimately depends only upon the **SlaveState**. The values are:

Available

AddStage

SuspendStage depending on whether any other slave stage is firing, no matter what SlaveState it is in.

Firing

OnLeave - same as SuspendStage

This ensures that when a slave returns and is already firing, it will remain firing until the master decides what to do about that, or if it is not firing it will remain off.

Disabled - same as Available

Recovering - same as Available

It next runs a rate allocator that depends upon the rate allocation method. This routine fills in the modulation rate for all Firing boilers.

Each rate allocation method also provides functions to return identification of the modulating stage and the last stage, for use by the Add-stage and Drop-stage methods.

Rate Allocation Parameters

BASE LOAD COMMON: 0-100%

If set to zero, this parameter is disabled. For any non-zero value, it uses the individual base load rates of each slave to be ignored by the LL master's routines and this common value to be used instead. It is an easy way to set all base loads to the same value, without having to set

each slave. Some rate allocation algorithms may specify the use of this parameter, and that the slave base load settings are ignored.

RATE ALLOCATION METHOD: PARALLEL
COMMONBASE LIMITED

This selects the rate allocation method. This performs three purposes:

it determines how the LL master allocates firing rate to each active stage, the modulating stage and last stage are determined for the Add-stage and Drop-stage methods,

it determines the overflow rate and underflow rate and can provide this to staging algorithms.

OVERFLOW RATE AND UNDERFLOW RATE

The rate allocator knows the rate assigned to each stage, and the requested rate, and thus can determine the difference between these.

This difference has two forms: overflow (used by Addstage methods), underflow (used by Drop-stage methods).

When asked for rate overflow the threshold that is used is the upper limit of the modulating stage per the current rate allocation rules. Additionally this threshold may be shifted if the Add-stage method is using a dRate/dt behavior. Rate overflow is a positive or negative percentage offset from the threshold. For example:

If the modulating stage is at the staging threshold position but the

LL master is not asking for more heat than this, then the overflow rate is 0%. If it is at this location (limited) or above this location (unlimited) and the LL master is asking for 10% more than the threshold value, then the overflow rate is 10%. If it is below the staging threshold position by 5%, then the overflow rate is -5%.

When asked for rate underflow the threshold that is used is the minimum modulation rate of the last stage. Additionally this threshold may be shifted if the Dropstage method is using a dRate/dt behavior.

Rate underflow is a positive or negative percentage offset from the threshold. For example:

If the last stage is at the threshold position but

the LL master is not asking for less heat than this, then the underflow rate is 0%. If it is at this location and the LL master is asking for 10% less than the threshold value, then the underflow rate is -10%. If the last stage is 5% above the threshold then the underflow rate is 5%.

Rate allocation methods

PARALLEL COMMON BASE LIMITED
Allocation

All stages that are Firing receive the same firing rate.

Only the **Base load common** parameter is used for base loading, the individual slave's base load values are ignored.

As load increases:
Until all stages are Firing:
No stage is requested to exceed the common base load rate.

After all stages are Firing:
There is no restriction on the slave's commanded firing rate.

As load decreases:
As long as all available stages are Firing There is no restriction on the slave's commanded firing rate.

When at least one stage has been dropped:
No stage is requested to exceed the common base load rate.

MODULATING STAGE

Since all Firing stages receive the same rate, any stage can be considered to be the modulating stage. The one with the highest **StagingOrder** number is considered to be the modulating stage.

Last stage

The stage with the highest **StagingOrder** number is the last stage.

OVERFLOW AND UNDERFLOW

For the **Parallel common-base limited** the **Base load common** parameter provides the overflow threshold.

For the **Parallel common-base limited** the minimum modulation rate provides the underflow threshold.

Stager

The Stager is an internal program that determines when slave Solas should turn on as the need for heat increases, and when they should turn off as the need for heat decreases.

In all cases:

- The first burner turns on due to the combination of heat demand (call for heat) and setpoint demand (operating point falls below the setpoint minus the on hysteresis).
- The last burner (or all burners) turn off due to the loss of burner demand which is caused by either the loss of heat demand (no call for heat) or the loss of setpoint demand (the operating point climbs above the setpoint plus the off hysteresis).
- In between those two extremes the Add-stage and Dropstage methods determine when staging occurs. The stager handles burner on and burner off events. It operates according to this state transition diagram.

The stager has the following variables:

StagerState: encodes the current state of the stager.

StagerTimer: multipurpose 1 second timer used by states which measure time.

StagerTimeLimit: the timeout value for the StagerTimer

LeadStartup: flag indicating the lead boiler is starting

AddStageA: the stage being added to those already firing

Stager Parameters

ADD-STAGE INTERSTAGE DELAY: MM:SS

This specifies the minimum time that the Stager waits after adding one stage before adding another stage or dropping a stage.

DROP-STAGE INTERSTAGE DELAY: MM:SS

This parameter specifies the minimum time that the Stager waits after dropping one stage before dropping another stage or adding a stage.

Functions common to all stager states

These functions handle overall burner demand responsibility, and take care of cleaning up any anomalous conditions.

4.7.10 BURNER DEMAND

The stager checks the Master's LL burner demand. If this demand is off all slaves with SlaveStates of AddStage, SuspendStage, or Firing are set to Available by the Rate Allocator turning them all off and the **StagerState** is set to be Idle.

STAGERSTATE = IDLE WITH SLAVES ACTIVE
If the stager runs and its state is Idle, it checks the status of all slaves. If any of these have **SlaveState**=AddStage, SuspendStage, or Firing then these are set to Available (this will cause the Rate Allocator to turn them all off).

Stager States

The stager's operation is defined for each of its states:

STAGERSTATE = IDLE

Burner demand means that a demand source is calling for heat and there is also setpoint demand.

When there is no burner demand the stager is forced to be **Idle**.

When burner demand becomes true (Call for Heat) the stager checks the sequencer to identify the lead boiler. That boiler is given a command to start.

The stager resets (to verify it is at 0) and starts its **Stager-Timer**, and sets the **StagerTimeLimit** to the value of the slave's **Demand-to-firing delay** time.

If the Stager fails to get even one boiler from the Sequencer, it issues an alert and suspends until it runs again.

STAGERSTATE = ADDSTAGERESPONSE

During this state the stager is waiting for slave to transition to Firing. If the identified boiler has a **SlaveState**=Firing then the stager:

Resets and starts its **StagerTimer**, sets the **StagerTime- Limit** to **Add-stage interstage delay**, and changes the **StagerState** to InterstageDelay.

If the boiler's **SlaveState** is still AddStage then:

The stager checks to see if the **StagerTimer** has reached the **StagerTimeLimit**.

If so then the stager: Changes the **SlaveState** to Suspend- Stage, resets and starts its **StagerTimer**, sets the **StagerTimeLimit** to T_StagerSuspend. This allows additional time for the slave to reach its firing condition.

STAGERSTATE = ADDSTAGESUSPEND

During this state the stager is waiting to see if the slave has transitioned to Firing or Available.

If the identified boiler has a **SlaveState**=Firing then the stager:

Resets and starts its **StagerTimer**, sets the **StagerTime- Limit** to **Add-stage interstage delay**, it changes the **StagerState** to InterstageDelay.

The stager checks to see if the **StagerTimer** has reached the **StagerTimeLimit**.

If so then:

If the boiler's **SlaveState** is set to Available.

If any slave boiler is firing then **StagerState** = Active

Otherwise **StagerState** = Idle

STAGERSTATE = ACTIVE

During this state the stager is ready to manage add-stage and drop-stage requests.

If AddStageRequest is true

The Stager ask the Sequencer for an available slave.

When an available slave is found the stager repeats the above steps to bring this stage to Active.

If **DropStageRequest** is true and more than 1 slave burner is firing, the stager:

Invokes **SetRecovering** for the stage identified by **DropStageRequest**. This will turn the stage off and put it into the recovering state until it has finished its postpurge (if any).

Resets and starts its **StagerTimer**, sets **StagerTime- Limit** to **Drop-stage interstage delay**, changes the **StagerState** to InterstageDelay, invokes an action to reset the Add/Drop detection timers.

When the Interstage time has elapsed, the

Stager can execute an AddStage or DropStage request.

Add Stage Methods

Various methods can be used to determine when a new stage should be added. The internal algorithms that generate **AddStageRequests** are called Add-stage methods.

All methods work by observing various criteria such as the Firing stages, the commanded rate, or setpoint error.

Adding Stages Parameters:

ADD-STAGE DETECTION TIME1: MM:SS
This provides time thresholds.

In the descriptions below, the relevant parameter is referred to as **Add-Stage detection timeN**.

Add-Stage method1:
Disable,
Error threshold,
Rate threshold,
dError/dt and threshold,
dRate/dt and threshold }

In the descriptions below, the relevant AddStageDetect- Timer is referred to as AddStageDetectTimerN.

ADD-STAGE ERROR THRESHOLD:
DEGREES

This provides the error threshold as defined by the methods below.

ADD-STAGE RATE OFFSET: -100% TO +100%

This provides the rate offset threshold as defined by the methods below.

Add-stage methods

ERROR THRESHOLD
For error threshold staging, a stage is added when the error becomes excessive based on degrees away from setpoint, and time.

ADD-STAGE CONDITION:
- The modulating burner(s) is at its (their) maximum position per the rate allocation rules,
- The operating point is below the setpoint by an

amount greater than or equal to **Add-stage error threshold**

When the Add-stage condition is false then **AddStage- DetectTimerN** is set to zero. (If the condition is true then **AddStageDetectTimerN** is not zeroed and thus allowed to run.) If this timer reaches or exceeds **LLAdd- stage detection timeN** then **AddStageRequestN** is true.

RATE THRESHOLD For rate based staging, a stage is added based on the rate of the modulating stage.

ADD-STAGE CONDITION:
The modulating burner is at a rate that is at or above the rate which is calculated by adding the **Add-stage rate offset** to the maximum position per the rate allocation rules.

Examples: rate offset = 20% The add-stage condition will occur if the modulating stage is 20% above base load for unlimited allocations, or, if limited, when there is 20% more rate to distribute than can be absorbed by firing the stages at base load.

rate offset = -20% The add-stage condition will be as described just above, but the threshold is now 20% below the modulating stage's base load rate.

To support this, the current Rate Allocation method asks for the current "Overflow rate" - see the Rate Allocator section.

Drop Stage Methods

Various methods can be used to determine when a stage should be dropped. The internal algorithms that generate **DropStageRequests** are called Drop-stage methods.

One or two methods may be active at any time. If two are active then their requests are OR'd together.

All methods work by observing various criteria such as the Firing stages, the commanded rate, or Setpoint.

Dropping Stages Parameters:

DROP-STAGE DETECTION TIME: MM:SS
This provides time thresholds. They differ only in

that:

Drop-Stage detection time is used with DropStageDetectTimer

In the descriptions below, the relevant parameter is referred to as **LL – Drop Stage detection time N** .

Drop-Stage method:

Disable,
Error threshold,
Rate threshold,
dError/dt and threshold,
dRate/dt and threshold

DROP-STAGE ERROR THRESHOLD: DEGREES

This provides the error threshold as defined by the methods below.

DROP-STAGE RATE OFFSET: -100% TO +100%

This provides the rate offset threshold as defined by the methods below.

LL boiler off options:

Options disabled,
Enable all boilers off (ABO)
Enable lead drop-stage on error (LDSE)
Enable both ABO and LDSE

This provides options for customizing the way stages are dropped, as described below.

LL ALL BOILERS OFF THRESHOLD: TEMPERATURE OR NONE

When the LL boiler off options specifies "Enable all boilers off (ABO)" or "Enable both ABO and LDSE" then this parameter provides the boiler off threshold temperature that is used. In this case, if the temperature is the None value then a parameter error lockout occurs.

Drop-stage methods Error threshold

For error threshold staging, a stage is dropped when the error becomes excessive based on degrees away from setpoint and time.

DROP-STAGE CONDITION:

- The modulating burner(s) is at its (their) minimum position per the rate allocation rules,
- The operating point is above the setpoint by an amount greater than or equal to **Drop-stage error threshold**

When the Drop-stage condition is false then

DropStageDetectTimer N is set to zero. (If the condition is true then **DropStageDetectTimer N** is not zeroed and thus allowed to run.) If this timer reaches or exceeds **Dropstage detection time N** then **DropStageRequest N** is true.

RATE THRESHOLD

For rate based staging, a stage is dropped based on the rate of the last stage.

DROP-STAGE CONDITION:

-The modulating burner(s) is at a rate that is at or below the minimum modulation rate plus a rate offset.

Examples:

rate offset = 20% The Drop-stage condition will occur when the last stage is less than a threshold that is the minimum modulation rate plus another 20%.

rate offset = 0% The Drop-stage condition will occur when the last stage is at the minimum modulation rate.

rate offset = -20% The Drop-stage condition will occur if the last stage is at minimum modulation and there is 20% less rate to distribute than can be absorbed; that is, the rate allocator would like the minimum modulation rate to be lower than it is.

To support this, the current Rate Allocation method asks for the current "Underflow rate" - see the Rate Allocator section.

Boiler off options

The **LL boiler off option** controls two optional behaviors. One option is to enable the use of the **LL all boilers off threshold** and is abbreviated "ABO", and the other controls whether a lead boiler is affected by a drop-stage method based upon error, and is abbreviated as "LDSE".

ALL BOILERS OFF - ABO:

The ABO temperature provides a Burner Off threshold that essentially replaces the normal Burner Off threshold as given by the **LL off hysteresis** parameter; it is processed by the same logic block using some additional rules.

If ABO is enabled then:

- When the LL master operating point reaches or exceeds the ABO threshold this turns off LL master burner demand.
- The Burner Off threshold provided by **LL off**

hysteresis is ignored if one or more lag boilers are firing.

- If LDSE is enabled:

The Burner Off threshold provided by **LL off hysteresis** is ignored also for the lead boiler when it is firing solo (i.e. when no lag boilers are firing).

- If LDSE is disabled:

When the lead is firing solo and the operating point reaches the Burner Off threshold specified by **LL off hysteresis** turns off LL master burner demand (and thus the lead boiler).

As usual, whenever LL master burner demand is turned off by its hysteresis block, it does not recur until the operating point falls below the Burner On threshold.

Summary of the burner-off thresholds that are used:

4.7.11 LEAD DROP-STAGE ON ERROR - LDSE:

If LDSE is enabled then either **Drop-stage method1** must be enabled to provide staging based on "Error threshold"; otherwise a parameter error lockout occurs.

Normally, for a lag boiler, dropping a stage based on error involves meeting three criteria: 1) the operating point temperature must exceed an offset from setpoint, 2) this condition must persist for a period of time, and 3) the measured time starts only when the modulating boilers are firing at the minimum modulation rate. And normally when LDSE is not enabled, the lead boiler is special case that is not affected by a drop-stage event: it shuts down only when the operating point reaches the burner-off threshold (or ABO threshold, if that is enabled).

If LDSE is enabled:

- Enabling (or disabling) LDSE has no effect on the dropstage behavior for a lag boiler; however
- When only the lead boiler is firing then an error based drop-stage event does act to drop the lead boiler, and moreover, only one of the three criteria above are considered by the method in this case: the operating point temperature. Thus dropping the lead does not depend on exceeding this temperature for a period of time, nor does it require the lead to be at minimum

modulation rate. When LDSE is enabled and the lead is firing solo, then simply reaching the drop-stage threshold causes a dropstage event that causes the lead to turn off and [rf3259] which thus ends LL master demand until the operating point again falls to the Burner On threshold.

Sequencer

The Sola sequencer determines which Sola will be the next one to turn on or turn off whenever an Add-stage event occurs. It maintains the following variables:

LeadBoilerSeqNum - sequence number of the current lead boiler in the Slave Status table.

Lead BoilerRunTime - the cumulative time that the current lead boiler has been running.

In all cases, if a boiler sequence number is needed and **Slave sequence order** is 0, then the boiler's ModBus address is used as its sequence number.

In all cases, if two boilers being compared have the same effective sequence number, then the one that is selected is undefined (either may prevail).

Sequencer Parameters

LEAD SELECTION METHOD: ROTATE IN SEQUENCE ORDER, MEASURED RUN TIME
This determines the selection method for lead selection and sequencing, as described below.

LAG SELECTON METHOD: SEQUENCE ORDER, MEASURED RUN TIME
This determines the selection method for lag selection and sequencing, as described below.

LEAD ROTATION TIME: HH:MM OR NONE
This determines the lead rotation time as defined below.

FORCE LEAD ROTATION TIME: HH:MM OR NONE

If this parameter is a non-zero time, then it is used to force the rotation of the lead boiler if it stays on longer than the time specified.

Sequencer Add Boiler Selection

The sequencer selects the next boiler to be added according to a sorted order. This description assumes this is implemented by

assigning an ordering number and that the lowest numbers are the first to be added.

- Any Available slaves that have a mode of Use First will have the lowest ordering numbers. If two or more Use First boilers exist, they are numbered according to their assigned **Slave sequence order** or Modbus address if this value is zero, as described above.

- Next are slaves that have the mode of Equalize Runtime. When the add boiler routine gets to this group it first invokes the Voluntary Lead Rotation routine (to make sure this is done, but only once) and then selects an Available boiler, if any, ordered according to:

- The first is the lead boiler per the **LeadBoilerSeqNum** parameter.

- The rest are the other slaves ordered according to the **LL -Lag selection method}** parameter:

- If this parameter is "Rotate in sequence order", then they are ordered according to their **LL - Slave sequence order** or Modbus address if this value is zero, as described above.

- If this parameter is "Measured run time" then they are ordered according to their reported run time. If two have the same measured run time, then either may be selected.

- Last are any Available slaves that have a mode of Use Last. These will have the highest numbers. If two or more Use Last boilers exist, they are numbered according to their assigned **Slave sequence order** or Modbus address if this value is zero, as described above.

Voluntary Lead Rotation

The current lead boiler is identified by the **LeadBoilerSeqNum** value. This value will change when the stager has asked the sequencer for a boiler to add and either:

- the boiler identified by **LeadBoilerSeqNum** is neither Available nor Firing (i.e. it has a fault or is OnLeave), or
- the **LeadBoilerRunTime** value exceeds **Lead rotation time**.

In either of these cases, the algorithm performed is: If the **Lead selection method** is "Rotate in sequence order", then **LeadBoilerSeqNum** is incremented, and then new lead boiler is the one that is a slave in Equalize Runtime mode that is responding to the LL master (i.e. not OnLeave or Recovering, but it might be Firing), and:

- has a sequence number equal to **LeadBoilerSeqNum**, or.

- If no boiler has this then the closest one with

a sequence number greater than this number is used, or

- If no boiler has a greater sequence number, then the one that has the smallest sequence number is used (wrap around).

Otherwise when the **Lead selection method** is "Measured run time", then the lead boiler is the one having the lowest Measured run time value. If two have the same measured run time, then either may be selected.

The **LeadBoilerRunTime** value is then set to zero to give the new lead boiler a fresh allotment. Note: if the old lead boiler is the only one, then this process may end up re-designating this as the "new" lead with a fresh time allotment.

Sequencer ordering function

Part of the sequencer is called by the stager just before the stager runs, to give the sequencer a chance to assign order numbers to stages that very recently turned on, and to maintain these in a sequence. It uses the **StagingOrder** item in the Slave Status table for this purpose.

The sequencer ordering function examines all slaves and sets to zero the **StagingOrder** of any stage that is not Firing.

This ensures that any stage that has left the Firing condition recently is no longer in the number sequence.

Next, skipping all of those that have 0 values in **StagingOrder** it finds the lowest numbered **StagingOrder** and gives it the value 1, the next receive 2, etc.

Thus if gaps have developed due to a slave dropping out these are filled in.

Finally, the ordering function continues on, giving the next numbers to and Firing stages which have a 0 **StagingOrder** values (i.e. they recently were added, or they recently returned from OnLeave).

Example: Before After Notfiring 3 0 Notfiring 0 0
Firing 2 1 Firing 5 3 Firing 0 4 Firing 4 2

Sequencer Drop Lag boiler selection

When the stager asks the sequencer for a lag boiler to drop the sequencer looks at the

StagingOrder numbers of all Firing boilers. If only one Firing boiler is found, or none are found, then this selection function returns a value that indicates no boiler may be dropped. Otherwise it returns an identifier for the boiler having the highest **StagingOrder** number.

SEQUENCER 1 MINUTE EVENT

Part of the sequencer is called by the timing service at a 1 minute rate to implement lead rotation.

The 1 minute event checks the boiler identified by **Lead- BoilerSeqNum**. If it is Firing then the **LeadBoilerRunTime** is incremented.

FORCED LEAD ROTATION:

When the boiler identified by **LeadBoilerSeqNum** is firing and also **LeadBoilerRunTime** reaches the **Force lead rotation time** parameter time then:

1. The current lead boiler is noted.
2. Lead rotation occurs as described above under Voluntary Lead Rotation (this changes the designation, but does not change the actual firing status).

SLAVE WRITE: DATA

This allows the slave to accept command messages from a Sola master

SLAVE READ: DATA

This provides the slave status message to be read by a Sola Master. It includes all of the data that is read from a slave.

SLAVE MODE: USE FIRST, EQUALIZE RUNTIME, USE LAST

- If set to Use First, then this slave Sola will be used prior to using other slave Solas with other values.
- If this parameter is set to Equalize Runtime, then this slave Sola will be staged according to a run time equalization. (Any Solas set to Use First will precede any that are set to Equalize Runtime.)
- If this parameter is set to Use Last, then this slave Sola will be used only after
- all Use First and Equalize Runtime Solas have been brought online.

SLAVE PRIORITY SEQUENCE ORDER: 0-255

Slave sequence order is used to determine the order in which the slave Solas will be used (staged on) for those Solas with the same Slave mode setting. Numbers may be skipped, that is

3 will be first if there is no 1 or 2.

NOTE: For Equalize Runtime purposes, 1 does not mean the Sola will be used first every time; that will vary over time based on the master's run time equalization scheme. In this case the sequence number determines the relative order in which Sola controls will be used in a round-robin scheme.

If the slave sequence number value is zero, then the slave Sola's ModBus address will be used instead.

If two Solas are set the same mode and both have the same sequence number then an alert will occur and the order in which they are used will be arbitrary and is not guaranteed to be repeatable.

Free Manuals Download Website

<http://myh66.com>

<http://usermanuals.us>

<http://www.somanuals.com>

<http://www.4manuals.cc>

<http://www.manual-lib.com>

<http://www.404manual.com>

<http://www.luxmanual.com>

<http://aubethermostatmanual.com>

Golf course search by state

<http://golfingnear.com>

Email search by domain

<http://emailbydomain.com>

Auto manuals search

<http://auto.somanuals.com>

TV manuals search

<http://tv.somanuals.com>