



## GENERAL PRECAUTIONS

- Use only Brother TZ tapes with this machine. Do not use tapes that do not have the **TZ** mark.
- Do not pull on the tape being fed from the P-touch, otherwise the tape cassette may be damaged.
- Do not attempt to cut the tape while printing or feeding since this will damage the tape.
- Do not clean the machine with alcohol or other organic solvents. Only use a soft, dry cloth.
- Remove the batteries if you do not intend to use the machine for an extended period of time.
  - Note:** If power is disconnected for more than three minutes, all text shown in the display and any text files stored in the memory will be lost. Language and unit settings will also be cleared.
- Do not put any foreign objects into or heavy objects on the machine.
- Do not expose the machine to extremely high temperatures or high humidity. Never leave it on the dashboard or in the back of your car.
- Avoid using the machine in extremely dusty places. Keep it out of both direct sunlight and rain.
- Do not leave any rubber or vinyl on the machine for an extended period of time, otherwise the machine may be stained.
- Do not touch the print head mechanism. If the head is touched, clean it immediately with a soft wipe (e.g. a cotton swab) to avoid permanent damage.
- To avoid injuries, do not touch the cutter's edge.
- Please contact your Brother dealer for details.
- If the cutter blade becomes blunt after repetitive use and the tape can not be cut cleanly, replace with new cutter unit (stock no. TC-5) by obtaining from an authorized brother dealer.
- Be sure to use scissors to cut the fabric tapes. The built-in cutter cannot completely cut the fabric tapes.

## POWER SUPPLY & TAPE CASSETTES

- Remove the back cover by pressing in the rough area at the top end of the machine. If a tape cassette is already installed, remove it by pulling it straight up. Also, if batteries are already installed, remove them.
- Insert six new AAA-size (LR03) alkaline batteries, making sure that their poles point in the correct directions. Always replace all six batteries at the same time using brand new ones.
- Insert a tape cassette, making sure that it snaps into place.
  - Make sure that the end of the tape feeds under the tape guides.
  - Be sure to remove the paper tab when installing a new tape cassette.
  - If the ink ribbon is loose, use your finger to wind the toothed wheel in the direction of the arrow on the cassette.
  - Use only Brother TZ tapes with this machine.
- Attach the back cover by inserting the two hooks at the bottom into the slots on the machine, then pushing down firmly on the cover until it snaps into place. After you have installed the tape, feed the tape (see FEEDING) once and then push in the tape cutter lever to cut the tape.

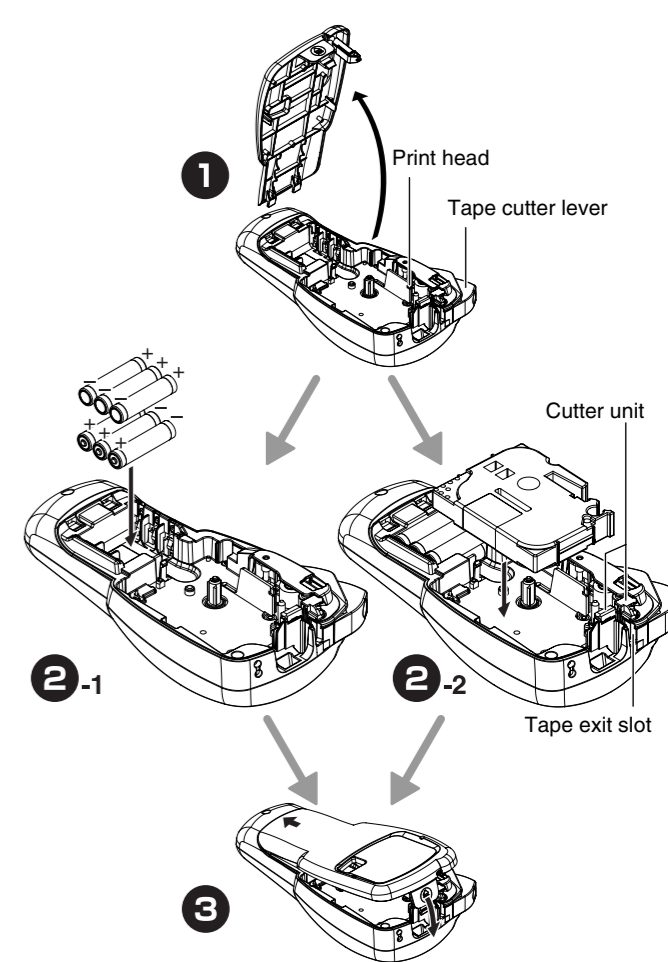

## INTRODUCTION

With your PT-900, you can create labels for any application. Select from the many frames, character sizes and styles to design beautiful custom labels. In addition, the variety of tape cartridges available allows you to print labels with different widths and exciting colours. Read this manual carefully before starting and keep the manual in a handy place for future reference.

SPECIFICATIONS	
Dimensions:	108 mm (W) X 196 mm (D) X 55 mm (H)
Weight:	335 g (without batteries and tape cassette)
Power supply:	Six AAA size alkaline batteries (LR03; not included)
Tape cassette:	Brother TZ tape 6 mm / 9 mm / 12 mm (width)
Cutter unit:	TC-5 (replacement)

## KEYBOARD & LCD

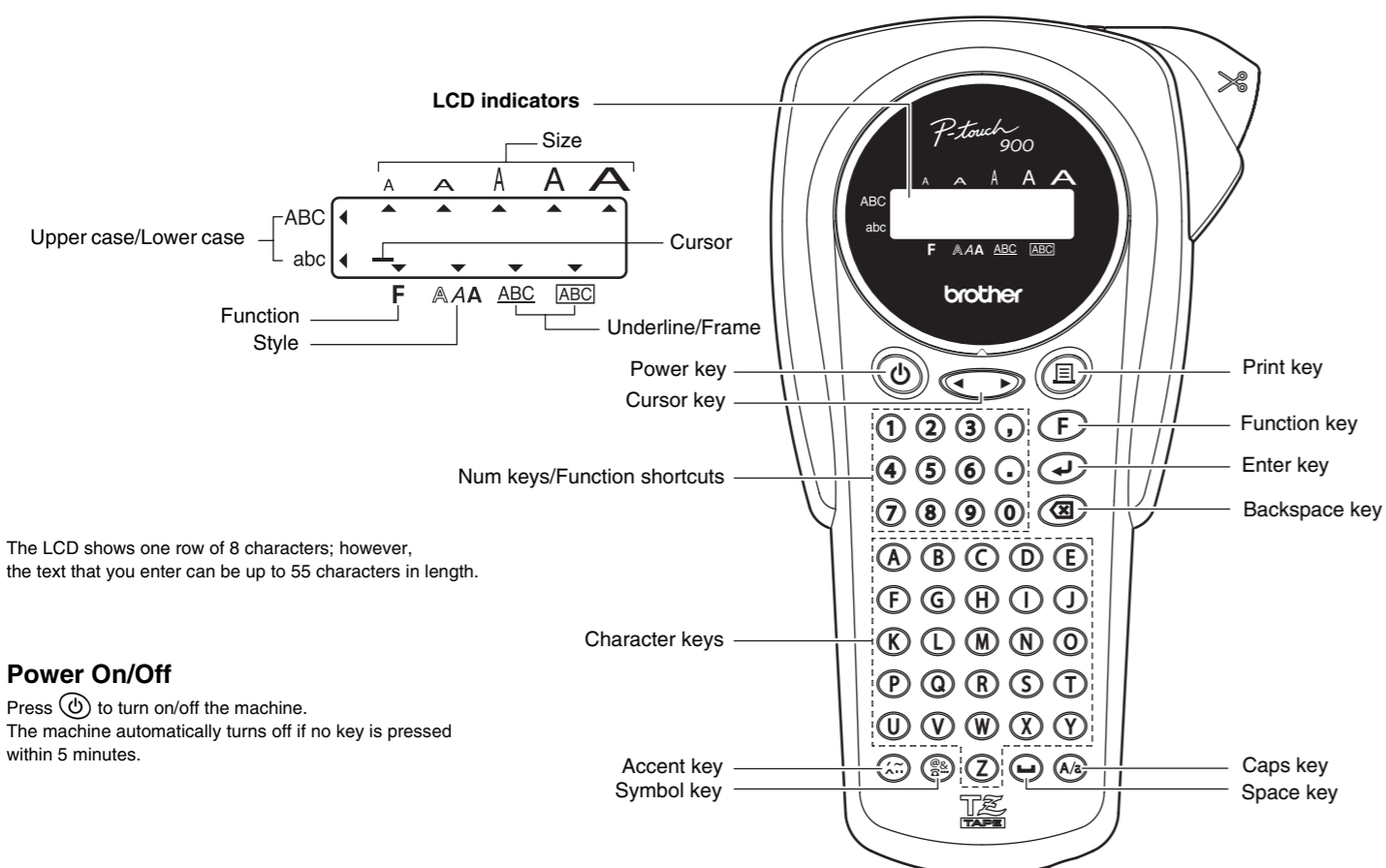

The LCD shows one row of 8 characters; however, the text that you enter can be up to 55 characters in length.

### Power On/Off

Press **ON/OFF** to turn on/off the machine. The machine automatically turns off if no key is pressed within 5 minutes.

## GETTING STARTED

- Start your machine**  
Supply power by using six AAA batteries, and then press **ON/OFF**.
- Set the language (English/French/German)**  
Press **1. ENG?**  
Choose a language with **←** and **→** and press **ENTER**.  
ENGLISH   FRANÇAIS   DEUTSCH  
Check the display and press **ENTER**. (To cancel, press **ESC**.)
- Set the unit (mm/inch)**  
Press **1. mm?**  
Choose a unit with **←** and **→** and press **ENTER**.  
mm   inch  
Check the display and press **ENTER**. (To cancel, press **ESC**.)

**NOTE:** You can also display the languages and units by pressing the corresponding Num keys (1-3).

- NOTE:**
- To cancel operations, press **ESC**.
  - To delete entries backward, press **←**.
  - To initialize the settings, turn off the machine and then while holding down **F** and **ESC**, press **ON/OFF** to turn the machine back on. Finally, release **F** and **ESC**.

## MAKING TEXT

### Switching UPPER CASE/LOWER CASE

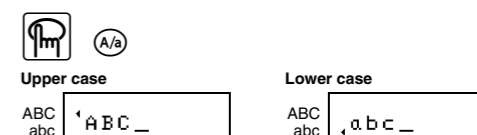

### Making TWO LINE TEXT

Move the cursor to where the second line starts and press **ENTER**.  
**NOTE:** Use either 9 mm or 12 mm wide tape for two line texts.



### Entering SYMBOLS

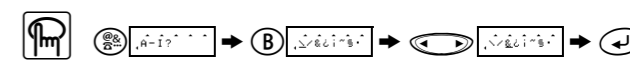

Group	Symbols	Group	Symbols
A	? ! " ' : ; - _	F	→ ← ↑ ↓ ↻ ↺
B	\ / & @ ~ § ·	G	* \$ & € ¢ Fr f ij
C	@ # % * & ™	H	® ¨ β μ ♂ ♂ ♀ ♂
D	+ - x * ± = ÷	I	☎ ★
E	( ) [ ] < >		

**NOTE:**

- You can also display the symbols by pressing **SYM** / **←**.
- To go to the next group, press **→**.
- To skip to a different group, press the corresponding character key of the group.
- You can also scroll the symbols in each group by pressing the corresponding character key of the group repeatedly.

## Entering ACCENTED CHARACTERS

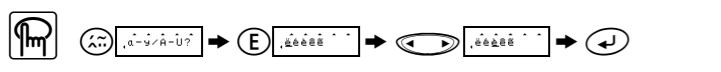

Letter	Accented characters	Letter	Accented characters
A	Á Â Ã Ä Å Æ	a	á â ã ä å æ
C	Č Ć Ç	c	č ć ç
D	Đ Đ	d	đ đ
E	É Ê Ë Ì Í Î Ï	e	é ê ë ì í î ï
I	İ İ	i	ı ı
L	Ł ł	l	ł ł
N	Ñ Ñ	n	ñ ñ
O	Ó Ô Õ Ö Ø	o	ó ô õ ö ø
R	Ř ř	r	ř ř
S	Ś ś	s	ś ś
T	Ť ť	t	ť ť
U	Ú Û Ü	u	ú û ü
Y	Ý ý	y	ý ý
Z	Ž ž	z	ž ž

**NOTE:**

- You can also display the characters by pressing **ACC** / **←**.
- To go to the next letter group, press **→**.
- To skip to a different letter group, press the corresponding character key.
- You can also scroll the characters in each letter group by pressing the corresponding character key repeatedly.

## DESIGNING LABELS

### Setting FONT (F+1)

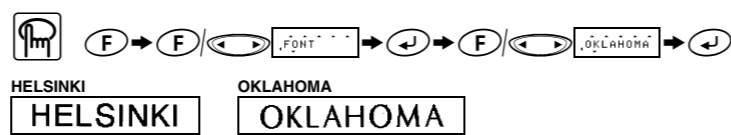

### Setting SIZE (F+2)

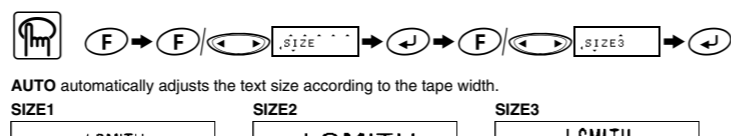

**NOTE:**

- Two line texts are printed in SIZE1 regardless of the setting.
- Only AUTO, SIZE1 and SIZE2 can be used on 6mm tapes.

### Setting STYLE (F+3)

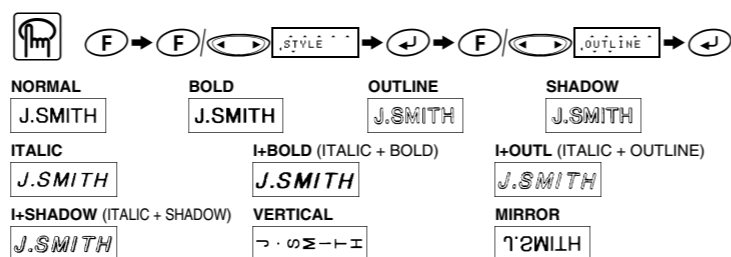

**NOTE:**

- Two line texts are printed in NORMAL, regardless of the setting.
- Use clear tape in MIRROR, so the labels appear on the other side when stuck on glass, windows or other transparent surfaces.

### Setting UNDERLINE/FRAME (F+4)

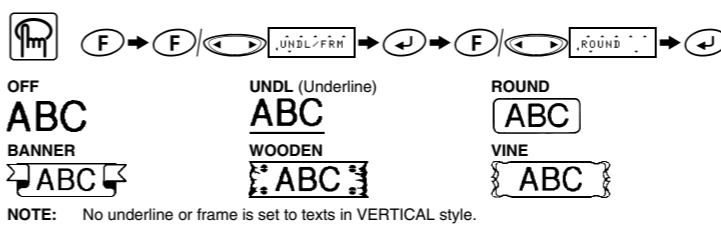

**NOTE:** No underline or frame is set to texts in VERTICAL style.

### Setting TAB (F+5)

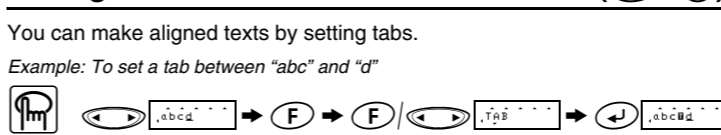

**NOTE:** The cursor should be positioned where you set a tab.

### Setting TAB LENGTH (0 - 100mm) (F+6)

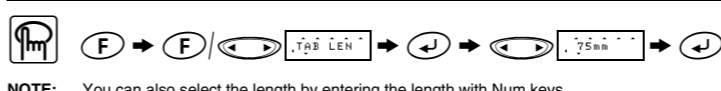

**NOTE:** You can also select the length by entering the length with Num keys.

### Setting LABEL LENGTH (AUTO/40 - 300mm) (F+7)

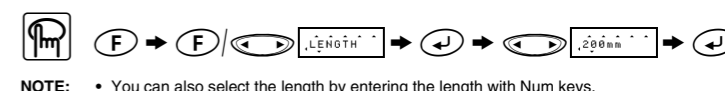

**NOTE:**

- You can also select the length by entering the length with Num keys.
- To return to AUTO, press any alphabet key or **SYM**.

### Using AUTO FORMAT (F+8)

You can choose label length from six formats to create labels for various applications.

LCD	Application	Length	LCD	Application	Length
VCR VHS	VCR VHS	140mm	FILE TAB	File Tab	70mm
FD 3.5"	3.5" Floppy Disk	68mm	AUDIO	Audio Cassette	89mm
CD CASE	CD	100mm	VIDEO 8	VCR 8mm (Video 8)	92mm

### To CLEAR (F+0)

All text and settings will be cleared.

## PRINTING

### TEXT PREVIEW (F+4)

You can preview the text before printing.  
**NOTE:**

- The LCD shows the whole text and the label length (mm/inch), then returns to the original text.
- Only the text can be previewed, but not the font, style, size, underline/frame or any additional features.

### FEEDING (TAPE FEED) (F+5)

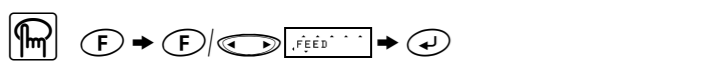

### PRINTING

**NOTE:**

- To cut off the label, push in the tape cutter lever on the upper-right corner of the machine.
- To prevent damage to the tape, do not try to cut while the message PRINT or FEED is displayed.
- Be sure to use scissors to cut the fabric tapes. The built-in cutter cannot completely cut the fabric tapes.

### TAPE MARGIN (F+6)

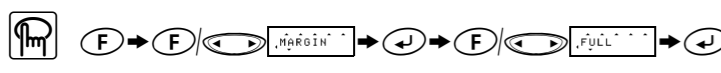

**NOTE:** Cut along the printed dots (·) with scissors so the text is centered in the label.

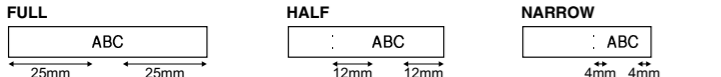

**CHAIN** is for printing more than 1 copy of a label with minimum margin <e.g. 1>. You can also create a label containing texts in various styles; print a text in one style, and before feeding, enter the second text in another style <e.g. 2>.

**NOTE:** FEED THE TAPE BEFORE USING THE CUTTER (see FEEDING/PRINTING). Otherwise A PART OF THE TEXT MAY BE CUT OFF. Do not try to pull the tape since this may damage the tape cassette.

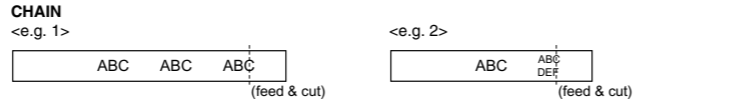

### Print Option/REPEAT PRINTING (F+9)

You can print up to 9 copies of each label.  
**NOTE:**

- When the tape margin is set to CHAIN, FEED THE TAPE BEFORE USING THE CUTTER (see FEEDING/PRINTING). Otherwise A PART OF THE TEXT MAY BE CUT OFF. Do not try to pull the tape since this may damage the tape cassette.
- When the tape margin is set to FULL/HALF/NARROW, cut along the printed dots (·) with scissors to separate the labels.

### Print Option/NUMBERING (F+0)

You can print many copies of the same text while increasing a selected number by 1 after each label is printed.

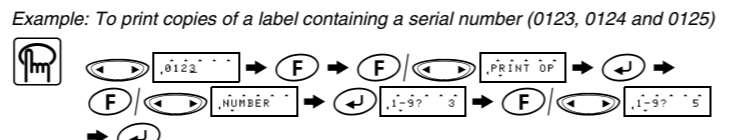

**NOTE:**

- The last number that will be printed must be larger than the number selected in the text, otherwise the message ERROR appears.
- When the tape margin is set to CHAIN, FEED THE TAPE BEFORE USING THE CUTTER (see FEEDING/PRINTING). Otherwise A PART OF THE TEXT MAY BE CUT OFF. Do not try to pull the tape since this may damage the tape cassette.
- When the tape margin is set to FULL/HALF/NARROW, cut along the printed dots (·) with scissors to separate the labels.

## MEMORY (F+9)

You can store up to 9 frequently used text files and recall them to create labels more quickly and easily.



**NOTE:**

- When the memory is full, delete one or more files and then store the new file.
- You can also choose a file number by pressing the corresponding Num key (1-9).

## FUNCTION SHORTCUTS (F+...)

In addition to the basic steps to search for a function, PT-900 provides you with function shortcuts so you can easily jump to a frequently used function just by pressing **F** and the shortcut key shown in the table below. To confirm, press **ENTER** (or the shortcut key again).

Key	LCD message	Function	Key	LCD message	Function
1	FONT	Character font	0	A/F	Auto Format
2	SIZE	Character size	0	MEMORY	Memory
3	STYLE	Print style	0	CLEAR	Clear text + style
4	UNDL/FRM	Underline/Frame	0	MARGIN	Tape margin
5	TAB	Tab setting	0	PRINT OP	Repeat/Numbering
6	TAB LEN	Tab length	0	PREVIEW	Text preview
7	LENGTH	Label length	0	FEED	Tape feed

**NOTE:**

- PRINT OP contains two functions, REPEAT PRINTING and NUMBERING.
- For PREVIEW and FEED, press **ENTER** to preview/feed after the LCD message appears.

## ERROR MESSAGE LIST

ERROR	An error occurred.
BATTERY	The batteries are weak.
B A T T E R Y	The batteries are empty.
FULL	The maximum number of characters (55 characters) have already been entered or the memory is full.
LONG TXT	The text length exceeds the selected label length.

## TROUBLESHOOTING

Problem	Solution
The display stays blank after you have turned on the machine.	• Check that the batteries are correctly inserted. • If the batteries are weak, replace them.
The machine does not print, or the printed characters are blurred.	• Check that the tape cassette has been inserted correctly. • If the tape cassette is empty, replace it. • Check that the character size is appropriate for the width of the tape that is used!
The printed characters are not formed properly.	• If the batteries are weak, replace them.
Striped tape appears.	• The tape cassette is empty. Replace it.
The memory has cleared on its own.	• The batteries may be weak. Replace them.
A blank horizontal line appears through the printed label.	• Remove the tape cassette and use a dry cotton swab to gently wipe the print head with an up-and-down motion. • The print head can be cleaned more easily if the optional print head cleaning cassette (TZ-CL3) is used.
The machine has "locked up" (i.e., nothing happens when a key is pressed, even though the machine is on).	• Turn off the machine, and then while holding down <b>F</b> and <b>ESC</b> , press <b>ON/OFF</b> to turn the machine back on. Finally, release <b>F</b> and <b>ESC</b> . <b>Note:</b> The text and formats in the display and all text files stored in the memory are erased. Also, the language and unit settings will be cleared.

## Free Manuals Download Website

<http://myh66.com>

<http://usermanuals.us>

<http://www.somanuals.com>

<http://www.4manuals.cc>

<http://www.manual-lib.com>

<http://www.404manual.com>

<http://www.luxmanual.com>

<http://aubethermostatmanual.com>

Golf course search by state

<http://golfingnear.com>

Email search by domain

<http://emailbydomain.com>

Auto manuals search

<http://auto.somanuals.com>

TV manuals search

<http://tv.somanuals.com>