

MANUALS
FOR
EVERY
DEVICE

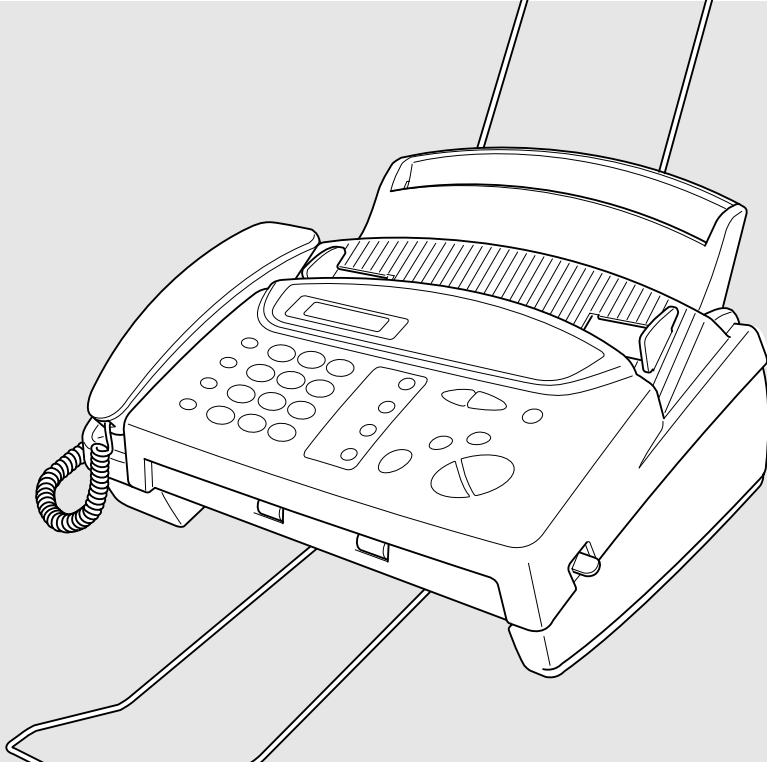

FAX 560

.....

brother

If You Need to Call Customer Service

Please complete the following information for future reference:

Model: FAX560

Serial Number:* _____

Date of Purchase: _____

Place of Purchase: _____

* The serial number is on the underside of the unit. Retain this Quick-Start Manual with your sales receipt as a permanent record of your purchase, in the event of a theft, fire or warranty service.

Year 2000 Compliant

Brother is addressing the Year 2000 related issues for all Brother fax machines and multi-function centers. Our focus is to ensure that our bundled third party software will continue to properly process date/time data after January 1, 2000.

Brother fax machines and multi-function centers will function properly after January 1, 2000, provided that all non-Brother hardware, software and firmware used by our customers in connection or combination with Brother fax machines, and bundled software, accurately exchange date data with the Brother products.

Please continue to check our Web page for updates at **<http://www.brother.com>**. All remedies will be provided to individual customers via software patches through software download or from Brother Customer Service.

Brother Numbers

Brother fax-back system

Brother Customer Service has installed an easy-to-use fax-back system, so you can get instant answers to common technical questions and product information for all Brother products. This system is available 24 hours a day, 7 days a week. You can use the system to send faxes to any fax machine, not just the one from which you are calling.

If you can't resolve difficulty with your fax machine using this manual, call our fax-back system, and follow the voice prompts to receive faxed instructions about using the system, and an index of fax-back subjects.

USA: 1-800-521-2846

From within Canada: 1-800-681-9838

The Brother fax-back system number (USA only) has been preprogrammed on One Touch key **1**.

Frequently Asked Questions (FAQs)

You can find more information about Brother products on the World Wide Web. From product specification sheets to Frequently Asked Questions (FAQs), it is all there. Visit us at:

<http://www.brother.com>

Brother Bulletin Board

Brother's Bulletin Board Numbers are

USA: 1-888-298-3616

From within Canada: 1-514-685-2040

For Customer Service

USA: 1-800-284-4329 (voice)
1-908-575-8790 (fax)

From within Canada: 1-800-853-6660 (voice)
1-514-685-4898 (fax)

From within Montreal: 1-514-685-6464 (voice)

Ordering Accessories and Supplies

For the best quality results use only genuine Brother accessories, available at most Brother retailers. If you cannot find the accessory you need and you have a Visa, MasterCard, Discover or American Express credit card, you can order accessories directly from Brother.

USA: 1-888-879-3232 (voice)
1-800-947-1445 (fax)

From within Canada: 1-800-668-2768 (voice)

DESCRIPTION	ITEM
Thermal Print Cartridge	PC401
2-PK Refill Ribbon Rolls	PC402RF
Telephone Line Cord	Tell the Brother Representative your Model number so you get the appropriate color.
Telephone Handset	Tell the Brother Representative your Model number so you get the appropriate color.
Handset Curled Cord	Tell the Brother Representative your Model number so you get the appropriate color.
Paper Wire Extension	UF9869001
Output Paper Extension	LE4129001
Paper Tray	LE4126001
Owner's Manual	LE4131001
Surge Protection Device with Telephone Line Protection (2 outlets)	QPD 120
Surge Protection Device with Telephone Line Protection (8 outlets)	FX 120

Notice – Disclaimer of Warranties (For USA and Canada)

BROTHER'S LICENSOR(S), AND THEIR DIRECTORS, OFFICERS, EMPLOYEES OR AGENTS (COLLECTIVELY BROTHER'S LICENSOR) MAKES NO WARRANTIES, EXPRESS OR IMPLIED, INCLUDING WITHOUT LIMITATION THE IMPLIED WARRANTIES OF MERCHANTABILITY AND FITNESS FOR A PARTICULAR PURPOSE, REGARDING THE SOFTWARE. BROTHER'S LICENSOR(S) DOES NOT WARRANT, GUARANTEE OR MAKE ANY REPRESENTATIONS REGARDING THE USE OR THE RESULTS OF THE USE OF THE SOFTWARE IN TERMS OF ITS CORRECTNESS, ACCURACY, RELIABILITY, CURRENTNESS OR OTHERWISE. THE ENTIRE RISK AS TO THE RESULTS AND PERFORMANCE OF THE SOFTWARE IS ASSUMED BY YOU. THE EXCLUSION OF IMPLIED WARRANTIES IS NOT PERMITTED BY SOME STATES IN THE USA AND SOME PROVINCES IN CANADA. THE ABOVE EXCLUSION MAY NOT APPLY TO YOU.

IN NO EVENT WILL BROTHER'S LICENSOR(S) BE LIABLE TO YOU FOR ANY CONSEQUENTIAL, INCIDENTAL OR INDIRECT DAMAGES (INCLUDING DAMAGES FOR LOSS OF BUSINESS PROFITS, BUSINESS INTERRUPTION, LOSS OF BUSINESS INFORMATION, AND THE LIKE) ARISING OUT OF THE USE OR INABILITY TO USE THE SOFTWARE EVEN IF BROTHER'S LICENSOR HAS BEEN ADVISED OF THE POSSIBILITY OF SUCH DAMAGES. BECAUSE SOME STATES IN THE USA AND SOME PROVINCES IN CANADA DO NOT ALLOW THE EXCLUSION OR LIMITATION OF LIABILITY FOR CONSEQUENTIAL OR INCIDENTAL DAMAGES, THE ABOVE LIMITATIONS MAY NOT APPLY TO YOU. IN ANY EVENT BROTHER'S LICENSOR'S LIABILITY TO YOU FOR ACTUAL DAMAGES FROM ANY CAUSE WHATSOEVER, AND REGARDLESS OF THE FORM OF THE ACTION (WHETHER IN CONTRACT, TORT (INCLUDING NEGLIGENCE), PRODUCT LIABILITY OR OTHERWISE), WILL BE LIMITED TO \$50.

Compilation and Publication Notice

Under the supervision of Brother Industries, Ltd., this manual has been compiled and published, covering the latest product descriptions and specifications.

The contents of this manual and the specifications of this product are subject to change without notice.

Brother reserves the right to make changes without notice in the specifications and materials contained herein and shall not be responsible for any damages (including consequential) caused by reliance on the materials presented, including but not limited to typographical and other errors relating to the publication.

Trademarks

The Brother logo is a registered trademark of Brother Industries, Ltd.

Brother is a registered trademark of Brother Industries, Ltd.

IBM, IBM PC, MWAVE and IBM Aptiva are registered trademarks of International Business Machines Corporation.

ScanSoft PaperPort is a registered trademark of ScanSoft, Inc.

Microsoft and MS-DOS are registered trademarks of Microsoft Corporation.

Windows and Windows NT are registered trademarks of Microsoft in the U.S. and other countries.

All other terms and brand and product names mentioned in this manual are registered trademarks of their respective companies.

BROTHER ONE YEAR LIMITED WARRANTY and EXCHANGE SERVICE (For USA Only)

This warranty gives you certain rights and you may also have other rights that may vary from state to state.

This warranty is given only to the first end-use purchaser of the accompanying product (referred to in this warranty as "his Product").

What is covered: Brother warrants to you for the Warranty Period that there are no defects in the materials, workmanship or Year 2000 compliance of this Product. The iWarranty Period" is 90 days from the date you purchased this product. The iWarranty Period" for consumable items, such as Toner, Drums, Ribbons, etc. is 90 days from the date of purchase, or the rated life of the Consumable item, whichever is shorter.

What is NOT covered: This warranty is VOID -- that is, this Product has no warranty -- if: (1) you did not purchase this Product from an authorized Brother reseller within the United States, (2) this Product has been serviced, modified or tampered with by anyone other than an Authorized Service Representative of Brother, (3) the serial number has been modified, defaced or removed from this Product, (4) this Product has been abused or damaged, (5) non Brother/Æ-brand or non Brother approved parts, supplies, power supplies or other accessories have been used with this Product, or (6) this Product has been transported without the proper preparation and packaging.

What to do if you think your Product is defective:

Call our Customer Service Hotline at 1-800-284-4329, or if you suspect a defect in materials or workmanship in this Product, you can report it to a Brother Authorized Service Center. During the Warranty Period, supply Brother's representative with a copy of your dated bill of sale showing that this Product was purchased within the United States. For the name of your Brother Authorized Service Center, call 1-800-521-2846. After contacting the Brother Authorized Service Center, you may be required to deliver or send the

Product properly packaged, freight prepaid, to the Authorized Service Center together with a photocopy of your bill of sale.

What Brother will do: Brother (or its Authorized Service Center) will evaluate your report of a possible defect to determine whether a defect exists, and if it does exist, Brother (or its Authorized Service Center) will repair or (at Brother's option) replace the Product with a product that performs the same functions and performs as well as the original Product. Brother reserves the right to supply refurbished or remanufactured replacement parts provided that the replacement parts conform to the manufacturer's specifications for new products. The repaired or replacement product will be returned to you at no cost.

Exchange Service:

When an exchange is authorized, Brother will exchange your non-working product with a refurbished or remanufactured product that conforms to the manufacturer's specifications for new products. The refurbished or remanufactured Product you receive will be covered by the balance of the limited warranty period remaining on the original Product, plus an additional thirty (30) days. You will keep the replacement Product that is sent to you and must return (or be billed up to the cost of a new product) your original non-working product, which shall become the property of Brother. You must call Brother Customer Service and if the representative cannot correct the product's malfunction over the telephone and you elect the exchange service, you must provide information pertaining to this Product and you must also provide a valid major credit card number. Your credit card will be charged up to the cost of a new Product if: (i) you do not return your original Product to Brother within five (5) business days; (ii) the malfunctions of your original Product are not covered by the limited warranty; (iii) the proper packaging instructions are not followed and has caused damage to the product;

BROTHER ONE YEAR LIMITED WARRANTY and EXCHANGE SERVICE (For USA Only)

or (iv) the warranty period on your original Product has expired or has not been sufficiently validated with a copy of the proof of purchase (bill of sale). The Brother Customer Service Representative will ship the exchange Product via next business day delivery courier service, with return instructions and prepaid return airbill. Follow the return instructions. You must return the original Product in the same shipping carton in which the exchanged Product was received and include a copy of proof of purchase (bill of sale). Retain your original accessory items and a copy of the return airbill, signed by the courier.

Limitations:

Repair or replacement as described above is your sole and exclusive (that is, your only) remedy if this Product is defective. Brother is not responsible for damage to or loss of any equipment, media, programs or data related to the use of this Product. Except for that repair or replacement, Brother shall not be liable for any direct, indirect, incidental or consequential damages or specific relief. Because some states do not allow the exclusion or limitation of consequential or incidental damages, the above limitation may not apply to you.

THIS WARRANTY IS GIVEN IN LIEU OF ALL OTHER WARRANTIES, WRITTEN OR ORAL, WHETHER EXPRESSED BY AFFIRMATION, PROMISE, DESCRIPTION, DRAWING, MODEL OR SAMPLE. ANY AND ALL WARRANTIES OTHER THAN THIS ONE, WHETHER EXPRESS OR IMPLIED, INCLUDING IMPLIED WARRANTIES OF MERCHANTABILITY AND FITNESS FOR A PARTICULAR PURPOSE, ARE HEREBY DISCLAIMED.

This Limited Warranty is the only warranty that Brother is giving for this Product. It is the final expression and the exclusive and only statement of Brother's obligations to you. It replaces all other agreements and understandings that you may have with Brother or its representatives.

This Limited Warranty (and Brother's obligation to you) may not be changed in any way unless you and Brother sign the same piece of paper in which we (1) refer to this Product and your bill of sale date, (2) describe the change to this warranty and (3) agree to make that change.

Product Support: Toll-free customer service and technical support is available for hardware operational assistance at [1-800-284-4329](tel:1-800-284-4329). At any time, free technical support in the form of Frequently Asked Questions, troubleshooting tips and service center locator is available through our fax-back system at [1-800-521-2846](tel:1-800-521-2846) or Brother's Internet Web Site (www.brother.com). Now you can visit us on-line (www.brothermall.com), your complete source for genuine Brother Accessories and Supplies.

**Brother International
Corporation 100 Somerset Corporate
Blvd. Bridgewater, New Jersey
08807-0911**

Please record your model and serial numbers and your date and location of Purchase below for your records. Keep this information with your proof of purchase (bill of sale) in case your Product is lost, stolen or requires service.

Model # _____

Serial # _____

Date of purchase: _____

Store where purchased: _____

Location of store: _____

Important: We recommend that you keep all original packing materials, in the event that you ship this product.

**BROTHER MULTIFUNCTION CENTER/FACSIMILE MACHINE
LIMITED WARRANTY
(For Canada Only)**

Pursuant to this limited warranty of 1 year from the date of purchase for labour and parts, Brother International Corporation (Canada) Ltd. ("Brother"), or its Authorized Service Centers, will repair this MFC/Facsimile machine free of charge if defective in material or workmanship. This Limited Warranty does not include cleaning, consumables (including, without limitation, print cartridges, print head, toner and drum) or damage caused by accident, neglect, misuse or improper installation or operation, any damage caused from service, maintenance, modifications, or tampering by anyone other than a Brother Authorized Service Representative, or from the use of supplies or consumable items that are non-Brother products. Operation of the MFC/Facsimile machine in excess of the specifications or with the Serial Number or Rating Label removed shall be deemed abuse and all repairs thereafter shall be the sole liability of the end-user/purchaser. In order to obtain warranty service, the MFC/Facsimile machine must be delivered or shipped freight prepaid by the end user/purchaser to a "Brother" Authorized Service Center, together with your Proof of Purchase in the form of a Sales Receipt.

For laser products: Failure to remove the Toner Cartridge (and Toner Drum Unit on applicable models) during shipping will cause severe damage to the MFC/Facsimile and will VOID the Warranty. (Refer to your Operation Manual for proper packaging.)

For ink-jet products: Do not remove the ink cartridges during shipping. Damage to your print head resulting from packing without the ink cartridges will VOID your warranty. (Refer to your Operation Manual for proper packaging.)

BROTHER DISCLAIMS ALL OTHER WARRANTIES EXPRESSED OR IMPLIED INCLUDING, WITHOUT LIMITATION, ANY IMPLIED WARRANTIES OF MERCHANTABILITY OR FITNESS FOR A PARTICULAR PURPOSE, EXCEPT TO THE EXTENT THAT ANY WARRANTIES IMPLIED BY LAW CANNOT BE VALIDLY WAIVED.

No oral or written information, advice or representation provided by Brother, its Authorized Service Centers, Distributors, Dealers, Agents or employees, shall create another warranty or modify this warranty. This warranty states Brother's entire liability and your exclusive remedy against Brother for any failure of the MFC/Facsimile machine to operate properly.

Neither Brother nor anyone else involved in the development, production, or delivery of this MFC/Facsimile machine shall be liable for any indirect, incidental, special, consequential, exemplary, or punitive damages, including lost profits, arising from the use of or inability to use the product, even if advised by the end user/purchaser of the possibility of such damages. Since some Provinces do not allow the above limitation of liability, such limitation may not apply to you.

This Limited Warranty gives you specific legal rights and you may also have other rights which vary from Province to Province.

Warranty Service is available at Brother Authorized Service Centers throughout Canada. For Technical Support or for the name and location of your nearest Authorized Service Center call 1-800-853-6660. Within Montreal, please call 685-6464. Internet support: support@brother.ca or browse Brother's Web Site: www.brother.com

Brother International Corporation (Canada) Ltd.
1 Rue Hôtel de Ville
Dollard-Des-Ormeaux, QC H9B 3H6

We're at your side.
brother®

Table of Contents

1

Introduction	1-1
Using This Manual	1-1
Finding Information.....	1-1
About Fax Machines	1-1
Fax Tones and Handshake.....	1-2
ECM (Error Correction Mode).....	1-2
FAX-560 Control Panel Overview.....	1-3

2

Location and Connections	2-1
Caution	2-1
Choosing a Location.....	2-1
Assembly.....	2-2
Attach the paper wire extension	2-2
Attach the paper tray	2-2
Attach the output paper support	2-2
Loading the Paper.....	2-3
Acceptable Paper	2-3
Connections.....	2-4
Connecting the Machine.....	2-4
Special Line Considerations	2-5
Roll Over Phone Lines.....	2-5
Two-Line Phone System.....	2-5
Converting Telephone Wall Outlets	2-5
Installing Brother Machine, External Two-Line TAD, and Two-Line Telephone	2-6
Multi-Line Connections (PBX)	2-7
If you are installing the fax machine to work with a PBX:	2-7
Custom Features on Your Phone Line.....	2-7
Connecting an External Telephone Answering Device (TAD).....	2-8
Sequence	2-8
Connections.....	2-9
Outgoing Message (OGM)	2-9
Connecting an External Telephone	2-9

3

On-Screen Programming.....	3-1
User-Friendly Programming.....	3-1
Function Mode.....	3-1
Alternating Displays.....	3-1
Function Selection Table.....	3-2

4

Initial Setup.....	4-1
Getting Started.....	4-1
Setting Date and Time.....	4-1
Choosing Station ID.....	4-1
Setting Tone/Pulse Dialing Mode (For Canada Only)....	4-2
Details for Entering Text.....	4-2
Inserting spaces.....	4-2
Making corrections.....	4-2
Repeating letters.....	4-3
Special characters and symbols.....	4-3
Setting Up Your Area Code (For USA Only).....	4-3
Setting Beeper Volume.....	4-4
Choosing the Handset Volume.....	4-4
Setting Volume Amplify.....	4-5
Setting the Speaker Volume.....	4-5
Setting the Ring Volume.....	4-5
Memory Storage.....	4-5

5

Setup Receive.....	5-1
Basic Receiving Operations.....	5-1
Select Answer Mode.....	5-1
To select or change your Answer Mode.....	5-2
Setting Ring Delay.....	5-2
Setting F/T Ring Time.....	5-3
Easy Receive.....	5-3
Printing a Reduced Incoming original.....	5-4
Recommended Reductions.....	5-4
Setting Paper Size.....	5-4
Advanced Receiving Operations.....	5-5
Operation from External or Extension Telephone.....	5-5
For FAX/TEL Mode Only.....	5-5
Changing Remote Codes.....	5-5
To change Remote Codes.....	5-5
Printing a Fax in Memory.....	5-6

Polling.....	5-6
--------------	-----

6

Setup Send	6-1
Automatic Document Feeder (ADF).....	6-1
Manual Transmission	6-2
Automatic Transmission.....	6-2
Manual and Automatic Fax Redial.....	6-2
Memory Transmission.....	6-3
Basic Sending Operations	6-3
Contrast.....	6-3
Resolution.....	6-4
Advanced Sending Operations	6-4
Overseas Mode	6-4
Delayed FAX.....	6-4
Setting Up for Polled Transmit.....	6-5
Canceling a Scheduled Job.....	6-5
Interrupting Delayed Fax and Polled Transmit Jobs	6-5
More Advanced Features	
(Call Brother fax-back system)	6-6

7

Auto Dial Numbers and Dialing Options	7-1
Storing Numbers for Easy Dialing	7-1
Storing One Touch Dial Numbers	7-1
Storing Speed Dial Numbers	7-2
Changing One Touch and Speed Dial Numbers.....	7-3
Setting Up Groups for Broadcasting	7-3
Dialing Options	7-4
Manual Dialing	7-4
One Touch Dialing	7-4
Speed Dialing	7-5
Dialing Access Codes and Credit Card Numbers.....	7-5
Search	7-6
Redial.....	7-6
Broadcasting.....	7-6
Pause.....	7-7
Hold	7-7
Tone/Pulse (For Canada Only).....	7-7

8

Telephone Services	8-1
Custom Features	8-1
Distinctive Ring	8-1
Registering the Distinctive Ring Pattern.....	8-1
Caller ID	8-2
Caller ID Log	8-2
Printing the Caller ID Log	8-3
Viewing the Caller ID Log.....	8-3
Returning a Call from the Log	8-3
Registering a Caller ID Number	8-4
Call Waiting Caller ID.....	8-4
CallManage (For USA Only)	8-5
Registration with CallManage	8-5
Sending a Fax Using CallManage	8-5
Placing a Telephone Call Using CallManage.....	8-6
Customer Support	8-6

9

Making Copies	9-1
Copy Functions.....	9-1
Making a Single Copy	9-1
Copy Options: Single or Multiple Copies, Reduce/Enlarge, Sort/Stack.....	9-1

10

Printing Reports	10-1
Fax Machine Settings and Activity	10-1
To Print a Report	10-1
Transmission Verification (Xmit) Report.....	10-2
Activity Report Interval.....	10-2

11

Important Information	11-1
Standard Telephone and FCC Notices	11-1
These notices are in effect on models sold and used in the United States only.	11-1
International Energy Star Compliance Statement	11-2
Industry Canada Compliance Statement (For Canada Only)	11-2
Federal Communications Commission Compliance Notice (For USA Only)	11-2
Important Safety Instructions.....	11-3

Troubleshooting and Routine Maintenance	12-1
Troubleshooting	12-1
Error Messages	12-1
If You Are Having Difficulty with Your Fax Machine.....	12-4
Printing or Receiving Faxes	12-4
Phone Line or Connections	12-5
Sending Faxes	12-5
Handling Incoming Calls	12-6
Routine Maintenance.....	12-7
Cleaning the Scanner.....	12-7
Cleaning the Print Head.....	12-7
Replacing the Print Cartridge	12-8
 Specifications	 S-1
 Index	 I-1
 Remote Fax Options.....	 R-1
Setting Up Fax Storage	R-1
Programming Paging Number	R-1
Programming a Fax Forwarding Number.....	R-2
Turning On Fax Storage	R-2
Changing Remote Access Code	R-2
Using Remote Retrieval Access Code	R-3
Calling for Messages.....	R-3
Retrieving Memory Status List	R-3
Remote Retrieval Access Card	R-3
Retrieving Fax Messages	R-4
Changing Fax Forwarding Number	R-4

1 Introduction

Using This Manual

Thank you for purchasing a Brother fax machine (FAX). This fax machine has been designed to be simple to use, with LCD screen prompts to guide you through functions. However, you can use your fax machine to its fullest potential by taking a few minutes to read this manual.



Additionally, your fax machine has a Help Key. Press **Copy/Help** and then press **Start** to print a list of basic operational steps and functions.

Finding Information

All chapter headings and subheadings are listed in the Table of Contents. You will be able to find information about a specific feature or function by checking the Index at the back of this manual. Also, throughout this manual, you'll see special symbols alerting you to important information, cross-references, and warnings. Illustrations of some screen displays also help you choose the correct key-presses.

About Fax Machines

If you're a first-time fax machine user, fax operation might seem a little mysterious. You'll soon get used to the unusual fax tones on your phone line, and be able to send and receive faxes easily.

Fax Tones and Handshake

When someone is sending a fax, the fax machine sends fax calling tones (CNG tones)—soft, intermittent beeps at 4-second intervals. You'll hear them when you dial and press **Start**, and they continue for about 40 seconds after dialing. During that time, the sending machine must begin the “handshake” with the receiving machine. Each time you use automatic procedures to send a fax, you are sending CNG tones over the phone line. You'll soon learn to listen for these soft beeps each time you answer a phone on your fax line, so you know if you are receiving a fax message.

The receiving fax responds with fax receiving tones—loud, chirping sounds. A receiving fax chirps for about 40 seconds over the phone line, and the screen displays **RECEIVE**. If your fax machine is set to the **FAX ONLY Mode**, it will answer every call automatically with fax receiving tones. Even if the other party hangs up, your fax machine continues to send the “chirps” for about 40 seconds, and the screen continues to display “**RECEIVE.**” To cancel the receiving mode, press **Stop**.

When your fax machine answers in **FAX/TEL Mode**, the fax machine listens for CNG tones and then responds with receiving tones.

The fax “handshake” is the time in which the sending machine's CNG tones and the receiving machines “chirps” overlap. This must be for at least 2 to 4 seconds, so the machines can understand how each is sending and receiving the fax. The handshake cannot begin until the call is answered, and the CNG tones only last for about 40 seconds after the number is dialed. Therefore, it's important for the receiving machine to answer the call in as few rings as possible.



When you have an external telephone answering device (TAD) on your fax line, your TAD will determine the number of rings before the call is answered. Pay special attention to the directions in the **Installation** chapter for connecting a TAD to your fax machine.

ECM (Error Correction Mode)

The Error Correction Mode (ECM) is a way for the fax machine to check the integrity of a fax transmission while it is in progress. ECM transmissions are possible only between machines that both have the ECM feature. If they do, you may send and receive fax messages that are continuously checked for their integrity.

Sufficient memory must be available in your fax machine for this feature to work.

FAX-560 Control Panel Overview

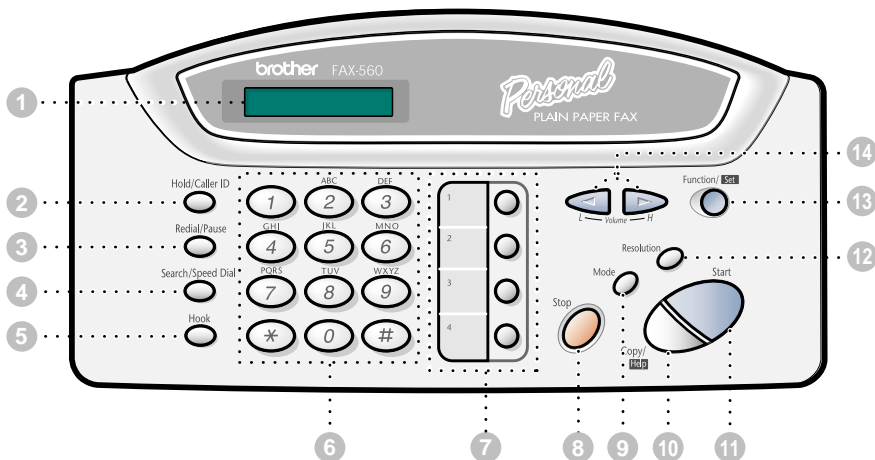

1 LCD (Liquid Crystal Display)
Displays messages to help you set up and operate your fax machine.

2 Hold/Caller ID
Lets you put calls on hold. Also, lets you view or print the Caller ID list.

3 Redial/Pause
Re-dials the last number called. Also inserts a pause in autodial numbers.

4 Search/Speed Dial
Lets you dial stored phone numbers by pressing # and a two-digit number. Also lets you look up numbers stored in the dialing memory.

5 Hook
Lets you dial telephone and fax numbers without lifting the handset.

6 Dial Pad
Dials phone and fax numbers, and can be used as a keyboard for entering information into the fax machine.

7 One Touch Dial Keys
These four keys give you instant access to previously stored phone numbers.

8 Stop
Stops a fax, cancels an operation or exits from Function mode.

9 Mode
Use to select how fax machine will handle incoming calls.

10 Copy/Help
Makes a copy. If no originals are in the ADF, it prints a quick reference Help List.

11 Start
Starts an operation, such as sending a fax.

12 Resolution
Sets the resolution when you send a fax or make a copy.

13 Function / Set
Lets you access the function and programming mode. Also, stores a function setting into the fax machine.

14 ◀ (Left Arrow) ▶ (Right Arrow) Volume
Moves the LCD cursor to the left or right. Adjusts speaker, ring and handset volume.

2

Location and Connections

Caution

- 1 Never install telephone wiring during a lightning storm.
- 2 We recommend that this product be used with a surge protection device to protect the product against lightning storms.
- 3 Never install a telephone jack in a wet location unless the jack is specifically designed for a wet location.
- 4 Never touch telephone wires or terminals that are not insulated unless the telephone line has been disconnected at the network interface.
- 5 Use caution when installing or modifying telephone lines.
- 6 Avoid using a telephone (other than a cordless type) during an electrical storm. There may be a remote risk of electric shock from lightning.
- 7 Do not use the telephone to report a gas leak in the vicinity of the leak.
- 8 For PLUGGABLE EQUIPMENT, the socket-outlet should be installed near the equipment and should be easily accessible.

Choosing a Location

Place your fax machine on a flat, stable surface, such as a desk. Select a place that is free of vibration and shocks. Locate the fax machine near a telephone jack and a standard, grounded power outlet.

-  Avoid placing your machine in a high-traffic area. Do not place near heaters, air conditioners, water, chemicals or refrigerators. Do not expose the fax machine to direct sunlight, excessive heat, moisture or dust. Do not connect your machine to electrical outlets controlled by wall switches or automatic timers. Disruption of power can wipe out information in the unit's memory. Do not connect your machine to electrical outlets on the same circuit as large appliances or other equipment that might disrupt the power supply. Avoid interference sources, such as speakers or the base units of cordless phones.

Assembly

Attach the paper wire extension

Attach the paper wire extension as shown in the illustration below.

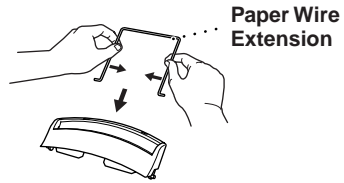

Attach the paper tray

Attach the paper tray. Make sure the wide pins on the paper tray inserted firmly into the pockets on the top edge of the machine.

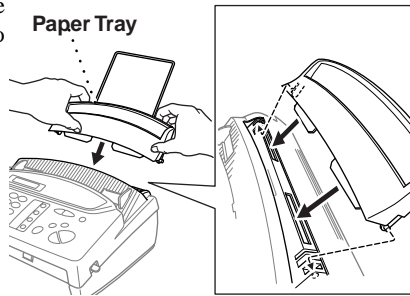

Attach the output paper support

Attach the output paper support.

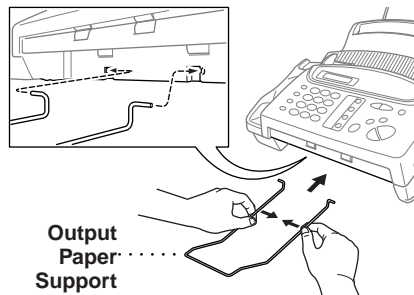

Loading the Paper

The maximum number of 20 lb. sheets you can load depends on the paper size, either 50 Letter or 30 Legal.

Temperature: 68°F (20°C)

Humidity 60%

- 1 Place paper in the paper tray.

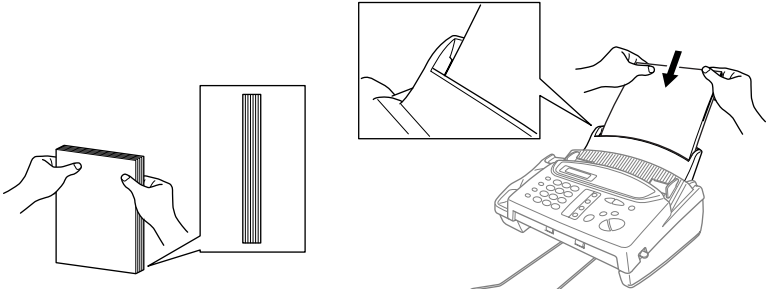

Tap the stack of paper so the edges are even.

Acceptable Paper

Size: Letter and Legal

Weight: 17 lb. – 24 lb.

Thickness: .0031 inches – .0039 inches

- ⊘ **Do not** use curled, wrinkled, folded or ripped paper, or paper with staples, paper clips, paste or tape attached. **DO NOT** use cardboard, newspaper or fabric.

Connections

Connecting the Machine

Connect the handset, power cord, and telephone line.

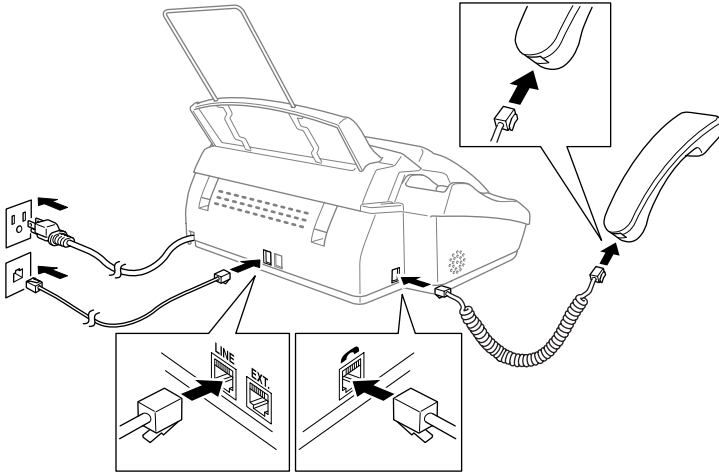

1 Connect the Handset.

Connect the curled handset cord to the bottom of the handset and the back of the machine.

2 Connect the power cord.

3 Connect the telephone line.

Connect one end of the telephone line cord to the jack labeled **LINE** on the back of the machine. Connect the other end to a modular wall jack.

WARNING

- This machine must be grounded using a three-prong plug.
- Since the machine is grounded through the power outlet, you can protect yourself from potentially hazardous electrical conditions on the telephone line by keeping the power to your machine on when you connect it to a telephone line. When you want to move your machine, protect yourself by disconnecting the telephone line first, and then the power cord.
- Lightning and power surges can damage this product! We recommend that you use a quality surge protection device on the AC power line as well as on the telephone line, or unplug the lines during a lightning storm.

Special Line Considerations

Roll Over Phone Lines

A roll over phone system is a group of two or more separate telephone lines that pass incoming calls to each other if they are busy. The calls are usually passed down or “rolled over” to the next available phone line in a preset order.

Your fax machine can work in a roll over system as long as it is the last number in the sequence, so the call cannot roll away. Do not put the fax machine on any of the other numbers; when the other lines are busy and a second fax call is received, the fax call is transferred to a line that does not have a fax machine. Your fax machine will work best on a dedicated line.

Two-Line Phone System

A two-line phone system is nothing more than two separate phone numbers on the same wall outlet. The two phone numbers can be on separate jacks (RJ11) or combined into one jack (RJ14). Your machine must be plugged into an RJ11 jack. RJ11 and RJ14 jacks may be equal in size and appearance and both may contain four wires (black, red, green, yellow). To test the type of jack, plug in a two-line phone and see if it can access both lines. If it can, you must separate the line for your machine.

Converting Telephone Wall Outlets

There are three ways to convert to an RJ11 receptacle. The first two ways may require assistance from the telephone company. You can change the wall outlets from one RJ14 jack to two RJ11 jacks. Or, you can have an RJ11 wall outlet installed and slave or jump one of the phone numbers to it.

The third way is the easiest: Buy a triplex adapter. You can plug a triplex adapter into an RJ14 outlet. It separates the wires into two separate RJ11 jacks (Line 1, Line 2) and a third RJ14 jack (Lines 1 and 2). If your Brother machine is on Line 1, plug the machine into L1 of the triplex adapter. If your machine is on Line 2, plug it into L2 of the triplex adapter.

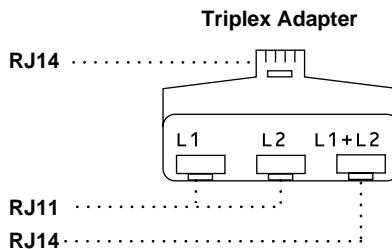

Installing Brother Machine, External Two-Line TAD, and Two-Line Telephone

When you are installing an **external** two-line telephone answering device (TAD) and a two-line telephone, your machine must be isolated on one line at both the wall jack and at the TAD. *The most common connection is to put the Brother machine on Line 2, which is our assumption in the following steps.* The back of the two-line TAD must have two telephone jacks: one labeled L1 or L1/L2, and the other labeled L2. You will need at least three telephone line cords, the one that came with your machine and two for your external two-line TAD. You will need a fourth line cord if you add a two-line telephone.

- 1 Place the two-line TAD and two-line telephone next to your Brother machine.
- 2 Plug one end of the telephone line cord for your machine into the L2 jack of the triplex adapter. Plug the other end into the **LINE** jack on the back of the machine.
- 3 Plug one end of the first telephone line cord for your TAD into the L1 jack of the triplex adapter. Plug the other end into the L1 or L1/L2 jack of the two-line TAD.
- 4 Plug one end of the second telephone line cord for your TAD into the L2 jack of the two-line TAD. Plug the other end into the **EXT.** jack on the back of the machine.

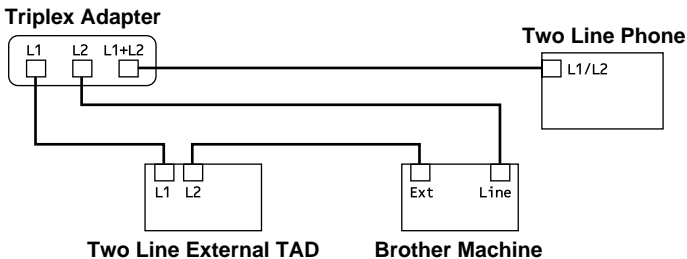

You can keep two-line telephones on other wall outlets as always. There are two ways to add a two-line telephone to the fax machine's wall outlet. You can plug the telephone line cord from the two-line telephone into the L1+L2 jack of the triplex adapter. Or, you can plug the two-line telephone into the TEL jack of the two-line TAD.

Multi-Line Connections (PBX)

Most offices use a central telephone system. While it is often relatively simple to connect the fax machine to a key system or a PBX (Private Branch Exchange), we suggest that you contact the company that installed your telephone system and ask them to connect the fax machine for you. It is advisable to have a separate line for the fax machine. You can then leave the fax machine in FAX ONLY Mode to receive faxes any time of day or night.

If the fax machine is to be connected to a multi-line system, ask your installer to connect the unit to the last line on the system. This prevents the unit from being activated each time a telephone call is received. (See *Easy Receive*, page 5-3.)

- ⊘ As with all fax units, this machine must be connected to a two wire system. If your line has more than two wires, proper connection of the fax machine cannot be made.

If you are installing the fax machine to work with a PBX:

- 1 It is not guaranteed that the unit will operate correctly under all circumstances with a PBX. Any cases of difficulty should be reported first to the company that handles your PBX.
- 2 If all incoming calls will be answered by a switchboard operator, it is recommended that the Answer Mode be set to MANUAL. All incoming calls should initially be regarded as telephone calls.
- 3 The unit may be used with either pulse or tone dialing telephone service.

Custom Features on Your Phone Line

To learn how custom features may affect your faxing operations, please see *Troubleshooting and Routine Maintenance*, Chapter 12.

Connecting an External Telephone Answering Device (TAD)

Sequence

You might choose to connect an additional answering system. When you have an external TAD on the same telephone line as the fax machine, the TAD answers all calls. The fax machine “listens” for fax calling (CNG) tones. If it hears them, the fax machine takes over the call and receives the fax. If it doesn’t hear CNG tones, the fax machine lets the TAD continue playing your outgoing message so your caller can leave you a voice message.

The TAD must answer within four rings (the recommended setting is two rings). The fax machine cannot hear CNG tones until the TAD has answered the call, and with four rings there are only 8–10 seconds of CNG tones left for the fax “handshake.” Make sure you carefully follow instructions in this manual for recording your outgoing message. We do not recommend using the toll saver feature on your external answering machine if it exceeds 4 rings.

- ⊘ Do not connect a TAD elsewhere on the same phone line—your fax machine and TAD will both try to control the line.

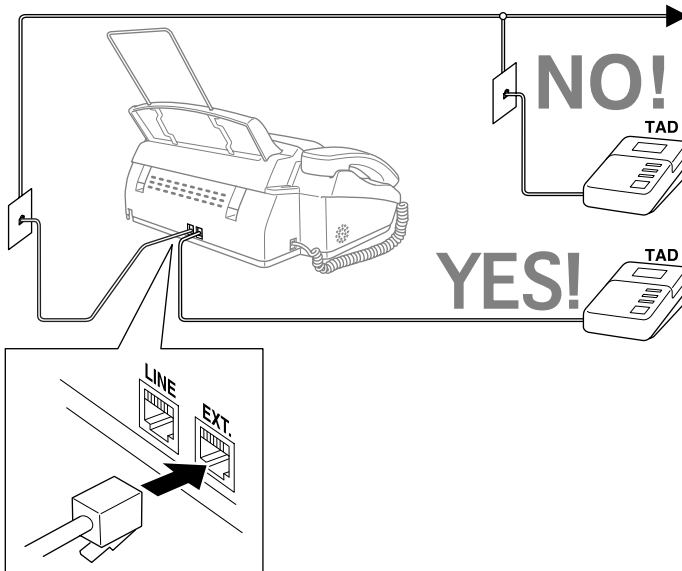

Connections

The external TAD must be plugged into the back of the fax machine, into the jack labeled EXT. Your fax machine cannot work properly if you plug the TAD into a wall jack.

- 1** Plug the telephone line cord from the wall jack into the back of the fax machine, in the jack labeled LINE.
- 2** Plug the telephone line cord from your TAD into the back of the fax machine, in the jack labeled EXT. (Make sure this cord is connected to the TAD at the TAD's telephone line jack (not to telephone set jack).)
- 3** Set your external TAD to four rings or less. (The fax machine's Ring Delay setting does not apply.)
- 4** Record the outgoing message (see below).
- 5** Set the TAD to answer calls.
- 6** Set the Answer Mode to TAD:ANSWER MACH.

Outgoing Message (OGM)

Timing is important in recording this message. The message sets up the ways to handle both manual and automatic fax reception.

- 1** Record 5 seconds of silence at the beginning of your message. (This allows your fax machine time to listen for the fax CNG tones of automatic transmissions before they stop.)
- 2** Limit your speaking to 20 seconds.
- 3** End your 20-second message by giving your Fax Receive Code for people sending manual faxes. For example:
“After the beep, leave a message or send a fax by pressing ✖ 5 1 and Start.”

Connecting an External Telephone

Your fax machine is equipped with a handset that you can use as a regular phone. However, you can also connect a separate telephone (or telephone answering device) directly to your fax machine.

Connect the modular plug on the telephone's line cord to the jack labeled EXT. on the back of the fax machine.

Whenever this phone (or TAD) is in use, the screen displays EXT. TEL IN USE, and, if the fax machine handset is lifted, an alarm sounds. To disconnect the call and switch to the fax machine, press **Hook**.

3 On-Screen Programming



User-Friendly Programming

We have designed your fax machine with on-screen programming and a Help key. User-friendly programming helps you take full advantage of all the functions your fax machine has to offer. (See *Using This Manual*, page 1-1.)

Since your fax programming is done on the LCD, we created step-by-step on-screen prompts to help you program your fax machine. All you need to do is follow the prompts as they guide you through the function menu selections and programming options and settings.

Function Mode

You can access the function mode by pressing **Function/Set**. When you enter the function mode, your fax machine displays a list of main menu options from which you can choose. These options appear one after the other on the display. Select an option by pressing **Function/Set** when the option appears on the screen.

You can “scroll” more quickly through options by pressing . When the screen displays your selection, press **Function/Set**. (Press  to scroll backward if you passed your choice or to save key strokes. Both arrow keys show all options, in the opposite order.)

Before you press **Function/Set** after entering information in a field using the dial pad, you can correct a mistake. Use  to back up and then type over the incorrect characters.



When you finish a function, the screen displays ACCEPTED.

If you want to exit the Function mode, press **Stop**.

Alternating Displays

When you see alternating displays, the LCD sometimes alternates between the currently selected option, and a help message giving brief instructions about how to proceed. The display you’ll probably see most often is shown below, showing you, when you place an original in the ADF, that you can dial a number and send a fax, or you can make a copy.



Function Selection Table

If you have a basic understanding of how to program your fax machine, you can perform most of the programming settings without the Owner's Manual. To help you understand the function selections, options, and settings that are found in your fax programs, use the Function Selection Table below.

1. INITIAL SETUP			
Function	Description	Factory Set	More Info
1. DATE/TIME	Enter date and time for LCD display and to print on transmissions.	—	4-1
2. STATION ID	Program name, fax number and telephone number to appear on each transmitted page.	—	4-1
3. BEEPER	Adjust volume level of beeper.	LOW	4-4
4. VOLUME AMPLIFY	For the hearing-impaired, you can set the volume to the VOL AMPLIFY:ON setting on a permanent or temporary basis.	OFF	4-5
5. TONE/PULSE (For Canada Only)	Selects dialing mode.	TONE	4-2
6. LOCAL LANGUAGE (For Canada Only)	Allows you to change the LCD Language to French.	ENGLISH	See French manual

2. SETUP RECEIVE			
Function	Description	Factory Set	More Info
1. RING DELAY	Number of rings before fax machine answers in FAX/TEL or FAX mode.	04	5-2
2. F/T RING TIME	Sets the time for "double ring" in FAX/TEL mode.	20	5-3
3. EASY RECEIVE	Receive fax messages without pressing the Start key.	ON	5-3
4. REMOTE CODE	Enter code to activate or deactivate machine from a remote location.	ON (* 51, #51)	5-5
5. REDUCTION	Reduces size of image.	AUTO	5-4
6. PAPER	Selects size of paper for fax receiving.	LETTER	5-4
7. POLLING RX	Sets up your fax machine to poll another fax machine.	OFF	5-6

3. SETUP SEND

Function	Description	Factory Set	More Info
1. COVERPG SETUP	Automatically sends a cover page you program.	OFF	6-6
2. COVERPAGE MSG	Program customized message for fax cover page.	—	6-6
3. CONTRAST	Change lightness or darkness of a fax you are sending.	AUTO	6-3
4. RESOLUTION	Allows you to change resolutions page by page.	STANDARD	6-6
5. OVERSEAS MODE	Adjusts for sometimes difficult overseas transmissions	OFF	6-4
6. CALL RESERVE	You can send a fax, then speak.	OFF	6-6
7. DELAYED FAX	Send originals later.	—	6-4
8. POLLED TX	Sets up your fax machine with an original to be retrieved by another fax machine.	OFF	6-5
9. MEMORY TX	You can send faxes from memory.	OFF	6-3

4. CANCEL JOB

Function	Description	Factory Set	More Info
	Cancel a delayed fax or polling job.		6-5

5. INTERRUPT

Function	Description	Factory Set	More Info
	Send a fax now, even if you have the machine set to send a fax later, or if you have it set for Polling.		6-5

6. SET AUTO DIAL

Function	Description	Factory Set	More Info
1. ONE-TOUCH DIAL	Dial numbers stored in memory by pressing only one key.	—	7-1
2. SPEED-DIAL	Dial numbers stored in memory by pressing only four keys.	—	7-2
3. SETUP GROUPS	Set up a Group number for broadcasting.	—	7-3

7. PRINT REPORTS			
Function	Description	Factory Set	More Info
1. XMIT REPORT	Print lists and reports of activity. (Details in Chapter 10)	OFF	10-1
2. ACT.REPORT		INTERVAL: OFF	10-1
3. AUTO DIAL		—	10-1
4. TEL. INDEX		—	10-1
5. USER SETTINGS		—	10-1
6. MEMORY STATUS		—	10-1

8. REMOTE FAX OPT			
Function	Description	Factory Set	More Info
1. FAX FWD/PAGING	Set fax machine to forward fax/message— OR —to call your pager.	OFF	R-2
2. FAX STORAGE	Store incoming fax in memory for remote retrieval.	OFF	R-1
3. REMOTE ACCESS	Set code for retrieving faxes.	159✕	R-2
4. PRINT FAX	Print incoming faxes stored in the memory.	—	5-6

0. TEL SERVICE			
Function	Description	Factory Set	More Info
1. DISTINCTIVE	Use with phone company Distinctive Ring service to register the ring pattern with fax machine.	OFF	8-1
2. CALLER ID (For USA only)	Register your AREA CODE to dial from the Caller ID Log.	—	4-3

4 Initial Setup

Getting Started

After you have assembled your machine using the Brother StartCard, continue the initial setup by programming the rest of the initial settings.

Setting Date and Time

Your fax machine displays the date and time, and prints it on every fax you send.

In the event of a power failure, the fax machine maintains date and time information for up to two hours. All other settings remain unaffected.

- 1 Press **Function/Set, 1, 1.**
- 2 Enter the last two digits of the year and press **Function/Set.**
- 3 Enter two digits for the month and press **Function/Set.** (For example, enter 09 for September, or 10 for October)
- 4 Enter two digits for the day and press **Function/Set.** (For example, 06)
- 5 Enter the time in 24-hour format and press **Function/Set.** (For example, enter 15:25 for 3:25 PM)
- 6 Press **Stop.** The screen now displays the date and time you set, and displays it whenever the fax machine is in Standby mode.

Choosing Station ID

You can store your name, fax number, and telephone number to be printed on all fax pages.



- 1 Press **Function/Set, 1, 2.**
- 2 Enter your fax number (up to 20 digits) and press **Function/Set.**
- 3 Enter your telephone number (up to 20 digits) and press **Function/Set.** If your telephone number and fax number are the same, enter the same number again. The screen displays your entry.
- 4 Use the dial pad to enter your name (up to 20 characters) and press **Function/Set.** (You can use the chart on next page to help you enter letters.)
- 5 Press **Stop.** The screen returns to the date and time.

Setting Tone/Pulse Dialing Mode (For Canada Only)

Your fax machine comes set to accommodate tone (multi-frequency) dialing service. If you have pulse (rotary) dialing service, you need to change the dialing mode.

- 1 Press **Function/Set**, **1**, **5**.

DIALING:TONE?

- 2 Press  or  to select TONE or PULSE and press **Function/Set**.

DIALING:PULSE?

- 3 Press **Stop** to exit.

Details for Entering Text

When you are setting certain functions, such as the Station ID, you may need to enter text into the fax machine. Most keys on the dial pad have three or four letters printed above them. The keys for 0, # and * don't have printed letters because they are used for special characters or operations.

By pressing the appropriate number on the dial pad the correct number of times, you can access the character you want.

Press Key	one time	two times	three times	four times
2	A	B	C	2
3	D	E	F	3
4	G	H	I	4
5	J	K	L	5
6	M	N	O	6
7	P	Q	R	S
8	T	U	V	8
9	W	X	Y	Z

Inserting spaces

If you want to enter a blank space, press  twice.

Making corrections

If you entered a letter incorrectly and want to change it, press  to move the cursor after the last correct letter. Then press **Stop**; the letters above and to the right of the cursor are deleted. Re-enter the correct text and/or digits. You can also back up and type over incorrect letters.

Repeating letters

If you need to enter a character assigned to the same key as the previous character, press  to move the cursor to the right.

Special characters and symbols

Press * repeatedly for (space) ! “ # \$ % & ’ () * + , - . /

Press # repeatedly for : ; < = > ? @ [] ^ _

Press Ø repeatedly for É À È Ê Î Ç Ë Ö 0

NOTICE

The Telephone Consumer Protection Act of 1991 makes it unlawful for any person to use a computer or electronic device to send any message via a telephone fax machine unless such messages clearly contain, in a margin at the top or bottom of each transmitted page, or on the first page of the transmission, the date and time it is sent and an identification of the business or other entity or other individual sending the message and the telephone number of the sending machines or such business, other entity or individual.

In order to program this information into your fax machine, you should complete the steps described on page 4-1.



- The telephone number you enter is used only for Call Back Message and Cover Page features.
- If you do not enter a fax number, no additional information can be entered.
- To enter a space, press  once between numbers and twice between characters.
- If your Station ID has already been programmed, the screen prompts “1” to make a change, or “2” to exit without changing.

Setting Up Your Area Code (For USA Only)

You must set up your area code in Caller ID.

1 Press **Function/Set, 0, 2.**

AREA CODE:000

2 Use the dial pad to enter your area code and press **Function/Set.**

AREA CODE:908

3 Press **Stop** to exit.

Setting Beeper Volume

You can set the beeper to LOW, HIGH or OFF. The default setting is **LOW**. When the beeper is set to LOW or HIGH, the fax machine beeps every time you press a key or make an error, and at the end of fax sending or receiving.

- 1 Press **Function/Set**, **1**, **3**.
- 2 Press \leftarrow or \rightarrow to select your setting and press **Function/Set**.
- 3 Press **Stop** to exit.

Choosing the Handset Volume

Before you begin to use the fax machine, you must decide if you need to set the handset volume to AMPLIFY:ON for a user who is hearing-impaired. The AMPLIFY volume level complies with FCC standards.

VOLUME AMPLIFY: OFF

This default setting is appropriate if none of the users are hearing-impaired. During a conversation, users can press \leftarrow or \rightarrow on the control panel to adjust the volume. When the handset is replaced, the handset volume remain until you change it again.

VOLUME AMPLIFY: ON-TEMPORARY

This setting is appropriate if some of the users are hearing-impaired. During a conversation, users can press \leftarrow or \rightarrow on the control panel to adjust the volume to LOW, HIGH or AMPLIFY. When the handset is replaced, the handset volume will returns to the default setting of LOW.

VOL AMPLIFY:ON-PERMANENT

Choose VOL AMPLIFY:ON-PERMANENT if all of the users are hearing-impaired. During a conversation, users can press \leftarrow or \rightarrow on the control panel to adjust the volume to LOW, HIGH or AMPLIFY. When the handset is replaced, the handset volume returns to the default setting of AMPLIFY.



When you press \leftarrow or \rightarrow on the control panel to adjust the volume, the display shows the setting you are choosing. Each key press changes the volume to the next setting.



WARNING

It is important that you do not choose PERMANENT unless all users are hearing-impaired. Otherwise, the default setting of AMPLIFY may damage the hearing of some users.

Setting Volume Amplify

Please carefully read “Setting the Handset Volume” before you do the following steps:

- 1 Press **Function/Set, 1, 4.**
- 2 Press $L \leftarrow$ or $\rightarrow H$ to select **VOL AMPLIFY:OFF?** if none of the users are hearing-impaired and go to Step 4—**OR**—If some or all of the users are hearing-impaired, select **VOL AMPLIFY:ON?**
- 3 Press $L \leftarrow$ or $\rightarrow H$ to select **PERMANENT?** if all the users are hearing-impaired—**OR**—Select **TEMPORARY?** if only some of the users are hearing-impaired..
- 4 Press **Function/Set.**
- 5 Press **Stop** to exit.



Setting the Speaker Volume

You can adjust the speaker volume when your fax machine is onhook (after you pressed **Hook**), by selecting a speaker volume level.

Press $L \leftarrow$ or $\rightarrow H$ to adjust the volume level. The display shows the setting you are choosing. Each key press changes the volume to the next setting. The new setting will remain until you change it again.

Setting the Ring Volume

You can adjust the ring volume when your fax machine is idle. You can select a ring volume level or press until the ring is off.

Press $L \leftarrow$ or $\rightarrow H$ to adjust the volume level. With each key press, the fax machine rings so you can hear the current setting and the display shows the setting you are choosing. Each key press changes the volume to the next setting. The new setting will remain until you change it again.

Memory Storage

In the event of a power failure, all settings in the INITIAL SETUP, SETUP RECEIVE, SET AUTO DIAL and REMOTE FAX OPT plus the COVERPG SETUP and COVERPAGE MSG (from SETUP SEND) functions are stored permanently. You may have to reset the date and time.

5 Setup Receive

Basic Receiving Operations

Select Answer Mode

MANUAL—You must answer all calls yourself. If you hear fax tones, press **Start** to begin receiving the fax, then hang up. You can use this mode with Distinctive Ringing. (See *Distinctive Ring*, page 8-1.)

FAX ONLY—The fax machine automatically answers every call as a fax call. You cannot receive a voice call, but you can dial out and make a voice call.

FAX/TEL—The fax machine automatically answers every call. If the call is a fax, it prints the fax. If the call is not a fax, it signals you with a double ring (ring-ring), different from the phone company ringing, to alert you to pick up the call. If you select this setting, you'll need to set the Ring Delay and F/T Ring Time features (on the following pages). If you have extension phones on the same line as the fax machine, set Ring Delay to 4. (See *For FAX/TEL Mode Only*, page 5-5.)

TAD—This is the only setting in which you can use an external answering machine. Your telephone answering device is connected to your FAX, and answers every call. Once the TAD answers, the FAX listens for fax tones. If it detects fax tones, it prints the fax.

The TAD setting works only with an external telephone answering device (TAD); it does not work with telephone company voice mail. Ring Delay and F/T Ring Time do not work in this setting.

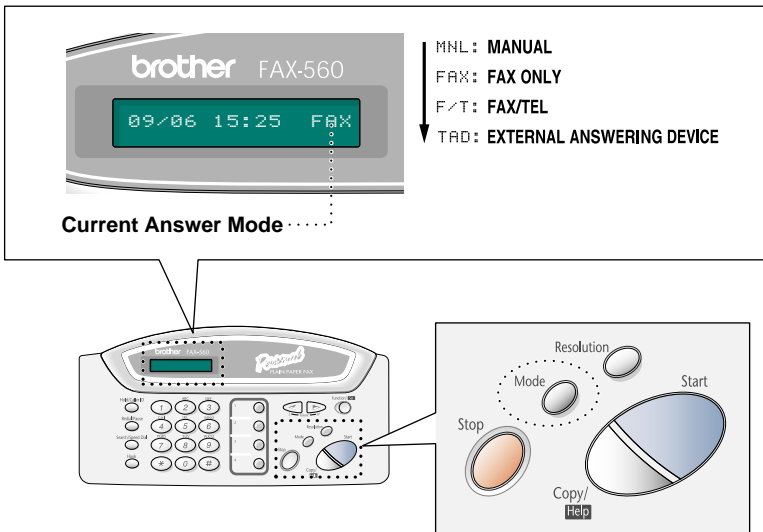

To select or change your Answer Mode

- 1 Press **Mode**. The screen displays your current selection.

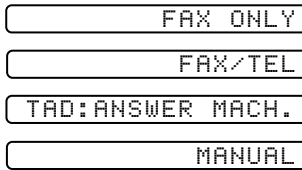



- 2 Continue to press **Mode** until your new selection appears. After 2 seconds, the screen returns to the date and time display, along with your new Answer Mode setting.



If you're changing Answer Mode while in another operation, the screen returns to the current operation display.



Setting Ring Delay

The Ring Delay setting determines the number of times the fax machine rings before it answers. If you have extension phones on the same line as the fax machine, keep the Ring Delay default setting of **4**. (See *Easy Receive*, page 5-3 and *Operation from External or Extension Telephone*, page 5-5 and *For FAX/TEL Mode Only*, page 5-5.)

- 1 Press **Function/Set, 2, 1**.
- 2 Press  or  to select how many times the line rings before the fax machine answers (00 – 04) and press **Function/Set**. If you select 00, the line doesn't ring at all.
- 3 Press **Stop** to exit.

Setting F/T Ring Time

You need to determine how long the fax machine will notify you with its special double ring when you have a voice call. This ringing happens after the initial ringing from the phone company. Only the fax machine rings, for 20, 30, 40 or 70 seconds; no other phones on the same line ring the special double ring. However, you can answer the call on any phone on the same line as the fax machine.

- 1 Press **Function/Set, 2, 2**.
- 2 Press  or  to select how long the fax machine will ring to alert you that you have a voice call and press **Function/Set**.
- 3 Press **Stop** to exit.

RING TIME: 20 SEC

Now, when a call comes in and the machine is set to FAX/TEL Mode, all phones on this line will ring the number of times you selected in Ring Delay.

You can let the fax machine pick up and detect if it's a fax or voice call. If it's a fax call, the machine prints the fax. If it's a voice call, the machine signals you with a double ring for the length of time you selected in F/T Ring Time.





Even if the caller hangs up during the double ringing, the fax machine continues for the set time.

Easy Receive



When you use this feature, you don't have to press **Start** when you answer a fax call and hear calling beeps. Just hold the handset and wait a few seconds. When you see RECEIVE on the fax screen or when you hear "chirps" through the handset of an extension phone connected to another wall jack, just replace the handset, and your machine does the rest. Selecting **ON** allows the fax machine to receive fax calls automatically, even if you lift the handset of an extension or external phone. Selecting **SEMI** lets the machine receive the call only if you've answered it at the fax machine. Selecting **OFF** means you'll have to activate the fax machine yourself, by pressing **Start** or by pressing *** 5 1** if you are not at your machine. (See *Operation from External or Extension Telephone* and *For FAX/TEL Mode Only*, page 5-5.)

If you've set the feature to **ON**, but your fax machine doesn't automatically connect a fax call when you lift an external or extension phone handset, press the Fax Receive code *** 5 1**. At the fax machine, lift the handset and press **Start**.

- 1 Press **Function/Set, 2, 3**.
- 2 Press  or  to select **ON, SEMI** or **OFF** and press **Function/Set**.
- 3 Press **Stop** to exit.

Printing a Reduced Incoming original

You can always reduce the size of an incoming fax to a fixed percentage, regardless of the size of the paper (up to legal) in your fax machine. If you choose AUTO, your machine chooses the level of reduction for you.

- 1 Press **Function/Set, 2, 5.** 
- 2 Press  or  to select the reduction ratio you want (AUTO, 93%, 87% or 75%) and press **Function/Set**. Choose 100% if you don't want a reduction.
- 3 Press **Stop** to exit.

Recommended Reductions





If your paper is letter size (8.5" x 11"), and the incoming fax is
letter size, select 93%
A4, select 87%
legal size, select 75%.

If your paper is A4 (8.2" x 11.6"), and the incoming fax is
letter size, select 100%
A4, select 93%

If your paper is legal size (8.5" x 14"), and the incoming fax is
letter size, select 100%
A4, select 100%
legal size, select 93%.

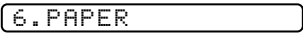
Setting Paper Size

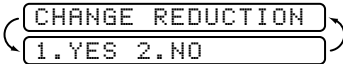
You can use three sizes of paper for printing your faxes—letter, legal and A4. When you change the kind of paper you have loaded in the fax machine, you will need to change the setting for paper size, so your machine will know how to fit the incoming fax on the page. You can also select the level of page reduction to fit on the paper in your machine.

- 1 Press **Function/Set, 2, 6.** 
- 2 Press  or  to select LETTER, LEGAL or A4 and press **Function/Set**. 
- 3 Press **1** if you want to change the reduction setting—**OR**—Press **2** to go to Step 5.
- 4 Press  or  to select **AUTO, 100%, 93%, 87%** or **75%** and press **Function/Set**.
- 5 Press **Stop** to exit.

Advanced Receiving Operations

Operation from External or Extension Telephone

If you answer a fax call on an extension phone or on an external phone in the EXT. jack, you can make your fax machine take over by using the Fax Receive Code. When you press the Fax Receive Code *** 5 1**, the fax machine starts to receive a fax. (See *Easy Receive*, page 5-3.)

If the fax machine answers a voice call and double-rings for you to take over, use the Telephone Answer Code **# 5 1** to take the call at an extension phone. (See *Setting F/T Ring Time*, page 5-3.)

If you answer a call, and no one is on the line, assume you're receiving a fax. At the fax machine phone, press **Start**, then hang up. At an extension phone, press *** 5 1**, wait for fax receiving tones (chirps), then hang up. At an external phone, press *** 5 1** and wait for the phone to be disconnected (the screen displays RECEIVE) before you hang up. (Your caller will have to press **Start** to send the fax.)

For FAX/TEL Mode Only

When the fax machine is in FAX/TEL mode, it will use the F/T Ring Time (double ringing) to alert you to a voice call. If you're at the fax machine, you can lift the handset to answer.

If you're at an extension phone, you'll need to lift the handset during the F/T Ring Time and press **# 5 1** between the double rings. If no one is on the line, or if someone wants to send you a fax, send the call back to the fax machine by pressing *** 5 1**.

Changing Remote Codes

Remote Codes might not work with some telephone systems. The preset Fax Receive Code is *** 5 1**. The preset Telephone Answer Code is **# 5 1**.



If you are always disconnected when accessing your external TAD remotely, try changing the Fax Receive Code from *** 5 1** to **###** and the Telephone Answer Code from **# 5 1** to **9 9 9**.

To change Remote Codes

- 1 Press **Function/Set**, **2**, **4**.
- 2 Press **◀** or **▶** to select ON (or OFF) and press **Function/Set**.
- 3 If you want to, enter a new Fax Receive Code, then press **Function/Set**.
- 4 If you want to, enter a new Telephone Answer Code, then press **Function/Set**.
- 5 Press **Stop** to exit.

REMOTE ACT.:ON?

FAX RECEIVE:*51

TEL ANSWER:#51

Printing a Fax in Memory

If you have Fax Storage ON for remote retrieval, you can still print a fax in the memory when you are at your machine:

- 1** Press **Function/Set, 8, 4.**
- 2** Press **Start.**
- 3** Press **Stop.**
(See *Turning On Fax Storage*, page R-2.)

Polling



Polling is the process of retrieving faxes from another fax machine. You can use your fax machine to “poll” other machines, or you can have someone poll your machine. All parties involved in polling need to set up their fax machines to accommodate polling. When someone polls your machine to receive a fax, they pay for the call; if you poll someone’s fax machine to receive a fax, you pay for the call.
(See *Canceling a Scheduled Job*, page 6-5.)

For details about the Polling function, our fax-back system 1-800-521-2846 (USA), 1-800-681-9838 (From within Canada) and request Document #: 20918.



Some fax machines do not respond to the polling function.

6 Setup Send

Automatic Document Feeder (ADF)

- originals must be between 5.8 and 8.5 inches wide, and 5.9 and 23.7 inches long. Your fax machine can only scan an image 8.2 inches wide, regardless of how wide the paper is.
- Make sure you place the original **face down, top edge first**.
- Adjust the paper guides to fit the width of your original.

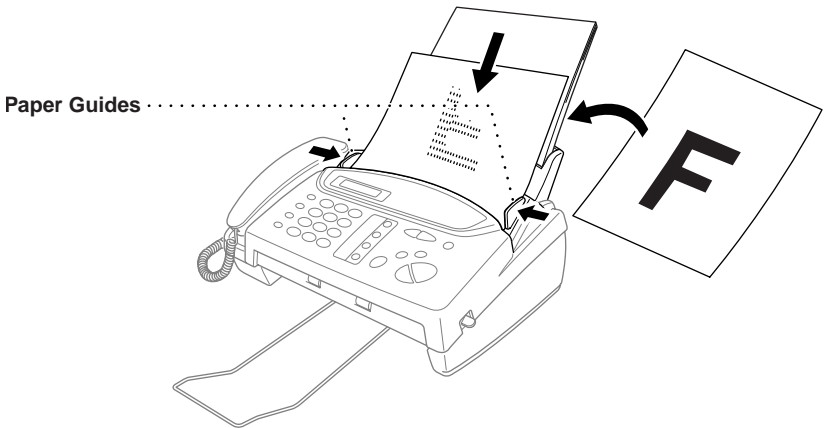

- The automatic document feeder (ADF) can hold up to 10 pages, feeding each one individually through the fax machine. Use standard (17 lb–24 lb) paper when using the ADF; if you're using heavier paper, feed each sheet individually to prevent paper jams.
- ⊘ **DO NOT** use curled, wrinkled, folded or ripped paper, or paper with staples, paper clips, paste or tape attached. **DO NOT** use cardboard, newspaper or fabric.
- Make sure originals written with ink are completely dry.
- 🔍 You must press **Resolution** (before you send the fax) to select the resolution for the type of original you're sending. (See *Resolution*, page 6-4.)

Manual Transmission

Manual transmission lets you hear the dial tone, ringing and fax receiving tones before sending the fax.

- 1** Place the original face down in the ADF.
- 2** Pick up the handset and listen for a dial tone
—**OR**—press **Hook** and listen for a dial tone.
- 3** Enter the fax number you want to call. (You can enter the digits using the dial pad, or you can enter a One Touch or Speed Dial number or you can call using **Search/Speed Dial**.) (See *One Touch Dialing*, page 7-4 and *Search*, page 7-6.)
- 4** When you hear the fax tone, press **Start**.
- 5** If you're using the handset, hang up.

Automatic Transmission

This is the easiest way to send a fax.

IMPORTANT: Do **not** pick up the handset, or press **Hook**.

- 1** Place the original face down in the ADF.
- 2** Enter the fax number using One Touch, Speed Dial, Search or the dial pad. (See *One Touch Dialing*, *Speed Dialing* and *Search*, page 7-4 to 7-6.)
- 3** Press **Start**.







Manual and Automatic Fax Redial

If you're sending a fax manually and the line is busy, press **Redial/Pause** to retry the number.

If you're sending a fax automatically and the line is busy, the fax machine will redial automatically up to three times at 5 minute intervals.

Memory Transmission

This feature allows your machine to scan a fax into its memory and send it as soon as the scan is complete. This way, you don't have to wait for the entire fax to be transmitted before you retrieve your original.

- 1 Place the original face down in the ADF.
- 2 Press **Function/Set, 3, 9.**
- 3 To change the default setting, press  or  to select ON (or OFF) and press **Function/Set.** Go to Step 5—**OR**—For the next fax transmission only, press  or  to select NEXT FAX ONLY and press **Function/Set.**
- 4 For the next fax only, press  or  to select ON (or OFF) and press **Function/Set.**
- 5 Press **1** to select additional settings. The display returns to the SETUP SEND menu—**OR**—Press **2** if you are finished choosing settings and go to Step 6.
- 6 Enter fax number and press **Start.**

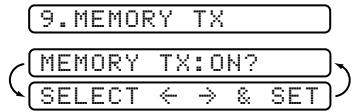



 If you get a MEMORY FULL message while scanning the first page of a fax, press **Stop** to cancel the scan. If you get a MEMORY FULL message while scanning in a subsequent page, you'll have the option to press **Start** to transmit the pages scanned so far, or to press **Stop** to cancel the operation. In this case, send the fax by the Manual Transmission.

 Depending on your typical faxes, MEMORY FULL errors can occur frequently. If this happens, change the Memory Transmission setting back to OFF.

Basic Sending Operations

Contrast

If your original is very light or very dark, you might want to set the contrast accordingly. Use S.LIGHT to send a very light original. Use S.DARK to send a very dark original.

- 1 Place the original face down in the ADF.
- 2 Press **Function/Set, 3, 3.**
- 3 Press  or  to select AUTO, S.LIGHT or S.DARK and press **Function/Set.**
- 4 Press **2** if you are finished choosing settings, and go to Step 5—**OR**—Press **1** if you want to select additional settings. The display returns to the Setup Send menu.
- 5 Enter a fax number and press **Start** to send a fax—**OR**—Press **Copy/Help** to make a copy.

Resolution

When you have an original in the ADF, you can use the **Resolution** key. Press **Resolution** continuously until you see your selection on the screen.

Standard—suitable for most typed originals.

Fine—good for small print; transmits a little slower than standard resolution.

Super Fine—good for small print or artwork; transmits slower than fine resolution.



Photo—use when original has varying shades of gray; slowest transmission time.

Advanced Sending Operations

Overseas Mode

If you have difficulty sending a fax overseas, use the Overseas mode.

After you send a fax using this feature, the feature turns itself off.

- 1 Place the original face down in the ADF.
- 2 Press **Function/Set, 3, 5.** 
- 3 Press  or  to select ON (or OFF) and press **Function/Set.**
- 4 Press **1** if you want to select additional settings. The display returns to the Setup Send menu—**OR**—Press **2** if you are finished choosing settings and go to Step 5.
- 5 Enter the fax number you're calling.
- 6 Press **Start.**

Delayed FAX

You can use this function to send a fax up to 24 hours later.

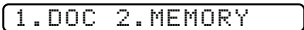
- 1 Place the original face down in the ADF.
- 2 Press **Function/Set, 3, 7.**
- 3 Enter the time you want the fax to be sent, in 24-hour format and press **Function/Set.** (For example, enter 19:45 for 7:45 PM)
- 4 Press **1** to leave the originals waiting in the ADF—**OR**—Press **2** to scan the original into memory. 
(See *Interrupting Delayed Fax and Polled Transmit Jobs*, page 6-5.)
- 5 Press **1** to select additional settings. The display returns to the SETUP SEND menu—**OR**—Press **2** if you are finished choosing settings and go to Step 6.

- 6 Enter the fax number.
- 7 Press **Start**. The machine will wait to send the fax at the time you set up.





Setting Up for Polled Transmit

Polled Transmit is when you set up your fax machine to wait with an original so another fax machine can retrieve it.

For more information call our fax-back system at 1-800-521-2846 (USA), 1-800-681-9838 (from within Canada) and request Document #: 21707.

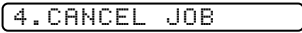

Canceling a Scheduled Job

You can cancel tasks you've scheduled, such as Delayed Fax or Polling Transmit.

- 1 Press **Function/Set, 4**. Any waiting jobs appear on the display. If there are no jobs waiting, the screen displays NO JOB WAITING. 
- 2 If you have more than two jobs waiting, press  or  to select the job you want to cancel and press **Function/Set**.
—OR—
If you have only one job waiting, go to Step 3.
- 3 Press **1** to cancel—OR—Press **2** to exit without canceling.
- 4 Press **Stop** to exit.

Interrupting Delayed Fax and Polled Transmit Jobs

You can send a fax or make a copy now, even if you have the fax machine set to send a fax later, or if you have it set to be polled. However, you cannot use automatic redial or the function mode.

- 1 Press **Function/Set, 5**.
 - 2 Wait 2 seconds, then remove the original that is waiting in the ADF. 
 - 3 Place the original you want to send now in the ADF.
 - 4 Enter the number for the fax you want to send now.
 - 5 Press **Start**.
 - 6 After the transmission is finished, return the first original to the ADF.
 - 7 Press **Function/Set, 5** to restore the Delayed Fax and/or Polling.
-  If you have set up a Delayed Fax or Polled Transmit job in memory, you don't have to interrupt it to send a fax or make a copy.



If you have set up a Delayed Fax or Polled Transmit job, the machine will send an original without storing it in memory.

More Advanced Features (Call Brother fax-back system)

Your machine has additional advanced features and functions that are not included in this manual. To receive faxed instructions, please call our automated Brother fax-back system at 1-800-521-2846 and enter the Document Numbers for the following scripts:

- Polling (Doc #: 21707)
- Cover Page (Doc #: 20918)
- Call Reservation (Doc #: 21708)
- Print Sample Call Back Message (Doc #: 21709)
- Next Fax Reservation (Doc #: 21710)
- Multiple Resolution Transmission (Doc #: 21711)
- Glossary (Doc #: 21712)

7 Auto Dial Numbers and Dialing Options

Storing Numbers for Easy Dialing

You can set up your fax machine to do three types of easy dialing: One Touch, Speed Dial, and Groups for Broadcasting of faxes.



If you lose electrical power, auto dial numbers in memory will not be lost.

Storing One Touch Dial Numbers

You can store four fax/phone numbers that you can dial by pressing one key (and **Start**). You also can store names with these numbers. When you press a One Touch dial location, the screen displays the name or number as the call is dialed. (See *One Touch Dialing*, page 7-4.)

One Touch keys are not the dial pad keys. They are the four keys (numbers 1–4) located in the middle of the control panel.

1 Press **Function/Set**, **6**, **1**.

2 Press the One Touch key where you want to store a number.



(One Touch key **1** is pre-programmed for Brother fax-back system, USA only. You can override it if you wish.) The screen displays the location you selected.



3 Enter a number (up to 20 digits) and press **Function/Set**.

NAME :



If you want to enter a pause in the dialing sequence (to wait for an “outside line,” for example), press **Redial/Pause** as you’re entering digits. Pressing **Redial/Pause** enters a 3.5-second pause when the number is dialed, and a dash appears on the screen.

4 Use the dial pad to enter the name or company (up to 15 characters) and press **Function/Set**. You can use the chart on page 17 to help you enter letters—**OR**—To store the number without a name, press **Function/Set**. (See *Details for Entering Text*, page 4-2.)

5 Press  or  to select the type of number and press **Function/Set**.

FAX a fax only number

TEL a telephone (voice) number

FAX/TEL both a fax and telephone (voice) number

CHAIN a number (usually an access code) for chain dialing.

- 6 Press to Step 2 to store another One Touch number—**OR**—Press **Stop** to exit.

When you dial an AUTO DIAL number, the screen displays the name you've stored, or, if you haven't stored a name, the number you've stored.



If you must wait for another dial tone at any point in the dialing sequence, store a pause at that place in the number by pressing **Redial/Pause**. Each key press adds a 3.5 second pause.

You can use chain dialing to store long dialing sequences. For example, to store **9 1 201 555 1234 987 65 4321**, divide the number into two parts. Store the first part as a Chain type number (this tells the system that the dialing sequence is not complete).

CHAIN—9 1 201 555 1234



The last part of the One Touch number must be stored as any of the other following three types.

FAX or FAX/TEL or TEL—987 65 4321

Now, when you dial, just press the two keys (one after the other, in order) where you've stored the two parts of the number.

Storing Speed Dial Numbers

You can store Speed Dial numbers, when you dial by pressing only four keys. There are 50 Speed Dial locations.

- 1 Press **Function/Set, 6, 2**.
- 2 Use the dial pad to enter a two-digit location (01–50) and press **Function/Set**.
- 3 Enter the number (up to 20 digits) and press **Function/Set**.
- 4 Use the dial pad to enter the name or company (up to 15 characters) and press **Function/Set—OR—Press Function/Set** to store the number without a name. (See *Details for Entering Text*, page 4-2.)
- 5 Press  or  to select the type of number and press **Function/Set**.

SPEED-DIAL? #

#05:

ENTER & SET



NAME:

- FAX** a fax only number
- TEL** a telephone (voice) number
- FAX/TEL** both a fax and telephone (voice) number
- CHAIN** a number (usually an access code) for chain dialing.

- 6 Return to Step 2 to store another Speed Dial number—**OR**—Press **Stop** to exit.



Changing One Touch and Speed Dial Numbers

If you try to store a One Touch or Speed Dial number in a location where a number is already stored, the screen displays the current name stored there, then prompts you to either **1. CHANGE—OR—2. EXIT.**

- 1 Press **1** to change the number stored, or press **2** to exit without making a change.
- 2 Enter a new number.
 - If you want to erase the whole number, press **Stop** when the cursor is to the left of the digits. The letters above and to the right of the cursor are deleted.
 - If you want to change a digit, use  or  to position the cursor under the digit you want to change, then type over it.
- 3 Follow the directions from Step 3 in Storing One Touch Numbers or Storing Speed Dial Numbers.

Setting Up Groups for Broadcasting

Groups allow you to send the same fax message to many fax numbers by pressing only one One Touch key (Broadcasting). **First**, you'll need to store each fax number as a One Touch or Speed Dial number. **Then**, you can combine them into a Group. **Each Group uses up a One Touch key.** **Finally**, you can have up to four small Groups, or you can assign up to 53 numbers to one large Group. (See *Storing One Touch Dial Numbers*, page 7-1, *Storing Speed Dial Numbers*, page 7-2 and *Broadcasting*, page 7-6.)

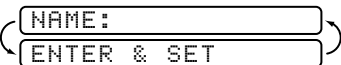
- 1 Press **Function/Set, 6, 3.** 
- 2 Select a One Touch key where you wish to store the number. (For example, press One Touch key **2** to store a Group.)
- 3 Use the dial pad to identify the Group with a number and press **Function/Set**. (For example, press **1** for Group 1.) 
- 4 To include One Touch or Speed Dial numbers in the Group, enter them as if you were dialing. For example, for One Touch key 3, press One Touch key **3**. For Speed Dial location 09, press **Search/Speed Dial**, then press **0, 9** on the dial pad. The LCD shows ***03, #09**. 
- 5 Press **Function/Set** to accept the numbers for this group. 
- 6 Use the dial pad to enter a name for the group and press **Function/Set**. (For example, NEW CLIENTS) (See *Details for Entering Text*, page 4-2.)
- 7 Press **Stop** to exit.



You can print a list of all One Touch and Speed Dial numbers. See *Printing Reports*, Chapter 10.

Dialing Options

You can use your fax machine to make voice telephone calls, by dialing manually, or by using Search, One Touch or Speed Dial memory. You can use the handset to make and receive calls.

When you dial an auto dial number, the screen displays the name you've stored, or, if you have'nt stored a name, the fax number you've stored.

Manual Dialing

Manual dialing is simply pressing all of the digits of the phone number.

- 1 Pick up the handset—**OR**—Press **Hook**.
- 2 When you hear a dial tone, dial the call using the dial pad.
- 3 If you pressed **Hook** to dial the call, pick up the handset when the other party answers. (The speaker works only one way; the other party won't be able to hear you unless you pick up the handset.)
- 4 To hang up, replace the handset.

One Touch Dialing

- 1 Pick up the handset—**OR**—Press **Hook**. (See *Storing One Touch Dial Numbers*, page 7-1.)
- 2 When you hear a dial tone, press the One Touch key of the location you want to call.
- 3 If you pressed **Hook** to dial the call, pick up the handset when the other party answers. (The speaker works only one way; the other party won't be able to hear you unless you pickup the handset.)
- 4 To hang up a voice call, replace the handset.



If you try to use a One Touch location with no number stored in it, you hear a warning sound, and screen displays NOT REGISTERED. The display returns to normal after 2 seconds.



If you are sending a fax, press **Start** after pressing the One Touch key. If you picked up the handset, press **Start** when the receiving fax machine answers with fax tones.

Speed Dialing

- 1 Pick up the handset—**OR**—Press **Hook**. (See *Storing Speed Dial Numbers*, page 7-2.)
 - 2 When you hear a dial tone, press **Search/Speed Dial**, press **#**, then press the two-digit Speed Dial number.
 - 3 If you pressed **Hook** to dial the call, pick up the handset when the other party answers. (The speaker works only one way; the other party won't be able to hear you unless you pickup the handset.)
 - 4 To hang up a voice call, replace the handset.
-  If you are sending a fax, press **Start** after entering the Speed Dial number. If you picked up the handset, press **Start** when the receiving fax machine answers with fax tones.

Dialing Access Codes and Credit Card Numbers

Sometimes you may want to choose from among several long distance carriers when you make a call. Rates may vary depending upon the time and destination. To take advantage of low rates, you can store the access codes or long-distance carriers as One Touch and Speed Dial numbers. You can store these long dialing sequences by dividing them and setting them up separately in any combination. You can even include manual dialing using the dial pad. The combined number will be dialed in the order you entered it, as soon as you press **Start**. Make sure you selected CHAIN as the type of the number when you store it into the One Touch or Speed Dial. (See *Storing One Touch Dial Numbers and Storing Speed Dial Numbers*, page 7-1 to 7-2.)

-  The CallManage access code can save you money on long distance calls (for details, see *CallManage*, page 8-5). (*For USA Only*)



For example:

You store “555” on One Touch key **03** and “7000” on One Touch key **02**. If you press One Touch **03**, **02** and **Start** you will dial “555-7000”. To temporarily change a number, you can substitute part of the number with manual dialing using the dial pad. For example, to change the number to 555-7001 you can press One Touch **03** and press **7**, **0**, **0**, **1** using the dial pad.

-  Pause after dialing Speed Dial numbers for the name to be displayed before you enter the next portion of the dialing sequence.

Search

You can search for names you have stored in One Touch and Speed Dial memories. Names are shown alphabetically. (See *Storing One Touch Dial Numbers*, page 7-1 and *Storing Speed Dial Numbers*, page 7-2.)

- 1 Press **Search/Speed Dial**, then enter the first letter of the name you're looking for.
- 2 Press  or  to search the memory.
- 3 When the screen displays the name you want to call, pick up the handset for a voice call.
- 4 Press **Start** to begin dialing.
- 5 If you pressed **Hook** to dial the call, pick up the handset when the other party answers. (The speaker works only one way; the other party won't be able to hear you unless you pick up the handset.)
- 6 When the call is over, hang up to cancel the call.

Redial

If the last number you dialed was busy, press **Redial/Pause** for easy dialing.

Broadcasting

Using the numbers you have stored in Groups, One Touch and Speed Dial memory, you can "broadcast" faxes automatically to a maximum of 54 different locations in a few simple steps. (See *Setting Up Groups for Broadcasting*, page 7-3.) To Broadcast, you must set MEMORY TX to either ON or NEXT FAX ONLY.

After the Broadcast is completed, a Broadcast Report will be printed automatically to let you know the results.

- 1 Place the original face down in the ADF.
- 2 Press **Function/Set, 3, 9** to select ON or NEXT FAX ONLY and press **Function/Set**.
- 3 Enter the One Touch and Speed Dial numbers (one after the other) or a Group Number you have stored.
- 4 Press **Start**. The fax machine stores the original in memory, then transmits it to all the numbers you entered. If the line is busy, your machine will redial automatically up to three times at 5 minutes intervals.



Press **Stop** during transmission to cancel the current fax broadcast.

Pause

Press **Redial/Pause** to insert a pause between numbers. Each key press adds a 3.5 second delay.

Hold

- 1** Press **Hold/Caller ID** to put a call on Hold.
- 2** You can put down the handset without disconnecting the call.
- 3** Pick up the fax machine handset to release the call from Hold. Picking up an extension handset will not release the call from Hold.

Tone/Pulse (For Canada Only)

If you have pulse dialing service, but need to send tone signals (for telephone banking, for example), follow the directions below. If you have touch tone service, you do not need this feature to send tone signals.

- 1** Lift the handset.
- 2** Press **#**. Any digits dialed after this send tone signals.
- 3** When you hang up, the fax machine returns to pulse dialing service.

8

Telephone Services

Custom Features

Your fax machine supports the Distinctive Ring and Caller ID telephone services offered by some telephone companies.



If you have Call Waiting, Ring Master, Voice Mail, an answering service or an alarm system or other custom feature on your telephone line, it may create a problem in the operation of your fax machine.

Distinctive Ring

This fax machine feature lets you use the Distinctive Ring subscriber service offered by some telephone companies, which allows you to have several telephone numbers on one phone line. Each phone number has its own Distinctive Ring pattern, so you know which phone number is ringing. This is one way you can have a separate phone number for your fax machine.

Your fax machine has a Distinctive Ring function, allowing you to dedicate one phone number just for receiving faxes. You'll need to follow the directions below to "register" the new Distinctive Ring pattern, that was assigned by the Telephone Company, so your fax machine can recognize its incoming calls.





You can change or cancel the Distinctive Ring pattern at any time. You can switch it off temporarily, then turn it back on. When you get a new fax number, make sure you reset this function.









You can register only one Distinctive Ring pattern with the fax machine. Some ringing patterns cannot be registered.

- The fax machine will answer only calls to its registered number.
- To have your TAD answer only the main number, the fax machine must be in Manual Mode.
- In FAX/TEL or FAX ONLY mode, the fax machine will answer all numbers on the phone line.

Registering the Distinctive Ring Pattern

- 1 Set the fax machine to MANUAL mode.
- 2 Press **Function/Set, 0, 1**.
- 3 Press  or  to select **DISTINCTIVE:SET?** and press **Function/Set**.

- 4 Press  or  to select the prestored ring pattern you want to assign and press **Function/Set**. (You will hear each pattern as you scroll through the four patterns.) Be sure to choose the pattern assigned by the Telephone Company.

Ring Pattern	Rings	
1	long - long	
2	short - long - short	
3	short - short - long	
4	very long (normal pattern)	

- 5 Press **Stop** to exit.

Caller ID

The Caller ID feature of this fax machine lets you use the Caller ID subscriber service offered by many local telephone companies. After at least two rings, the screen displays the telephone number of your caller (or up to 16 characters of the name, if available). Once you pick up the handset, the Caller ID information disappears from the screen, but the call information remains stored in the Caller ID memory.

- CALL PICKUP display remains on the screen when no Caller ID information was transmitted.
- OUT-OF-AREA display means the call originates outside your Caller ID service area.
- PRIVATE CALL display means the caller has intentionally blocked transmission of information.

Caller ID service varies with different carriers. Call your local telephone company to determine the kind of service available in your area.

Caller ID Log





Your fax machine stores up to 30 of the last Caller IDs received into the fax machine's memory in the Caller ID Log. When the thirty-first call comes in, information about the first call is erased. You can print the report or scroll through Caller ID information to review those calls made to your fax machine.

Printing the Caller ID Log

- 1 Press **Hold/Caller ID**.
- 2 To print the Caller ID Log, press **Start**.

CALLER ID LOG
PRINTING

Viewing the Caller ID Log



- 1 Press **Hold/Caller ID**.
- 2 After 2 seconds, press  or  to scroll through the Caller ID Log.
- 3 When you want to see more detailed information for a displayed ID (phone number and date and time call was received) press **Function/Set**.
- 4 To continue viewing the Caller ID Log (Step 2), press  or  .
—OR—
To exit the Caller ID Log, press **Stop**.

CALLER ID LOG
PRESS START KEY
SELECT ← → & SET
01)MARY HENDERSON
02)TOM HENDERSON
03)ABC COMPANY
03)ABC COMPANY
03)9087772837
03)02/01 12:00
DIAL:PRESS START

Returning a Call from the Log

You can scroll through the Caller ID Log and select a call to return automatically. (See page 8-2)

You must set up your AREA CODE in advance. (USA only)

- 1 Press **Hold/Caller ID**.
- 2 Press  or  to scroll through the Caller ID Log and when you see a call you want to return immediately, press **Function/Set**.
- 3 To begin dialing, press **Start**.
- 4 Begin speaking when the other party answers.

CALLER ID LOG
PRESS START KEY
SELECT ← → & SET
01)MARY HENDERSON
01)9082438436
01)02/01 12:00
DIAL:PRESS START



This feature may not be available in certain area of USA and Canada.

If your dialing plan does not follow the standard 1 + area code + 7-digit number dialing system for calling outside your area code, you may experience problems returning calls automatically from the Caller ID Log. Your fax machine will automatically dial "1" plus the area code for any number that does not originate in your area code. If this is not the procedure followed by your dialing plan you will not be able to return calls automatically.

Registering a Caller ID Number



You can set up a caller in the Caller ID Log as a One Touch or Speed Dial number.

- 1** Press **Hold/Caller ID**.

CALLER ID LOG

PRESS START KEY

SELECT ← → & SET

- 2** After 2 seconds, press  or  to scroll through the Log and when you see a caller you want to register, press **Function/Set**.

03>ABC COMPANY

03>9087772837

03>02/01 12:00

DIAL:PRESS START

- 3** To register the caller as a One Touch number, press the One Touch key where you want the number to be stored.

—OR—



To register the caller as a Speed Dial number, press **Search/Speed Dial** and use the dial pad to press the two-digit location code (01–50), and press **Function/Set**.

NAME:

ENTER & SET



If the LCD shows REGISTERED, the auto dial location already has a number.

- 4** Enter the caller's name and press **Function/Set**.
- 5** Press  or  to select the type of number and press **Function/Set**:

FAX A fax number

TEL A telephone (voice) number

FAX/TEL Both a fax and telephone number

CHAIN A number, usually an access code, for chain dialing

- 6** Return to Step 2 to store another auto dial number—OR—
Press **Stop** to exit.

Call Waiting Caller ID

The Call Waiting Caller ID feature lets you use the Call Waiting Caller ID service offered by many local telephone companies. This feature displays the telephone number (or name, if available) of Call Waiting callers on your fax machine's screen.

- 1** To answer a Call Waiting signal while you're talking on the phone, ask the other party if you can put them on Hold to catch the other call. The screen displays the Caller ID.
- 2** Press **Search/Speed Dial** to switch to the second call.
- 3** To switch back to the first call, press **Search/Speed Dial** again.



Either caller can hang up at any time. However, if you hang up you will disconnect both callers.

CallManage (For USA Only)

This Brother fax machine provides convenient, “One-Touch” access to a long distance plan that provides best average long distance rates*. Once registered, fax or phone calls made using the CallManage feature will access a long distance carrier selected by CallManage, Inc., that offers a plan with best average domestic rates based on standard long distance plans of major carriers within the United States. This may result in significant savings, depending on your current long distance carrier and calling patterns.

Trying the CallManage feature requires no commitment on your part. Just follow the steps below to register with CallManage, Inc. Once registered, your One-Touch key **4** can be used to access the CallManage feature for any calls you choose. Calls made without using the CallManage feature will be processed through your normal long distance carrier.

If you prefer not to activate the CallManage feature you can use One Touch key **4** to store a number of your own choosing.

Registration with CallManage

Before using the CallManage feature, you must register for this service with CallManage Inc.:

1 Pick up the fax handset.

2 Press One Touch **4**.

(Your machine will automatically dial the pre-stored toll free registration number for CallManage, Inc. or you may directly dial **1-888-387-9680**.)

3 A CallManage Customer Service Representative will ask you a number of simple questions required to set up your account (such as name, address, phone number, etc. for billing purposes). There are no sign-up fees, monthly service charges or connection fees for the CallManage feature. You will receive a separate itemized bill each month from CallManage, Inc. for only those calls made using the CallManage feature*.

4 After registering, the Representative will explain how to reprogram your One Touch key **4** for CallManage dialing.

Sending a Fax Using CallManage

1 Place the original face down in the ADF.

2 Press One Touch **4**.

3 Dial the complete long distance or international fax number as usual, using One Touch, Speed Dial, Search or the dial pad. (See *One Touch Dialing*, *Speed Dialing* and *Search*, page 7-4 to 7-6.)

4 Press **Start**.

Placing a Telephone Call Using CallManage

-  You must dial the number and wait to hear the other party answer *before* you pick up the handset to speak.
- 1** Press One Touch **4**.
 - 2** Dial the complete long distance or international number as usual, using One Touch, Speed Dial, Search or the dial pad. (See *One Touch Dialing*, *Speed Dialing* and *Search*, page 7-4 to 7-6.)
 - 3** Press **Start**.
 - 4** Pick up the handset when you hear the other party through the fax machine's one-way speaker.

Customer Support

If you have questions or want more information*, call CallManage at **1-877-622-5457**.

-  Percent savings and comparisons based on standard rate plans of major carriers with tariffs in effect as of January 2000. Long distance savings will depend upon the customer's current carrier for long distance service and his or her calling patterns. Rates updated periodically. Call 1-877-622-5457 for latest rate and underlying carrier information. In order to use the CallManage feature you must register for service through CallManage, Inc (toll free) at 1-888-387-9680. Once registered, the One Touch 4 button will access a long distance provider selected by CallManage, Inc. that offers a plan with best average domestic rates based on standard long distance plans of major carriers within the United States. Using the CallManage feature after registering will result in your receiving a long distance telephone bill from CallManage, Inc. Without proper registration, calls made using the One Touch 4 button may not be connected or may default to a standard rate plan offered by the underlying carrier and charges for such calls will appear either on the customer's local telephone bill as the underlying carrier's service or on a direct bill from the underlying carrier. The One Touch 4 button should not be used if the customer wishes to use his or her existing primary or dial around carrier for long distance service. Brother International, Corp. is not responsible for long distance service or customer billing. Subject to service availability. All applications are subject to credit approvals. **DO NOT USE THE ONE TOUCH 4 BUTTON TO DIAL 911 – IT WILL NOT ACCESS EMERGENCY SERVICES.** CallManage is a trademark of CallManage, Inc.

9

Making Copies

Copy Functions

To make a single copy that is not reduced, enlarged or sorted, you only have to press one key. The default resolution for a single copy is Super Fine. Set the resolution to PHOTO for photographs. Remember, your machine cannot scan anything closer than one-eighth inch from the edge of the paper.

Making a Single Copy

- 1 Place the original face down in the ADF.
- 2 Press **Copy/Help** twice.

To cancel, press **Stop**.

Do NOT pull on the paper while copying is in progress.

Copy Options: Single or Multiple Copies, Reduce/Enlarge, Sort/Stack

You can choose additional copy options. First, you can select the number of copies. Next, you can choose whether multiple copies will be STACKED (all copies of page 1, then all copies of page 2, etc.) or SORTED (collated). Finally, you can choose an enlargement or reduction ratio. To automatically reduce the copy to the paper size you have set for the paper tray, select **AUTO**. To reduce the copy by a fixed percentage, choose **93%**, **87%**, **75%** or **50%**. Or, to enlarge the copy, select **150%**, **125%** or **120%**. To copy a document at its original size, select **100%**.

- 1 Place the original face down in the ADF.
- 2 Press **Copy/Help**.
- 3 Enter the number of copies you want (1-99) and press **Function/Set**.

For example, press 9 for nine copies.

To start copying now, press **Copy/Help**.

If you would like to select additional copy options, like **SORT**, **ENLARGE** or **REDUCE**, press **Function/Set**.

FAX:NO.& START
COPY:PRESS COPY

NO.OF COPIES:01
THEN COPY OR SET

NO.OF COPIES:09

STACK P.01 FNE

MULTI COPY:STACK
THEN COPY OR SET

- 4 Press ◀ or ▶ to select **SORT**.

For example, select **SORT**.

MULTI COPY: SORT

*To start copying now without enlarging or reducing, press **Copy/Help**.*

SORT P.01 FNE

*To reduce or enlarge the image, press **Function/Set**.*

ELG/RDC: 100% ?
THEN COPY OR SET

- 5 Press ◀ or ▶ to select an enlargement or reduction ratio.

ELG/RDC: 100% ?

ELG/RDC: 120% ?

•

ELG/RDC: 93% ?

For example, **75 %**.

ELG/RDC: 75% ?

- 6 Press **Copy/Help**.

SORT P.01 FNE









If you are making multiple copies and get a **MEMORY FULL** message while you are scanning the first page, press **Stop** to cancel the job. Then make a single copy. If you selected **SORT** and the **MEMORY FULL** message appears while scanning subsequent pages, you can press **Copy/Help** to copy the portion that is in memory, or press **Stop** to cancel. To restart the copy job using less memory, press **Copy/Help** for stacked copies.

10 Printing Reports

Fax Machine Settings and Activity

You can print the following lists and reports:

- | | |
|---|---|
|  | Choose to print a Transmission Verification Report after all faxes you send. |
|  | Activity Report lists information about the last 30 incoming and outgoing faxes. TX means Transmit; RX means Receive. |
|  | Lists names and numbers stored in One Touch and Speed Dial memory, in numerical order. |
|  | AUTO DIAL list (above), alphabetically. |
|  | Lists settings for INITIAL SETUP, SETUP RECEIVE, SETUP SEND, PRINT REPORTS, REMOTE FAX OPT and TEL SERVICE. |
|  | Lists summary information and amount of occupied memory. |

To Print a Report

- 1 Press **Function/Set, 7**.
- 2 Enter the number of the report you want to print. For example, press **4** to print the TEL-INDEX.



For the Activity Report, also press  or  to select PRINT REPORT?.



- 3 Press **Start**.
- 4 Press **Stop** to exit.

Transmission Verification (Xmit) Report

You can use the Xmit Report as proof that you sent a fax. This report lists the name or fax number of the receiving party, the time and date of transmission, and if the transmission was successful.



When the feature is OFF, the report is printed automatically only if there's an error during transmission. If the report indicates NG, send the original again. If the report indicates you should check the readability of certain pages, resend those pages.

When the feature is ON, the report is printed with every fax you send.

- 1 Press **Function/Set, 7, 1.**
- 2 Press  or  to select ON (or OFF) and press **Function/Set.**
- 3 Press **Stop** to exit.



Activity Report Interval

You can set the fax machine to print activity reports at specific intervals (6, 12, 24 hours, 2, 4 or 7 days). If you set the interval to OFF, you can print the report by following the steps in the previous section.

- 1 Press **Function/Set, 7, 2.**
- 2 Press  or  to display:

INTERVAL?

and press **Function/Set.**

- 3 Press  or  to choose your setting and press **Function/Set.** If you choose 7 days, the screen prompts you to choose a day at which to begin the 7-day countdown.
- 4 Enter the time to begin printing, in 24-hour format and press **Function/Set.** (For example, enter 19:45 for 7:45 PM)
- 5 Press **Stop** to exit.

Standard Telephone and FCC Notices

These notices are in effect on models sold and used in the United States only.

This equipment is hearing aid and volume control compatible.

When programming emergency numbers and/or making test calls to emergency numbers:

- Before you hang up, briefly explain to the dispatcher the reason for the call.
- Perform such activities in the off-peak hours, such as early morning or late evening.

This equipment complies with Part 68 of FCC Rules. On the rear panel of this equipment is a label that contains, among other information, the FCC Registration Number and Ringer Equivalence Number (REN) for this equipment. You must, upon request, provide this information to your telephone company.

You may safely connect this equipment to the telephone line by means of a standard modular jack, USOC RJ11C.

An FCC compliant telephone cord with a modular plug is provided with this equipment. This equipment is designed to be connected to the telephone line or premise's wiring using a compatible modular jack that is Part 68 compliant. See the Installation section of this manual for details.

The REN is useful to determine the quantity of devices you may connect to your telephone line and still have those devices ring when your telephone number is called. In most, but not all areas, the sum of the RENs of all devices connected to one line should not exceed five (5). To be certain of the number of devices you may connect to your line, as determined by the REN, you should contact your local telephone company to determine the maximum REN for your calling area. If your fax damages the telephone line, the telephone company may discontinue your service temporarily. If possible, they will notify you in advance. But if advance notice is not practical, you will be notified as soon as possible. You will be informed of your right to file a complaint with the FCC.

Your telephone company may make changes to its facilities, equipment, operations or procedures that could affect the proper functioning of your equipment. If they do, you will be notified in advance to give you an opportunity to maintain uninterrupted telephone service.

If you experience trouble with this fax machine, please contact a Brother Authorized Service Center for information on obtaining service or repair. The telephone company may ask that you disconnect this equipment from the line until the problem has been corrected or until you are sure that the equipment is not malfunctioning.

If you are not able to solve a problem with your fax machine, contact Brother Customer Service. (See *Brother Numbers*, page i.)

International Energy Star Compliance Statement

The purpose of the International Energy Star Program is to promote the development and popularization of energy-efficient office equipment, which includes computers, monitors, printers, facsimile receivers and copy machines world-wide. As an International Energy Star partner, Brother Industries, Ltd. has decided that this product meets the guideline of the program.



Industry Canada Compliance Statement (For Canada Only)

This Class B digital apparatus meets all requirements of the Canadian Interference-Causing Equipment Regulations.

Cet appareil numérique de la classe B respecte toutes les exigences du Règlement sur la matériel brouilleur du Canada.

Federal Communications Commission Compliance Notice (For USA Only)

This equipment has been tested and found to comply with the limits for a Class B digital device, pursuant to Part 15 of the FCC Rules. These limits are designed to provide reasonable protection against harmful interference in a residential installation. This equipment generates, uses, and can radiate radio frequency energy and, if not installed and used in accordance with the instructions, may cause harmful interference to radio communications. However, there is no guarantee that interference will not occur in a particular installation. If this equipment does cause harmful interference to radio or television reception, which can be determined by turning the equipment off and on, the user is encouraged to try to correct the interference by one or more of the following measures:

- Reorient or relocate the receiving antenna.
- Increase the separation between the fax equipment and the receiver.
- Connect the fax equipment on a separate circuit.
- Consult the dealer or an experienced radio/TV technician for help.



WARNING

For protection against the risk of electrical shock, always disconnect all cables from the wall outlet before servicing, modifying or installing the equipment.

This equipment may not be used on coin service lines provided by the telephone company or connected to party lines.

Brother cannot accept any financial or other responsibilities that may be the result of your use of this information, including direct, special or consequential damages. There are no warranties extended or granted by this document.

Important Safety Instructions

- 1** Read all of these instructions.
- 2** Save them for later reference.
- 3** Follow all warnings and instructions marked on the product.
- 4** Unplug this product from the wall outlet before cleaning. Do not use liquid or aerosol cleaners. Use a damp cloth for cleaning.
- 5** Do not use this product near water.
- 6** Do not place this product on an unstable cart, stand, or table. The product may fall, causing serious damage to the product.
- 7** Slots and openings in the cabinet and the back or bottom are provided for ventilation; to ensure reliable operation of the product and to protect it from overheating, these openings must not be blocked or covered. The openings should never be blocked by placing the product on a bed, sofa, rug, or other similar surface. This product should never be placed near or over a radiator or heater. This product should never be placed in a built-in installation unless proper ventilation is provided.
- 8** This product should be operated from the type of power source indicated on the label. If you are not sure of the type of power available, consult with your dealer or local power company.
- 9** This product is equipped with a 3-wire grounding type plug, a plug having a third (grounding) pin. This plug will fit into only a grounding-type power outlet. This is a safety feature. If you are unable to insert the plug into the outlet, contact your electrician to replace your obsolete outlet. Do not defeat the purpose of the grounding-type plug.
- 10** Do not allow anything to rest on the power cord. Do not place this product where people can walk on the cord.
- 11** If an extension cord is used with this product, make sure that the total ampere ratings on the products plugged into the extension cord do not exceed the extension cord ampere rating. Also, make sure that the total of all products plugged into the wall outlet does not exceed 15 amperes (USA only).
- 12** Do not place anything in front of the fax machine that will block the exit-path of sent documents, originals and received faxes.
- 13** Do not touch an original during printing.
- 14** Never push objects of any kind into this product through cabinet slots, because they may touch dangerous voltage points or short out parts resulting in a risk of fire or electric shock. Never spill liquid of any kind on the product.
- 15** Do not attempt to service this product yourself, as opening or removing covers may expose you to dangerous voltage points and/or other risks, and may void your warranty. Refer all servicing to a Brother Authorized Service Center. A list of Brother Authorized Service Centers has been included for your convenience, or you may contact the Brother Customer Service for your nearest Brother Authorized Service Center. (See *Brother Numbers*, page i.)
- 16** Unplug this product from the wall outlet and refer servicing to a Brother Authorized Service Center under the following conditions:
 - A** When the power cord is damaged or frayed.
 - B** If liquid has been spilled into the product.
 - C** If the product has been exposed to rain or water.
 - D** If the product does not operate normally when the operating instructions are followed. Adjust only those controls that are covered by the operating instructions. Improper adjustment of other controls may result in damage and will often require extensive work by a qualified technician to restore the product to normal operation.
 - E** If the product has been dropped or the cabinet has been damaged.
 - F** If the product exhibits a distinct change in performance, indicating a need for service.
- 17** To protect your product against power surges, we recommend the use of a power protection device (Surge Protector).

12 Troubleshooting and Routine Maintenance

Troubleshooting

If you can't resolve a difficulty with your fax machine using this manual, please see page i for *Brother Numbers* to call for assistance.

Error Messages

You may occasionally encounter a difficulty with your fax machine or telephone line. If this happens, your fax machine often identifies the problem and displays an error message. The list below explains the most common error messages.

If you need additional help, call the Brother fax-back system. (See *Brother Numbers*, page i)

CHANGE CARTRIDGE

The ribbon is used up and printing is not possible. Replace the ribbon or the ribbon cartridge with a new one. (See *Replacing the Print Cartridge*, page 12-8.)

CHECK PAPER

PRESS START KEY

The fax machine is out of paper, or the paper is not properly loaded. After you load paper, press **Start**.

CHECK PAPER

The paper is jammed in the fax machine.

- 1 Remove any paper that is not jammed.



- 2** Open the top cover by lifting the gray lever on the right side of the top cover.

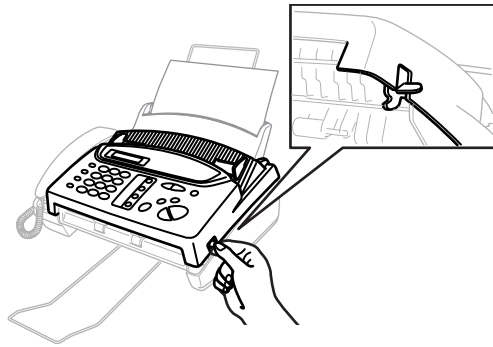

Top Cover

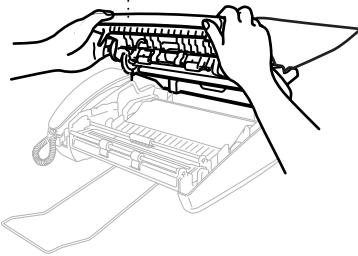

- 3** Pull the jammed paper gently from the paper tray toward the *front* of the machine. If the paper is jammed under the rollers, then pull it toward the *back* of the machine.

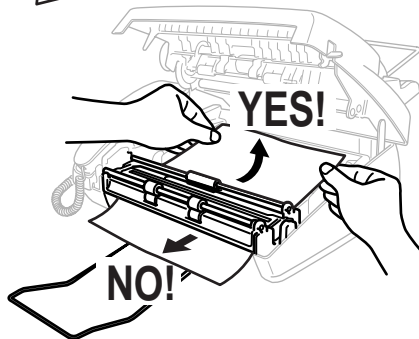
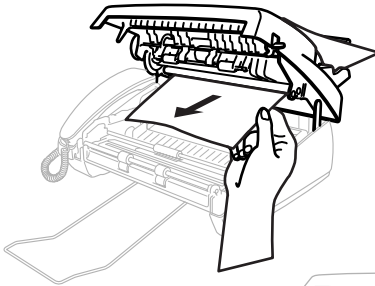

- 4 Remove the print cartridge and turn the spool to tighten the ribbon.
- 5 Install the cartridge. (See *Replacing the Print Cartridge*, page 12-8)
- 6 Close the top cover.
- 7 Load the paper.

COMM.ERROR

A poor quality phone line resulted in a communications error. Try the call again.

CONNECTION FAIL

You have requested a polling call from another party, but the other fax machine is not in Poll Waiting mode.

DISCONNECTED

The other party has disconnected during a fax. Try calling the other party.

DOCUMENT JAM

The documents were not inserted or fed properly, or were too long or too short.

- 1 Remove any paper that is not jammed from the ADF.
- 2 Open the top cover.
- 3 Pull the document toward the front of the machine.
- 4 Close the cover and press **Stop**.

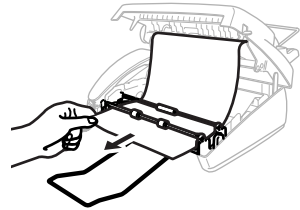

MACHINE ERROR XX

PRESS STOP KEY

Contact Brother Customer Service at

USA: 1-800-284-4329 (voice)

From within Canada: 1-800-853-6660 (voice)

From within Montreal: 1-514-685-6464 (voice)

NO RESPONSE/BUSY

The number you called does not answer or is busy. You may also have reached a number not connected to a fax. Check the number and call again.

NOT REGISTERED

You've tried accessing a One Touch or Speed Dial location with no number assigned to it. See pages 7-1 to 7-2 for information about storing One Touch or Speed Dial numbers.

PRINTER FAULT

The print head has overheated. Unplug the fax machine and wait 30 minutes for it to cool.

TOP COVER OPEN

The top cover is not closed completely.

If You Are Having Difficulty with Your Fax Machine

If you think there is a problem with your fax machine, make a *copy* first. If the copy looks good, the problem is probably not your fax machine. Check the difficulties below and follow the troubleshooting tips.

Printing or Receiving Faxes

Condensed Print and Horizontal Streaks; Top and Bottom of Sentences Cut Off

If your copy looks good, you probably had a bad connection, with static or interference on the phone line. If the copy looks bad, call Brother Customer Service at 1-800-284-4329 (USA), 1-800-853-6660 (from within Canada) or 1-514-685-6464 (from within Montreal).

Vertical Black Lines When Receiving

The sender's scanner may be dirty. Ask the sender to make a copy to see if the problem is with the sending machine. Try receiving from another fax machine. If the problem continues, call Brother Customer Service at 1-800-284-4329 (USA), 1-800-853-6660 (from within Canada) or 1-514-685-6464 (from within Montreal).

Phone Line or Connections

Fax Machine Does Not Answer When Called

Make sure the fax machine is in the correct receiving mode for your setup (either FAX, FAX/TEL or TAD). Check for dial tone. If possible, call your fax machine to hear it answer. If there is still no answer, check the telephone line cord connection. (See *Connecting the Machine*, page 2-4 and *Connect the telephone line*.) Connect a *standard* telephone handset to the fax machine telephone jack. If there is no ringing when you call your fax machine, call your Telephone Company to check the line.

Telephone Answering Device (TAD) Does Not Answer When Called

Connect the telephone line cord from your TAD to the back of the fax machine, in the jack labeled EXT. Make sure the TAD is set to answer calls. (See *Connecting an External Telephone Answering Device (TAD)*, page 2-8.)

No Dial Tone on the Handset

Press **Hook**—**OR**—Lift the handset. If you don't hear a dial tone, check telephone line cord connections at the fax machine and wall jack. Check that the handset is connected to the fax machine's handset jack. Test the wall jack with another single line telephone. If there is no dial tone at the wall outlet, call your Telephone Company.

The Caller ID does not display after the Call Waiting Signal

The Caller ID signal is sent ten seconds after the Call Waiting Signal and speaking may interfere with it. When you hear the Call Waiting signal, ask the other party to hold while you answer the call. Then stop speaking until you see the Caller ID on the LCD.

Sending Faxes

Poor Transmitting Quality

Try changing your resolution to FINE or SUPERFINE. (See *Resolution*, page 6-4.) Make a copy to verify the fax machine's scanner operation.

Dialing Does Not Work

Check all line cord connections, and make sure the curled handset cord is not in the **EXT** jack.

Check power cord connection.

Send a manual fax by pressing **Hook**—**OR**—Lifting the handset, and dialing the number. Wait to hear fax receiving tones before pressing **Start**.

Vertical Black Lines When Sending

Use your fax machine to make a copy. If the copy shows the same problem, the scanner area is dirty. Lift the top cover and check the original path. Clean the scanner's white tape and the glass strip under the tape using isopropyl alcohol and a lint-free cloth. (See page 12-7.)

Handling Incoming Calls

Double Ring in FAX/TEL Mode

The fax machine knows the incoming call is not a fax so it is signaling you to answer the telephone call. Pick up the fax machine handset or answer from an extension phone and press your fax machine's Telephone Answer Code (default setting is #51). (See *For FAX/TEL Mode Only*, page 5-5.)

Transferring a Call to the Fax Machine

If you have answered the fax machine handset, press **Start**, and hang up immediately.

If you answered at an extension phone, press your three-digit Fax Receive Code (the factory setting is ✕51). When your fax machine answers, hang up.

Fax Machine "Hears" Voice as CNG Tone

If your fax machine is set to Easy Receive ON, and it answers voice calls by trying to receive a fax, try turning Easy Receive to OFF. (See *Easy Receive*, page 5-3.)

Transmission Verification Report Prints "Result: NG"

There is probably temporary noise or static on the phone line. Try sending the fax again. If the problem continues, call the Telephone Company to check your phone line.

Custom Features on a Single Line

If you have Call Waiting, Caller ID, Call Waiting/Caller ID, Ring Master, Voice Mail, an answering machine, alarm system or any other custom feature on a single phone line with your fax machine, it may create a problem sending or receiving fax data.

Example #1:

If you are having a telephone conversation and a fax communication signal comes through on your Call Waiting Caller ID feature, you can verify that the second call is a fax by switching to it. You have the option to receive the fax call, by asking the first caller to hang up to clear the line.

Example #2:

If you are sending or receiving a fax message while a Call Waiting Caller ID (or other custom feature) signal comes through on the line, the signal can temporarily interrupt or disrupt the fax data. Brother's ECM feature should help overcome this problem. This condition is related to the telephone system industry, and is common to all devices that send and receive information on a single, shared line with custom features. If avoiding a slight interruption is crucial to your business, a separate line with no custom features is recommended.

Routine Maintenance

Cleaning the Scanner

Before cleaning, unplug the power cord for safety. Clean the white bar and the glass strip under the bar with isopropyl alcohol on a lint-free cloth. Be careful not to bend the spring plate or drop anything into the fax machine.

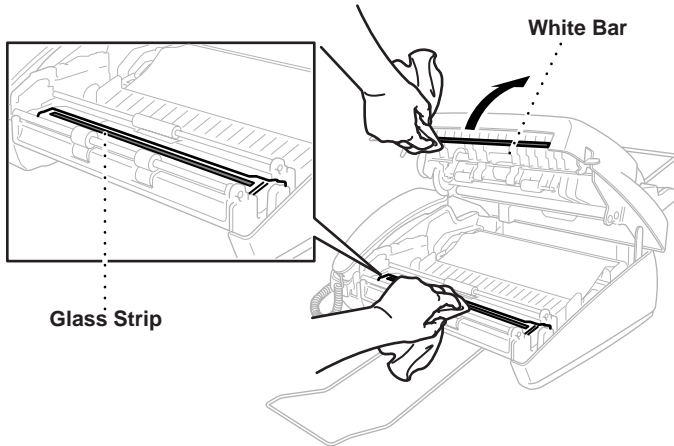

Cleaning the Print Head

Before cleaning, unplug the power cord for safety. To clean the fax machine print head, wipe the print head with a lint-free cloth that is dry or lightly moistened with isopropyl alcohol.

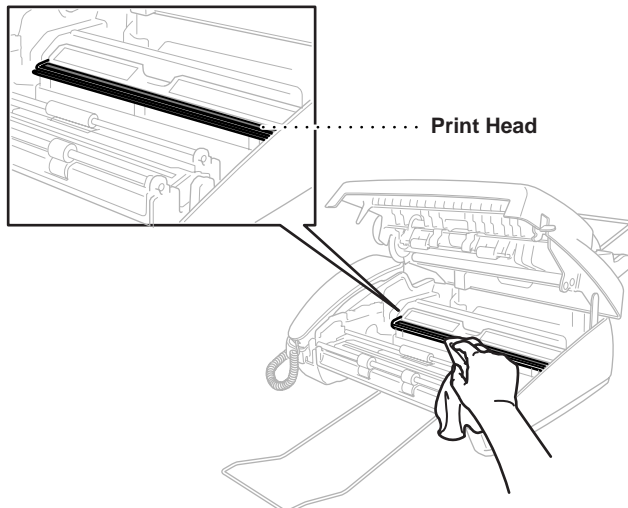



WARNING

Just after you have used the machine, the print head is extremely **HOT!**

Replacing the Print Cartridge

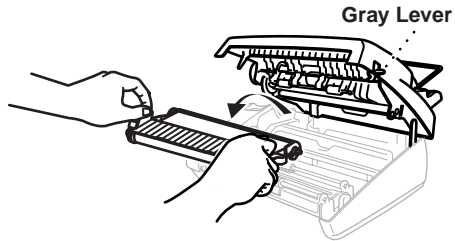
- 1 Open the top cover by lifting the gray lever on the right side. (See page 12-2)
- 2 Remove the print cartridge containing the used ribbon and set it down.



- 3 Install the new print cartridge, by inserting the recessed first  and placing the cartridge into its four holders.

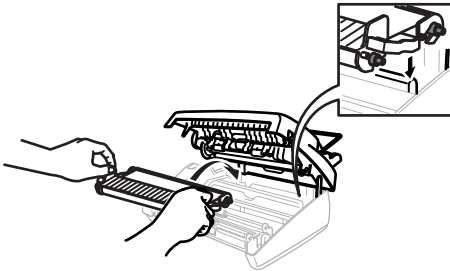
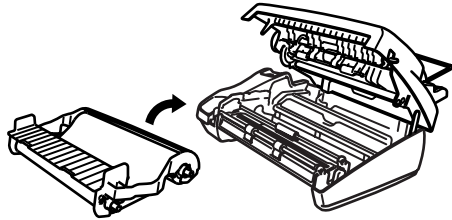

- 4 Press down on both sides of the top cover to close it securely.



You can save money by purchasing the 2-PK Refill Ribbon Rolls (PC402RF). *Installation instructions will be included.* If you handle the print cartridge (frame) carefully, you can reuse it until it breaks.

Specifications

Type	Desktop facsimile transceiver
Compatibility	ITU-T Group 3
Coding System	Modified Huffman (MH)
Modem Speed	9600/7200/4800/2400; Automatic Fallback
original Input Width	5.8 inches to 8.5 inches (148 mm to 216 mm)
Scanning/Printing Width	8.2 inches (208 mm)
Paper Tray	Letter: 50 Sheets; Legal: 30 Sheets
Printer Type	Line Thermal with Ribbon
Gray Scale	64 levels (Dithered)
Display	LCD, 16 characters
Polling Types	Standard, Sequential
Contrast Control	Automatic/Super Light/Super Dark (manual setting)
Resolution	<ul style="list-style-type: none">• Horizontal 203 dot/inch (8 dot/mm)• Vertical Standard—98 line/inch (3.85 line/mm) Fine, Photo—196 line/inch (7.7 line/mm) Superfine, Photo (copy)—392 line/inch (15.4 line/mm)
Memory Capacity	512 KB (up to 25 pages*)
One Touch Dial	4
Speed Dial	50 stations
Automatic Redial	3 times at 5 minute intervals
Speaker Type	Monitor
Auto Answer	0, 1, 2, 3 or 4 rings
Communication Source	Public switched telephone network
Operating Environment	41 - 95° F
Power Source	120V AC 50/60Hz (U.S.A., Canadian Version Only)
Power Consumption	Standby: under 5 watts — Peak: under 170 watts
Dimensions	13.1 x 11.9 x 11.1 (inches)/ 334 x 301 x 281 (mm)
Weight	7.5 lb / 3.4 kg

* "Pages" refers to the ITU-T #1 chart (in Out of Paper Reception in ECM mode). Specifications are subject to change without prior notice.

Index

A

Accessories	ii
ACTIVITY REPORT	10-2
Alternating Displays	3-1
Answer Mode	5-1, 5-2
Answering Machine	2-8
AUTO DIAL REPORT	10-1
Automatic Transmission	6-2

B

Beeper Volume	4-4
Broadcasting	7-6
Broadcasting (Set Up Groups)	7-3
Brother Numbers	i

C

CALL PICKUP	8-2
Call Waiting Caller ID	8-4
Caller ID	8-2
Caller ID (Printing Log)	8-3
Caller ID (Viewing Log)	8-3
CallManage	8-5
Canceling Job	6-5
Chain Dialing	7-2
CHECK PAPER	12-1
COMM. ERROR	12-3
Connect (External Telephone Answering Device)	2-8
Connect (External Telephone)	2-9
Connect (Power Cord)	2-4
Connect (Telephone Line)	2-4
CONNECTION FAIL	12-3
Contrast	6-3
Control Panel	1-3
Corrections (Entering Text)	4-2

Customer Service	i
------------------------	---

D

Date and Time	4-1
Delayed FAX	6-4
Dialing Mode	4-2
Dialing Options	7-4
Disclaimer & Warranties	iii
DISCONNECTED	12-3
Distinctive Ring	8-1
DOCUMENT JAM	12-3
Documents (Size)	6-1

E

Easy Receive	5-3
ECM (Error Correction Mode)	1-2
Entering Text	4-2
External Telephone	2-9
External Telephone Answering Device	2-8

F

F/T (FAX/TEL) Mode	5-1
F/T Ring Time	5-3
FAX ONLY Mode	5-1
Fax Receive Code	5-5
Fax Storage	5-6
Fax Tones and Handshake	1-2
fax-back system	i
Fine (Resolution)	6-4
Frequently Asked Questions (FAQs)	i
Function Mode	3-1
Function Selection Table	3-2

G

Gray Scale	S-1
------------------	-----

H

Handset Volume	4-4
Help	1-1
Hold	1-3, 7-7

I

Inserting Spaces	4-2
International Calls	6-4
Interrupting	6-5

M

Maintenance (Routine)	12-7
Manual Dialing	7-4
MANUAL Mode	5-1
Manual Transmission	6-2
MEMORY STATUS REPORT	10-1
Memory Storage	4-5
Memory Transmission	6-3
Multi-Line Connections	2-7

O

One Touch Dial (Changing)	7-3
One Touch Dial (Storing)	7-1
One Touch Dialing	7-4
On-Screen Programming	3-1
Outgoing Message (External TAD)	2-9
Overseas Mode	6-4

P

Paper Size	5-4
Pause	7-7
PBX	2-7
Photo (Resolution)	6-4
Polled Transmit	6-5
Polling (Receive)	5-6
Power Consumption	S-1
Print (a Fax in Memory)	5-6
Print (Caller ID Log)	8-3

Print (Report)	10-1
Print Head (Cleaning)	12-7
PRINTER FAULT	12-4
Pulse (For Canada Only)	4-2

R

Redial (Automatic)	6-2
Redial (Manual)	6-2
Reduction (Printing)	5-4
Reduction (Recommended Ratios)	5-4
Remote Codes (Changing)	5-5
Resolution	6-4
Ring Delay	5-2
Ring Volume	4-5
Roll Over Phone Lines	2-5

S

Safety Instructions	11-3
Scanner (Cleaning)	12-7
Scroll	3-1
Search	7-6
Speaker Volume	4-5
Special characters	4-3
Speed Dial (Changing)	7-3
Speed Dial (Storing)	7-2
Speed Dialing	7-5
Standard (Resolution)	6-4
Station ID	4-1
Storing Telephone Numbers	7-1
Super Fine (Resolution)	6-4

T

TAD	2-8
TAD (Mode)	5-1
TEL.INDEX REPORT	10-1
Telephone Answer Code	5-5
Telephone Numbers	7-1
Tone	4-2

Tone (Send Signals)7-7
TOP COVER OPEN12-4
TRANSMISSION VERIFICATION
(XMIT) REPORT10-2
Troubleshooting12-1
Two-Line Phone System2-5

U

USER SETTINGS REPORT10-1

V

VERIFICATION (XMIT) REPORT ..10-1
Volume Amplify4-5

W

WARNING11-2

Remote Fax Options



Setting Up Fax Storage



You cannot use Paging and Fax Forwarding at the same time.
You cannot use Paging and Fax Forwarding when Fax Storage is set to OFF.
(See *Turning On Fax Storage*, page R-2.)



Programming Paging Number

When Paging is selected, your fax machine dials the pager number you've programmed, and dials your Personal Identification Number (PIN) when connected, to activate your pager and let you know you have a fax message in the memory.

- 1 Press **Function/Set, 8, 1**.
- 2 Press  or  until the screen displays

PAGING?

and press **Function/Set**.

PAG#: 
ENTER & SET 



- 3 Enter your pager phone number (up to 20 digits) followed by ## and press **Function/Set**. Do not include the area code if it is the same as that of your fax machine. *For example,*
1 8 0 0 5 5 5 1 2 3 4 ##.
- 4 If your pager requires a PIN, enter the PIN, press #, press **Redial/Pause**, enter your fax number, then press ## and press **Function/Set**. *For example,*
1 2 3 4 5 # Redial/Pause 1 8 0 0 5 2 1 2 8 4 6 ##.
—OR—
If you do not need a PIN, press **Redial/Pause**, enter your fax number, then press ## and press **Function/Set**. *For example,*
Redial/Pause 1 8 0 0 5 2 1 2 8 4 6 ##.
- 5 Press **Stop** to exit.



You cannot change a Paging number or PIN remotely.



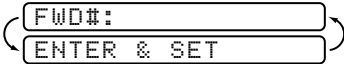

Programming a Fax Forwarding Number

When Fax Forwarding is set to ON, your fax machine stores the received fax in memory, then dials the fax machine phone number you've programmed, and forwards the fax message.

- 1 Press **Function/Set, 8, 1.**
- 2 Press  or  until the screen displays **FAX FORWARD?** and press **Function/Set.** 
- 3 Enter the number of the fax machine where faxes will be forwarded (up to 20 digits) and press **Function/Set.**
- 4 Press **Stop** to exit.

Turning On Fax Storage

If you set Fax Storage to ON, you will be able to retrieve fax messages from another location, using Fax Forwarding, Paging, or Remote Retrieval functions. The screen will indicate when you have a fax stored in memory.

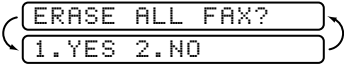
- 1 Press **Function/Set, 8, 2.** 
 - 2 Press  or  to select ON (or OFF) and press **Function/Set.**
 - 3 Press **Stop** to exit.
-  If there are faxes in memory when you turn the Fax Storage OFF, the screens prompts you to erase any faxes in memory. 

If you press **1**, all fax data is erased and Fax Storage is turned off. If you press **2**, data is not erased, and Fax Storage remains on. (See *Printing a Fax in Memory*, page 5-6.)

Changing Remote Access Code

Enter your Remote Access Code when the fax machine picks up your call, so you can access features remotely. The access code is preset to **1 5 9 ***, but you can change this.

- 1 Press **Function/Set, 8, 3.** (See *Operation from External or Extension Telephone*, page 5-5)
- 2 Enter a three-digit number from 000 to 999. The "*****" cannot be changed. Do not use the same digits that appear in your Fax Receive or Telephone Answer Code.
- 3 Press **Function/Set.**
- 4 Press **Stop** to exit.

Using Remote Retrieval Access Code

Calling for Messages

You can call your FAX from any touch tone phone (or remote Group 3 fax machine) and use a Remote Access Code and other button presses to retrieve fax messages.

- 1 Dial your fax number from a touch tone phone.
- 2 When your fax machine answers, immediately enter your Remote Access Code (**1 5 9 ***).
- 3 The fax machine signals the kinds of messages received:
 - 1 long beep — Fax message(s)
 - No beeps — No messages
- 4 The fax machine then prompts you with two short beeps to enter a command. If you wait longer than 30 seconds to enter a command, the machine hangs up. If you enter an invalid command, the machine beeps three times.
- 5 Press **9 0** to reset the fax machine when you finish.
- 6 Hang up.

 If your fax machine is set to MANUAL mode, you can access your machine by waiting about 2 minutes, then entering the Remote Access Code within 30 seconds.

Retrieving Memory Status List

You can retrieve the Memory Status List from a remote fax machine to see if you have any fax messages.

- 1 Dial your fax number.
- 2 When your machine answers, immediately enter your Remote Access Code (**1 5 9 ***).
- 3 When you hear two short beeps, use the dial pad to press **9 6 1**.
- 4 Using the dial pad, enter the number (up to 20 digits) of the remote fax machine where you want the Memory Status List forwarded, and then press **#**.

 You cannot use ***** and **#** as dial numbers. However, if you want to store a pause, press **#**.

- 5 After you hear your fax machine beep, hang up and wait.

Your fax machine calls the remote fax machine. The remote fax machine prints the Memory Status List.

Remote Retrieval Access Card

If you plan to receive fax messages while away from your machine, carrying the Remote Retrieval Access Card printed below will serve as a convenient reminder of the retrieval procedures. Simply cut out the card and fold it to fit your wallet or organizer. Keeping it handy will help you derive the full benefit of your machine's forwarding, paging and remote retrieval features.

REMOTE RETRIEVAL ACCESS CARD

Using Remote Retrieval Access Code

- 1 Dial your fax number from a fax machine using touch tone phone.
- 2 When your machine answers, immediately enter your Remote Retrieval Access Code (**159***).
- 3 Your machine signals the kinds of messages received:
 - 1 long beep — Fax message(s)
 - 3 short — No messages.
- 4 After 2 short beeps, enter a remote command and follow the steps.
- 5 Press **9 0** to reset your machine when you finish.
- 6 Hang up.

CHECK RECEIVING STATUS
Press **9 7 1**
1 long beep — Fax message(s)
3 short beeps — No messages

CHANGE ANSWER MODE
Press **9 8**
then for TAD, press **1**
FAX/TEL (Fax/Telephone), press **2**
FAX, press **3**.

EXIT REMOTE OPERATION
Press **9 0**

Fold →

← Fold

Retrieving Fax Messages

- 1 Dial your fax number.
- 2 When your machine answers, immediately enter your Remote Access Code (1 5 9 *).
- 3 As soon as you hear two short beeps, use the dial pad to press 9 6 2.
- 4 Using the dial pad, enter the number (up to 20 digits) of the remote fax machine where you want your fax messages forwarded, and then press # #.

 You cannot use * and # as dial numbers. However, if you want to store a pause, press #.

- 5 After you hear your fax machine beep, hang up and wait.
Your fax machine calls the remote fax machine. The remote fax machine prints your fax messages.

Changing Fax Forwarding Number

You can change the default setting of your fax forwarding number from a remote fax machine.

- 1 Dial your fax number.
- 2 When your machine answers, immediately enter your Remote Access Code (1 5 9 *).
- 3 When you hear two short beeps, use the dial pad to press 9 5 4.
- 4 Enter the new number of the remote fax machine where you want your fax messages forwarded, and then press # #.

 You cannot use * and # as dial numbers. However, if you want to store a pause, press #.

- 5 To retrieve the Memory Status List, when you hear two short beeps, use the dial pad to press 9 6 1.
- 6 Use the dial pad to enter the number of the remote fax machine (up to 20 digits), and then press # #.
- 7 After you hear your fax machine beep, hang up and wait.
Your fax machine calls the remote fax machine. The remote fax machine prints the Memory Status List showing the new forwarding number.
- 8 Check the forwarding number.
If the forwarding number is incorrect, return to Step 1 to reset it.

Changing Remote Retrieval Access Code

- 1 Press **Function/Sel.** [8] [3].
- 2 Enter a three-digit number from 000 to 999.
The * cannot be changed.
- 3 Press **Function/Sel.**
- 4 Press **Stop** to exit.

Remote Commands

CHANGE PAGING/FAX FORWARDING SETTING

- Press [9] [5].
- Then to
- Turn Feature off, press [1]
 - Select Fax Forwarding, press [2]
 - Select Paging, press [3]

Program Fax Forwarding Number press [4]

- Enter the new fax number where you want your fax messages forwarded, and press [##]. To retrieve a Memory Status List to check the new number, after two short beeps, press [9] [6] [1]. Enter the number of the remote fax machine, and press [##].
- Turn Fax Storage on, press [6]
 - Turn Fax Storage off, press [7]

RETRIEVE A FAX

- Press [9] [6].
- Print a Memory Status List, press [1], then enter the number of remote fax machine, and press [##]. After the beep, hang up and wait.
 - Retrieve all faxes, press [2], then enter the number of remote fax machine, and press [##]. After the beep, hang up and wait.
 - Erase all fax messages, press [3].

brother®

Brother International Corporation
100 Somerset Corporate Boulevard
P.O. Box 6911
Bridgewater, NJ 08807-0911 USA

Brother International Corporation (Canada) Ltd.
1 rue Hôtel de Ville,
Dollard-des-Ormeaux, QC, CANADA H9B 3H6

Visit us on the World Wide Web
<http://www.brother.com>

These machines are made for use in the USA or CANADA only. We can not recommend using them overseas because it may violate the Telecommunications Regulations of that country and the power requirements of your fax machine may not be compatible with the power available in foreign countries. **Using USA or CANADA models overseas is at your own risk and will void your warranty.**

LE4131001
Printed in Malaysia

Free Manuals Download Website

<http://myh66.com>

<http://usermanuals.us>

<http://www.somanuals.com>

<http://www.4manuals.cc>

<http://www.manual-lib.com>

<http://www.404manual.com>

<http://www.luxmanual.com>

<http://aubethermostatmanual.com>

Golf course search by state

<http://golfingnear.com>

Email search by domain

<http://emailbydomain.com>

Auto manuals search

<http://auto.somanuals.com>

TV manuals search

<http://tv.somanuals.com>