

FAX 1570MC
MFC 1870MC
MFC 1970MC

brother

Year 2000 Compliant

All Brother fax machines and multi-function centers are Year 2000 Compliant. For more information, visit the Brother Home Page at <http://www.brother.com>, then click the **Year 2000 Statement** button.

Table of Contents

1	Introduction	
	Using This Manual	1
	Finding Information	1
	Test Sheet Procedures (for USA only)	1
	About Fax Machines	2
	Fax Tones and Handshake	2
	FAX 1570MC Control Panel Overview	3
	MFC 1870MC and MFC 1970MC Control Panel Overview	4
2	Installation	
	Caution	5
	Packing List	6
	Make sure you have the following items:	6
	Choosing a Location	7
	Assembly	7
	Attach the document support	7
	Attach paper support	8
	Install the printing cartridge	8
	Install paper	9
	Acceptable paper	10
	Connect the handset	10
	Connect the power cord	10
	Connect the telephone line	11
	Special Line Considerations	11
	Roll Over Phone Lines	11
	Two-Line Phone System	11
	Converting Telephone Wall Outlets	12
	Installing FAX/MFC, External Two-Line TAD, and Two-Line Telephone	12
	Multi-Line Connections (PBX)	13
	If you are installing the FAX/MFC to work with a PBX:	13
	Custom Features on Your Phone Line	14
	Connecting an External Telephone Answering Device (TAD)	14
	Sequence	14
	Connections	15
	Outgoing Message (OGM) on External TAD	16
	Connecting an External Telephone	16

Fax Settings

Fax Settings	17
Setting Dialing Mode (Tone/Pulse)	17
Setting Date and Time	17
Setting Station ID	18
Entering Text	18
Inserting spaces	19
Making corrections	19
Repeating letters	19
Special characters and symbols	19
Storing One Touch Dial Numbers	20
One Touch Dialing	21
Storing Speed Dial Numbers	22
Speed Dialing	22
Changing One Touch and Speed Dial Numbers	23
Setting Up Groups for Broadcasting	23
Setting Beeper Level	24
Memory Storage	24

On-Screen Programming

User-Friendly Programming	25
Function Mode	25
Alternating Displays	26
Function Selection Table	26

Basic Fax Operation

Sending Faxes	31
Before you begin:	31
Contrast Setting	32
Manual Transmission	32
Automatic Transmission	33
Manual and Automatic Fax Redial	33
Receiving Faxes	33
Select Answer Mode	33
Record Fax/Tel Outgoing Announcement (F/T OGM)	34
Easy Receive	34
To select or change your Answer Mode	35
Setting Ring Delay	35
Setting F/T Ring Time	36
Speaker Volume	36
Ring Volume	37
Smoothing	37
Setting Paper Size	37
Printing a Reduced Incoming Document	38
Recommended Reductions	38

Telephone & Speakerphone (Voice) Operation

Making Voice Calls	39
Manual Dialing	39
Answering Calls with the Speakerphone	39
One Touch Dialing	40
Speed Dialing	40
Hold	40
Pause	40
Tone/Pulse	40
Searching Telephone Index	41

Advanced Fax Operation

Sending Faxes	43
Quick Scan Fax Transmission	43
Daily Timer	43
Delayed Transmission	44
Interrupting Timer and Poll Waiting	44
Canceling a Delayed Fax	45
Broadcasting	45
Overseas Mode	45
Error Re-Transmission	46
Composing Electronic Cover Page	46
Always Send Cover Page	47
Cover Page (Temporary Setting)	47
Using a Printed Cover Page	48
Call Reservation	48
Print Call Back Message	49
Next-Fax Reservation	49
Multiple Resolution Transmission	50
Receiving Faxes	50
Operation from Extension Telephone	50
For F/T (Fax/Tel) Mode Only	50
Changing Remote Codes	51
To change Remote Codes	51
Distinctive Ringing	51
Registering the Distinctive Ringing phone number	52
Caller ID	53
Clearing Caller ID Information	54
Polling	54
Setup to Poll Another Fax	54
Setup to Be Polled (Poll Waiting)	55
Sequential Polling	56
Copy Functions	57
Multiple Copies	57
Reducing and Enlarging Copies	57

**Message
Center**

Message Center Mode	59
Flexible Memory Settings	60
Setting Up Message Center	60
Setting Message Storage	61
Recording Message Center Outgoing Message	61
Listening to Outgoing Message (OGM)	62
Erasing Outgoing Message (OGM)	62
Activating Message Center Mode	62
Message Indicators	62
Playing Voice Messages and Memos	63
Printing a Fax Message	63
Backup Printing Option	64
Erasing Messages	64
To erase voice messages individually	64
To erase messages all at once	65
Setting Maximum Time for Incoming Messages	65
Setting Toll Saver	65
ICM Recording Monitor	66
Recording a Memo	66
Recording a Conversation	66
Paging/Fax Forwarding	66
Programming Paging Number	67
Programming a Fax Forwarding Number	67
Remote Retrieval	68
Using Remote Access Code	68
Changing Remote Access Code	68
Remote Control Commands	69
Retrieving Memory Status List	70
Retrieving Fax Messages	70
Changing Fax Forwarding Number	71

**Message
Center Pro**

Message Center Pro	73
Start with a Plan	73
Setting Up Message Center Pro	74
Voice	74
Recording Voice Information In Memory Box	74
Playing Voice Message in Memory Box	75
Erasing Voice Memory Box	75
Personal Mailbox	76
Recording Personal Mailbox OGM/Password	76
Playing Incoming Messages and Memo in Personal Mailbox	76
Erasing Incoming Messages and Memos From Personal Mailbox	77
To erase an individual message	77

10
Printing Reports and Lists

11
Important Information

12
Troubleshooting and Maintenance

To erase all messages 77

Recording Memo in Personal Mailbox 78

Remote Retrieval of Incoming Messages and Memos In Personal Mailbox 78

Recording Second Level OGM 79

 Playing Second Level OGM 79

 Erasing Second Level OGM 79

Recording First Level OGM 80

 Playing First Level OGM 80

 Erasing First Level OGM 80

Turning On Message Center Pro 81

FAX/MFC Activity 83

 To print a report 84

 Activity Report Interval 84

 Transmission Verification (Xmit) Report 84

Standard Telephone and FCC Notices 85

 These notices are in effect on models sold and used in the United States only 85

 International Energy Star Compliance Statement 86

 WARNING 87

 Federal Commission Compliance Notice (For USA Only) 87

 Industry Canada Compliance Statement (For Canada Only) 87

 Important Safety Instructions 88

 Notice-Disclaimer of Warranties 90

 Trademarks 90

 Compilation and Publication Notice 91

Fax-Back System 93

Brother Home Page on the World Wide Web 93

Brother Bulletin Board 93

Error Messages 94

If You Are Having Difficulty with Your FAX/MFC 97

 Condensed Print and Horizontal Streaks;

 Top and Bottom of Sentences Cut Off 97

 Vertical Black Lines When Receiving 97

 FAX/MFC Does Not Answer When Called 98

 Dialing Does Not Work 98

 No Dial Tone on the Handset 98

 Poor Transmitting Quality 98

 Transmission Verification Report Says "Result: NG" 98

 Vertical Black Lines When Sending 98

 Double Ring in F/T Mode 99

 Transferring a Fax Call to the FAX/MFC 99

 FAX/MFC "Hears" Voice as CNG Tone 99

For Customer Service 99

13 Setting Up the MFC 1870MC or MFC 1970MC and Computer to Work Together

Before You Install Multi-Function Link	101
Package Contents	101
PC Configuration Requirements	102
Connecting MFC 1870MC or MFC 1970MC to Your PC	102
Available Options	103
Install Multi-Function Link Software	103
On-Line Documentation	103
Product Support	103
Brother Web Link	103
Installing the Multi-Function Link Software	104
Overview of Basic Steps	104
Accessing the Software Installation Window	104
Installing the Brother Software	104
Viewing On-Line Documentation	105

14 Using the Multi-Function Link Software (For MFC 1870MC and MFC 1970MC Only)

Introduction	107
Running the Brother Software	107
Multi-Function Link	108
Visioneer PaperPort LE	108
Sending a Fax from Your PC	109
Sending a Quick Fax	109
Sending a Fax from the Main Menu	109
Sending a Fax from a Windows® Application	110
Receiving Faxes into the PC	111
Before You Begin	111
Checklist for the MFC:	112
On your PC:	112
Viewing Received Faxes	112
Scanning a Document	113
Scanning Options	113
Resolution	114
Contrast	114
Image Type	114
Scanning into the Paperport Viewer	114

15 Multi-Function Link (option) For FAX 1570MC

.....	115
Glossary	117
Specifications	121
Index	122
Brother Numbers	126
Ordering Accessories and Supplies	127

Introduction

Using This Manual

Thank you for purchasing a Brother FAX/MFC. This FAX/MFC has been designed to be simple to use, with LCD screen prompts to guide you through functions. However, you can use your FAX/MFC to its fullest potential by taking a few minutes to read this manual.



Additionally, your FAX/MFC has a Help Key. Press **[Help]** to print a list of basic operational steps and functions.

Finding Information

All chapter headings and subheadings are listed in the Table of Contents. You will be able to find information about a specific feature or function by checking the Index at the back of this manual. Also, throughout this manual, you'll see special symbols alerting you to important information, cross-references, and warnings. Illustrations of some screen displays also help you choose the correct key-presses.

Test Sheet Procedures (for USA only)

After programming your Station ID, please fill out the TEST SHEET included with your FAX/MFC and fax it to Brother's Automated Fax Response System as your first transmission. This will verify that your FAX/MFC is properly installed.

When this document is received a confirmation sheet will be sent back to your FAX/MFC. To get a response, be sure to set up your Station ID.

USA 1-908-685-9283 (Fax)

*See
Station ID
p. 18*

About Fax Machines

If you're a first-time fax machine user, fax operation might seem a little mysterious. You'll soon get used to the unusual fax tones on your phone line, and be able to send and receive faxes easily.

Fax Tones and Handshake

When someone is sending a fax, the FAX/MFC sends fax calling tones, (CNG tones) — soft, intermittent beeps at 4-second intervals. You'll hear them when you dial and press **[Start]**, and they continue for about 40 seconds after dialing. During that time, the sending machine must begin the "handshake" with the receiving machine. Each time you use automatic procedures to send a fax, you are sending CNG tones over the phone line. You'll soon learn to listen for these soft beeps each time you answer a phone on your fax line, so you can know if you are receiving a fax message.

The receiving fax responds with fax receiving tones — loud, chirping sounds. A receiving fax chirps for about 40 seconds over the phone line, and the screen displays "RECEIVE." If your FAX/MFC is set to the FAX ONLY Mode, it will answer every call automatically with fax receiving tones. Even if the other party hangs up, your FAX/MFC continues to send the "chirps" for about 40 seconds, and the screen continues to display "RECEIVE." To cancel the receiving mode, press **[Stop]**.

When your FAX/MFC is in FAX/TEL (F/T), it answers with a short beep. After this beep, the FAX/MFC listens for CNG tones, and then responds with receiving tones.

The fax "handshake" is the time in which the sending machine's CNG tones and the receiving machine's "chirps" overlap. This must be for at least two to four seconds, so the fax machines can understand how each is sending and receiving the fax. The handshake cannot begin until the call is answered, and the CNG tones only last for about 40 seconds after the number is dialed. Therefore, it's important for the receiving machine to answer the call in as few rings as possible.



When you have an external telephone answering device (TAD) on your fax line, your TAD will determine the number of rings before the call is answered. Pay special attention to the directions in the Installation chapter for connecting a TAD to your FAX/MFC.

FAX 1570MC Control Panel Overview

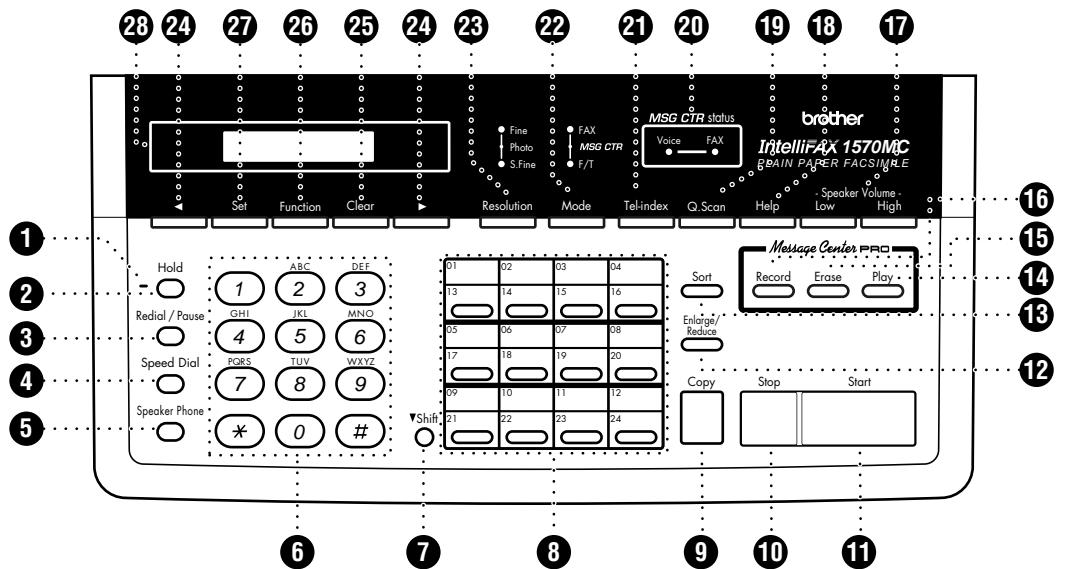

1 Microphone

Picks up your voice when you speak with another party using speaker phone.

2 Hold

Lets you put calls on hold.

3 Redial / Pause

Redials the last number called. Also inserts a pause in autodial numbers.

4 Speed Dial

Lets you dial stored phone numbers by pressing a two-digit number.

5 Speaker Phone

Lets you speak to the person at the other end and dial telephone and fax numbers without lifting the handset.

6 Dial Pad

Dials phone and fax numbers, and can be used as a keyboard for entering information into the FAX.

7 Shift

Use this key to access "13" through "24" One Touch keys.

8 One Touch Dial Keys

These twelve keys give you instant access to previously stored phone numbers.

9 Copy

Makes a copy.

10 Stop

Stops a fax, cancels an operation, or exits from function mode.

11 Start

Starts an operation, such as sending a fax.

12 Enlarge/Reduce

Use this key to enlarge or reduce copies depending on the ratio you select: 150%, 125%, 120%, 100%, 93%, 87%, 75% or 50%. To reduce the image size automatically, select AUTO.

13 Sort

Use this key when you want multiple copies of a multiple page original copied in order.

14 Play

Lets you listen to voice messages and outgoing messages, and print fax messages stored in memory.

15 Erase

Lets you delete voice messages, fax messages or all messages.

16 Record

Lets you record Outgoing Message (OGM), memos and telephone calls, and store information for Message Center Pro features.

17 Speaker Volume Low High

You can press to decrease or increase speaker volume during a call using Speaker Phone or while playing a message.

18 Help

Prints a quick reference Help List.

19 Q. Scan

Lets you take advantage of memory transmission.

20 MSG CTR Status

Indicator lights remind you that you have voice or fax messages in the memory.

21 Tel-index

Lets you look up numbers stored in the dialing memory.

22 Mode

Use to select how FAX will handle incoming calls.

23 Resolution

Sets the resolution when you send a fax or make a copy.

24 ◀ (Left Arrow) ▶ (Right Arrow)

Moves the LCD cursor to the left or right.

25 Clear

Deletes entered data or backs up one step in function procedure.

26 Function

Lets you access the function and programming mode.

27 Set

Stores a function setting into the FAX.

28 Liquid Crystal Display

LCD displays messages to help you set up and operate your FAX.

MFC 1870MC and MFC 1970MC Control Panel Overview

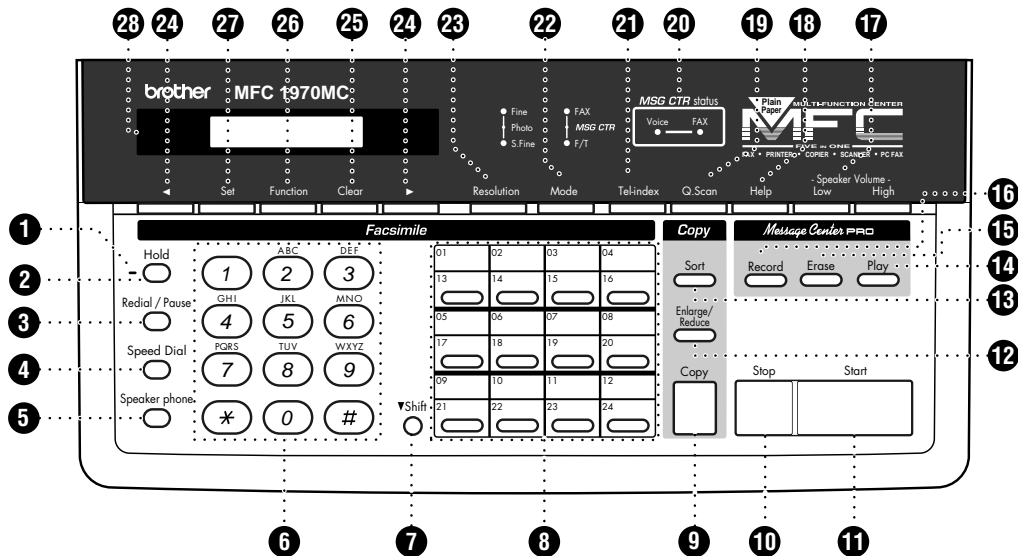

1 Microphone

Picks up your voice when you speak with another party using speaker phone.

2 Hold

Lets you put calls on hold.

3 Redial / Pause

Redials the last number called. Also inserts a pause in autodial numbers.

4 Speed Dial

Lets you dial stored phone numbers by pressing a two-digit number.

5 Speaker Phone

Lets you speak to the person at the other end and dial telephone and fax numbers without lifting the handset.

6 Dial Pad

Dials phone and fax numbers, and can be used as a keyboard for entering information into the MFC.

7 Shift

Use this key to access "13" through "24" One Touch keys.

8 One Touch Dial Keys

These twelve keys give you instant access to previously stored phone numbers.

9 Copy

Makes a copy.

10 Stop

Stops a fax, cancels an operation, or exits from function mode.

11 Start

Starts an operation, such as sending a fax.

12 Enlarge/Reduce

Use this key to enlarge or reduce copies depending on the ratio you select: 150%, 125%, 120%, 100%, 93%, 87%, 75% or 50%. To reduce the image size automatically select AUTO.

13 Sort

Use this key when you want multiple copies of a multiple page original copied in order.

14 Play

Lets you listen to voice messages and outgoing messages, and print fax messages.

15 Erase

Lets you delete voice messages, fax messages or all messages.

16 Record

Lets you record Outgoing Message (OGM), memos and telephone calls, and store information for Message Center Pro features.

17 Speaker Volume Low High

You can press to decrease or increase speaker volume during a call using Speaker Phone or while playing a message.

18 Help

Prints a quick reference Help List.

19 Q. Scan

Lets you take advantage of memory transmission.

20 MSG CTR Status

Indicator lights remind you that you have voice or fax messages in the memory.

21 Tel-index

Lets you look up numbers stored in the dialing memory.

22 Mode

Use to select how MFC will handle incoming calls.

23 Resolution

Sets the resolution when you send a fax or make a copy.

24 (Left Arrow)

Moves the LCD cursor to the left or right.

25 Clear

Deletes entered data or backs up one step in function procedure.

26 Function

Lets you access the function and programming mode.

27 Set

Stores a function setting into the MFC.

28 Liquid Crystal Display

LCD displays messages to help you set up and operate the MFC.

Installation

Caution

- 1** ▶ Never install telephone wiring during a lightning storm.
- 2** ▶ We recommend that this product be used with a surge protection device to protect the product against lightning storms.
- 3** ▶ Never install a telephone jack in a wet location unless the jack is specifically designed for a wet location.
- 4** ▶ Never touch telephone wires or terminals that are not insulated unless the telephone line has been disconnected at the network interface.
- 5** ▶ Use caution when installing or modifying telephone lines.
- 6** ▶ Avoid using a telephone (other than a cordless type) during an electrical storm. There may be a remote risk of electric shock from lightning.
- 7** ▶ Do not use the telephone to report a gas leak in the vicinity of the leak.
- 8** ▶ For PLUGGABLE EQUIPMENT, the socket-outlet should be installed near the equipment and should be easily accessible.

Packing List

Make sure you have the following items:

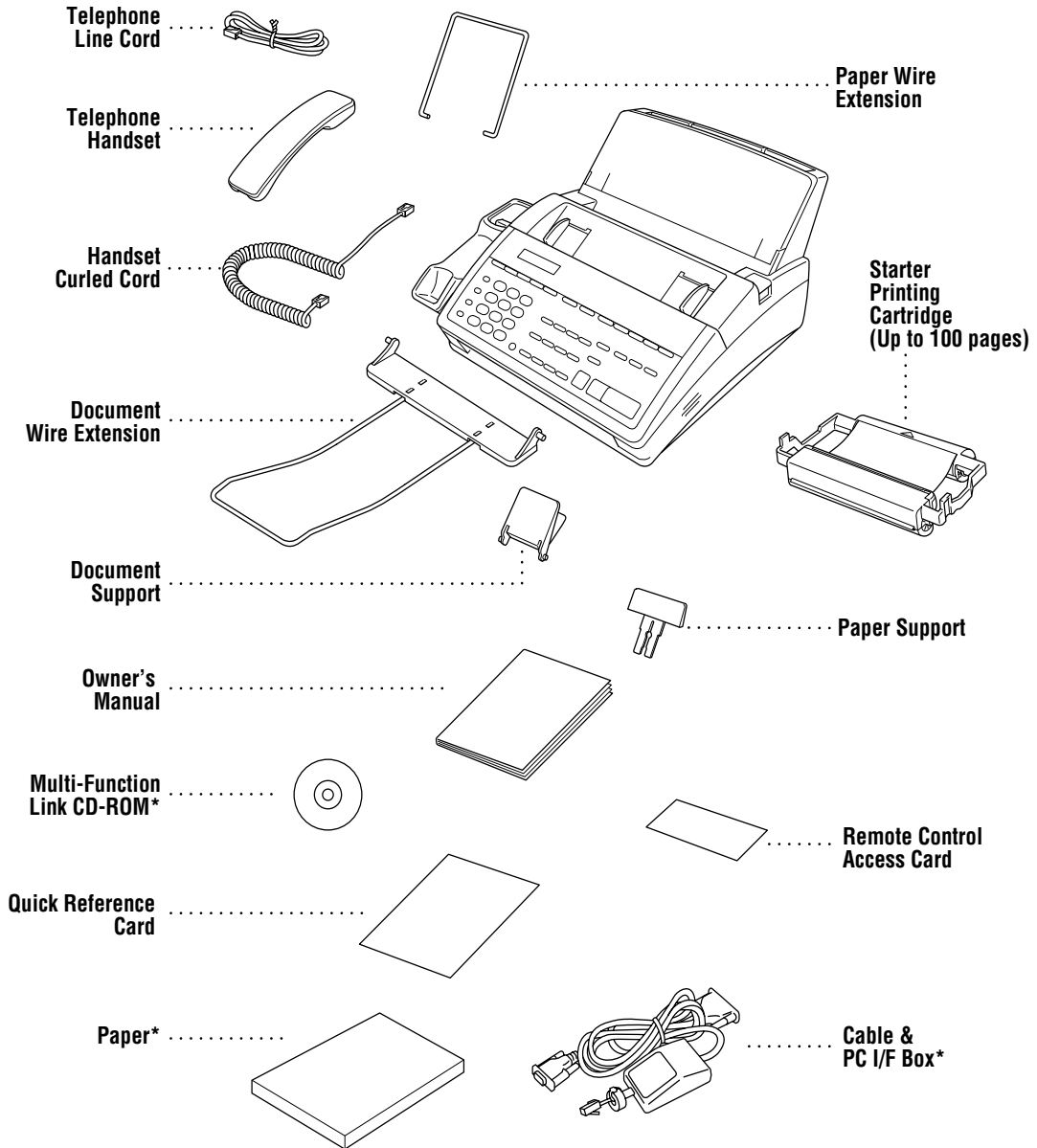

*..... For MFC 1870MC and MFC 1970MC only

Choosing a Location

Place your FAX/MFC on a flat, stable surface, such as a desk. Select a place that is free of vibration and shocks. Locate the machine near a telephone jack and a standard, grounded power outlet.



Avoid placing your FAX/MFC in a high-traffic area. Do not place near heaters, air conditioners, water, chemicals, or refrigerators. Do not expose the FAX/MFC to direct sunlight, excessive heat, moisture, or dust. Do not connect your FAX/MFC to electrical outlets controlled by wall switches or automatic timers. Disruption of power can wipe out information in the unit's memory. Do not connect your FAX/MFC to electrical outlets on the same circuit as large appliances or other equipment that might disrupt the power supply. Avoid interference sources, such as speakers or the base units of cordless phones.

Assembly

Attach the document support

Attach the document support and the document wire extension as shown in the illustration below.

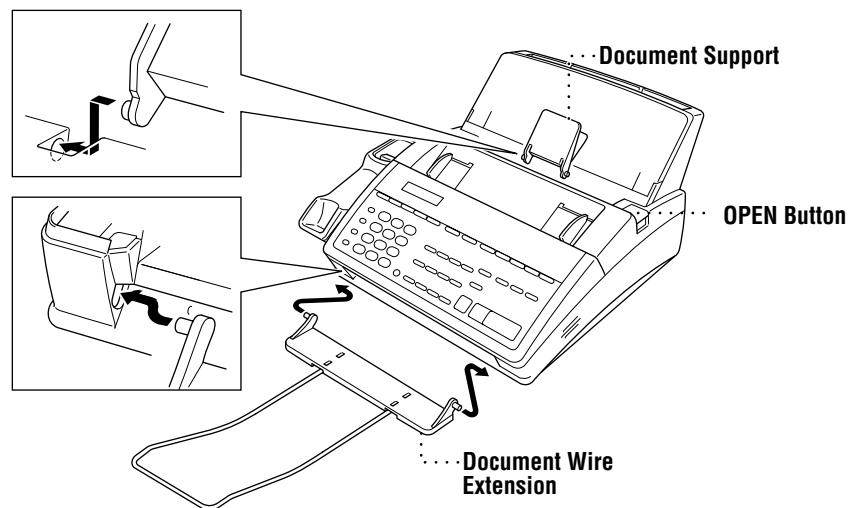

Attach paper support

- 1 Attach the paper wire extension.
- 2 Open the paper cover. Insert the paper support into the grooves of the cover as shown.

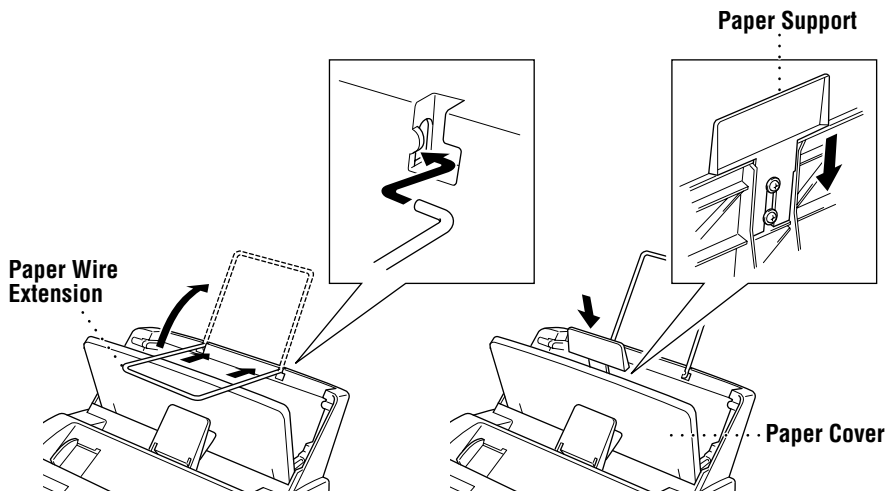

Install the printing cartridge

- 1 Push the OPEN button to open the top cover.
- 2 Remove the paper stopper from the printing cartridge.

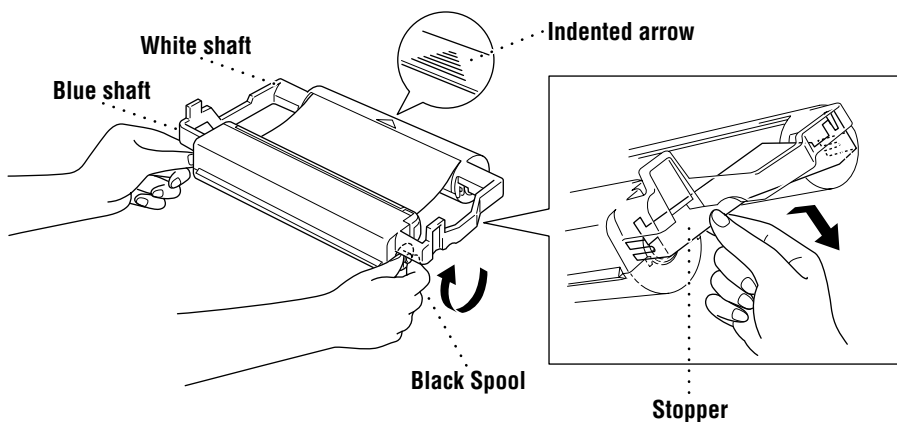

- 3 Turn the black spool on the right clockwise to tighten the ribbon, as shown.

- 4** Install the printing cartridge by inserting the indented \triangle first and placing the cartridge into its four holders.

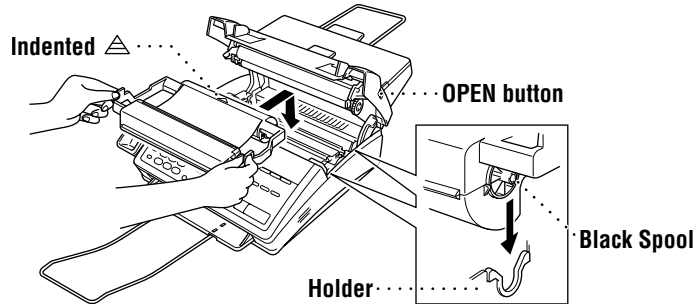

- 5** Press down on both sides of the cover to close it securely.



The starter cartridge prints approximately 100 pages.

Install paper

The paper cassette can hold about 200 sheets of 20-lb. paper.

- 1** Open the cover of the paper holder.
- 2** Place up to 200 sheets of paper in the paper holder. Do not allow the level of paper to pass the paper guides.
- 3** Close the paper cover.

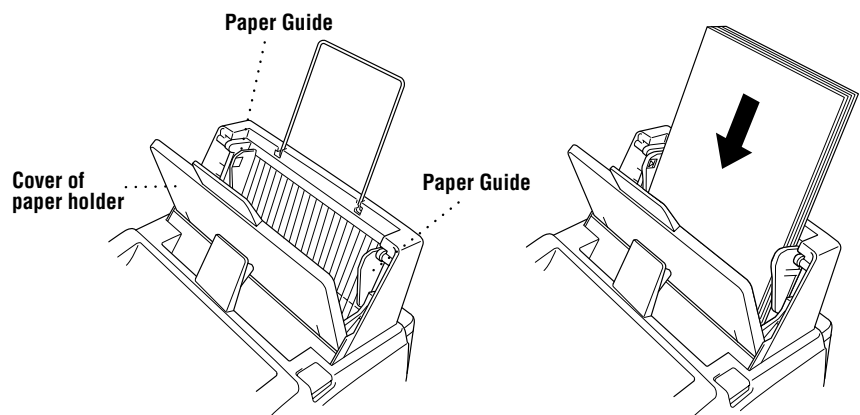

Acceptable Paper

Size: Letter, Legal and A4
Weight: 17 lb. -24 lb.
Thickness: .0031 inches - .0039 inches

Connect the handset

Connect the curled handset cord to the bottom of the handset and the side of the FAX/MFC.

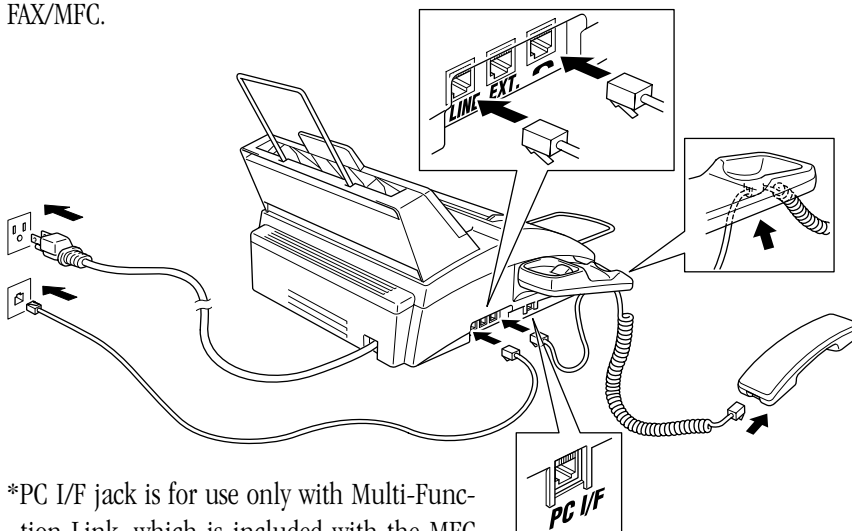

*PC I/F jack is for use only with Multi-Function Link, which is included with the MFC 1870MC and MFC 1970MC, or with the optional software. If you have not purchased the *optional* Multi-Function Link (also called “Missing Link”) for your FAX 1570MC, then ignore this jack.



Connect the power cord

When you connect the power, the screen displays 01/01 00:00 FAX.

NOTICE:

- 1) This fax must be grounded using a 3-prong plug.
- 2) Since the FAX/MFC is grounded through the power outlet, you can protect yourself from potentially hazardous electrical conditions on the telephone line by keeping the power to your FAX/MFC on when you connect it to a telephone line. Similarly, you can protect yourself when you want to move your machine, by disconnecting the telephone line first, and then the power cord.

- 3) Lightning and power surges can damage this product! We recommend that you use a quality surge protection device on the AC power line as well as on the telephone line, or unplug the telephone line and electrical cords during a lightning storm.

Connect the telephone line

Connect one end of the telephone line cord to the jack labeled **LINE** on the left side of the FAX/MFC. Connect the other end to a modular wall jack.

Special Line Considerations

Roll Over Phone Lines

A roll over phone system is a group of two or more separate telephone lines that pass incoming calls to each other if they are busy. The calls are usually passed down or “rolled over” to the next available phone line in a preset order.

Your FAX/MFC can work in a roll over system as long as it is the last number in the sequence, so the call cannot roll away. Do not put the FAX/MFC on any of the other numbers; when the other lines are busy and a second fax call is received, the fax call is transferred to a line that does not have a fax machine. Your FAX/MFC will work best on a dedicated line.

Two-Line Phone System

A two-line phone system is nothing more than two separate phone numbers on the same wall outlet. The two phone numbers can be on separate jacks (RJ11) or combined into one jack (RJ14). Your FAX/MFC must be plugged into an RJ11 jack. RJ11 and RJ14 jacks may be equal in size and appearance and both may contain 4 wires (black, red, green, yellow). To test the type of jack, plug in a two-line phone and see if it can access both lines. If it can, you must separate the line for your FAX/MFC.

Converting Telephone Wall Outlets

There are three ways to convert to an RJ11 receptacle. The first two ways may require assistance from the telephone company. You can change the wall outlets from one RJ14 jack to two RJ11 jacks. Or, you can have an RJ11 wall outlet installed and slave or jump one of the phone numbers to it.

The third way is the easiest: Buy a triplex adapter. You can plug a triplex adapter into an RJ14 outlet. It separates the wires into two separate RJ11 jacks (Line 1, Line 2) and a third RJ14 jack (Lines 1 and 2). Plug the FAX/MFC into Line 2 of the triplex adapter.

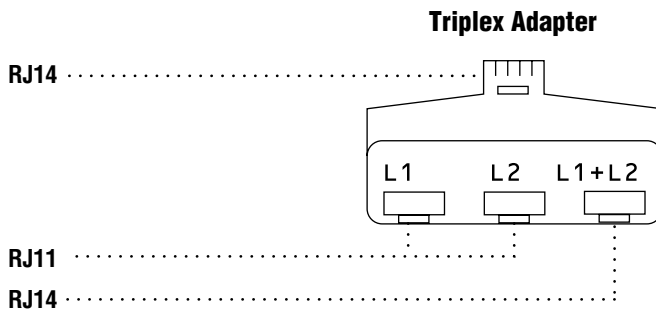

Installing FAX/MFC, External Two-Line TAD, and Two-Line Telephone

When you are installing an **external** two-line telephone answering device (TAD) and a two-line telephone, your FAX/MFC must be isolated on one line at both the wall jack and at the TAD. The most common connection is to put the FAX/MFC on Line 2. The back of the two-line TAD must have two telephone jacks: one labeled L1 or L1/L2, and the other labeled L2. You will need at least three telephone line cords, the one that came with your FAX/MFC and two for your external two-line TAD. You will need a fourth line cord if you add a two-line telephone.

- 1** Place the two-line TAD and the two-line telephone next to your FAX/MFC.
- 2** Plug one end of the telephone line cord for your FAX/MFC into the L2 jack of the triplex adapter. Plug the other end into the **LINE** jack on the left side of the FAX/MFC.
- 3** Plug one end of the first telephone line cord for your TAD into the L1 jack of the triplex adapter. Plug the other end into the L1 or L1/L2 jack of the two-line TAD.

- 4 Plug one end of the second telephone line cord for your TAD into the L2 jack of the two-line TAD. Plug the other end into the **EXT.** jack on the left side of the FAX/MFC.

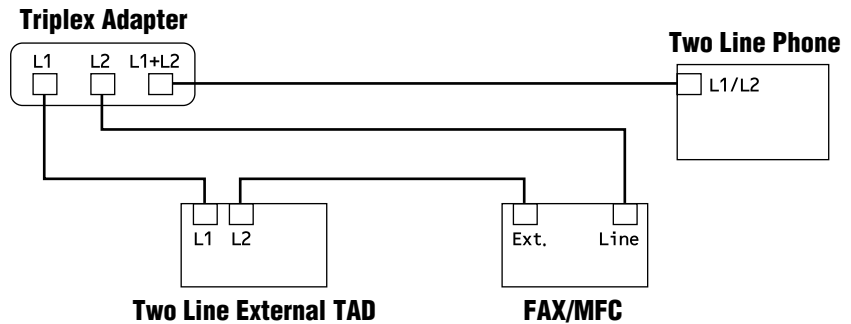

You can keep two-line telephones on other wall outlets as always. There are two ways to add a two-line telephone to the FAX/MFC's wall outlet. You can plug the telephone line cord from the two-line telephone into the L1+L2 jack of the triplex adapter. Or, you can plug the two-line telephone into the TEL jack of the two-line TAD.

Multi-Line Connections (PBX)

Most offices use a central telephone system. While it is often relatively simple to connect the FAX/MFC to a key system or a PBX (Private Branch Exchange), we suggest that you contact the company that installed your telephone system and ask them to connect the FAX/MFC for you. It is advisable to have a separate line for the FAX/MFC. You can then leave the machine in FAX ONLY Mode to receive faxes any time of day or night.

*See
Easy Receive
pp. 34-35*



If the FAX/MFC is to be connected to a multi-line system, ask your installer to connect the unit to the last line on the system. This prevents the unit from being activated each time a telephone call is received.

As with all fax units, this machine must be connected to a two wire system. If your line has more than two wires, proper connection of the FAX/MFC cannot be made.

If you are installing the FAX/MFC to work with a PBX:

- 1 It is not guaranteed that the unit will operate correctly under all circumstances with a PBX. Any cases of difficulty should be reported first to the company that handles your PBX.

- 2 If all incoming calls will be answered by a switchboard operator, it is recommended that the Answer Mode be set to MANUAL. All incoming calls should initially be regarded as telephone calls.
- 3 The unit may be used with either pulse or tone dialing telephone service.

Custom Features on Your Phone Line

If you have Ring Master, Voice Mail, an answering service, alarm system or any other custom feature on your telephone line, it may create a problem in the operation of your FAX/MFC.

Connecting an External Telephone Answering Device (TAD)

Sequence

You might choose to connect an additional answering system. When you have an **external** TAD on the same telephone line as the FAX/MFC, the TAD answers all calls. The FAX/MFC “listens” for fax calling (CNG) tones. If it hears them, the FAX/MFC takes over the call and receives the fax. If it doesn’t hear CNG tones, the FAX/MFC lets the TAD continue playing your outgoing message so your caller can leave you a voice message.

The TAD must answer within 4 rings (the recommended setting is 2 rings). The FAX/MFC cannot hear CNG tones until the TAD has answered the call, and with 4 rings there are only 8-10 seconds of CNG tones left for the fax “handshake.” Make sure you carefully follow instructions in this manual for recording your outgoing message. Do not use a “toll-saver” ring setting on the TAD.



Do not connect a TAD elsewhere on the same phone line—your FAX/MFC and TAD will both try to control the line.

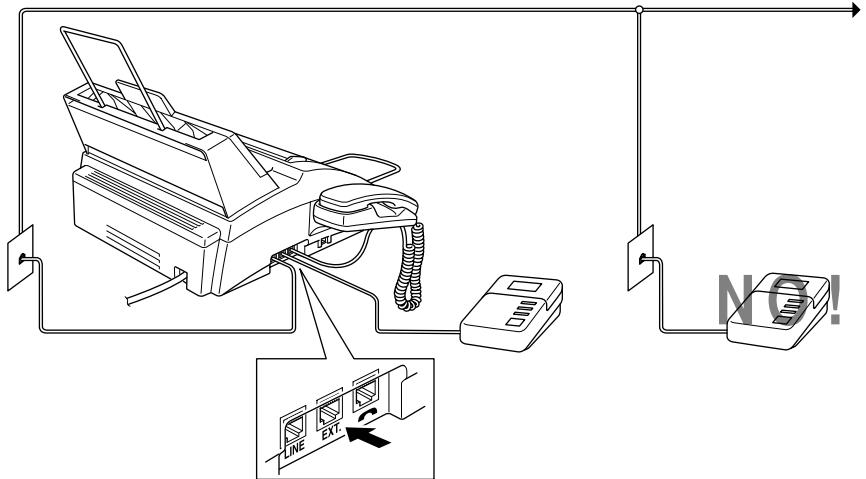

Connections

The external TAD must be plugged into the left side of the FAX/MFC, into the jack labeled EXT. Your FAX/MFC cannot work properly if you plug the TAD into a wall jack.

- 1** Plug the telephone line cord from the wall jack into the left side of the FAX/MFC, in the jack labeled LINE.
- 2** Plug the telephone line cord from your TAD into the left side of the FAX/MFC, in the jack labeled EXT. (Make sure this cord is connected to the TAD at the TAD's telephone line jack, and not its telephone set jack.)
- 3** Set your external TAD to 4 rings or less. (The FAX/MFC's Ring Delay setting does not apply).
- 4** Record the outgoing message (see below).
- 5** Set the TAD to answer calls.
- 6** Set Message Storage (Function, 8, 1) to VOICE:EXT..
- 7** Set the Answer Mode to MC:MSG CTR.

Outgoing Message (OGM) on External TAD

Timing is important in recording this message. The message sets up the way your external TAD handles both manual and automatic fax reception.

- 1** Record 5 seconds of silence at the beginning of your message. (This allows your FAX/MFC time to listen for the fax CNG tones of automatic transmissions before they stop.)
- 2** Limit your speaking to 20 seconds.
- 3** End your 20-second message by giving your Remote Activation Code for people sending manual faxes. For example:
“After the beep, leave a message or send a fax by pressing * 5 1.”

Connecting an External Telephone

Your FAX/MFC is equipped with a handset that you can use as a regular phone. However, you can also connect a separate telephone (or telephone answering device) directly to your FAX/MFC.

Connect the modular plug on the telephone's line cord to the jack labeled **EXT.** on the left side of the FAX/MFC.

Whenever this phone (or TAD) is in use, the screen displays “EXT. TEL IN USE,” and, if the fax handset is lifted, an alarm sounds. To disconnect the call on the external phone and switch to the fax, press **Speaker Phone**.

Fax Settings

Fax Settings

Setting Dialing Mode (Tone/Pulse)

Your FAX/MFC comes set to accommodate tone (multi-frequency) dialing service. If you have pulse (rotary) dialing service, you need to change the dialing mode.

- 1 Press **Function**, **6**, **1**. The screen prompts you to select TONE or PULSE.

DIALING: TONE

DIALING: PULSE

- 2 Use **◀** or **▶** to select dialing mode.
- 3 Press **Set** when the screen displays the dialing mode you want.
- 4 Press **Stop**.

Setting Date and Time

Your FAX/MFC displays the date and time, and prints it on every fax you send.

In the event of a power failure, the FAX/MFC maintains date and time information for about one hour. All other settings remain unaffected.

- 1 Press **Function**, **7**, **1**. The screen prompts you to enter the year:

ENTER YEAR: XX

- 2 Enter the last two digits of the year. The screen displays your entry, then prompts you to enter the month.

ENTER MONTH: XX

- 3** Enter two digits for the month (for example, enter 09 for September, or 10 for October). The screen displays your entry, then prompts you to enter the day.

ENTER DAY: XX

- 4** Enter two digits for the day (for example, 06). The screen displays your entry, then prompts you to set the time.

ENTER TIME: XX:XX

- 5** Enter the time in 24-hour format (for example, enter 15:25 for 3:25 PM).

- 6** Wait two seconds.

- 7** Press **[Stop]**. The screen now displays the date and time you set, and displays it whenever the FAX/MFC is standing by.

Setting Station ID

You can store your name, fax number, and telephone number to be printed on the fax Cover Page, and on all fax pages.

- 1** Press **[Function]**, **[7]**, **[4]**. The screen prompts you to enter your fax number.

FAX:

- 2** Enter your fax number (up to 20 digits). The screen displays your entry.

- 3** Press **[Set]**. The screen prompts you to enter your telephone number.

TEL:

- 4** Enter your telephone number (up to 20 digits). If your telephone number and fax number are the same, enter the same number again.

- 5** Press **[Set]**. The screen prompts you to enter your name or your company name.

NAME:

- 6** Use the dial pad to enter your name (up to 20 characters). (You can use the chart on page 19 to help you enter letters.)

- 7** Press **[Set]** to confirm.

- 8** Press **[Stop]**. The screen returns to the date and time.

Entering Text

When you are setting certain functions, such as the Station ID, you may need to enter text into the FAX/MFC. Most number keys have three or four letters printed above them. The keys for 0, #, and * don't have printed letters because they are used for special characters.

*See
Composing
Electronic
Cover Page
p. 46*

*See
Entering
Text
pp. 18-19*

By pressing the appropriate number key the correct number of times, you can access the character you want.

Press Key	one time	two times	three times	four times
2	A	B	C	
3	D	E	F	
4	G	H	I	
5	J	K	L	
6	M	N	O	
7	P	Q	R	S
8	T	U	V	
9	W	X	Y	Z

Inserting spaces

If you want to enter a blank space, press  twice.

Making corrections

If you entered a letter incorrectly and want to change it, press  to move the cursor after the last correct letter. Then press **Clear**; all letters to the right of the cursor are deleted. Re-enter the correct text and/or digits.

Repeating letters

If you need to enter a character assigned to the same key as the previous character, press  to move the cursor to the right.

Special characters and symbols

Press * for (space) ! “ # \$ % & ’ () * + , - . /

Press # for ; < = > ? @ [] ^ _

Press Ø for Ä Ë Ö Ü À Ç È É 0

NOTICE: The Telephone Consumer Protection Act of 1991 makes it unlawful for any person to use a computer or electronic device to send any message via a telephone fax machine unless such message clearly contains, in a margin at the top or bottom of each transmitted page, or on the first page of the transmission, the date and time it is sent and an identification of the business or other entity or other individual sending the message and the telephone number of the sending machine or such business, other entity, or individual. In order to program this information into your FAX/MFC, you should complete the steps described on page 18 and 19.











See
ALL DIAL
Report
p. 83

- The telephone number you enter is used only for Call Back Message and Cover Page features.
- If you do not enter a fax number, no additional information can be entered.
- To enter a space, press  once between numbers and twice between characters.
- If your Station ID has already been programmed, the screen prompts “1” to make a change, or “2” to exit without changing.

Storing One Touch Dial Numbers

You can store 24 fax/phone numbers that you can dial by pressing one key. You can also store names with these numbers. When you press a One Touch dial location, the screen displays the name or number as the call is dialed.

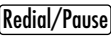
One Touch keys are not the dial pad keys. They are the 12 keys (number 01-24) located to the right of the dial pad. One Touch Numbers 13-24 are accessed by holding down  when you press the appropriate One Touch key.

- 1** Press , , .
- 2** Press the One Touch key where you want to store a number. (One Touch key  is pre-programmed for Brother Fax-Back System (USA only). You can override it if you wish.) The screen displays the location you selected.
- 3** Enter a number (up to 20 digits). If you want to enter a pause in the dialing sequence (to wait for an “outside line,” for example), press  as you’re entering digits. Pressing  enters a 3.5-second pause when the number is dialed, and a dash appears on the screen.
- 4** Press . The screen prompts you to enter a name for this number.

NAME :

- 5** Use the dial pad to enter the name (up to 15 characters). You can use the chart on page 19 to help you enter letters—**OR**—Go to Step 6 to store the number without a name.

- 6** Press **Set**. The screen prompts you to select the type of number this is. Use **◀** or **▶** to select the type you want.

FAX a fax only number

TEL a telephone (voice) number

F/T both a fax and telephone (voice) number

CHAIN a number (usually an access code) for chain dialing.

- 7** Press **Set**.

- 8** Return to Step 2 to store another One Touch number—**OR**—Press **Stop** to exit.

When you dial an AUTO DIAL number, the screen displays the name you've stored, or, if you haven't stored a name, the number you've stored .



If you need to store a pause longer than 3.5 seconds, please call Brother Customer Service at 1-800-284-4329 in the USA, or 1-800-853-6660 from within Canada.

You can use chain dialing to store long dialing sequences. For example, to store **9 1 201 555 1234 987 65 4321**, divide the number into 2 parts. Store the first part as a Chain type number (this tells the system that the dialing sequence is not complete).

CHAIN—9 1 201 555 1234

The last part of the One Touch number must be stored as any of the other following 3 types.

FAX or F/T or TEL—987 65 4321

Now, when you dial, just press the two keys (one after the other, in order) where you've stored the two parts of the number.



If you are using Chain Dialing with a credit card number, do not send an electronic cover page. **The credit card number will appear on it.**

One Touch Dialing

- 1** Pick up the handset—**OR**—Press **Speaker Phone**.
- 2** When you hear a dial tone, press the One Touch key of the location you want to call.

If you try to use a One Touch location with no number stored in it, you hear a warning sound, and the screen displays NOT REGISTERED. The display returns to normal after 2 seconds.



Storing Speed Dial Numbers

You can store Speed Dial numbers, when you dial by pressing only three keys. Model MFC 1870MC has 36 Speed Dial locations, Models FAX 1570MC and MFC 1970MC have 100. Even if you lose electrical power, numbers stored in memory will not be lost.

- 1 Press **[Function]**, **[4]**, **[2]**. The screen prompts you to enter a location.

SPEED-DIAL? #_

- 2 Use the dial pad to enter a 2-digit location. (For model MFC 1870MC, enter 01 - 36.) (For models FAX 1570MC and MFC 1970MC, enter 00 - 99.) The screen displays your entry, then prompts you to enter the number you're storing.

#05
ENTER & SET

- 3 Enter the number (up to 20 digits).
- 4 Press **[Set]**. The screen now prompts you to store a name with this number.
- 5 Use the dial pad to enter the name (up to 15 characters). You can use the chart on page 19 to help you enter letters—**OR**—Press **[Set]** and go to Step 7 to store the number without a name.
- 6 Press **[Set]**.
- 7 The screen prompts you to select the type of number this is. Use **[Left Arrow]** or **[Right Arrow]** to select the type you want.

FAX a fax number

TEL a telephone (voice) number

F/T both a fax and telephone number

CHAIN a number (usually an access code) for chain dialing.

- 8 Press **[Set]**.
- 9 Return to Step 2 to store another Speed Dial number—**OR**—Press **[Stop]** to exit.

Speed Dialing

- 1 Pick up the handset—**OR**—Press **[Speaker Phone]**.
- 2 When you hear a dial tone, press **[Speed Dial]**, then press the two-digit Speed Dial number.

Changing One Touch and Speed Dial Numbers

If you try to store a One Touch or Speed Dial number in a location where a number is already stored, the screen displays the current name stored there, then prompts you to either

1. CHANGE —OR— 2. EXIT.

- 1 Press **[1]** to change the number stored, or press **[2]** to exit without making a change.
- 2 If you want to erase the number, press **[Clear]** when the cursor is to the far left of the digits.
- 3 If you want to change a digit, use **[◀]** or **[▶]** to position the cursor under the digit you want to change, then press **[Clear]**.
- 4 Enter a new number.
- 5 Follow the directions from Step 4 in Storing One Touch Numbers or Storing Speed Dial Numbers.

Setting Up Groups for Broadcasting

Groups allow you to send the same fax message to many fax numbers by pressing only one One Touch key (Broadcasting). **First**, you'll need to store each fax number as a One Touch or Speed Dial number. **Then**, you can combine them into a Group. Each Group uses a One Touch key. Finally, you can have up to 6 small Groups, or you can assign many numbers to one large group. If you have Model MFC 1870MC you can assign up to 59 numbers to one large group, and for Models FAX 1570MC and MFC 1970MC up to 123 numbers to one large group.

- 1 Press **[Function]**, **[4]**, **[3]**. The screen displays:

SELECT ONE-TOUCH

- 2 Select a One Touch key where you wish to store the number. (For example, press One Touch key **[02]** to use as a group.)
- 3 Use the dial pad to enter the Group number (for example, press **[1]** for Group 1).

SETUP GROUP:GO
ENTER & SET

*See
Storing
One Touch
Dial
Numbers
pp. 20-21
and
Storing
Speed Dial
Numbers
p. 22*

- 4** Use the dial pad to enter the One Touch or Speed Dial numbers in this group. For example, enter **# 0 3**, **# 0 5**, *** 0 2**. Enter a **#** before Speed Dial locations; enter a ***** before One Touch locations.

G01: #03#05*02_

- 5** Press **Set**. The screen prompts you to enter a name.

NAME:
ENTER & SET

- 6** Use the dial pad and the chart on pages 18-19 to enter a name for the group (for example, NEW CLIENTS).
- 7** Press **Set**.
- 8** Press **Stop** to exit.

You can print a list of all One Touch and Speed Dial numbers. See Chapter 10, "Printing Reports and Lists."



Setting Beeper Level

You can set the beeper to **LOW**, **HIGH** or **OFF**. The FAX/MFC comes set to **LOW**. When the beeper is set to **LOW** or **HIGH**, the FAX/MFC beeps every time you press a key or make an error, and at the end of fax sending or receiving.

- 1** Press **Function**, **5**, **2**.
- 2** Press **◀** or **▶** to select your setting.
- 3** When the screen displays the setting you want, press **Set**.
- 4** Press **Stop** to exit.

Memory Storage

All settings in the SET AUTO DIAL, USER OPTIONS, TEL OPTIONS, and SETUP SYSTEM functions are stored permanently and will be retained even in the event of a power failure.

CHAPTER FOUR

On-Screen Programming

User-Friendly Programming

*See
Using This
Manual p. 1*

We have designed your FAX/MFC with on-screen programming and a Help key. User-friendly programming helps you take full advantage of all the functions your FAX/MFC has to offer.

Since your fax programming is done on the LCD, we created step-by-step on-screen prompts to help you program your FAX/MFC. All you need to do is follow the prompts as they guide you through the function menu selections and programming options and settings.

Function Mode

You can access the function mode by pressing **[Function]**. When you enter the function mode, your FAX/MFC displays a list of Level One Functions from which you can choose. These function options appear one after the other on the display. Select an option by pressing **[Set]** when the option appears on the LCD.

You can “scroll” more quickly through options by pressing **[▶]**. When the screen displays your selection, press **[Set]**. (Use **[◀]** to scroll backward if you passed your choice or to save key strokes. Both arrow keys show all options, in the opposite order.)



If you want to exit the Function Mode, press **[Stop]**.

Alternating Displays

When you see alternating displays, the LCD sometimes alternates between the currently selected option, and a help message giving brief instructions about how to proceed. The display you'll probably see most often is shown below, showing you, when you place a document in the feeder, that you can dial a number and send a fax, or you can make a copy.



Function Selection Table

If you have a basic understanding of how to program a fax machine, you can perform most of the programming settings without the Owner's Manual. To help you understand the function selections, options, and settings that are found in your fax and Message Center programs, use the Function Selection Table below.

1. TEMP. SETTINGS			
Function	Description	Factory Set	More Info
1. TIMER	Send documents later.	--	p. 44
2. POLLING	Retrieve faxes from another machine.	OFF	pp. 54–56
3. CALL RESERVE	You can send a fax, then speak.	OFF	pp. 48–49
4. CONTRAST	Change lightness or darkness of fax you're sending.	AUTO	p. 32
5. RESOLUTION	Allows you to change resolution page by page.	STANDARD	pp. 32, 50
6. OVERSEAS MODE	Adjusts for sometimes difficult overseas transmissions.	OFF	p. 45
7. COVERPAGE	Automatically sends cover page you program.	OFF	pp. 47–48
2. CANCEL JOB			
Function	Description	Factory Set	More Info
	Cancel a timed or polled job.		p.45

3. PRINT REPORTS

Function	Description	Factory Set	More Info
1. ACT. REPORT 2. ALL DIAL 3. TEL. INDEX 4. COVERPAGE 5. CALL BACK MSG 6. USER OPTIONS 7. XMIT REPORT 8. MEMORY STATUS 9. CALLER ID	Print lists and reports of activity. (Details in Chapter 10)	OFF	pp. 83–84 p. 83 p. 83 pp. 48, 83 pp. 49, 83 p. 83 pp. 83–84 p. 83 p. 83

4. SET AUTO DIAL

Function	Description	Factory Set	More Info
1. ONE-TOUCH DIAL	Dial numbers stored in memory by pressing only one key.	USER DEFINED	pp. 20–21
2. SPEED-DIAL	Dial numbers stored in memory pressing only 3 keys.		p. 22
3. SETUP GROUPS	Set up a group number for broadcasting.		pp. 23–24

5. USER OPTIONS

Function	Description	Factory Set	More Info
1. SMOOTHING	Enhance the appearance of incoming faxes.	ON	p. 37
2. BEEPER	Adjust volume level of beeper.	LOW	p. 24
3. COVERPG ON/OFF	Send automatic cover page with comment.	OFF	p. 47
4. ERROR RE-TX	Resend a fax if an error occurs.	OFF	p. 46
5. REDUCTION	Reduce size of image.	AUTO	p. 38
6. RCD PAPER	Select size of paper for fax receiving.	LETTER	p. 37

6. TEL OPTIONS			
Function	Description	Factory Set	More Info
1. TONE/PULSE	Select dialing mode.	TONE	p. 17
2. RING DELAY	Number of rings before machine answers in F/T, FAX or MC mode.	2	p. 35
3. SPEAKER VOLUME	Adjust speaker volume.	LOW	p. 36
4. ICM REC. MONITR	Adjust volume of incoming messages.	LOW	p. 66
5. F/T RING TIME	Sets the time for “double-ring” in F/T mode.	20	p. 36
6. RING VOLUME	Adjust volume of ringer.	MEDIUM	p. 37
7. DISTINCTIVE	Use with phone company distinctive ringing service to register the ring pattern with FAX/MFC.	OFF	pp. 51–52
8. CALLER ID	View a list of the last 30 Caller IDs stored in memory.		pp. 53–54

7. SETUP SYSTEM			
Function	Description	Factory Set	More Info
1. DATE/TIME	Enter date and time for LCD display and to print on transmissions.	01/01/1999 00:00	pp. 17–18
2. DAILY TIMER	Send delayed jobs at the same time every day.	00:00	p. 43
3. INTERVAL	Select the interval of time between activity reports.	OFF	p. 84
4. STATION ID	Program name, fax number, and telephone number to appear on each transmitted page.	--	p. 18
5. REMOTE CODE	Enter code to activate or deactivate machine from a remote location.	ON (✳51, #51)	p. 51
6. EASY RECEIVE	Receive fax messages without pressing the Start key.	ON	pp. 34-35
7. SET COVERPAGE	Register your own two custom comments.		p. 46
(8.MF LINK) (For MFC 1870MC and MFC 1970MC only)	Fax Receive Only/ PC Primary/ PC Receive Only	PC Primary	Multi-Function Link/Missing Link

8. SETUP MSG CTR

Function	Description	Factory Set	More Info
1. MSG STORAGE	Select if memory will store fax, voice or both.	FAX:OFF/ VOICE:ON	p. 61
2. BACKUP PRINT	Select if fax prints memory backup.	ON	p. 64
3. FAX FWD/PAGING	Set fax to forward fax/message OR to call your pager.	OFF	pp. 66–67
4. REMOTE ACCESS	Set code for retrieving messages.	159✳	p. 68
5. ICM MAX. TIME	Set length of incoming messages.	30 seconds	p. 65
6. OGM	Select/record outgoing message.	MSG CTR OGM	pp. 61-62
7. TOLL SAVER	Set to ring twice when messages are waiting.	OFF	p. 65

9. SETUP MC PRO

Function	Description	Factory Set	More Info
1. MSG CTR PRO	Select ON or OFF.	OFF	p. 81
2. OGM	Record outgoing announcements for 1st Level and 2nd Level.		pp. 79–80
3. MAIL BOX	Select primary (default) mailbox.		p. 76
4. VOICE INFO	Store the voice information for each Voice-on-Demand.	User Defined	pp. 74–75

0. INTERRUPT

Function	Description	Factory Set	More Info
—	Send a fax now OR make a copy, even if you have the FAX/MFC set up to send a fax later or for Polling.	—	p. 44

Basic Fax Operation

Sending Faxes

Before you begin:

- Documents must be between 5.8 and 8.5 inches wide, and 5.9 and 23.7 inches long. Your FAX/MFC can only scan an image 8.2 inches wide, regardless of how wide the paper is.
- Make sure you insert documents **face down, top edge first**.
- Adjust the paper guides to fit the width of your document.

Paper guides

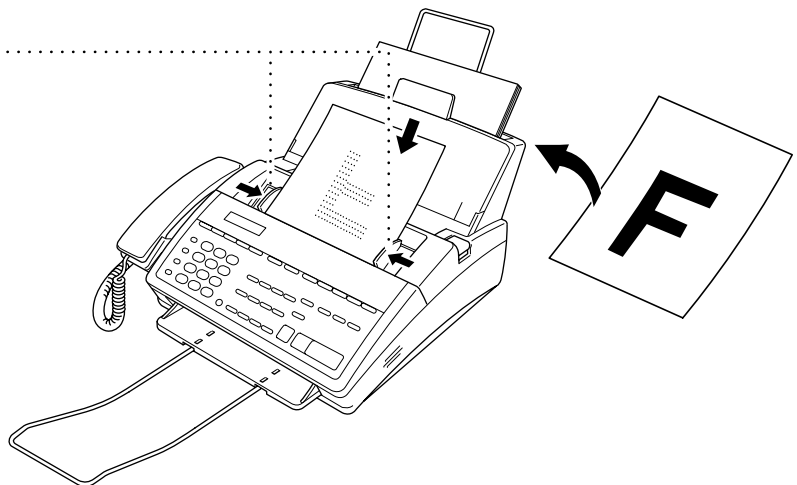

- The automatic document feeder (ADF) can hold up to 20 pages, feeding each one individually through the FAX/MFC. Use standard (20 lb.) paper when using the ADF; if you're using heavier paper, feed each sheet individually to prevent paper jams.



- Press **Resolution** (before you send the fax or make a copy) to select the resolution for the document you're sending.
 - Standard** — Suitable for most typed documents.
 - Fine** — Good for small print; transmits a little slower than standard resolution.
 - Super Fine** — Good for small print or artwork; transmits slower than fine resolution.
 - Photo** — Use when document has varying shades of gray; slowest transmission time.
- **DO NOT** use curled, wrinkled, folded, or ripped paper, or paper with staples, paper clips, paste or tape attached. **DO NOT** use cardboard, newspaper, or fabric.
- Make sure documents written with ink are completely dry.

Contrast Setting

If your document is very light or very dark, you might want to set the contrast accordingly. Use **S.LIGHT** to send a very light document. Use **S.DARK** to send a very dark document.

- 1 Insert the document, face down, in the feeder.
- 2 Press **Function**, **1**, **4**.
- 3 Use **◀** or **▶** to select **AUTO**, **S.LIGHT**, or **S.DARK**.
- 4 When the screen displays your selection, press **Set**.
- 5 Press **Stop** to exit.
- 6 Enter a fax number and press **Start** to send a fax—**OR**—Press **Copy** to make a copy.

Manual Transmission

Manual transmission lets you hear the dial tone, ringing, and fax chirps before sending the fax.

- 1 Insert the document face down in the feeder.
- 2 Pick up the handset and listen for a dial tone
 - OR**—press **Speaker Phone** and listen for a dial tone.
- 3 Enter the fax number you want to call (you can enter the digits using the dial pad, or you can enter a One Touch or Speed Dial number or you can call from the Tel-index).

*See
One Touch
Dialing
p. 21*

*See
Speed Dial
p. 22*

- 4 When you hear the fax tone, press **[Start]**.
- 5 If you're using the handset, hang up.

Automatic Transmission

This is the easiest way to send a fax.

IMPORTANT: Do **not** pick up the handset or press **[Speaker Phone]**.

- 1 Insert the document face down in the feeder.
- 2 Enter the fax number using One Touch, Speed Dial, Tel-index or the dial pad.
- 3 Press **[Start]**.

Manual and Automatic Fax Redial

If you're sending a fax manually and the line is busy, press **[Redial/Pause]** to retry the number.

If you're sending a fax automatically, and if the line is busy, the FAX/MFC will redial automatically up to three times at 5 minute intervals.

Receiving Faxes

*See
Distinctive
Ringing
pp. 51-52*

Select Answer Mode

Manual—You must answer all calls yourself. If you hear fax tones, press **[Start]** to begin receiving the fax, then hang up. You can use this mode with Distinctive Ringing.

Fax Only—The FAX/MFC automatically answers every call as a fax call. You cannot receive a voice call, but you can dial out and make a voice call.

*See
F/T (Fax/Tel)
Mode Only
p. 50*

F/T—The FAX/MFC automatically answers every call. If the call is a fax, it prints the fax. If the call is not a fax, it signals you with a double ring (ring-ring), different from the phone company ringing, to alert you to pick up the call. If you select this setting, you'll need to set the Ring Delay and F/T Ring Time features (on the following pages). If you have extension phones on the same line as the FAX/MFC, set Ring Delay to 4.

MSG CTR—These FAX/MFCs provide you with a built-in digital message center for fax and voice. When you set the machine to answer calls, it will record up to 15 minutes (MFC 1870MC) or up to 30 minutes (Fax 1570MC and MFC 1970MC) of messages, depending on how much memory is available. For more information about Message Center (MSG CTR) operation, please see Chapter 8 and Chapter 9.



Record Fax/Tel Outgoing Announcement (F/T OGM)

This is the announcement played by your FAX/MFC (not an external TAD) when someone calls and your machine is set to F/T mode. Although callers hear your announcement, they cannot leave a message. To erase the announcement, follow the directions on page 62, “Erasing Outgoing Message”.

- 1 Press **Function**, **8**, **6**. The screen prompts you to choose **F/T OGM** or **MSG CTR OGM**.
- 2 Press **◀** or **▶** to select **F/T OGM**.
- 3 Press **Set**.
- 4 Press **Record**, then pick up the handset to record a message.
- 5 Replace the handset. Your OGM is played.
- 6 Press **Stop** to exit.

Easy Receive

*See
 Operation
 from
 Extension
 Telephone
 p. 50
 and
 For F/T
 (Fax/Tel)
 Mode Only
 p. 50*

When you use this feature, you don't have to press **Start** when you answer a fax call and hear calling beeps. Just hold the handset and wait a few seconds. When you see “RECEIVE” on the fax screen or when you hear “chirps” through the handset of an extension phone connected to another wall jack, just replace the handset, and the FAX/MFC does the rest. Selecting **ON** allows the machine to receive fax calls automatically, even if you lift the handset of an extension phone. Selecting **SEMI** lets the FAX/MFC receive the call only if you've answered it at the FAX/MFC. Selecting **OFF** means you'll have to activate the FAX/MFC yourself, by pressing **Start** or by pressing *** 5 1** if you are not at the FAX/MFC.

In case Easy Receive does not work because of a poor phone line connection, just press **[Start]** or press the Activation Code **[*] [5] [1]**.

- 1 Press **[Function]**, **[7]**, **[6]**.
- 2 Use **[◀]** or **[▶]** to select **ON**, **SEMI**, or **OFF**.
- 3 Press **[Set]** when screen displays your selection.
- 4 Press **[Stop]** to exit.

If you've set the feature to **ON**, but your FAX/MFC doesn't automatically connect a fax call when you lift the extension phone handset, press **[*] [5] [1]**.
At the FAX/MFC, lift the handset and press **[Start]**.

To select or change your Answer Mode

Press **[Mode]** repeatedly until you find the mode you want.

The indicator lights show your current selection.

(• means light off. ☉ means light on.)

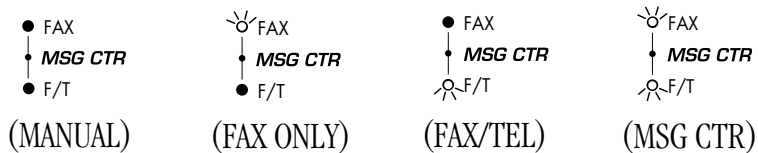

*You must record an outgoing message (OGM) in order to use the Message Center Mode. See Message Center Mode P.59.

Setting Ring Delay

The Ring Delay setting determines the number of times the FAX/MFC rings before it answers. If you have extension phones on the same line as the FAX/MFC, set the Ring Delay to 4.

- 1 Press **[Function]**, **[6]**, **[2]**.
- 2 Press **[◀]** or **[▶]** to select how many times the line rings before the FAX/MFC answers (00 – 04). If you select 00, the line doesn't ring at all.
- 3 Press **[Set]** when the screen displays your selection.
- 4 Press **[Stop]** to exit.

*See
Operation
from
Extension
Telephone
p. 50
and
For F/T
(Fax/Tel)
Mode Only
p. 50*

Setting F/T Ring Time

You must determine how long the FAX/MFC will notify you with its special double ring when you have a voice call. This ringing happens *after* the initial ringing from the phone company. Only the FAX/MFC rings, for 20, 30, 40 or 70 seconds; no other phones on the same line ring the special double ring.

- 1 Press **Function**, **6**, **5**.
- 2 Press **◀** or **▶** to select how long the FAX/MFC will ring to alert you that you have a voice call.
- 3 Press **Set** when the screen displays your selection.

RING TIME:XX SEC

- 4 Press **Stop** to exit.

Now, when a call comes in and the machine is set to F/T Mode, all phones on this line will ring the number of times you selected in Ring Delay.

You can let the FAX/MFC pick up and detect if it's a fax or voice call. If it's a fax call, the machine prints the fax. If it's a voice call, the machine signals you with a double ring for the length of time you selected in F/T Ring Time.



Even if the caller hangs up during the double ringing, the FAX/MFC continues for the set time.

Speaker Volume

You can set the volume of the FAX/MFC speaker phone.

- 1 Press **Function**, **6**, **3**.
- 2 Press **◀** or **▶** to select your volume setting (**OFF**, **LOW**, **MEDIUM**, or **HIGH**).
- 3 Press **Set** when the screen displays your selection.
- 4 Press **Stop** to exit.

Ring Volume

You can select how loudly, or if, the FAX/MFC rings.

- 1 Press **Function**, **6**, **6**.
- 2 Press **◀** or **▶** to select **OFF**, **LOW**, **MEDIUM**, or **HIGH**.
- 3 Press **Set** when the screen displays your selection.
- 4 Press **Stop** to exit.

Even if you select OFF, the ring volume will remain LOW in F/T ringing (double ringing), and LOW in Call Reservation.



Smoothing

When activated, this feature enhances the appearance of incoming faxes by “smoothing” lines. It takes no longer to receive faxes in this setting, which comes set to ON.

You cannot use “smoothing” for outgoing faxes, or for printing lists and reports.

- 1 Press **Function**, **5**, **1**.
- 2 Press **◀** or **▶** to choose **ON** or **OFF**.
- 3 Press **Set**.
- 4 Press **Stop** to exit.

Setting Paper Size

You can use three sizes of paper for printing your faxes—letter, legal, and A4. When you change the kind of paper you have loaded in the FAX/MFC, you will need to change the setting for paper size, so the FAX/MFC will know how to fit the incoming fax on the page. You can also select the level of page reduction to fit the paper in your FAX/MFC.

- 1 Press **Function**, **5**, **6**. The screen displays:

RCD PAPER:LETTER

- 2 Use **◀** or **▶** to select **LETTER**, **LEGAL** or **A4**.
- 3 Press **Set** when the screen displays your selection.
- 4 Use **◀** or **▶** to select **AUTO**, **100%**, **93%**, **87%** or **75%**.
- 5 Press **Set** when the screen displays your selection.
- 6 Press **Stop** to exit.

Printing a Reduced Incoming Document

You can always reduce the size of an incoming fax to a fixed percentage, regardless of the size of the paper (up to legal) in your FAX/MFC. If you choose AUTO, the FAX/MFC chooses the level of reduction for you.

1 Press **[Function]**, **[5]**, **[5]**. The screen displays:

REDUCTION: AUTO

- 2** Use **[◀]** or **[▶]** to select the reduction ratio you want—**AUTO**, **93%**, **87%**, or **75%**. Choose **100%** if you don't want a reduction.
- 3** Press **[Set]** when the screen displays your selection.
- 4** Press **[Stop]** to exit.

Recommended Reductions

If your paper is letter size (8.5" x 11"), and the incoming fax is

letter size, select 93%

A4, select 87%

legal size, select 75%.

If your paper is A4 (8.2" x 11.6"), and the incoming fax is

letter size, select 100%

A4, select 93%.

If your paper is legal size (8.5" x 14"), and the incoming fax is

letter size, select 100%

A4, select 100%

legal size, select 93%.

Telephone & Speaker Phone (Voice) Operation

Making Voice Calls

You can use your FAX/MFC to make voice telephone calls, by dialing manually or by using One Touch or Speed Dial memory. You can use the handset or the Speaker Phone to make and receive calls. The Speaker Phone allows you to operate the phone hands-free, or allows more than one person in the room to participate in a two-way phone conversation. When using the Speaker Phone, make sure to speak clearly and close to the microphone.

Manual Dialing

Manual dialing is simply pressing all of the digits of the Phone number.

- 1 Pick up the handset—**OR**—Press **[Speaker Phone]**.
- 2 When you hear a dial tone, dial the call, using the dial pad.
- 3 You can switch from handset to Speaker Phone by pressing **[Speaker Phone]**, then replacing the handset. You can switch from Speaker Phone to handset by lifting the handset.
- 4 To hang up, replace the handset—**OR**—Press **[Speaker Phone]**.

Answering Calls with the Speaker Phone

When the phone rings, instead of lifting the handset, press **[Speaker Phone]**. Speak clearly, toward the microphone. To end the call, press **[Speaker Phone]**.

If you have a bad telephone line connection, the other party might hear your voice echoed during the call. Hang up and try the call again—**OR**—Pick up the handset.



See
Storing One
Touch Dial
Numbers
pp. 20-21



See
Storing
Speed Dial
Numbers
p. 22

One Touch Dialing

- 1 Pick up the handset—**OR**—Press **Speaker Phone**.
- 2 When you hear a dial tone, press the One Touch key of the location you want to call.

If you try to use a One Touch location with no number stored in it, you hear a warning sound, and the screen displays NOT REGISTERED. The display returns to normal after 2 seconds.

Speed Dialing

- 1 Pick up the handset—**OR**—Press **Speaker Phone**.
- 2 When you hear a dial tone, press **Speed Dial**, then press the two-digit Speed Dial number.
- 3 To hang up, replace the handset—**OR**—Press **Speaker Phone**.

Hold

- 1 Press **Hold** to put a call on Hold.
- 2 You can put down the handset without disconnecting the call.
- 3 Pick up the FAX/MFC handset to release the call from Hold. Picking up an extension handset will not release the call from Hold.

Pause

Press **Redial/Pause** to insert a 3.5 second pause between numbers.

Tone/Pulse

If you have pulse dialing service, but need to send tone signals (for telephone banking, for example), follow the directions below. If you have touch tone service, you do not need this feature to send tone signals.

- 1 Lift the handset.
- 2 Press **#**. Any digits dialed after this send tone signals.
- 3 When you hang up, the FAX/MFC returns to pulse dialing service.

*See
Storing One
Touch Dial
Numbers
pp. 20-21
and
Storing
Speed Dial
Numbers
p. 22*

Searching Telephone Index

You can search for names you have stored in One Touch and Speed Dial memories. Names are stored alphabetically.

- 1 Press **Tel-index**, then enter the first letter of the name.
- 2 Press **◀** or **▶** to search the memory.
- 3 When the screen displays the name you want to call, pick up the handset or press **Speaker Phone**.
- 4 Press **Start** to begin dialing.
- 5 When the call is over, hang up, or press **Speaker Phone** to cancel the call.

Advanced Fax Operation

Sending Faxes

Quick Scan Fax Transmission

You can scan a fax into the FAX/MFC's memory to be sent as soon as the scan is complete. This way, you don't have to wait for the entire fax to be transmitted before you retrieve your original.

If you get a MEMORY FULL message while scanning the first page of a fax, press **[Stop]** to cancel the scan. If you get a MEMORY FULL message while scanning in a subsequent page, you'll have the option to press **[Start]** to transmit the pages scanned so far, or to press **[Stop]** to cancel the Quick Scan operation.

- 1 Insert the document in the feeder.
- 2 Press **[Q.Scan]**. The screen indicates how much memory is available.
- 3 Enter the fax number.
- 4 Press **[Start]** to begin scanning the document into memory. Once the scan is complete, the FAX/MFC dials the call.

Daily Timer

You can use this function to set a time to send a fax every day. The setting stays the same until you change it. Then, when you use Delayed Transmission the time will be displayed automatically.

- 1 Press **[Function]**, **[7]**, **[2]**.
- 2 Use the dial pad to enter the time in 24-hour format (for example, enter 19:45 for 7:45 PM).
- 3 Wait 2 seconds, then press **[Stop]** to exit.

*See
Delayed
Transmission
p. 44
and
Delayed
Polling
p. 55*

*See
Daily Timer
p. 43*

Delayed Transmission

You can use this function to send a fax up to 24 hours later. If you have set a time in Daily Timer, the time will be displayed in Step 4.

- 1 Insert the document in the feeder.
- 2 You can press **Q.Scan** to use memory transmission, or you can send your fax normally.
- 3 Press **Function**, **1**, **1**.
- 4 Enter the time you want the fax to be sent, in 24-hour format (for example, enter 19:45 for 7:45 PM).
- 5 Wait 2 seconds (the screen will display 1. TIMER), then press **Stop**. The screen prompts you to enter the fax number.



- 6 Enter the fax number, and press **Start**. The FAX/MFC will wait until the time you have entered to send the fax.

Interrupting Timer and Poll Waiting

You can send a fax (or make a copy) now, even if you have the FAX/MFC set to send a fax later, or if you have it set for Poll Waiting. However, you cannot use automatic redial or the function mode.

- 1 Press **Function**, **0**.
- 2 Wait 2 seconds, then remove the documents that are waiting in the feeder.



- 3 Place the document you want to send now in the feeder.
- 4 Enter the number for the fax you want to send now.
- 5 Press **Start**.
- 6 After the transmission is finished, return the first document to the feeder.
- 7 Press **Function**, **0** to restore the Delayed Transmission timer.

Canceling a Delayed Fax

You can cancel tasks you've scheduled using the timer.

- 1 Press **Function**, **2**. Any waiting jobs appear on the display. If no jobs are waiting, the screen displays NO JOB WAITING.

2. CANCEL JOB

- 2 If you have more than two jobs waiting, use **◀** or **▶** to select the job you want to cancel. Press **Set** when the screen displays your selection.

—OR—

If you have only one job waiting, go to step 3.

- 3 Press **1** to cancel—OR—Press **2** to exit without canceling.
- 4 Press **Stop** to exit.

Broadcasting

Using the numbers you have stored in group dialing, One Touch and Speed Dial memory, you can “broadcast” faxes automatically to many different locations in a few simple steps. (Model MFC 1870MC offers up to 59 locations; FAX 1570MC and MFC 1970MC offer up to 123 locations.)

After the Broadcast is completed, a Broadcast Report will be printed automatically to let you know the results.

- 1 Insert the document in the feeder.
- 2 Press **Q.Scan**. The screen displays how much memory is available.
- 3 Enter the One Touch and Speed Dial numbers (one after the other) or a Group number you have stored.
- 4 Press **Start**. The FAX/MFC stores the document in memory, then transmits it to all the numbers you entered. If the line is busy, the FAX/MFC will retry.

Press **Stop** during transmission to cancel the current fax broadcast.

Overseas Mode

If you have difficulty sending a fax overseas, use the Overseas Mode.

After you send a fax using this feature, the feature turns itself off.

- 1 Insert document.
- 2 Press **Function**, **1**, **6**.

6. OVERSEAS MODE

- 3 Press **◀** or **▶** to select **ON** (or **OFF**).
- 4 Press **Set** when the screen displays your selection.
- 5 Press **Stop** to exit.
- 6 Follow basic procedures to send a fax.

*See
Setting Up
Groups for
Broadcasting
pp. 23-24*



*See
Sending
Faxes
pp. 31-33*

Error Re-Transmission

Sometimes there is noise or interference on the phone line, which makes it difficult for your FAX/MFC to transmit a fax. You can set the FAX/MFC to automatically retransmit (RE-TX).

- 1 Press **Function**, **5**, **4**.
- 2 Press **◀** or **▶** to select **ON** (or **OFF**).
- 3 Press **Set** when the screen displays your selection.
- 4 Press **Stop** to exit.

Composing Electronic Cover Page

*See
One Touch
and
Speed Dial
pp. 20-22*

Your cover page includes the name/number stored in the One Touch or Speed Dial memory. If you're dialing manually, the name is left blank.

The cover page indicates the fax is from your Station ID, and the number of pages you're sending. If you have COVERPG ON/OFF (function 5-3) ON, the number of pages remains blank.

You can select a comment to include on your cover page.

*See
Setting
Station ID
p. 18*

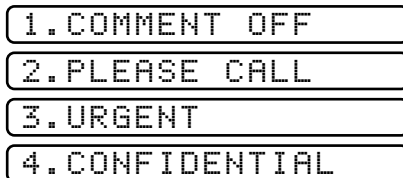

Instead of using one of the comments above, you can enter up to two customized messages, each 27 characters long. Use the chart on page 19 to help enter characters.

- 1 Press **Function**, **7**, **7**.
- 2 Use **◀** or **▶** to choose position 5 or 6 for your customized comment.
- 3 Press **Set**.
- 4 Use the dial pad to enter your customized comment.
- 5 Press **Set**.
- 6 Press **Stop** to exit.

Always Send Cover Page

Make sure station ID is set up (p. 18). This feature does not work without Station ID set up.

You can set the FAX/MFC to send a cover page whenever you send a fax. The number of pages in your fax is not included when you use this setting.

1 Press **Function**, **5**, **3**.

2 Press **◀** or **▶** to select.

COVERPAGE: OFF

COVERPAGE: ON

3 Press **Set** when the screen displays your selection. (If you select **ON**, a coverpage is always sent when you send a fax.)

4 If you selected **ON**, you must select a comment. Use **◀** or **▶** to view possible selections. (You can select a custom comment, instead.)

1. COMMENT OFF

2. PLEASE CALL

3. URGENT

4. CONFIDENTIAL

5. (USER DEFINED)

6. (USER DEFINED)

5 Press **Set** when the screen displays your selection.

6 Press **Stop** to exit. Now, whenever you insert a document in the feeder, the screen displays COVERPAGE ON before prompting you to dial.

Cover Page (Temporary Setting)

Make sure station ID is set up (p. 18). This feature does not work without Station ID set up.

You can set the fax to send a cover page with a particular document. This cover page will include the number of pages in your document.

1 Insert the document in the feeder.

2 Press **Function**, **1**, **7**.

3 Press **◀** or **▶** to select **ON** (or **OFF**).

4 Press **Set** when the screen displays your selection.

- 5 Press  or  to view comment selections.

1. COMMENT OFF





2. PLEASE CALL

3. URGENT

4. CONFIDENTIAL

5. <USER DEFINED>

6. <USER DEFINED>

- 6 Press  when the screen displays your selection.
- 7 Enter two digits to indicate the number of pages you are sending (enter   to leave number of pages blank).
- 8 Wait 2 seconds, then press .
- 9 Enter the fax number you're calling.
- 10 Press .



Using a Printed Cover Page

- 1 Press , , .
- 2 Press . Your FAX/MFC prints a copy of your cover page.

Call Reservation



You can send a fax and let the other party know that you want to have a conversation after the fax transmission is complete. The other fax machine will ring as if it were receiving a telephone call; if the other party picks up the handset, your FAX/MFC will ring. Lift the handset to speak.

If you set Call Reservation and Call Back message to ON, your FAX/MFC leaves a message if the other party does not answer.

- 1 Insert the document in the feeder.
- 2 Press , , . The screen displays the current setting for Call Reservation.

CALL RESERVE: ON

CALL RESERVE: OFF

- 3 Press  or  to select **ON** (or **OFF**).

- 4 If you set Call Reservation to ON, press **Set** when the screen displays your selection. The screen displays the current setting for Call Back Message.

CALL BACK: OFF

CALL BACK: ON

- 5 Press **Left Arrow** or **Right Arrow** to select **ON** (or **OFF**).
- 6 Press **Set** when the screen displays your selection.
- 7 Press **Stop**. The screen prompts you to enter the fax number you want to call.
- 8 Enter the fax number, and press **Start**.
- 9 If you've set Call Reservation to **ON**, pick up your handset if the FAX/MFC rings.



You cannot use auto redial with Call Reservation. You cannot use Call Reservation with Delayed Transmission or with Polling. You must register your Station ID to set Call Back Message to **ON**.

Print Call Back Message

- 1 Press **Function**, **3**, **5**.
- 2 Press **Start**.

Next-Fax Reservation

Even if your fax is receiving another fax, you can set your FAX/MFC to send your fax next. This way, you don't have to wait for it to finish sending or receiving the other fax. You can dial this fax call manually, or by using Redial, One Touch, Speed Dial, or Chain dialing. (When you use One Touch and Speed Dial, only the memory location—not the name of the person you're calling—is displayed.)

- 1 Insert the documents in the feeder. If necessary, press **Resolution** to adjust resolution.
- 2 Enter the fax number.
- 3 Press **Start**.
- 4 Press **Set**. The screen displays:

NEXT-FAX RESERVD

- 5 To cancel the reservation, remove the documents and press **Stop**.

You can't use this feature if there is a document waiting in the feeder (possibly for Delayed Transmission or Poll Waiting), or when the timer has been interrupted.



Multiple Resolution Transmission

Use this feature to select separate resolution settings for each page of the fax you're sending. This could be useful if you're sending a fax with photos and letters, or some pages with small print and others with normal print. Resolution settings return to STANDARD after the fax is sent.

- 1 Insert documents in feeder, then press **Function**, **1**, **5**.
- 2 Use **◀** or **▶** to select resolution for page 1, then press **Set**.
- 3 Repeat Step 2 for subsequent pages. Press **Stop** when you're finished.
- 4 Enter the fax number you're calling, and press **Start**.

Receiving Faxes

*See
F/T Ring
Time
p. 36*

Operation from Extension Telephone

If you answer a fax call on an extension phone, you can make your FAX/MFC take over by using the Activation Code. When you press the Activation Code *** 5 1**, the FAX/MFC starts to receive a fax.

If the FAX/MFC answers a voice call and double-rings for you to take over, use the Deactivation Code **# 5 1** to take the call at an extension phone.

*See
Easy Receive
pp. 34-35*

If you answer a call, and no one is on the line, assume you're receiving a fax. At the FAX/MFC phone, press **Start**, then hang up. At an extension phone, press *** 5 1**, wait for fax receiving tones (chirps), then hang up. (Your caller will have to press **Start** to send the fax.)

For F/T (Fax/Tel) Mode Only

When the FAX/MFC is in F/T mode, it will use the F/T Ring Time (double ringing) to alert you to a voice call. If you're at the FAX/MFC, you can lift the handset to answer.

If you're at an extension phone, you'll need to lift the handset during the F/T Ring Time and press **# 5 1** between the double rings. If no one is on the line, or if someone wants to send you a fax, send the call back to the FAX/MFC by pressing *** 5 1**.

Changing Remote Codes



Remote Codes might not work with some telephone systems. The preset Activation Code is ***51**. The preset Deactivation Code is **#51**.

If you are always disconnected when accessing your TAD remotely, try changing the Activation Code from ***51** to **##** and the Deactivation Code from **#51** to **999**.

To change Remote Codes

- 1 Press **Function**, **7**, **5**.
- 2 Press **◀** or **▶** to select **ON** (or **OFF**).

REMOTE ACT.: ON
- 3 Press **Set** when the screen displays the setting you want.
- 4 If you want to, enter a new Remote Activation Code, then wait 2 seconds.

ACT. CODE: *51
- 5 If you want to, enter a new Remote Deactivation Code, then wait 2 seconds.

DEACT. CODE: #51
- 6 Press **Stop** to exit.

Distinctive Ringing

This FAX/MFC feature lets you use the Distinctive Ringing subscriber service offered by some telephone companies, which allows you to have several telephone numbers on one phone line. Each phone number has its own Distinctive Ringing pattern, so you know which phone number is ringing. This is one way you can have a separate phone number for your FAX/MFC.

Your FAX/MFC has a Distinctive Ringing function, allowing you to dedicate one phone number just for receiving faxes. You'll need to follow the directions below to "register" the Distinctive Ringing pattern, so your FAX/MFC can recognize its incoming calls. You will need another person standing by on another line to help you with Step 6 of this registration.



You can change or cancel the Distinctive Ringing pattern at any time. You can switch it off temporarily, then turn it back on. When you get a new fax number, make sure you reset this function.



You can register only one Distinctive Ringing pattern with the FAX/MFC. Some ringing patterns cannot be registered.

- The FAX/MFC will answer only calls to its registered number.
- To have your TAD answer only the main number, the FAX/MFC must be in Manual Mode.
- In F/T Mode or FAX ONLY, the FAX/MFC will answer all numbers on the phone line.

Registering the Distinctive Ringing phone number

- 1 Disconnect the FAX/MFC from any TAD or telephone company voice mail.
- 2 **Have someone ready to call the Distinctive Ringing number you're assigning to the FAX/MFC.**
- 3 Press **[Function]**, **[6]**, **[7]**.
- 4 Press **[◀]** or **[▶]** to select the SET Mode.
- 5 Press **[Set]**.
- 6 Press **[Stop]**. The screen displays:

D/R SET MODE

Now, another person must call your fax number.

If you want to exit this programming, press **[Stop]. Settings remain unchanged.**

- 7 When the FAX/MFC rings, listen for the ring pattern, and make sure it's the one you want for the FAX/MFC.

If it is, wait until the screen displays:

PICK UP TO SET

- 8 Lift the FAX/MFC handset and press **[Start]**. The screen displays REGISTERED. (If the incorrect distinctive ringing number was called, press **[Stop]** to cancel.)

- 9 Hang up.

Your FAX/MFC must be in MANUAL mode before someone calls.

Once you've registered the Distinctive Ringing number in your FAX/MFC, you can turn this feature **ON** (or **OFF**). To change the setting, follow steps 1 to 4 above, selecting **ON** or **OFF**.





*See
Printing
Reports and
Lists
pp. 83-84*

Caller ID

The Caller ID feature of this FAX/MFC lets you use the Caller ID subscriber service offered by many local phone companies. This service provides you, by means of the screen display, the name or telephone number of your caller as the line rings.

After two rings, the screen displays the telephone number of your caller (or name, if available). Once you pick up the handset, the Caller ID information disappears from the screen, but the call information remains stored in the Caller ID memory.

- You will see the first 16 characters of the number or name.
- OUT-OF-AREA display means call originates outside your Caller ID service area.
- PRIVATE CALL display means the caller has intentionally blocked transmission of information.
- CALL PICKUP display remains on screen when no Caller ID information was transmitted.

If both the name and number are received, the screen displays only the name. You can print a list of Caller ID information received by your FAX/MFC.

Caller ID service varies with different carriers. Call your local phone company to determine what kind of service is available in your area.

Caller ID memory stores information for up to thirty calls; when the thirty-first call comes in, information about the first call is erased. You can scroll through Caller ID information to review those calls made to your FAX/MFC.

- 1** Press **[Function]**, **[6]**, **[8]**.
- 2** Press **[Set]**. The screen displays the number of the most recent call, and the call information.
- 3** Press **[◀]** or **[▶]** to scroll through the Caller ID memory.
- 4** Press **[Stop]** to exit.

Clearing Caller ID Information

Press **Clear** when the screen displays the Caller ID information you want to erase.

Polling



Polling is the process of retrieving faxes from another fax machine. You can use your FAX/MFC to “poll” other machines, or you can have someone poll your machine.

All parties involved in polling need to set up their fax machines to accommodate polling. When someone polls your FAX/MFC to receive a fax, they pay for the call; if you poll someone’s fax machine to receive a fax, you pay for the call.



Some fax machines do not respond to the polling function.

Setup to Poll Another Fax

- 1- *Make sure no document is in the feeder.*
- 2- Press **Function**, **1**, **2**.
- 3- Wait 2 seconds.
- 4- The screen displays:

POLLING: OFF

- 5- Press **◀** or **▶** to choose **ON**.
- 6- Press **Set**.
- 7- Press **Stop**.

The screen prompts you to enter the fax number you want to poll, and then to press **Start**.

ENTER FAX NO.

PRESS START KEY

- 8- Enter the fax number you are polling.
- 9- Press **Start**.

Setup to Be Polled (Poll Waiting)

- 1 Place document in feeder.
- 2 Press **Function**, **1**, **2**.
- 3 Wait 2 seconds.
- 4 The screen displays:

POLLING: OFF
- 5 Press **◀** or **▶** to choose **ON**.
- 6 Press **Set**.
- 7 Press **Stop**. The screen prompts you to press **Start**.
- 8 Press **Start** and wait for the fax to be polled.

Before pressing **Start**, press **Q.Scan** so that you can store your Poll Waiting document in the memory. If you use **Q.Scan** to place the Poll Waiting documents into the memory, they will not be erased automatically after they are polled. To erase them you must use the Cancel Job function. (See page 45.)

Sequential Polling

In Sequential Polling, the reverse of Broadcasting, your FAX/MFC requests documents from several fax units, in a single operation.

A Sequential Polling Report prints on completion.

1 Make sure no document is in the feeder.

2 Press **Function**, **1**, **2**.

3 Wait 2 seconds.

The screen displays:

POLLING: OFF

4 Press **◀** or **▶** to choose **ON**.

5 Press **Set**.

6 Then press **Stop**. The screen prompts you to enter the fax number you are polling.

ENTER FAX NO.
PRESS START KEY

7 Specify the destination of fax machines, that you wish to poll by using One Touch, Speed Dial, or Group keys.

8 Press **Start**. Your FAX/MFC polls each number or group member in turn for a document.

See
p. 32



Copy Functions

Your FAX/MFC cannot scan anything closer than one-eighth inch from the edge of the paper. For photographs, set the resolution to PHOTO.

- 1 Place document face down in the feeder.
- 2 Press **Copy**. (You can press **Copy** again for faster response, otherwise copying begins in about 5 seconds.)

Do not pull on the paper while copying is in progress.

Multiple Copies

You can make multiple copies using your FAX/MFC, and you can choose whether the copies will be **STACKED** (all copies of page 1, then all copies of page 2, etc.) or **SORTED** (collated).

- 1 Place the document face down in the feeder.
- 2 If you want copies “stacked”, press **Copy**.

—OR—

If you want copies “sorted” (collated), press **Sort**.

- 3 Enter the number (1-99) of copies you want.
- 4 Press **Copy**.

If you selected **Sort** and get a MEMORY FULL message, press **Copy** to copy the portion that is in memory, or press **Stop** to cancel.



Reducing and Enlarging Copies

When making copies, you can reduce or enlarge the size of the printed image. To reduce to the size of your selected paper automatically, select **AUTO**. To select a reduction ratio, choose **93%**, **87%**, **75%**, or **50%**. To enlarge a document, select **150%**, **125%** or **120%**. To print a document at its original size, select **100%**.

- 1 Insert the document face down in the feeder.
- 2 Press **Enlarge/Reduce**.
- 3 Use **Left Arrow** or **Right Arrow** to choose a reduction ratio setting.
- 4 Press **Copy**—OR—**Sort**, if you want sorted copies.
- 5 Enter the number (1-99) of copies you want. For example, press **9** for nine copies.
- 6 Press **Copy**.

CHAPTER EIGHT

Message Center

Message Center Mode

*See
Recording
Message
Center
Outgoing
Message
p. 61*

Message Center Mode allows you to store incoming fax and voice messages in a flexible memory. If you have Model MFC 1870MC the memory stores 15 minutes of voice messages or up to 20 pages of fax memory, and for Models FAX 1570MC and MFC 1970MC, the memory stores 30 minutes of voice messages, or up to 50 pages of fax memory. Any voice or fax message can be retrieved remotely. Memory is shared between fax and voice messages, which are stored on a “first-come, first-served” basis.

You must record an outgoing message in order to use the Message Center Mode.

Flexible Memory Settings

Message Center Mode offers you six flexible memory settings, so that you can decide which kinds of messages you want to receive.

- 1. FAX:ON VOICE:ON** Both voice and fax messages are stored. You can use the Fax Forwarding or Paging features and retrieve voice and fax messages remotely.
- 2. FAX:ON VOICE:EXT** You need an external answering machine connected to the EXT. jack for this setting. Fax messages are stored in the message center memory, but voice messages are stored in your external answering machine. Retrieve messages from the external answering machine. You cannot use the Paging feature for voice messages with this setting.
- 3. FAX:ON VOICE:OFF** All memory is used to store fax messages—no voice messages will be stored.
- 4. FAX:OFF VOICE:ON** All memory is used to store voice messages—no fax messages will be stored. Incoming faxes will print on paper. You can use the Paging feature, and retrieve voice messages remotely.
- 5. FAX:OFF VOICE:EXT** You need an external answering machine connected to the EXT. jack for this setting. Incoming faxes are not stored in memory, but will print on paper. Voice messages are stored in the external answering machine.
- 6. FAX:OFF VOICE:OFF** Incoming faxes are not stored in memory, but will print on paper. Voice calls are not stored in memory.

Setting Up Message Center

You must set up Message Center in the following order :

- | | |
|------------------|---|
| <i>See p. 61</i> | 1 Turn Message Storage ON . |
| <i>See p. 61</i> | 2 Record Message Center Outgoing Message (MSG CTR OGM). |
| <i>See p. 81</i> | 3 Turn Message Center Pro OFF . |
| <i>See p. 62</i> | 4 Activate Message Center Mode. |

Setting Message Storage

Select the setting from the descriptions in Flexible Memory Settings.

See
Flexible
Memory
Settings
p. 60

- 1 Press **Function**, **8**, **1**. The screen prompts you to choose a **FAX** setting.



- 2 Press **Left Arrow** or **Right Arrow** to select **ON** (or **OFF**).

- 3 Press **Set**. The screen prompts you to choose a **VOICE** setting.



- 4 Press **Left Arrow** or **Right Arrow** to select **ON**, **OFF** or **EXT**.

- 5 Press **Set** when the screen displays your selection.

- 6 Press **Stop** to exit.

Recording Message Center Outgoing Message



Recording the Message Center Outgoing Message (**MSG CTR OGM**) is the second step you need to follow before you can turn on the Message Center. Make sure your OGM is less than 20 seconds long.

- 1 Press **Function**, **8**, **6**. The screen prompts you to choose an OGM.

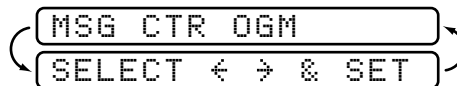

- 2 Press **Left Arrow** or **Right Arrow** to reach:

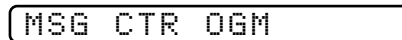

This is the only setting you can select if you want to turn the Message Center on.

- 3 Press **Set**.

- 4 Press **Record**, then pick up the handset to record a message.

For example: *Hello. We are unable to take your call at this time. Please leave a message after the signal. If you wish to send a fax, please press * 5 1 and Start.*

- 5 Replace the handset. The Message Center plays your OGM.

- 6 Press **Stop** to exit.

See
Record
Fax/Tel
Announcement
p. 34

Listening to Outgoing Message (OGM)

- 1 Press **Function**, **8**, **6**.
- 2 Press **◀** or **▶** to select **MSG CTR OGM** or **F/T OGM**.
- 3 Press **Set** when the screen displays your selection.
- 4 Press **Play** to hear the OGM. Adjust the volume by pressing Speaker Volume **Low** or **High**.
- 5 Press **Stop** to exit.

Erasing Outgoing Message (OGM)

- 1 Press **Function**, **8**, **6**.
- 2 Press **◀** or **▶** to select **MSG CTR OGM** or **F/T OGM**.
- 3 Press **Set** when the screen displays your selection.
- 4 Press **Erase**.
- 5 Press **1** to erase the OGM—**OR**—Press **2** to exit without erasing.
- 6 Press **Stop** to exit.

Activating Message Center Mode

Press **Mode** until the FAX and F/T lights are on.

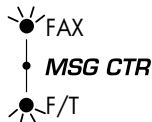

Message Indicators

The Voice and/or FAX indicator lights flash when you have voice messages and/or faxes waiting for your review. Once you listen to the message or print the fax, the light stops flashing.



The LCD screen displays the total number of voice (including memos) and/or fax messages stored in Message Center memory.

VOICE:03 FAX:02

Playing Voice Messages and Memos

Follow the steps below to listen to voice messages and memos.

- 1 Press **Play**. Adjust volume by pressing Speaker Volume **Low** or **High**.

All messages and memos are played in the order they were recorded. The display shows the number of the current message, and the total number of messages.

If Caller ID information was received, the FAX/MFC beeps during the message and displays the Caller ID information for one second.

During playback, the screen displays the time and date the message was recorded.

- 2 Use **◀** at the end of the message to repeat a message. Use **▶** to skip to the next message. You can press **◀** and **▶** repeatedly until you reach the message you want to play.
- 3 Press **Stop** to exit.

Printing a Fax Message

Once you print a new fax message stored in memory, it is erased from the memory automatically.

- 1 Press **Play**. After two seconds, the FAX/MFC begins to play voice messages.
- 2 After playing voice messages, the display asks if you want to print fax messages that are in the memory. There is no display message if there are no faxes.

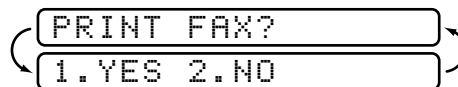

- 3 To print the faxes in memory, press **1**

—OR—

Press **2** to exit without printing.

Backup Printing Option

When you choose **FAX: ON** in the Message Center mode, all incoming fax messages are stored in the available memory for retrieval. To print a backup copy automatically, turn this option on.

- 1 Press **Function**, **8**, **2**. The screen prompts you to select a setting.

- 2 Press **Left Arrow** or **Right Arrow** to display **ON** (or **OFF**).
- 3 Press **Set** when the screen displays your selected setting.
- 4 Press **Stop** to exit.

Erasing Messages

If you choose to erase all fax messages, the FAX/MFC will print any previously unprinted fax messages before erasing them from memory. Fax messages cannot be erased individually.

You can erase voice messages and memos individually, or all at once.

To erase voice messages individually

- 1 Press **Play**. After two seconds, the FAX/MFC beeps and begins message playback. Each message is preceded by one long beep, and followed by two short beeps.
- 2 To erase a specific message, press **Erase** immediately after the two short beeps, or while the message is playing. The screen prompts:

- 3 Press **1** to erase the message

—OR—

- Press **2** to cancel.

To erase messages all at once

- 1 Press **Erase**. The screen prompts you to choose what the kind of messages you want to erase.

```

ERASE ALL VOICE?
SELECT ← → & SET
  
```

- 2 Press **Left Arrow** or **Right Arrow** to select erasing all voice messages (**VOICE**), all document messages (**FAX**), or all messages—both voice and fax—(**MSG**).
- 3 Press **Set**.
- 4 Press **1** to erase—**OR**—Press **2** to cancel.

Setting Maximum Time for Incoming Messages

Your FAX/MFC comes set to receive voice and fax messages up to 30 seconds long. You can change this setting to any length from 20 seconds to 60 seconds, in 5-second increments. This setting also applies to the Personal Mailbox ICM and Memo.

- 1 Press **Function**, **8**, **5**. The screen prompts you to select a maximum time.

```

MESSAGE 30 SEC
SELECT ← → & SET
  
```

- 2 Press **Left Arrow** or **Right Arrow** to select the maximum time setting for incoming messages.
- 3 Press **Set** when the screen displays your setting.
- 4 Press **Stop** to exit.

Setting Toll Saver

See
Ring Delay
p. 35



When you set the toll saver feature, the FAX/MFC answers after 4 rings if you *don't* have messages, and after 2 rings if you *do* have messages. This way, when you call your FAX/MFC, if it rings 3 times, you know you have no messages, and can hang up, avoiding any toll charge.

When Toll Saver is **ON**, it overrides your Ring Delay setting. Toll Saver must be off for the FAX/MFC to operate using your Ring Delay setting.

- 1 Press **Function**, **8**, **7**.
- 2 Press **Left Arrow** or **Right Arrow** to select **ON** (or **OFF**).
- 3 Press **Set** when the screen displays your selection.
- 4 Press **Stop** to exit.

ICM Recording Monitor

This feature lets you adjust the speaker volume for voice messages you monitor as they come in. You can select **LOW**, **MEDIUM**, or **HIGH**, or you can turn the monitor **OFF** so you will not hear messages as they come in.

- 1 Press **Function**, **6**, **4**.
- 2 Use **◀** or **▶** to select **LOW**, **MEDIUM**, **HIGH**, or **OFF**.
- 3 Press **Set** when the screen displays your selection.
- 4 Press **Stop** to exit.

Recording a Memo

A memo is stored and played as a voice message.

- 1 Press **Record**.
- 2 When the display prompts you to pick up the handset, speak into the handset to record your memo. Your recording can be as long as the Incoming Message Maximum Time. (**Function**, **8**, **5**)
- 3 Press **Stop** or replace the handset when you're finished.

Recording a Conversation

You can record a telephone conversation by pressing **Record** during the conversation. Your recording can be as long as the Incoming Message Maximum Time. You and the other party will hear a beep every 15 seconds while recording. You cannot record a conversation using the Speaker Phone.

Press **Stop** to exit.



Paging/Fax Forwarding

When Paging is set to **ON**, your FAX/MFC dials the pager number you've programmed, and dials your Personal Identification Number (PIN) when connected, to activate your pager and let you know you have a fax or voice message in the Message Center memory.

When Fax Forwarding is set to **ON**, your FAX/MFC dials the fax machine phone number you've programmed, and forwards any faxes you've received.

You cannot use Paging and Fax Forwarding at the same time.

Programming Paging Number

- 1 Press **Function**, **8**, **3**.
- 2 Press **◀** or **▶** until the screen displays:

PAGING

- 3 Press **Set**. The screen prompts you to enter your pager number.

PAG#: _____
ENTER & SET

- 4 Enter your pager phone number (up to 20 digits) followed by **# #**. Do not include the area code if it is the same as that of your FAX/MFC. *For example*, **1 8 0 0 5 5 5 1 2 3 4 # #**.
- 5 Press **Set**.
- 6 If your pager requires a PIN, enter the PIN, press **# #**, press **Redial/Pause**, enter your FAX/MFC telephone number, then press **# #**. *For example*, **1 2 3 4 5 # # Redial/Pause 1 8 0 0 5 2 1 2 8 4 6 # #**.

—OR—

If you do not need a PIN, press **Redial/Pause**, enter the telephone number of your FAX/MFC, then press **# #**. *For example*, **Redial/Pause 1 8 0 0 5 2 1 2 8 4 6 # #**.

- 7 Press **Set**.
- 8 Press **Stop** to exit.

You cannot change a Paging number or PIN remotely.



Programming a Fax Forwarding Number

- 1 Press **Function**, **8**, **3**.
- 2 Press **◀** or **▶** until the screen displays:

FAX FORWARD

- 3 Press **Set**. The screen prompts you to enter the number of the fax machine where faxes will be forwarded.

FWD#: _____
ENTER & SET

- 4 Enter the forwarding number (up to 20 digits).
- 5 Press **Set**.
- 6 Press **Stop** to exit.

You can change a Fax Forwarding number remotely (See page 69).



Remote Retrieval

You can call your FAX/MFC from any touch tone phone (or remote Group 3 fax machine) and use a Remote Access Code and other button presses to retrieve voice (and fax) messages. You can also program and change some settings for your Message Center.

Using Remote Access Code

- 1 Dial your FAX/MFC phone number from a touch tone phone.
- 2 When your FAX/MFC answers and beeps, immediately enter your Remote Access Code.
- 3 The FAX/MFC signals the kinds of messages received:
 - 1 long beep — **Fax message(s)**
 - 2 long beeps — **Voice message(s)**
 - 3 long beeps — **Fax and Voice message(s)**
 - No beeps — **No messages.**
- 4 The FAX/MFC then prompts you with two short beeps to enter a command. If you wait longer than 30 seconds to enter a command, the machine hangs up. If you enter an invalid command, the machine beeps three times.
- 5 Press **[9] [0]** to reset the FAX/MFC when you finish.
- 6 Hang up.

If your FAX/MFC is set to MANUAL mode, you can access the Message Center by waiting about 2 minutes, then entering the Remote Access Code within 30 seconds.



Changing Remote Access Code

Enter your Remote Access Code when the FAX/MFC picks up your call, so you can access features remotely. The access code is preset to 159✳, but you can change this.

- 1 Press **[Function], [8], [4]**.
- 2 Enter a three-digit number from 000 to 999, then **[✳]**. You must end the Remote Access Code with **[✳]**. Do not use the same digits that appear in your Remote Activation or Deactivation Codes (see pp. 50-51), or Personal Mailbox Codes.
- 3 Wait 2 seconds.
- 4 Press **[Stop]** to exit.

Remote Control Commands

Follow the commands below to access features remotely. When you call your FAX/MFC and enter your Remote Access Code (The factory setting is 159*), the system will signal you with two short beeps to enter a remote control command.

Remote control commands		Detail Operation
91 Playing voice messages	1 ◀ (Skip back)	After one long beep, the FAX/MFC plays ICM and Memo. Press [1] while listening to an ICM or Memo message to play it again. If you press [1] before a message, you will hear the previous message.
	2 ▶ (Skip next)	While playing ICM or Memo you can skip to next message.
	9 STOP Playing	Stop playing the ICM or Memo.
	92 Record Memo	
93 Erase all ICM & Memo		If you hear one long beep, the erase is accepted. If you hear three short beeps, you cannot erase because all voice messages have not been played, or there is no voice message to erase. *This code erases all recorded messages, not one at a time.
94 Play and Record OGM in memory		
1 Play	1 MSG CTR OGM	The FAX/MFC plays the selected OGM. You can stop playing OGMs by pressing [9].
	2 F/T OGM	
2 Record	1 MSG CTR OGM	After one long beep, you can record the selected OGM. You will hear the message played once. You can stop recording the message by pressing [9].
	2 F/T OGM	
95 Changing Fax Forwarding/Paging setting		If you hear one long beep, the change is accepted. If you hear three short beeps, you cannot change it because the conditions have not been met (Example: registering paging number). You can register your fax forwarding number by using 4. FAX FWD NO (See page 71). Once you have registered the number, the FAX/MFC will turn automatically to "FAXFWD:ON" mode. Then retrieve a Memory Status List by entering [9] [6] [1] (See page 70) to make sure the Fax Forwarding number you registered is correct in the List.
1 OFF		
2 Fax Forwarding		
3 Paging		
4 FAX FWD NO.		
96 Retrieve Fax		
1 Memory Status List		Enter the number of a remote fax machine to receive a report or stored fax messages.
2 Retrieve all FAX		
3 Erase FAX in the memory		If you hear one long beep, you can erase the fax message from the memory.
97 Check the receiving status		You can check whether your FAX/MFC has received any FAX or VOICE messages. If yes, you will hear one long beep. If no, you will hear three short beeps.
1 FAX		
2 VOICE		
98 Change Answer Mode		If you hear one long beep, you can change the answer mode. If you hear three short beeps, you cannot change it. (Example: There is no MSG CTR OGM when you want to change to MSG CTR mode.)
1 MSG CTR		
2 F/T		
3 FAX		
90 Exit		After a long beep, you can exit remote control.

Retrieving Memory Status List

You can retrieve the Memory Status List from a remote fax machine to see if you have any fax messages.

- 1 Dial your FAX/MFC's number.
- 2 When you hear the beep, immediately enter your Remote Access Code (The factory setting is **1 5 9 ***).
- 3 When you hear two short beeps, use the dial pad to press **9 6 1**.
- 4 Using the dial pad, enter the number (up to 20 digits) of the remote fax machine where you want the Memory Status List forwarded, and then press **# #**.
You cannot use ***** and **#** as dial numbers. However, if you want to store a pause, press **#**.
- 5 After you hear your FAX/MFC beep, hang up and wait.
Your FAX/MFC calls the remote fax machine. The remote fax machine prints the Memory Status List.

Retrieving Fax Messages

- 1 Dial your FAX/MFC's number.
- 2 When you hear the beep, immediately enter your Remote Access Code (The factory setting is **1 5 9 ***).
- 3 As soon as you hear two short beeps, use the dial pad to press **9 6 2**.
- 4 Using the dial pad, enter the number (up to 20 digits) of the remote fax machine where you want your fax messages forwarded, and then press **# #**.
You cannot use ***** and **#** as dial numbers. However, if you want to store a pause, press **#**.
- 5 After you hear your FAX/MFC beep, hang up and wait.
Your FAX/MFC calls the remote fax machine. The remote fax machine prints your fax messages.

Changing Fax Forwarding Number

You can change the default setting of your fax forwarding number from a remote fax machine.

- 1** Dial your FAX/MFC number.
- 2** When you hear the beep, immediately enter your Remote Access Code (The factory setting is **1 5 9 ***).
- 3** When you hear two short beeps, use the dial pad to press **9 5 4**.
- 4** Enter the new number of the remote fax machine where you want your fax messages forwarded, and then press **# #**.
You cannot use ***** and **#** as dial numbers. However, if you want to store a pause, press **#**.
- 5** To retrieve the Memory Status List, when you hear two short beeps, use the dial pad to press **9 6 1**.
- 6** Use the dial pad to enter the number of the remote fax machine (up to 20 digits), and then press **# #**.
- 7** After you hear your FAX/MFC beep, hang up and wait.
Your FAX/MFC calls the remote fax machine. The remote fax machine prints the Memory Status List showing the new forwarding number.
- 8** Check the forwarding number.
If the forwarding number is incorrect, return to Step 1 to reset it.

Message Center Pro

Message Center Pro

Message Center Pro works as an additional enhancement of Message Center and provides you with Personal Mailbox and Voice-on-Demand. Up to five Personal Mailboxes are available. Voice-on-Demand stores voice information messages for someone calling you. These memory boxes allow you to store voice messages that provide callers with more information automatically and effectively, so you don't have to answer the call yourself.

Start with a Plan

Before you can record your outgoing messages (OGMs), you need a plan. Decide what you will store in each Voice Information memory box such as directions to your home or business, and the number you will give it. Choose who will have a personal mailbox. Tell each person with a personal mailbox to prepare to record an OGM and choose a four-digit password.

Prepare one 2nd Level OGM that identifies the type of information in each Voice Information memory box number and another 2nd Level OGM that identifies the name and box number of each person with a Personal Mailbox.

Finally, prepare a 1st Level OGM that identifies your company (or family) and directs callers to either Voice-on-Demand (Voice Information) or Personal Mailboxes. Also explain they can just leave a general voice message or send a general fax after the beep.

Setting Up Message Center Pro

You must set up Message Center Pro in the following order: However, if you are using only Voice Information, follow steps 1, 3, 5, 6 and 7. If you are using only Personal Mailbox, follow steps 2, 4, 5, 6 and 7.

- 1** Record Voice-on-Demand information messages.
(Function), 9, 4)
- 2** Record Outgoing Message (OGM) and Password for each Personal Mailbox.
(Function), 9, 3)
- 3** Record 2nd Level Outgoing Message (OGM) for Voice Information.
(Function), 9, 2)
- 4** Record 2nd Level Outgoing Message (OGM) for Personal Mailbox.
(Function), 9, 2)
- 5** Record 1st Level Outgoing Message (OGM).
(Function), 9, 2)
- 6** Turn Message Center Pro **ON**.
(Function), 9, 1)
- 7** Activate Message Center Mode.

Voice

*Recording,
Playing and
Erasing
Voice
Information
is included
in this
section.*

The Voice-on-Demand allows you to store voice messages into the memory boxes respectively. You can use the memory boxes to provide callers with more information automatically and effectively, without answering the call yourself.

Recording Voice Information In Memory Box

- 1** Press (Function), 9, 4).
- 2** Press (Set). The screen prompts you to enter a Voice Memory Box number.

VOICE NO.: _

- 3** Enter a memory box number (01-99).

*See
Setting
Maximum
Time for
Incoming
Messages
Time
p. 65*

4 Press **[Set]**. The screen prompts:

REC/ERASE/PLAY?

5 Press **[Record]**, then pick up the handset. Record a message up to the Incoming Maximum Message Time you've set.

6 Replace the handset. The FAX/MFC plays back your message.

7 To leave another message, return to Step 3.

8 Press **[Stop]** to exit.

Playing Voice Message in Memory Box

1 Press **[Function]**, **[9]**, **[4]**.

2 Press **[Set]**. The screen prompts you to enter a Voice Memory Box number.

VOICE NO.: _

3 Enter a memory box number (01-99).

4 Press **[Set]**. The screen prompts:

REC/ERASE/PLAY?

5 Press **[Play]**. The FAX/MFC plays the message stored in the selected memory box. Adjust volume by pressing Speaker Volume **[Low]** or **[High]**.

Erasing Voice Memory Box

1 Press **[Function]**, **[9]**, **[4]**.

2 Press **[Set]**. The screen prompts you to enter a Voice Memory Box number.

VOICE NO.: _

3 Enter a memory box number (01-99).

4 Press **[Set]**. The screen prompts:

REC/ERASE/PLAY?

5 Press **[Erase]**, **[1]** to erase the voice message stored in the selected memory box.

Personal Mailbox

Recording, Playing and Erasing Personal Mailbox OGMs is included in this section.

Callers can enter a confidential fax or voice message into one of five personal mailboxes. Each mailbox is accessed by a pre-determined password, to help protect the privacy of multiple FAX/MFC users. The same password is necessary to retrieve these messages remotely.

Recording Personal Mailbox OGM/Password

1 Press **Function**, **9**, **3**.

2 The screen prompts you to select a mailbox number.

BOX NO.: 01
SELECT < > & SET

3 Press **<** or **>** to display your selected mailbox number.

4 Press **Set** when the screen displays the selected mailbox. The screen then prompts you to enter a 4-digit password.

PASSWORD: XXXX

5 Enter the 4-digit code you want to use as your password.

6 Press **Record**, then pick up the handset.

7 Record an OGM (no longer than 20 seconds) that informs users they can send a fax or voice message.

8 Replace the handset. The FAX/MFC plays back your OGM.

9 Press **Stop** to exit.

Playing Incoming Messages and Memo in Personal Mailbox

The screen displays whether it has received any messages. If any mailboxes contain messages, the screen will alternately display the numbers of those mailboxes, with how many VOICE and FAX messages the Message Center has stored.

To listen to voice incoming messages and memos in your mailbox, or to print faxes in your mailbox, you will need your 4-digit password.

1 Press **Play**, while holding down **Shift**.

2 Press **<** or **>** to display the mailbox number you want to select.

- 3 Press **Set**. The screen then prompts you to enter your 4-digit password.
- 4 Enter your password.
- 5 Press **Set**. The FAX/MFC plays back voice incoming messages and memos stored in the mailbox, then prints faxes stored in the mailbox.

Erasing Incoming Messages and Memos From Personal Mailbox

You can erase voice incoming messages and memos individually or all at once. You cannot erase fax incoming messages individually.

To erase an individual message

- 1 Press **Play**, while holding down **Shift**.
- 2 Press **Left** or **Right** to display the number you want to select.
- 3 Press **Set**. The screen then prompts you to enter your 4-digit password.
- 4 Enter your password.
- 5 Press **Set**. The FAX/MFC begins to play back messages. Each message is preceded by one long beep and followed by two short beeps.
- 6 Press **Erase** immediately after the two short beeps, or while a message is playing to erase it. The screen prompts:

ERASE THIS MSG?
1. YES 2. NO

- 7 Press **1** to erase
—OR—
Press **2** to exit without erasing.

To erase all messages

- 1 Press **Erase**, while holding down **Shift**.
- 2 Press **Left** or **Right** to display your selected mailbox number.
- 3 Press **Set**. The screen then prompts you to enter your 4-digit password.
- 4 Enter your password.
- 5 Press **Set**.
- 6 Press **Left** or **Right** to select **VOICE** (erase all voice messages), **FAX** (erase all fax messages), or **MSG** (erase all messages).

*See
Recording
OGM/
Password
p. 76*

- 7 Press **[Set]** when the screen displays your selection.
- 8 Press **[1]** to erase
—OR—
Press **[2]** to exit without erasing.

Recording Memo in Personal Mailbox

- 1 While holding down **[Shift]**, press **[Record]**.
- 2 Press **[◀]** or **[▶]** to display the mailbox number you want to select. Press **[Set]**.
- 3 Pick up the handset and record your memo (no longer than the Incoming Message Maximum Time).
- 4 Replace the handset or press **[Stop]**.

Remote Retrieval of Incoming Messages and Memos In Personal Mailbox

- 1 Dial your FAX/MFC number from a touch tone phone (or from fax machine if you plan to retrieve fax messages).
- 2 During the Message Center Pro OGM (1st Level), immediately enter **[0] [1] [*]** to access Personal Mailbox.
- 3 When you hear 2nd Level OGM, enter your Personal Mailbox number (**01*—05***).
- 4 When you hear your Personal Mailbox OGM, enter your 4-digit password. If there are no messages, the line will disconnect. If there are messages, you will hear the voice messages begin to play. Press **[1]** to replay a message while it is playing. Press **[2]** to skip a message. Press **[9]** to stop message playback. Press **[3]** to erase all messages.
- 5 Replace the handset.

*See
Recording
OGM/
Password
p. 76*

Recording Second Level OGM

Recording, Playing and Erasing Second Level OGMs is included in this section.

After callers have pressed **[0] [1] [*]** for Personal Mailbox, or **[0] [2] [*]** for Voice-on-Demand, they will need to hear more instructions from you in the 2nd Level OGM. Make sure you tell callers the memory box numbers of specific voice messages (2 3 *, 2 4 *, 2 5 *, etc.) and the names and mailbox numbers (0 1 *—0 5 *) for personal mailboxes.

- 1 Press **[Function]**, **[9]**, **[2]**. The screen prompts you to select an OGM.
- 2 Use **[◀]** or **[▶]** to display **MAIL BOX** or **VOICE ON DEMAND**.
- 3 Press **[Set]**. The screen prompts:

REC/ERASE/PLAY?

- 4 Press **[Record]**, then pick up the handset. Record a message no longer than 20 seconds.
- 5 Hang up. The FAX/MFC plays back the selected second level OGM.
- 6 Press **[Stop]** to exit.

Playing Second Level OGM

- 1 Press **[Function]**, **[9]**, **[2]**. The screen prompts you to select an OGM.
- 2 Use **[◀]** or **[▶]** to display **MAIL BOX** or **VOICE ON DEMAND**.
- 3 Press **[Set]**. The screen prompts:

REC/ERASE/PLAY?

- 4 Press **[Play]**. Adjust the volume by pressing Speaker Volume **[Low]** or **[High]**.
- 5 Press **[Stop]** to exit.

Erasing Second Level OGM

- 1 Press **[Function]**, **[9]**, **[2]**. The screen prompts you to select an OGM.
- 2 Use **[◀]** or **[▶]** to display **MAIL BOX** or **VOICE ON DEMAND**.
- 3 Press **[Set]**. The screen prompts:

REC/ERASE/PLAY?

- 4 Press **[Erase]**, **[1]**.
- 5 Press **[Stop]** to exit.

Recording First Level OGM

Recording, Playing and Erasing First Level OGMs is included in this section.

This is the announcement all callers will hear. In this announcement, you must tell callers how to select the option for Personal Mailbox (press **0 1 ***) or Voice-on-Demand (press **0 2 ***). This outgoing message should also tell callers that after the beep they can leave a voice message, or they can send a fax .

- 1 Press **Function**, **9**, **2**. The screen prompts you to select an OGM.

```
MSG CTR PRO
SELECT ← → & SET
```

- 2 Use **←** or **→** to display **MSG CTR PRO**.
- 3 Press **Set**. The screen prompts:

```
REC/ERASE/PLAY?
```

- 4 Press **Record**, then pick up the handset. Record a message no longer than 20 seconds.
- 5 Hang up. The FAX/MFC plays back the first level OGM.
- 6 Press **Stop** to exit.

Playing First Level OGM

- 1 Press **Function**, **9**, **2**. The screen prompts you to select an OGM.
- 2 Use **←** or **→** to display **MSG CTR PRO**.
- 3 Press **Set**. The screen prompts:

```
REC/ERASE/PLAY?
```

- 4 Press **Play**. Adjust the volume by pressing Speaker Volume **Low** or **High**.
- 5 Press **Stop** to exit.

Erasing First Level OGM

- 1 Press **Function**, **9**, **2**. The screen prompts you to select an OGM.
- 2 Use **←** or **→** to display **MSG CTR PRO**.
- 3 Press **Set**. The screen prompts:

```
REC/ERASE/PLAY?
```

- 4 Press **Erase**, **1**.
- 5 Press **Stop** to exit.

..... ***Turning On Message Center Pro***

This is the final step to turn on Message Center Pro. You must have already stored information in Personal Mailboxes and/or in Voice-on-Demand memory boxes. You must have recorded a 1st Level and a 2nd Level OGM.

- 1** Press **Function**, **9**, **1**.
- 2** The screen prompts you to select **ON** or **OFF**.
- 3** Use **◀** or **▶** to select **ON** (or **OFF**).
- 4** Press **Set** when the screen displays your selection.
- 5** Press **Stop** to exit.

Printing Reports and Lists

FAX/MFC Activity

You can print the following lists and reports:

1. ACT. REPORT

Activity Report lists information about the last 30 incoming and outgoing faxes. TX means Transmit; RX means Receive.

2. ALL DIAL

Lists names and numbers stored in One Touch and Speed Dial memory, in numerical order.

3. TEL. INDEX

ALL DIAL list (above), alphabetically.

4. COVERPAGE

Check cover page format.

5. CALL BACK MSG

Check Call Back Message format.

6. USER OPTIONS

Lists settings for USER OPTIONS, TEL OPTIONS, SETUP SYSTEM, SETUP MSG CTR and SETUP MC PRO.

7. XMIT REPORT

You can print a Transmission Verification Report after all faxes you send.

8. MEMORY STATUS

Lists summary information and amount of occupied memory.

9. CALLER ID

Lists Caller ID names/numbers, and time and date of call.

*See
FAX/MFC
Activity
p. 83*

To print a report

- 1 Press **Function**, **3**.
- 2 Enter the number of the report you want to print. For example, press **3** to print the TEL.INDEX.
- 3 Press **Start**.
- 4 Press **Stop** to exit.

Activity Report Interval

You can set the FAX/MFC to print activity reports at specific intervals (6, 12, 24 hours, 2, 4, or 7 days). Even if you set the interval to OFF, you can print the report at any time by following the steps in the previous section.

- 1 Press **Function**, **7**, **3**. The screen displays the current interval setting.

ACT. RPT. : OFF

- 2 Press **◀** or **▶** to choose your setting. If you choose 7 days, the screen prompts you to choose a day at which to begin the 7-day countdown.
- 3 When the screen displays the setting you want, press **Set**.
- 4 Enter the time to begin printing, in 24-hour format. (For example, enter 19:45 for 7:45 PM).
- 5 Wait 2 seconds.
- 6 Press **Stop** to exit.

Transmission Verification (Xmit) Report

You can use the Xmit Report as proof that you sent a fax. This report lists the name or fax number of the receiving party, the time and date of transmission, and if the transmission was successful.

When the feature is OFF, the report is printed automatically only if there's an error during transmission. If the report indicates NG, send the document again. If the report indicates you should check the readability of certain pages, resend those pages.

When the feature is ON, the report is printed with every fax you send.

- 1 Press **Function**, **3**, **7**.
- 2 Press **◀** or **▶** to select **ON** (or **OFF**).
- 3 Press **Set**.
- 4 Press **Stop** to exit.

Important Information

Standard Telephone and FCC Notices

These notices are in effect on models sold and used in the United States only.

This equipment is hearing aid compatible.

When programming emergency numbers and/or making test calls to emergency numbers:

- Remain on the line and briefly explain to the dispatcher the reason for the call before hanging up.
- Perform such activities in the off-peak hours, such as early morning or late evening.

This equipment complies with Part 68 of FCC Rules. On the rear panel of this equipment is a label that contains, among other information, the FCC Registration Number and Ringer Equivalence Number (REN) for this equipment. You must, upon request, provide this information to your telephone company.

You may safely connect this equipment to the telephone line by means of a standard modular jack, USOC RJ11C.

An FCC compliant telephone cord with a modular plug is provided with this equipment. This equipment is designed to be connected to the telephone line or premises wiring using a compatible modular jack that is Part 68 compliant. See the Installation section of this manual for details.

The REN is useful to determine the quantity of devices you may connect to your telephone line and still have those devices ring when your telephone number is called. In most, but not all areas, the sum of the RENs of all devices connected to one line should not exceed five (5). To be certain of the number of devices you may connect to your line, as determined by the REN, you should contact your local telephone company to determine the maximum REN for your calling area. If your fax damages the telephone network, the telephone company may discontinue your service temporarily. If possible, they will notify you in advance. But if advance notice is not practical, you will be notified as soon as possible. You will be informed of your right to file a complaint with the FCC.

Your telephone company may make changes to its facilities, equipment, operations or procedures that could affect the proper functioning of your equipment. If they do, you will be notified in advance to give you an opportunity to maintain uninterrupted telephone service.

If you experience trouble with this FAX/MFC, please contact Brother Customer Service for information on obtaining service or repair. The telephone company may ask that you disconnect this equipment from the line until the problem has been corrected or until you are sure that the equipment is not malfunctioning.

If you are not able to solve a problem with your FAX/MFC, contact Brother at

USA: *1-800-284-4329* (voice)

1-908-575-8790 (fax)

From within Canada: *1-800-853-6660* (voice)

1-514-685-4898 (fax)

From within Montreal: *1-514-685-6464* (voice)

International Energy Star Compliance Statement

The purpose of the International Energy Star Program is to promote the development and popularization of energy-efficient office equipment, which includes computers, monitors, printers, facsimile receivers and copy machines world-wide. As an International Energy Star partner, Brother Industries, Ltd. has determined that this product meets the guidelines of the program.





WARNING

For protection against the risk of electrical shock, always disconnect all cables from the wall outlet before servicing, modifying or installing the equipment.

This equipment may not be used on coin service lines provided by the telephone company or connected to party lines.

Federal Commission Compliance Notice (For USA Only)

This equipment has been tested and found to comply with the limits for a Class B digital device, pursuant to Part 15 of the FCC Rules. These limits are designed to provide reasonable protection against harmful interference in a residential installation. This equipment generates, uses, and can radiate radio frequency energy and, if not installed and used in accordance with the instructions, may cause harmful interference to radio communications. However, there is no guarantee that interference will not occur in a particular installation. If this equipment does cause harmful interference to radio or television reception, which can be determined by turning the equipment off and on, the user is encouraged to try to correct the interference by one or more of the following measures:

- Reorient or relocate the receiving antenna.
- Increase the separation between the fax equipment and the receiver.
- Connect the fax equipment on a separate circuit.
- Consult with the dealer or an experienced radio/TV technician for help.

Industry Canada Compliance Statement (For Canada Only)

This Class B digital apparatus meets all requirements of the Canadian Interference-Causing Equipment Regulations.

Cet appareil numérique de la classe B respecte toutes les exigences du Règlement sur le matériel brouilleur du Canada.

Brother cannot accept any financial or other responsibilities that may be the result of your use of this information, including direct, special or consequential damages. There are no warranties extended or granted by this document.

The serial number may be found on the label affixed to the back of the unit. For your convenience, note the number below and retain this Owner's Manual to

serve as a permanent record of your purchase, in the event of a theft or fire, or for future reference.

MODEL NO. FAX 1570MC, MFC 1870MC, MFC 1970MC
(Circle your model number)

SERIAL NUMBER _____

NAME OF DEALER _____

DATE OF PURCHASE _____

Important Safety Instructions

- 1** Read all of these instructions.
- 2** Save them for later reference.
- 3** Follow all warnings and instructions marked on the product.
- 4** Unplug this product from the wall outlet before cleaning. Do not use liquid or aerosol cleaners. Use a damp cloth for cleaning.
- 5** Do not use this product near water.
- 6** Do not place this product on an unstable cart, stand, or table. The product may fall, causing serious damage to the product.
- 7** Slots and openings in the cabinet and the back or bottom are provided for ventilation; to ensure reliable operation of the product and to protect it from overheating, these openings must not be blocked or covered. The openings should never be blocked by placing the product on a bed, sofa, rug, or other similar surface. This product should never be placed near or over a radiator or heater. This product should never be placed in a built-in installation unless proper ventilation is provided.
- 8** This product should be operated from the type of power source indicated on the label. If you are not sure of the type of power available, consult with your dealer or local power company.
- 9** This product is equipped with a 3-wire grounding type plug, a plug having a third (grounding) pin. This plug will fit into only a grounding-type power outlet. This is a safety feature. If you are unable to insert the plug into the outlet, contact your electrician to replace your obsolete outlet. Do not defeat the purpose of the grounding-type plug.
- 10** Do not allow anything to rest on the power cord. Do not place this product where people can walk on the cord.

- 11** If an extension cord is used with this product, make sure that the total ampere ratings on the products plugged into the extension cord do not exceed the extension cord ampere rating. Also, make sure that the total of all products plugged into the wall outlet does not exceed 15 amperes (USA only).
- 12** Do not place anything in front of the FAX/MFC that will block received faxes. Do not place anything in the path of received faxes.
- 13** Do not touch a document during printing.
- 14** Never push objects of any kind into this product through cabinet slots, since they may touch dangerous voltage points or short out parts resulting in a risk of fire or electric shock. Never spill liquid of any kind on the product.
- 15** Do not attempt to service this product yourself, as opening or removing covers may expose you to dangerous voltage points and/or other risks, and may void your warranty. Refer all servicing to a Brother Authorized Service Center. A list of Brother Authorized Service Centers has been included for your convenience, or you may contact the following Customer Service Numbers for your nearest Brother Authorized Service Center:

USA: *1-800-284-4329* (voice)
1-908-575-8790 (fax)
1-800-521-2846 (Fax-Back System)

From within Canada: *1-800-853-6660* (voice)
1-514-685-4898 (fax)
1-800-681-9838 (Fax-Back System)

From within Montreal: *1-514-685-6464* (voice)

- 16** Unplug this product from the wall outlet and refer servicing to a Brother Authorized Service Center under the following conditions:
 - A** When the power cord is damaged or frayed.
 - B** If liquid has been spilled into the product.
 - C** If the product has been exposed to rain or water.
 - D** If the product does not operate normally when the operating instructions are followed. Adjust only those controls that are covered by the operating instructions. Improper adjustment of other controls may result in damage and will often require extensive work by a qualified technician to restore the product to normal operation.
 - E** If the product has been dropped or the cabinet has been damaged.
 - F** If the product exhibits a distinct change in performance, indicating a need for service.
- 17** To protect your product against power surges, we recommend the use of a power protection device (Surge Protector).

Notice-Disclaimer of Warranties

BROTHER'S LICENSOR(S) MAKES NO WARRANTIES, EXPRESS OR IMPLIED, INCLUDING WITHOUT LIMITATION THE IMPLIED WARRANTIES OF MERCHANTABILITY AND FITNESS FOR A PARTICULAR PURPOSE, REGARDING THE SOFTWARE. BROTHER'S LICENSOR(S) DOES NOT WARRANT, GUARANTEE OR MAKE ANY REPRESENTATIONS REGARDING THE USE OR THE RESULTS OF THE USE OF THE SOFTWARE IN TERMS OF ITS CORRECTNESS, ACCURACY, RELIABILITY, CURRENTNESS OR OTHERWISE. THE ENTIRE RISK AS TO THE RESULTS AND PERFORMANCE OF THE SOFTWARE IS ASSUMED BY YOU. THE EXCLUSION OF IMPLIED WARRANTIES IS NOT PERMITTED BY SOME STATES. THE ABOVE EXCLUSION MAY NOT APPLY TO YOU.

IN NO EVENT WILL BROTHER'S LICENSOR(S), AND THEIR DIRECTORS, OFFICERS, EMPLOYEES OR AGENTS (COLLECTIVELY BROTHER'S LICENSOR) BE LIABLE TO YOU FOR ANY CONSEQUENTIAL, INCIDENTAL OR INDIRECT DAMAGES (INCLUDING DAMAGES FOR LOSS OF BUSINESS PROFITS, BUSINESS INTERRUPTION, LOSS OF BUSINESS INFORMATION, AND THE LIKE) ARISING OUT OF THE USE OR INABILITY TO USE THE SOFTWARE EVEN IF BROTHER'S LICENSOR HAS BEEN ADVISED OF THE POSSIBILITY OF SUCH DAMAGES. BECAUSE SOME STATES DO NOT ALLOW THE EXCLUSION OR LIMITATION OF LIABILITY FOR CONSEQUENTIAL OR INCIDENTAL DAMAGES, THE ABOVE LIMITATIONS MAY NOT APPLY TO YOU. IN ANY EVENT BROTHER'S LICENSOR'S LIABILITY TO YOU FOR ACTUAL DAMAGES FROM ANY CAUSE WHATSOEVER, AND REGARDLESS OF THE FORM OF THE ACTION (WHETHER IN CONTRACT, TORT (INCLUDING NEGLIGENCE), PRODUCT LIABILITY OR OTHERWISE), WILL BE LIMITED TO \$50.

Trademarks

The brother logo is a registered trademark of Brother Industries, Ltd.

Brother is a registered trademark of Brother Industries, Ltd.

Visioneer PaperPort is a registered trademark of Visioneer, Inc.

Windows is a registered trademark of Microsoft in the U.S. and other countries.

All other terms and brand and product names mentioned in this manual are registered trademarks of their respective companies.

Compilation and Publication Notice

Under the supervision of Brother Industries Ltd., this manual has been compiled and published, covering the latest product descriptions and specifications.

The contents of this manual and the specifications of this product are subject to change without notice.

Brother reserves the right to make changes without notice in the specifications and materials contained herein and shall not be responsible for any damages (including consequential) caused by reliance on the materials presented, including but not limited to typographical and other errors relating to the publication.

Troubleshooting and Maintenance

Fax-Back System

Brother Customer Service has installed an easy-to-use Fax-Back System, so you can get instant answers to common technical questions and product information for all Brother products. This system is available 24 hours a day, 7 days a week. You can use the system to send faxes to any fax machine, not just the one from which you are calling.

If you can't resolve difficulty with your FAX/MFC using this manual, call our Fax-Back System, and follow the voice prompts to receive faxed instructions about using the system, and an index of Fax-Back subjects.

USA: *1-800-521-2846*

From within Canada: *1-800-681-9838*

The Brother Fax-Back System number (USA only) has been preprogrammed on One Touch Key **01**.

Brother Home Page on the World Wide Web

You can find more information about Brother products, from product specification sheets to Frequently Asked Questions (FAQs), on the World Wide Web. Visit us at

<http://www.brother.com>

Brother Bulletin Board

Brother's Bulletin Board Numbers are

USA: *1-888-298-3616*

From within Canada: *1-514-685-2040*

Error Messages

As with any sophisticated office product, errors may sometimes occur. If this happens, your FAX/MFC often identifies the problem and displays an error message. The table below explains the most common error messages.

You can correct most problems by yourself. If you need additional help, call the Brother Fax-Back System.

USA: *1-800-521-2846*

From within Canada: *1-800-681-9838*

CHECK PAPER

The paper is jammed in the printer.

- 1** Unplug the power cord.
- 2** Open the paper cover and remove any unjammed paper.
- 3** Push the OPEN button to open the top cover.
- 4** Pull the jammed paper gently from the paper feeder toward the back of the FAX/MFC. If the paper remains jammed, then pull it toward the front of the FAX/MFC.

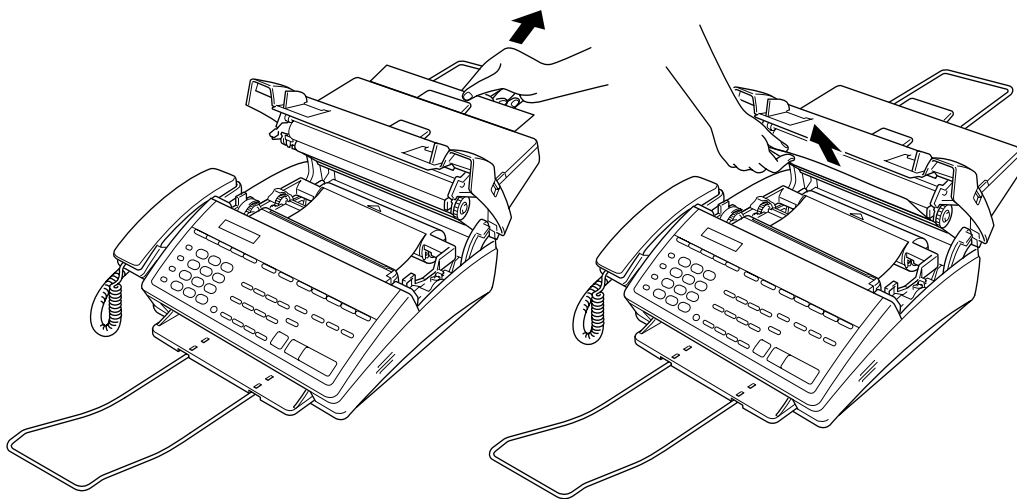

- 5** Close the cover.
- 6** Load the paper.

CLEAN UP SCANNER

The scanner is dirty; clean the white bar and the glass strip under the roller with isopropyl alcohol on a lint-free cloth. You'll need to lift the two release levers to release the white bar; be sure to lock them in place when you're through. During cleaning, unplug the power cord for safety.

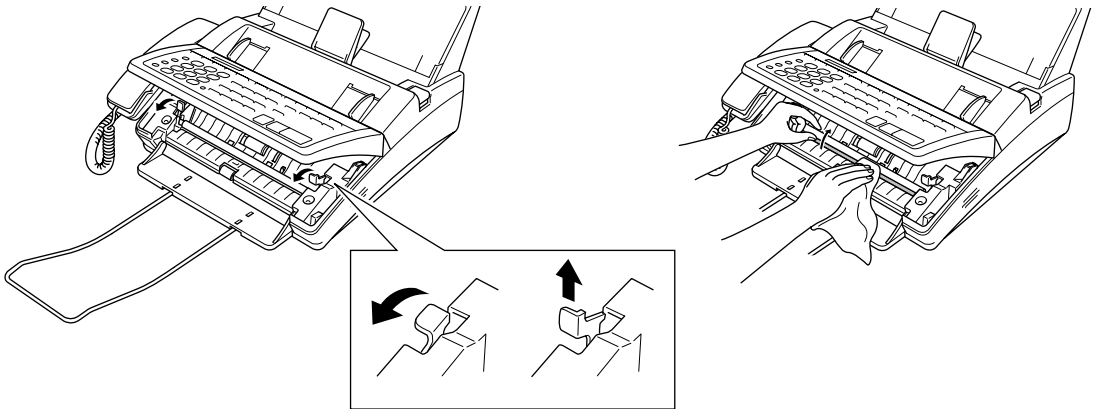
**COMM. ERROR**

A poor quality phone line resulted in a communications error. Try the call again.

CONNECTION FAIL

You have requested a polling call from another party, but the other fax machine is not in Poll Waiting mode.

COVER OPEN

The cover is not completely closed.

DISCONNECTED

The other party has disconnected during a call or fax. Try calling the other party.

DOCUMENT JAM

The documents were not inserted or fed properly, or were too long or too short.

- 1** Open the front cover.
- 2** Lift the two release levers to release the white bar.
- 3** Gently pull the document toward the front of the FAX/MFC.

- 4 Lock the levers back in place.
- 5 Close the cover and press **Stop**.

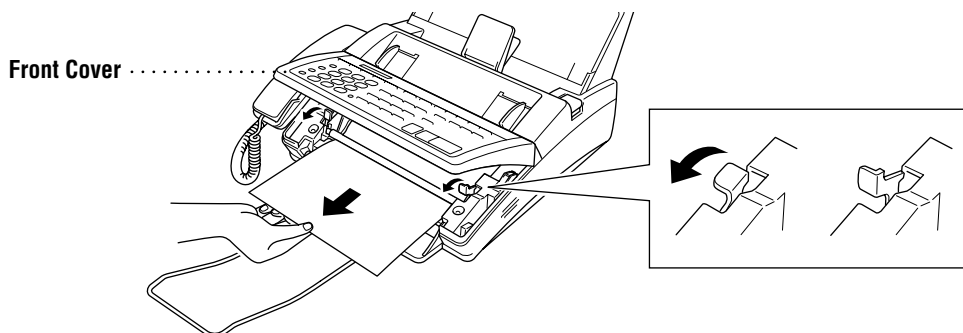

MACHINE ERROR XX

and

PRESS STOP KEY

Contact Brother Customer Service at

USA: 1-800-284-4329 (voice)

From within Canada: 1-800-853-6660 (voice)

From within Montreal: 1-514-685-6464 (voice)

NO RESPONSE/BUSY

The number you called does not answer or is busy. You may also have reached a number not connected to a fax machine. Check the number and call again.

NOT REGISTERED

You've tried accessing a One Touch or Speed Dial location with no number assigned to it.

PRINTER FAULT

The print head has overheated. Unplug the FAX/MFC and wait 30 minutes for it to cool.

*See
Storing One
Touch Dial
numbers and
Storing
Speed Dial
numbers
pp. 20-22*

SCANNER ERROR

During cleaning, unplug the power cord. Try cleaning the white bar and the glass strip under the bar. If you still get a scanner error, contact Brother Customer Service at

USA: 1-800-284-4329 (voice)

From within Canada: 1-800-853-6660 (voice)

From within Montreal: 1-514-685-6464 (voice)

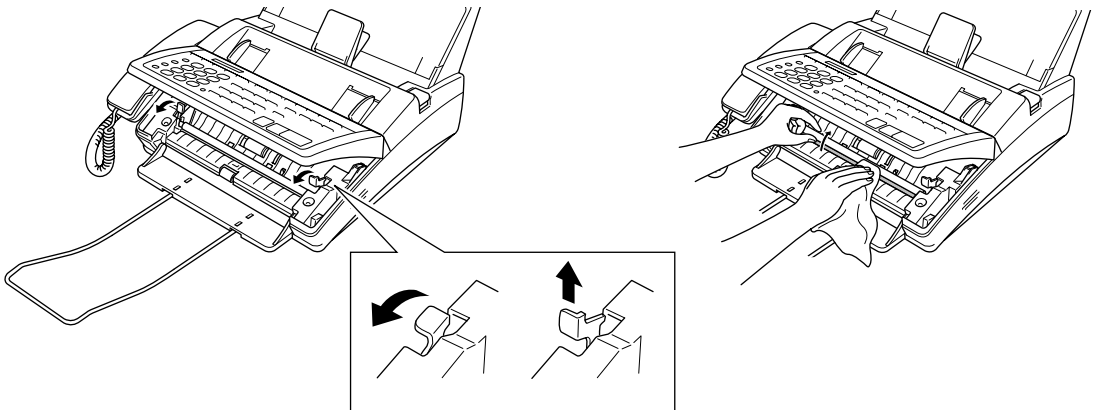

If You Are Having Difficulty with Your FAX/MFC

If you think there is a problem with your FAX/MFC, make a copy first. If the copy looks good, the problem is probably not your FAX/MFC. Check the chart below and follow the troubleshooting tips.

► *Printing and Receiving Faxes*

Condensed Print and Horizontal Streaks; Top and Bottom of Sentences Cut Off

If your copy looks good, you probably had a bad connection, with static or interference on the phone line. If the copy looks bad, call Brother Customer Service at 1-800-284-4329.

Vertical Black Lines When Receiving

The sender's scanner may be dirty. Ask the sender to make a copy to see if the problem is with the sending machine. Try receiving from another fax machine. If the problem continues, call Brother Customer Service at 1-800-284-4329.

► *Phone
Line or
Connections*

FAX/MFC Does Not Answer When Called

Make sure the FAX/MFC is in the correct receiving mode for your setup (either FAX, F/T or MSG CTR). Check for dial tone. If possible, call your FAX/MFC to hear it answer. If there is still no answer, check the telephone line cord connection. Connect a standard telephone handset to the FAX/MFC telephone jack. If there is no ringing when you call your FAX/MFC, call your Telephone Company to check the line.

Dialing Does Not Work

Check for a dial tone. If there is no dial tone, see Suggestions for “No Dial Tone on the Handset”. Change the TONE/PULSE setting (see “Fax Settings”, p.17). Send a manual fax (press **Speaker Phone** or lift handset), and wait to hear fax receiving tones before pressing **Start**. This way you can hear if the problem is that the receiving machine does not answer.

No Dial Tone on the Handset

Press **Speaker Phone**. If you hear no dial tone, check telephone line cord connections at the FAX/MFC and wall jack. Check that the handset is connected to the FAX/MFC’s handset jack. Test the wall jack with another single line telephone. If no dial tone on the wall outlet, call your Telephone Company.

► *Sending
Faxes*

Poor Transmitting Quality

Try changing your resolution to FINE or SUPER FINE (see “Sending Faxes” pp. 31-33).

Try cleaning the white pressure bar of the scanner and the glass under the bar (see p. 94).

Transmission Verification Report says “Result: NG”

There is probably temporary noise or static on the line. Try sending the fax again. If the problem continues, call the Telephone Company to check your phone line.

Vertical Black Lines When Sending

If the copy you made shows the same problem, your scanner is dirty (see Cleaning the Scanner p. 95).

► **Handing
Incoming
Calls**

Double Ring in F/T Mode

The FAX/MFC knows the incoming call is not a fax so it is signaling you to answer the telephone call. Pick up the FAX/MFC's handset or answer from an extension phone and press your FAX/MFC's Remote Deactivation Code (default setting is #51).

Transferring a Fax Call to the FAX/MFC

If you answered at the FAX/MFC, press **[Start]** and hang up immediately. If you answered at an extension phone, press your Remote Activation Code (default setting is *51). When your FAX/MFC answers, hang up.

► **Adjusting
Settings**

FAX/MFC "Hears" Voice as CNG Tone

If your FAX/MFC is set to Easy Receive On, and it answers voice calls by trying to receive a fax, try turning Easy Receive Off.

For Customer Service

USA: 1-800-284-4329 (voice)

1-908-575-8790 (fax)

From within Canada: 1-800-853-6660 (voice)

1-514-685-4898 (fax)

From within Montreal: 1-514-685-6464 (voice)

Setting up the MFC 1870MC or MFC 1970MC and Computer to Work Together

Before You Install Multi-Function Link

This chapter takes you through each step of the installation process. Read it carefully to ensure a problem-free installation.

Package Contents

Before you begin the Multi-Function Link installation, please check the contents of your package:

- Brother CD-ROM
- Multi-Function Link Cable and PC I/F Box
- Warranty, Upgrade and Licensing Materials

PC Configuration Requirements

Your PC must meet or exceed the following minimum system configuration requirements for you to install and use Multi-Function Link:

CPU	80486/66 or higher
RAM	8MB or greater for Windows® 3.1 or 3.11 8MB or greater for Windows® 95 (16MB recommended) 16MB or greater for Windows NT® Workstation Version 4.0 (32MB recommended)
Hard Disk Drive	50MB
Operating System	Windows® 3.1, 3.11, 95 or NT® Workstation Version 4.0
Port	Available Serial port
CD-Rom Drive	

Connecting MFC 1870MC or MFC 1970MC to Your PC

Follow the instructions below to hook up the Multi-Function Link Cable.

- 1 Position your Brother MFC near your personal computer CPU (maximum distance of approximately 5-6 feet).
- 2 Make sure the power to the PC is switched off and the MFC is unplugged.
- 3 Connect the RJ-8 connector of the Multi-Function Link Cable to the side of your Brother MFC in the jack labeled *PC I/F*.
- 4 Connect the 25-pin *female* RS-232 connector of the Multi-Function Link Cable to your PC in the available *male* serial communications port. Use the 9-pin adapter if your PC requires it. (See your PC owner's manual for the correct interface port for connection.) **NOTE: If your PC is an IBM Aptiva, and MWAVE card is using COM1. You must connect the Multi-Function Link Cable to another COM serial port that is available.**

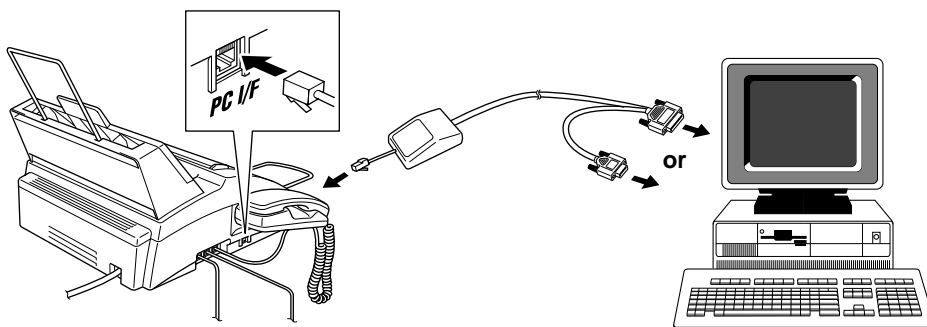

Available Options



Install Multi-Function Link Software

Click on Install Multi-Function Link Software to access the Software Installation window.

On-Line Documentation

On-Line Documentation includes all online documentation. To view the On-Line Documentation, you must first install the Acrobat Reader software from the CD-ROM, by clicking on the Install Acrobat Reader button.

Product Support

This is a page of all Brother support numbers.

Brother Web Link

Brother WEB Link visits the Internet Brother Home Page on the World Wide Web. You can find more information about Brother products, from product specifications sheets to Frequently Asked Questions (FAQ's). You must have service with an Internet service provider.

Click **Exit** to exit the CD-ROM window, or click **Return** to return to the previous window.

Installing the Multi-Function Link Software

Make sure your MFC 1870MC or MFC 1970MC is connected to your PC as described earlier and that both machines are plugged in and switched on.

Overview of Basic Steps

- 1 Insert the Brother CD-ROM into your CD-ROM drive and access the Installation Window.
- 2 Enter the command for your version of Windows®, if needed.
- 3 Select the option “Install Multi-Function Link Software”.
- 4 Follow the installation instructions.

Accessing the Software Installation Window

If you are using Windows® 95 or Windows NT® Workstation Version 4.0:

- When you insert the CD-ROM into the PC with Windows® 95 or Windows NT® Workstation Version 4.0, the screen appears automatically.
- You can also run: **X:SETUP.EXE** for Windows® 95 from Explorer on the root directory of the CD-ROM

If you are using Windows® 3.1 or 3.11:

- From the File Manager run:
X:SETUP.EXE (“X” is the drive letter for your CD-ROM drive). This will start the Software Installation program.

Installing the Brother Software

- 1 Insert the Brother CD-ROM into your CD-ROM drive.
- 2 Enter the command: **X:SETUP.EXE**

The Brother LOGO will be displayed on the screen.

The Brother software will run the appropriate install program.

The Brother software will identify your Windows® Operating System and automatically run the appropriate install program for your version of Windows®.

3 Click on the “Install Multi-Function Link Software” option.

The Software Installation window will appear.

The Software Installation screen automatically loads. Multi-Function Link includes Visioneer PaperPort applications.

4 Follow the installation instruction:

Follow the instructions on the screen. The last step will be to restart Windows®.

Viewing On-Line Documentation



Make sure you have installed the Acrobat Reader software. (Click on the Install Acrobat Reader button and follow the instructions on the screen.)

After the Acrobat Reader is installed, click on the View Multi-Function Link Documentation button. When the Table of Contents appears, select a chapter by clicking on it.



Since the Multi-Function Link Pro manual is On-Line Documentation only, you may wish to print a copy by selecting Print from the File pull-down menu.

C H A P T E R F O U R T E E N

Using the Multi-Function Link Software (For MFC 1870MC and MFC 1970MC Only)

Introduction

This chapter outlines the basics of the Brother software, so you can get started using the Multi-Function Link software. Detailed installation and setup instructions are in the On-Line Documentation section of the Brother CD-ROM that is included with your MFC. Be sure to check the online ReadMe file for last-minute, important information that was not included in the On-Line Documentation.

Running the Brother Software

The software included with your MFC consists of two parts, the Multi-Function Link and Visioneer PaperPort LE for Brother.

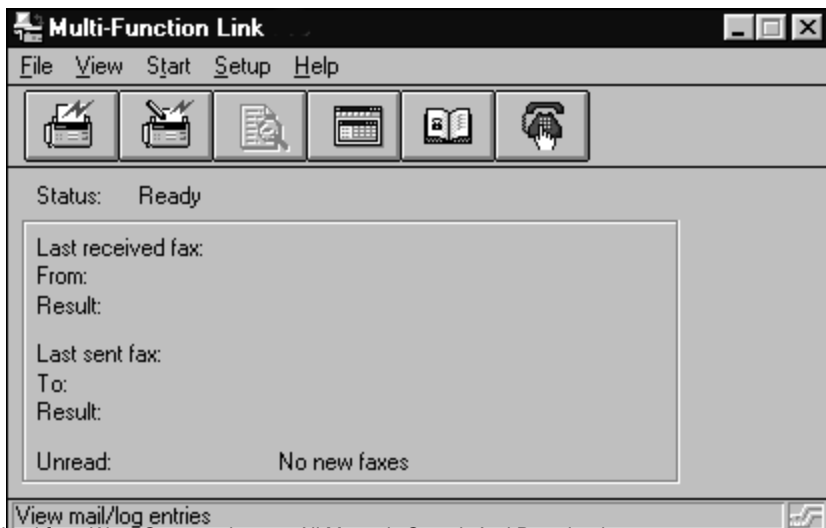

Multi-Function Link

The Multi-Function Link Main Menu is the application used for all fax sending and receiving operations. It also contains an electronic Phone Book program and a Log Manager that maintains a record of all PC fax transactions. The Main Menu can be accessed through the Brother Multi-Function Link program group.

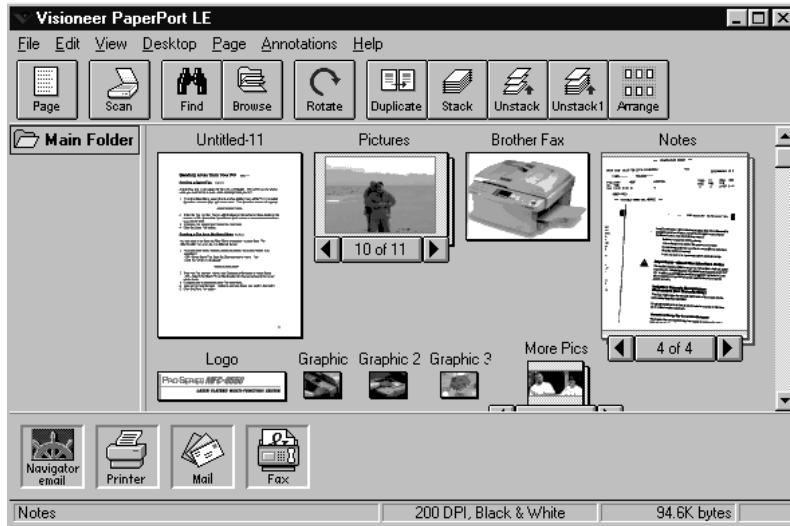

Visioneer PaperPort LE

Visioneer PaperPort LE for Brother is a document management application. You will use PaperPort to view incoming faxes and scanned documents. PaperPort has a sophisticated, yet easy to use filing system that will help you organize your documents. It allows you to combine or "stack" documents of different formats for printing, faxing, or filing. PaperPort can be accessed through the PaperPort program group.

Sending a Fax from Your PC

Sending a Quick Fax

A QuickFax is a cover page only fax with a message. This option is very useful when you want to fax a quick, short message from your PC.

- 1 From the Main Menu, select the QuickFax button  or select QuickFax from the Start pull-down menu. The QuickFax screen will appear.

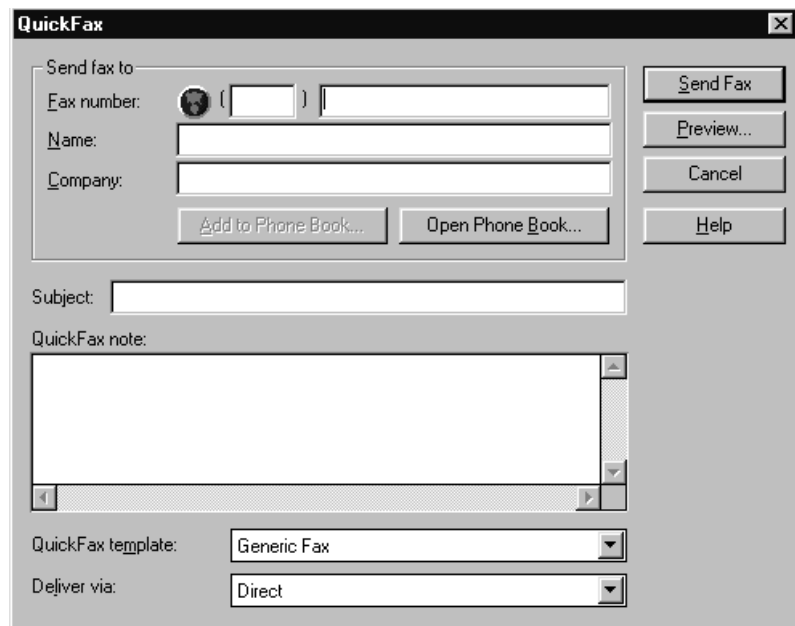

The screenshot shows a 'QuickFax' dialog box with the following elements:

- Send fax to:** A group box containing:
 - Fax number:** A text field with a globe icon and a small box for international dialing.
 - Name:** A text field.
 - Company:** A text field.
 - Buttons:** 'Add to Phone Book...' and 'Open Phone Book...'.
- Subject:** A text field.
- QuickFax note:** A large text area with scrollbars.
- Buttons:** 'Send Fax', 'Preview...', 'Cancel', and 'Help'.
- QuickFax template:** A dropdown menu currently showing 'Generic Fax'.
- Deliver via:** A dropdown menu currently showing 'Direct'.

- 2 Enter the Fax number, Name, and Company information in these fields on the screen—OR—Select the Open Phone Book... button to choose someone from your phone book.
- 3 Complete the Subject and QuickFax note fields.
- 4 Click the Send Fax button.

Sending a Fax from the Main Menu

You can send a fax from the Main Menu and attach multiple files. The “attachments” can even be in a different formats.

- 1 From the Main Menu window, select the Send Fax —OR—Select Send Fax from the Start pull-down menu. The Send Fax window will appear:

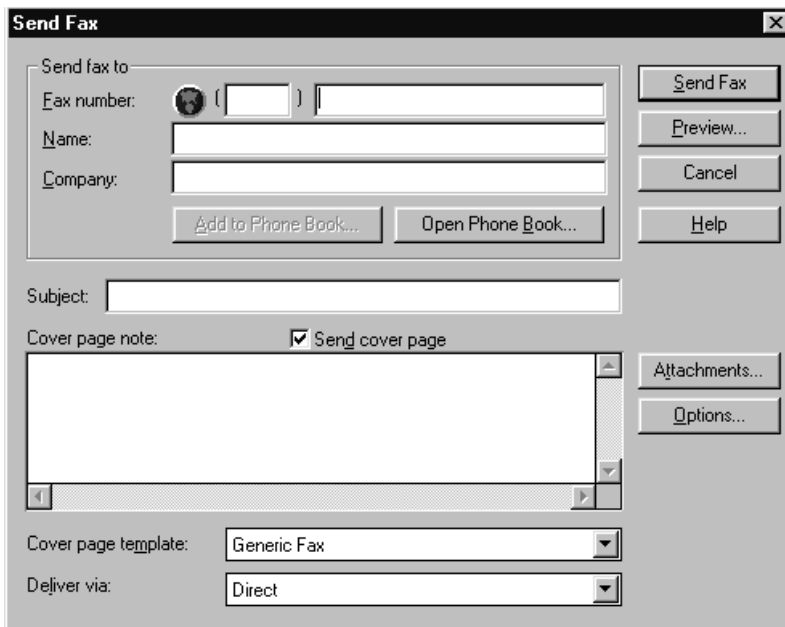

- 2** Enter the Fax number, Name, and Company information in these fields
—OR—Select the Open Phone Book button to choose someone from your phone book.
- 3** Complete the Subject and Cover page note fields.
- 4** Click on the Attachments... button to add any file(s) you want to fax with it.
- 5** Click the Send Fax button.

Sending a Fax from a Windows® Application

You can send a fax directly from any Windows® application using the following steps:

- 1** Create the document in a Windows® application.
- 2** Select Brother MFL Fax as your printer.
- 3** Select the Print command to begin the fax transmission.

The Fax Sending dialog box will appear :

- 4 Enter the name and fax number of the recipient or select the Open Phone Book... button and choose a name. Select Close to return to the Send Fax dialog box.
- 5 Select the Send cover page check box to include a cover page.
- 6 Select the Send Fax button.

Receiving Faxes into the PC

*See
Using the
MFC 1870MC
and
MFC 1970MC
with Your PC*

To receive faxes into your PC through the MFC, you must first connect your MFC to your computer. Then, you can load the software.

Before You Begin

Use the following checklists for the MFC and PC, to make sure you have properly set up the MFC and PC to work together.

Checklist for the MFC:

The default setting for MF Link mode is **PC PRIMARY** in this setting all faxes will be routed into the PC unless it is not turned on. If the PC is turned off, incoming faxes will be printed on the MFC.

- 1- To make sure the MF Link mode is set to **PC PRIMARY**, press **Function**, **7**, **8**.
- 2- Use **◀** or **▶** to select **PC PRIMARY**.
- 3- Press **Set**.
- 4- Press **Stop** to exit.

On your PC:

- 1- In the Main Menu, select the Setup pull-down menu.
- 2- Select Preferences...
- 3- Under Answer Mode, select Fax only.
- 4- Click the OK button.
- 5- Make sure the MFC is connected to the PC.
- 6- Keep the PC and the Multi-Function Link Main Menu running at all times.

Viewing Received Faxes

Faxes that are received into the PC will appear in the InBox of the Log Manager. To access the Log Manager, from the Main Menu click the Log Manager button



—OR— From the Start pull-down menu, select Mail/Log.

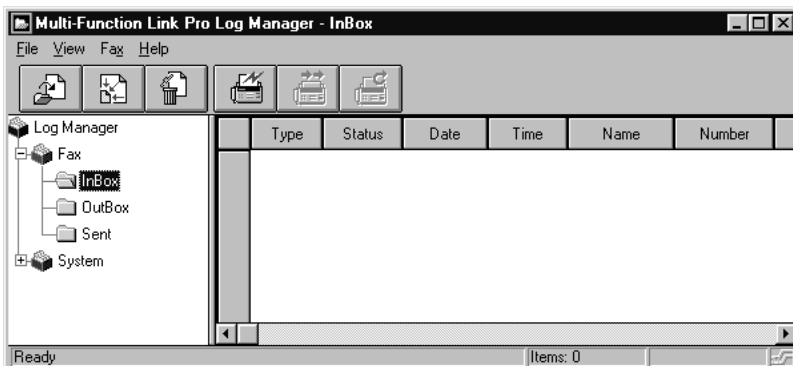

- 1- In the Log Manager, select the Fax folder.
- 2- Then select the InBox folder. A listing of your incoming messages will appear on the right side of the window.

- 3 Double-click on the fax you wish to view.

The Visioneer PaperPort Viewer will run automatically and the fax you selected from the list will be displayed.

Scanning a Document

The Brother Multi-Function Link software includes a TWAIN compliant scanner driver. TWAIN drivers meet the standard universal protocol for communicating between scanners and software applications. This means that not only can you scan images directly into the PaperPort viewer that Brother included with your MFC, but you can also scan images directly into hundreds of other software applications that support TWAIN scanning. These applications include popular programs like Adobe Photoshop, Aldus Pagemaker, Corel Draw and many more.

To choose the Brother Multi-Function Link as your scanner driver, select it under the “Select scanner” or “Select source” option in your software.

Scanning Options

When you scan using the Brother Multi-Function Link Scanner driver, a scanning options dialog box will appear:

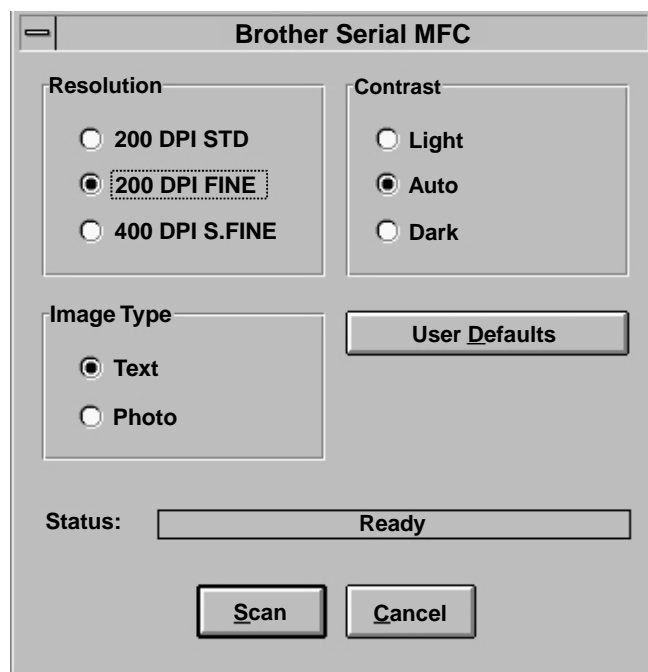

Set the following options based on each document to be scanned, then click the SCAN button to start scanning.

Resolution

You can choose one of three resolutions, 200 DPI STD, 200 DPI FINE or 400 DPI S.FINE. The higher the number of dpi (dots per inch), the clearer the image will appear on your PC. However, the size of the image file increases with the dpi. Try scanning at different resolutions to determine the best resolution for your needs.

Contrast

To have the scanner adjust the contrast automatically, choose Auto. If your original is too light, set the contrast to Light. If the original is too dark, set the contrast to dark.

Image Type

If you are scanning text or black and white line art, choose Text as the image type. If you're scanning a photo or detailed picture with many different colors, choose Photo as the image type.

Scanning into the PaperPort Viewer

To scan into the PaperPort viewer that was provided with your MFC, run the PaperPort viewer program and then select the SCAN button on the top of the

screen  or select ACQUIRE from the File pull-down menu.

Multi-Function Link (option) For FAX 1570MC

If you have a FAX 1570MC you can purchase the optional Multi-Function Link package (also called “Missing Link”). Multi-Function Link turns your fax machine into a multifunction center, by enabling you to use your fax machine as a printer and a scanner and to use it to fax messages from Windows applications in your computer.

Multi-Function Link is available at most Brother retailers. If you cannot find it, you can order Multi-Function Link directly from Brother. The item number is PCI-1.

Installation instructions will be included with PCI-1. However, it is important that you hook up your fax machine to your computer before you install the software.

Glossary

Activity Report Lists information about the last 30 incoming and outgoing faxes.

TX means Transmit. RX means Receive.

ADF (Automatic Document Feed) Refers to the number of pages that can be placed in the document feeder and fed one at a time automatically.

All Dial List A listing of names and numbers stored in One Touch and Speed Dial memory, in numerical order.

automatic fax transmission Sending a fax without picking up the handset or pressing **Speaker Phone**.

Backup Print Sets your FAX/MFC to print a copy of faxes that are received and stored in memory.

beeper The sound the keys make when they are pressed, an error occurs or a document has been received or transmitted.

broadcasting The ability to send the same fax message to more than one location.

Call Back Message Allows you to send a fax and then leave a message for the other party to call you back.

Call Reservation Allows you send a fax and then at the end of transmission, you can talk with the other party.

Caller ID A service purchased from the Telephone Company that lets you see the number (or name) of the party calling you.

Cancel Job Cancels a programmed job, like Delayed Fax or Polling.

CNG tones The special tones (beeps) sent by fax machines during automatic transmission to tell the receiving machine that they are from a fax machine.

communication error (or Comm. Error) An error during fax sending or receiving, usually caused by line noise or static.

Contrast Setting to compensate for dark or light documents, by lightening dark documents or darkening light documents.

Cover Page Prints a page at the other party's machine, that contains the sender and recipient's name and fax number, number of pages and comment. You can generate an electronic cover page at the other end with pre-programmed information from memory or you can print a sample cover page to fax with your document.

Delayed Fax Sends your fax at a later time that day.

Distinctive Ring A service purchased from the Telephone Company that provides another phone number on an existing phone line. The Brother FAX/MFC uses the new number to simulate a dedicated fax line.

- ECM (Error Correction Mode)** Detects errors during fax transmission and resends the page(s) of the document that had an error.
- F/T Ring Time** The length of time the FAX/MFC rings (when the answer mode setting is FAX/TEL) to notify you to pick up a voice call that it answered.
- Fax Forwarding** Sends a fax received in memory to another preprogrammed fax number.
- fax tones** The signals sent by sending and receiving fax machines while communicating information.
- Fine Mode** Resolution is 196 x 203 dpi. It is used for small print and graphs.
- gray scale** The shades of gray available for copying and faxing photographs.
- group number** A combination of One Touch and/or Speed Dial numbers that are stored on a One Touch key for Broadcasting.
- ICM (incoming message)** A recorded voice message received into an external answering machine or the digital Message Center.
- Interrupt** Temporarily puts a waiting job on hold while you perform another operation.
- interval** The preprogrammed time period between automatically printed Activity Reports. You can print Activity Reports on demand without interrupting this cycle.
- LCD (liquid crystal display)** The display screen on the FAX/MFC that shows interactive messages during On-Screen Programming and defaults to the date and time when the machine is idle.
- manual fax** When you press **Speaker Phone** —OR— lift the handset so you can hear the receiving fax machine answer before you press **Start** to begin transmission.
- Memory Status List** Shows how much memory is being used, how much is left, and the type of messages in memory.
- memory usage** Instructs the FAX/MFC how to allocate the memory.
- Multi-Function Link Ready** FAX/MFC models that have a PCI/F Port to connect a computer, using the optional hardware/software package called “Missing Link.”
- Next Fax Reservation** Accepts the next document in the document feeder for transmission while the FAX/MFC is still receiving.
- OGM (Out-Going Message)** The message callers hear when you call your Message Center or external answering machine.
- One Touch** Keys on the FAX/MFC control panel where you can store numbers for easy dialing. You must use a separate key for each number.
- Out of Paper Reception** Receives faxes into the FAX/MFC’s memory when the machine is out of paper.

- Overseas Mode** Makes temporary changes to the fax tones to accommodate noise and static on overseas phone lines.
- Paging** Feature enables your fax unit to call your pager when a fax and/or a voice message is received into its memory.
- Pause** Allows you to place a 3.5 second delay in the dialing sequence stored on One Touch and Speed Dial numbers.
- Photo Mode** A resolution setting that uses varying shades of gray for the best representation of photographs.
- polling** The process of a fax machine calling another fax machine to retrieve waiting fax messages.
- Pulse** A form of dialing on a telephone line.
- print reduction** reduces the size of incoming faxes.
- Quick Scan** Enables the FAX/MFC to scan a document into memory before faxing it.
- remote access** The ability to access your Message Center remotely from a touch tone phone.
- remote activation** allows you to transfer a fax call, answered at an extension phone, to the FAX/MFC.
- remote access code** The four-digit code that allows you to call and access your Message Center from a remote location.
- resolution** The number of vertical and horizontal lines per inch. See: Standard, Super Fine and Photo.
- Rotary** A form of dialing on a telephone line.
- scanning** The process of sending an electronic image of an original paper document into your computer.
- speed dial** A preprogrammed number for easy dialing. You must press the **[Speed Dial]** key and then two digit code to start the dialing process.
- Standard resolution** 98 x 203 dpi. It is used for regular size text and quickest transmission.
- Station ID** The stored information that appears on the top of faxed pages. It includes the sender's name and fax number.
- super fine resolution** 392 x 203 dpi. Best for very small print and line art.
- Tel Index** An electronic, alphabetical listing of stored One Touch, Speed Dial and Group numbers.
- thermal transfer** A printing process in which heat transfers carbon ink from a ribbon to plain paper.
- Toll Saver** A Message Center setting that allows the FAX/MFC to answer after two rings when a message(s) was received and after four rings when there are no messages. The caller can hang up (after two rings) without paying for the call if there are no messages to retrieve.

Tone A form of dialing on the telephone line used for Touch Tone telephones.

transmission The process of sending documents over the phone lines from your FAX/MFC to the receiving fax machine.

User Option List A printed report that shows the current settings of your FAX/MFC.

Xmit Report (Transmission Report) A listing of each transmission, showing caller ID, date, time, and number of pages.

Specifications

Type	Desktop facsimile transceiver
Compatibility	ITU-TS Group 3
Coding system	Modified Huffman (MH)
Modem speed	14,400/12,000/9600/7200/4800/2400; Automatic Fallback
Document input width	5.8 inches to 8.5 inches (148 mm to 216 mm)
Scanning/Printing width	8.2 inches (208 mm)
Paper Cassette	200 Sheets (20 lbs.)
Printer type	Line Thermal with Ribbon
Gray scale	64 levels
Display	LCD, 16 characters
Polling types	Standard, Sequential
Contrast control	Automatic/Super Light/Super Dark (manual setting)
Resolution	<ul style="list-style-type: none"> • Horizontal 203 dot/inch (8 dot/mm) • Vertical Standard — 98 line/inch (3.85 line/mm) <li style="padding-left: 2em;">Fine, Photo — 196 line/inch (7.7 line/mm) <li style="padding-left: 2em;">Superfine, Photo (copy) — 392 line/inch (15.4 line/mm)
Memory Capacity	MFC 1870MC — 512 KB (up to 20 pages*) FAX 1570MC, MFC 1970MC — 1 MB (up to 50 pages*)
One touch dial	24
Speed-dial	36 stations (MFC 1870MC), 100 stations (FAX 1570MC, MFC 1970MC)
Automatic redial	3 times at 5 minute intervals
Speaker type	Full Duplex
Auto answer	0, 1, 2, 3 or 4 rings
Communication source	Public switched telephone network
Operating environment	41 - 95° F
Power source	120V AC 50/60Hz (USA, Canadian Version Only)
Power consumption	Standby: under 10 watts — Peak: under 110 watts
Dimensions	15.2 x 15.0 x 8.4 inches / 385 x 378 x 213 (mm)
Weight	12.3 lb / 5.6 kg

* "Pages" refers to the "Brother Standard chart no. 1" (a typical business letter, Standard resolution).
Specifications are subject to change for improvement without prior notice.

Index

A

Accessories 127
 Activation Code 16, 35, 50, 51
 Activity Report 27, 83, 84
 ADF 31
 ALL DIAL List 27, 83
 Alternating Displays 26
 Answer Mode 14, 33, 34, 35
 Assembly 7
 AUTO DIAL 21
 Automatic Document Feeder (ADF) 31
 Automatic Transmission 33

B

Backup printing 64
 Beeper 24, 27
 Beeps 68, 70, 71
 Broadcasting 23, 24, 45
 Brother Bulletin Board 93, 126
 Brother Customer Service 96, 97, 126
 Brother Fax-Back System 20, 93, 94, 126
 Brother Home Page 93, 126

C

Call Back Message 20, 48, 49, 83
 CALL PICKUP 53
 Call Reservation 26, 37, 48, 49
 Caller ID 27, 28, 53
 Canceling 26, 45
 Chain Dialing 21, 22, 49
 Cleaning 95, 97
 Clearing Caller ID 54

Connecting 2, 10, 11, 14, 15
 Contrast 26, 32
 Control Panel 3, 4
 Copy 26, 32, 57
 Corrections 19
 Cover Page 18, 20, 21, 26, 27, 28,
 46, 47, 48, 83
 Custom Telephone Features 14

D

D/R SET MODE 52
 Daily Timer 28, 43
 Date and Time 17, 18, 28
 Deactivation Code 50, 51
 Delayed Transmission 44
 Distinctive Ringing 28, 33, 51, 52
 Document 31, 32
 Document Size and Resolution 31, 32
 Double Ringing 36

E

Easy Receive 28, 34, 35
 Energy Star Compliance 86
 Enlarged Copies 57
 Entering Text 18, 19
 Erasing Message 64, 65
 Error Messages 94, 95, 96, 97
 Error Re-Transmission 27, 46
 Extension Cord 88
 Extension Telephone 33, 34, 50, 99
 External Telephone 16

F

F/T (Fax/Tel) Mode	2, 28, 33, 35, 36, 37, 50, 52, 99
F/T (Fax/Tel) Ring Time	28, 33, 36, 50
Fax Forwarding	29, 66, 67, 71
Fax Tones and Handshake	2
Fax-Back System	20, 93, 126
FCC Notices	85, 86, 87
Fine Resolution	32, 98
Flexible Memory Settings	60
Function	25
Function Selection Table	26, 27, 28, 29

G

Gray Scale	118, 121
Group Number	23, 24, 45

H

HELP	1, 26
Hold	3, 4, 40

I

Inserting Spaces	19
Installation	5
Interrupting	44
Interval	2, 28, 84
ICM Recording Monitor	66

J

Jacks	11, 12, 98
Jam	31, 94, 95

L

Loading Paper	9
---------------------	---

M

Maintenance	93
Manual Dial	39
Manual Mode	33, 98
Manual Transmission	32
Maximum Message Time	65, 66, 75, 78
Memo	63, 66
Memory	7, 22, 41
Memory Full Message	43
Memory Status List	70
Memory Storage	24
Message Center Mode	59, 62
Message Center Pro	73
Message Storage	61
MSG CTR OGM	61
Multi-Function Link (for MFC 1870MC and 1970MC)	101, 102, 108
Multi-Function Link (option)	115
Multiple Resolution	50

N

Next-Fax Reservation	49
----------------------------	----

O

On-Screen Programming	25
One Touch List	83
One Touch Dialing	20, 21, 23, 27, 32, 33, 40, 41, 46, 49, 55, 96
OUT-OF-AREA	53
Outgoing Message (OGM)	61, 62, 76
Overseas Mode	26, 45

P

Packing List	6
Paging	29, 66, 67
Paper	27, 37
Paper Size	37, 38
Password	76
Pause	20, 21, 40

Personal Mailbox 65, 73, 76
 Personal Mailbox memo 78
 Personal Mailbox Remote Retrieval 78
 PBXs 13
 Photo 32, 56
 PIN 66, 67
 Playing Messages 63
 Poll Waiting 49, 55
 Polling 26, 49, 54, 55
 Power 10, 88, 89
 Power Failure 17, 22, 24
 Printing 29, 48, 63, 64, 83, 84
 Printing Message 63
 Program Fax Forward Number 67
 Program Paging Number 67
 PRIVATE CALL 53

Q

Quick Scan 43

R

Receiving Faxes 33, 50
 Recording Conversation 66
 Recording Memo 66
 Recording Monitor 66
 Redial 33, 49
 Reduction 27, 37, 38
 Remote Access Code 68, 69, 70, 71
 Remote Activation 16, 50, 51, 99
 Remote Code 28, 51
 Remote Commands 69
 Remote Deactivation 50, 51
 Remote Message Retrieval 70
 Reports 27, 83
 Resolution 26, 32, 49, 50, 56, 98
 Ring Delay 15, 28, 33, 35, 36
 Ring Pattern 52
 Ring Volume 28, 37
 Roll Over Phone Lines 11

S

Safety Instructions 88, 89
 Scanning Document 113
 Scroll 25
 Sending Faxes 43
 Setting Up 5
 Smoothing 27, 37
 Sort 56, 57
 Speaker Volume 28, 36
 Special Characters 18, 19
 Specifications 121
 Speed Dial 22, 23, 27
 Stack 57
 Standard Resolution 32
 Station ID 1, 18, 20, 28, 46, 49
 Super Fine Resolution 32

T

Telephone Answering Device (TAD) 2, 12, 14,
 15, 16
 Telephone Index 41, 83
 Telephone Notices 85, 86, 87
 Temporary Cover Page 47, 48
 Test Sheet Procedure 1
 Timer 26, 43, 44
 Tone/Pulse 17, 28, 98
 Transmission Verification Report 83, 98
 Troubleshooting 93
 Two-Line Phone System 11, 12
 Two-Line Telephone Answering Device (TAD) 12

U

User Options 27, 83

V

Viewing faxes (PC) 112
 Viewing On -Line Documentation 105
 Voice Calls 39
 Voice On Demand 73, 74, 79

Volume 62, 63, 66

W

Warranties 90

Windows® 3.1 or 3.11 102, 104

Windows® 95 102, 104

Windows® NT Workstation Version 4.0 102, 104

World Wide Web 93, 103, 126

Brother Numbers

Fax-Back System

Brother Customer Service has installed an easy-to-use Fax-Back System, so you can get instant answers to common technical questions and product information for all Brother products. This system is available 24 hours a day, 7 days a week. You can use the system to send faxes to any fax machine, not just the one from which you are calling.

If you can't resolve difficulty with your FAX/MFC using this manual, call our Fax-Back System, and follow the voice prompts to receive faxed instructions about using the system, and an index of Fax-Back subjects.

USA: *1-800-521-2846*

From within Canada: *1-800-681-9838*

The Brother Fax-Back System number (USA only) has been preprogrammed on One Touch key **01**.

Brother on the World Wide Web

You can find more information about Brother products, from product specification sheets to Frequently Asked Questions (FAQs), on the World Wide Web. Visit us at

<http://WWW.brother.com>

Brother Bulletin Board

Brother's Bulletin Board Numbers are

USA: *1-888-298-3616*

From within Canada: *1-514-685-2040*

For Customer Service

USA: *1-800-284-4329 (voice)*

1-908-575-8790 (fax)

From within Canada: *1-800-853-6660 (voice)*

1-514-685-4898 (fax)

From within Montreal: *1-514-685-6464 (voice)*

Ordering Accessories and Supplies

For the best quality results use only genuine Brother accessories, available at most Brother retailers. If you cannot find the accessory you need and you have a Visa, MasterCard, Discover or American Express credit card, you can order accessories directly from Brother.

USA:

1-888-879-3232 (voice)

1-800-947-1445 (fax)

www.brothermall.com

From within Canada:

1-800-668-2768 (voice)

DESCRIPTION	ITEM
Printing Cartridge	PC 201
2-PK Refill Rolls	PC 202 RF
4-PK Refill Rolls	PC 204 RF
Telephone Line Cord	Tell the Brother Representative your Model number so you get the appropriate color.
Telephone Handset	Tell the Brother Representative your Model number so you get the appropriate color.
Handset Curled Cord	Tell the Brother Representative your Model number so you get the appropriate color.
Paper Wire Extension	UL6856001
Document Support	UF8048001
Paper Support	UF8247001
Owner's Manual	UF8209001
Multi-Function Link/Missing Link Options for FAX 1570MC	PCI-1
* For MFC 1870MC and MFC 1970MC, Multi-Function Link Option on Floppy Disks, (Includes MFL and Visioneer PaperPort Only)	MFL2D31 (Floppy Disks for Windows® 3.1X) MFL2D95 (Floppy Disks for Windows® 95)

* Software on Floppy disks for the MFC 1870MC and MFC 1970MC is not available for Windows NT® Workstation Version.



Brother International Corporation
100 Somerset Corporate Boulevard
P.O.Box 6911
Bridgewater, NJ 08807-0911 USA

Brother International Corporation (Canada) Ltd.
1 rue Hôtel de Ville,
Dollard-des-Ormeaux, QC, CANADA H9B 3H6

Visit us on the World Wide Web
<http://www.brother.com>

These machines are made for use in the USA or CANADA only. We can not recommend using them overseas because it may violate the Telecommunications Regulations of that country and the power requirements of your fax machine may not be compatible with the power available in foreign countries. **Using USA or CANADA models overseas is at your own risk and will void your warranty.**

UF8322001①
Printed in Malaysia

Free Manuals Download Website

<http://myh66.com>

<http://usermanuals.us>

<http://www.somanuals.com>

<http://www.4manuals.cc>

<http://www.manual-lib.com>

<http://www.404manual.com>

<http://www.luxmanual.com>

<http://aubethermostatmanual.com>

Golf course search by state

<http://golfingnear.com>

Email search by domain

<http://emailbydomain.com>

Auto manuals search

<http://auto.somanuals.com>

TV manuals search

<http://tv.somanuals.com>