

FAX-575

brother.

If you need to call Customer Service

Please complete the following information for future reference:

Model Number: FAX-575

Serial Number:* _____

Date of Purchase: _____

Place of Purchase: _____

* The serial number is on the back of the unit. Retain this User's Guide with your sales receipt as a permanent record of your purchase, in the event of theft, fire or warranty service.

Register your product on-line at

<http://www.brother.com/registration>

By registering your product with Brother, you will be recorded as the original owner of the product.

Your registration with Brother:

- may serve as confirmation of the purchase date of your product should you lose your receipt;
- may support an insurance claim by you in the event of product loss covered by insurance; and,
- will help us notify you of enhancements to your product and special offers.

The most convenient and efficient way to register your new product is on-line at <http://www.brother.com/registration>

Brother numbers

IMPORTANT

For technical help, you must call the country where you bought the fax machine. Calls must be made **from within** that country.

Register your product (USA only)

By registering your product with Brother International Corporation, you will be recorded as the original owner of the product.

Your registration with Brother:

- may serve as confirmation of the purchase date of your product should you lose your receipt;
- may support an insurance claim by you in the event of product loss covered by insurance; and,
- will help us notify you of enhancements to your product and special offers.

Please complete and fax the Brother Warranty Registration and Test Sheet, or for your convenience and most efficient way to register your new product, register on-line at

<http://www.brother.com/registration>

Frequently Asked Questions (FAQs)

You can find more information about Brother products on the World Wide Web. From product specification sheets to Frequently Asked Questions (FAQs), it is all there. Visit us at:

<http://www.brother.com>

For Customer Service

In USA: 1-800-284-4329 (voice)
1-901-379-1215 (fax)
1-800-284-3238
(TTY service for the hearing-impaired)

In Canada: 1-877-BROTHER (voice)
(514) 685-4898 (fax)

Service Center Locator (USA only)

For the location of a Brother authorized service center, call 1-800-284-4357.

Service Center Locations (Canada only)

For the location of a Brother authorized service center, call 1-877-BROTHER.

Brother fax back system (USA only)

Brother has installed an easy-to-use fax back system, so you can get instant answers to common technical questions and product information for all Brother products. This system is available 24 hours a day, 7 days a week. You can use the system to receive faxed instructions and an Index of fax back subjects.

In USA only: 1-800-521-2846

Ordering accessories and supplies

For best quality results use only genuine Brother accessories, which are available at most Brother retailers. If you cannot find the accessory you need and you have a Visa, MasterCard, Discover, or American Express credit card, you can order accessories directly from Brother. (In the USA, you can visit us online for a complete selection of the Brother accessories and supplies that are available for purchase.)

In USA: 1-888-879-3232 (voice)
1-800-947-1445 (fax)

<http://www.brothermall.com>

In Canada: 1-877-BROTHER (voice)

DESCRIPTION	ITEM
Print Cartridge and a Refill (1 set per box)	PC-501
2 Refills for use in PC-501 Print Cartridge	PC-402RF
Telephone Line Cord	LG3077001
Telephone Handset	LF3800002
Handset Curled Cord	LG3768004
Paper Wire Extension	LF3814001
Document Support	LF8268001
Paper Tray	LF3926001
User's Guide	LF3929001
Surge Protection Device with Telephone Line Protection (2 outlets)	QPD 120
Surge Protection Device with Telephone Line Protection (8 outlets)	FX 120

Notice - Disclaimer of Warranties (USA and Canada)

BROTHER'S LICENSOR(S), AND THEIR DIRECTORS, OFFICERS, EMPLOYEES OR AGENTS (COLLECTIVELY BROTHER'S LICENSOR) MAKE NO WARRANTIES, EXPRESS OR IMPLIED, INCLUDING WITHOUT LIMITATION THE IMPLIED WARRANTIES OF MERCHANTABILITY AND FITNESS FOR A PARTICULAR PURPOSE, REGARDING THE SOFTWARE. BROTHER'S LICENSOR(S) DOES NOT WARRANT, GUARANTEE OR MAKE ANY REPRESENTATIONS REGARDING THE USE OR THE RESULTS OF THE USE OF THE SOFTWARE IN TERMS OF ITS CORRECTNESS, ACCURACY, RELIABILITY, CURRENTNESS OR OTHERWISE. THE ENTIRE RISK AS TO THE RESULTS AND PERFORMANCE OF THE SOFTWARE IS ASSUMED BY YOU. THE EXCLUSION OF IMPLIED WARRANTIES IS NOT PERMITTED BY SOME STATES IN THE USA AND SOME PROVINCES IN CANADA. THE ABOVE EXCLUSION MAY NOT APPLY TO YOU.

IN NO EVENT WILL BROTHER'S LICENSOR(S) BE LIABLE TO YOU FOR ANY CONSEQUENTIAL, INCIDENTAL OR INDIRECT DAMAGES (INCLUDING DAMAGES FOR LOSS OF BUSINESS PROFITS, BUSINESS INTERRUPTION, LOSS OF BUSINESS INFORMATION, AND THE LIKE) ARISING OUT OF THE USE OR INABILITY TO USE THE SOFTWARE EVEN IF BROTHER'S LICENSOR HAS BEEN ADVISED OF THE POSSIBILITY OF SUCH DAMAGES. BECAUSE SOME STATES IN THE USA AND SOME PROVINCES IN CANADA DO NOT ALLOW THE EXCLUSION OR LIMITATION OF LIABILITY FOR CONSEQUENTIAL OR INCIDENTAL DAMAGES, THE ABOVE LIMITATIONS MAY NOT APPLY TO YOU. IN ANY EVENT BROTHER'S LICENSOR'S LIABILITY TO YOU FOR ACTUAL DAMAGES FROM ANY CAUSE WHATSOEVER, AND REGARDLESS OF THE FORM OF THE ACTION (WHETHER IN CONTRACT, TORT (INCLUDING NEGLIGENCE), PRODUCT LIABILITY OR OTHERWISE), WILL BE LIMITED TO \$50.

Compilation and Publication Notice

Under the supervision of Brother Industries Ltd., this User's Guide has been compiled and published, covering the latest product descriptions and specifications.

The contents of this User's Guide and the specifications of this product are subject to change without notice.

Brother reserves the right to make changes without notice in the specifications and materials contained herein and shall not be responsible for any damages (including consequential) caused by reliance on the materials presented, including but not limited to typographical and other errors relating to the publication.

Brother® One Year Limited Warranty and Replacement Service (USA only)

Who is covered:

- This limited warranty ("warranty") is given only to the original end-use/retail purchaser (referred to in this warranty as "Original Purchaser") of the accompanying product, consumables and accessories (collectively referred to in this warranty as "this Product").
- If you purchased a product from someone other than an authorized Brother reseller in the United States or if the product was used (including but not limited to floor models or refurbished product), prior to your purchase you are not the Original Purchaser and the product that you purchased is not covered by this warranty.

What is covered:

- This Product includes a Machine and Consumable and Accessory Items. Consumable and Accessory Items include but are not limited to print heads, toner, drums, ink cartridges, print cartridges, refill ribbons, therma PLUS paper and thermal paper.
- Except as otherwise provided herein, Brother warrants that the Machine and the accompanying Consumable and Accessory Items will be free from defects in materials and workmanship, when used under normal conditions.
- This warranty applies only to products purchased and used in the United States. For products purchased in, but used outside, the United States, this warranty covers only warranty service within the United States (and does not include shipping outside the United States).

What is the length of the Warranty Periods:

- Machines: one year from the original purchase date.
- Accompanying Consumable and Accessory Items: 90 days from the original purchase date or the rated life of consumable, whichever comes first.

What is NOT covered:

This warranty does not cover:

- (1) Physical damage to this Product;
- (2) Damage caused by improper installation, improper or abnormal use, misuse, neglect or accident (including but not limited to transporting this Product without the proper preparation and/or packaging);
- (3) Damage caused by another device or software used with this Product (including but not limited to damage resulting from use of non Brother®-brand parts and Consumable and Accessory Items);
- (4) Consumable and Accessory Items that expired in accordance with a rated life; and,
- (5) Problems arising from other than defects in materials or workmanship.
- (6) Normal Periodic Maintenance Items, such as Paper Feeding Kit, Fuser and Laser Units.

This limited warranty is VOID if this Product has been altered or modified in any way (including but not limited to attempted warranty repair without authorization from Brother and/or alteration/removal of the serial number).

What to do if you think your Product is eligible for warranty service:

Report your issue to either our Customer Service Hotline at 1-800-284-4329 for Fax, MFC and DCP and 1-800-276-7746 for Printers, or to a Brother Authorized Service Center within the applicable warranty period. Supply Brother or the Brother Authorized Service Center with a copy of your dated bill of sale showing that this Product was purchased within the U.S. For the name of local Brother Authorized Service Center(s), call 1-800-521-2846.

What Brother will ask you to do:

After contacting Brother or a Brother Authorized Service Center, you may be required to deliver (by hand if you prefer) or send the Product properly packaged, freight prepaid, to the Authorized Service Center together with a photocopy of your bill of sale. **You are responsible for the cost of shipping, packing product, and insurance (if you desire). You are also responsible for loss or damage to this Product in shipping.**

What Brother will do:

If the problem reported concerning your Machine and/or accompanying Consumable and Accessory Items is covered by this warranty and if you first reported the problem to Brother or an Authorized Service Center within the applicable warranty period, Brother or its Authorized Service Center will repair or replace the Machine and/or accompanying Consumable and Accessory Items at no charge to you for parts or labor. The decision as to whether to repair or replace the Machine and/or accompanying Consumable and Accessory Items is made

Brother® One Year Limited Warranty and Replacement Service (USA only)

by Brother in its sole discretion. Brother reserves the right to supply a refurbished or remanufactured replacement Machine and/or accompanying Consumable and Accessory Items and use refurbished parts provided such replacement products conform to the manufacturer's specifications for new product/parts. The repaired or replacement Machine and/or accompanying Consumable and Accessory Items will be returned to you freight prepaid or made available for you to pick up at a conveniently located Authorized Service Center.

If the Machine and/or accompanying Consumable and Accessory Items are not covered by this warranty (either stage), you will be charged for shipping the Machine and/or accompanying Consumable and Accessory Items back to you and charged for any service and/or replacement parts/products at Brother's then current published rates.

The foregoing are your sole (i.e., only) and exclusive remedies under this warranty.

What happens when Brother elects to replace your Machine:

When a replacement Machine is authorized by Brother, and you have delivered the Machine to an Authorized Service Center, the Authorized Service Center will provide you with a replacement Machine after receiving one from Brother. If you are dealing directly with Brother, Brother will send to you a replacement Machine with the understanding that you will, after receipt of the replacement Machine, supply the required proof of purchase information, together with the Machine that Brother agreed to replace. You are then expected to pack the Machine that Brother agreed to replace in the package from the replacement Machine and return it to Brother using the pre-paid freight bill supplied by Brother in accordance with the instructions provided by Brother. Since you will be in possession of two machines, Brother will require that you provide a valid major credit card number. Brother will issue a hold against the credit card account number that you provide until Brother receives your original Product and determines that your original Product is entitled to warranty coverage. Your credit card will be charged up to the cost of a new Product only if: (i) you do not return your original Product to Brother within five (5) business days; (ii) the problems with your original Product are not covered by the limited warranty; (iii) the proper packaging instructions are not followed and has caused damage to the product; or (iv) the warranty period on your original Product has expired or has not been sufficiently validated with a copy of the proof of purchase (bill of sale). The replacement Machine you receive (even if refurbished or remanufactured) will be covered by the balance of the limited warranty period remaining on the original Product, plus an additional thirty (30) days. You will keep the replacement Machine that is sent to you and your original Machine shall become the property of Brother. **Retain your original Accessory Items and a copy of the return freight bill, signed by the courier.**

Limitations:

Brother is not responsible for damage to or loss of any equipment, media, programs or data related to the use of this Product. Except for that repair or replacement as described above, Brother shall not be liable for any direct, indirect, incidental or consequential damages or specific relief. Because some states do not allow the exclusion or limitation of consequential or incidental damages, the above limitation may not apply to you.

THIS WARRANTY IS GIVEN IN LIEU OF ALL OTHER WARRANTIES, WRITTEN OR ORAL, WHETHER EXPRESSED BY AFFIRMATION, PROMISE, DESCRIPTION, DRAWING, MODEL OR SAMPLE. ANY AND ALL WARRANTIES OTHER THAN THIS ONE, WHETHER EXPRESS OR IMPLIED, INCLUDING IMPLIED WARRANTIES OF MERCHANTABILITY AND FITNESS FOR A PARTICULAR PURPOSE, ARE HEREBY DISCLAIMED.

- This Limited Warranty is the only warranty that Brother is giving for this Product. It is the final expression and the exclusive and only statement of Brother's obligations to you. It replaces all other agreements and understandings that you may have with Brother or its representatives.
- This warranty gives you certain rights and you may also have other rights that may vary from state to state.
- This Limited Warranty (and Brother's obligation to you) may not be changed in any way unless you and Brother sign the same piece of paper in which we (1) refer to this Product and your bill of sale date, (2) describe the change to this warranty and (3) agree to make that change.

Important: *We recommend that you keep all original packing materials, in the event that you ship this Product.*

© 2003 Brother International Corporation

BROTHER MULTIFUNCTION CENTER/FACSIMILE MACHINE LIMITED WARRANTY (Canada only)

Pursuant to this limited warranty of 1 year from the date of purchase for labour and parts, Brother International Corporation (Canada) Ltd. ("Brother"), or its Authorized Service Centers, will repair this MFC/Facsimile machine free of charge if defective in material or workmanship. This Limited Warranty does not include cleaning, consumables (including, without limitation, print cartridges, print head, toner and drum) or damage caused by accident, neglect, misuse or improper installation or operation, any damage caused from service, maintenance, modifications, or tampering by anyone other than a Brother Authorized Service Representative, or from the use of supplies or consumable items that are non-Brother products. Operation of the MFC/Facsimile machine in excess of the specifications or with the Serial Number or Rating Label removed shall be deemed abuse and all repairs thereafter shall be the sole liability of the end-user/purchaser. In order to obtain warranty service, the MFC/Facsimile machine must be delivered or shipped freight prepaid by the end user/purchaser to a "Brother" Authorized Service Center, together with your Proof of Purchase in the form of a Sales Receipt.

For laser products: Failure to remove the Toner Cartridge (and Toner Drum Unit on applicable models) during shipping will cause severe damage to the MFC/Facsimile and will VOID the Warranty. (Refer to your User's Guide for proper packaging.)

For ink-jet products: Do not remove the ink cartridges during shipping. Damage to your print head resulting from packing without the ink cartridges will VOID your warranty. (Refer to your User's Guide for proper packaging.)

BROTHER DISCLAIMS ALL OTHER WARRANTIES EXPRESSED OR IMPLIED INCLUDING, WITHOUT LIMITATION, ANY IMPLIED WARRANTIES OF MERCHANTABILITY OR FITNESS FOR A PARTICULAR PURPOSE, EXCEPT TO THE EXTENT THAT ANY WARRANTIES IMPLIED BY LAW CANNOT BE VALIDLY WAIVED.

No oral or written information, advice or representation provided by Brother, its Authorized Service Centers, Distributors, Dealers, Agents or employees, shall create another warranty or modify this warranty. This warranty states Brother's entire liability and your exclusive remedy against Brother for any failure of the MFC/Facsimile machine to operate properly.

Neither Brother nor anyone else involved in the development, production, or delivery of this MFC/Facsimile machine shall be liable for any indirect, incidental, special, consequential, exemplary, or punitive damages, including lost profits, arising from the use of or inability to use the product, even if advised by the end user/purchaser of the possibility of such damages. Since some Provinces do not allow the above limitation of liability, such limitation may not apply to you.

This Limited Warranty gives you specific legal rights and you may also have other rights which vary from Province to Province.

Warranty Service is available at Brother Authorized Service Centers throughout Canada. For Technical Support or for the name and location of your nearest Authorized Service Center call 1-877-BROTHER.

**Internet support: support@brother.ca or browse
Brother's Web Site: www.brother.com**

Brother International Corporation (Canada) Ltd.
1 Rue Hôtel de Ville
Dollard-Des-Ormeaux, QC H9B 3H6





At your side.
brother®

Safety precautions

To use the fax machine safely

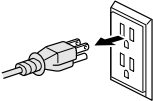
Please refer to these instructions for later reference and before attempting any maintenance.

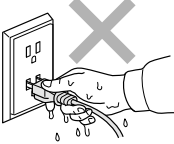
WARNING

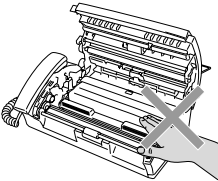
	<p>There are high voltage electrodes inside the fax machine. Before you clean the fax machine, make sure you have unplugged the telephone line cord first and then the power cord from the AC power outlet.</p>	
	<p>Do not handle the plug with wet hands. Doing this might cause an electrical shock.</p>	
	<p>After you have just used the fax machine, some internal parts are extremely HOT! Please be careful.</p>	

WARNING

- Use caution when installing or modifying telephone lines. Never touch telephone wires or terminals that are not insulated unless the telephone line has been disconnected at the wall jack. Never install telephone wiring during a lightning storm. Never install a telephone jack in a wet location.
- This product must be installed near an AC power outlet that is easily accessible. In case of emergencies, you must disconnect the power cord from the AC power outlet to shut off power completely.
- To reduce the risk of shock or fire, use only a No.26 AWG or larger telecommunication line cord.

WARNING

IMPORTANT SAFETY INSTRUCTION

When using your telephone equipment, basic safety precautions should always be followed to reduce the risk of fire, electric shock and injury to persons, including the following:



1. Do not use this product near water, for example, near a bath tub, wash bowl, kitchen sink or washing machine, in a wet basement or near a swimming pool.
2. Avoid using this product (other than a cordless type) during an electrical storm. There may be a remote risk of electric shock from lightning.
3. Do not use this product to report a gas leak in the vicinity of the leak.

SAVE THESE INSTRUCTIONS

Choosing a location

Place the fax machine on a flat, stable surface that is free of vibration and shocks, such as a desk. Put the fax machine near a telephone wall jack and a standard, grounded AC power outlet. Choose a location where the temperature remains between 50°F and 95°F (10°-35°C).



Caution

- Avoid placing the fax machine in a high-traffic area.
- Do not place near heaters, air conditioners, water, chemicals, or refrigerators.
- Do not expose the fax machine to direct sunlight, excessive heat, moisture, or dust.
- Do not connect the fax machine to electrical outlets controlled by wall switches or automatic timers.
- Disruption of power can wipe out information in the fax machine's memory.
- Do not connect the fax machine to electrical outlets on the same circuit as large appliances or other equipment that might disrupt the power supply.
- Avoid interference sources, such as speakers or the base units of cordless phones.

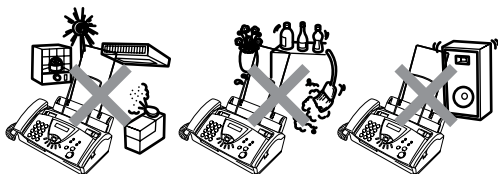

Quick Reference Guide

Sending faxes

Automatic transmission

- 1 Insert the document face down in the ADF (up to 10 pages).
- 2 Enter the fax number you want to call.
- 3 Press **Fax Start**.

Receiving faxes

Select Receive Mode

- 1 Press **Receive Mode** to select **FAX ONLY**, **FAX/TEL**, **TAD:ANSWER MACH.** or **MANUAL**. If you select **FAX/TEL**, make sure you set Ring Delay and F/T Ring Time. (See *Setting the Ring Delay* on page 5-2 and *Setting the F/T Ring Time (FAX/TEL mode only)* on page 5-3.)

Storing numbers

Storing One-Touch Dial numbers

- 1 Press **Menu/Set**, **6**, **1**.
- 2 Press a One-Touch key where you want to store a number.
- 3 Enter a number (up to 20 digits), and then press **Menu/Set**.
- 4 Enter a name (up to 15 characters) or leave it blank, and then press **Menu/Set**.
- 5 Press **▲** or **▼** to select the type of number and press **Menu/Set**.
- 6 Press **Stop/Exit**.

Storing Speed-Dial numbers

- 1 Press **Menu/Set**, **6**, **2**.
- 2 Using the dial pad, enter a two-digit Speed-Dial location number (00-99), and then press **Menu/Set**.
- 3 Enter a number (up to 20 digits), and then press **Menu/Set**.
- 4 Enter a name (up to 15 characters) or leave it blank, and then press **Menu/Set**.
- 5 Press **▲** or **▼** to select the type of number and press **Menu/Set**.
- 6 Press **Stop/Exit**.

Dialing operations

One-Touch Dialing

- 1 Insert the document face down in the ADF.
- 2 Press the One-Touch key of the number you want to call.
- 3 Press **Fax Start**.

Speed-Dialing

- 1 Insert the document face down in the ADF.
- 2 Press **Search/Speed-Dial**, then press **#** and the two-digit Speed-Dial number.
- 3 Press **Fax Start**.

Using Search

- 1 Insert the document face down in the ADF.
- 2 Press **Search/Speed Dial** and use the dial pad to enter the first letter of the name you are looking for.
- 3 Press ◀ or ▶ to search the memory.
- 4 Press **Fax Start**, when the LCD shows the name you want to call.

Making copies

Making a single copy

- 1 Insert the document face down in the ADF.
- 2 Press **Copy/Reports** twice.

Sorting multiple copies

- 1 Insert the document face down in the ADF.
- 2 Press **Copy/Reports**.
- 3 Enter the number of copies you want (up to 99).
- 4 Press **Menu/Set**.
- 5 Press ▲ or ▼ to select **SORT**, and then press **Copy/Reports**.

Table of Contents

1 Introduction

Using this Guide	1-1
Finding information	1-1
Fax Test Sheet and Product Registration (USA only).....	1-2
Part names	1-3
Control panel overview	1-4
About fax machines	1-6
Custom features	1-6
Fax tones and handshake	1-7
ECM (Error Correction Mode).....	1-7
Connections.....	1-8
Connecting an external telephone	1-8
Connecting an external telephone answering device (TAD).....	1-8
Special line considerations	1-11
Multi-Line connections (PBX)	1-13
Custom features on your phone line.....	1-13

2 Paper

About paper	2-1
Handling and using plain paper	2-1
How to load paper.....	2-2

3 On-Screen Programming

User-friendly programming	3-1
Menu table	3-1
Memory Storage	3-1
Navigation keys	3-2

4 Initial Setup

Getting started	4-1
Setting the Date and Time	4-1
Turning on Automatic Daylight Savings Time.....	4-1
Setting the Station ID.....	4-2
Setting the Beeper Volume	4-4
Setting the Speaker Volume	4-4
Choosing the Handset Volume (For Volume Amplify)	4-4
Setting Volume Amplify.....	4-5
Setting the Ring Volume	4-6
Setting Tone and Pulse dialing mode (Canada Only).....	4-6
Setting up your area code (USA only)	4-6

5 Setup Receive

Basic receiving operations	5-1
Choosing the Receive Mode.....	5-1
Setting the Ring Delay	5-2
Setting the F/T Ring Time (FAX/TEL mode only)	5-3
Easy Receive	5-3
Printing a reduced incoming fax (Auto Reduction)	5-4
Setting Paper Size	5-4
Receiving a fax at the end of a conversation.....	5-4
Advanced receiving operations.....	5-5
Operation from extension telephones.....	5-5
For FAX/TEL mode only	5-5
Using a cordless external handset.....	5-5
Changing the remote codes	5-6
Printing a fax from the memory	5-6
Polling.....	5-6
Telephone services.....	5-8
Distinctive Ring	5-8
Registering the Distinctive Ring pattern.....	5-9
Caller ID	5-10
Call Waiting/Caller ID.....	5-13

6 Setup Send

How to dial	6-1
Manual dialing.....	6-1
One-Touch dialing	6-1
Speed-Dialing	6-1
Search	6-1
Fax Redial	6-2
How to fax.....	6-2
Automatic transmission.....	6-2
Manual transmission	6-3
Sending a fax at the end of a conversation	6-3
Basic sending operations.....	6-3
Sending faxes using multiple settings.....	6-3
Contrast	6-4
Fax resolution	6-4
Multiple Resolution Transmission	6-5
Canceling a fax in progress	6-5
Canceling a scheduled job.....	6-5
Advanced sending operations	6-6
Composing the electronic Cover Page	6-6
Broadcasting.....	6-8
Overseas Mode	6-8
Call Reservation	6-9
Delayed Fax.....	6-10
Setting up Polled Transmit	6-11
Memory Transmission	6-12
Out of Memory message	6-12
Interrupting Delayed Fax and Polled Transmit jobs.	6-13

7 Quick-Dial numbers and dialing options

Storing numbers for easy dialing	7-1
Storing One-Touch Dial numbers	7-1
Storing Speed-Dial numbers.....	7-2
Changing One-Touch and Speed-Dial numbers.....	7-3
Setting up Groups for Broadcasting.....	7-4
Dialing options	7-5
Manual dialing.....	7-5
One-Touch dialing	7-5
Speed-Dialing	7-6
Access codes and credit card numbers.....	7-6
Search	7-7
Pause.....	7-7
Hold	7-7
Redial (Telephone)	7-7
Redial (Fax)	7-7
Tone or Pulse (Canada only)	7-7

8 Remote Fax Options

Fax Forwarding.....	8-1
Setting up Fax Forwarding.....	8-1
Programming your pager number.....	8-2
Setting Fax Storage	8-3
Turning off Remote Fax Options.....	8-3
Setting your remote access code	8-3
Remote Retrieval	8-4
Using your remote access code	8-4
Remote commands.....	8-5
Retrieving fax messages	8-6
Changing your Fax Forwarding number	8-6

9 Printing reports

FAX settings and activity	9-1
Customizing the Transmission Verification Report	9-1
Setting the Journal Period	9-1
Printing reports	9-2
How to print a report	9-2

10 Making copies

Using the fax machine as a copier.....	10-1
Copy operations.....	10-1
Making a single copy	10-1
Copy options: Single or Multiple copies, Sort/Stack, Reduce/Enlarge	10-2

11 Important information

Standard telephone and FCC Notices	11-1
These notices are in effect on models sold and used in the United States only.	11-1
Federal Communications Commission (FCC) Declaration of Conformity (USA only)	11-2
Important safety instructions.....	11-4

Trademarks.....	11-5
Shipment of the fax machine	11-5

12 Troubleshooting and routine maintenance

Troubleshooting	12-1
Error messages	12-1
Compatibility	12-4
Document Jam or Paper Jam	12-4
If you are having difficulty with the fax machine	12-6
Routine maintenance	12-8
Cleaning the print head.....	12-8
Cleaning the scanner.....	12-9
Changing the ribbon	12-9

G Glossary G-1

S Specifications S-1

General	S-1
Copy	S-1
Fax.....	S-2

I Index I-1

R Remote Retrieval Access Card R-1

1 Introduction

Using this Guide

Throughout this Guide you'll see special symbols alerting you to important warnings, notes and actions. Special fonts identify keys you should press, messages that appear on the LCD, and important points or related topics.

Bold Bold typeface identifies specific keys on the fax machine control panel.

Italics Italicized typeface emphasizes an important point or refers you to a related topic.

`Courier` Courier typeface identifies the messages on the LCD of the fax machine.

 Warnings inform you what to do to avoid possible personal injury.

 Electrical Hazards alert you to a possible electrical shock.

 Cautions specify procedures you must follow or avoid to prevent possible damage to the fax machine.

 Notes tell you how you should respond to a situation that may arise or give tips about how the current operation works with other features.

 Improper Setup alerts you to devices and operations that are not compatible with the fax machine.

Finding information

All the chapter headings and subheadings are listed in the Table of Contents. You will be able to find information about a specific feature or operation by checking the Index at the back of this Guide.

Fax Test Sheet and Product Registration (USA only)

After setting your Station ID, please fill in the Test Sheet included with the fax machine and fax it to Brother's Automated Fax Response System as your first transmission. This will check that your fax machine is working properly.

To get a response, you must have set up your Station ID.
(See *Setting the Station ID* on page 4-2.)

In USA only: 1-877-268-9575 (fax)

When your Test Sheet is received, a Confirmation Sheet and Product Registration form will be sent back to your fax machine. Please fill in the form and return it to complete your registration.

Part names

■ Front view

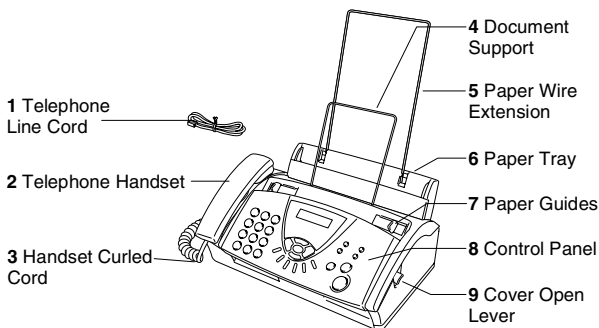

No.	Name	Description
1	Telephone Line Cord	Connect the fax machine to a telephone wall jack.
2	Telephone Handset	Use when receiving or making voice calls.
3	Handset Curled Cord	Use to connect the handset to the fax machine.
4	Document Support	Supports the document in the ADF.
5	Paper Wire Extension	Supports the paper in the paper tray.
6	Paper Tray	Load paper here.
7	Paper Guides	Press and slide to fit the document width.
8	Control Panel	Use the keys and display to control the fax machine.
9	Cover Open Lever	To open the top cover, lift this lever.

■ Back view

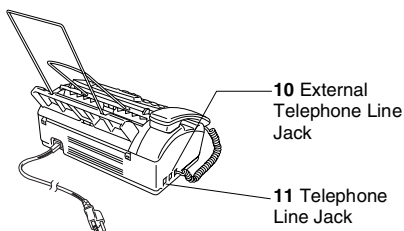

No.	Name	Description
10	External Telephone Line Jack (EXT.)	Plug in the telephone line of an external telephone or TAD here.
11	Telephone Line Jack (LINE)	Plug in the telephone line here.

Control panel overview

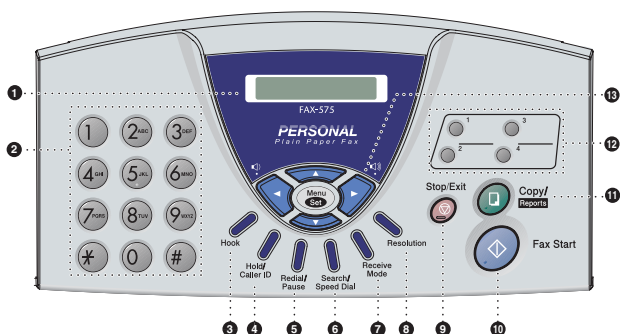

1 LCD (Liquid Crystal Display)

Displays messages on the screen to help you set up and use your fax machine.

2 Dial Pad

Use these keys to dial telephone and fax numbers and as a keyboard for entering information into the fax machine.

The # key lets you temporarily switch the dialing type during a telephone call from "PULSE" to "TONE". (Canada Only)

3 Hook

Lets you dial telephone and fax numbers without lifting the handset.

4 Hold/Caller ID

Lets you place calls on hold. Also, lets you view or print the Caller ID list.

5 Redial/Pause

Redials the last number you called. It also inserts a pause in Quick-Dial numbers.

6 Search/Speed Dial

Lets you look up numbers stored in the dialing memory and lets you dial stored numbers by pressing # and a two-digit number.

7 Receive Mode

Use to select how your fax machine will handle incoming calls.

8 Resolution

Adjusts the resolution when you send a fax or make a copy.

9 Stop/Exit

Stops a fax, cancels an operation or exits from the menu.

10 Fax Start

Starts an operation, such as sending a fax.

11 Copy/Reports

With document in the ADF: Makes a copy. Without document in the ADF: Lets you access the Reports menu.

12 One-Touch Keys

These keys give you instant access to previously stored Quick-Dial numbers.

13 Navigation Keys:

Menu/Set

The same key is used for menu and set operations.

Lets you access the menu to program and store your settings in the fax machine.

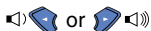

Press to scroll forward or backward to see a menu selection.

—OR—

You can press these keys to adjust the beeper, ring or speaker volume.

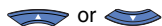

Press to scroll through the menus and options.

You can also use these keys to do a numerical search for stored numbers.

About fax machines

Custom features

Do you have Voice Mail on the phone line?

If you have Voice Mail on the phone line where you will install your new fax machine, there is a strong possibility that Voice Mail and the fax machine may conflict with each other while receiving incoming calls.

Why should there be problems?

Since both the fax machine and Voice Mail will pick up the call after the number of rings you have set, each of them has the ability to keep the other from receiving calls.

For example, if your Voice Mail is set to answer after two rings and the fax machine is set to answer after four, your Voice Mail will stop the fax machine from receiving faxes.

If you set Voice Mail and the fax machine to answer after the same number of rings, there is no way of knowing which one will answer first. It is important to remember that neither Voice Mail nor the fax machine can pass the call back to the other after the call has been answered.

How can you avoid possible problems?

A very good way to avoid problems like the one mentioned, *is to get a second phone number on your present phone line.*

Many people with Voice Mail choose this service, which is called 'Distinctive Ring', and they are very satisfied with it.

(See Distinctive Ring on page 5-8.)

Another way to avoid possible problems is to replace your Voice Mail with an answering machine. Your fax machine is designed to work with an answering machine or TAD (telephone answering device).

(See Connecting an external telephone answering device (TAD) on page 1-8.)

Fax tones and handshake

When someone is sending a fax, the fax machine sends fax calling tones (CNG tones). These are quiet, intermittent beeps every 4-seconds. You'll hear them after you dial and press **Fax Start** and they will continue for about 60 seconds after dialing. During that time, the sending machine must begin the "handshake" with the receiving machine.

Each time you use automatic procedures to send a fax, you are sending CNG tones over the phone line. You'll soon learn to listen for these quiet beeps each time you answer a phone on your fax line, so you will know if you are receiving a fax message.

The receiving fax responds with fax receiving tones, which are loud, chirping sounds. A receiving fax chirps for about 40 seconds over the phone line, and the LCD shows **RECEIVE**.

If the fax machine is set to the **FAX ONLY** mode, it will answer every call automatically with fax receiving tones. If the other person hangs up, the fax machine will continue to send the "chirps" for about 40 seconds, and the LCD continues to show **RECEIVE**. To cancel the receiving, press **Stop/Exit**.

The fax 'handshake' is the time in which the sending machine's CNG tones and the receiving machines "chirps" overlap. This must be for at least 2 to 4 seconds, so the fax machines can understand how each is sending and receiving the fax. The handshake cannot begin until the call is answered, and the CNG tones only last for about 60 seconds after the number is dialed. So it is important for the receiving machine to answer the call in as few rings as possible.



When you have an external Telephone Answering Device (TAD) on your fax line, your TAD will decide the number of rings before the call is answered.

Pay special attention to the directions for connecting a TAD in this chapter. (See *Connecting an external telephone answering device (TAD)* on page 1-8.)

ECM (Error Correction Mode)

The Error Correction Mode (ECM) is a way for the fax machine to check a fax transmission while it is in progress. ECM transmissions are only possible between machines that both have this feature. If they do, you may send and receive fax messages that are continuously being checked by the fax machine.

The fax machine must have enough memory for this feature to work.

Connections

Connecting an external telephone

You can connect a separate telephone (or telephone answering device) directly to your fax machine as shown in the diagram below.

Connect the telephone's line cord to the jack labeled EXT. in the side of the fax machine.

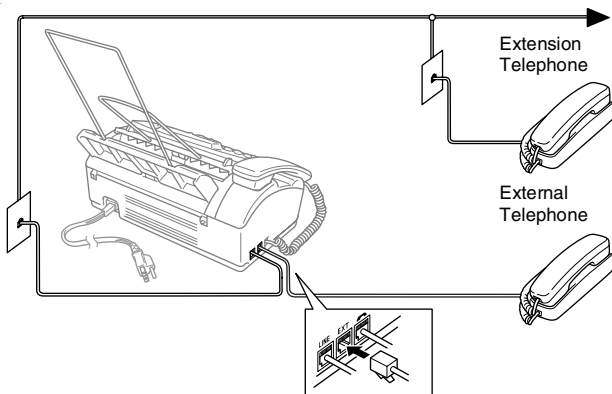

Whenever this phone (or TAD) is in use, the LCD shows **EXT. TEL IN USE**, and, if the fax handset is lifted, an alarm sounds.

To disconnect the call on the external phone and switch to the fax, lift the handset and press **Hook**.

Connecting an external telephone answering device (TAD)

Sequence

You may choose to connect an answering device. However, when you have an **external** TAD on the same telephone line as the fax machine, the TAD answers all calls and the fax machine "listens" for fax calling (CNG) tones. If it hears them, the fax machine takes over the call and receives the fax. If it doesn't hear CNG tones, the fax machine lets the TAD continue playing your outgoing message so your caller can leave you a voice message.

The TAD must answer within four rings (the recommended setting is two rings). The fax machine cannot hear CNG tones until the TAD has answered the call, and with four rings there are only 8 to 10 seconds of CNG tones left for the fax "handshake". Make sure you carefully follow the instructions in this manual for recording your outgoing message. We do not recommend using the toll saver feature on your external answering machine if it exceeds four rings.



If you do not receive all your faxes, you must reset the setting on your external TAD to four rings or less.



If you subscribe to your telephone company's Distinctive Ring service:

You may connect an external TAD to a separate wall jack only if you subscribe to your telephone company's Distinctive Ring service, have registered the distinctive ring pattern on the fax machine, use that number as a fax number and set your fax machine's Receive mode to **MANUAL**. The recommended setting is four rings on the external TAD when you have the telephone company's Distinctive Ring Service.



If you do not subscribe to Distinctive Ring service:

You must plug your TAD into the EXT. jack of the fax machine. If your TAD is plugged into a wall jack, both your fax machine and the TAD will try to control the phone line. (See illustration on page 1-10.)

- ⊘ Unless you are using Distinctive Ring, do not connect a TAD elsewhere on the same phone line.

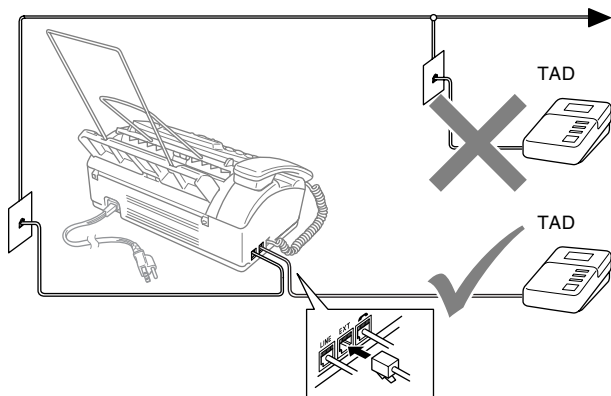

Connections

The external TAD must be plugged into the side of the fax machine, into the jack labeled EXT. The fax machine cannot work properly if you plug the TAD into a wall jack (unless you are using Distinctive Ring).

- 1 Plug the telephone line cord from the wall jack into the back side of the fax machine, in the jack labeled LINE.
- 2 Plug the telephone line cord from your external TAD into the back side of the fax machine, in the jack labeled EXT. (Make sure this cord is connected to the TAD at the TAD's telephone line jack, and not its telephone set jack.)
- 3 Set your external TAD to four rings or less. (The fax machine's Ring Delay setting does not apply.)
- 4 Record the outgoing message on your external TAD.
- 5 Set the TAD to answer calls.
- 6 Set the Receive Mode to `TAD:ANSWER MACH..`
(See *Choosing the Receive Mode* on page 5-1.)

Recording outgoing message (OGM) on an external TAD

Timing is important in recording this message. The message sets up the ways to handle both manual and automatic fax reception.

- 1 Record 5 seconds of silence at the beginning of your message. (This allows the fax machine time to listen for the fax CNG tones of automatic transmissions before they stop.)
- 2 Limit your speaking to 20 seconds.
- 3 End your 20-second message by giving your Fax Receive Code for people sending manual faxes. For example:
"After the beep, leave a message or send a fax by pressing *51 and Start."



We recommend beginning your OGM with an initial 5-second silence because the fax machine cannot hear fax tones over a resonant or loud voice. You may try omitting this pause, but if the fax machine has trouble receiving, then you must re-record the OGM to include it.

Special line considerations

Roll Over phone lines

A roll over phone system is a group of two or more separate telephone lines that pass incoming calls to each other if they are busy. The calls are usually passed down or “rolled over” to the next available phone line in a preset order.

The fax machine can work in a roll over system as long as it is the last number in the sequence, so the call cannot roll away. Do not put the fax machine on any of the other numbers; when the other lines are busy and a second fax call is received, the fax call would be transferred to a line that does not have a fax machine. **The fax machine will work best on a dedicated line.**

Two-Line phone system

A two-line phone system is nothing more than two separate phone numbers on the same wall outlet. The two phone numbers can be on separate jacks (RJ11) or combined into one jack (RJ14). Your fax machine must be plugged into an RJ11 jack. RJ11 and RJ14 jacks may be equal in size and appearance and both may contain four wires (black, red, green, yellow). To test the type of jack, plug in a two-line phone and see if it can access both lines. If it can, you must separate the line for the fax machine.

Converting telephone wall outlets

There are three ways to convert to an RJ11 jack. The first two ways may require assistance from the telephone company. You can change the wall outlets from one RJ14 jack to two RJ11 jacks. Or, you can have an RJ11 wall outlet installed and slave or jump one of the phone numbers to it.

The third way is the easiest: Buy a triplex adapter. You can plug a triplex adapter into an RJ14 outlet. It separates the wires into two separate RJ11 jacks (Line 1, Line 2) and a third RJ14 jack (Lines 1 and 2). If the fax machine is on Line 1, plug the fax machine into L1 of the triplex adapter. If the fax machine is on Line 2, plug it into L2 of the triple adapter.

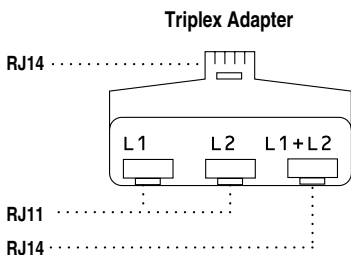

Installing fax machine, external two-line TAD and two-line telephone

When you are installing an external two-line telephone answering device (TAD) and a two-line telephone, the fax machine must be isolated on one line at both the wall jack and at the TAD. The most common connection is to put the fax machine on Line 2, which is explained in the following steps. The back of the two-line TAD must have two telephone jacks: one labeled L1 or L1/L2, and the other labeled L2. You will need at least three telephone line cords, the one that came with the fax machine and two for your external two-line TAD. You will need a fourth line cord if you add a two-line telephone.

- 1 Place the two-line TAD and the two-line telephone next to the fax machine.
- 2 Plug one end of the telephone line cord for the fax machine into the L2 jack of the triplex adapter. Plug the other end into the LINE jack on the back side of the fax machine.
- 3 Plug one end of the first telephone line cord for your TAD into the L1 jack of the triplex adapter. Plug the other end into the L1 or L1/L2 jack of the two-line TAD.
- 4 Plug one end of the second telephone line cord for your TAD into the L2 jack of the two-line TAD. Plug the other end into the EXT. jack on the left side of the fax machine.

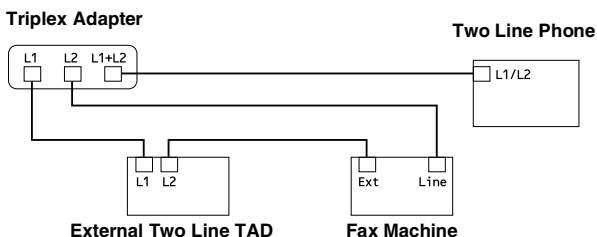

You can keep two-line telephones on other wall outlets as always. There are two ways to add a two-line telephone to the fax machine's wall outlet. You can plug the telephone line cord from the two-line telephone into the L1+L2 jack of the triplex adapter. Or, you can plug the two-line telephone into the TEL jack of the two-line TAD.

Multi-Line connections (PBX)

Most offices use a central telephone system. While it is often relatively simple to connect the fax machine to a key system or a PBX (Private Branch Exchange), we suggest that you contact the company that installed your telephone system and ask them to connect the fax machine for you. It is advisable to have a separate line for the fax machine.

If the fax machine is to be connected to a multi-line system, ask your installer to connect the unit to the last line on the system. This prevents the unit from being activated each time a telephone call is received.

If you are installing the fax machine to work with a PBX

- 1 It is not guaranteed that the unit will operate correctly under all circumstances with a PBX. Any cases of difficulty should be reported first to the company that handles your PBX.
- 2 If all incoming calls will be answered by a switchboard operator, it is recommended that the Receive Mode be set to **MANUAL**. All incoming calls should initially be regarded as telephone calls.

Custom features on your phone line

If you have Voice Mail, Call Waiting, RingMaster, an answering service, an alarm system or other custom feature on one phone line it may create a problem with the operation of your fax machine. (See *Custom features on a single line* on page 12-7.)

2 Paper

About paper

Handling and using plain paper

Store paper in its original packaging, and keep it sealed. Keep the paper flat and away from moisture, direct sunlight and heat.

Paper specifications for the paper tray

Size:	letter, legal
Weight:	17 to 24 lb (64 to 90 g/m ²)
Thickness:	0.003 to 0.0047 in. (0.08 to 0.12 mm)
Capacity:	up to 50 sheets (under the following conditions: temperature 23°C, humidity 50%)



The fax machine can only scan an image 8.2 in. (208 mm) wide, regardless of how wide the paper is.



Do not use cardboard, newspaper or fabric.

Do not use paper:

- that is extremely shiny or highly textured
- that was previously printed by a printer
- that cannot be arranged uniformly when stacked
- that is made with a short grain
- that is curled, wrinkled, folded, ripped, stapled, paper-clipped, pasted, or taped

How to load paper

To load paper

Before you add paper, remove all of the paper from the paper tray.

- 1 Fan the stack of paper well to avoid paper jams and mis-feeds.

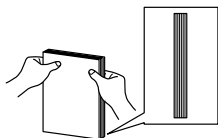

Tap the stack of paper so the edges are even.

- 2 Gently insert the paper.
The side to be printed on must be face down.

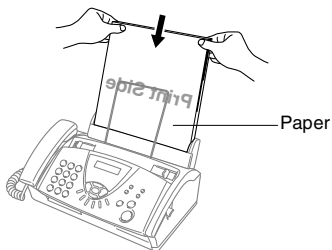

3 On-Screen Programming

User-friendly programming

The fax machine is designed to be easy to use with LCD on-screen programming using the navigation keys. User-friendly programming helps you take full advantage of all the menu selections the fax machine has to offer.

Since your programming is done on the LCD, we have created step-by-step on-screen instructions to help you program the fax machine. All you need to do is follow the instructions as they guide you through the menu selections and programming options.

Menu table

You can probably program the fax machine without the User's Guide if you use the Menu table that begins on page 3-3. These pages will help you understand the menu selections and options that are found in the fax machine programs.



You can program the fax machine by pressing **Menu/Set**, followed by the menu numbers.

For example to set **RESOLUTION** to **FINE**:

Press **Menu/Set**, **3**, **4** and **▲** or **▼** to select **FINE**.

Press **Menu/Set**.

Memory Storage

If there is a power failure, you will not lose your menu settings because they are stored permanently. Temporary settings (such as Contrast, Overseas Mode, and so on) will be lost. You may also have to reset the date and time.

Navigation keys

		Access the menu Go to the next menu level Accept an option
		Scroll through the current menu level
		Go back to the previous menu level
		Go forward to the next menu level
	Stop/Exit 	Exit the menu

You can access the menu mode by pressing **Menu/Set**.

When you enter the menu, the LCD scrolls.

SELECT ↑ ↓ & SET

Press **1** for Initial Setup

1. INITIAL SETUP

—OR—

Press **2** for Setup Receive menu

2. SETUP RECEIVE

—OR—

Press **3** for Setup Send menu

3. SETUP SEND

—OR—

Press **4** for Cancel Job menu

4. CANCEL JOB

—OR—

Press **5** for Interrupt menu

5. INTERRUPT

—OR—

Press **6** for Set Quick-Dial menu

6. SET QUICK-DIAL

—OR—

Press **7** for Setup Reports menu

7. SETUP REPORTS

—OR—

Press **8** for Remote Fax Opt menu

8. REMOTE FAX OPT

—OR—

Press **0** for Miscellaneous menu

0. MISCELLANEOUS

You can scroll more quickly through each menu level by pressing the arrow key (▲ or ▼) for the direction you want. Select an option by pressing **Menu/Set** when that option appears on the LCD. Then the LCD shows the next menu level.

Press ▲ or ▼ to scroll to your next menu selection.

Press **Menu/Set**. When you finish setting an option, the LCD shows ACCEPTED.

Press the Menu numbers.
(ex. Press 1, 1 for Date/Time)

—OR—

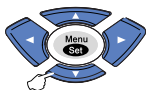

to select



to select

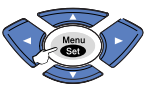

to accept

Stop/Exit



to exit

Main Menu	Menu Selections	Options	Descriptions	Page
1. INITIAL SETUP	1. DATE/TIME	—	Puts the date and time on the LCD and in the headings of faxes you send.	4-1
	2. STATION ID	—	Program your name and fax number to appear on each page you fax.	4-2
	3. BEEPER	OFF LOW HIGH	Adjust the volume level of the beeps that sound when you press a key, an error occurs or a document is sent or received.	4-4
	4. VOLUME AMPLIFY	ON (PERMANENT/ TEMPORARY) OFF	For the hearing-impaired, you can set the volume to the VOL AMPLIFY:ON setting on a permanent or temporary basis.	4-5
	5. AUTO DAYLIGHT	ON OFF	Changes for Daylight Saving Time automatically.	4-1
	6. TONE/PULSE (For Canada Only)	TONE PULSE	Selects the dialing mode.	4-6
	7. LOCAL LANGUAGE (For Canada Only)	ENGLISH FRENCH	Allows you to change the LCD Language to French.	See French manual.
2. SETUP RECEIVE	1. RING DELAY	04 03 02 01 00	Sets the number of rings before your fax machine answers in FAX/TEL or FAX ONLY mode.	5-2
	2. F/T RING TIME	70 40 30 20	Sets pseudo/double-ring time in FAX/TEL Mode.	5-3
	3. EASY RECEIVE	ON SEMI OFF	Receive fax messages without pressing the Fax Start key.	5-3



The factory setting (option) is shown in bold.

Press the Menu numbers.
(ex. Press 1, 1 for Date/Time)

—OR—



to select



to select

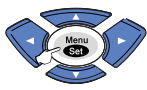

to accept

Stop/Exit



to exit

Main Menu	Menu Selections	Options	Descriptions	Page
2.SETUP RECEIVE (Continued)	4. REMOTE CODE	ON (*51, #51) OFF	You can answer all calls at an extension or external phone and use codes to turn the fax machine on or off. You can personalize these codes.	5-6
	5. AUTO REDUCTION	ON OFF	Reduces size of incoming faxes.	5-4
	6. PAPER	LETTER LEGAL A4	Selects size of paper for fax receiving	5-4
	7. POLLING RX	—	Sets up your fax machine to poll another fax machine.	5-6
3.SETUP SEND	1. COVERPG SETUP	NEXT FAX ONLY ON OFF PRINT SAMPLE	Automatically sends a programmable cover page or prints a sample coverpage.	6-6
	2. COVERPAGE MSG	—	Program a customized message for fax cover page.	6-6
	3. CONTRAST	AUTO LIGHT DARK	Change the lightness or darkness of the faxes you send.	6-4
	4. RESOLUTION	STANDARD FINE S.FINE PHOTO	Allows you to change resolutions page by page.	6-4
	5. OVERSEAS MODE	ON OFF	If you are having difficulty sending faxes overseas, set this to on.	6-8
	6. CALL RESERVE	ON OFF PRINT SAMPLE	You can send a fax, then speak or print a sample call back message.	6-9



The factory setting (option) is shown in bold.

Press the Menu numbers.
(ex. Press 1, 1 for Date/Time)

—OR—



to select



to select

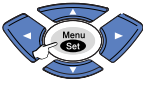

to accept



Main Menu	Menu Selections	Options	Descriptions	Page
3.SETUP SEND (Continued)	7. DELAYED FAX	—	Set the time of day in 24 hour format that the delayed faxes will be sent.	6-10
	8. POLLED TX	ON OFF	Set up your fax machine with a document to be retrieved by another fax machine.	6-11
	9. MEMORY TX	NEXT FAX ONLY ON OFF	You can send faxes from memory.	6-12
4.CANCEL JOB	—	—	Cancel a delayed fax or polling job.	6-5
5.INTERRUPT	—	—	Send a fax now, even if you have your fax machine set to send a fax later, or if you have it set for Polling.	6-13
6.SET QUICK-DIAL	1. ONE-TOUCH DIAL	—	Stores One-Touch Dial numbers, so you can dial by pressing one key.	7-1
	2. SPEED-DIAL	—	Stores Speed-Dial numbers, so you can dial by pressing only a few keys.	7-2
	3. SETUP GROUPS	—	Sets up a Group number for Broadcasting.	7-4
7.SETUP REPORTS	1. TRANSMISSION	ON OFF	Initial setup for Transmission Verification Report and Fax Journal period.	9-1
	2. JOURNAL PERIOD	EVERY 30 FAXES EVERY 6 HOURS EVERY 12 HOURS EVERY 24 HOURS EVERY 2 DAYS EVERY 7 DAYS OFF		9-1



The factory setting (option) is shown in bold.

Press the Menu numbers.
(ex. Press 1, 1 for Date/Time)

—OR—

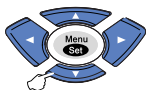

to select



to select

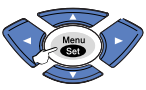

to accept

Stop/Exit



to exit

Main Menu	Menu Selections	Options	Descriptions	Page
8. REMOTE FAX OPT	1. FWD / PAGE / STORE	OFF FAX FORWARD PAGING FAX STORAGE	Sets the fax machine to forward fax messages, to call your pager, or to store incoming faxes in the memory so you can retrieve them while you are away from your fax machine.	8-1
	2. REMOTE ACCESS	---*	You must set your own code for Remote Retrieval.	8-3
	3. PRINT FAX	—	Print incoming faxes stored in the memory.	5-6
0. MISCELLANEOUS	1. COMPATIBILITY	NORMAL BASIC	If interference on your phone line interrupts your faxes, try the 'BASIC' setting.	12-4
	2. DISTINCTIVE	ON OFF SET	Use with phone company Distinctive Ring service to register the ring pattern with the fax machine.	5-8
	3. CALL WAITING ID	ON OFF	Lets you use the telephone company's Call Waiting/ Caller ID subscriber service.	5-13
	4. CALLER ID (US only)	—	Uses the telephone company's Distinctive Ring subscriber service to display the caller's name or number on the fax machine as it rings.	5-10



The factory setting (option) is shown in bold.

4 Initial Setup

Getting started

Setting the Date and Time

When the fax machine is not in use, it will display the date and time. If you set up the Station ID the date and time displayed by your fax machine will be printed on every fax you send. If there is a power failure, you may have to reset the date and time.

- 1 Press **Menu/Set**, **1**, **1**. 1.DATE/TIME
- 2 Enter the last two digits of the year.
Press **Menu/Set**.
- 3 Enter two digits for the month.
Press **Menu/Set**.
(For example, enter 09 for September, or 10 for October.)
- 4 Enter two digits for the day.
Press **Menu/Set**.
(For example, enter 06.)
- 5 Enter the time in 24-Hour format.
Press **Menu/Set**.
(For example, enter 15:25 for 3:25 P.M.)
- 6 Press **Stop/Exit**.
The LCD now shows the date and time whenever the fax machine is in Standby mode.

Turning on Automatic Daylight Savings Time

You can set the fax machine to change automatically for Daylight Savings Time. It will reset itself forward one hour in the Spring and backward one hour in the Fall. Make sure you have set the correct day and time in the `DATE/TIME` setting. The default setting is `OFF`.

- 1 Press **Menu/Set**, **1**, **5**. 5.AUTO DAYLIGHT
- 2 Press **▲** or **▼** to select `ON` (or `OFF`).
Press **Menu/Set**.
- 3 Press **Stop/Exit**.

Setting the Station ID

You should store your name or company name and fax number so they print on all fax pages that you send. The telephone number will appear only on cover pages and call back messages.

1 Press **Menu/Set**, **1**, **2**.

2 . STATION ID

2 Enter your fax number (up to 20 digits).

Press **Menu/Set**.

You must enter a fax number to continue (up to 20 digits).



If you do not enter a fax number, you cannot enter any more information.

You can not enter a hyphen.

3 Enter your telephone number (up to 20 digits).

Press **Menu/Set**.

4 Use the dial pad to enter your name (up to 20 characters).

Press **Menu/Set**.

(See *Entering text below*.)

5 Press **Stop/Exit**.

The LCD will show the date and time.



If the Station ID has already been programmed, the Station ID will ask you to press **1** to make a change or **2** to exit without changing the setting.

Entering text

When you are setting certain menu selections, such as the Station ID, you may need to type text into the fax machine. Most number keys have three or four letters printed on them. The keys for **0**, **#** and ***** do not have printed letters because they are used for special characters.

By pressing the appropriate dial pad key repeatedly, you can access the character you want.

Press Key	one time	two times	three times	four times	five times
2	A	B	C	2	A
3	D	E	F	3	D
4	G	H	I	4	G
5	J	K	L	5	J
6	M	N	O	6	M
7	P	Q	R	S	7
8	T	U	V	8	T
9	W	X	Y	Z	9

Inserting spaces

To enter a space in the fax number, press ► once between numbers. To enter a space in the name, press ► twice between characters.

Making corrections

If you entered a letter incorrectly and want to change it, press ◀ to move the cursor under the incorrect character. Then press **Stop/Exit**. All the letters above and to the right of the cursor will be deleted. Re-enter the correct characters. You can also back up and type over incorrect letters.

Repeating letters

If you need to enter a character that is on the same key as the previous character, press ► to move the cursor to the right before you press the key again.

Special characters and symbols

Press *, # or 0, and then press ◀ or ► to move the cursor under the special character or symbol you want. Then press **Menu/Set** to select it.

Press * for (space) ! " # \$ % & ' () * + , - . /

Press # for : ; < = > ? @ [] ^ _

Press 0 for É À È Ê Î Ç Ë Ö 0

NOTICE

The Telephone Consumer Protection Act of 1991 makes it unlawful for any person to use a computer or electronic device to send any message via a telephone fax machine unless such messages clearly contain, in a margin at the top or bottom of each transmitted page, or on the first page of the transmission, the date and time it is sent and an identification of the business or other entity or other individual sending the message and the telephone number of the sending machines or such business, other entity or individual.

To program this information into the fax machine, see *Setting the Date and Time* on page 4-1 and *Setting the Station ID* on page 4-2.

Setting the Beeper Volume

You can change the beeper volume. The default (factory) setting is **LOW**. When the beeper is on, the fax machine will beep when you press a key, make a mistake or after you send or receive a fax.

- 1 Press **Menu/Set**, **1**, **3**.
- 2 Press **▲** or **▼** to select **LOW**, **HIGH** or **OFF**.
Press **Menu/Set**.
- 3 Press **Stop/Exit**.

3 . BEEPER

Setting the Speaker Volume

You can adjust the speaker volume by pressing **Hook**, and then selecting a speaker volume level.

Press **◀** or **▶** to adjust the volume level.

The LCD shows the setting you are choosing. Each key press changes the volume to the next setting. The new setting will remain until you change it again.



Choosing the Handset Volume (For Volume Amplify)

Before you begin to use your fax machine, you must decide if you need to set the handset volume to **VOL AMPLIFY: ON?** for a user who is hearing-impaired. The **AMPLIFY** volume level complies with FCC standards.



VOLUME AMPLIFY: OFF

This default setting is appropriate if none of the users are hearing-impaired. During a conversation, users can press **◀** or **▶** on the control panel to adjust the volume to **LOW** or **HIGH**. When the handset is replaced, the handset volume will remain until you change it again.



VOLUME AMPLIFY: ON-TEMPORARY

This setting is appropriate if some of the users are hearing-impaired. During a conversation, users can press  or  on the control panel to adjust the volume to **LOW** or **HIGH**. When the handset is replaced, the handset volume returns to the default setting of **LOW**.

VOLUME AMPLIFY:ON-PERMANENT

Choose **VOL AMPLIFY: ON?-PERMANENT?** if all of the users are hearing-impaired. During a conversation, users can press  or  on the control panel to adjust the volume to **LOW** or **HIGH**. When the handset is replaced, the handset volume returns to the default setting of amplify.



When you press  or  on the control panel to adjust the volume, the LCD shows the setting you are choosing. Each key press changes the volume to the next setting.



It is important that you do not choose **PERMANENT** unless all users are hearing-impaired. Otherwise, the default setting of amplify may damage the hearing of some users.



Setting Volume Amplify





Please carefully read *Choosing the Handset Volume (For Volume Amplify)* on page 4-4 before you do the following steps:



1 Press **Menu/Set, 1, 4.**

4.VOLUME AMPLIFY



2 If none of the users are hearing-impaired, press  or  to select **VOL AMPLIFY:OFF?**, and then press **Menu/Set** and go to Step 4.

—OR—

If some or all of the users are hearing-impaired, press  or  to select **VOL AMPLIFY:ON?**, and then press **Menu/Set**.

3 If all the users are hearing-impaired, press  or  to select **PERMANENT?**, and then press **Menu/Set**.

—OR—

If only some of the users are hearing-impaired, press  or  to select **TEMPORARY**, and then press **Menu/Set**.

4 Press **Stop/Exit**.

Setting the Ring Volume

You can turn the ring off or you can select a ring volume level when your machine is idle (not being used).

Press **⏪** or **⏩** to adjust the volume level. Every time you press these keys, the fax machine will ring so you can hear the active setting as the LCD shows it. The volume changes with each key press. The new setting will stay until you change it again.

Setting Tone and Pulse dialing mode (Canada Only)

- 1 Press **Menu/Set**, **1**, **6**.
- 2 Press **▲** or **▼** to select **PULSE** (or **TONE**).
Press **Menu/Set**.
- 3 Press **Stop/Exit**.

6 . TONE / PULSE

Setting up your area code (USA only)

If you must dial the area code to call within your area code, do not enter this setting.

- 1 Press **Menu/Set**, **0**, **4**.
- 2 Use the dial pad to enter your area code, and then press **Menu/Set**.
- 3 Press **Stop/Exit**.

4 . CALLER ID

AREA CODE : 000

AREA CODE : 908

5 Setup Receive

Basic receiving operations

Choosing the Receive Mode

There are four different Receive Modes for the fax machine. You can choose the mode that best suits your needs.

LCD	How it works	When to use it
FAX ONLY (automatic receive)	The fax machine automatically answers every call as a fax.	For dedicated fax lines.
FAX/TEL* (fax and telephone)	The fax machine controls the line and automatically answers every call. If the call is a fax it will receive the fax. If the call is not a fax it will ring (pseudo/double ring) for you to pick up the call.	Use this mode if you expect to receive lots of fax messages and few telephone calls. You cannot have an answering machine on the same line, even if it is on a separate wall jack on the same line. You cannot use the telephone company's Voice Mail in this mode.
TAD : ANSWER MACH. (with an external answering device)	The external answering device (TAD) automatically answers every call. Voice messages are stored on the external TAD. Fax messages are printed.	Use this mode if you have connected an external answering machine to your machine. The TAD setting works only with an external answering machine. Ring Delay and F/T Ring Time do not work in this setting.
MANUAL (manual receive)	You control the phone line and must answer every call yourself.	Use this mode if you do not receive many fax messages, with Distinctive Ring or if you are using a computer on the same line. If you answer and hear fax tones, wait until the machine takes over the call, then hang up. (See <i>Easy Receive</i> on page 5-3)

* In FAX/TEL mode you must set the RING DELAY and F/T RING TIME. If you have extension phones on the line, keep the RING DELAY set to 4 rings.

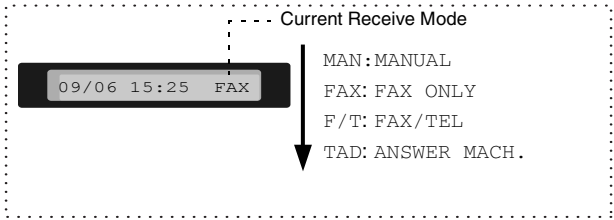

To select or change your Receive Mode

- 1 Press **Receive Mode**.

The LCD shows your current selection.

FAX ONLY

FAX/TEL

TAD: ANSWER MACH.

MANUAL

- 2 Continue to press **Receive Mode** until your new selection

appears. After 2 seconds, the screen returns to the date and time display, along with your new Receive Mode setting.



If you are changing the Receive Mode while in another operation, the screen returns to the current operation display.

Setting the Ring Delay

The Ring Delay sets the number of times the fax machine rings before it answers in **FAX ONLY** or **FAX/TEL** mode. If you have extension phones on the same line as the fax machine or subscribe to the telephone company's Distinctive Ring service, keep the Ring Delay setting of 4. (See *Easy Receive* on page 5-3 and *Operation from extension telephones* on page 5-5.)

- 1 Press **Menu/Set**, **2**, **1**.

1.RING DELAY

- 2 Press **▼** or **▲** to select how many times the line will ring before the fax machine answers (00, 01, 02, 03, or 04).

Press **Menu/Set**.

(If you select 00, the line won't ring at all.)

- 3 Press **Stop/Exit**.

Setting the F/T Ring Time (FAX/TEL mode only)

If you set the Receive Mode to **FAX/TEL**, you'll need to decide how long the fax machine will signal you with its special pseudo/double-ring when you have a voice call. (If it's a fax call, the fax machine prints the fax.) This pseudo double ringing happens after the initial ringing from the phone company. Only the fax machine rings and no other phones on the same line will ring with the special pseudo/double-ring. However, you can still answer the call on any extension phone (in a separate wall jack) on the same line as the fax machine. (See *Operation from extension telephones* on page 5-5.)

- 1 Press **Menu/Set, 2, 2.**
- 2 Press **▲** or **▼** to select how long the fax machine will ring to alert you that you have a voice call (20, 30, 40 or 70 seconds).

2.F/T RING TIME

Press **Menu/Set**.

- 3 Press **Stop/Exit**.



Even if the caller hangs up during the pseudo/double-ringing, the fax machine will continue to ring for the set time.

Easy Receive

When you use this feature, you don't have to press **Fax Start** or the Fax Receive Code *** 5 1** when you answer a fax call and hear calling beeps. Just hold the handset and wait a few seconds. Selecting **ON** allows the fax machine to receive fax calls automatically, even if you lift the machine's handset or the handset of an extension or external phone. When you see **RECEIVE** on the LCD or when you hear "chirps" through the handset of an extension phone connected to another wall jack, just replace the handset and the fax machine will do the rest. **SEMI** lets the fax machine receive the fax only if you've answered it at the fax machine.



■ If you have set this feature to **EASY RECEIVE:ON**, but your machine does not automatically connect a fax call when you lift an external or extension phone handset, press the Fax Receive Code *** 5 1**. At the machine lift the handset and then press **Fax Start**.

■ If you send faxes from a computer on the same phone line and the machine intercepts them, set this feature to **EASY RECEIVE:OFF**.

■ Selecting **EASY RECEIVE:OFF** means you'll have to activate the machine yourself by pressing **Fax Start**.

—OR—

Press *** 5 1** on the external or extension phone if you are not at your machine.

- 1 Press **Menu/Set, 2, 3.**
- 2 Use **▲** or **▼** to select **ON**, **SEMI** or **OFF**.

3.EASY RECEIVE

Press **Menu/Set**.

- 3 Press **Stop/Exit**.

Printing a reduced incoming fax (Auto Reduction)

If you choose **ON**, the fax machine automatically reduces an incoming fax to fit on one page of Letter or Legal size paper, regardless of the paper size of the document. The fax machine calculates the reduction ratio by using the page size of the document and your Paper Size setting (**Menu/Set, 2, 6**).

1 Press **Menu/Set, 2, 5**.

5 . AUTO REDUCTION

2 Use **▲** or **▼** to select **ON** (or **OFF**).

Press **Menu/Set**.

3 Press **Stop/Exit**.



■ If you receive faxes that are split on two pages, turn on this setting. If the document is too long, however, the fax machine may print it on two pages.

■ When Auto Reduction is turned on and an incoming document is smaller than your paper, no reduction will take place, and you will get the same size as the sender's document.

Setting Paper Size

You can use three sizes of paper for printing your faxes—Letter, Legal and A4. When you change the type of paper in the paper tray, you will need to change the setting for paper size at the same time, so your machine can fit an incoming fax on the page.

1 Press **Menu/Set, 2, 6**.

6 . PAPER

2 Press **▲** or **▼** to select **LETTER**, **LEGAL** or **A4**.

Press **Menu/Set**.

3 Press **Stop/Exit**.

Receiving a fax at the end of a conversation

At the end of a conversation you can ask the other party to fax you information before you both hang up.

1 Ask the other party to place the document in their machine and to press **Start**. Tell the other party to wait until the fax machine sends receiving tones (chirps) before hanging up.

2 When you hear the other machine's **CNG** tones (beeps), press **Fax Start**.

The LCD shows:

RECEIVE

3 Replace the handset.

Advanced receiving operations

Operation from extension telephones

If you answer a fax call on an extension telephone, or an external telephone in the EXT. jack of the machine, you can make the fax machine take the call by using the Fax Receive Code. When you press the Fax Receive Code * 5 1, the fax machine starts to receive a fax. (See *Easy Receive* on page 5-3.)

If the fax machine answers a voice call and pseudo/double-rings for you to take over, use the Telephone Answer Code # 5 1 to take the call at an extension phone. (See *Setting the F/T Ring Time (FAX/TEL mode only)* on page 5-3.)

If you answer a call and no one is on the line, you should assume that you're receiving a manual fax.

- At an extension phone (on a separate telephone wall jack), press * 5 1, wait for fax-receiving tones (chirps), and then hang up.
- At an external phone (connected to the fax machine's EXT jack), press * 5 1 and wait for the phone to be disconnected before you hang up (the LCD shows RECEIVE).

Your caller will have to press the Start key to send the fax.

For FAX/TEL mode only

When the fax machine is in FAX/TEL mode, it will use the F/T Ring Time (pseudo/double-ringing) to alert you to pick up a voice call.

If you're at an extension or external phone, you'll need to lift the handset during the F/T Ring Time and then press # 5 1 between the double rings. If no one is on the line, or if someone wants to send you a fax, send the call back to the fax machine by pressing * 5 1.

Using a cordless external handset

If your cordless telephone is connected to the EXT. jack of the fax machine and you typically carry the cordless handset elsewhere, it is easier to answer calls during the Ring Delay. If you let the fax machine answer first, you will have to answer using the cordless and then go to the fax machine so you can press **Hook** to transfer the call to the cordless handset.

Changing the remote codes

Remote Codes might not work with some telephone systems. The preset Fax Receive Code is * 5 1. The preset Telephone Answer Code is # 5 1.

 If you are always disconnected when accessing your external TAD remotely, try changing the Fax Receive Code, Telephone Answer Code, or Activation Voice Code to other three-digit codes using numbers 0-9, * or #.

- 1 Press **Menu/Set**, **2**, **4**. 4 . REMOTE CODE
- 2 Press **▲** or **▼** to select **ON** (or **OFF**).
Press **Menu/Set**.
- 3 Enter the new Fax Receive Code.
Press **Menu/Set**.
- 4 Enter the new Telephone Answer Code.
Press **Menu/Set**.
- 5 Press **Stop/Exit**.

Printing a fax from the memory

If you have selected Fax Forwarding, Paging or Fax Storage (**Menu/Set**, **8**, **1**) you can still print a fax from the memory when you are at the fax machine. (See *Setting Fax Storage* on page 8-3.)

- 1 Press **Menu/Set**, **8**, **3**. 3 . PRINT FAX
- 2 Press **Fax Start**.
- 3 After printing has finished, press **Stop/Exit**.

Polling

Polling is the process of retrieving faxes from another fax machine. You can use the fax machine to 'poll' other machines, or you can have someone poll the fax machine.

Everyone who is involved in Polling needs to set up their fax machines for Polling. When someone polls the fax machine to receive a fax, they pay for the call. If you poll someone's fax machine to receive a fax, you pay for the call.

 Some fax machines do not respond to the Polling feature.

Setting up Polling Receive

Polling Receive is when you call another fax machine to receive a fax from it.

- 1 Press **Menu/Set**, **2**, **7**. 7 . POLLING RX
- 2 Enter the fax number you are polling.
- 3 Press **Fax Start**.
The LCD shows **DIALING**.

Setting up Sequential Polling Receive

The fax machine can ask for faxes from several fax units in a single operation (Sequential Polling Receive). Afterwards, a Sequential Polling Report will be printed.

1 Press **Menu/Set, 2, 7.**

7. POLLING RX

2 Enter the fax machines you want to poll using One-Touch, Speed-Dial, a Group, or Search. For example, for One-Touch 3 and Speed-Dial location 09, press One-Touch dial key **3, Search/Speed Dial, #** and 09.

3 Press **Fax Start**. The fax machine will poll each number or Group number in turn to receive a fax.



Press **Stop/Exit** while the machine is dialing to cancel the polling process.

To cancel all sequential polling receive jobs, press **Menu/Set, 4.** (See *Canceling a scheduled job* on page 6-5.)

Telephone services

Your fax machine supports the Caller ID and Distinctive Ring subscriber telephone service that some telephone companies offer.



If you have Voice Mail, Call Waiting, RingMaster, an answering service, an alarm system or other custom features on your telephone line, it may affect the way the fax machine works. (See *Custom features on a single line* on page 12-7.)

If you have Voice Mail on your phone line, please read the following carefully.

Distinctive Ring

Brother uses the term 'Distinctive Ring' but different telephone companies have other names for this service such as SmartRing, RingMaster, Teen-Ring, Indent-a-Call or Indent-a-Ring.

What does your telephone company's 'Distinctive Ring' do?

Your telephone company's Distinctive Ring service allows you to have more than one number on the same phone line. **If you need more than one phone number, it is cheaper than paying for an extra line.** Each phone number has its own distinctive ring pattern, so you will know which phone number is ringing. This is one way you can have a separate phone number for your machine.



Please call your telephone company for availability and rates.

What does Brother's 'Distinctive Ring' do?

The Brother fax machine has a Distinctive Ring feature that allows you to use your machine to take full advantage of the telephone company's Distinctive Ring service. The new phone number on your line can just receive faxes.



You must pay for your telephone company's Distinctive Ring service before you program the fax machine to work with it.

Do you have Voice Mail?

If you have Voice Mail on the phone line that you will install your new fax machine on, *there is a strong possibility that Voice Mail and the fax machine will conflict with each other while receiving incoming calls.* **However, this Distinctive Ring feature allows you to use more than one number on your line, so both Voice Mail and the machine can work together without any problems.** If each one has a separate phone number, neither will interfere with the other's operations.





If you decide to get the Distinctive Ring service from the telephone company, you will need to follow the directions below to 'register' the new Distinctive Ring pattern they give you. This is so your machine can recognize its incoming calls.



You can change or cancel the Distinctive Ring pattern at any time. You can switch it off temporarily, and turn it back on later. When you get a new fax number, make sure you reset this feature.

Before you choose the ring pattern to register

You can only register one Distinctive Ring pattern with the machine. Some ring patterns cannot be registered. The ring patterns below are supported by the Brother machine. Register the one your telephone company gives you.

Ring Pattern	Rings	
1	long-long	
2	short-long-short	
3	short-short-long	
4	very long (normal pattern)	

 If the ring pattern you received is not on this chart, **please call your telephone company and ask for one that is shown.**

- The machine will only answer calls to its registered number.
- The first two rings are silent on the machine. This is because the fax must «listen» to the ring pattern (to compare it to the pattern that was 'registered'). (Other telephones on the same line will ring.)
- If you program the machine properly, it will recognize the registered ring pattern of the 'fax number' within 2 ring patterns and then answer with a fax tone. When the 'voice number' is called, the machine will not answer.

Registering the Distinctive Ring pattern

Very important

After you have set the Distinctive Ring feature to **ON**, the receive mode is set to **MANUAL** automatically. Unless you have a TAD or Voice Mail set up on the Distinctive Ring number, **MANUAL** mode means you must answer all the calls yourself. You can not change the receive mode to the other mode while the Distinctive Ring is set to on.

- 1 Press **Menu/Set, 0, 2.** 2.DISTINCTIVE
- 2 Press **▲** or **▼** to select **SET?**.
Press **Menu/Set**.
- 3 Press **▲** or **▼** to select the stored ring pattern you want to use.
Press **Menu/Set**.
(You will hear each pattern as you scroll through the four patterns. Make sure you choose the pattern that the telephone company gave you.)
- 4 Press **Stop/Exit**.
Distinctive Ring is now set to on.

Turning off the Distinctive Ring

- 1 Press **Menu/Set**, **0**, **2**.
- 2 Press **▲** or **▼** to select **OFF**.
Press **Menu/Set**.
- 3 Press **Stop/Exit**.

2.DISTINCTIVE



If you turn off Distinctive Ring, the machine will stay in **MANUAL** receive mode. You will need to set the Receive Mode again. (See *To select or change your Receive Mode* on page 5-2.)

Caller ID



The Caller ID feature lets you use the Caller ID subscriber service offered by many local telephone companies. This service displays the telephone number, or name if it is available, of your caller as the line rings.

After a few rings, the LCD shows the telephone number of your caller (and name if available). Once you pick up the handset, the Caller ID information disappears from the LCD, but the call information remains stored in the Caller ID memory.

- You will see the first 16 characters of the number (or name).
- **OUT OF AREA** display means call originated outside your Caller ID service area.
- **PRIVATE CALL** display means the caller has intentionally blocked transmission of information.

Caller ID service varies with different carriers. Call your local telephone company to determine the kind of service available in your area.

Caller ID Log

Your machine stores up to 30 of the last Caller IDs received into your machine's memory in the Caller ID Log. When the thirty-first call comes in, information about the first call is erased. You can print the report or scroll through Caller ID information to review those calls made to your machine.

Printing the Caller ID Log

- 1 Press **Hold/Caller ID**.
- 2 To print the Caller ID Log, press **Fax Start**.

CALLER ID LOG

PRESS START KEY

Viewing the Caller ID Log

- 1 Press **Hold/Caller ID**.
- 2 After two seconds, press **▲** or **▼** to scroll through the Caller ID Log.
- 3 When you want to see detailed information for a displayed ID (phone number and date and time call was received) press **Menu/Set**.
- 4 To continue viewing the Caller ID Log (Step 2), press **▲** or **▼**.

—OR—

To exit the Caller ID Log, press **Stop/Exit**.

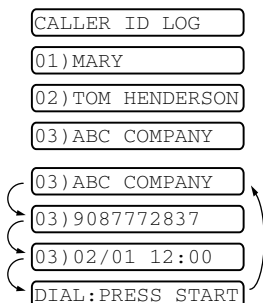

Returning a call from the Log

You can scroll through the Caller ID Log and select a call to return automatically. (See page 5-10.)

(For USA Only) You must set up your AREA CODE in advance. (See *Setting up your area code (USA only)* on page 4-6.)

- 1 Press **Hold/Caller ID**.
- 2 Press **▲** or **▼** to scroll through the Caller ID Log and when you see a call you want to return immediately, press **Menu/Set**.
- 3 To begin dialing, press **Fax Start**.
- 4 Begin speaking when the other party answers.

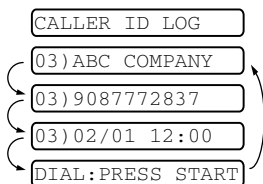

This feature may not be available in certain areas of the USA and Canada.

If your dialing plan does not follow the standard 1 + area code + 7-digit number dialing system for calling outside your area code, you may experience problems returning calls automatically from the Caller ID Log. Your machine will automatically dial "1" plus the area code for any number that does not originate in your area code. If this is not the procedure followed by your dialing plan you will not be able to return calls automatically.

Registering a Caller ID number

You can set up a caller in the Caller ID Log as a One-Touch or Speed Dial number.

- 1 Press **Hold/Caller ID**.
- 2 After two seconds, press ▲ or ▼ to scroll through the Log and when you see a caller you want to register, press **Menu/Set**.

CALLER ID LOG

- 3 To register the caller as a One-Touch number, press the One-Touch key where you want the number to be stored.

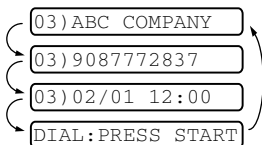

—OR—

To register the caller as a Speed-Dial number, press

Search/Speed Dial and use the dial pad to press the two-digit location code (00–99), and then press **Menu/Set**.

 If the LCD shows REGISTERED, the quick-dial location already has a number.

- 4 Enter the caller's name, and then press **Menu/Set**.
- 5 Press ▲ or ▼ to select the type of number, and then press **Menu/Set**:

NAME :

FAX	a fax number
TEL	a telephone (voice) number
FAX/TEL	both a fax and telephone number
CHAIN	a number (usually an access code) for chain dialing.

- 6 Return to Step 2 to store another quick-dial number.

—OR—

Press **Stop/Exit**.

Call Waiting/Caller ID

The Call Waiting/Caller ID feature lets you use the Call Waiting/Caller ID subscriber service offered by many local telephone companies. This feature displays the telephone number (or name, if available) of Call Waiting Callers on your machine's LCD.

- 1 Press **Menu/Set, 0, 3**.
- 2 Press **▲** or **▼** to select **ON** (or **OFF**).
Press **Menu/Set**.

3 .CALLWAITING ID

To answer a Call Waiting signal:

- 3 To answer a Call Waiting signal while you're talking on the phone, ask the other party if you can put them on Hold to catch the other call. The LCD shows the Caller ID.
- 4 Press **Search/Speed Dial** to switch to the second call.
- 5 To switch back to the first call, press **Search/Speed Dial** again.



Either caller can hang up at any time. However, if you hang up you will disconnect both callers.

6 Setup Send

How to dial

You can dial in any of the following ways.

Manual dialing

Press all of the digits of the phone or fax number.



One-Touch dialing

Press the One-Touch key of the location you want to call.

If the LCD shows **NOT REGISTERED** when you enter the One-Touch number, a number has not been stored for it.

Speed-Dialing

Press **Search/Speed Dial**, #, and then the two digit Speed-Dial number. (See *Storing Speed-Dial numbers* on page 7-2.)

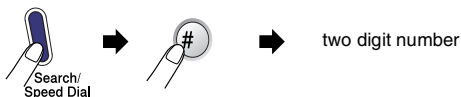

If the LCD shows **NOT REGISTERED** when you enter the Speed-Dial number, a number has not been stored for it.

Search

You can search for names you have stored in One-Touch and Speed-Dial memories. Press **Search/Speed Dial** and the navigation keys (◀ or ▶) to search.

(See *Storing One-Touch Dial numbers* on page 7-1 and *Storing Speed-Dial numbers* on page 7-2.)

 To search alphabetically, you can use the dial pad to enter the first letter of the name you are looking for.

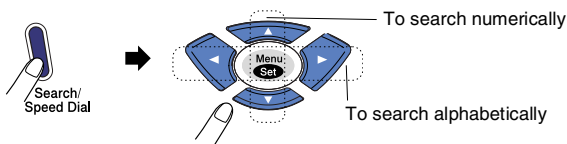

Fax Redial

If you are sending a fax manually and the line is busy, press **Redial/Pause**, and then press **Fax Start** to try again. If you want to make a second call to the last number dialed, you can save time by pressing **Redial/Pause** and **Fax Start**.

Redial/Pause only works if you dialed from the control panel.

If you are sending a fax automatically and the line is busy, the fax machine will automatically redial one time after five minutes.

How to fax

Automatic transmission

This is the easiest way to send a fax. Documents must be between 5.8 and 23.7 inches (150 and 600 mm) long and between 5.9 and 8.5 inches (148 and 210 mm) wide.

IMPORTANT: Do not pick up the handset or press **Hook**.

- 1 Insert the document face down, top edge first in the Automatic Document Feeder (ADF).
- 2 Adjust the paper guides to fit the width of your document.

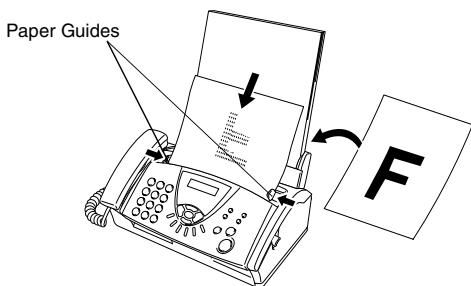

- 3 Enter the fax number using One-Touch, Speed-Dial, Search or the dial pad. (See *One-Touch dialing* on page 6-1, *Speed-Dialing* on page 6-1 and *Search* on page 6-1.)
- 4 Press **Fax Start**.

 Do not use paper that is curled, wrinkled, folded, ripped, stapled, paper clipped, pasted, or taped.

Do not use cardboard, newspaper or fabric.

 The ADF can hold up to 10 pages, feeding each one individually through the fax machine. Use standard 17 lb-24 lb (64 g/m²-90 g/m²) paper when using the ADF; if you are using heavier paper, feed each sheet individually to prevent paper jams.

Manual transmission

Manual transmission lets you hear the dialing, ringing and fax-receiving tones while sending a fax.

- 1 Insert the document face down in the ADF.
- 2 Pick up the handset and listen for a dial tone.
—OR—
Press **Hook** listen for a dial tone.
- 3 Enter the fax number you want to call. (You can enter the digits using the dial pad, or you can enter a One-Touch or Speed-Dial number, or you can call using **Search/Speed Dial**.)
(See *How to dial* on page 6-1.)
- 4 When you hear the fax tone,  press **Fax Start**.
- 5 If you picked up the handset, hang up.

Sending a fax at the end of a conversation

At the end of a conversation you can send a fax to the other party before you both hang up.

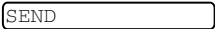
- 1 Ask the other party to wait for fax tones (beeps) and then to press Start before hanging up.
- 2 Insert the document face down in the ADF.
Press **Fax Start**.
The LCD shows: 
- 3 Replace the handset.

Basic sending operations

Sending faxes using multiple settings

When you send a fax you can choose any combination of these settings such as contrast, resolution, overseas mode, delayed fax timer, polling transmission or memory transmission.

After each setting is accepted, the LCD will ask if you want to enter more settings:

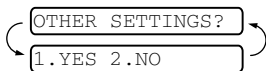

Press **1** to select more settings. The LCD will return to the **SETUP SEND** menu.

—OR—

Press **2** if you have finished choosing settings and go to the next step.

Contrast

If your document is very light or very dark, you may want to set the contrast.

Use **LIGHT** to make the document darker.

Use **DARK** to make the document lighter.

1 Insert the document face down in the ADF.

2 Press **Menu/Set**, **3**, **3**.

3 . CONTRAST

3 Press **▲** or **▼** to select **AUTO**, **LIGHT** or **DARK**.

Press **Menu/Set**.

4 Press **1** if you want to choose more settings and the LCD will return to the **SETUP SEND** menu.

ACCEPTED

OTHER SETTINGS?

1 . YES 2 . NO

—**OR**—

Press **2** if you have finished choosing settings for this page, and then go to Step 5.

5 Enter a fax number.

6 Press **Fax Start** to send the fax.

The fax machine starts scanning the first page.

Fax resolution

When you have an document in the ADF you can use the **Resolution** key to change the setting temporarily (for this fax only). Press **Resolution** repeatedly until the LCD shows the setting you want.

STANDARD — Suitable for most typed documents.

FINE — Good for small print and transmits a little slower than Standard resolution.

S . FINE — Good for small print or artwork and transmits slower than Fine resolution.

PHOTO — Use when the document has varying shades of gray or is a photograph. This has the slowest transmission time.

Multiple Resolution Transmission

Use this feature to select separate resolution settings for each page of the fax you are sending. This could be useful if you are sending a fax with photos and text, or some pages with small print and others with larger print. Resolution settings return to *STANDARD* after the fax is sent.

- 1 Insert the document face down in the ADF.
- 2 Press **Menu/Set**, **3**, **4**.
- 3 Use **▲** or **▼** to select *STANDARD*, *FINE*, *S . FINE* or *PHOTO* as the resolution for page 1.

Press **Menu/Set**.

- 4 Repeat Step 3 for each page.
Press **Stop/Exit** when you are finished. The screen displays:

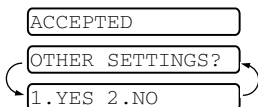

- 5 Press **1** if you want to select additional settings. The display returns to the *SETUP SEND* menu.

—OR—

Press **2** if you are finished choosing settings, and go to Step 6. The screen prompts you to enter the fax number you want to call.

- 6 Enter the fax number, and press **Fax Start**.

Canceling a fax in progress

If you want to cancel a fax, while the fax machine is scanning, dialing or sending it, press **Stop/Exit**.

Canceling a scheduled job

You can cancel a fax job that is stored and waiting in memory.

- 1 Press **Menu/Set**, **4**.
Any jobs that are waiting will appear on the LCD.
- 2 If you have more than one job waiting, press **▲** or **▼** to select the job you want to cancel.

The diagram shows a single rectangular box representing LCD screen text containing "4.CANCEL JOB".

Press **Menu/Set**.

—OR—

If you only have one job waiting, go to Step 3.

- 3 Press **1** to cancel.

—OR—

Press **2** to exit without canceling.

To cancel another job go to Step 2.

- 4 Press **Stop/Exit**.

Advanced sending operations

Composing the electronic Cover Page

The cover page is sent to the receiving party's machine. Your cover page includes the name or number stored in the One-Touch or Speed-Dial memory. If you are dialing manually, the name is left blank.

The cover page shows your Station ID, and the number of pages you are sending. If you have `COVERPG SETUP` set to `ON` (See *Send a cover page for all faxes* on page 6-7), the number of pages is left blank.

You can select a comment to include on your cover page.

1. `COMMENT OFF`
2. `PLEASE CALL`
3. `URGENT`
4. `CONFIDENTIAL`

Instead of using one of the preset comments, you can enter two personal messages of your own, up to 27 characters. (See *Entering text* on page 4-2.)

5. `(USER DEFINED)`
6. `(USER DEFINED)`

Most of the `SETUP SEND` settings are temporary to allow you to make changes for each fax you send. However when you set up your Cover Page and Cover Page Comments, you are changing the default settings so they will be available while faxing.

Composing your own comments

- 1 Press **Menu/Set**, **3**, **2**.

The screen displays:

2. `COVERPAGE MSG`

- 2 Use **▲** or **▼** to choose position 5 or 6 for your own comment.

Press **Menu/Set**.

- 3 Use the dial pad to enter your customized comment. (See *Entering text* on page 4-2.)

- 4 Press **Menu/Set**.

The screen displays:

ACCEPTED

- 5 Press **1** if you want to choose more settings. The display returns to the `SETUP SEND` menu.

OTHER SETTINGS?

1. `YES` 2. `NO`

—**OR**—

Press **2** to exit.

Cover page for next fax only

This feature does not work unless you have set up the Station ID. (See *Setting the Station ID* on page 4-2.)

If you only want to send a cover page with a particular fax, this cover page will include the number of pages in your document.

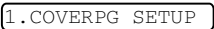
- 1 Insert the document face down in the ADF.
- 2 Press **Menu/Set**, **3**, **1**. 
- 3 When the LCD shows NEXT FAX ONLY, press **Menu/Set**.
- 4 Press **▲** or **▼** to select NEXT FAX:ON (or NEXT FAX:OFF), and press **Menu/Set**.
- 5 Press **▲** or **▼** to select one of the standard or your own comments.
- 6 Press **Menu/Set**.
- 7 Enter two digits to show the number of pages you are sending. (Enter **00** to leave the number of pages blank.) If you have made a mistake, press **◀** to back up and re-enter the number of pages.
- 8 Press **Menu/Set**.
- 9 Press **1** if you want to choose more settings. The LCD returns to the SETUP SEND menu.
—OR—
Press **2** if you have finished choosing settings.
- 10 Enter the fax number you are calling and then press **Fax Start**.

Send a cover page for all faxes

Make sure you have set up the Station ID before continuing. This feature does not work without the Station ID. (See *Setting the Station ID* on page 4-2.)

You can set your machine to send a cover page whenever you send a fax. The number of pages in your fax is not included when you use this setting.

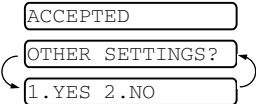
- 1 Press **Menu/Set**, **3**, **1**. 
- 2 Press **▲** or **▼** to select ON (or OFF). (If you select ON, a cover page is always sent when you send a fax.)
- 3 Press **Menu/Set**.
- 4 If you selected ON, press **▲** or **▼** to select one of the standard or your own comments.
- 5 Press **Menu/Set** when the screen displays your selection. The screen displays:

- 6 Press **1** if you want to choose more settings. The LCD returns to the SETUP SEND menu.
—OR—
Press **2** to exit if you have finished choosing settings.

Using a printed Cover Page

If you prefer using a printed cover page that you can write on, you can print the sample page and attach it to your fax.

- 1 Press **Menu/Set, 3, 1.**
- 2 Press **▲** or **▼** to select
PRINT SAMPLE.
Press **Menu/Set.**

1. COVERPG SETUP

Broadcasting

Using the numbers you have stored in Groups, One-Touch and Speed-Dial memory, you can “Broadcast” faxes automatically to a maximum of 104 different locations in a few simple steps. You must set MEMORY TX, either ON or NEXT FAX ONLY.

After the Broadcast is completed, a Broadcast Report will be printed automatically to let you know the results.

- 1 Insert the document face down in the ADF.
- 2 Press **Menu/Set, 3, 9** to select ON for Memory Transmission. (See *Memory Transmission* on page 6-12.)
- 3 Press **Menu/Set.**
- 4 Enter the One-Touch and Speed-Dial numbers (one after the other), Search numbers or a Group number you have stored.
- 5 Press **Fax Start.** The fax machine stores the document in memory, and then transmits it to all the numbers you entered. If the line is busy, your machine will redial.



- Press **Stop/Exit** during transmission to cancel the current fax Broadcast.
- To cancel all locations, press **Menu/Set, 4.** (See *Canceling a scheduled job* on page 6-5.)
- To turn Memory Transmission back off, after the Broadcast has finished go to Step 2 and select OFF.

Overseas Mode

If you are having difficulty sending a fax overseas due to possible interference on the phone line, we recommend that you turn on the Overseas Mode. After you send a fax using this feature, the feature will turn itself off.

- 1 Insert the document face down in the ADF.
- 2 Press **Menu/Set, 3, 5.**
- 3 Press **▲** or **▼** to select ON (or OFF).
Press **Menu/Set.**
- 4 Press **1** if you want to choose more settings and the LCD will return to the SETUP SEND menu.
—OR—
Press **2** if you have finished choosing settings, and then go to Step 5.
- 5 Enter the fax number you're calling.
- 6 Press **Fax Start.**

5. OVERSEAS MODE

Call Reservation

You can send a fax and let the other party know that you want to speak to him after the fax transmission is completed. The other fax machine will ring as if it were receiving a telephone call; if the other party picks up the handset, your machine will ring. To have a conversation, lift the handset.

If you set Call Reservation and Call Back message to **ON**, your machine leaves a message if the other party does not answer.

- 1 Insert the document face down in the ADF.
- 2 Press **Menu/Set**, **3**, **6**. 6 . CALL RESERVE
The screen displays the current setting for Call Reservation.
- 3 Press **▲** or **▼** to select **ON** (or **OFF**).
Press **Menu/Set**.
- 4 If you set Call Reservation to **ON**, the LCD shows the current setting for Call Back Message.
Press **▲** or **▼** to select **ON** (or **OFF**).
Press **Menu/Set**.
- 5 Press **1** if you want to select additional settings. The display returns to the **SETUP SEND** menu.
—OR—
Press **2** if you are finished choosing settings, and go to Step 6.
- 6 Enter the fax number, and press **Fax Start**.
- 7 If you've set Call Reservation to **ON**, pick up your handset if your machine rings.



You cannot use auto redial with Call Reservation. You cannot use Call Reservation with Delayed Transmission or with Polling. You must register your Station ID to set Call Back Message to **ON**.

Print Sample Call Back Message

- 1 Press **Menu/Set**, **3**, **6**. 6 . CALL RESERVE
- 2 Press **▲** or **▼** to select **PRINT SAMPLE**.
Press **Menu/Set**.

Delayed Fax

Depending on the amount of the data, you can use this menu setting to send up to 3 faxes at later times within the next 24 hours.

- 1 Insert the document face down in the ADF.
- 2 Press **Menu/Set**, **3**, **7**. 7 . DELAYED FAX
- 3 Enter the time you want the fax to be sent (in 24-hour format).
Press **Menu/Set**.
(For example, enter 19:45 for 7:45 P.M.)
- 4 Press **1** if you want to leave the document in the ADF. 1 . DOC 2 . MEMORY
—OR—
Press **2** to scan the document into the memory.
- 5 Press **1** if you want to choose more settings and the LCD will return to the **SETUP SEND** menu.
—OR—
Press **2** if you have finished choosing settings, and then go to Step 6.
- 6 Enter the fax number.
- 7 Press **Fax Start**. The fax machine will wait until the time you have entered to send the fax.



- The number of pages you can scan into the memory depends on the amount of data that is printed on each page.
- If you press **2** in Step 4, the scanned document data will be stored until you delete the fax in memory by using the **Canceling a Job** menu setting.

Setting up Polled Transmit

Polled Transmit is when you set up the fax machine to wait with a document so another fax machine can call and retrieve it.

1 Insert the document face down in the ADF.

2 Press **Menu/Set**, **3**, **8**.

8 . POLLED TX

3 Press **▲** or **▼** to choose **ON** (or **OFF**).

POLLED TX : ON ?

Press **Menu/Set**.

4 Press **1** if you want to leave the document in the ADF.

1 . DOC 2 . MEMORY

—**OR**—

Press **2** to scan the document into the memory.

5 Press **1** if you want to choose more settings and the LCD will return to the **SETUP SEND** menu.

—**OR**—

Press **2** if you have finished choosing settings, and go to Step 6.

6 Press **Fax Start**.



■ If you pressed **1** in Step 4, the document remains in the ADF until your fax machine is polled. If you must use your fax machine before the polled Transmit occur, you can “interrupt” it to send another fax. (See *Interrupting Delayed Fax and Polled Transmit jobs* on page 6-13.) The document in the ADF can only be polled once.

■ If you pressed **2** in Step 4, the document will be stored in the memory and can be retrieved from any other fax machine until you delete the fax in memory by using the **Canceling a Job** menu setting.

Memory Transmission

This feature allows the fax machine to scan a fax into its memory and send it as soon as the scan is complete. This way, you don't have to wait for the entire fax to be transmitted before you retrieve your document.

1 Insert the document face down in the ADF.

2 Press **Menu/Set, 3, 9**.

3 To change the default setting, press **▲** or **▼** to select **ON** (or **OFF**).

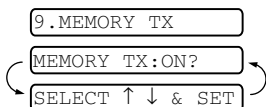

Press **Menu/Set**.

Go to Step 5.

—OR—

For the next fax transmission only, press **▲** or **▼** to select **NEXT FAX ONLY**.

Press **Menu/Set**.

4 For the next fax only, press **▲** or **▼** to select **ON** (or **OFF**).

Press **Menu/Set**.

5 Press **1** to choose more settings. The LCD returns to the **SETUP SEND** menu.

—OR—

Press **2** if you have finished choosing settings and go to Step 6.

6 Enter fax number and press **Fax Start**.

Out of Memory message

If you get an **OUT OF MEMORY** message while scanning the first page of a fax, press **Stop/Exit** to cancel the scan. If you get an **OUT OF MEMORY** message while scanning a subsequent page, you will have the option to press **Fax Start** to send the pages scanned so far, or to press **Stop/Exit** to cancel the operation.



If the faxes you send are typically very large or detailed, you may get **OUT OF MEMORY** errors frequently. If this happens, change the Memory Transmission setting back to **OFF**.

Interrupting Delayed Fax and Polled Transmit jobs

Even if you have your machine set to send a fax later, or if you have it set to be polled, you can interrupt the scheduled job to send a fax or make a copy now. However, you cannot use automatic redial or the Menu mode.

- 1** Press **Menu/Set, 5**. 
- 2** Wait 2 seconds, then remove the documents that are waiting in the ADF.
- 3** Insert the document you want to send now in the ADF.
- 4** Enter the number for the fax you want to send now, and press **Fax Start**.
- 5** After the transmission is finished, return the first document to the ADF.
- 6** Press **Menu/Set, 5** to restore the Delayed Fax or Polled Transmit.



If you set Delayed Fax or Polled Transmit using the memory (that is, if you have already scanned the document into your machine's memory and will send it from there), you don't have to interrupt to send a fax or make a copy.

7 Quick-Dial numbers and dialing options

Storing numbers for easy dialing

You can set up the fax machine to do following types of easy dialing: One-Touch, Speed-Dial and Groups for Broadcasting faxes. When you dial a quick-dial number, the LCD shows the name, if you stored it, or the number.



If you lose electrical power, the quick-dial numbers that are in the memory will not be lost.

Storing One-Touch Dial numbers

Your fax machine has One-Touch keys where you can store fax or phone numbers for automatic dialing. (See *One-Touch dialing* on page 7-5.) One-Touch keys are located on the right side of the control panel.

1 Press **Menu/Set**, **6**, **1**.

1 . ONE-TOUCH DIAL

2 Press the One-Touch key where you want to store a number.

3 Enter the number (up to 20 digits).
Press **Menu/Set**.



To enter a pause in the dialing sequence, press **Redial/Pause**. (See *Pause* on page 7-7.)

4 Use the dial pad to enter the name (up to 15 characters).

NAME :

Press **Menu/Set**. You can use the chart to help you enter letters. (See *Entering text* on page 4-2.)

—OR—

Press **Menu/Set**, to store the number without a name.

5 Press **▲** or **▼** to select the type of number and press **Menu/Set**.

FAX	a fax only number
TEL	a telephone (voice) number
FAX/TEL	both a fax and telephone (voice) number
CHAIN	a number (usually an access code) for chain dialing. Selecting CHAIN tells the fax machine that the complete number has not yet been entered.

6 Return to Step 2 to store another One-Touch number.

—OR—

Press **Stop/Exit** to exit.

Storing Speed-Dial numbers

You can store Speed-Dial numbers, so that when you dial you will only have to press a few keys (**Search/Speed Dial**, #, the two-digit number, and **Fax Start**). The fax machine can store 100 Speed-Dial numbers.

1 Press **Menu/Set**, **6**, **2**.

2 . SPEED-DIAL

2 Use the dial pad to enter a two-digit Speed-Dial number (00-99).

#05 :

(For example, press **0 5**.)

Press **Menu/Set**.

ENTER & SET

3 Enter the phone or fax number (up to 20 digits).

Press **Menu/Set**.



To enter a pause in the dialing sequence, press **Redial/Pause**. (See *Pause* on page 7-7.)

4 Use the dial pad to enter the name (up to 15 characters).

NAME :

Press **Menu/Set**.

(You can use the chart on page 4-2 to help you enter letters.)

—OR—

Press **Menu/Set** to store the number without a name.

5 Press **▲** or **▼** to select the type of number and press **Menu/Set**.

FAX	a fax only number
TEL	a telephone (voice) number
FAX/TEL	both a fax and telephone (voice) number
CHAIN	a number (usually an access code) for chain dialing. Selecting CHAIN tells the fax machine that the complete number has not yet been entered.

6 Go to Step 2 to store another Speed-Dial number.

—OR—

Press **Stop/Exit**.

Changing One-Touch and Speed-Dial numbers

If you try to store a One-Touch or Speed-Dial number where a number has already been stored, the LCD will show the name stored there (or number) and will ask you to do one of the following:

- 1 Press **1** to change the stored number.

1234567

—OR—

1.CHANGE 2.EXIT

Press **2** to exit without making a change.

How to change the stored number or name:

- If you want to change a character, use ◀ or ▶ to position the cursor under the character you want to change, and then type over it.
 - If you want to erase the whole number or whole name, press **Stop/Exit** when the cursor is under the first digit or letter. The characters above and to the right of the cursor will be deleted.
- 2 Enter a new number.
Press **Menu/Set**.
 - 3 Follow the directions beginning at Step 4 in Storing One-Touch Number or Storing Speed-Dial numbers.

Setting up Groups for Broadcasting

Groups, which can be stored on a One-Touch key location, allow you to send the same fax message to many fax numbers by pressing only a One-Touch key and **Fax Start**

First, you will need to store each fax number as a One-Touch or Speed-Dial number. Then, you can combine them into a Group, *Each Group uses up a One-Touch key location.* Finally, you can have up to four small Groups, or you can assign up to 103 numbers to one large Group.

(See *Storing One-Touch Dial numbers* on page 7-1 and *Storing Speed-Dial numbers* on page 7-2.)

1 Press **Menu/Set, 6, 3.**

3 . SETUP GROUPS

2 Select a One-Touch key where you wish to store the number. (For example, press One-Touch key **2** to store a Group.)

3 Use the dial pad to enter the Group number (1 to 4) and press **Menu/Set.**

SETUP GROUP : G0

ENTER & SET

(For example, press **1** for Group 1.)

To include One-Touch or Speed-Dial numbers in the Group, enter them as follows. For example, for One-Touch key 3, press One-Touch key **3**. For Speed-Dial location 09, press **Search/Speed Dial**, then press **0, 9** on the dial pad.

The LCD shows *03, #09.

G01 : *03#09

4 Press **Menu/Set** to accept the numbers for this group.

5 Use the dial pad to enter a name for the group and press **Menu/Set.**

NAME :

ENTER & SET

(For example, NEW CLIENTS)

(See *Entering text* on page 4-2.)

6 Press **Stop/Exit.**



You can print a list of all One-Touch and Speed-Dial numbers. Group numbers will be marked in the GROUP column.

(See *Printing reports* on page 9-2.)

Dialing options

You can use the fax machine to make voice telephone calls by dialing manually or by using Search, One-Touch or Speed-Dial memory. You can use the handset to make calls.

When you dial a quick-dial number, the LCD shows the name you've stored, or if you haven't stored a name, the fax number you've stored.

Manual dialing

Manual dialing is simply pressing all of the digits of the phone number.

- 1 Pick up the handset.
—OR—
Press **Hook**
- 2 When you hear a dial tone, dial the call using the dial pad.
- 3 If you pressed **Hook** to dial the call, pick up the handset when the other party answers. (The speaker works only one way; the other party won't be able to hear you unless you pick up the handset.)
- 4 To hang up, replace the handset.
—OR—
Press **Hook**.

One-Touch dialing

- 1 Pick up the handset.
—OR—
Press **Hook**.
- 2 When you hear a dial tone, press the One-Touch key of the location you want to call.
- 3 If you pressed **Hook** to dial the call, pick up the handset when the other party answers. (The speaker works only one way; the other party won't be able to hear you unless you pick up the handset.)
- 4 To hang up a voice call, replace the handset.



If the LCD shows **NOT REGISTERED** when you press the One-Touch key, a number has not been stored for it.

If you are sending a fax, press **Fax Start** after pressing the One-Touch key. If you picked up the handset or pressed **Hook**, press **Fax Start** when the receiving fax machine answers with fax tones.

Speed-Dialing

- 1 Pick up the handset.
—OR—
Press **Hook**.
 - 2 When you hear a dial tone, press **Search/Speed Dial**, press #, and then press the two-digit Speed-Dial number.
 - 3 If you pressed **Hook** to dial the call, pick up the handset when the other party answers. (The speaker works only one way; the other party won't be able to hear you unless you pick up the handset.)
 - 4 To hang up a voice call, replace the handset.
- If the LCD shows **NOT REGISTERED** when you press the Speed-Dial 2-digit number, a number has not been stored for it.
 - If you are sending a fax, press **Fax Start** after entering the Speed-Dial number. If you picked up the handset or pressed **Hook**, press **Fax Start** when the receiving fax machine answers with fax tones.

Access codes and credit card numbers

Sometimes you may want to choose from several long distance carriers when you make a call. Rates may vary depending on the time and destination. To take advantage of low rates, you can store the access codes or long-distance carriers and credit card numbers as One-Touch and Speed-Dial numbers. You can store these long dialing sequences by dividing them and setting them up on separate keys in any combination. Make sure you have selected **CHAIN** as the type of number when you stored the beginning portions of a long number.

The combined number will be dialed in the order that you entered it as soon as you press **Fax Start**.

(See *Storing Speed-Dial numbers* on page 7-2.)

Perhaps you have stored '555' on Speed-Dial #03 and '7000' on Speed-Dial #02. If you press **Search/Speed Dial**, #03, **Search/Speed Dial**, #02, and **Fax Start**, you will dial '555-7000'.

To temporarily change a number, you can substitute part of the number with manual using the dial pad.

For example, to change the number to 555-7001 you could press **Search/Speed Dial**, #03 and then press **7001** using the dialing pad.

- If you must wait for another dial tone or signal at any point in the dialing sequence, store a pause there in the number by pressing **Redial/Pause**. Each key press adds a 3.5-second delay.

#05 :

ENTER & SET

Search

You can search for names you have stored in One-Touch and Speed-Dial memories. (See *Storing One-Touch Dial numbers* on page 7-1 and *Storing Speed-Dial numbers* on page 7-2.)

- 1 Pick up the handset.
- 2 Press **Search/Speed Dial**, then enter the first letter of the name you are looking for by using the dial pad.
- 3 Press ◀ or ▶ to search the names that are displayed alphabetically.
- 4 When the screen displays the name you want to call, press **Fax Start** to begin dialing.
- 5 To hang up, replace the handset.

Pause

Press **Redial/Pause** to insert a 3.5-second pause between numbers. If you are dialing overseas, you can press **Redial/Pause** as many times as needed to increase the length of the pause.

Hold

- 1 Press **Hold/Caller ID** to put a call on Hold.
- 2 You can replace the handset without disconnecting the call.
- 3 Pick up the fax machine's handset to release the call from Hold. Picking up an extension handset will not release the call from Hold.

Redial (Telephone)

If you are calling someone and the line is busy, you can retry the number by pressing **Redial/Pause**.

- 1 Pick up the handset.
- 2 Press **Redial/Pause**.
- 3 To hang up, replace the handset.

Redial (Fax)

If you're sending a fax manually and the line is busy, press **Redial/Pause** to try again. Any time you want to make a second call to the last number dialed, press **Redial/Pause** to save time.

If you're sending a fax automatically and the line is busy, the fax machine will automatically redial one time at five minutes intervals after the transmission.

Tone or Pulse (Canada only)

If you have a Pulse dialing service, but need to send Tone signals (for example, for telephone banking), follow the instructions below. If you have Touch Tone service, you will not need this feature to send tone signals.

- 1 Pick up the handset.
- 2 Press #. Any digits dialed after this will send tone signals.
- 3 When you hang up, the fax machine will return to the Pulse dialing service.

8

Remote Fax Options

Fax Forwarding



You can only use one remote fax option at a time:

Fax Forwarding—OR—Paging—OR—Fax Storage—OR—Off.

You can change your selection at any time (**Menu, 8, 1**).

(See *Turning off Remote Fax Options* on page 8-3.)

Setting up Fax Forwarding

When you select Fax Forward, your fax machine stores the received fax in the memory. The fax machine will then dial the fax number you've programmed and forwards the fax message.

1 Press **Menu/Set, 8, 1**.

1 . FWD / PAGE / STORE

2 Press **▲** or **▼** to select

FAX FORWARD.

Press **Menu/Set**.

3 Enter the forwarding number (up to 20 digits).

Press **Menu/Set**.

4 Press **▲** or **▼** to select

BACKUP PRINT : ON or

BACKUP PRINT : OFF.

BACKUP PRINT : ON

SELECT ↑ ↓ & SET

Press **Menu/Set**.



■ If you select **BACKUP PRINT : ON**, faxes will also be printed at your fax machine so you will have a copy if there is a power failure before it is forwarded or a problem at the receiving machine.

■ If you select **BACKUP PRINT : OFF** and a problem occurs during Fax Forwarding, then your received fax might be erased from memory before it can be printed.

The LCD will ask you to enter the fax number to which faxes will be forwarded.

5 Press **Stop/Exit**.

Programming your pager number

When Paging is selected, your fax machine dials the pager number you've programmed, and then dials your Personal Identification Number (PIN). This activates your pager so you will know that you have a fax message in the memory.

1 Press **Menu/Set**, **8**, **1**.

1. FWD/PAGE/STORE

2 Press **▲** or **▼** to select **PAGING**.

3 Enter your pager phone number followed by **# #** (up to 20 digits).

Press **Menu/Set**.

4 Do not include the area code if it is the same as that of your fax machine.

For example, press **1 8 0 0 5 5 5 1 2 3 4 # #**.

5 If your pager needs a PIN, enter the PIN, press **#**, press **Redial/Pause**, enter your fax number followed by **# #**.

Press **Menu/Set**.

(For example, press **1 2 3 4 5 # Redial/Pause 1 8 0 0 5 5 5 1 2 1 2 # #**)

—OR—

If you do not need a PIN, press **Redial/Pause**, enter your fax number followed by **# #**.

Press **Menu/Set**.

(For example, press **Redial/Pause 1 8 0 0 5 5 5 1 2 1 2 # #**)

6 Press **Stop/Exit**.



You cannot change a Paging number or PIN remotely. If you have set Paging, a backup copy will automatically be printed at the fax machine.

Setting Fax Storage

If you select Fax Storage, your fax machine stores the received fax in the memory. You will be able to retrieve fax messages from another location using the Remote Retrieval commands.

1 Press **Menu/Set**, **8**, **1**.

1 . FWD / PAGE / STORE

2 Press **▲** or **▼** to select
FAX STORAGE.

Press **Menu/Set**.

3 Press **Stop/Exit**.



If you have set Fax Storage, a backup copy will automatically be printed at the fax machine.

Turning off Remote Fax Options

If you set the **FWD / PAGE / STORE** to **OFF** and there are faxes in your fax machine's memory, the LCD will give you two options.

- If you press **1**, all unprinted faxes will be printed and erased before the setting turns off. If a backup copy has already been printed it will not be printed again.
- If you press **2**, the memory will not be erased and the setting will be unchanged.

Setting your remote access code

The remote access code lets you access the Remote Retrieval features when you are away from the fax machine. Before you use the remote access and retrieval features, you have to set up your own code. The default code is inactive code (**--- ***).

1 Press **Menu/Set**, **8**, **2**.

2 . REMOTE ACCESS

2 Enter a three-digit code using
numbers 0-9.

Press **Menu/Set**. (The "*****" cannot be changed.)



Do not use the same code which is set in your Fax Receive Code (***51**) or Telephone Answer Code (**#51**).
(See *Operation from extension telephones* on page 5-5.)

3 Press **Stop/Exit**.



You can change your code at any time by entering a new one.
If you want to make your code inactive, press **Stop/Exit** in Step 2 to restore the inactive setting (**--- ***).

Remote Retrieval

You can call your fax machine from any touch tone telephone or fax machine, then use the Remote Access Code and remote commands to retrieve fax messages. Be sure to cut out the Remote Retrieval Access Card on the last page and keep it with you at all times.

Using your remote access code

- 1** Dial the fax number from a telephone or another fax machine using touch tone.
- 2** When the fax machine answers, immediately enter your Remote Access Code (3 digits followed by *).
- 3** The fax machine signals if it has received fax messages:
1 long beep — Fax messages
No beeps — No fax messages
- 4** The fax machine gives two short beeps, which tells you to enter a command. The fax machine will hang up if you wait longer than 30 seconds to enter a command. The fax machine will beep three times, if you enter an invalid command.
- 5** Press **90** to reset the fax machine when you've finished.
- 6** Hang up.

Remote commands

Follow the commands below to access features when you are away from the fax machine. When you call the fax machine and enter your Remote Access Code (3 digits followed by *), the system will give two short beeps and you must enter a remote command.

Remote commands	Operation details
95 Change the Fax Forwarding or Paging settings	
1 OFF	You can select OFF after you have registered or erase all the fax messages.
2 Fax Forwarding	If you hear one long beep, the change has been accepted. If you hear three short beeps, you cannot change it because something has not been set up (for example, perhaps a fax forwarding or paging number had not been registered). You can register your Fax Forwarding number by entering 4 (see page 8-6). Once you have registered the number, Fax Forwarding will work.
3 Paging	
4 Fax Forwarding number	
6 Fax Storage	You can turn FAX Storage to ON (or OFF after you have retrieved or erased all your messages.)
96 Retrieve a fax	
1 Print a memory status list	Enter the number of a remote fax machine to print a memory status list.
2 Retrieve all faxes	Enter the number of a remote fax machine to receive stored fax messages. (See page 8-6.)
3 Erase faxes from the memory	If you hear one long beep, you can erase fax messages from the memory.
97 Check the Receiving Status	
1 Fax	You can check whether the fax machine has received any faxes. If yes, you will hear one long beep. If no, you will hear three short beeps.
98 Change the Receive Mode	
1 TAD:ANSWER MACH.	If you hear one long beep, your change has been accepted.
2 FAX/TEL	
3 FAX ONLY	
90 Exit	Press 9 0 to exit Remote Retrieval. Wait for the long beep, then replace the handset.

Retrieving fax messages

- 1 Dial your fax number.
- 2 When your fax machine answers, immediately enter your Remote Access Code (3 digits followed by *). If you hear one long beep, you have messages.
- 3 As soon as you hear two short beeps, use the dial pad to press **9 6 2**.
- 4 Wait for the long beep, and then use the dial pad to enter the number of the remote fax machine where you want your fax messages sent to followed by # # (up to 20 digits).



You cannot use * and # as dial numbers. However, press # if you want to store a pause.

- 5 Hang up after you hear your fax machine beep. Your fax machine will call the other machine, which will then print your fax messages.

Changing your Fax Forwarding number

The default setting of your fax forward number that has been previously stored can be changed from another telephone or fax machine using Touch Tone.

- 1 Dial your fax number.
- 2 When your fax machine answers, immediately enter your Remote Access Code (3 digits followed by *). If you hear one long beep, you have messages.
- 3 When you hear two short beeps, use the dial pad to press **9 5 4**.
- 4 Wait for the long beep, and then use the dial pad to enter the new number of the remote fax machine you want your fax messages forwarded to followed by # # (up to 20 digits).



You cannot use * and # as dial numbers. However, press # if you want to store a pause.

- 5 Hang up after you hear the fax machine beep.

9 Printing reports

FAX settings and activity

Your fax machine can print a Transmission Verification Report after each fax you send. Also, a journal of sent and received faxes can be printed at specified intervals.

Customizing the Transmission Verification Report

You can use the Transmission Report as proof that you sent a fax. This report lists the time and date of transmission and whether the transmission was successful (OK). If you select **ON**, the report will print for every fax you send.

 When the feature is **OFF**, the Report will only print if there is a transmission error (NG).

- 1 Press **Menu/Set**, **7**, **1**.
- 2 Press **▲** or **▼** to select **ON** or **OFF**.
Press **Menu/Set**.
- 3 Press **Stop/Exit**.

1. TRANSMISSION

Setting the Journal Period

You can set the fax machine to print a journal at specific intervals (every 30 faxes, 6, 12 or 24 hours, 2 or 7 days). If you set the journal period to **OFF**, you can print the report by following the steps on the next page.

The default setting is **EVERY 30 FAXES**.

- 1 Press **Menu/Set**, **7**, **2**.
- 2 Press **▲** or **▼** to choose a journal period.
- 3 Press **Menu/Set**.
(If you choose 7 days, the LCD will ask you to choose a day on which to begin the 7-day countdown.)
- 4 Enter the time to begin printing in 24-hour format.
Press **Menu/Set**.
(For example: enter 19:45 for 7:45 P.M.)
- 5 Press **Stop/Exit**.

2. JOURNAL PERIOD

 If you select 6, 12, 24 hours, 2 or 7 days, the fax machine will print the report at the selected time and then erase all jobs from its memory. If the fax machine's memory becomes full with 30 jobs before the time you selected has passed, the fax machine will print the Journal early and then erase all jobs from memory. If you want an extra report before it is due to print, you can print it without erasing the jobs from memory.

Printing reports

Following reports are available:

1. TRANSMISSION

Prints a Transmission Verification Reports for the last fax that was sent. This information will remain until you pick up the handset.

2. HELP LIST

Prints the Help List so you can see at-a-glance how to quickly program your fax machine.

3. QUICK-DIAL

Lists names and numbers stored in One-Touch and Speed-Dial memory, in numerical order.

4. FAX JOURNAL

Lists information about the last incoming and outgoing faxes. (TX means Transmit.) (RX means Receive.)

5. TEL. INDEX

Quick-Dial list (above), alphabetically.

6. USER SETTINGS

Lists your settings.

7. MEMORY STATUS

Lists summary information and amount of occupied memory.

How to print a report

- 1 Make sure that there is no document in the ADF.
- 2 Press **Copy/Reports**, then enter the number (see list above) of the report you want to print. For example, press **6** to print the `USER SETTINGS`.

10 Making copies

Using the fax machine as a copier

You can use this fax machine as a copier. Always make sure you have paper in the paper tray before making copies.

Copy Key



Incoming faxes cannot be received on paper or into the memory while the fax machine is copying.

Copy operations

To make a single copy that is not reduced, enlarged or sorted, you only have to press one key. Remember, your fax machine cannot scan anything closer than 1/6 in. (4 mm) from the edge of the paper.

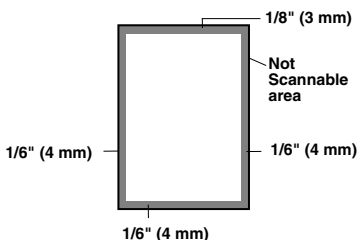

Making a single copy

- 1 Insert the document face down in the ADF.
- 2 Press **Copy/Reports** twice.
To cancel, press **Stop/Exit**.
Do NOT pull on the paper while copying is in progress.



The default resolution for a single copy is **S.FINE**. Set the resolution to **PHOTO** for photographs by using the **Resolution** key.

Copy options: Single or Multiple copies, Sort/Stack, Reduce/Enlarge

You can choose additional copy options. First, you can select the number of copies. Next, you can choose whether multiple copies will be STACKED (all copies of page 1, then all copies of page 2, etc.) or SORTED (collated). Finally, you can choose an enlargement or reduction ratio. To automatically reduce the copy to the paper size you have set for the paper tray, select **AUTO**. To reduce the copy by a fixed percentage, choose 93%, 87%, 75% or 50%. Or, to enlarge the copy, select 150%, 125% or 120%. To copy a document at its document size, select 100%.

1 Insert the document face down in the ADF.

2 Press **Copy/Reports**.

3 Enter the number of copies you want (1-99).

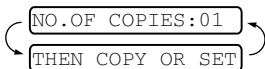

To start copying now, press **Copy/Reports**.

If you would like to select additional copy options, like **SORT**, **ELG/RDC** (Enlarge or Reduce) press **Menu/Set**.

4 Press **▲** or **▼** to select **SORT** or **STACK**.

To start copying now without enlarging or reducing, press **Copy/Reports**.

To reduce or enlarge the image, press **Menu/Set**.

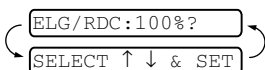

5 Press **▲** or **▼** to select an enlargement or reduction ratio.

6 Press **Copy/Reports**.

 If you are making multiple copies and get a **OUT OF MEMORY** message while you are scanning the first page, press **Stop/Exit** to cancel the job. Then make a single copy. If you selected **SORT** and the **OUT OF MEMORY** message appears while scanning subsequent pages, you can press **Copy/Reports** to copy the portion that is in memory, or press **Stop/Exit** to cancel. To restart the copy job using less memory, press **Copy/Reports** for stacked copies.

 The default resolution for multiple copies or reducing and enlarging copies is **FINE**. Set the resolution to **S.FINE** for small print or artwork and **PHOTO** for photographs by using the **Resolution** key. **S.FINE** and **PHOTO** resolutions use up more memory than **FINE** mode.

Standard telephone and FCC Notices

These notices are in effect on models sold and used in the United States only.

This equipment is hearing-aid compatible.

When programming emergency numbers or making test calls to emergency numbers:

- Remain on the line and briefly explain to the dispatcher the reason for the call before hanging up.
- Perform these activities in the off-peak hours, such as early morning or late evening.

This equipment complies with Part 68 of the FCC rules and the requirements adopted by the ACTA. On the backside of this equipment is a label that contains, among other information, a product identifier in the format US: AAAEQ##TXXXX. If requested, this number must be provided to the telephone company.

You may safely connect this equipment to the telephone line by means of a standard modular jack, USOC RJ11C.

A plug and jack used to connect this equipment to the premises wiring and telephone network must comply with the applicable FCC Part 68 rules and requirements adopted by the ACTA. A compliant telephone cord and modular plug is provided with this product. It is designed to be connected to a compatible modular jack that is also compliant. See installation instructions for details.

The REN is used to determine the number of devices that may be connected to a telephone line. Excessive RENs on a telephone line may result in the devices not ringing in response to an incoming call. In most but not all areas, the sum of RENs should not exceed five (5.0). To be certain of the number of devices that may be connected to a line, as determined by the total RENs, contact the local telephone company. For products approved after July 23, 2001, the REN for this product is part of the product identifier that has the format US:AAAEQ##TXXXX. The digits represented by ## are the REN without a decimal point (e.g., 06 is a REN of 0.6). For earlier products, the REN is separately shown on the label.

If this equipment causes harm to the telephone network, the telephone company will notify you in advance that temporary discontinuance of service may be required. But if advance notice isn't practical, the telephone company will notify the customer as soon as possible. Also, you will be advised of your right to file a complaint with the FCC if you believe it is necessary.

The telephone company may make changes in its facilities, equipment, operations or procedures that could affect the operation of the equipment. If this happens the telephone company will provide advance notice in order for you to make necessary modifications to maintain uninterrupted service.

If trouble is experienced with this equipment, for repair or warranty information, please contact Brother Customer Service. (See *Brother numbers* on page i.) If the equipment is causing harm to the telephone network, the telephone company may request that you disconnect the equipment until the problem is resolved.

Connection to party line service is subject to state tariffs. Contact the state public utility commission, public service commission or corporation commission for information.

If your home has specially wired alarm equipment connected to the telephone line, ensure the installation of this equipment does not disable your alarm equipment. If you have questions about what will disable alarm equipment, call your telephone company or a qualified installer.

If you are not able to solve a problem with the fax machine, call Brother Customer Service. (See *Brother numbers* on page i.)

WARNING

For protection against the risk of electrical shock, always disconnect all cables from the wall outlet before servicing, modifying or installing the equipment.

This equipment may not be used on coin service lines provided by the telephone company or connected to party lines.

Brother cannot accept any financial or other responsibilities that may be the result of your use of this information, including direct, special or consequential damages. There are no warranties extended or granted by this document.

WARNING

This fax machine has been certified to comply with FCC standards, which are applied to the USA only. A grounded plug should be plugged into a grounded AC outlet after checking the rating of the local power supply for the fax machine to operate properly and safely.

Federal Communications Commission (FCC) Declaration of Conformity (USA only)

Responsible Party: Brother International Corporation
100 Somerset Corporate Boulevard
Bridgewater, NJ 08807-0911 USA
TEL: (908) 704-1700

declares, that the products

Product Name: FAX575

comply with Part 15 of the FCC Rules. Operation is subject to the following two conditions: (1) This device may not cause harmful interference, and (2) this device must accept any interference received, including interference that may cause undesired operation.

This equipment has been tested and found to comply with the limits for a Class B digital device, pursuant to Part 15 of the FCC Rules. These limits are designed to provide reasonable protection against harmful interference in a residential installation. This equipment generates, uses, and can radiate radio frequency energy and, if not installed and used in accordance with the instructions, may cause harmful interference to radio communications. However, there is no guarantee that interference will not occur in a particular installation. If this equipment does cause harmful interference to radio or television reception, which can be determined by turning the equipment off and on, the user is encouraged to try to correct the interference by one or more of the following measures:

- Reorient or relocate the receiving antenna.
- Increase the separation between the equipment and receiver.
- Connect the equipment into an outlet on a circuit different from that to which the receiver is connected.
- Call the dealer or an experienced radio/TV technician for help.

Important

Changes or modifications not expressly approved by Brother Industries, Ltd. could void the user's authority to operate the equipment.

Industry Canada Compliance Statement (Canada only)

This Class B digital apparatus complies with Canadian ICES-003.

Cet appareil numérique de la classe B est conforme la norme NMB-003 du Canada.

International ENERGY STAR® Compliance Statement

As an ENERGY STAR® Partner, Brother Industries, Ltd. has determined that product meets the ENERGY STAR® guidelines for energy efficiency.



Important safety instructions

- 1** Read all of these instructions.
- 2** Save them for later reference.
- 3** Follow all warnings and instructions marked on the product.
- 4** Unplug this product from the AC power outlet before cleaning. To clean the inside of the machine, use a dry, lint-free cloth, however, do not use liquid or aerosol cleaners.
- 5** Do not use this product near water.
- 6** Do not place this product on an unstable cart, stand, or table. The product may fall, causing serious damage to the product.
- 7** Slots and openings in the cabinet and the back or bottom are provided for ventilation; to ensure reliable operation of the product and to protect it from overheating, these openings must not be blocked or covered. The openings should never be blocked by placing the product on a bed, sofa, rug, or other similar surface. This product should never be placed near or over a radiator or heater. This product should never be placed in a built-in installation unless proper ventilation is provided.
- 8** This product should be operated from the type of power source indicated on the label. If you are not sure of the type of power available, call your dealer or local power company.
- 9** This product is equipped with a 3-wire grounded type plug, a plug having a third (grounded) pin. This plug will only fit into a grounded-type power outlet. This is a safety feature. If you are unable to insert the plug into the outlet, call your electrician to replace your obsolete outlet. Do not defeat the purpose of the grounded-type plug.
- 10** Do not allow anything to rest on the power cord. Do not place this product where people can walk on the cord.
- 11** If an extension cord is used with this product, make sure that the total ampere ratings on the products plugged into the extension cord do not exceed the extension cord ampere rating. Also, make sure that the total of all products plugged into the wall outlet does not exceed 15 amperes (USA only).
- 12** Do not place anything in front of the fax machine that will block received faxes. Do not place anything in the path of received faxes.
- 13** Wait until pages have exited the fax machine before picking them up.
- 14** Never push objects of any kind into this product through cabinet slots, since they may touch dangerous voltage points or short out parts resulting in the risk of fire or electric shock. Never spill liquid of any kind on the product.
- 15** Do not attempt to service this product yourself, as opening or removing covers may expose you to dangerous voltage points and/or other risks, and may void your warranty. Refer all servicing to Brother Authorized Service Personnel. A list of Authorized Service Centers has been included for your convenience, or you may contact Brother Customer Service for your nearest Brother Authorized Service Center.
(See *Brother numbers* on page i.)

- 16** Unplug this product from the AC power outlet and refer servicing to Authorized Service Personnel under the following conditions:
- When the power cord is damaged or frayed.
 - If liquid has been spilled into the product.
 - If the product has been exposed to rain or water.
 - If the product does not operate normally when the operating instructions are followed. Adjust only those controls that are covered by the operating instructions. Improper adjustment of other controls may result in damage and will often require extensive work by a qualified technician to restore the product to normal operation.
 - If the product has been dropped or the cabinet has been damaged.
 - If the product exhibits a distinct change in performance, indicating a need for service.
- 17** To protect your product against power surges, we recommend the use of a power protection device (Surge Protector).

Trademarks

The Brother logo is a registered trademark of Brother Industries, Ltd. Brother is a registered trademark of Brother Industries, Ltd.

© 2004 Brother Industries, Ltd. All rights reserved.

All other brand and product names mentioned in this manual are registered trademarks of their respective companies.

Shipment of the fax machine

If for any reason you must ship your fax machine, carefully package the fax machine to avoid any damage during transit. We recommend that you save and use the original packaging. The fax machine should also be adequately insured with the carrier.

12 Troubleshooting and routine maintenance

Troubleshooting

IMPORTANT

For technical help, you must call the country where you bought the fax machine. Calls must be made **from within** that country.

Error messages

As with any sophisticated office product, errors may occur. If this happens, your fax machine identifies the problem and displays an error message. The most common error messages are shown below.

You can correct most problems by yourself. If you need more help, call the Brother fax back system (USA only).

In USA only: 1-800-521-2846

ERROR MESSAGES		
ERROR MESSAGE	CAUSE	ACTION
CHECK PAPER RELOAD PAPER PRESS STOP KEY	The fax machine is out of paper or paper is not properly loaded in the paper tray.	Refill the paper or remove the paper and load it again. If this error appears while receiving a fax, load paper to restart printing. If you were copying or printing reports, load paper and try again. (See <i>How to load paper</i> on page 2-2)
	The paper is jammed in the fax machine.	See <i>Paper Jam</i> on page 12-5.
COVER IS OPEN CLOSE COVER	The cover is not closed completely.	Close the cover.
DOCUMENT JAM REMOVE JAM PRESS STOP KEY	The documents were not inserted or fed properly, or were too long. (See <i>Document Jam</i> on page 12-4.)	Insert the document again.
	The document is jammed in the fax machine.	See <i>Document Jam</i> on page 12-4.
DR MODE IN USE	The fax machine is set to Distinctive Ring mode. You can not change the Receive Mode from Manual to another mode.	Set Distinctive Ring to off.
LINE DISCONNECT	The other person or other person's fax machine stopped the call.	Try to send again.
MEMORY NEAR FULL CLEAR MEMORY	The fax machine is almost out of memory.	Clear the faxes and scheduled jobs from the memory. —OR— Print the faxes that are in the memory. (See <i>Printing a fax from the memory</i> on page 5-6.)

ERROR MESSAGES		
ERROR MESSAGE	CAUSE	ACTION
NOT REGISTERED	You tried to access a One-Touch or Speed-Dial number that is not programmed.	Set up the One-Touch or Speed-Dial number. (See <i>Storing One-Touch Dial numbers</i> on page 7-1 and <i>Storing Speed-Dial numbers</i> on page 7-2.)
OUT OF MEMORY CLEAR MEMORY	The data is too large for the fax machine's memory.	(Fax sending or copy operation in process) Press Stop/Exit and wait until the other operations in progress finish and then try again. —OR— Clear the faxes and schedule jobs in the memory. To gain extra memory, you can turn off Fax Storage. (<i>Setting Fax Storage</i> on page 8-3.) —OR— Print the faxes that are in the memory. (<i>Printing a fax from the memory</i> on page 5-6)
PAPER JAM PLS OPEN COVER REMOVE JAM	The paper is jammed in the fax machine.	(See <i>Paper Jam</i> on page 12-5.)
PHONE LINE BUSY	The number you dialed does not answer or is busy.	Verify the number and try again.
POLLING FAILED	You tried to poll a fax machine that is not in Polled Waiting mode.	Check the other fax machine's polling setup.
PRINTHEAD OVERHEATED WAIT TO COOL	The print head has overheated.	Wait 30 minutes for it to cool or wait until the message disappears automatically.
RECEIVE FAILED	Poor phone line quality caused a communication error.	If the problem continues, call the telephone company and ask them to check your phone line.
RIBBON EMPTY RESET OR REPLACE	Your fax machine is out of ribbon or the print cartridge is not properly installed.	Install the print cartridge or change the ribbon again. (See <i>Changing the ribbon</i> on page 12-9.)

ERROR MESSAGES

ERROR MESSAGE	CAUSE	ACTION
<p>MEMORY DISABLED UNABLE TO INIT UNABLE TO PRINT UNABLE TO SCAN</p>	<p>The fax machine has a mechanical problem. —OR— A foreign obstacle, such as a clip or ripped paper, is in the fax machine.</p>	<p>Open the top cover and remove any foreign obstacles from inside the fax machine. If the error message continues, disconnect the fax machine from the power source for several minutes then reconnect it. You will lose all faxes in the memory. Please follow the steps below before disconnecting the fax machine so you will not lose any important messages.</p> <p>Check whether the fax machine has faxes in the memory</p> <ol style="list-style-type: none"> 1. Press Menu/Set, 0, 0, 1. 2. If the fax machine does not have faxes in its memory, disconnect the fax machine from the power source for several minutes and then reconnect it. <p>—OR—</p> <p>If faxes are present, you can transfer them to another fax machine. Go to Step 3.</p> <p>Transfer faxes to another fax machine</p> <ol style="list-style-type: none"> 3. Enter the fax number to which faxes will be forwarded. 4. Press Fax Start. 5. After the faxes are transferred, disconnect the fax machine from the power source for several minutes and then reconnect it. <p>Transfer Journal report to another fax machine</p> <p>You can transfer the Fax Journal report to another fax machine.</p> <ol style="list-style-type: none"> 1. Press Menu/Set, 0, 0, 2. 2. Enter the fax number to which faxes will be forwarded. 3. Press Fax Start. <p>If you have not set up your Station ID, you cannot enter fax transfer mode.</p> <p>If the error message still continues, call Brother Customer Service.</p> <p>In USA: 1-800-284-4329</p> <p>In Canada: 1-877-BROTHER</p>

Compatibility

If you are having difficulty sending or receiving a fax due to possible interference on the phone line, we recommend that you try setting the compatibility to **BASIC**.

- 1 Press **Menu/Set, 0, 1**.
- 2 Press **▲** or **▼** to select **BASIC** (or **NORMAL**).
Press **Menu/Set**.
- 3 Press **Stop/Exit**.

1 . COMPATIBILITY

Document Jam or Paper Jam

Document Jam

The documents were not inserted or fed properly, or were too long.

- 1 Remove any paper from ADF that is not jammed.
- 2 Open the top cover by lifting the lever on the right side of the top cover.

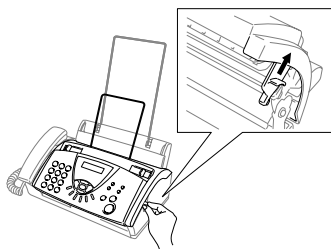

- 3 Pull the document toward the front of your fax machine.

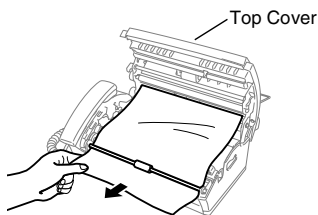

Document is jammed.

- 4 Close the top cover. Press down on both sides of the top cover until it clicks.

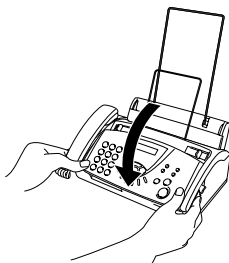

Paper Jam

The paper is jammed in your fax machine.

- 1 Remove any paper that is not jammed.

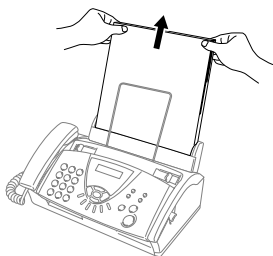

- 2 Open the top cover by lifting the lever on the right side of the top cover.

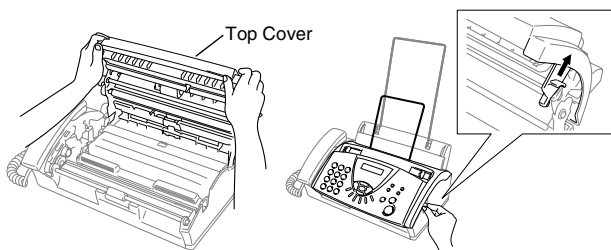

- 3 Pull the jammed paper gently from the paper feeder toward the front of the fax machine as per diagram A.
If you can't, pull the jammed paper towards the back and remove it as per diagram B.

Diagram A

Diagram B

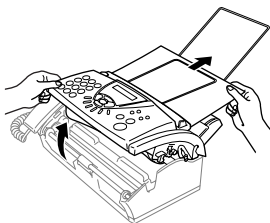
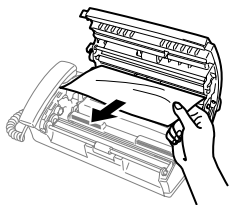

Printout is jammed.

- 4 Close the top cover. Press down on both sides of the top cover until it clicks.
- 5 Put the paper back into the paper tray.

If you are having difficulty with the fax machine

If you think there is a problem with your fax machine or the way your faxes look, *make a copy first*. If the copy looks good, the problem is probably not the fax machine. Check the chart below and follow the troubleshooting tips.

DIFFICULTY	SUGGESTIONS
Printing or Receiving Faxes	
Condensed print and white streaks across the page or the top and bottom of sentences are cut off.	If your copy looks good, you probably had a bad connection, with static or interference on the phone line. If the copy looks bad, call Brother Customer Service at 1-800-284-4329 (in USA) or 1-877-BROTHER (in Canada).
Vertical black lines when receiving.	Your machine's print head might be dirty. Clean the print head. (See <i>Cleaning the print head</i> on page 13-9.) The sender's scanner may be dirty. Ask the sender to make a copy to see if the problem is with the sending machine. Try receiving from another fax machine. If the problem continues, call Brother Customer Service at 1-800-284-4329 (in USA) or 1-877-BROTHER (in Canada).
Phone Line or Connections	
The fax machine does not answer when called.	Make sure the fax machine is in the correct receiving mode for your setup. (See <i>Choosing the Receive Mode</i> on page 5-1.) Check for a dial tone. If possible, call the fax machine to hear it answer. If there is still no answer, check the telephone line cord connection. Connect a standard telephone to the fax machine's telephone wall jack. If there is no ringing when you call the fax machine, ask your telephone company to check the line.
External Telephone answering device (TAD) does not answer when called	Make sure the telephone line cord from your TAD is connected to the back of the fax machine, in the jack labeled EXT. (See <i>Connecting an external telephone answering device (TAD)</i> on page 1-8.) Make sure the TAD is set to answer calls.
No dial tone on the handset	Press Hook—OR—Lift the handset. If you don't hear a dial tone, check telephone line cord connections at the fax machine and wall jack. Check that the handset is connected to the fax machine's handset jack. Test the wall jack with another single line telephone. If there is no dial tone at the wall outlet, call your telephone company.
The Caller ID does not display after the Call Waiting signal	The Caller ID signal is sent ten seconds after the Call Waiting Signal and speaking may interfere with it. When you hear the Call Waiting signal, ask the other party to hold while you answer the call. Then stop speaking until you see the Caller ID on the LCD.
Receiving Faxes	
Cannot receive a fax	Make sure that the fax machine is in the correct receiving mode for your setup. (See <i>Choosing the Receive Mode</i> on page 5-1.)
	If there seems to be interference on your phone line, try setting the Compatibility to BASIC. (See <i>Compatibility</i> on page 12-4.)

DIFFICULTY	SUGGESTIONS
Sending Faxes	
Cannot send a fax	Ask the other party to check that the receiving machine has paper. Print the Transmission Verification Report and check for an error. (See <i>Printing reports</i> on page 9-1.)
Poor sending quality.	Try changing your resolution to FINE or S.FINE . Make a copy to check the fax machine's scanner operation.
Dialing does not work	Check all line cord connections and make sure the curled handset cord is not in the EXT jack. Check the power cord connection. Send a manual fax by pressing Hook or by lifting the handset and dialing the number. Wait to hear fax receiving tones before pressing Fax Start . (Canada only) Change the Tone/Pulse setting. (See <i>Setting Tone and Pulse dialing mode (Canada Only)</i> on page 4-6.)
Vertical black lines when sending.	Use the fax machine to make a copy. If the copy shows the same problem, the scanner area is dirty. Lift the top cover and check the document path. Clean the white film and the scanner's glass strip using isopropyl alcohol and a lint-free cloth. (See <i>Cleaning the scanner</i> on page 12-9.)
Transmission Verification Report prints "RESULT: NG"	There is probably temporary noise or static on the phone line. Try sending the fax again. Try setting the Compatibility to BASIC . (See <i>Compatibility</i> on page 12-4.) If the problem continues, call the telephone company to check your phone line.
Handling Incoming Calls	
Double-ring in FAX/TEL mode	The fax machine knows the incoming call is not a fax so it is signaling you to answer the telephone call. Pick up the fax machine's handset or answer from an extension phone, and then press the fax machine's Telephone Answer Code (default setting is #51). (See <i>For FAX/TEL mode only</i> on page 5-5.)
Transferring a call to the fax machine	If you have answered at the fax machine's handset, press Fax Start and hang up immediately. If you answered at an extension phone, press your three-digit Fax Receive Code (default setting is *51). When the fax machine answers, hang up.
The fax machine "hears" voice as fax tone	If the fax machine is set to Easy Receive ON , it is more sensitive to sounds. The fax machine may mistakenly interpret certain voices or music on the line as a calling fax machine and respond with fax receiving tones. Deactivate the fax by pressing #51 if you are at an extension phone or press Stop/Exit if you are at the fax machine or an external phone. Try avoiding this problem by turning Easy Receive to OFF . (See <i>Easy Receive</i> on page 5-3.)
Custom features on a single line	If you have Call Waiting, Ring Master, Voice Mail, an alarm system or any other custom feature on a single phone line with the fax machine, it may create a problem sending or receiving fax data. For example: If you are sending or receiving a fax message while a custom feature signal comes through on the line, the signal can temporarily interrupt or disrupt the fax data. Your fax machine's ECM feature should help overcome this problem. This condition is related to the telephone system industry and is common to all devices that send and receive data on a single, shared line with custom features. If avoiding a slight interruption is crucial to your business, we recommend a separate phone line with no custom features.

Routine maintenance

Cleaning the print head

Clean the print head when you want to improve the print quality and also as part of your routine maintenance.

⚠ After you have just used the fax machine, some internal parts of the fax machine are extremely **HOT!** So please be careful.

- 1** Before you clean inside the fax machine, unplug the telephone line cord first, and then the power cord from the AC power outlet.
- 2** Open the top cover by lifting the lever on the right side of the top cover.
- 3** Take out the print cartridge.

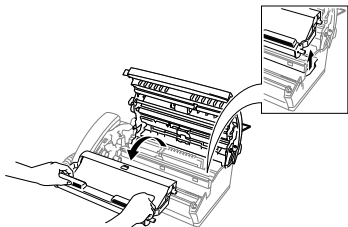

- 4** To clean your fax machine's print head, wipe the print head with a lint-free cloth that is dry or lightly moistened with isopropyl alcohol.

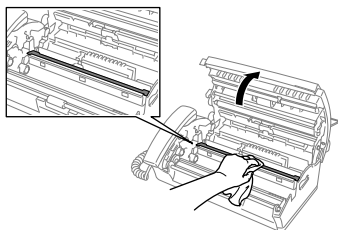

- 5** Wait until the alcohol on the print head is completely dry.
- 6** Install the print cartridge. (See *Changing the ribbon* on page 12-9.)
- 7** Close the top cover. Press down on both sides of the top cover until it clicks.

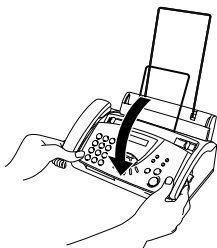

- 8** Plug in the telephone line cord back in first and then plug the power cord back into the AC power outlet.

Cleaning the scanner

- 1 Before you clean inside the fax machine, unplug the telephone line cord first, and then the power cord from the AC power outlet.
- 2 Open the top cover by lifting the lever on the right side of the top cover.
- 3 Clean the white film and the glass strip with isopropyl alcohol on a lint-free cloth.

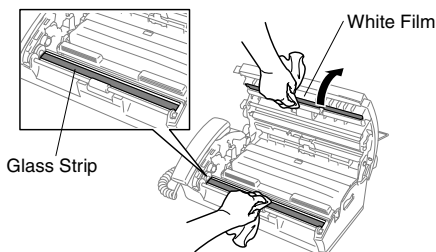

 Be careful not to bend the white film or drop anything into the fax machine.

- 4 Close the top cover. Press down on both sides of the top cover until you hear it click into place.
- 5 Plug in the telephone line cord back in first and then plug the power cord back into the AC power outlet.

Changing the ribbon

The starter ribbon prints up to 30 pages.

- 1 Open the top cover by lifting the lever on the right side of the top cover.

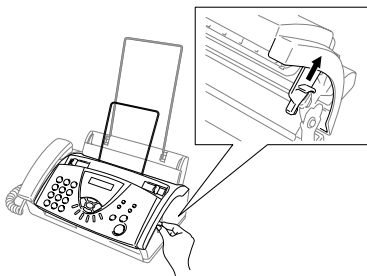

- 2 Remove the print cartridge containing the used ribbon and set it upside-down with the blue gear in the upper left corner.

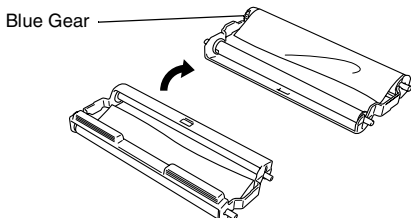

- 3** Take the used ribbon out of the cartridge:
- ① Snap out the upper and lower right white spools.
 - ② Slide the roll off the blue gear and lower left white spool. (Do not remove the blue gear and lower left white spool).

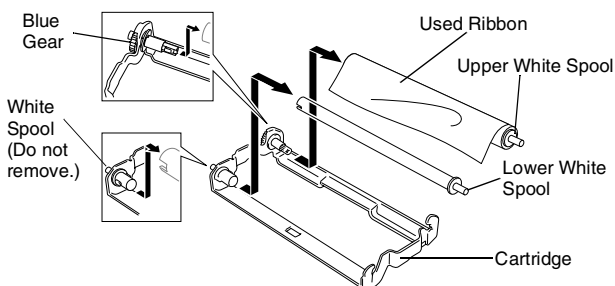

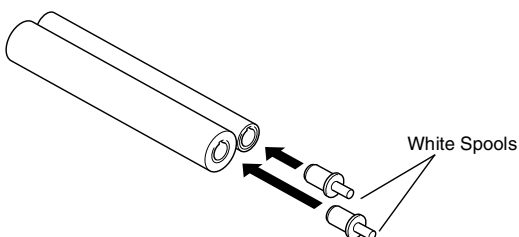

- 4** Slide the white elastic off the new refill rolls and set them down with the full roll in the lower position. (The ribbon's shiny side is facing *down*.)
- 5** Remove the white spools from the ends of the used cardboard cores. Then insert them into the same positions in the new cores.

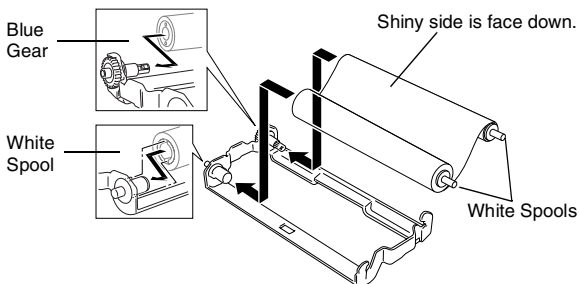

- 6** Install the new ribbon in the cartridge:

 - ① Slip the lower left cardboard core onto the white spool of the cartridge and then slip the upper blue core onto the blue gear of the cartridge.
 - ② Insert the upper and lower right white spools into the holders.



 Insert the teeth of the white spool into the cutouts of the cardboard core.

- 7 Turn the left blue gear to tighten the ribbon as shown in the illustration.

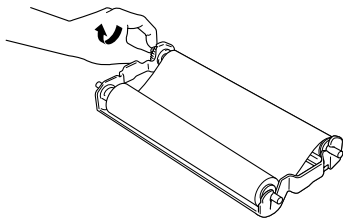

- 8 Turn the cartridge over and re-install it in your fax machine: Insert the recessed  first and place the cartridge into its four holders.

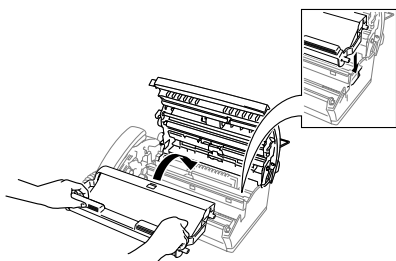
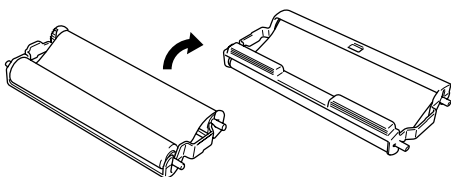

- 9 Press down on both sides of the top cover to close it securely.

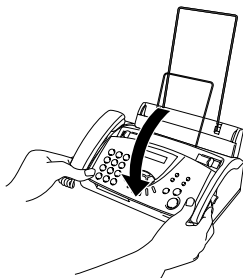

G Glossary

- ADF (automatic document feeder)** The document can be placed in the ADF and scanned one page at a time automatically.
- Automatic fax transmission** Sending a fax without picking up the handset or pressing **Hook**.
- Automatic Redial** A feature that enables your fax machine to redial the last fax number after five minutes if the fax did not go through because the line was busy.
- Auto Reduction** Reduces size of incoming faxes.
- Backup Print** Sets the fax machine to print a copy of every fax that is received and stored in memory. This is a safety feature so you will not lose message during a power failure.
- Beeper Volume** Volume setting for the beep when you press a key or make an error.
- Broadcasting** The ability to send the same fax message to more than one location.
- Call Reservation** Allows you send a fax and then at the end of transmission, you can talk with the other party.
- Caller ID** A service purchased from the telephone company that lets you see the number (or name) of the party calling you.
- Call Waiting/Caller ID** Subscribers to this service from the telephone company can see the caller ID of a second call while on the telephone and can switch back and forth between two calls.
- Cancel Job** Cancels a programmed job, like Delayed Fax or Polling.
- CNG tones** The special tones (beeps) sent by fax machines during automatic transmission to tell the receiving machine that a fax machine is calling.
- Communication error** An error during fax sending or receiving, usually caused by line noise or static.
- Contrast** Setting to compensate for dark or light documents, by making faxes or copies of dark documents lighter and light documents darker.
- Cover Page** Prints a page at the other party's machine that contains the sender and recipient's name and fax number, number of pages and comment. You can generate an electronic cover page at the other end with pre-programmed information from memory or you can print a sample cover page to fax with your document.
- Delayed Fax** Sends your fax at a specified later time that day.
- Distinctive Ring** A subscriber service purchased from the telephone company that gives you another phone number on an existing phone line. The Brother fax machine uses the new number to simulate a dedicated fax line.

- Easy Receive** Enables the fax machine to respond to CNG tones if you interrupt a fax call by answering it.
- ECM (Error Correction Mode)** Detects errors during fax transmission and resends the pages of the fax that had an error.
- Extension telephone** A telephone on the fax number that is plugged into a separate telephone wall jack.
- External telephone** A TAD (telephone answering device) or telephone that is plugged into the EXT jack of the fax machine.
- F/T Ring Time** The length of time that the Brother fax machine rings (when the receive mode setting is FAX/TEL) to notify you to pick up a voice call that it answered.
- Fax Forwarding** Sends a fax received in memory to another pre-programmed fax number.
- Fax Receive Code** Press this code (* 5 1) when you answer a fax call from an extension or external phone.
- Fax Storage** You can store faxes in memory.
- Fax tones** The signals sent by sending and receiving fax machines while communicating information.
- FAX/TEL** You can receive faxes and telephone calls. Do not use this mode if you are using a telephone answering device (TAD).
- Fine resolution** Resolution is 203 x 196 dpi. It is used for small print and graphs.
- Group number** A combination of One-Touch and/or Speed-Dial numbers that are stored on a One-Touch key for Broadcasting.
- Help list** A printout of the complete Menu that you can use to program your fax machine when you do not have the User's Guide with you.
- LCD (liquid crystal display)** The display screen on the fax machine that shows interactive messages during On-Screen Programming and shows the date and time when the fax machine is idle.
- Manual fax** When you lift the handset or press **Hook** so you can hear the receiving fax machine answer before you press **Fax Start** to begin transmission.
- Menu mode** Programming mode for changing your fax machine's settings.
- Next Fax Reservation** Accepts the next document in the ADF for transmission while the fax machine is still receiving.
- One-Touch** Keys on the fax machine's control panel where you can store numbers for easy dialing. You must use a separate key for each number.
- Out of Paper Reception** Receives faxes into the fax machine's memory when the fax machine is out of paper.
- Overseas Mode** Makes temporary changes to the fax tones to accommodate noise and static on overseas phone lines.
- Paging** This feature enables your fax machine to call your pager when a fax is received into its memory.

- Pause** Allows you to place a 3.5 second delay in the dialing sequence stored on One-Touch keys or Speed-Dial numbers.
- Photo resolution** A resolution setting that uses varying shades of gray for the best representation of photographs.
- Polling** The process of a fax machine calling another fax machine to retrieve waiting fax messages.
- Pulse (Canada only)** A form of rotary dialing on a telephone line.
- Quick Dial List** A listing of names and numbers stored in One-Touch and Speed-Dial memory, in numerical order.
- Remote Access Code** Your own four-digit code (---*) that allows you to call and access the fax machine from a remote location.
- Resolution** The number of vertical and horizontal lines per inch. See: Standard, Fine, Super Fine and Photo.
- Ring Delay** The number of rings before the fax machine answers in FAX ONLY and FAX/TEL modes.
- Search** An electronic, alphabetical listing of stored One-Touch, Speed-Dial and Group numbers.
- Speed-Dial** A pre-programmed number for easy dialing. You must press the **Search/Speed Dial** key and then #, two digit code to start the dialing process.
- Standard resolution** 203 x 98 dpi. It is used for regular size text and quickest transmission.
- Station ID** The stored information that appears on the top of faxed pages. It includes the sender's name and fax number.
- Super fine resolution** 203 x 392 dpi. Best for very small print and line art.
- TAD (telephone answering device)** You can connect an external device or answering machine to the EXT. jack of your fax machine.
- Telephone Answer Code (Fax/Tel mode only)** When the fax machine answers a voice call, it pseudo/double-rings. You can pick up at an extension phone by pressing this code (# 5 1).
- Tel-Index List** A listing of names and numbers stored in One-Touch and Speed-Dial memory, in alphabetical order.
- Tone** A form of dialing on the telephone line used for Touch Tone telephones.
- Transmission** The process of sending documents over the phone lines from the fax machine to a receiving fax machine.
- Transmission Verification Report** A listing for each transmission, that shows its date, time and number.
- User Settings** A printed report that shows the current settings of the fax machine.

S Specifications

General

Type	Desktop facsimile transceiver
Memory Capacity	512 KB
Paper Tray	17-24 lb (64 g/m ² – 90 g/m ²): Up to 50 sheets (Temperature: 23°C, Humidity 50%)
Paper Output	17-24 lb (64 g/m ² – 90 g/m ²): Up to 20 sheets
Printer Type	Line Thermal with Ribbon
LCD (Liquid Crystal Display)	16 characters x 1 Line
Operating Environment	Temperature: 50-95 °F (10-35 °C) Humidity: 20-80%
Best Print Quality	68-86 °F (20-30 °C)
Power Source	120V AC 50/60 Hz (USA and Canadian version only)
Power Consumption	Standby: under 4.8 watts Operating: under 160 watts

Dimensions

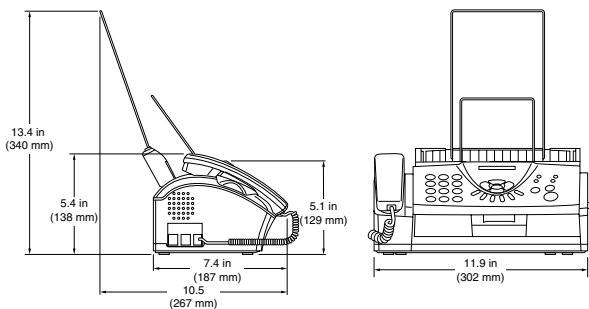

Weight	5.5 lb (2.5 kg) (with components)
---------------	-----------------------------------

Copy

Enlarge/Reduce	50% to 150% (50, 75, 87, 93, 100, 120, 125, 150% & Auto)
Multiple Copies	Up to 99 pages plus sort

Fax

Compatibility	ITU-T Group 3
Coding System	Modified Huffman (MH)
Modem Speed	9600/7200/4800/2400 bps; Automatic Fallback
Document Size	Scanner Width: Max. 8.5" (216 mm)
Paper Size	Letter, Legal
Automatic Document Feeder (ADF)	Up to 10 pages
Gray Scale	64 levels
Polling Types	Standard, Sequential
Contrast Control	Automatic/Light/Dark (manual setting)
Resolution	<ul style="list-style-type: none">• Horizontal 203 dot/inch (8 dot/mm)• Vertical Standard — 98 line/inch (3.85 line/mm)<ul style="list-style-type: none">Fine, Photo — 196 line/inch (7.7 line/mm)Superfine, Photo (copy) — 392 line/inch (15.4 line/mm)
One-Touch Dial	4 stations
Speed-Dial	100 stations
Groups	Up to 4 groups
Broadcasting	Up to 104 locations
Automatic Redial	One time after 5 minutes
Auto Answer	0, 1, 2, 3 or 4 rings
Speaker Type	Monitor
Communication Source	Public switched telephone network
Memory Transmission	Up to 20 pages *
Out of Paper Reception	Up to 25 pages *
Refill Ribbon Roll	Yield: Up to 150 pages (Letter)

* "Pages" refers to the ITU-T Test Chart #1 (in Out of Paper Reception in ECM mode). Specifications and printed materials are subject to change without prior notice.

Index

The items in all upper case represent LCD messages.

- A**
 - Access codes, storing and dialing 7-6
 - Accessories and supplies ii
 - ADF (automatic document feeder) 6-2
 - Answering machine (TAD) 1-8, 5-1
 - Automatic
 - fax receive 5-1
 - Easy Receive 5-3
 - fax redial 6-2, 6-3, 6-9
 - transmission 6-2
- B**
 - Broadcasting 6-8
 - setting up Groups 7-4
 - Brother
 - accessories and supplies ii
 - Brother numbers i
 - Customer Service i
 - FAQs (frequently asked questions) i
 - fax back system ii
 - product support i
 - Test Sheet, sending 1-2
 - warranties iii, iv, vi
- C**
 - Call Back Message 6-9
 - Call Reservation 6-9
 - Call Waiting/Caller ID 5-13
 - Caller ID
 - print Log 5-10
 - view Log 5-11
 - Canceling
 - a scheduled fax job 6-5
 - Fax Forwarding 8-5
 - Fax Storage 8-3
 - Paging 8-5
 - while scanning a fax 6-5
 - Cleaning 12-8
 - print head 12-8
 - Scanner 12-9
 - Connecting
 - external TAD 1-8
 - external telephone 1-8
 - Consumable Items ii
 - Control panel overview 1-4–1-5
 - Copy
 - multiple 10-2
 - operations 10-1
 - reduce/enlarge 10-2
 - Resolution 10-1, 10-2
 - single 10-1, 10-2
 - sort 10-2
 - specifications S-1
 - Cordless phone 5-5
 - Cover Page 6-6–6-8
 - Credit card numbers 7-6
 - Custom telephone features 1-13, 12-7
 - D**
 - Date and Time 4-1
 - Delayed Fax 6-10
 - Dialing
 - a pause 7-7
 - access codes and credit card numbers 7-6
 - automatic fax redial 6-2, 6-9
 - Groups (Broadcasting) 6-8
 - setting up 7-4
 - manual 7-5
 - Quick-Dial numbers 7-5
 - Distinctive Ring 5-8
 - E**
 - Easy Receive 5-3
 - ECM (Error Correction Mode) 1-7
 - Error messages on LCD 12-1
 - Extension telephones, using 5-5
 - External telephone 1-8
 - F**
 - Fax codes
 - changing 8-3
 - Fax Receive Code 5-5
 - Remote Access Code 8-3
 - Telephone Answer Code 5-5
 - Fax Forwarding 8-1
 - Backup Print 8-1
 - changing remotely 8-5, 8-6
 - programming a number 8-1
 - Fax Journal 9-2
 - Fax Receive Code 5-5, 5-6
 - Fax Storage 8-3
 - printing from memory 5-6
 - turning on 8-3
 - Fax, stand-alone
 - receiving 5-1
 - at end of conversation 5-4
 - difficulties 12-6
 - erasing from the memory 8-5
 - Fax Forwarding 8-1, 8-5
 - Paging 8-2
 - Polling Receive 5-6
 - reducing to fit on paper ... 5-4
 - retrieving from a remote site 8-6
 - Ring Delay, setting 5-2
 - Sequential Polling RX 5-7

sending	
at end of conversation	6-3
Broadcasting	6-8
contrast	6-4
delayed	6-10
fax redial	7-7
manual	6-3
Memory Transmission	6-12
multiple settings	6-3
overseas	6-8
Polling Transmit	6-11
resolution	6-4
FAX/TEL mode	5-1
answering at extension phones	5-5
double-ringing (voice calls)	5-3
Easy Receive	5-3
Fax Receive Code	5-6
receiving faxes	5-5
setting F/T Ring Time	5-3
setting Ring Delay	5-2
Telephone Answer Code	5-5
FCC notices	11-1
G	
Gray scale	S-2
Groups, setting up	7-4
H	
Handset volume	4-5
Hearing-aid compatible	11-1
HELP	
Help List	9-2
Hold	7-7
I	
International calls	6-8
Interrupting	6-13
J	
Jacks	
convert to RJ11 jack	1-11
EXT jack	
external telephone	1-8
TAD (answering machine)	1-8
triplex adapter	1-11
Jams	12-4
L	
LCD (Liquid Crystal Display)	1-4, 3-1
M	
Maintenance, routine	12-8
changing the ribbon	12-9
cleaning the print head	12-8
Manual	
dialing	7-5
receive	5-1
transmission	6-3
Memory Status List	9-2
Memory Storage	3-1
Menu Table	3-1, 3-3-3-6
N	
Navigation keys	3-2
O	
One-Touch	1-5
changing	7-3
dialing	7-5
setting up	7-1
P	
Paging	8-1, 8-2
programming your pager	
number	8-1
Paper	2-1
capacity	2-1
size	5-4
Phone line	
connections	1-10
difficulties	12-6
multi-line (PBX)	1-13
roll-over lines	1-11
two-line phone system	1-11
Polling	5-6
Polling Receive	5-6
Polling Transmit	6-11
sequential receiving	5-7
Power failure	3-1
Print	
Caller ID Log	5-10
Cover Page	6-8
difficulties	12-6
fax from memory	5-6
improving quality	12-8
jams	12-4
Q	
Quick-Dial	7-1
Access codes and credit card	
numbers, setting up	7-6
Broadcasting (using Groups)	6-8
Group dial	
setting up Groups for	
Broadcasting	7-4
List	9-2
One-Touch dial	
changing	7-3
setting up	7-1
using	6-1, 7-5
Search	6-1
Speed-Dial	
changing	7-3
setting up	7-2
using	7-6
R	
Receive Mode	5-2
EXTERNAL TAD	5-1
FAX ONLY	5-1
FAX/TEL	5-1
MANUAL	5-1
Redial/Pause	6-2, 6-3, 6-9
Reducing	
copies	10-2
long faxes	5-4

Remote Retrieval	
access code	8-3, 8-4
changing the code	8-3
commands	8-5
getting your faxes	8-6
Reports	9-2
Fax Journal	9-2
Journal Period	9-1
Help List	9-2
Memory Status	9-2
Quick-Dial List	9-2
Tel.Index	9-2
Transmission Verification	9-1
User Settings	9-2
Resolution	
copy	10-2
fax (Standard, Fine, SuperFine, Photo)	S-2
for next fax only	6-4
multiple	6-5
Ring Delay, setting	5-2

S

Safety instructions	vii, 11-4
Search	7-7
Setup	
Date and Time	4-1
Station ID (fax header)	4-2
Specifications	S-2
Speed-Dial	1-4
changing	7-3
dialing	7-6
setting up	7-2

T

TAD (telephone answering device), external	5-1
connecting	1-8
Receive Mode	5-1
with two-line jack	1-12
Temporary Cover Page	6-7
Text, entering	
special characters	4-3
Tone signals on Pulse line	7-7
Troubleshooting	12-1
error messages on LCD	12-1
if you are having difficulty	
incoming calls	12-7
phone line difficulties	12-6
printing or receiving faxes	12-6
sending faxes	12-6, 12-7
Two-line phone system	1-11

U

User Settings List	9-2
--------------------------	-----

V

Volume, setting	
beeper	4-4
handset	4-4, 4-5
Volume Amplify (for the hearing-impaired)	4-4, 4-5
ring	4-6
speaker	4-4

W

Warranties	iii
Canada	vi
Notice-Disclaimer	iii
USA	iv
World Wide Web	i

Remote Retrieval Access Card

If you plan to receive fax messages while away from the fax machine, carrying the Remote Retrieval Access Card printed below will serve as a convenient reminder of the retrieval procedures. Simply cut out the card and fold it to fit your wallet or organizer. Keeping it handy will help you derive the full benefit of the fax machine's Forwarding, Paging and Remote Retrieval features.

REMOTE RETRIEVAL ACCESS CARD

CHECK RECEIVING STATUS
Press **971**
1 long beep — Fax messages
3 short beeps — No messages

CHANGE RECEIVE MODE
Press **98**
then for **TAD:ANSWER MACH.**, press **1**.
FAX/TEL, press **2**.
FAX ONLY, press **3**.

EXIT REMOTE OPERATION
Press **90**.



Using Remote Access Code

- 1 Dial your fax number from a telephone or fax machine using touch tone.
- 2 When your fax machine answers, immediately enter your Remote Access Code (3 digits followed by **✳**).
- 3 Your Fax machine signals the kinds of messages received:
1 long beep — Fax messages
No beeps — No messages.
- 4 After 2 short beeps, enter a command.
- 5 Press **90** to reset your fax machine when you finish.
- 6 Hang up.

1

4

Fold → ← Fold



Changing Remote Access Code

"When you are at the machine:"

- 1 Press **Menu/Set**, **8**, **2**.
- 2 Enter a three-digit number from 000 to 999.
The * cannot be changed.
- 3 Press **Menu/Set**.
- 4 Press **Stop/Exit**.

Remote Commands

CHANGE PAGING/FAX FORWARDING SETTING

- Press **9 5**.
- then to Turn feature **OFF**, press **1**.
Select **Fax Forwarding**, press **2**.
Select **Paging**, press **3**.

Fold

Program Fax Forwarding Number, press **4**. Enter the new fax number where you want your fax messages forwarded followed by **##**.
Select **Fax Storage**, press **6**.

RETRIEVE A FAX

- Press **9 6**.
- then to Retrieve **all faxes**, press **2**.
then enter the number of remote fax machine, followed by **##**.
After the beep, hang up and wait.
Erase all fax messages, press **3**.

Fold

EQUIPMENT ATTACHEMNT LIMITATIONS (Canada only)

NOTICE

This product meets the applicable industry Canada technical specifications.

NOTICE

The Ringer Equivalence Number is an indication of the maximum number of devices allowed to be connected to a telephone interface.

The termination on an interface may consist of any combination of devices subject only to the requirement that the sum of the RENs of all the devices does not exceed five.

brother®

Brother International Corporation
100 Somerset Corporate Boulevard
P.O. Box 6911
Bridgewater, NJ 08807-0911 USA

Brother International Corporation (Canada) Ltd.
1 rue Hôtel de Ville,
Dollard-des-Ormeaux, QC, CANADA H9B 3H6

Visit us on the World Wide Web
<http://www.brother.com>

These machines are made for use in the USA and CANADA only. We cannot recommend using them overseas because it may violate the Telecommunications Regulations of that country and the power requirements of your multi-function center may not be compatible with the power available in foreign countries. **Using USA or CANADA models overseas is at your own risk and may void your warranty.**



US/CAN
LF3929001①

Free Manuals Download Website

<http://myh66.com>

<http://usermanuals.us>

<http://www.somanuals.com>

<http://www.4manuals.cc>

<http://www.manual-lib.com>

<http://www.404manual.com>

<http://www.luxmanual.com>

<http://aubethermostatmanual.com>

Golf course search by state

<http://golfingnear.com>

Email search by domain

<http://emailbydomain.com>

Auto manuals search

<http://auto.somanuals.com>

TV manuals search

<http://tv.somanuals.com>