

Quick Setup Guide

MFC-5440CN
MFC-5840CN

Before you can use the machine, you must set up the hardware and install the driver. To help you get started in setting up the machine and installing the driver and software, please read this "Quick Setup Guide" and follow the simple instructions.

Step 1



Setting Up the Machine

Step 2



Installing the Driver & Software

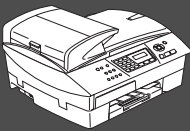

Setup is Complete!

For the latest drivers and to find the best solution for your problem or question, access the Brother Solutions Center directly from the driver or go to <http://solutions.brother.com>. Keep this "Quick Setup Guide", User's Guide and supplied CD-ROM in a convenient place for quick and easy reference at all times.

Setting Up
the Machine

Windows®

Windows®
Network





Installing the Driver & Software

Mac OS® X







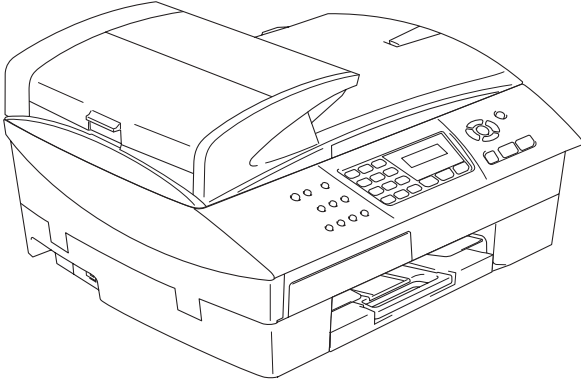
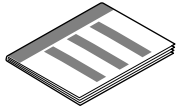

Mac OS®
8.6 - 9.2

Macintosh®
Network

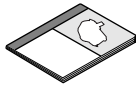
For
Network Users

| | | | |
|----------------------------------------------------------------------------------------------------|------------------------------------------------------------------------------------------------------------------|-------------------------------------------------------------------------------------------------|-----------------------------------------------------------------------------------------------------------|
|  Warning |  |  Hint |  User's Guide |
| <p>Indicates warnings that must be observed to prevent possible personal injury.</p> | <p>Indicates cautions that must be observed to use the machine properly or to prevent damage to the machine.</p> | <p>Indicates notes and useful tips to remember when using the machine.</p> | <p>Indicates reference to the User's Guide.</p> |

Carton Components

| | | | |
|-----------------------------------------------------------------------------------------------------------------|------------------------------------------------------------------------------------------------------------------|------------------------------------------------------------------------------------------------------------------|-----------------------------------------------------------------------------------------------------------------|
|  |  Quick Setup Guide | | |
| |  CD-ROM | | |
| |  User's Guide | | |
|  Telephone Line Cord |  Power Cord | | |
|  Black (LC900BK) |  Magenta (LC900M) |  Yellow (LC900Y) |  Cyan (LC900C) |
| Ink Cartridges | | | |

Carton components may differ from one country to another.
Save all packing materials and the carton.



If you are connecting the machine via USB:

- *The interface cable is not a standard accessory. Please purchase an appropriate USB 2.0 interface cable.*
- *Please make sure you use a USB 2.0 interface cable that is no longer than 2 meters.*
- *Your machine has a full speed USB 2.0 interface. This interface is compatible with Hi-Speed USB 2.0; however, the maximum data transfer rate will be 12 Mbits/s. The machine can also be connected to a computer that has a USB 1.1 interface.*
- *Most of the illustrations in this Quick Setup Guide show the MFC-5440CN.*

Control Panel

(For MFC-5440CN)

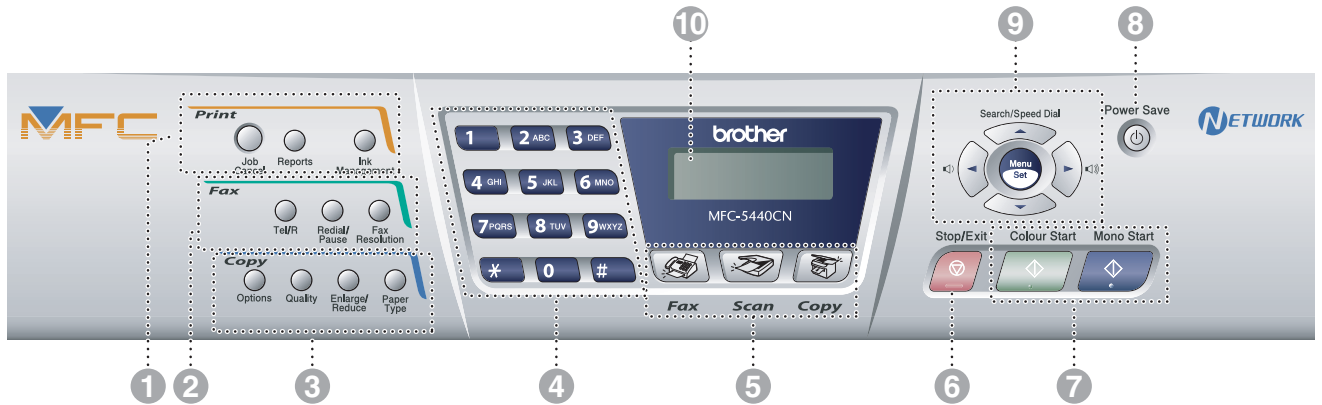

| | | |
|---------------------------|-------------------|----------------------------------|
| 1. Print keys | 5. Mode keys | 9. Navigation keys |
| 2. Fax and telephone keys | 6. Stop/Exit key | 10. Liquid Crystal Display (LCD) |
| 3. Copy keys | 7. Start keys | |
| 4. Dial Pad | 8. Power Save key | |



For the details of the control panel, see "Control panel overview" in Chapter 1 of the User's Guide.

(For MFC-5840CN)

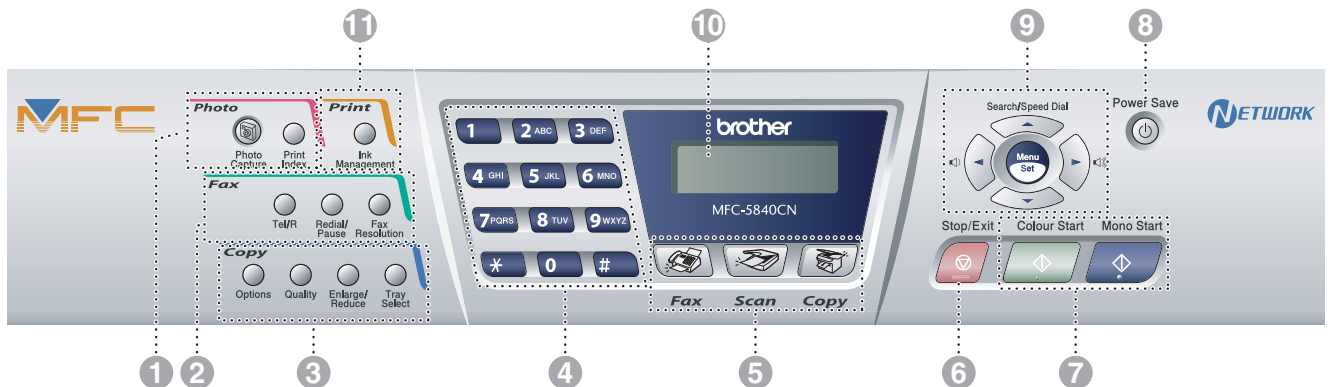

| | | |
|---------------------------|-------------------|----------------------------------|
| 1. Photo keys | 5. Mode keys | 9. Navigation keys |
| 2. Fax and telephone keys | 6. Stop/Exit key | 10. Liquid Crystal Display (LCD) |
| 3. Copy keys | 7. Start keys | 11. Print key |
| 4. Dial Pad | 8. Power Save key | |



For the details of the control panel, see "Control panel overview" in Chapter 1 of the User's Guide.

Table of Contents

Step 1

Setting Up the Machine

| | |
|---------------------------------------------------|----|
| 1. Removing the Protective Parts | 4 |
| 2. Loading Paper | 4 |
| 3. Installing the Phone Line and Power Cord | 6 |
| 4. Installing the Ink Cartridges | 7 |
| 5. Print Quality Check | 9 |
| 6. Setting the Date and Time | 10 |
| 7. Setting Your Station ID | 10 |
| 8. Selecting a Receive Mode | 11 |

Step 2

Installing the Driver & Software

| | | |
|----------------------------------------|------------------------------------------------------|----|
| Windows® | Supplied CD-ROM “MFL-Pro Suite” | 12 |
| | For USB Interface Cable Users | |
| | ■ For Windows® 98/98SE/Me/2000 Professional/XP | 14 |
| Macintosh® | For Network Interface Cable Users | |
| | ■ For Windows® 98/98SE/Me/2000 Professional/XP | 17 |
| | For USB Interface Cable Users..... | 20 |
| | ■ For Mac OS® X 10.2.4 or greater..... | 20 |
| | ■ For Mac OS® 8.6 to 9.2 | 23 |
| | For Network Interface Cable Users | 25 |
| ■ For Mac OS® X 10.2.4 or greater..... | 25 | |
| ■ For Mac OS® 8.6 to 9.2 | 28 | |

■ For Network Users

| | |
|------------------------------------------------------------------------------------------------------|----|
| Network User's Guide Chapter Map | 30 |
| Restoring the Network Settings to Factory Default | 30 |
| Installing the BRAdmin Professional Configuration Utility (Windows® only) | 31 |
| Setting your IP Address, Subnet Mask and Gateway using BRAdmin Professional (Windows® only) | 32 |

■ Consumables and Options

| | |
|------------------------------|----|
| Replacement Consumables..... | 33 |
| Option | 33 |

Step 1

Setting Up the Machine

1 Removing the Protective Parts

- 1 Remove the protective tape and paper.

DO NOT connect the USB cable. Connecting the USB cable is done when installing the driver.

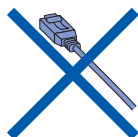

2 Loading Paper

 For Tray#2, see To load paper in the paper tray#2 (MFC-5840CN only) on page 5.

 You can load up to 100 sheets of 80 g/m² paper in Tray#1 and 250 sheets of 80 g/m² paper in Tray#2. For more details, see "About paper" in Chapter 1 of the User's Guide.

To load paper or other media

- 1 Pull the paper tray completely out of the machine and remove the output paper tray.

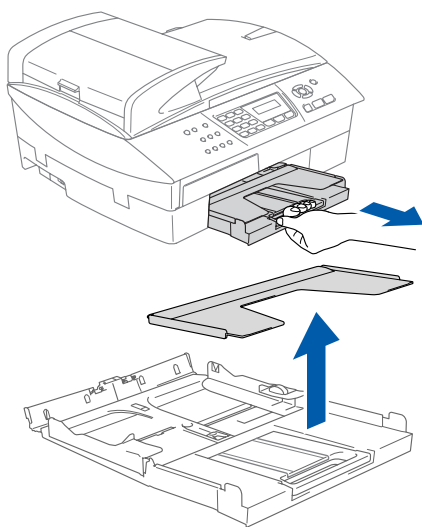

- 2 Press and slide the paper side guide to fit the paper width.

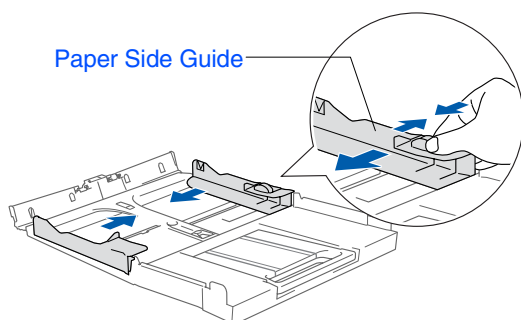

- 3 Pull out the paper support and unfold the paper support flap.

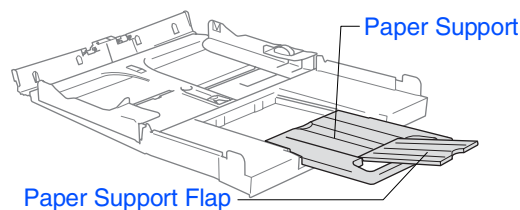

 Use the paper support flap for Letter, Legal and A4 size paper.

- 4 Fan the stack of paper well to avoid paper jams and mis-feeds.

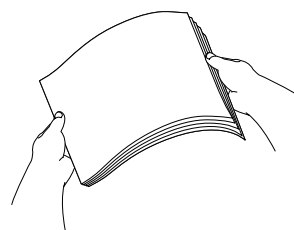

- 5 Gently insert the paper into the paper tray print side down and the leading edge (top of the paper) in first.

Check that the paper is flat in the tray and below the maximum paper mark.

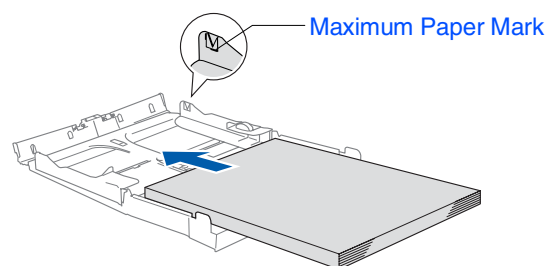

- Make sure the paper side guides touch the sides of the paper.
- Be careful that you do not push the paper in too far; it may lift at the back of the tray and cause paper feed problems.

- 6 Put the output paper tray back on and push the paper tray firmly back into the machine.

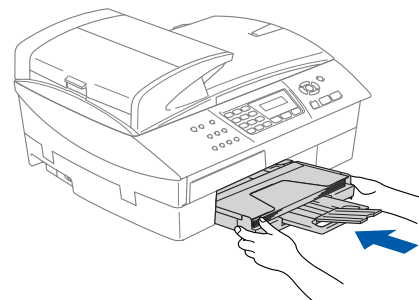

To load paper in the paper tray#2 (MFC-5840CN only)



You can use only plain paper sizes Letter, Legal, A4, Executive or B5 in Tray#2.

- 1 Pull the paper tray completely out of the machine.

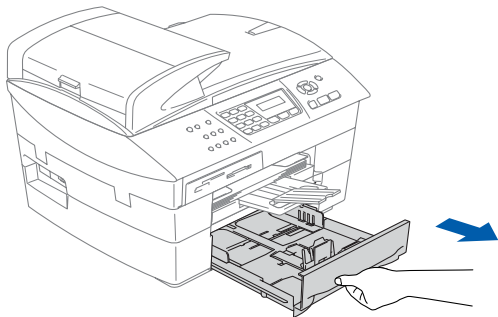

- 2 Press and slide the paper side guide and paper length guide to fit the paper width and length.

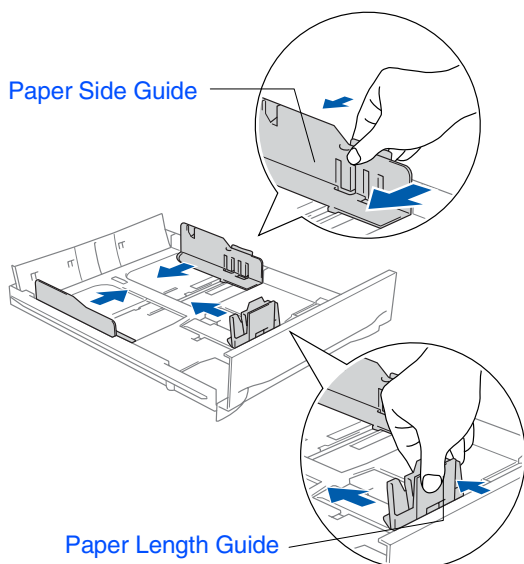

For Legal size paper, press and hold the universal guide release button as you slide out the front of the paper tray.

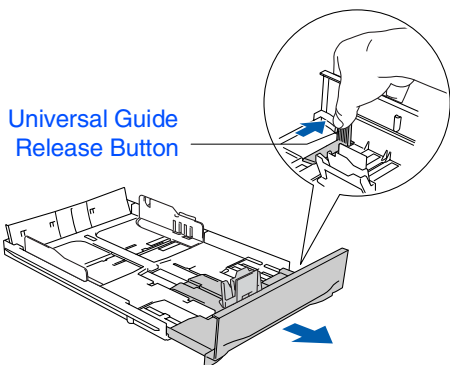

- 3 Fan the stack of paper well to avoid paper jams and mis-feeds.

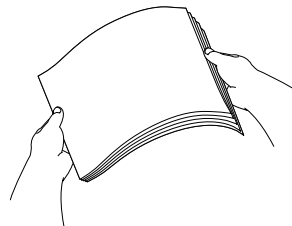

- 4 Gently insert the paper into the paper tray print side down and the leading edge (top of the paper) in first. Check that the paper is flat in the tray and below the maximum paper mark.

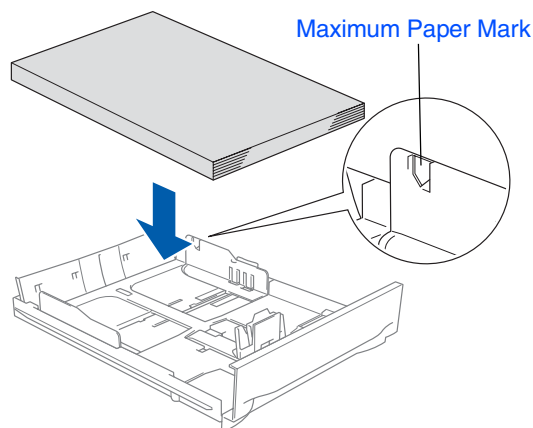

- 5
- Make sure the paper side guides and length guide touch the sides of the paper.
 - Be careful that you do not push the paper in too far; it may lift at the back of the tray and cause paper feed problems.

- 5 Put the paper tray firmly back into the machine.

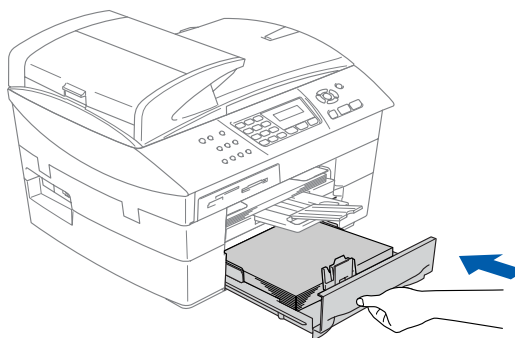

Only for MFC-5840CN, see "To load paper in the paper tray#2 (MFC-5840CN only)" in Chapter 1 of the User's Guide.

3 Installing the Phone Line and Power Cord

- 1 Connect the power cord.

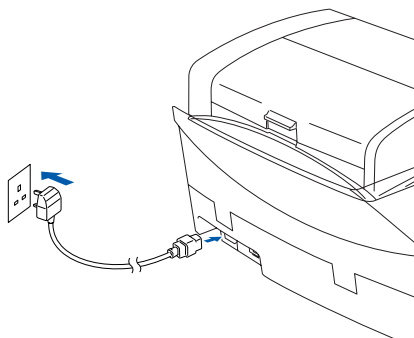

(Example for the U.K.)

- 2 Connect the telephone line cord.
Connect one end of the telephone line cord to the socket on the machine marked **LINE** and the other end to a modular wall socket.

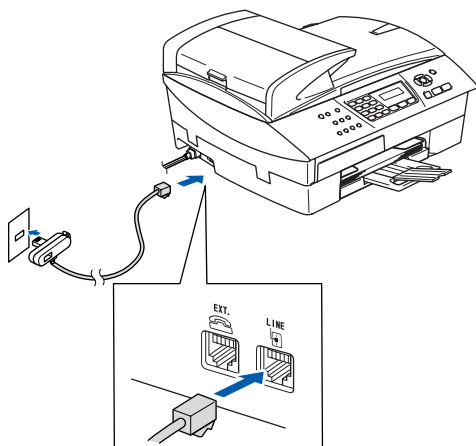

(Example for the U.K.)



DO NOT connect the USB cable yet.

Warning

- The machine must be fitted with an earthed plug.
- Since the machine is grounded through the power outlet, you can protect yourself from potentially hazardous electrical conditions on the telephone network by keeping the power switched on when you connect the machine to a telephone line. Similarly, you can protect yourself when you want to move your machine by disconnecting the telephone line first and then the power cord.



If you are sharing one phone line with an external telephone, connect it as shown below.

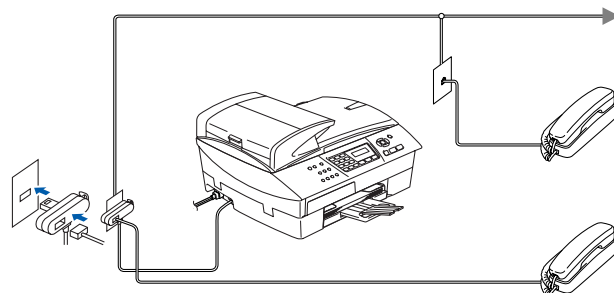

(Example for the U.K.)



If you are sharing one phone line with an external telephone answering machine, connect it as shown below.



Please set the Receive Mode to "External TAD" if you have an external answering machine. For more details, see "Connecting an external device to your MFC" in the Appendix of the User's Guide.

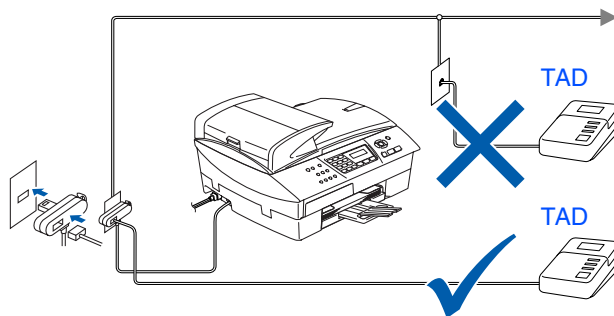

(Example for the U.K.)

4

Installing the Ink Cartridges

Warning

If ink gets in your eyes wash them with water immediately, and if irritation occurs consult a doctor.

- 1 Make sure that the power is turned on. The LCD shows:

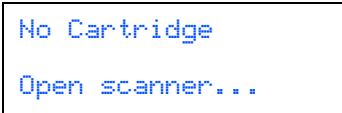

- 2 Lift the scanner cover from the right-hand side of the machine until it locks securely into the open position.

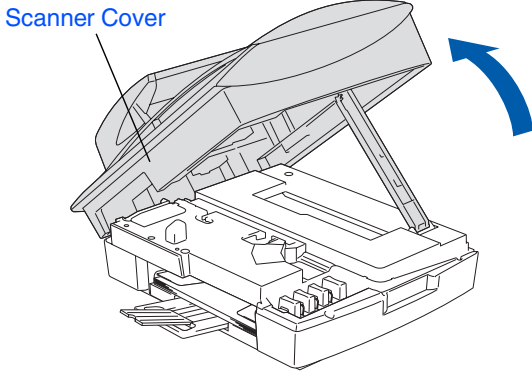

- 3 Remove the protective parts.

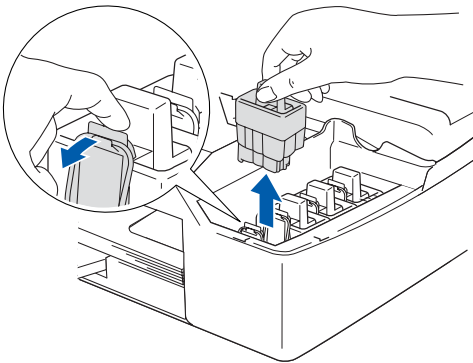

 Do not throw away the protective parts. You will need them when you transport the machine.

- 4 Take out the ink cartridge.

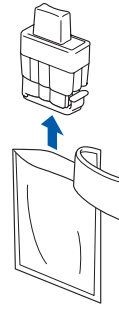

- 5 Carefully remove the bottom cap.

 **DO NOT touch the area shown in the illustration below.**

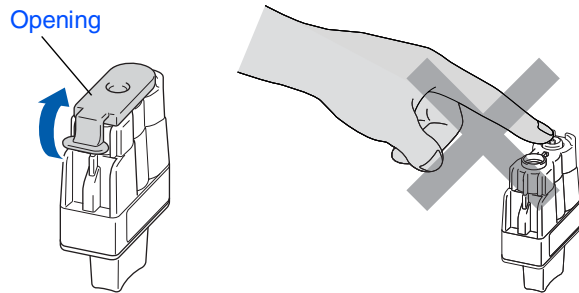

 If the cartridge cover comes off when you open the bag the cartridge will not be damaged.

Keep the ink cartridge in an upright position when you insert it into the slot.

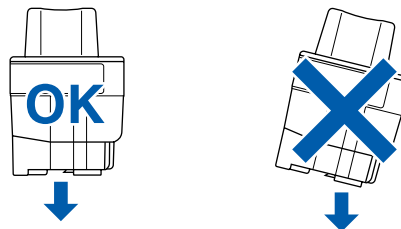

Step 1

Setting Up the Machine

- 6 Press firmly down on the ink cartridge until the hook snaps over it, taking care to match the slot colour (A) with the cartridge colour (B), as shown in the diagram below.

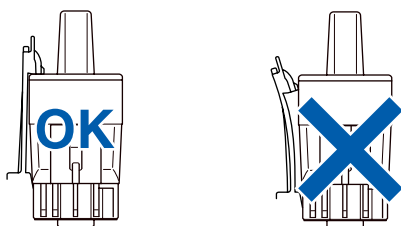
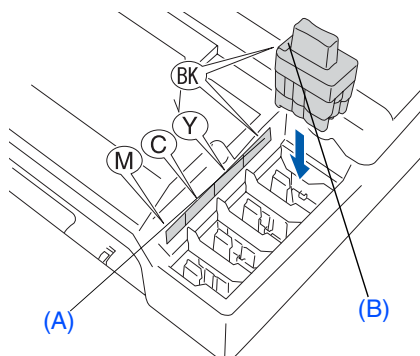

- 7 Lift the scanner cover to release the lock. Gently push the scanner cover support down and close the scanner cover.



If **Install** shows on the LCD after you install the ink cartridges, check to make sure the ink cartridges are installed correctly.

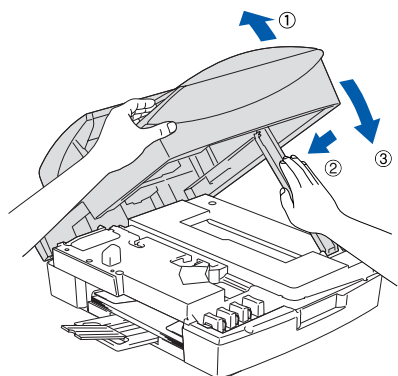

The machine will clean the ink tube system for use for the first time. This process will occur only once, the first time ink cartridges are installed. The cleaning process will last approximately four minutes.

The LCD shows:

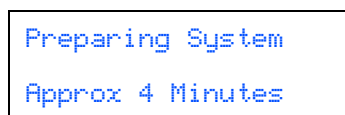

- **DO NOT** remove ink cartridges if you do not need to replace them. If you do so, it may reduce the ink quantity and the machine will not know the quantity of ink left in the cartridge.
- **DO NOT** shake the ink cartridges. If ink stains your body or clothing, wash with soap or detergent immediately.
- **DO NOT** insert and remove the cartridges repeatedly. If you do so, the ink may seep out of the cartridge.
- Brother inkjet machines are designed to work with ink of a particular specification and work to a level of optimum performance when used with genuine Brother ink cartridges. Brother cannot guarantee this optimum performance if ink or ink cartridges of other specifications are used. Brother does not therefore recommend the use of cartridges other than genuine Brother cartridges with this machine or the refilling of empty cartridges with ink from other sources. If damage is caused to the print head or other parts of this machine as a result of the use of ink or ink cartridges other than genuine Brother products due to the incompatibility or lack of suitability of those products with this machine, any repairs required as a result will not be covered by the warranty.



- If you mix the colours by installing an ink cartridge in the wrong position, you must clean the print head by running several cleaning cycles after correcting the cartridge installation. (See "Cleaning the print head" in chapter 11 Troubleshooting and Routine Maintenance of the User's Guide.)
- Once you open an ink cartridge, install it in the machine and use it up within six months of installation. Use unopened ink cartridges by the expiration date written on the cartridge package.

5

Print Quality Check

- 1 After the cleaning cycle is finished, the LCD shows:



Set Paper and
Press Start

- 2 Make sure the paper is loaded in the paper tray.

Press **Colour Start**.

The machine starts printing the PRINT QUALITY CHECK SHEET (only during initial ink cartridge installation).

- 3 Check the quality of the four colour blocks formed by the short lines printed on the sheet.
(BLACK/ CYAN/ YELLOW/ MAGENTA)

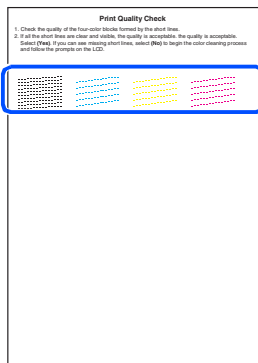

Avoid touching the printed surface of the paper immediately after printing, the surface may not be completely dry and may stain your fingers.

- 4 The LCD shows:

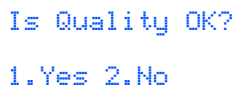

Is Quality OK?
1.Yes 2.No

- 5 If all lines are clear and visible, press **1** on the dial pad to finish the quality check.
---OR---
If you can see missing short lines, press **2** on the dial pad and go to **6**.

OK Poor



- 6 The LCD asks you if the print quality is OK for black and colour. Press **1** or **2** on the dial pad.

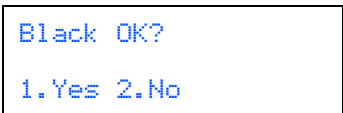

Black OK?
1.Yes 2.No

After making your selection **1 (Yes)** or **2 (No)** for both black and colour, the LCD shows:

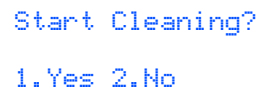

Start Cleaning?
1.Yes 2.No

Press **1 (Yes)**, the machine will then start cleaning the colours.

After cleaning is finished, press **Colour Start**. The machine starts printing the PRINT QUALITY CHECK SHEET again and goes back to step **3**.

6 Setting the Date and Time

- 1 Press **Menu/Set**.
- 2 Press **0**.
- 3 Press **2**.
- 4 Enter the last two digits of the year on the dial pad, and then press **Menu/Set**.

```
Date/Time
Year:2004
```

(e.g. Enter **0 4** for 2004.)

- 5 Enter the two digits for the month on the dial pad, and then press **Menu/Set**.

```
Date/Time
Month:03
```

(e.g. Enter **0 3** for March.)

- 6 Enter the two digits for the day on the dial pad, and then press **Menu/Set**.

```
Date/Time
Day:01
```

(e.g. Enter **0 1**.)

- 7 Enter the time in 24-hour format on the dial pad, and then press **Menu/Set**.

```
Date/Time
Time:15:25
```

(e.g. Enter **1 5, 2 5** for 3:25 P.M.)

- 8 Press **Stop/Exit**.



If you want to repeat input, press **Stop/Exit** to start from Step 1.

7 Setting Your Station ID

You should store your name and fax number to be printed on all fax pages that you send.

- 1 Press **Menu/Set**.
- 2 Press **0**.
- 3 Press **3**.
- 4 Enter your fax number (up to 20 digits) on the dial pad, and then press **Menu/Set**.

```
Station ID
Fax: _
```

- 5 Use the dial pad to enter your name (up to 20 characters), and then press **Menu/Set**.

```
Station ID
Name: _
```



- Refer to the following chart for entering your name.
- If you need to enter a character that is on the same key as the previous character, press to move the cursor to the right.

| Press key | One time | Two times | Three times | Four times |
|-----------|----------|-----------|-------------|------------|
| 2 | A | B | C | 2 |
| 3 | D | E | F | 3 |
| 4 | G | H | I | 4 |
| 5 | J | K | L | 5 |
| 6 | M | N | O | 6 |
| 7 | P | Q | R | S |
| 8 | T | U | V | 8 |
| 9 | W | X | Y | Z |



For more details, see "Setting the Station ID" in Chapter 2 of the User's Guide.

- 6 Press **Stop/Exit**.



If you want to repeat input, press **Stop/Exit** to start from Step 1.

Selecting a Receive Mode

There are four possible receive modes: **Fax Only**, **Fax/Tel**, **Manual** and **External TAD**.

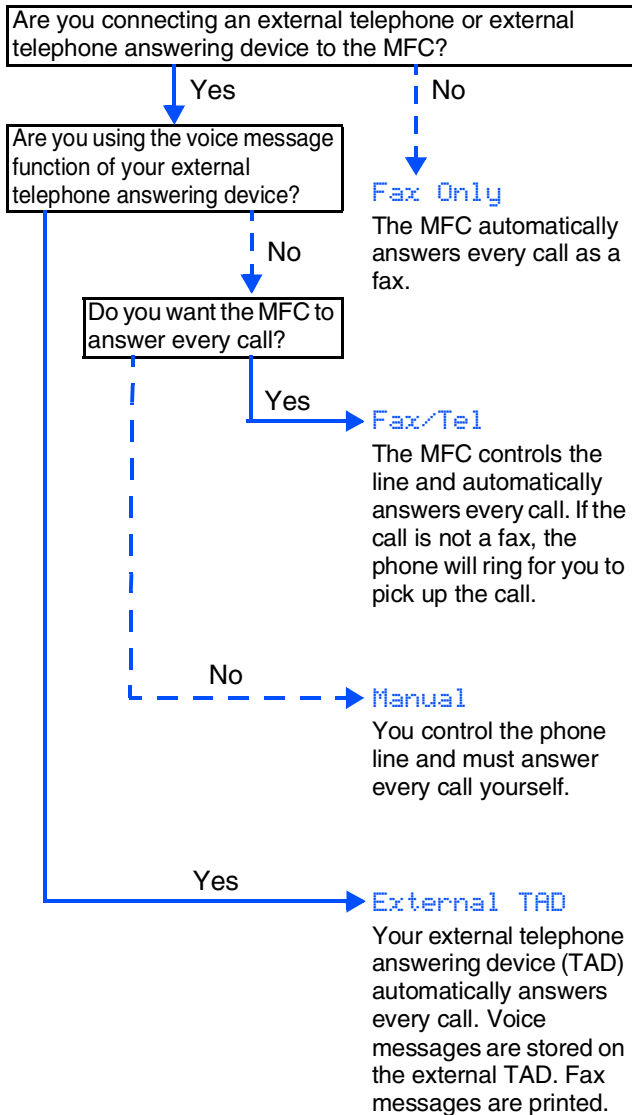

- 1 Press **Menu/Set**.
- 2 Press **0**.
- 3 Press **1**.
- 4 Press **▲** or **▼** to select the mode.
- 5 Press **Menu/Set**.
- 6 Press **Stop/Exit**.



For more details, see "Setup Receive" in Chapter 4 of the User's Guide.

Go to Next page to
install the driver

Supplied CD-ROM “MFL-Pro Suite”

The CD-ROM includes the following items:

Windows®



MFL-Pro Suite includes Printer Driver, Scanner Driver, ScanSoft® PaperPort® 9.0SE, ScanSoft® OmniPage® and True Type® fonts. PaperPort® 9.0SE is a document management application for viewing scanned documents. ScanSoft® OmniPage®, which is integrated into PaperPort® 9.0SE, is an OCR application that converts an image into text and inserts it into your default word processor.

Macintosh®



Install MFL-Pro Suite

You can install the MFL-Pro Suite software and multifunction drivers.



Install Optional Applications

You can install additional MFL-Pro Suite software utilities.



Documentation*¹

View the User's Guide and other documentation in PDF format (Viewer included).



On-Line Registration

You will be pointed to the Brother Product Registration Web page for quick registration of your machine.



Brother Solutions Center

Brother contact information and web site links offering the latest news and support information.



Repair MFL-Pro Suite

If an error occurred during the installation of the MFL-Pro Suite, use this selection to automatically repair and re-install the MFL-Pro Suite.



Start Here

You can install the printer driver, scanner driver and Presto!® PageManager® for Mac OS® 8.6 - 9.2.



Start Here OSX

You can install the printer driver, scanner driver, remote setup program and Presto!® PageManager® for Mac OS® 10.2.4 or greater.



Readme!

You can get important information and troubleshooting tips.



Documentation*¹

View the User's Guide and other documentation in PDF format.



Brother Solutions Center

You can access the Brother Solutions Center, a Web site offering information about your Brother product including FAQs, User's Guides, Driver updates and Tips for using your machine.



On-Line Registration

You will be pointed to the Brother Product Registration Web Page for quick registration of your machine.

*¹ The User's Guide on the CD-ROM includes the Software and Network User's Guide for features available when connected to a computer (e.g. Printing and Scanning).



Follow the instructions on this page for your operating system and interface cable.

Setting Up
the Machine

Windows®



For USB Interface Cable Users

■ Windows® 98/98SE/Me/2000 Professional/XP ... Go to page 14

Windows®



For Network Interface Cable Users

■ Windows® 98/98SE/Me/2000 Professional/XP ... Go to page 17

Windows®
Network

Macintosh®



For USB Interface Cable Users

■ Mac OS® X 10.2.4 or greater Go to page 20

Mac OS® X



For USB Interface Cable Users

■ Mac OS® 8.6 to 9.2 Go to page 23

Mac OS®
8.6 - 9.2



For Network Interface Cable Users

■ Mac OS® X 10.2.4 or greater Go to page 25

■ Mac OS® 8.6 to 9.2 Go to page 28

Macintosh®
Network

For Network Users Go to page 30

For
Network Users

Step 2

Installing the Driver & Software



For USB Interface Cable Users

(For Windows® 98/98SE/Me/2000 Professional/XP)

Make sure that you have completed the instructions from Step 1 “Setting Up the Machine” on pages 4 - 11.

(MFC-5840CN only)

If you are using Windows® 2000 Professional:

To access the PhotoCapture Center™ features from your PC you may have to install a Windows® 2000 update first.

The Windows® 2000 update is included with the MFL-Pro Suite installer.

To install the update, follow the steps below:

1. Follow the installation steps from ① to ④.
2. Click **OK** to start installation of the update.
3. When instructed, click **OK** to restart your PC.
4. After the PC restarts, the installation of MFL-Pro Suite will automatically continue.



■ If the installation does not continue automatically, please open the MFL-Pro Suite installer menu again by ejecting then reinserting the CD-ROM disc or double-click the **setup.exe** program from the root directory, and continue from Step ④ to install the MFL-Pro Suite.

■ Make sure there are no media cards inserted into the media drive of the machine.

■ Brother recommends you connect the machine directly to your computer.

■ Please close any applications running before installing MFL-Pro Suite.

- ① Disconnect the machine from the power socket and from your computer, if you have already connected an interface cable.

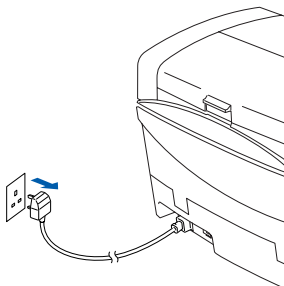

(Example for the U.K.)

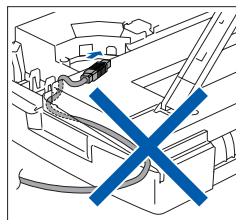

- ② Turn on your computer.
(For Windows® 2000 Professional/XP, you must be logged on as the administrator.)

- ③ Insert the supplied CD-ROM into your CD-ROM drive. If the model name screen appears, select your machine. If the language screen appears, select your language.



- ④ The CD-ROM main menu will appear. Click **Install MFL-Pro Suite**.



If this window does not appear, use Windows® Explorer to run the **setup.exe** program from the root directory of the Brother CD-ROM.



(MFC-5840CN only)

If you see the following screen, click **OK** to install the Windows® updates. After the updates are installed, your PC may restart. Then the installation will automatically continue.

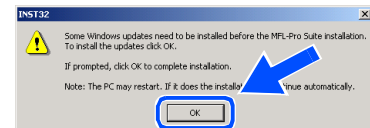

If the installation does not continue automatically, please open the main menu again by ejecting then reinserting the CD-ROM disc or double-click the **setup.exe** program from the root directory, and continue from Step ④ to install the MFL-Pro Suite.

- 5 After reading and accepting the ScanSoft® PaperPort® 9.0SE License Agreement, click **Yes**.

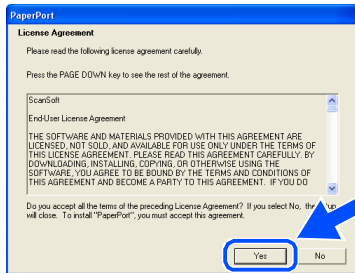

- 6 The installation of PaperPort® 9.0SE will automatically start and is followed by the installation of MFL-Pro Suite.

- 7 When the Brother MFL-Pro Suite Software License Agreement window appears, click **Yes**, if you agree to the Software Licence Agreement.

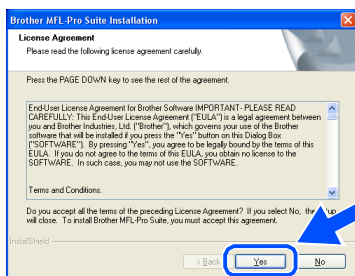

- 8 Select **Local Connection**, and then click **Next**. The installation will continue.

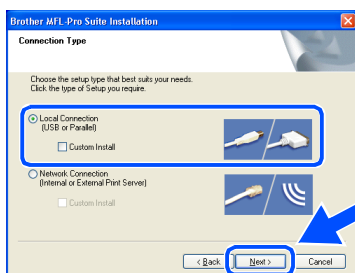

- 9 When this screen appears, connect the USB interface cable to your PC, and then connect it to the machine.

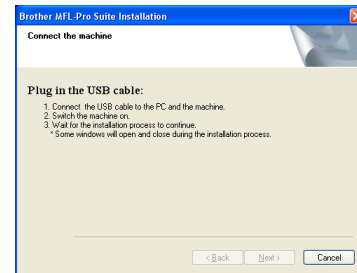

To connect the USB cable to the machine:

1. Lift the scanner cover to its open position.
2. Connect the USB cable into the USB socket, marked with a  symbol. You will find the USB socket above and to the left of the ink cartridge slots, as shown below.

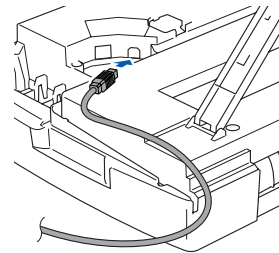

3. Carefully guide the USB cable into the trench as shown below, following the trench round and toward the back of the machine.

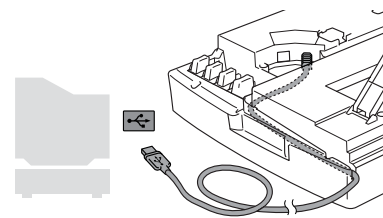

Warning

Ensure that the cable does not restrict the cover from closing, or an error may occur.



DO NOT connect the machine to a USB port on a keyboard or a non powered USB hub.

Continued...



For USB Interface Cable Users

(For Windows® 98/98SE/Me/2000 Professional/XP)

- 10 Lift the scanner cover to release the lock. Gently push the scanner cover support down and close the scanner cover.
- 11 Turn on the machine by plugging in the power cord.

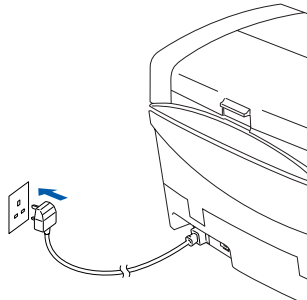

(Example for the U.K.)

It will take a few seconds for the installation screens to appear.

The installation of the Brother drivers will automatically start. The installation screens appear one after another, please wait for a while.

- 12 When the Brother and ScanSoft on-line Registration screen is displayed, make your selection and follow the on-screen instructions.

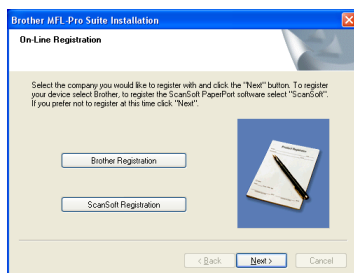

- 13 Click **Finish** to restart your computer.

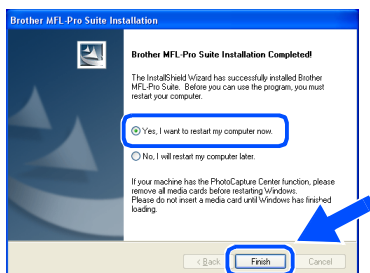

- 14 After restarting the computer, the Installation Diagnostics will run automatically and the installation results window will be shown.



*If the installation is unsuccessful try installing again using the **Repair MFL-Pro Suite** option from the main menu. Select **Repair MFL-Pro Suite** and follow the instructions on the screen.*

- OK!** The MFL-Pro Suite, Brother Printer driver and Scanner driver have been installed and the installation is now complete.

For Network Interface Cable Users (Windows® 98/98SE/Me/2000 Professional/XP)

Make sure that you have completed the instructions from Step 1 “Setting Up the Machine” on pages 4 - 11.

Before installation, if you are using Personal Firewall software, disable it. Once you are sure that you can print, re-start your Personal Firewall software.

- 1 Connect the network cable to the machine, and then connect it to a free port on your hub.

To connect the network interface cable to the machine:

1. Lift the scanner cover to its open position.
2. Connect the network cable into the LAN socket, marked with a  symbol. You will find the LAN socket above and to the left of the ink cartridge slots, as shown below.

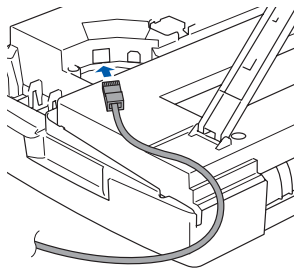

3. Carefully guide the network cable into the trench as shown below, following the trench round and toward the back of the machine.

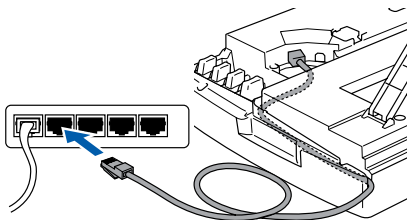

Warning

Ensure that the cable does not restrict the cover from closing, or an error may occur.

 In case of using both USB and LAN cables, guide both cables through the trench.

- 2 Lift the scanner cover to release the lock. Gently push the scanner cover support down and close the scanner cover.
- 3 Turn on the machine by plugging in the power cord.

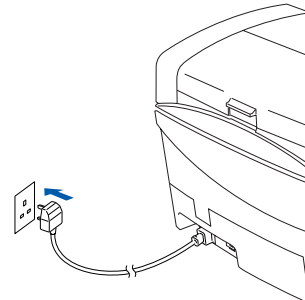

(Example for the U.K.)

- 4 Turn on your computer. (For Windows® 2000 Professional/XP, you must be logged on as the administrator.)
- 5 Insert the supplied CD-ROM into your CD-ROM drive. If the model name screen appears, select your machine. If the language screen appears, select your language.



- 6 The CD-ROM main menu will appear. Click **Install MFL-Pro Suite**.



If this window does not appear, use Windows® Explorer to run the **setup.exe** program from the root directory of the Brother CD-ROM.

Continued...

For Network Interface Cable Users (For Windows® 98/98SE/Me/2000 Professional/XP)



If you see the following screen, click **OK** to install the Windows® updates. After the updates are installed your PC may restart. Then the installation will automatically continue.

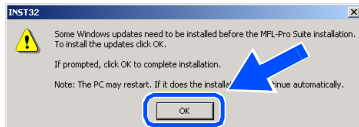

If the installation does not continue automatically, please open the main menu again by ejecting then reinserting the CD-ROM disc or double-click the **setup.exe** program from the root directory, and continue from Step 6 to install the MFL-Pro Suite.

- 7 After reading and accepting the ScanSoft® PaperPort® 9.0SE License Agreement, click **Yes**.

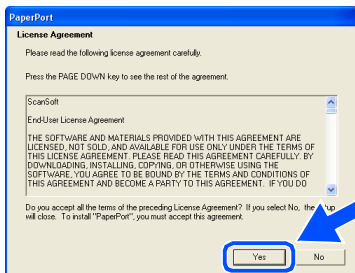

- 8 The installation of PaperPort® 9.0SE will automatically start and is followed by the installation of MFL-Pro Suite.

- 9 When the Brother MFL-Pro Suite Software License Agreement window appears, click **Yes**, if you agree to the Software Licence Agreement.

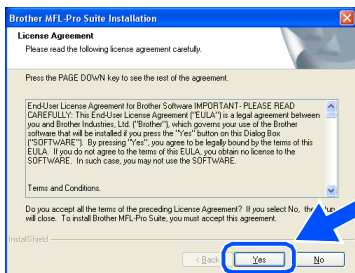

- 10 Select **Network Connection**, and then click **Next**.

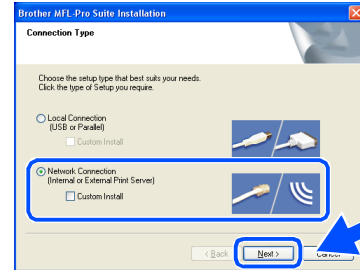

- 11 The installation of the Brother drivers will automatically start. The installation screens appear one after another, please wait for a while.

- 12 If the machine is configured for your network, select the machine from the list, and then click **Next**.



This window will not appear if there is only one machine connected on the network, it will be selected automatically.

If the machine is not yet configured for use on your network, the **Configure IP Address** window will appear. Enter the IP address information appropriate to your network by following the on-screen instructions.

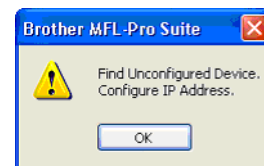

- 13 When the Brother and ScanSoft on-line Registration screen is displayed, make your selection and follow the on-screen instructions.

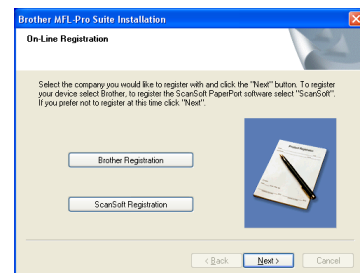

- 14 Click **Finish** to restart your computer.

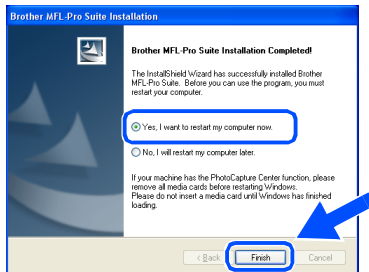

- 15 After restarting the computer, the Installation Diagnostics will run automatically and the installation results window will be shown.



For network installations the **Repair MFL-Pro Suite** selection from the main menu is not supported.

- OK!** The MFL-Pro Suite, Brother Network Printer driver, Network Scanner driver and Network PhotoCapture Center™ have been installed and the installation is now complete.

For USB Interface Cable Users

For Mac OS® X 10.2.4 or greater

Make sure that you have completed the instructions from Step 1 “Setting Up the Machine” on pages 4 - 11.

 For Mac OS® X 10.2.0 to 10.2.3 user, please upgrade to Mac OS® X 10.2.4 or greater. (The latest information for Mac OS® X, please visit at: <http://solutions.brother.com>)

- 1 Turn off and unplug the machine from the AC outlet and disconnect it from your Macintosh® if you already connected an interface cable.

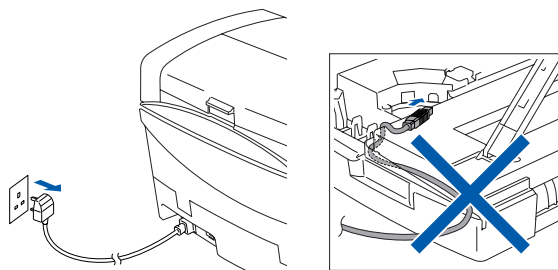

(Example for the U.K.)

- 2 Turn on your Macintosh®.
- 3 Insert the supplied CD-ROM into your CD-ROM drive.



- 4 Double-click the **Start Here OSX** icon to install the printer driver, Scanner driver and Remote Setup program. If the language screen appears, select your language.

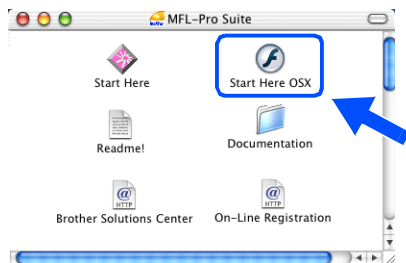

- 5 Click **MFL-Pro Suite** to install.



- 6 Follow the on-screen instructions, and restart your Macintosh®.
- 7 After the **DeviceSelector** window appears, connect the USB interface cable to your Macintosh® and then to the machine.



 The **DeviceSelector** window will not appear if the USB interface cable has been connected before restarting your Macintosh® or if you are overwriting a previously installed version of the Brother Software. If you encounter this problem continue with the installation skipping step 10 and then see the Software User's Guide Chapter 8 for details on selecting what machine the ControlCenter2.0 will connect with.

To connect the USB cable to the machine:

1. Lift the scanner cover to its open position.
2. Connect the USB cable into the USB socket, marked with a  symbol. You will find the USB socket above and to the left of the ink cartridge slots, as shown below.

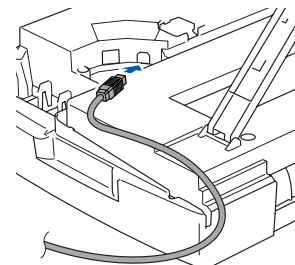

- Carefully guide the USB cable into the trench as shown below, following the trench round and toward the back of the machine.

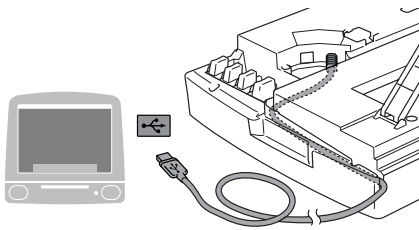

Warning

Ensure that the cable does not restrict the cover from closing, or an error may occur.



DO NOT connect the machine to a USB port on a keyboard or a non powered USB hub.

- Lift the scanner cover to release the lock. Gently push the scanner cover support down and close the scanner cover.
- Turn on the machine by plugging in the power cord.

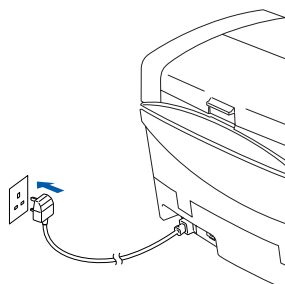

(Example for the U.K.)

- Select **USB** and then click **OK**.



- Select **Applications** from the **Go** menu.

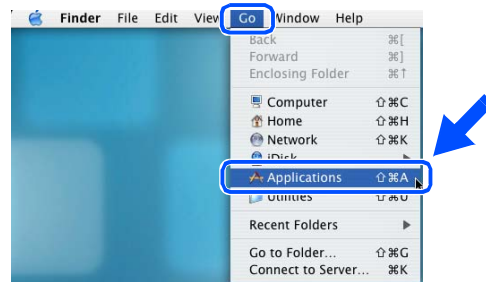

- Open the **Utilities** folder.



- Open the **Print Center** icon.



- Click **Add**.

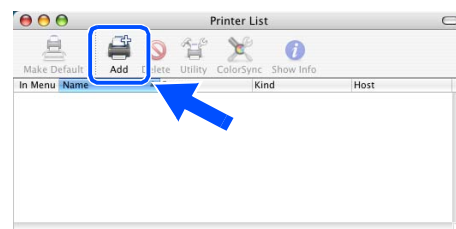



For USB Interface Cable Users

- 15 Select **USB**.

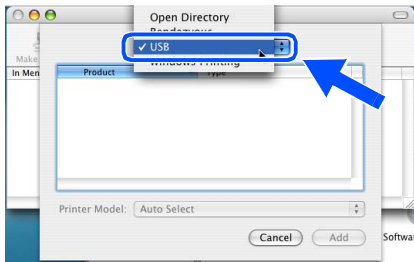

- 16 Select **MFC-XXXX** (XXXX is your model name), and then click **Add**.

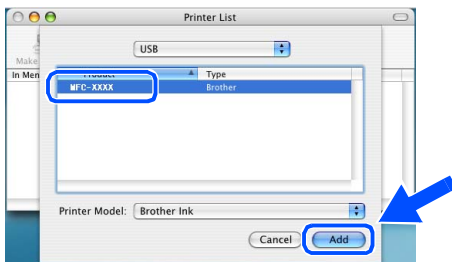

- 17 Select **Quit Printer Setup Utility** from the **Printer Setup Utility** menu.

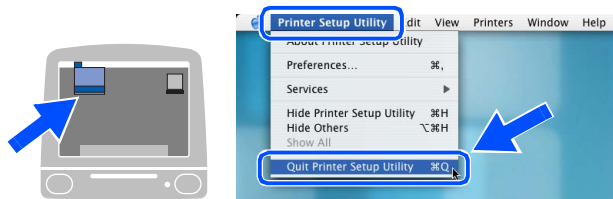

- OK!** The MFL-Pro Suite, Brother Printer driver, Scanner driver and Remote Setup Program have been installed and the installation is now complete.

- 18 To install Presto!® PageManager®, click the **Presto! PageManager** icon and follow the on-screen instructions.



 You can easily scan, share and organize photos and documents using Presto!® PageManager®.

- OK!** Presto!® PageManager® has been installed and the installation is now complete.

For Mac OS® 8.6 to 9.2

Make sure that you have completed the instructions from Step 1 “Setting Up the Machine” on pages 4 - 11.

- 1 Turn off and unplug the machine from the AC outlet and disconnect it from your Macintosh® if you already connected an interface cable.

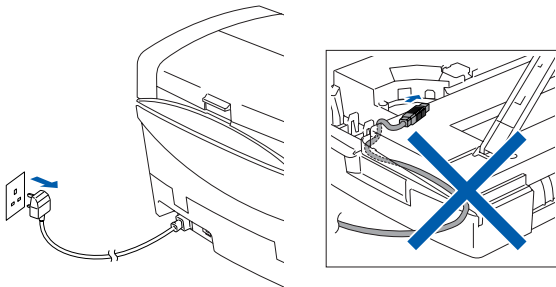

(Example for the U.K.)

- 2 Turn on your Macintosh®.
- 3 Insert the supplied CD-ROM into your CD-ROM drive.



- 4 Double-click the **Start Here** icon to install the printer and scanner drivers. If the language screen appears, select your language.

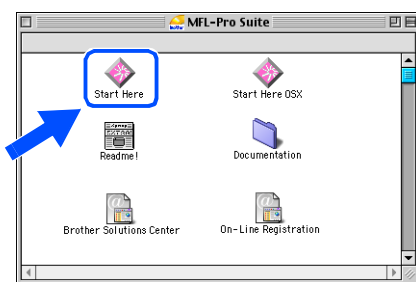

- 5 Click **MFL-Pro Suite** to install.



- 6 Follow the on-screen instructions, and restart your Macintosh®.
- 7 Connect the USB interface cable to your Macintosh®, and then connect it to the machine.

To connect the USB cable to the machine:

1. Lift the scanner cover to its open position.
2. Connect the USB cable into the USB socket, marked with a  symbol. You will find the USB socket above and to the left of the ink cartridge slots, as shown below.

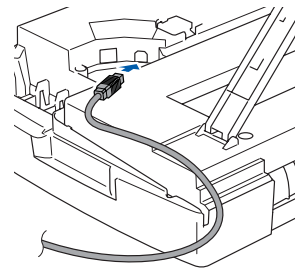

3. Carefully guide the USB cable into the trench as shown below, following the trench round and toward the back of the machine.

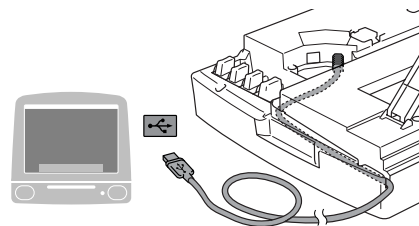

Warning

Ensure that the cable does not restrict the cover from closing, or an error may occur.



DO NOT connect the machine to a USB port on a keyboard or a non powered USB hub.

Continued...

For USB Interface Cable Users

- 8 Lift the scanner cover to release the lock. Gently push the scanner cover support down and close the scanner cover.
- 9 Turn on the machine by plugging in the power cord.

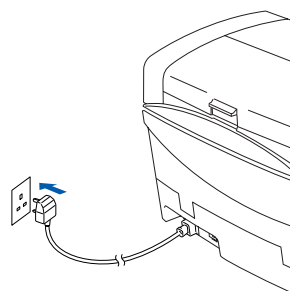

(Example for the U.K.)

- 10 From the Apple® menu, open the **Chooser**.



- 11 Click the **Brother Ink** icon. On the right side of the **Chooser**, select the machine to which you want to print. Close the **Chooser**.

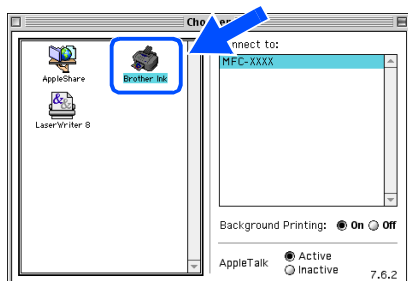

- OK! The **Brother Printer driver and Scanner driver** have been installed.

- 12 To install Presto!® PageManager®, click the **Presto! PageManager** icon and follow the on-screen instructions.



 You can easily scan, share and organize photos and documents using Presto!® PageManager®.

- OK! **Presto! PageManager®** has been installed and the installation is now complete.

For Network Interface Cable Users

For Mac OS® X 10.2.4 or greater

Make sure that you have completed the instructions from Step 1 “Setting Up the Machine” on pages 4 - 11.

- 1 Turn off and unplug the machine from the AC outlet and disconnect it from your Macintosh® if you already connected an interface cable.

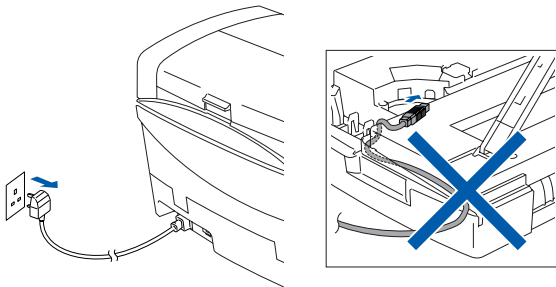

(Example for the U.K.)

- 2 Turn on your Macintosh®.
- 3 Insert the supplied CD-ROM into your CD-ROM drive.
- 4 Double-click the **Start Here OSX** icon to install the printer driver and Remote Setup program. If the language screen appears, select your language.

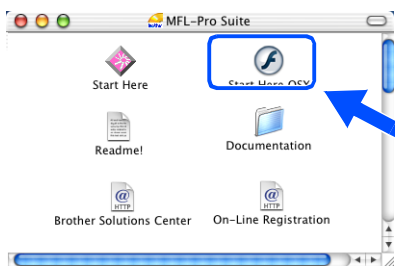

- 5 Click **MFL-Pro Suite** to install.



- 6 Follow the on-screen instructions, and restart your Macintosh®.
- 7 After the **DeviceSelector** window appears, connect the network interface cable to your Macintosh® and then to the machine.



The **DeviceSelector** window will not appear if you have also connected a USB interface cable to the machine before restarting your Macintosh® or if you are overwriting a previously installed version of the Brother Software. If you encounter this problem continue with skipping steps 10 through 12 and then see the Software User's Guide Chapter 8 for details on selecting what machine the ControlCenter2.0 will connect with.

To connect the network interface cable to the machine:

1. Lift the scanner cover to its open position.
2. Connect the network cable into the LAN socket, marked with a  symbol. You will find the LAN socket above and to the left of the ink cartridge slots, as shown below.

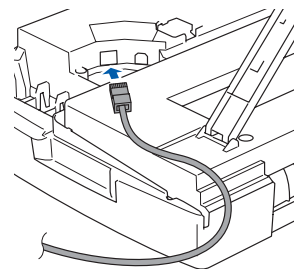

Continued...

For Network Interface Cable Users

- Carefully guide the network cable into the trench as shown below, following the trench round and toward the back of the machine.

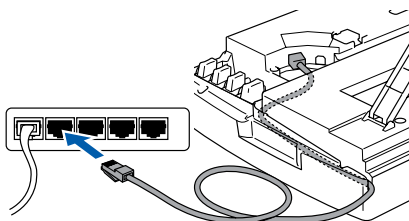

Warning

Ensure that the cable does not restrict the cover from closing, or an error may occur.



In case of using both USB and LAN cables, guide both cables through the trench.

- Lift the scanner cover to release the lock. Gently push the scanner cover support down and close the scanner cover.
- Turn on the machine by plugging in the power cord.

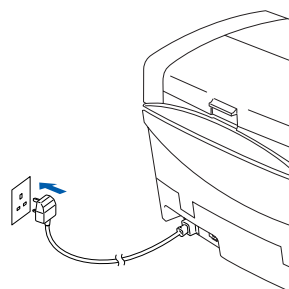

(Example for the U.K.)

- Select **Network** and then click **OK**.

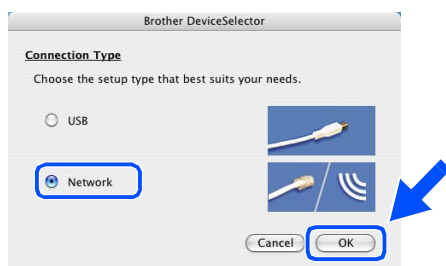

- Click **Browse**.

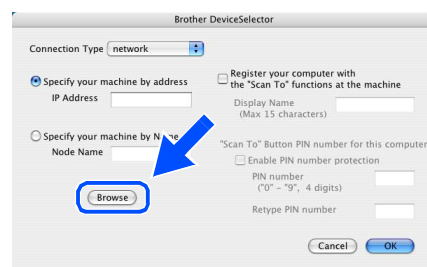

- Select your model name, and then click **OK**. Then click **OK** again to close the DeviceSelector.

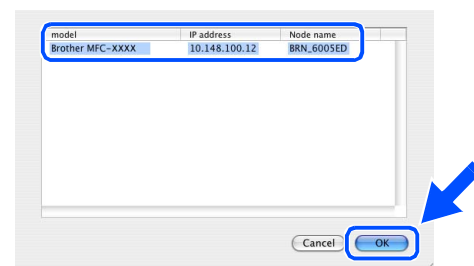

- Select **Applications** from the **Go** menu.

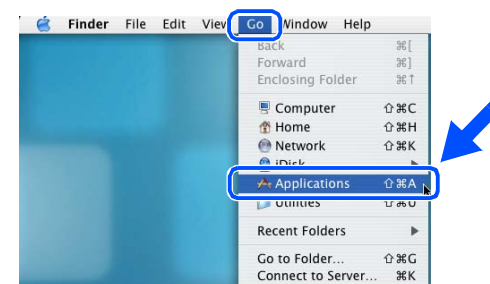

- Open the **Utilities** folder.

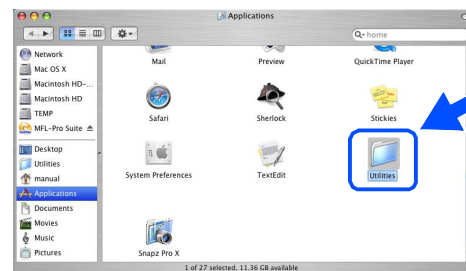

15 Open the **Print Center** icon.



16 Click **Add**.

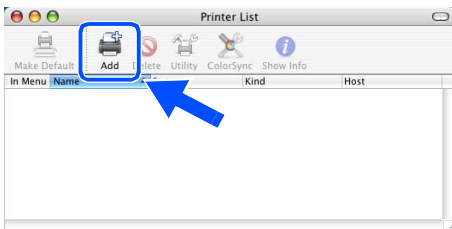

17 Make the selection shown below.

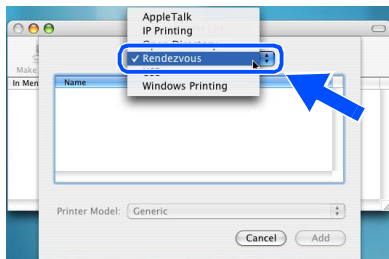

18 Select **Brother MFC-XXXX** (XXXX is your model name) (**BRN_xxxxxx_P1**), and then click the **Add** button.

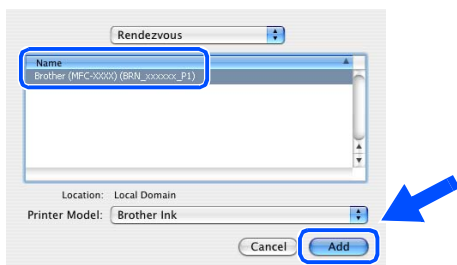

 xxxxxx are the last six digits of the Ethernet address.

 Network User's Guide Chapter 5 on the CD-ROM.

19 Select **Quit Printer Setup Utility** from the **Printer Setup Utility** menu.

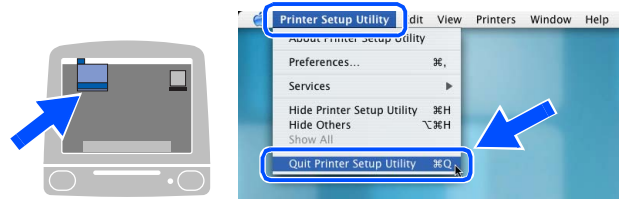

 **The setup is now complete.**

 Please see *Network User's Guide Chapter 5* on the CD-ROM for more information about connecting the machine to a Macintosh® network.

For Network Interface Cable Users

For Mac OS[®] 8.6 to 9.2

Make sure that you have completed the instructions from Step 1 “Setting Up the Machine” on pages 4 - 11.

- 1 Turn off and unplug the machine from the AC outlet and disconnect it from your Macintosh[®] if you already connected an interface cable.

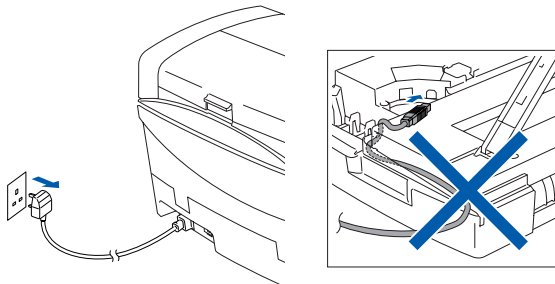

(Example for the U.K.)

- 2 Turn on your Macintosh[®].
- 3 Insert the supplied CD-ROM into your CD-ROM drive.



- 4 Double-click the **Start Here** icon to install the printer and scanner drivers. If the language screen appears, select your language.

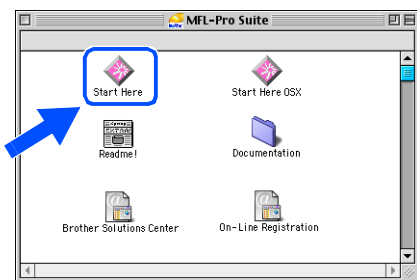

- 5 Click **MFL-Pro Suite** to install.



- 6 Follow the on-screen instructions, and restart your Macintosh[®].
- 7 Connect the network interface cable to the machine, and then connect it to a free port. To connect the network interface cable to the machine:
 1. Lift the scanner cover to its open position.
 2. Connect the network cable into the LAN socket, marked with a  symbol. You will find the LAN socket above and to the left of the ink cartridge slots, as shown below.

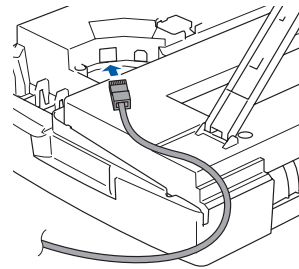

3. Carefully guide the network cable into the trench as shown below, following the trench round and toward the back of the machine.

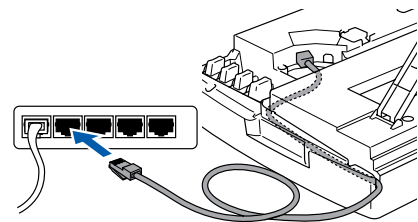

Warning

Ensure that the cable does not restrict the cover from closing, or an error may occur.



In case of using both USB and LAN cables, guide both cables through the trench.

- 8 Lift the scanner cover to release the lock. Gently push the scanner cover support down and close the scanner cover.
- 9 Turn on the machine by plugging in the power cord.

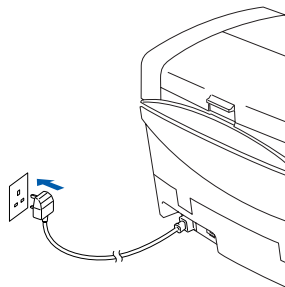

(Example for the U.K.)

- 10 Open the **Chooser** from the **Apple** menu.



- 11 Click the **Brother Ink (IP)** icon, and then select **BRN_XXXXXX**. Close the **Chooser**.

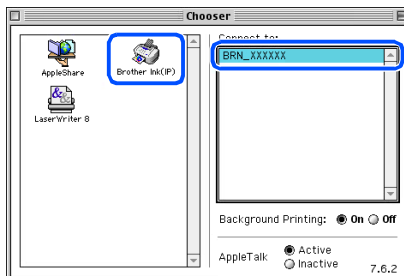

- *xxxxxx are the last six digits of the Ethernet address.*
- *Please see Network User's Guide Chapter 5 on the CD-ROM for more information about connecting the machine to a Macintosh® network.*

OK! The setup is now complete.

■ For Network Users

This section is for using the machine on a network.
An administrator should set up the machine using the following steps.

Network User's Guide Chapter Map

Windows®

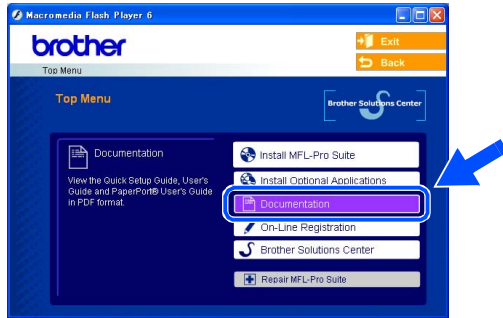

Macintosh®



| | | | | |
|-----------------------------|--------------|--------|-----------|----------------------------------|
| Windows® 98/Me | Peer-to-Peer | TCP/IP | Chapter 4 | Network Printing from Windows® |
| Windows® 2000/XP | Peer-to-Peer | TCP/IP | Chapter 4 | Network Printing from Windows® |
| Macintosh® | | TCP/IP | Chapter 5 | Network Printing from Macintosh® |
| OS2 Warp Server, LAN Server | | TCP/IP | Chapter 4 | Network Printing from Windows® |

Restoring the Network Settings to Factory Default

To restore all network settings of the internal Print/Scan server to factory default, please follow the steps below.

- 1 Make sure the machine is not operating, then disconnect all the cables from the machine (except power cable).
- 2 For **MFC-5440CN**, press **Menu/Set, 4, 0**. For **MFC-5840CN**, press **Menu/Set, 5, 0**.
- 3 Press **1** to select **Reset**.
- 4 Press **1** to select **Yes**.
- 5 The machine will restart, re-connect cables once this is complete.

Installing the BRAdmin Professional Configuration Utility (Windows® only)

The BRAdmin Professional utility is designed to manage your Brother network connected devices such as network-ready Multifunction devices and/or network-ready printers in a Local Area Network (LAN) environment.

BRAdmin Professional can also be used to manage devices from other manufacturers whose products support SNMP (Simple Network Management Protocol).

For more information on BRAdmin Professional go to <http://solutions.brother.com>

- 1 Insert the supplied CD-ROM into your CD-ROM drive. The opening screen will appear automatically. Follow the on-screen instructions.



- 2 Click the **Install Optional Applications** icon on the main menu screen.



- 3 Click **BRAdmin Professional** and follow the on-screen instructions.

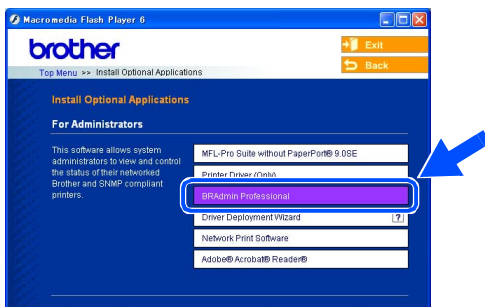

The default password for the print server is **“access”**. You can use BRAdmin Professional to change this password.

Setting your IP Address, Subnet Mask and Gateway using BRAdmin Professional (Windows® only)

- 1 Start BRAdmin Professional, and select **TCP/IP**.

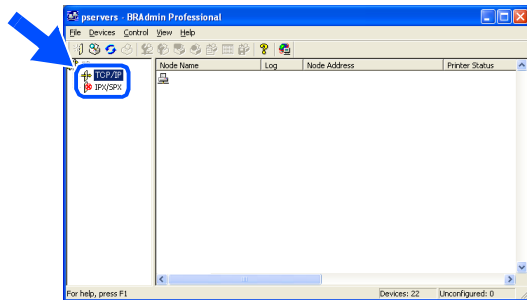

- 2 Select **Search Active Devices** from the **Devices** menu. BRAdmin will search for new devices automatically.

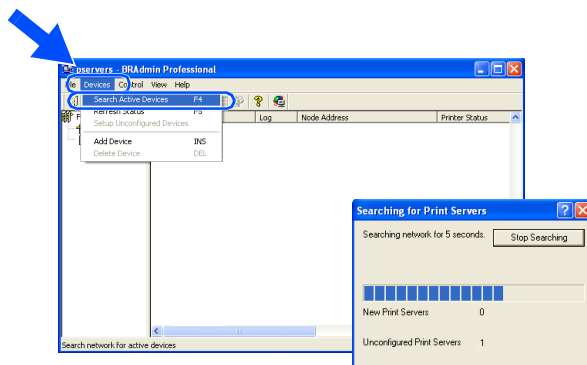

- 3 Double-click the new device.

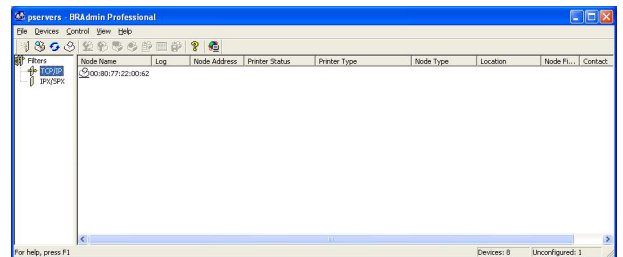

- 4 Enter the **IP Address**, **Subnet Mask** and **Gateway**, and then click the **OK** button.

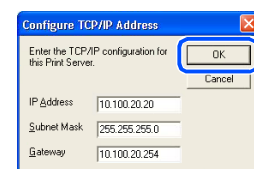

- 5 The address information will be saved to the machine.

 The default password for the print server is **“access”**. You can use BRAdmin Professional to change this password.

■ Consumables and Options

Replacement Consumables

Ink Cartridge

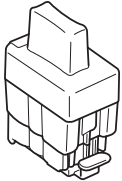
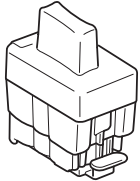
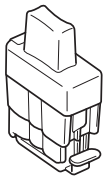
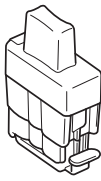
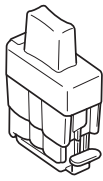
| Black (Standard) | Black (High Yield) | Magenta | Yellow | Cyan |
|-----------------------------------------------------------------------------------|-----------------------------------------------------------------------------------|-----------------------------------------------------------------------------------|------------------------------------------------------------------------------------|-------------------------------------------------------------------------------------|
| LC900BK | LC900HYBK | LC900M | LC900Y | LC900C |
|  |  |  |  |  |

Option

The external wireless Print/Scan server (802.11b) is available for Brother MFC's as an option.

| |
|-----------------------------------------------------------------------------------------------------------------------------------|
| External Wireless Print/Scan Server |
| NC-2200w |
|  |
| The optional External Wireless Print/Scan Server (NC-2200w) provides wireless network printing and network scanning capabilities. |



- Requires USB 2.0 cable (not included).
- Supports Mac OS® X 10.2.4 or greater.
- You can assign the scan key to one networked computer only.

Trademarks

The Brother logo is a registered trademark of Brother Industries, Ltd.

Brother is a registered trademark of Brother Industries, Ltd.

Multi-Function Link is a registered trademark of Brother International Corporation.

© Copyright 2004 Brother Industries, Ltd. All rights reserved.

Windows and Microsoft are registered trademarks of Microsoft in the U.S. and other countries.

Macintosh and True Type are registered trademarks of Apple Computer, Inc.

PaperPort and OmniPage OCR are registered trademarks of ScanSoft, Inc.

Presto! PageManager is a registered trademark of NewSoft Technology Corporation.

Each company whose software title is mentioned in this manual has a Software License Agreement specific to its proprietary programs.

All other brand and product names mentioned in this manual are registered trademarks of their respective companies.

Compilation and Publication

Under the supervision of Brother Industries Ltd., this manual has been compiled and published, covering the latest product descriptions and specifications.

The contents of this manual and the specifications of this product are subject to change without notice.

Brother reserves the right to make changes without notice in the specifications and materials contained herein and shall not be responsible for any damages (including consequential) caused by reliance on the materials presented, including but not limited to typographical and other errors relating to the publication.

This product is designed for use in a Professional Environment.

©2004 Brother Industries, Ltd.



UK
LF7125001①

Free Manuals Download Website

<http://myh66.com>

<http://usermanuals.us>

<http://www.somanuals.com>

<http://www.4manuals.cc>

<http://www.manual-lib.com>

<http://www.404manual.com>

<http://www.luxmanual.com>

<http://aubethermostatmanual.com>

Golf course search by state

<http://golfingnear.com>

Email search by domain

<http://emailbydomain.com>

Auto manuals search

<http://auto.somanuals.com>

TV manuals search

<http://tv.somanuals.com>