

DCP-770CW

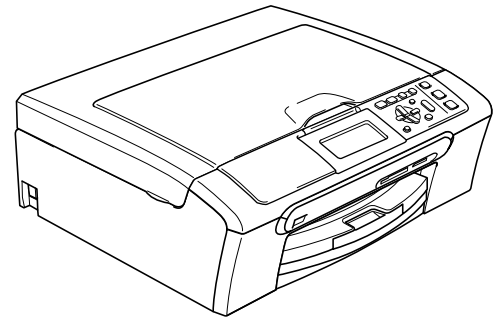

Quick Setup Guide

Before you can use the machine, you must set up the hardware and install the software. Please read this Quick Setup Guide for the correct setup procedure and installation instructions.

STEP 1

Setting Up the Machine



STEP 2





Installing the Driver & Software

Setup is Complete!

Keep this Quick Setup Guide, the User's Guide and the supplied CD-ROM in a convenient place for quick and easy reference at all times.



Symbols used in this guide

 Warning	 Caution	 Improper Setup
<p>Warnings tell you what to do to prevent possible personal injury.</p>	<p>Cautions specify procedures you must follow or avoid to prevent possible damage to the machine or other objects.</p>	<p>Improper Setup icons alert you to devices and operations that are not compatible with the machine.</p>
 Note	 User's Guide, Software User's Guide or Network User's Guide	
<p>Notes tell you how you should respond to a situation that may arise or give tips about how the current operation works with other features.</p>	<p>Indicates reference to the User's Guide, Software User's Guide or Network User's Guide which is on the CD-ROM we have supplied.</p>	

Getting Started

Carton components	3
Control panel	4

STEP 1 – Setting Up the Machine

Removing the protective parts	5
Loading paper	5
Connecting the power cord	7
Choosing your language	7
Installing the ink cartridges	8
Print quality check	10
Setting the LCD Contrast	10
Setting the date and time	11

STEP 2 – Installing the Driver & Software

Windows®

For USB Interface Users (For Windows® 2000 Professional/XP/XP Professional x64 Edition/Windows Vista™)	14
Installing FaceFilter Studio	17
For Wired Network Interface Users (For Windows® 2000 Professional/XP/XP Professional x64 Edition/Windows Vista™)	18
Installing FaceFilter Studio	21
For Wireless Network Interface Users (For Windows® 2000 Professional/XP/XP Professional x64 Edition/Windows Vista™) in infrastructure mode	22
Connecting your wireless machine and wireless network together and installing the printer driver in infrastructure mode	22
Using the SecureEasySetup™ or AOSS™ software to configure your machine for a wireless network	24
Using the Setup Wizard from the control panel LAN menu for wireless network configuration	26
Installing FaceFilter Studio	30

Macintosh®

For USB Interface Users (For Mac OS® X 10.2.4 or greater)	31
For Wired Network Interface Users (For Mac OS® X 10.2.4 or greater)	34
For Wireless Network Interface Users (For Mac OS® X 10.2.4 or greater) in infrastructure mode	37
Connecting your wireless machine and wireless network together and installing the printer driver in infrastructure mode	37
Using the SecureEasySetup™ or AOSS™ software to configure your machine for a wireless network	39
Using the Setup Wizard from the control panel LAN menu for wireless network configuration	41

For Network Users

BRAdmin Light utility (For Windows® users)	45
Installing the BRAdmin Light configuration utility	45
Setting your IP address, Subnet Mask and Gateway using BRAdmin Light	45
BRAdmin Light utility (For Mac OS® X users).....	46
Setting your IP address, Subnet Mask and Gateway using BRAdmin Light	46
Entering Text.....	47
Restoring the network settings to factory default.....	47

Installing FaceFilter Studio Help

Instructions on how to install FaceFilter Studio Help (For Windows® users).....	48
Installing FaceFilter Studio Help	48

Consumables





Replacement consumables.....	49
Ink cartridge	49

Carton components

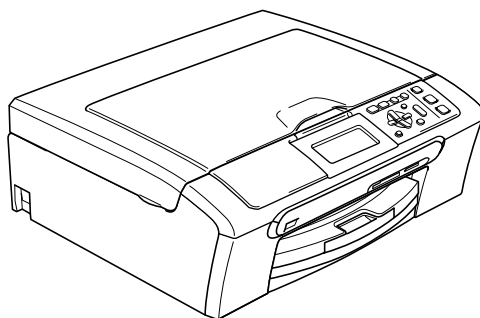
Carton components may vary from one country to another.

Save all packing materials and the carton in case for any reason you must ship your machine.

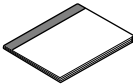

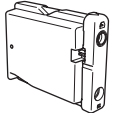
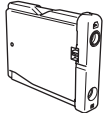
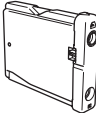
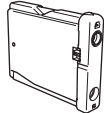
 Quick Setup Guide	 CD-ROM	 User's Guide	 Power Cord
 Black (LC1000BK)	 Yellow (LC1000Y)	 Cyan (LC1000C)	 Magenta (LC1000M)
<p>The ink cartridges are on top of the paper tray. See <i>Removing the protective parts</i> on page 5.</p> <p style="text-align: center;">Ink Cartridges</p>			

An interface cable is not a standard accessory. You need to purchase an appropriate USB 2.0 interface cable or network cable.

USB cable

- Please make sure you use a USB 2.0 cable that is no longer than 2 metres.
- Your machine has a USB interface that is compatible with the USB 2.0 specification.
- DO NOT connect the interface cable at this time.
Connecting the interface cable is done during the software installation process.

Network cable

- Use a straight-through Category5 (or greater) twisted-pair cable for 10BASE-T or 100BASE-TX Fast Ethernet Network.

Control panel

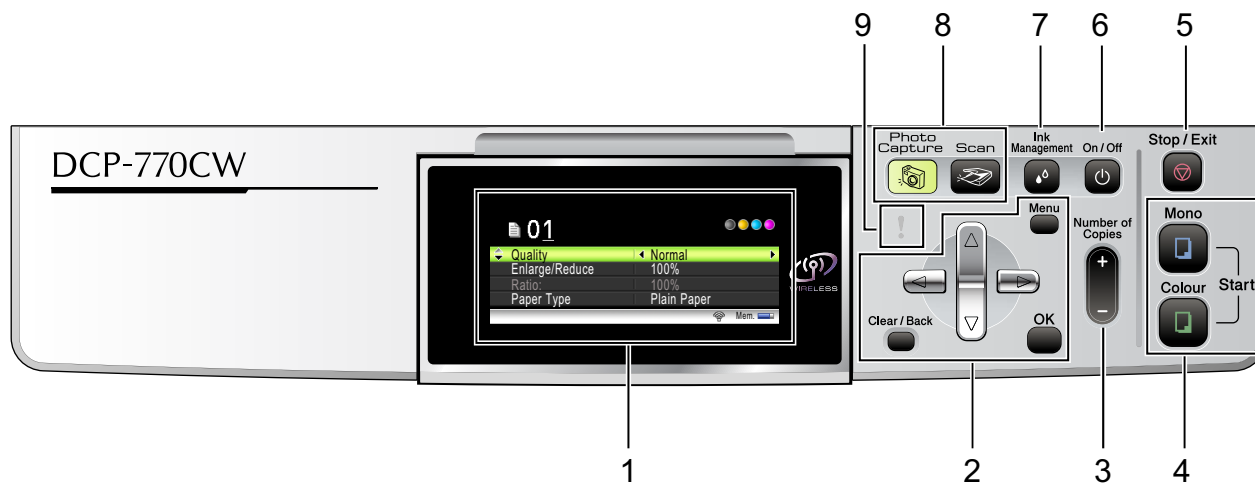

- | | |
|--------------------------------|----------------------|
| 1 LCD (Liquid Crystal Display) | 6 On/Off key |
| 2 Menu keys | 7 Ink Management key |
| 3 Number of Copies key | 8 Mode keys |
| 4 Start keys | 9 Warning LED |
| 5 Stop/Exit key | |



For the details of the control panel, see Control panel overview in Chapter 1 of the User's Guide.

1 Removing the protective parts

- 1 Remove the protective tape and film covering the scanner glass.
- 2 Remove the foam bag (1) containing the ink cartridges from on top of the paper tray.

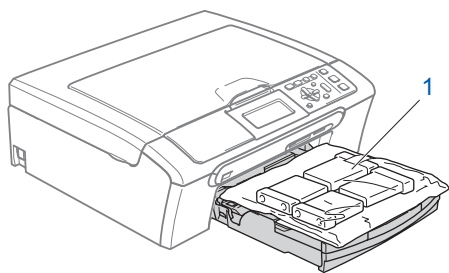

⊘ Improper Setup

DO NOT connect the interface cable.
Connecting the interface cable is done during the software installation process.

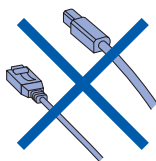

2 Loading paper

-  You can load up to 100 sheets of 80 g/m² paper.
For details, see *Acceptable paper and other media* in Chapter 2 of the User's Guide.

- 1 Pull the paper tray completely out of the machine and lift the output paper tray cover (1).

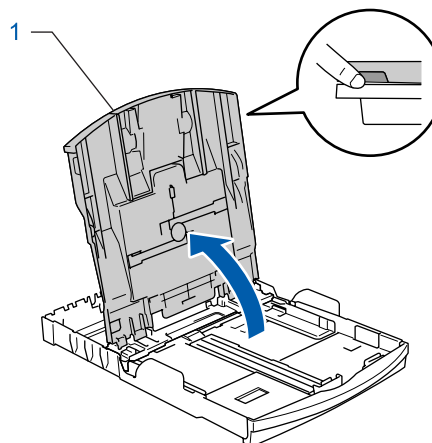
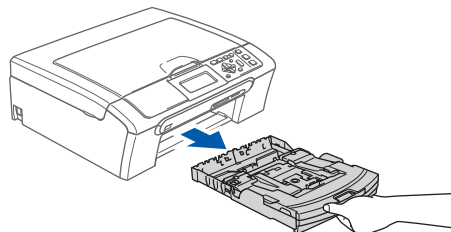

- 2 Press and slide the paper side guides (1) and paper length guide (2) to fit the paper size.

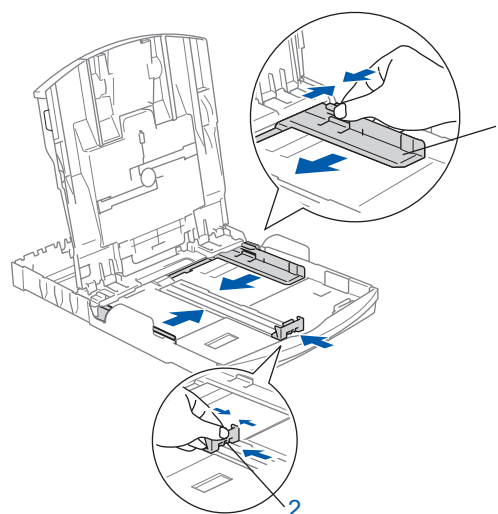

- 3** Fan the stack of paper well to avoid paper jams and misfeeds.

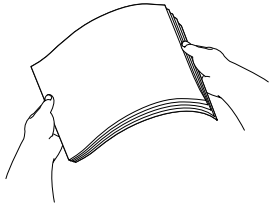

- 4** Gently put the paper into the paper tray print side down and top edge first. Check that the paper is flat in the tray.

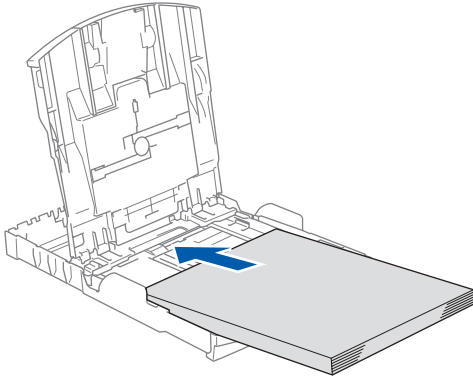

 **Note**

When you use Legal size paper, press and hold the universal guide release button (1) as you slide out the front of the paper tray.

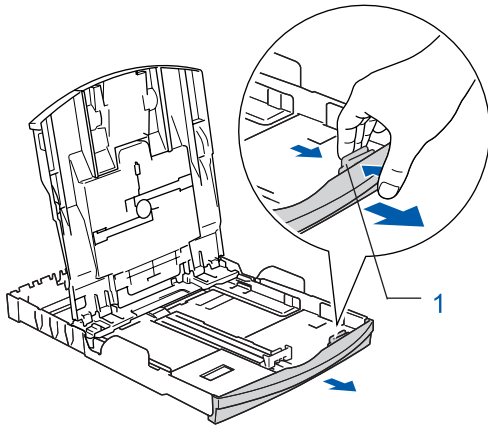

- 5** Gently adjust the paper side guides with both hands to fit the paper. Make sure that the paper guides touch the edges of the paper.

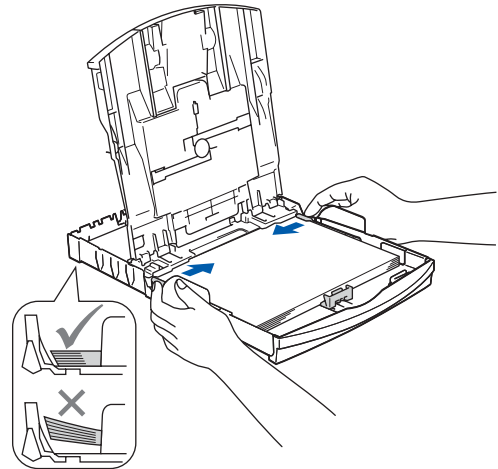

 **Note**

Be careful that you do not push the paper in too far; it may lift at the back of the tray and cause paper feed problems.

- 6** Close the output paper tray cover (1).

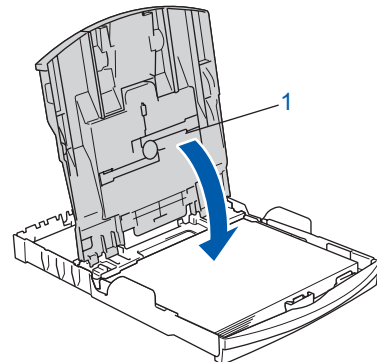

- 7** Slowly push the paper tray completely into the machine.

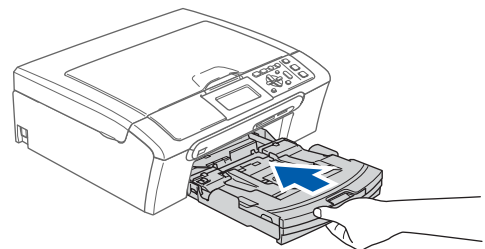

- 8** While holding the paper tray in place, pull out the paper support ① until it clicks, and then unfold the paper support flap ②.

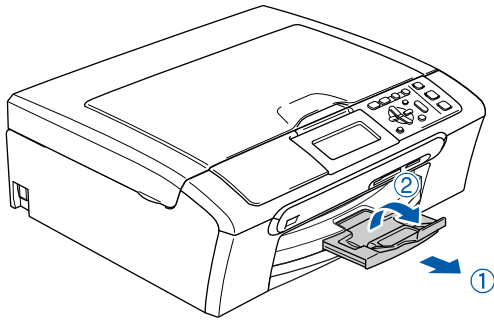

Note

Do not use the paper support flap ② for Legal size paper.

Note

You can use the photo paper tray which is located on the top of the paper tray to print on photo 10 × 15 cm and photo L size paper. For details, see Loading photo paper in Chapter 2 of the User's Guide.

3 Connecting the power cord

- 1** Connect the power cord.

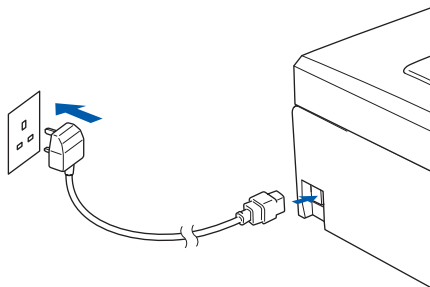

⊘ Improper Setup

DO NOT connect the interface cable. Connecting the interface cable is done during the software installation process.

⚠ Warning

The machine must be fitted with an earthed plug.

Note

The control panel warning LED will stay on until you have installed the ink cartridges.

4 Choosing your language

- 1** After connecting the power cord, the LCD shows:

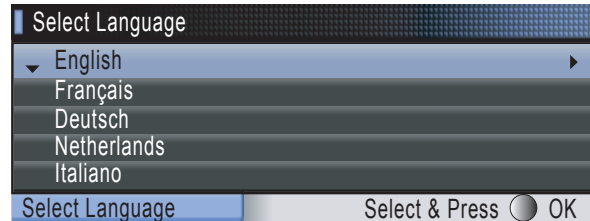

Press ▲ or ▼ to choose your language and press **OK**.

- 2** Choose **Yes** or **No** and press **OK**.

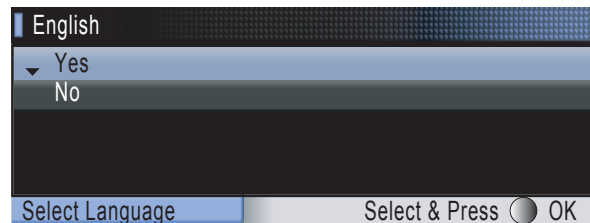

If you set the wrong language, you can change the language after setting the date and time. (For details, see Changing LCD language in Appendixes B of the User's Guide.)

5 Installing the ink cartridges

Warning

If ink gets in your eyes, wash them out with water at once, and if irritation occurs consult a doctor.

- 1 Make sure that the power is turned on.
The LCD shows:

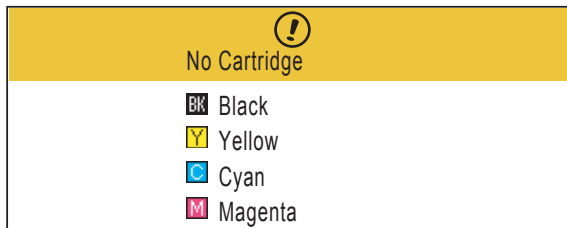

- 2 Open the ink cartridge cover (1).

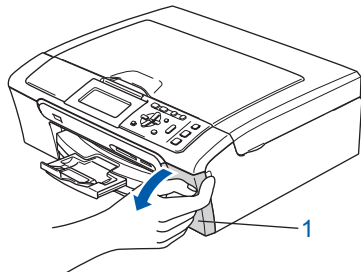

- 3 Pull all the lock release levers down and remove the yellow protective part (1).

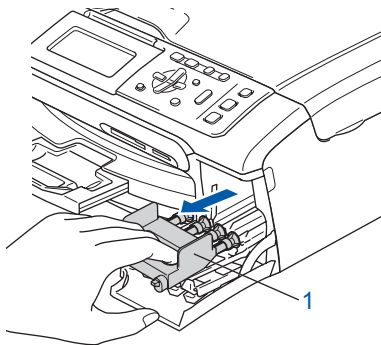
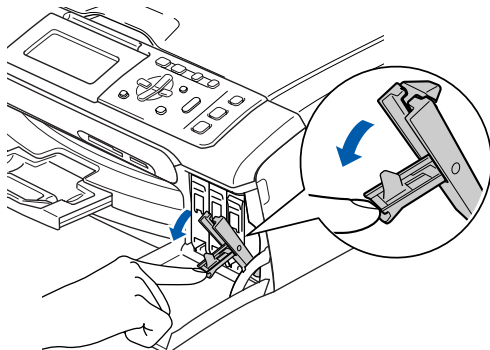

Note

Do not throw away the yellow protective part. You will need it if you transport the machine.

- 4 Take out the ink cartridge.

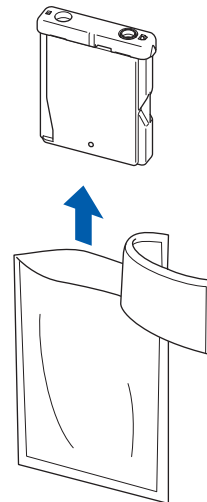

- 5 Carefully remove the protective yellow cap (1).

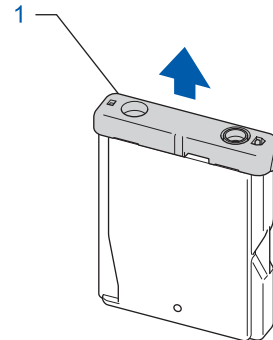

Improper Setup

DO NOT touch the area shown in the illustration below.

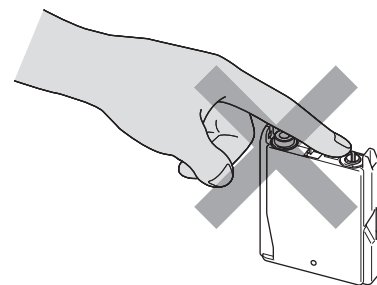

Note

If the protective yellow cap comes off when you open the bag, the cartridge will not be damaged.

- 6** Install each ink cartridge in the direction of the arrow on the label. Take care to match the colour of the lock release lever (1) with the cartridge colour (2), as shown in the diagram below.

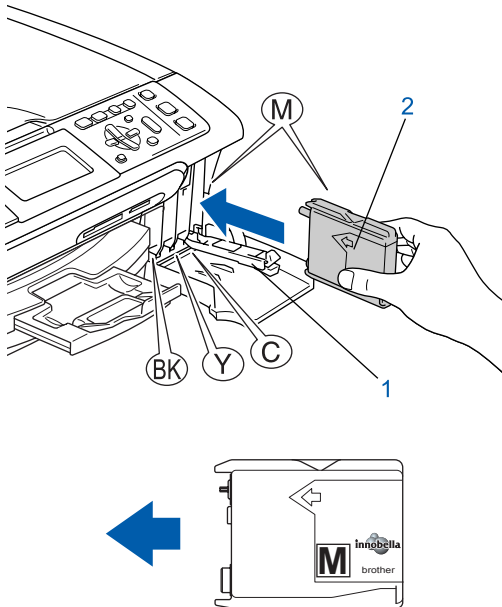

- 7** Lift each lock release lever and gently push it until it clicks, and then close the ink cartridge cover.

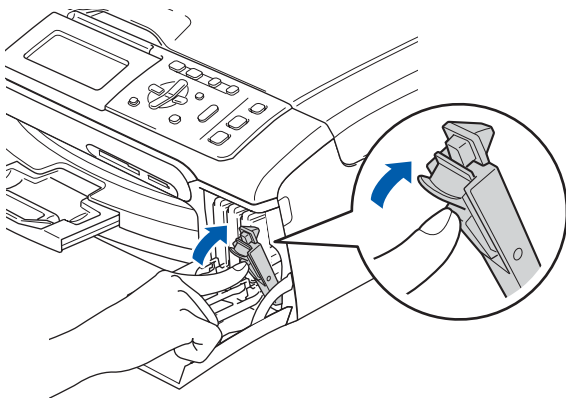

Note

If the LCD prompts you to re-insert the ink cartridge correctly, after you install the ink cartridges, check that the ink cartridges are installed correctly.

The first time the ink cartridges are installed the machine prepares and cleans the ink tube system. This initial process will take more time than a normal cleaning cycle but will happen only once.

The LCD shows:

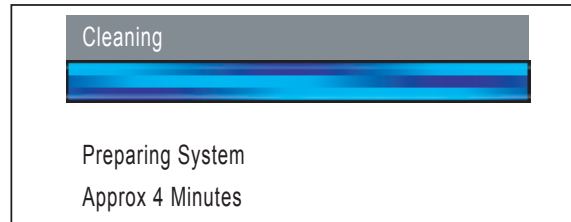

Caution

- DO NOT take out ink cartridges if you do not need to replace them. If you do so, it may reduce the ink quantity and the machine will not know the quantity of ink left in the cartridge.
- DO NOT shake the ink cartridges. If ink stains your skin or clothing, wash with soap or detergent at once.
- DO NOT repeatedly insert and remove the cartridges. If you do so, ink may seep out of the cartridge.
- If you mix the colours by installing an ink cartridge in the wrong position, clean the print head several times after correcting the cartridge installation. (See *Cleaning the print head in Appendixes B of the User's Guide.*)
- Once you open an ink cartridge, install it in the machine and use it up within six months of installation. Use unopened ink cartridges by the expiration date written on the cartridge package.
- DO NOT dismantle or tamper with the ink cartridge, this can cause the ink to leak out of the cartridge.
- Brother multifunction machines are designed to work with ink of a particular specification and will work to a level of optimum performance when used with genuine Brother branded ink cartridges. Brother cannot guarantee this optimum performance if ink or ink cartridges of other specifications are used. Brother does not therefore recommend the use of cartridges other than genuine Brother branded cartridges with this machine or the refilling of empty cartridges with ink from other sources. If damage is caused to the print head or other parts of this machine as a result of using incompatible products with this machine, any repairs required as a result may not be covered by the warranty.

6 Print quality check

- 1 Make sure A4, Letter or Legal size paper is loaded in the paper tray.
Press **Colour Start**.
The machine starts printing the Print Quality Check Sheet (only during initial ink cartridge installation).
- 2 Check the quality of the four colour blocks on the sheet.
(black/yellow/cyan/magenta)

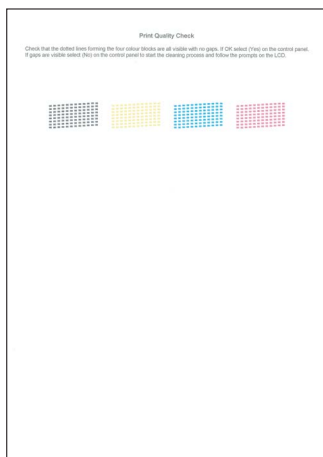

Note

Avoid touching the printed surface of the paper immediately after printing, the surface may not be completely dry and may stain your fingers.

- 3 The LCD shows:

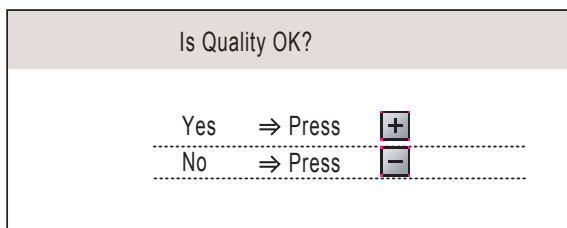

- If all lines are clear and visible, press **+** (Yes) to finish the quality check.
- If you can see missing short lines, press **-** (No) and go to step 4.

OK

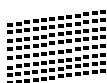

Poor



- 4 The LCD asks you if the print quality is OK for black and colour. Press **+** (Yes) or **-** (No).

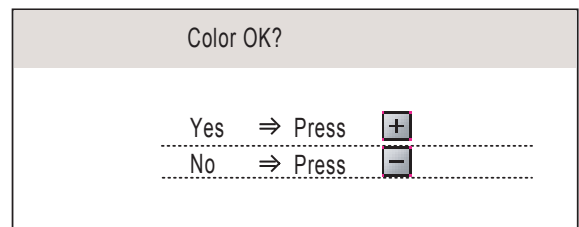
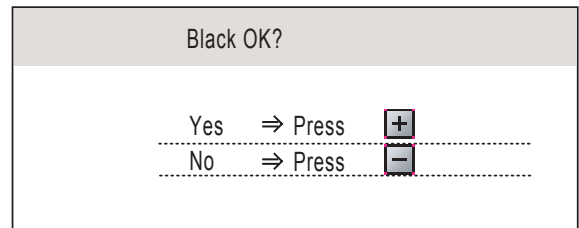

After pressing **+** (Yes) or **-** (No) for both black and colour, the LCD shows:

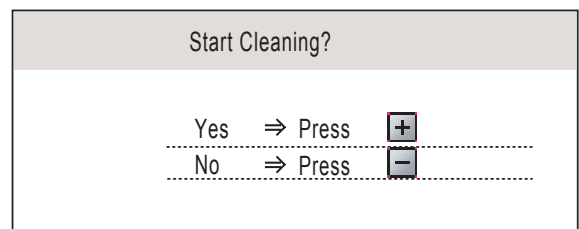

- 5 Press **+** (Yes), the machine will then start cleaning the colours.
- 6 After cleaning is finished, press **Colour Start**. The machine starts printing the Print Quality Check Sheet again and goes back to step 2.

7 Setting the LCD Contrast

You can adjust the LCD contrast for a sharper and more vivid display. If you are having difficulty reading the LCD, try changing the contrast setting.

- 1 Press **Menu**.
- 2 Press **▲** or **▼** to choose **General Setup**. Press **OK**.
- 3 Press **▲** or **▼** to choose **LCD Settings**. Press **OK**.
- 4 Press **▲** or **▼** to choose **LCD Contrast**.
- 5 Press **◀** or **▶** to choose **Light**, **Med** or **Dark**. Press **OK**.
- 6 Press **Stop/Exit**.

Note

You can also adjust the angle of the LCD display by lifting it.

8 Setting the date and time

Setting the date and time allows the machine to clean the print head regularly and maintain optimum print quality. It also allows the machine to name files created when using the Scan to Card feature.

- 1 Press **Menu**.
- 2 Press **▲** or **▼** to choose **Initial Setup**, and then press **OK**.
- 3 Press **▲** or **▼** to choose **Date&Time**, and then press **OK**.
- 4 Press **▲** or **▼** to enter the last two digits of the year, and then press **OK**.

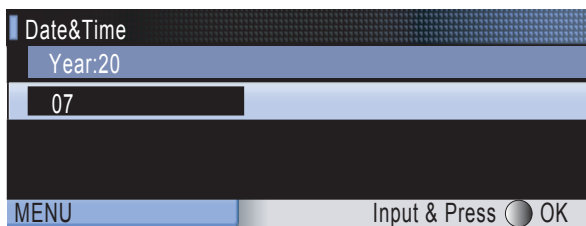

(e.g. Enter **0 7** for 2007.)

- 5 Press **▲** or **▼** to enter the two digits for the month, and then press **OK**.

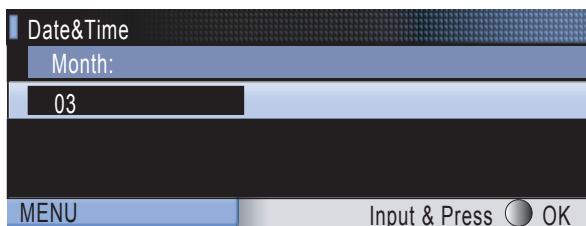

(e.g. Enter **0 3** for March.)

- 6 Press **▲** or **▼** to enter the two digits for the day, and then press **OK**.

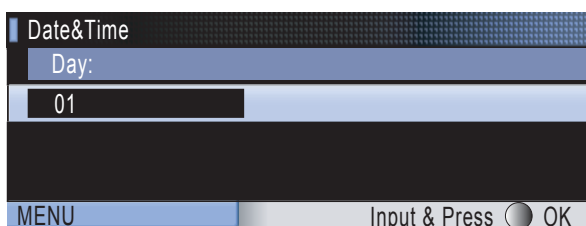

(e.g. Enter **0 1** for the first day of the month.)

- 7 Press **▲** or **▼** to enter the two digits for the hour in 24-hour format, and then press **▶** to next.

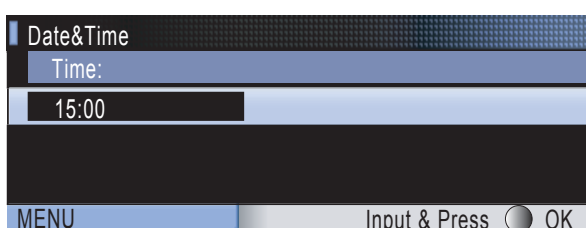

(e.g. Enter **1 5** for 15:00)

- 8 Press **▲** or **▼** to enter the two digits for the minutes, and then press **OK**.

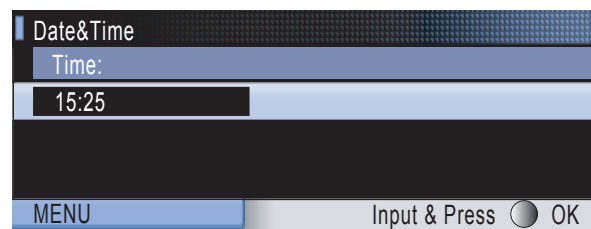

(e.g. Enter **1 5, 2 5** for 15:25.)

Note

You can increase or decrease the number rapidly by holding down **▲** or **▼**.

- 9 Press **Stop/Exit**.

Note

If you make a mistake and want to start again, press **Stop/Exit** and go back to step 1.



To confirm the current date and time, print out the **User Settings** report. (See **Printing Reports** in Chapter 1 of the *User's Guide*.)

Now go to

Supplied CD-ROM 'MFL-Pro Suite' on the next page to install the drivers.

Supplied CD-ROM 'MFL-Pro Suite'

Windows®



Install MFL-Pro Suite

You can install the MFL-Pro Suite software and multifunction drivers.

Install Other Drivers or Utilities

You can install additional MFL-Pro Suite software utilities, install without ScanSoft™ PaperPort™ 11SE with OCR by NUANCE™, install the printer driver only or install FaceFilter Studio.

Documentation

View the Software User's Guide and Network User's Guide in HTML format. You can also view the manuals in PDF format by accessing the Brother Solutions Center. The Software User's Guide and Network User's Guide include instructions for features available when connected to a computer. (eg. Printing, scanning and networking details)

On-Line Registration

Register your machine from the Brother Product Registration Page.

Brother Solutions Center

Access the Brother Solutions Center for FAQs, User's Guide, driver updates and tips for using your machine. (Internet access required)

Supplies Information

View our web site for original/genuine Brother supplies at <http://www.brother.com/original/>.

Repair MFL-Pro Suite (USB only)

If an error occurred during the installation of the MFL-Pro Suite, use this selection to automatically repair and re-install the MFL-Pro Suite.

Note

MFL-Pro Suite includes the Printer Driver, Scanner Driver, Brother ControlCenter3, ScanSoft™ PaperPort™ 11SE. ScanSoft™ PaperPort™ 11SE is a document management application for scanning and viewing documents.

Macintosh®



Start Here OSX

You can install the MFL-Pro Suite that includes the printer driver, scanner driver, Brother ControlCenter2 and BRAdmin Light for Mac OS® X 10.2.4 or greater.

Presto! PageManager

You can also install Presto!® PageManager® to add OCR capability to Brother ControlCenter2 and easily scan, share and organize photos and documents.

For Mac OS® X 10.3.9 or greater users, you can directly install the software from the included CD-ROM, follow the steps in Installing the Drivers & Software.

For Mac OS® X 10.2.4 to 10.3.8 users, you need to download the software from the Brother Solutions Center web site. To download, follow the steps in Installing the Drivers & Software.

Documentation

View the Software User's Guide and Network User's Guide in HTML format. You can also view the manuals in PDF format by accessing the Brother Solutions Center. The Software User's Guide and Network User's Guide include instructions for features available when connected to a computer. (eg. Printing, scanning and networking details)

Brother Solutions Center

Access the Brother Solutions Center for FAQs, User's Guide, driver updates and tips for using your machine. (Internet access required)

On-Line Registration

Register your machine from the Brother Product Registration Page.

Utilities

You can find the following additional Utilities from this folder.

- Wireless Device Setup Wizard
- Presto!® PageManager® Uninstaller
- BRAdmin Light

STEP 2

Installing the Driver & Software

Follow the instructions on this page for your operating system and interface.
For the latest drivers, documentation, and to find the best solution for your problem, access the Brother Solution Center directly from the CD-ROM / Driver or visit <http://solutions.brother.com>.

Windows®



For USB Interface Users
(For Windows® 2000 Professional/XP/
XP Professional x64 Edition/Windows Vista™) 14



For Wired Network Interface Users
(For Windows® 2000 Professional/XP/
XP Professional x64 Edition/Windows Vista™) 18



For Wireless Network Interface Users
(For Windows® 2000 Professional/XP/
XP Professional x64 Edition/Windows Vista™) in infrastructure mode 22

Macintosh®



For USB Interface Users
(For Mac OS® X 10.2.4 or greater) 31



For Wired Network Interface Users
(For Mac OS® X 10.2.4 or greater) 34



For Wireless Network Interface Users
(For Mac OS® X 10.2.4 or greater) in infrastructure mode 37

The screens for Windows® in this Quick Setup Guide are based on Windows® XP.
The screens for Mac OS® X in this Quick Setup Guide are based on Mac OS® X 10.4.

Screens on your computer may vary depending on your operating system.

For USB Interface Users (For Windows® 2000 Professional/XP/ XP Professional x64 Edition/Windows Vista™)

Important

Make sure that you have finished the instructions from **STEP 1 Setting Up the Machine** on pages 5 through 11.

Note

- The supplied CD-ROM includes ScanSoft™ PaperPort™ 11SE. This software supports Windows® 2000 (SP4 or greater), XP (SP2 or greater), XP Professional x64 Edition and Windows Vista™ only. Please update to the latest Windows® Service Pack before installing MFL-Pro Suite.
- Please close any applications running before installing MFL-Pro Suite.
- Make sure there are no memory cards or a USB Flash memory drive inserted into the media drives or USB direct interface at the front of the machine.

- 1 Disconnect the machine from the power socket and from your computer, if you already connected an interface cable.

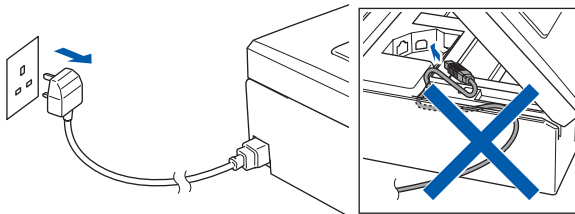

- 2 Turn on your computer. You must be logged on with Administrator rights.

- 3 Put the supplied CD-ROM into your CD-ROM drive. If the model name screen appears, choose your machine. If the language screen appears, choose your language.

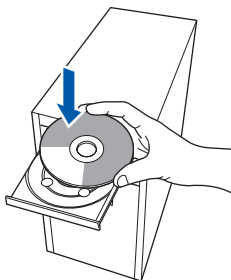

- 4 The CD-ROM main menu will appear. Click **Install MFL-Pro Suite**.



If this window does not appear, use Windows® Explorer to run the **start.exe** program from the root folder of the Brother CD-ROM.

Note

- If this screen appears, click **OK** and restart your computer.

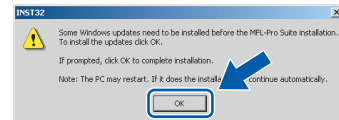

- If the installation does not continue automatically, open the main menu again by ejecting and then reinserting the CD-ROM disc or double-click the **start.exe** program from the root folder, and continue from step 4 to install MFL-Pro Suite.
- For Windows Vista™, when the User Account Control screen appears, click **Allow**.

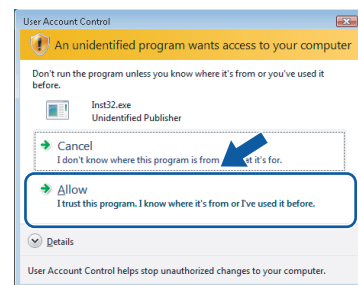

- 5 Choose **Local Connection**, and then click **Next**. The installation continues.

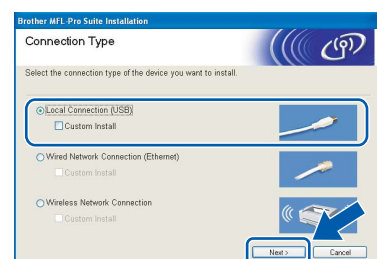

- 6** After reading and accepting the ScanSoft™ PaperPort™ 11SE License Agreement, click **Yes**.

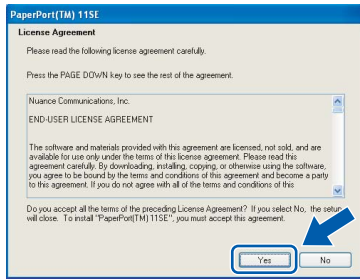

- 7** The installation of ScanSoft™ PaperPort™ 11SE will automatically start and is followed by the installation of MFL-Pro Suite.

- 8** When the Brother MFL-Pro Suite Software License Agreement window appears, click **Yes** if you agree to the Software License Agreement.

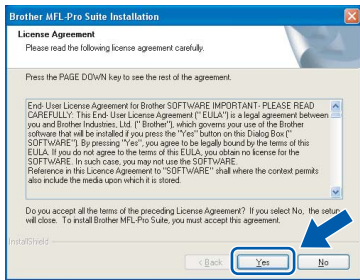

- 9** When this screen appears, go to the next step.



- 10** Using both hands, use the plastic tabs on both sides of the machine to lift the scanner cover until it locks securely into the open position.

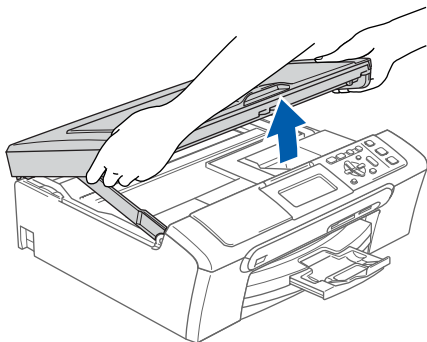

- 11** Connect the USB cable to the USB socket marked with a  symbol. You will find the USB socket inside the machine on the right as shown below.

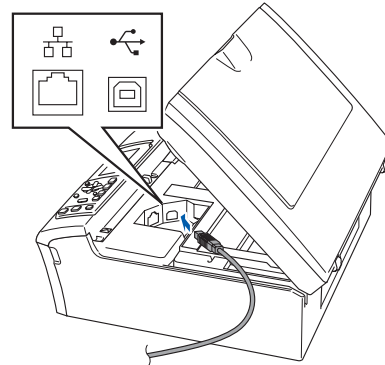

- 12** Carefully guide the USB cable into the trench as shown below, following the trench around and toward the back of the machine. Then, connect the cable to your computer.

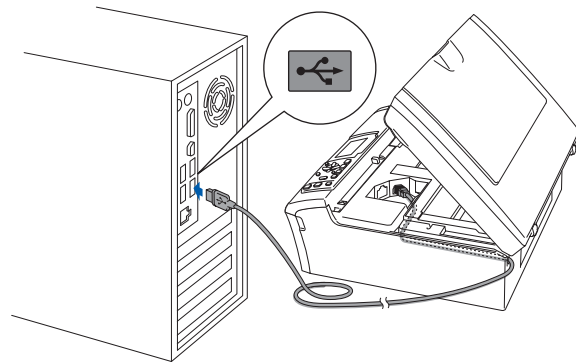

Improper Setup

- **DO NOT** connect the machine to a USB port on a keyboard or a non-powered USB hub. Brother recommends that you connect the machine directly to your computer.
- Make sure that the cable does not restrict the cover from closing, or an error may occur.
- Make sure you use a USB 2.0 cable that is no longer than 2 metres.

- 13** Lift the scanner cover to release the lock ①. Gently push the scanner cover support down ② and close the scanner cover ③.

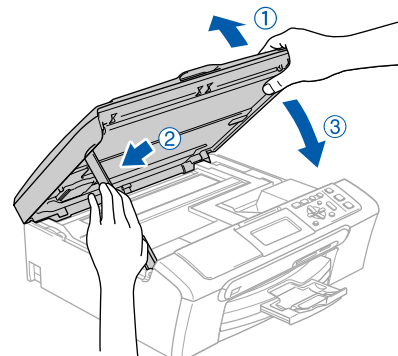

- 14** Turn on the machine by connecting the power cord.

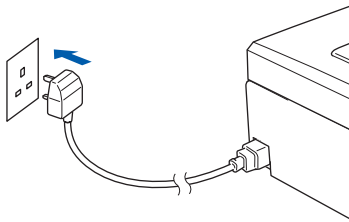

The installation of the Brother drivers will automatically start. The installation screens appear one after another. **Please wait, it will take a few seconds for all the screens to appear.**



The MFL-Pro Suite has been installed completely. Proceed to *Installing FaceFilter Studio* on page 17 to install the FaceFilter Studio application.



Note

MFL-Pro Suite includes the Printer Driver, Scanner Driver, Brother ControlCenter3, ScanSoft™ PaperPort™ 11SE. ScanSoft™ PaperPort™ 11SE is a document management application for scanning and viewing documents.

⊘ Improper Setup

DO NOT try to cancel any of the screens during this installation.

- 15** When the On-Line Registration screen is displayed, make your selection and follow the on-screen instructions.

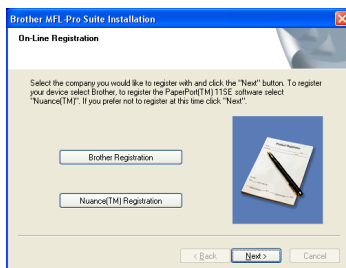

- 16** Click **Finish** to restart your computer. After restarting the computer, you must be logged on with Administrator rights.

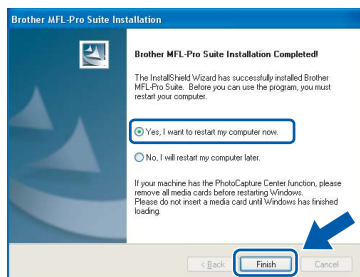

Note

After restarting the computer, the Installation Diagnostics will run automatically. If the installation is unsuccessful, the installation results window will be shown. If the Diagnostics shows a failure, please follow the on-screen instructions or read the on-line help and FAQs in **Start/All Programs/Brother/DCP-XXXX**.

Installing FaceFilter Studio

FaceFilter Studio is an easy-to-use borderless photo printing application. FaceFilter Studio also lets you edit your photo data and add photo effects such as red eye reduction or skin tone enhancement.

Important

Before you launch FaceFilter Studio for the first time, you must confirm MFL-Pro Suite is installed, your Brother machine is turned ON and connected to your computer.

- 17** Open the main menu again by ejecting and then reinserting the CD-ROM disc or by double-clicking the **start.exe** program from the root folder.
- 18** The CD-ROM main menu will appear. Click **Install Other Drivers or Utilities**.



- 19** Click the **FaceFilter Studio** button to install.

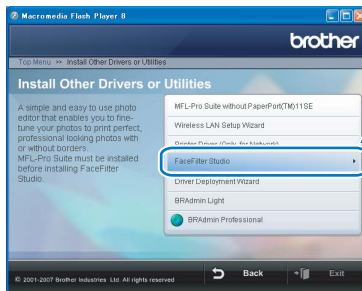

- 20** For information on basic FaceFilter Studio functions, see *Using FaceFilter Studio for photo printing by REALLUSION in the Software User's Guide on the CD-ROM*. For more detailed information, install FaceFilter Studio Help. See *Instructions on how to install FaceFilter Studio Help (For Windows® users)* on page 48.

For Wired Network Interface Users (For Windows® 2000 Professional/XP/ XP Professional x64 Edition/Windows Vista™)

Important

Make sure that you have finished the instructions from STEP 1 *Setting Up the Machine* on pages 5 through 11.

Note

- The supplied CD-ROM includes ScanSoft™ PaperPort™ 11SE. This software supports Windows® 2000 (SP4 or greater), XP (SP2 or greater), XP Professional x64 Edition and Windows Vista™ only. Please update to the latest Windows® Service Pack before installing MFL-Pro Suite.
- Please close any applications running before installing MFL-Pro Suite.
- Make sure there are no memory cards or a USB Flash memory drive inserted into the media drives or USB direct interface at the front of the machine.

- 1 Disconnect the machine from the power socket.
- 2 Using both hands, use the plastic tabs on both sides of the machine to lift the scanner cover until it locks securely into the open position.

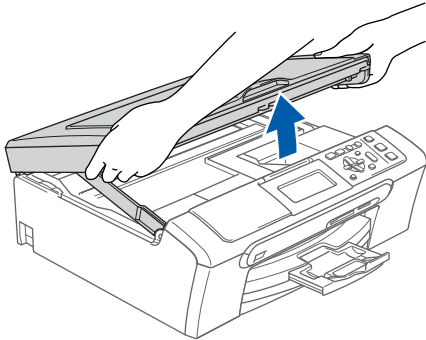

- 3 Connect the network cable to the LAN socket marked with a  symbol. You will find the LAN socket inside the machine on the left as shown below.

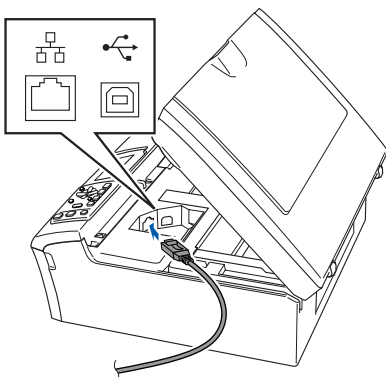

- 4 Carefully guide the network cable into the trench as shown below, following the trench around and toward the back of the machine. Then, connect the cable to your network.

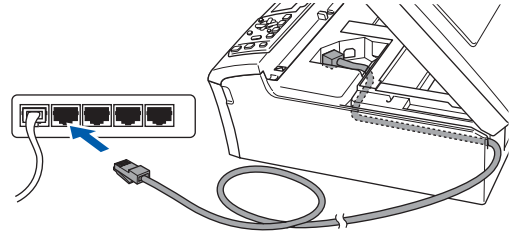

Improper Setup

Make sure that the cable does not restrict the cover from closing, or an error may occur.

Note

If both USB and LAN cables are being used, guide both cables through the trench with one on top of the other.

- 5 Lift the scanner cover to release the lock ①. Gently push the scanner cover support down ② and close the scanner cover ③.

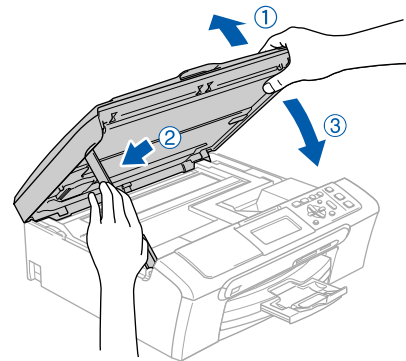

- 6 Turn on the machine by connecting the power cord.

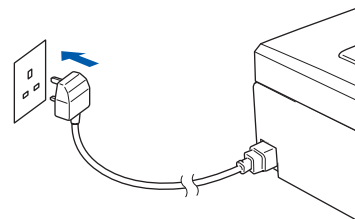

Improper Setup

If you have previously set up your machine for a wireless network and then want to set it up on a wired network, you should check that the machine's Network I/F is Wired LAN. The wireless network interface will become inactive with this setting.

On your machine, press Menu. Press ▲ or ▼ to choose LAN and press OK. Press ▲ or ▼ to choose Network I/F and press OK. Press ▲ or ▼ to choose Wired LAN and press OK. Press Stop/Exit.

7 Turn on your computer. You must be logged on with Administrator rights. Close any applications running before installing MFL-Pro Suite.

Note Before installation, if you are using Personal Firewall software, disable it. After the installation, restart your Personal Firewall software.

8 Put the supplied CD-ROM into your CD-ROM drive. If the model name screen appears, choose your machine. If the language screen appears, choose your language.

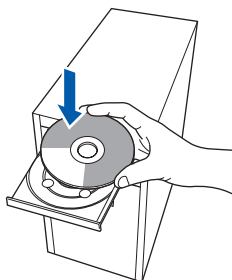

9 The CD-ROM main menu will appear. Click **Install MFL-Pro Suite**.

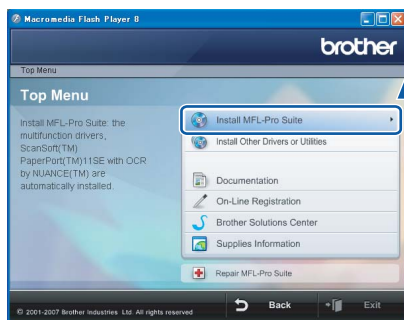

If this window does not appear, use Windows® Explorer to run the **start.exe** program from the root folder of the Brother CD-ROM.

Note If this screen appears, click **OK** and restart your computer.

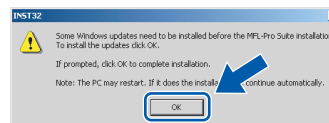

- If the installation does not continue automatically, open the main menu again by ejecting and then reinserting the CD-ROM disc or double-click the **start.exe** program from the root folder, and continue from step 9 to install MFL-Pro Suite.
- For Windows Vista™, when the User Account Control screen appears, click **Allow**.

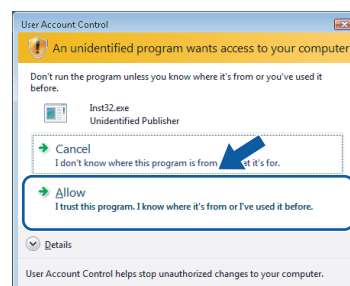

10 Choose **Wired Network Connection**, and then click **Next**.

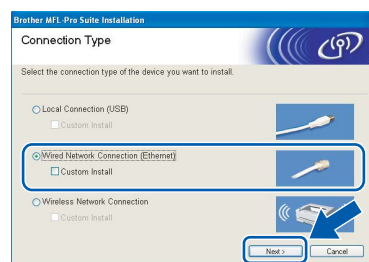

11 After reading and accepting the ScanSoft™ PaperPort™ 11SE License Agreement, click **Yes**.

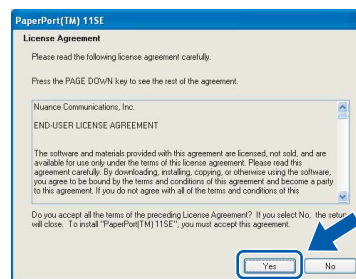

12 The installation of ScanSoft™ PaperPort™ 11SE will automatically start and is followed by the installation of MFL-Pro Suite.

- 13 When the Brother MFL-Pro Suite Software License Agreement window appears, click **Yes** if you agree to the Software License Agreement.

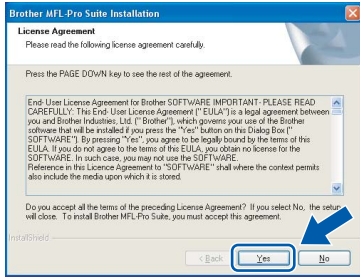

- 14 For Windows® XP SP2/Windows Vista™ users, when this screen appears, choose **Change the Firewall port settings to enable network connection and continue with the installation. (Recommended)** and click **Next**.

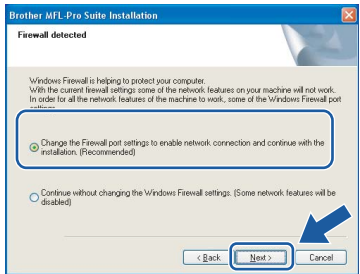

If you are not using the Windows® Firewall, see the User's Guide for your software for information on how to add the following network ports.

- For network scanning, add UDP port 54925.
- If you still have trouble with your network connection, add UDP port 137.

Note

- If the machine is configured for your network, choose the machine from the list, and then click **Next**.

This window will not appear if there is only one machine connected on the network, it will be chosen automatically.

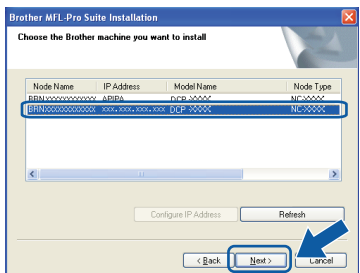

If your machine shows **APIPA** in the **IP Address** field, click **Configure IP Address** and enter an IP address for your machine that is suitable for your network.

- If the machine is not yet configured for use on your network, the following screen appears.



Click **OK**.

The **Configure IP Address** window will appear. Enter an IP address for your machine that is suitable for your network by following the on-screen instructions.

- 15 The installation of the Brother drivers will automatically start. The installation screens appear one after another. **Please wait, it will take a few seconds for all the screens to appear.**

Improper Setup

DO NOT try to cancel any of the screens during this installation.

Note

For Windows Vista™, when this screen appears, click the check box and click **Install** to complete the installation properly.

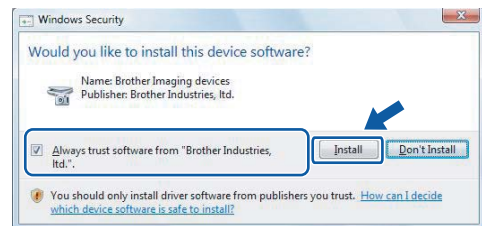

- 16 When the On-Line Registration screen is displayed, make your selection and follow the on-screen instructions.

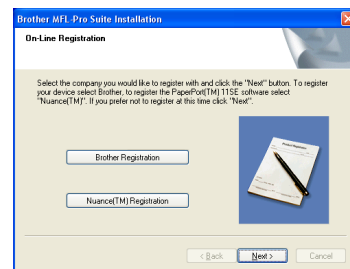

- 17** Click **Finish** to restart your computer. After restarting the computer, you must be logged on with Administrator rights.

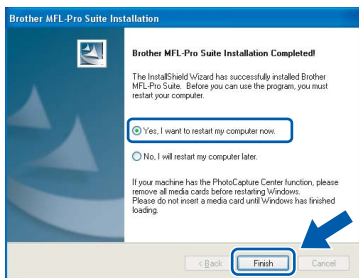

Note

After restarting the computer, the *Installation Diagnostics* will run automatically. If the installation is unsuccessful, the installation results window will be shown. If the Diagnostics shows a failure, please follow the on-screen instructions or read the on-line help and FAQs in **Start/All Programs/Brother/DCP-XXXX**.



The MFL-Pro Suite has been installed completely. Proceed to Installing FaceFilter Studio on page 21 to install the FaceFilter Studio application.



Note

MFL-Pro Suite includes the *Network Printer Driver, Network Scanner Driver, Brother ControlCenter3, ScanSoft™ PaperPort™ 11SE. ScanSoft™ PaperPort™ 11SE is a document management application for scanning and viewing documents.*

Installing FaceFilter Studio

FaceFilter Studio is an easy-to-use borderless photo printing application. FaceFilter Studio also lets you edit your photo data and add photo effects such as red eye reduction or skin tone enhancement.

Important

Before you launch FaceFilter Studio for the first time, you must confirm MFL-Pro Suite is installed, your Brother machine is turned ON and connected to your network.

- 18** Open the main menu again by ejecting and then reinserting the CD-ROM disc or by double-clicking the **start.exe** program from the root folder.
- 19** The CD-ROM main menu will appear. Click **Install Other Drivers or Utilities**.

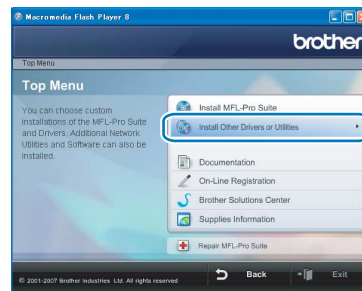

- 20** Click the **FaceFilter Studio** button to install.

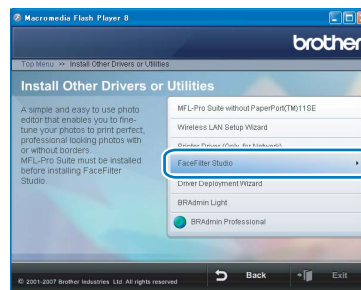

- 21** For information on basic FaceFilter Studio functions, see *Using FaceFilter Studio for photo printing by REALLUSION in the Software User's Guide on the CD-ROM*. For more detailed information, install FaceFilter Studio Help. See *Instructions on how to install FaceFilter Studio Help (For Windows® users)* on page 48.



For Wireless Network Interface Users (For Windows® 2000 Professional/XP/XP Professional x64 Edition/Windows Vista™) in infrastructure mode

Connecting your wireless machine and wireless network together and installing the printer driver in infrastructure mode

First you must configure the wireless network settings of your machine to communicate with your network access point (router). After the machine is configured to communicate with your access point (router) computers on your network will have access to the machine. To use the machine from these computers, you will need to install the MFL-Pro Suite. The following steps will guide you through the configuration and installation process.

To achieve optimum results with normal every day document printing, place the Brother machine as close to the network access point (router) as possible with minimal obstructions. Large objects and walls between the two devices as well as interference from other electronic devices can affect the data transfer speed of your documents.

Important

The following instructions will offer two methods for installing your Brother machine in a wireless network environment. Both methods are for infrastructure mode, using a wireless router or access point that uses DHCP to assign IP addresses. If your wireless router/access point supports SecureEasySetup™ or AOSS™ follow the steps on page 24 *Using the SecureEasySetup™ or AOSS™ software to configure your machine for a wireless network*. If your wireless router/access point does not support SecureEasySetup™ or AOSS™ follow the steps on page 26 *Using the Setup Wizard from the control panel LAN menu for wireless network configuration*. To set up your machine in any other wireless environment you can find instructions in the Network User's Guide on the CD-ROM.

You can view the Network User's Guide by following the instructions below.

- 1 Turn on your computer. Insert the Brother CD-ROM into your CD-ROM drive.
- 2 If the model name screen appears, click your model name.
- 3 If the language screen appears, click your language. The CD-ROM main menu will appear.
- 4 Click **Documentation**.
- 5 Click **HTML documents**.
- 6 Click **NETWORK USER'S GUIDE**.

Confirm your network environment

The setup process will be different depending on your network environment.

■ Installation using SecureEasySetup™ or AOSS™.

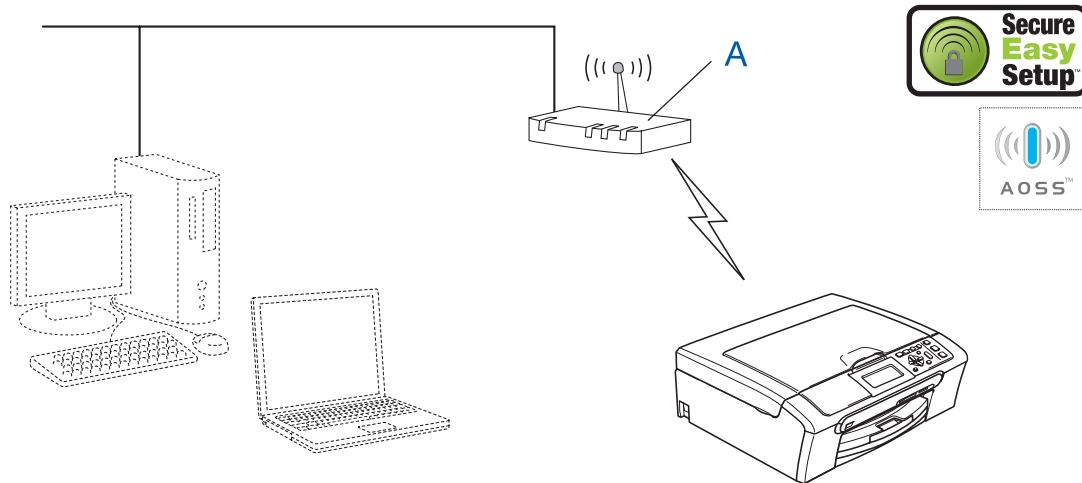

If your wireless access point (A) supports SecureEasySetup™ or AOSS™, you do not need to use a computer to configure the machine. The access point (router) and your machine can automatically negotiate using the SecureEasySetup™ or AOSS™ procedure. For instructions, go to page 24.

■ Infrastructure Mode

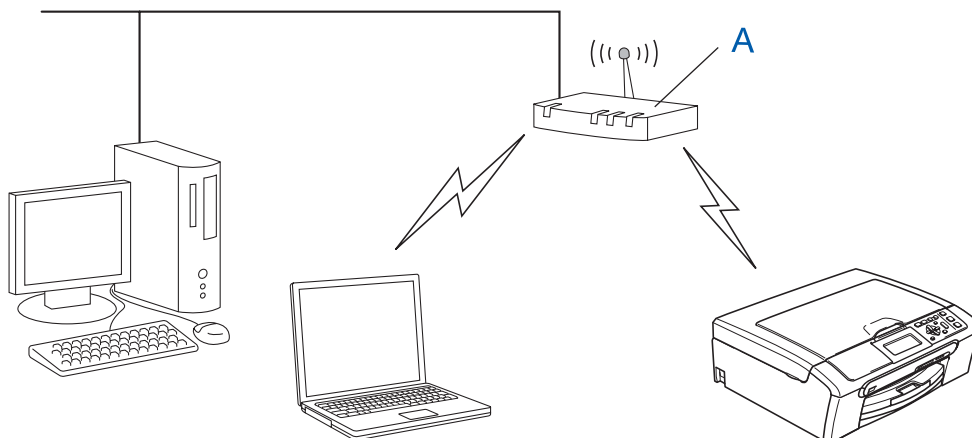

If your wireless access point (A) does not support SecureEasySetup™ or AOSS™, follow the instructions, on page 26.

Using the SecureEasySetup™ or AOSS™ software to configure your machine for a wireless network

Important

Make sure that you have finished the instructions from **STEP 1 Setting Up the Machine** on pages 5 through 11.

The SecureEasySetup™ or AOSS™ software allows you to configure the wireless network easier than configuring it manually. By pushing a button on the wireless router or access point, you can setup the wireless network and security settings. Your router or access point must also support SecureEasySetup™ or AOSS™. See the user's guide for your wireless LAN router or access point for instructions to configure your machine for a wireless network. If your wireless router or access point does not support SecureEasySetup™ or AOSS™ go to page 26 for installation instructions.

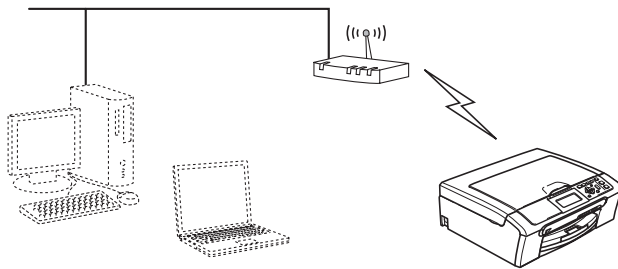

Note

Routers or access points that support SecureEasySetup™ have the SecureEasySetup™ symbol as shown below.



Note

Routers or access points that support AOSS™ have the AOSS™ symbol as shown below.



- 1 Turn on the machine by connecting the power cord.

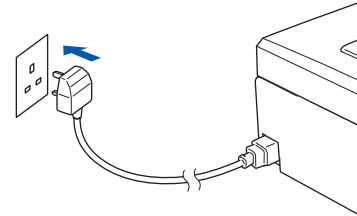

- 2 Place the Brother machine close to the SecureEasySetup™ or AOSS™ router or access point.

⊘ Improper Setup

If you have previously configured the wireless settings of the machine you must reset the network (LAN) settings before you can configure the wireless settings again.

On your machine, press **Menu**. Press **▲** or **▼** to choose **LAN** and then press **OK**.

Press **▲** or **▼** to choose **Factory Reset**, and then press **OK**.

Press **+** to choose **Yes**.

Press **+** to choose **Yes**.

- 3 Push the SecureEasySetup™ or AOSS™ button on your wireless router or access point. See the user's guide for your wireless router or access point for instructions.
- 4 On your machine, press **Menu**. Press **▲** or **▼** to choose **LAN** and press **OK**. Press **▲** or **▼** to choose **WLAN** and press **OK**. Press **▲** or **▼** to choose **SecureEasySetup** or **AOSS** and press **OK**. When **Network I/F switched to Wireless** is displayed, press **OK** to accept or press **Clear/Back** to cancel.

- 5** The wireless network connection status using the SecureEasySetup™ or AOSS™ software will be displayed: *Connecting WLAN*, *Setting AOSS* or *Connecting AOSS*.

Wait till either *Connected* or *Connection Error (Connection Fail)* is displayed.

Connected is displayed when the print server is successfully connected to your router or access point. You can now use your machine in a wireless network.

Connection Error (Connection Fail) is displayed when the print server has not successfully connected to your router or access point. Try starting from step **2** again. If the same message is displayed again, reset the print server back to the default factory settings and try again.

(See *Restoring the network settings to factory default* on page 47.)



Note

If you encounter a problem during setup, temporarily place your machine closer to the wireless access point, and go back to step 3.



Wireless setup is now complete. To install MFL-Pro suite, continue to step 12 on page 28.

Using the Setup Wizard from the control panel LAN menu for wireless network configuration

Important

Make sure that you have finished the instructions from **STEP 1 Setting Up the Machine** on pages 5 through 11.



- 1 Write down the wireless network settings of your access point or wireless router.
SSID (Service Set ID or Network name)

WEP Key (if needed)

WPA/WPA2-PSK (TKIP or AES) (if needed)

The WEP key is for 64-bit encrypted networks or 128-bit encrypted networks and can contain both numbers and letters. If you do not know this information you should see the documentation provided with your access point or wireless router. This key is a 64-bit or 128-bit value that must be entered in an ASCII or HEXADECIMAL format.

For example:

64-bit ASCII: Uses 5 text characters.
e.g. "Hello" (this is case sensitive)

64-bit Hexadecimal: Uses 10 digits of hexadecimal data.
e.g. "71f2234aba"

128-bit ASCII: Uses 13 text characters.
e.g. "Wirelesscomms" (this is case sensitive)

128-bit Hexadecimal: Uses 26 digits of hexadecimal data.
e.g.
"71f2234ab56cd709e5412aa3ba"

WPA/WPA2-PSK is a Wi-Fi® Protected Access Pre-shared key, which lets the Brother wireless machine associate with access points using TKIP or AES encryption (WPA-Personal). WPA/WPA2-PSK (TKIP or AES) uses a Pre-Shared Key (PSK) that is 8 or more characters in length, up to a maximum of 63 characters. See the *Network User's Guide* for more details.

- 2 Turn on the machine by connecting the power cord.

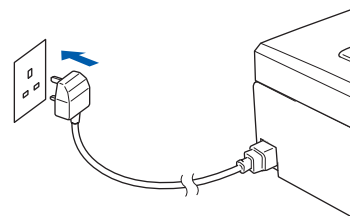

⊘ Improper Setup

If you have previously configured the wireless settings of the machine you must reset the network (LAN) settings before you can configure the wireless settings again.

On your machine, press **Menu**.

Press **▲** or **▼** for **LAN** and press **OK**.

Press **▲** or **▼** to choose **Factory Reset**, and then press **OK**.

Press **+** to choose **Yes**.

Press **+** to choose **Yes**.

- 3 On your machine, press **Menu**.
Press **▲** or **▼** to choose **LAN** and press **OK**.
Press **▲** or **▼** to choose **WLAN** and press **OK**.
Press **▲** or **▼** to choose **Setup Wizard** and press **OK**.
When **Network I/F switched to Wireless** is displayed, press **OK** to accept. This will start the wireless setup wizard.
Press **Clear/Back** to cancel.

- 4 The machine will search for available SSIDs. If a list of SSIDs is displayed, use the **▲** or **▼** keys to choose the SSID you wrote down in step 1, then press **OK**. Go to step 8.



Note

It will take several seconds to display a list of available SSIDs.

If your access point is set to not broadcast the SSID you will have to manually add the SSID name. Go to step 5.

- 5 Press **▲** or **▼** to choose **<New SSID>** and press **OK**.

- 6** Enter the SSID you wrote down in step **1** using ▲, ▼ keys to choose each letter or number. You can use the ◀ and ▶ keys to move the cursor left and right. For example, to enter the letter a, press the ▲ key once. To enter the number 3, hold down the ▲ key until it appears.

The letters appear in this order: lower case, upper case, numbers and then special letters. (For more information, see *Entering Text* on page 47.)

Press **OK** when you have entered all the characters.

- 7** Press ▲ or ▼ to choose *Infrastructure*, then press **OK**.

- 8** Use the ▲, ▼ and **OK** keys to choose one of the options below: If your network is configured for Authentication and Encryption you must match the settings used for your network.

No Authentication or Encryption: Choose *Open System*, press **OK** then choose *None* for *Encryption Type?* and press **OK**. Then press  to choose *Yes* to apply your settings. Go to step **11**.

No Authentication with WEP Encryption: Choose *Open System*, press **OK** then use the ▲ or ▼ to choose *WEP* for the *Encryption Type?* and press **OK**. Go to step **9**.

Authentication with WEP Encryption: Choose *Shared Key*, press **OK**. Go to step **9**.

Authentication with WPA/WPA2-PSK (TKIP or AES) Encryption: Choose *WPA/WPA2-PSK*, press **OK**. Go to step **10**.

- 9** Press ▲ or ▼ to choose the appropriate key number and press **OK**. Enter the WEP key you wrote down in step **1** using ▲, ▼ keys to choose each letter or number. You can use the ◀ and ▶ keys to move the cursor left and right. For example, to enter the letter a, press the ▲ key once. To enter the number 3, hold down the ▲ key until it appears.

The letters appear in this order: lower case, upper case, numbers and then special letters. (For more information, see *Entering Text* on page 47.)

Press **OK** when you have entered all the characters, then press  *Yes* to apply your settings. Go to step **11**.

Most access points and routers can store more than one key, but they will only use one at any time for authentication and encryption.

- 10** Press ▲ or ▼ to choose *TKIP* or *AES* for *Encryption Type?* and press **OK**. Enter the WPA/WPA2-PSK password you wrote down in step **1** using ▲, ▼ keys to choose each letter or number. You can use the ◀ and ▶ keys to move the cursor left and right. For example, to enter the letter a, press the ▲ key once. To enter the number 3, hold down the ▲ key until it appears.

The letters appear in this order: lower case, upper case, numbers and then special letters. (For more information, see *Entering Text* on page 47.)

Press **OK** when you have entered all the characters, then press  *Yes* to apply your settings. Go to step **11**.

- 11** Your machine will now try to connect to your wireless network using the information you have entered. If successful, *Connected* will appear briefly on the LCD.

*If your machine does not successfully connect to your network, you should repeat steps **3** to **10** to make sure you have entered the correct information.*

*If your access point does not have DHCP enabled you will need to manually configure the IP address, subnet mask and gateway of the machine to suit your network. See the *Network User's Guide* for details.*



Wireless setup is now complete. A four level indicator on the bottom of your machine's LCD will show the wireless signal strength of your access point or router. To install MFL-Pro Suite, continue to step **12.**

Note

- The supplied CD-ROM includes ScanSoft™ PaperPort™ 11SE. This software supports Windows® 2000 (SP4 or greater), XP (SP2 or greater), XP Professional x64 Edition and Windows Vista™ only. Please update to the latest Windows® Service Pack before installing MFL-Pro Suite.
- Please close any applications running before installing MFL-Pro Suite.
- Make sure there are no memory cards or a USB Flash memory drive inserted into the media drives or USB direct interface at the front of the machine.

12 Turn on your computer. You must be logged on with Administrator rights. Close any applications running before installing MFL-Pro Suite.

Note

Before installation, if you are using Personal Firewall software, disable it. After the installation, restart your Personal Firewall software.

13 Put the supplied CD-ROM into your CD-ROM drive. If the model name screen appears, choose your machine. If the language screen appears, choose your language.

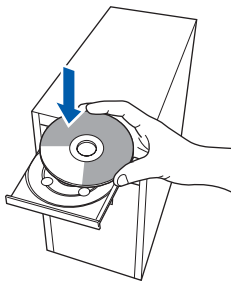

14 The CD-ROM main menu will appear. Click **Install MFL-Pro Suite**.



If this window does not appear, use Windows® Explorer to run the **start.exe** program from the root folder of the Brother CD-ROM.

Note

- If this screen appears, click **OK** and restart your computer.

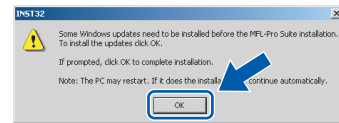

If the installation does not continue automatically, open the main menu again by ejecting and then reinserting the CD-ROM disc or double-click the **start.exe** program from the root folder, and continue from step **14** to install MFL-Pro Suite.

- For Windows Vista™, when the User Account Control screen appears, click **Allow**.

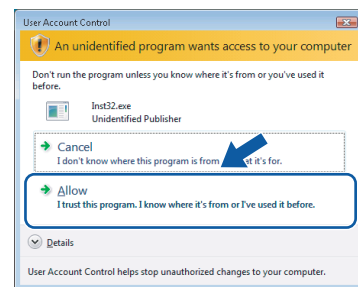

15 Choose **Wireless Network Connection**, and then click **Next**.

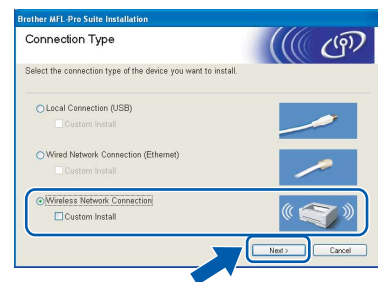

16 Click on **Checked and confirmed** check box, and then click **Next**.

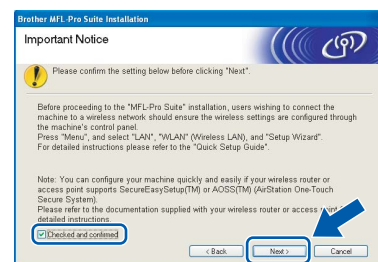

- 17** After reading and accepting the ScanSoft™ PaperPort™ 11SE License Agreement, click **Yes**.

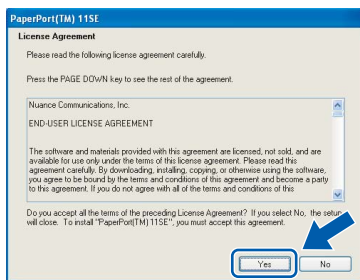

- 18** The installation of ScanSoft™ PaperPort™ 11SE will automatically start and is followed by the installation of MFL-Pro Suite.

- 19** When the Brother MFL-Pro Suite Software License Agreement window appears, click **Yes** if you agree to the Software License Agreement.

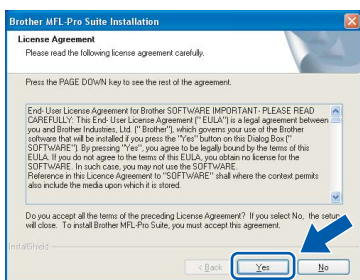

- 20** For Windows® XP SP2/Windows Vista™ users, when this screen appears, choose **Change the Firewall port settings to enable network connection and continue with the installation. (Recommended)** and click **Next**.

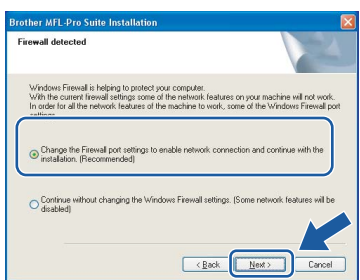

If you are not using the Windows® Firewall, see the User's Guide for your software for information on how to add the following network ports.

- For network scanning, add UDP port 54925.
- If you still have trouble with your network connection, add UDP port 137.

Note

- If the machine is configured for your network, choose the machine from the list, and then click **Next**.

This window will not appear if there is only one machine connected on the network, it will be chosen automatically.

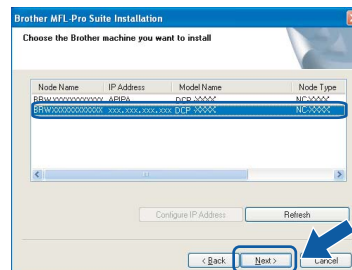

If your machine shows **APIPA** in the **IP Address** field, click **Configure IP Address** and enter an IP address for your machine that is suitable for your network.

- If the machine is not yet configured for use on your network, the following screen appears.

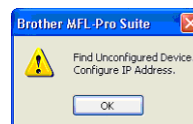

Click **OK**.

The **Configure IP Address** window will appear. Enter an IP address for your machine that is suitable for your network by following the on-screen instructions.

Windows®
Wireless
Network

Improper Setup

If your wireless settings fail, an error message will appear during the installation of MFL-Pro Suite and the installation will be terminated. If you encounter this failure, please go to step 1 and setup the wireless connection again.

- 21** The installation of the Brother drivers will automatically start. The installation screens appear one after another. **Please wait, it will take a few seconds for all the screens to appear.**

Improper Setup

DO NOT try to cancel any of the screens during this installation.

Note

For Windows Vista™, when this screen appears, click the check box and click **Install** to complete the installation properly.

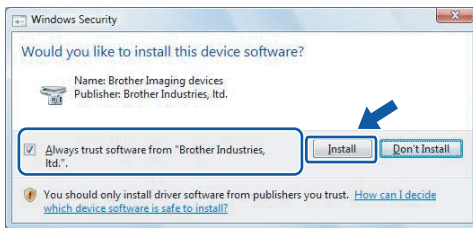

- 22** When the On-Line Registration screen is displayed, make your selection and follow the on-screen instructions.

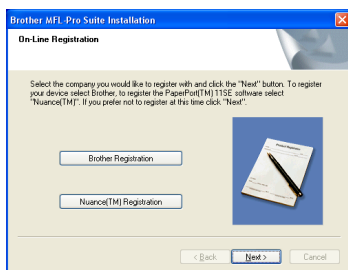

- 23** Click **Finish** to restart your computer. After restarting the computer, you must be logged on with Administrator rights.

**Note**

After restarting the computer, the Installation Diagnostics will run automatically. If the installation is unsuccessful, the installation results window will be shown. If the Diagnostics shows a failure, please follow the on-screen instructions or read the on-line help and FAQs in **Start/All Programs/Brother/DCP-XXXX**.



The MFL-Pro Suite has been installed completely. Proceed to *Installing FaceFilter Studio* on page 30 to install the FaceFilter Studio application.

Note

MFL-Pro Suite includes the Network Printer Driver, Network Scanner Driver, Brother ControlCenter3, ScanSoft™ PaperPort™ 11SE. ScanSoft™ PaperPort™ 11SE is a document management application for scanning and viewing documents.

Installing FaceFilter Studio

FaceFilter Studio is an easy-to-use borderless photo printing application. FaceFilter Studio also lets you edit your photo data and add photo effects such as red eye reduction or skin tone enhancement.

Important

Before you launch FaceFilter Studio for the first time, you must confirm MFL-Pro Suite is installed, your Brother machine is turned ON and connected to your network.

- 25** Open the main menu again by ejecting and then reinserting the CD-ROM disc or by double-clicking the **start.exe** program from the root folder.

- 26** The CD-ROM main menu will appear. Click **Install Other Drivers or Utilities**.

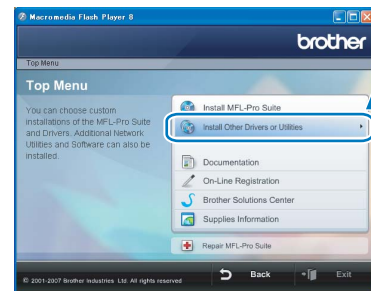

- 27** Click the **FaceFilter Studio** button to install.

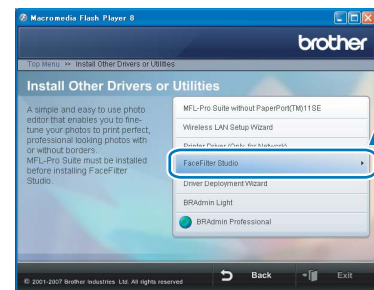

- 28** For information on basic FaceFilter Studio functions, see *Using FaceFilter Studio for photo printing by REALLUSION in the Software User's Guide on the CD-ROM*. For more detailed information, install FaceFilter Studio Help. See *Instructions on how to install FaceFilter Studio Help (For Windows® users)* on page 48.

For USB Interface Users (For Mac OS® X 10.2.4 or greater)

Important

Make sure that you have finished the instructions from **STEP 1 Setting Up the Machine** on pages 5 through 11.

Note

- For Mac OS® X 10.2.0 to 10.2.3 users, upgrade to Mac OS® X 10.2.4 or greater. (For the latest information for Mac OS® X, visit <http://solutions.brother.com>)
- Make sure there are no memory cards or a USB Flash memory drive inserted into the media drives or USB direct interface at the front of the machine.

- Using both hands, use the plastic tabs on both sides of the machine to lift the scanner cover until it locks securely into the open position.

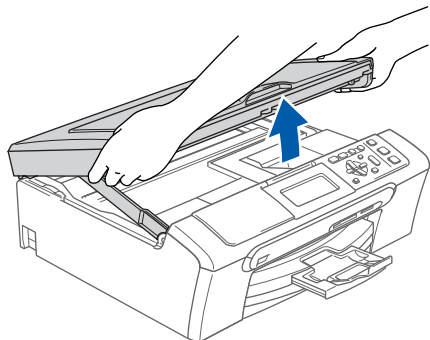

- Connect the USB cable to the USB socket marked with a  symbol. You will find the USB socket inside the machine on the right as shown below.

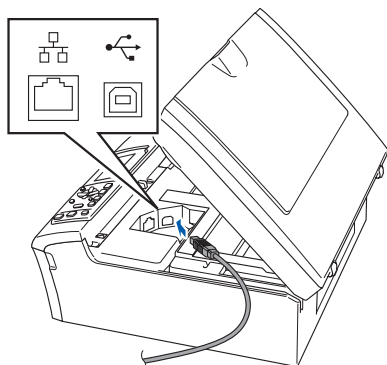

- Carefully guide the USB cable into the trench as shown below, following the trench around and toward the back of the machine. Then, connect the cable to your Macintosh®.

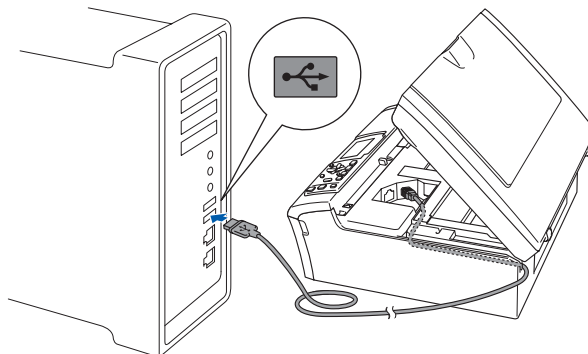

Improper Setup

- **DO NOT** connect the machine to a USB port on a keyboard or a non-powered USB hub. Brother recommends that you connect the machine directly to your Macintosh®.
- Make sure that the cable does not restrict the cover from closing, or an error may occur.
- Make sure you use a USB 2.0 cable that is no longer than 2 metres.

- Lift the scanner cover to release the lock ①. Gently push the scanner cover support down ② and close the scanner cover ③.

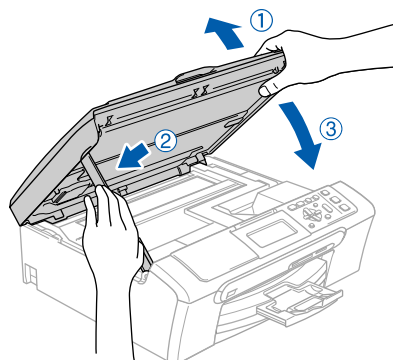

Note

Make sure that the machine is turned on by connecting the power cord.

- Turn on your Macintosh®.

- 6** Put the supplied CD-ROM into your CD-ROM drive.

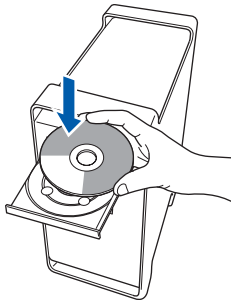

- 7** Double-click the **Start Here OSX** icon to install.

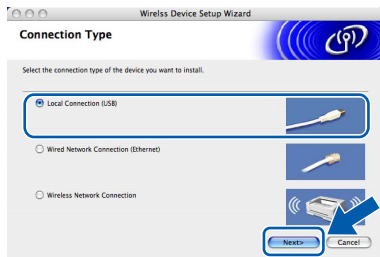

- 8** Choose **Local Connection**, and then click **Next**. Follow the on-screen instruction.

**Note**

Please wait, it will take a few seconds for the software to install. After the installation, click **Restart** to finish installing the software.

- 9** The Brother software will search for the Brother device. During this time the following screen will appear.

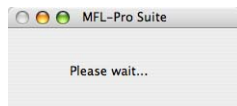

- 10** When this screen appears, click **OK**.

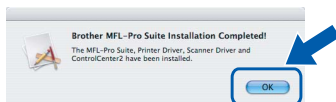

For Mac OS® X 10.3.x or greater users: The MFL-Pro Suite, Brother printer driver, scanner driver and Brother ControlCenter2 have been installed and the installation is now complete. Go to step **15**.

- 11** For Mac OS® X 10.2.4 to 10.2.8 users: Click **Add**.

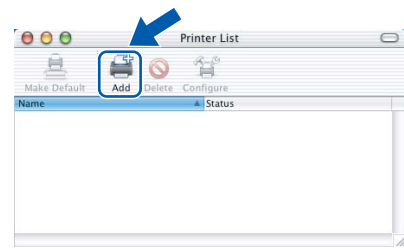

- 12** Choose **USB**.

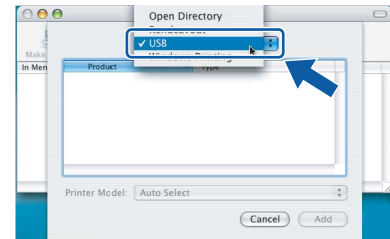

- 13** Choose **DCP-XXXX** (where XXXX is your model name), and then click **Add**.

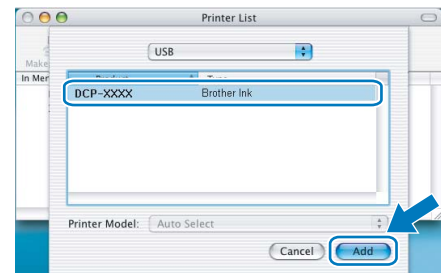

- 14** Click **Print Center**, then **Quit Print Center**.

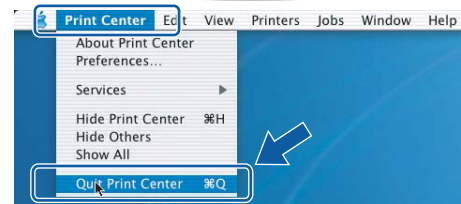
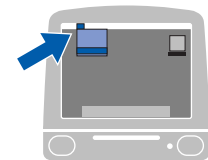

The MFL-Pro Suite, Brother printer driver, scanner driver and Brother ControlCenter2 have been installed and the installation is now complete.

- 15** To install Presto!® PageManager®, double-click the **Presto! PageManager** icon and follow the on-screen instructions.

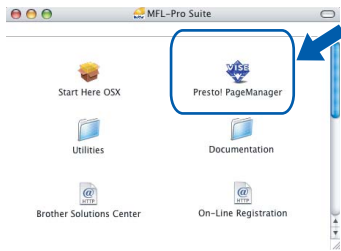

For Mac OS® X 10.2.4 to 10.3.8 users:
When this screen appears, click **Go** to download the software from the Brother Solutions Center web site.



 **Note**

When Presto!® PageManager® is installed OCR capability is added to Brother ControlCenter2. You can easily scan, share and organize photos and documents using Presto!® PageManager®.



Presto!® PageManager® has been installed and the installation is now complete.

For Wired Network Interface Users (For Mac OS® X 10.2.4 or greater)

Important

Make sure that you have finished the instructions from **STEP 1 Setting Up the Machine** on pages 5 through 11.

Note

- For Mac OS® X 10.2.0 to 10.2.3 users, upgrade to Mac OS® X 10.2.4 or greater. (For the latest information for Mac OS® X, visit <http://solutions.brother.com>)
- Make sure there are no memory cards or a USB Flash memory drive inserted into the media drives or USB direct interface at the front of the machine.

- Using both hands, use the plastic tabs on both sides of the machine to lift the scanner cover until it locks securely into the open position.

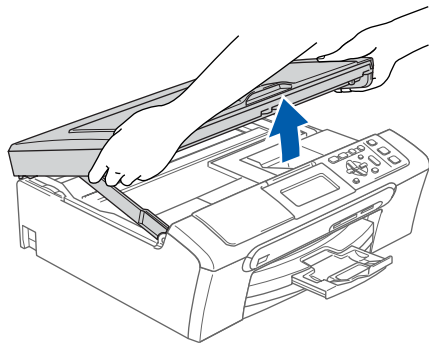

- Connect the network cable to the LAN socket marked with a  symbol. You will find the LAN socket inside the machine on the left as shown below.

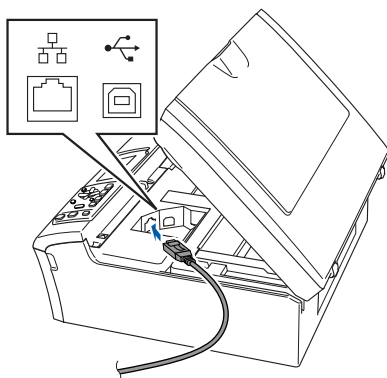

- Carefully guide the network cable to the trench as shown below, following the trench around and toward the back of the machine. Then, connect the cable to your network.

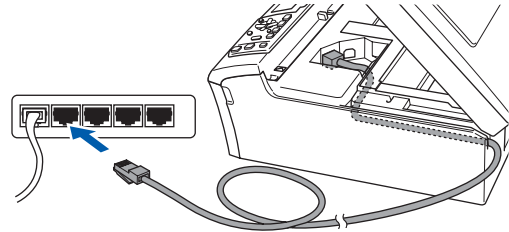

Improper Setup

Make sure that the cable does not restrict the cover from closing, or an error may occur.

Note

If both USB and LAN cables are being used, guide both cables through the trench with one on top of the other.

- Lift the scanner cover to release the lock ①. Gently push the scanner cover support down ② and close the scanner cover ③.

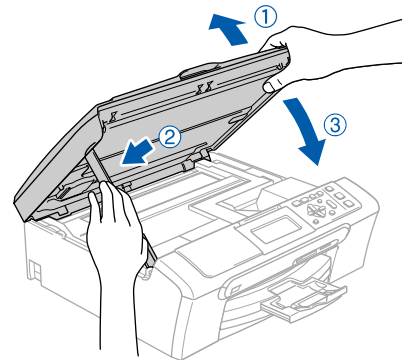

Note

Make sure that the machine is turned on by connecting the power cord.

⊘ Improper Setup

If you have previously set up your machine for a wireless network and then want to set it up on a wired network, you should check that the machine's Network I/F is Wired LAN. The wireless network interface will become inactive with this setting.

On your machine, press Menu.
 Press ▲ or ▼ to choose LAN and press OK.
 Press ▲ or ▼ to choose Network I/F and press OK.
 Press ▲ or ▼ to choose Wired LAN and press OK.
 Press Stop/Exit.

5 Turn on your Macintosh®.

6 Put the supplied CD-ROM into your CD-ROM drive.

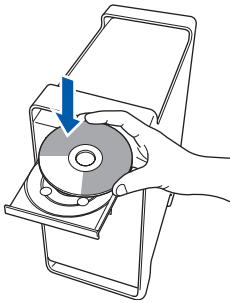

7 Double-click the **Start Here OSX** icon to install.



8 Choose **Wired Network Connection**, and then click **Next**. Follow the on-screen instructions.

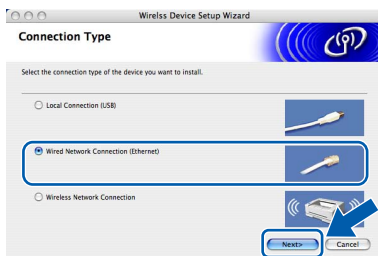

Please wait, it will take a few seconds for the software to install. After the installation, click **Restart** to finish installing the software.

9 The Brother software will search for the Brother device. During this time the following screen will appear.

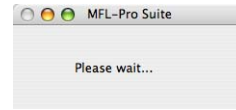

📝 Note

- If the machine is configured for your network, choose the machine from the list, and then click **OK**. This window will not appear if there is only one machine connected on the network, it will be chosen automatically. Go to step **10**.

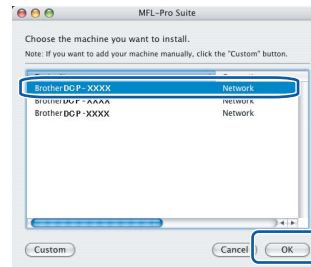

- If this screen appears click **OK**.



Enter a name for your Macintosh® in **Display Name** up to 15 characters long and click **OK**. Go to step **10**.

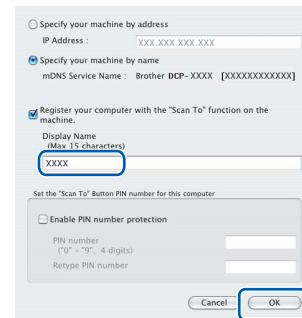

- If you want to use the machine's Scan key to scan over the network you must check the **Register your computer with the "Scan To" function on the machine** box.
- The name you enter will appear on the machine's LCD when you press the **Scan** key and choose a scan option. (For more information, see *Network Scanning in the Software User's Guide on the CD-ROM.*)

- 10** When this screen appears, click **OK**.

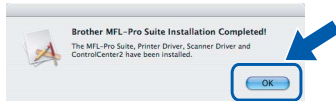

- OK!** For Mac OS® X 10.3.x or greater users: The MFL-Pro Suite, Brother printer driver, scanner driver and Brother ControlCenter2 have been installed and the installation is now complete. Go to step 15.

- 11** For Mac OS® X 10.2.4 to 10.2.8 users: Click **Add**.

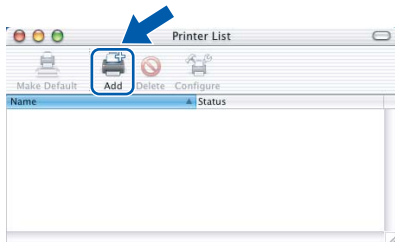

- 12** Make the selection shown below.

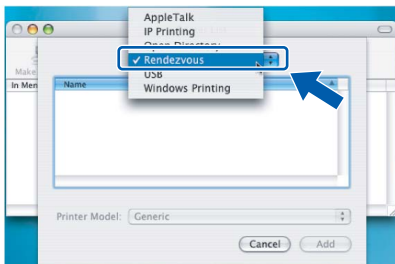

- 13** Choose **DCP-XXXX** (where XXXX is your model name), and then click **Add**.

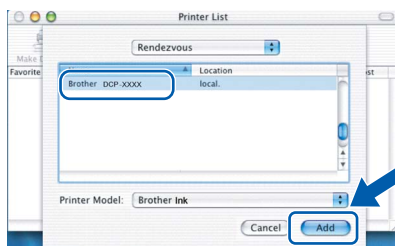

- 14** Click **Print Center**, then **Quit Print Center**.

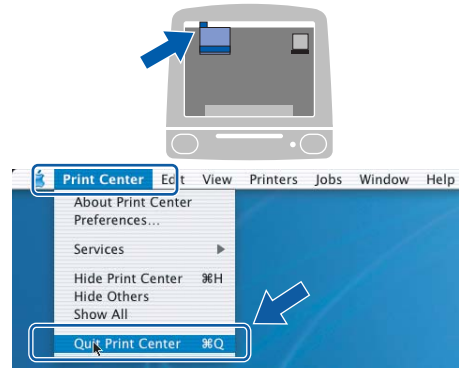

- OK!** The MFL-Pro Suite, Brother printer driver, scanner driver and Brother ControlCenter2 have been installed and the installation is now complete.

- 15** To install Presto!® PageManager®, double-click the **Presto! PageManager** icon and follow the on-screen instructions.



For Mac OS® X 10.2.4 to 10.3.8 users: When this screen appears, click **Go** to download the software from the Brother Solutions Center web site.



Note

When Presto!® PageManager® is installed OCR capability is added to Brother ControlCenter2. You can easily scan, share and organize photos and documents using Presto!® PageManager®.

- OK!** Presto!® PageManager® has been installed and the installation is now complete.

For Wireless Network Interface Users (For Mac OS® X 10.2.4 or greater) in infrastructure mode

Connecting your wireless machine and wireless network together and installing the printer driver in infrastructure mode

First you must configure the wireless network settings of your machine to communicate with your network access point (router). After the machine is configured to communicate with your access point (router) computers on your network will have access to the machine. To use the machine from these computers, you will need to install the MFL-Pro Suite. The following steps will guide you through the configuration and installation process.

To achieve optimum results with normal every day document printing, place the Brother machine as close to the network access point (router) as possible with minimal obstructions. Large objects and walls between the two devices as well as interference from other electronic devices can affect the data transfer speed of your documents.

Important

The following instructions will offer two methods for installing your Brother machine in a wireless network environment. Both methods are for infrastructure mode, using a wireless router or access point that uses DHCP to assign IP addresses. If your wireless router/access point supports SecureEasySetup™ or AOSS™ follow the steps on page 39 *Using the SecureEasySetup™ or AOSS™ software to configure your machine for a wireless network*. If your wireless router/access point does not support SecureEasySetup™ or AOSS™ follow the steps on page 41 *Using the Setup Wizard from the control panel LAN menu for wireless network configuration*. To set up your machine in any other wireless environment you can find instructions in the Network User's Guide on the CD-ROM.

You can view the Network User's Guide by following the instructions below.

- 1 Turn on your Macintosh®. Insert the Brother CD-ROM into your CD-ROM drive.
- 2 Double-click **Documentation**.
- 3 Double-click your language folder.
- 4 Double-click the top page file in HTML format.
- 5 Click **NETWORK USER'S GUIDE**.

Confirm your network environment

The setup process will be different depending on your network environment.

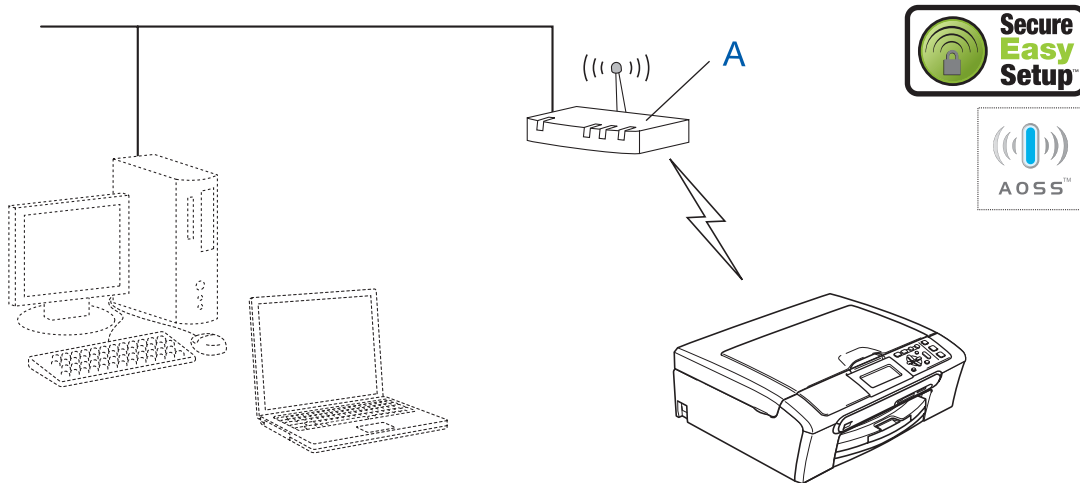
■ Installation using SecureEasySetup™ or AOSS™.

If your wireless access point (A) supports SecureEasySetup™ or AOSS™, you do not need to use a computer to configure the machine. The access point (router) and your machine can automatically negotiate using the SecureEasySetup™ or AOSS™ procedure. For instructions, go to page 39.

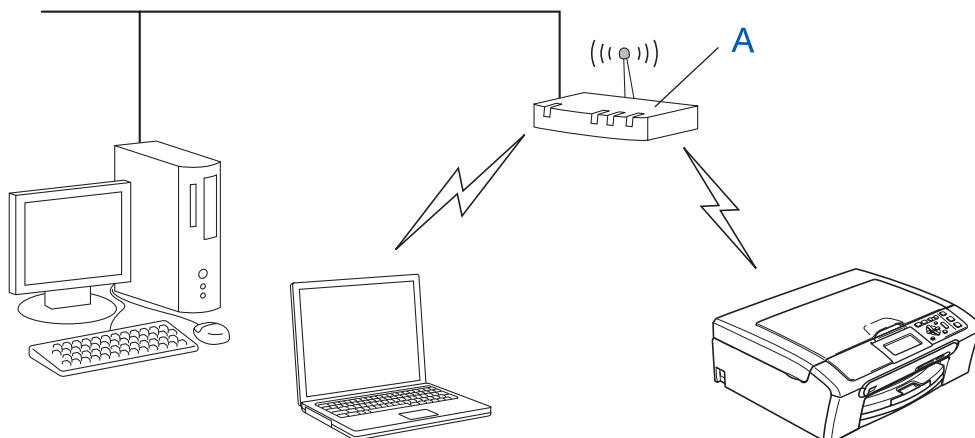
■ Infrastructure Mode

If your wireless access point (A) does not support SecureEasySetup™ or AOSS™, follow the instructions, on page 41.

Using the SecureEasySetup™ or AOSS™ software to configure your machine for a wireless network

Important

Make sure that you have finished the instructions from **STEP 1 Setting Up the Machine** on page 5 through 11.

The SecureEasySetup™ or AOSS™ software allows you to configure the wireless network easier than configuring it manually. By pushing a button on the wireless router or access point, you can complete setup and secure the wireless network. Your router or access point must also support SecureEasySetup™ or AOSS™. See the user's guide for your wireless LAN router or access point for instructions to configure your machine for a wireless network. If your wireless router or access point does not support SecureEasySetup™ or AOSS™ go to page 41 for installation instructions.

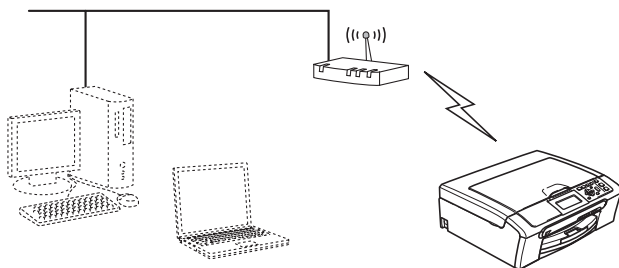

Note

Routers or access points that support SecureEasySetup™ have the SecureEasySetup™ symbol as shown below.



Note

Routers or access points that support AOSS™ have the AOSS™ symbol as shown below.



Note

Make sure that the machine is turned on by connecting the power cord.

- 1 Place the Brother machine close to the SecureEasySetup™ or AOSS™ router or access point.

Improper Setup

If you have previously configured the wireless settings of the machine you must reset the network (LAN) settings before you can configure the wireless settings again.

On your machine, press **Menu**. Press **▲** or **▼** to choose **LAN** and then press **OK**.

Press **▲** or **▼** to choose **Factory Reset**, and then press **OK**.

Press **+** to choose **Yes**.

Press **+** to choose **Yes**.

- 2 Push the SecureEasySetup™ or AOSS™ button on your wireless router or access point. See the user's guide for your wireless router or access point for instructions.
- 3 On your machine, press **Menu**. Press **▲** or **▼** to choose **LAN** and press **OK**. Press **▲** or **▼** to choose **WLAN** and press **OK**. Press **▲** or **▼** to choose **SecureEasySetup** or **AOSS** and press **OK**. When **Network I/F switched to Wireless** is displayed, press **OK** to accept or press **Clear/Back** to cancel.

- 4** The wireless network connection status using the SecureEasySetup™ or AOSS™ software will be displayed: Connecting WLAN, Setting AOSS or Connecting AOSS.

Wait till either Connected or Connection Error (Connection Fail) is displayed.

Connected is displayed when the print server is successfully connected to your router or access point. You can now use your machine in a wireless network.

Connection Error (Connection Fail) is displayed when the print server has not successfully connected to your router or access point. Try starting from step **1** again. If the same message is displayed again, reset the print server back to the default factory settings and try again.

(See *Restoring the network settings to factory default* on page 47.)



Note

*If you encounter a problem during setup, temporarily place your machine closer to the wireless access point, and go back to step **2**.*



Wireless setup is now complete. To install MFL-Pro suite, continue to step **11 on page 43.**

Using the Setup Wizard from the control panel LAN menu for wireless network configuration

Important

Make sure that you have finished the instructions from **STEP 1 Setting Up the Machine** on pages 5 through 11.



- 1 Write down the wireless network settings of your access point or wireless router.
SSID (Service Set ID or Network name)

WEP Key (if needed)

WPA/WPA2-PSK (TKIP or AES) (if needed)

The WEP key is for 64-bit encrypted networks or 128-bit encrypted networks and can contain both numbers and letters. If you do not know this information you should see the documentation provided with your access point or wireless router. This key is a 64-bit or 128-bit value that must be entered in an ASCII or HEXADECIMAL format.

For example:

64-bit ASCII:	Uses 5 text characters. e.g. "Hello" (this is case sensitive)
64-bit Hexadecimal:	Uses 10 digits of hexadecimal data. e.g. "71f2234aba"
128-bit ASCII:	Uses 13 text characters. e.g. "Wirelesscomms" (this is case sensitive)
128-bit Hexadecimal:	Uses 26 digits of hexadecimal data. e.g. "71f2234ab56cd709e5412aa3ba"

WPA/WPA2-PSK is a Wi-Fi® Protected Access Pre-shared key, which lets the Brother wireless machine associate with access points using TKIP or AES encryption (WPA-Personal). WPA/WPA2-PSK (TKIP or AES) uses a Pre-Shared Key (PSK) that is 8 or more characters in length, up to a maximum of 63 characters. See the *Network User's Guide* for more details.

Note

Make sure that the machine is turned on by connecting the power cord.

Improper Setup

If you have previously configured the wireless settings of the machine you must reset the network (LAN) settings before you can configure the wireless settings again.

On your machine, press **Menu**.

Press **▲** or **▼** for **LAN** and press **OK**.

Press **▲** or **▼** to choose **Factory Reset**, and then press **OK**.

Press **+** to choose **Yes**.

Press **+** to choose **Yes**.

2

On your machine, press **Menu**.

Press **▲** or **▼** to choose **LAN** and press **OK**.

Press **▲** or **▼** to choose **WLAN** and press **OK**.

Press **▲** or **▼** to choose **Setup Wizard** and press **OK**.

When **Network I/F switched to Wireless** is displayed, press **OK** to accept.

This will start the wireless setup wizard.

Press **Clear/Back** to cancel.

3

The machine will search for available SSIDs. If a list of SSIDs is displayed, use the **▲** or **▼** keys to choose the SSID you wrote down in step 1, then press **OK**. Go to step 7.

Note

It will take several seconds to display a list of available SSIDs.

If your access point is set to not broadcast the SSID you will have to manually add the SSID name. Go to step 4.

4

Press **▲** or **▼** to choose **<New SSID>** and press **OK**.

- 5** Enter the SSID you wrote down in step **1** using ▲, ▼ keys to choose each letter or number. You can use the ⬅️ and ➡️ keys to move the cursor left and right. For example, to enter the letter a, press the ▲ key once. To enter the number 3, hold down the ▲ key until it appears.

The letters appear in this order: lower case, upper case, numbers and then special letters. (For more information, see *Entering Text* on page 47.)

Press **OK** when you have entered all the characters.

- 6** Press ▲ or ▼ to choose *Infrastructure*, then press **OK**.

- 7** Use the ▲, ▼ and **OK** keys to choose one of the options below: If your network is configured for Authentication and Encryption you must match the settings used for your network.

No Authentication or Encryption: Choose *Open System*, press **OK** then choose *None* for *Encryption Type?* and press **OK**. Then press **+** to choose *Yes* to apply your settings. Go to step **10**.

No Authentication with WEP Encryption: Choose *Open System*, press **OK** then use the ▲ or ▼ to choose *WEP* for the *Encryption Type?* and press **OK**. Go to step **8**.

Authentication with WEP Encryption: Choose *Shared Key*, press **OK**. Go to step **8**.

Authentication with WPA/WPA2-PSK (TKIP or AES) Encryption: Choose *WPA/WPA2-PSK*, press **OK**. Go to step **9**.

- 8** Press ▲ or ▼ to choose the appropriate key number and press **OK**. Enter the WEP key you wrote down in step **1** using ▲, ▼ keys to choose each letter or number. You can use the ⬅️ and ➡️ keys to move the cursor left and right. For example, to enter the letter a, press the ▲ key once. To enter the number 3, hold down the ▲ key until it appears.

The letters appear in this order: lower case, upper case, numbers and then special letters. (For more information, see *Entering Text* on page 47.)

Press **OK** when you have entered all the characters, then press **+** *Yes* to apply your settings. Go to step **10**.

Most access points and routers can store more than one key, but they will only use one at any time for authentication and encryption.

- 9** Press ▲ or ▼ to choose *TKIP* or *AES* for *Encryption Type?* and press **OK**. Enter the WPA/WPA2-PSK password you wrote down in step **1** using ▲, ▼ keys to choose each letter or number. You can use the ⬅️ and ➡️ keys to move the cursor left and right. For example, to enter the letter a, press the ▲ key once. To enter the number 3, hold down the ▲ key until it appears.

The letters appear in this order: lower case, upper case, numbers and then special letters. (For more information, see *Entering Text* on page 47.)

Press **OK** when you have entered all the characters, then press **+** *Yes* to apply your settings. Go to step **10**.

- 10** Your machine will now try to connect to your wireless network using the information you have entered. If successful, *Connected* will appear briefly on the LCD.

*If your machine does not successfully connect to your network, you should repeat steps **2** to **9** to make sure you have entered the correct information.*

*If your access point does not have DHCP enabled you will need to manually configure the IP address, subnet mask and gateway of the machine to suit your network. See the *Network User's Guide* for details.*

- OK!** **Wireless setup is now complete. A four level indicator on the bottom of your machine's LCD will show the wireless signal strength of your access point or router. To install MFL-Pro Suite, continue to step **11**.**

Note

- For Mac OS® X 10.2.0 to 10.2.3 users, upgrade to Mac OS® X 10.2.4 or greater. (For the latest information for Mac OS® X, visit <http://solutions.brother.com>)
- Make sure there are no memory cards or a USB Flash memory drive inserted into the media drives or USB direct interface at the front of the machine.

11 Turn on your Macintosh®.

12 Put the supplied CD-ROM into your CD-ROM drive.

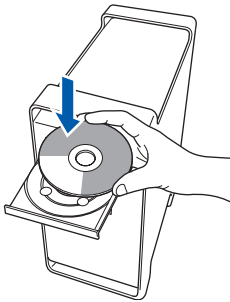

13 Double-click the **Start Here OSX** icon to install.



14 Choose **Wireless Network Connection**, and then click **Next**.

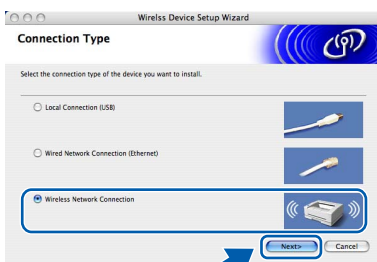

15 Click on the **Checked and confirmed** check box, and then click **Next**. Follow the on-screen instructions.

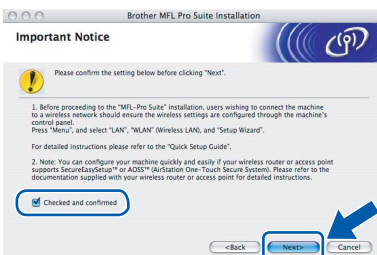

Please wait, it will take a few seconds for the software to install. After the installation, click **Restart** to finish installing the software.

16 The Brother software will search for the Brother device. During this time the following screen will appear.

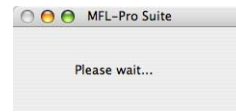

Note

- If the machine is configured for your network, choose the machine from the list, and then click **OK**. This window will not appear if there is only one machine connected on the network, it will be chosen automatically. Go to step **17**.

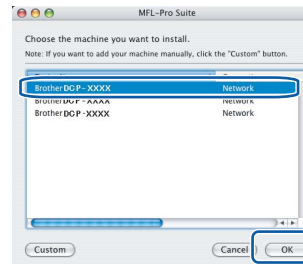

- If this screen appears click **OK**.



Enter a name for your Macintosh® in **Display Name** up to 15 characters long and click **OK**. Go to step **17**.

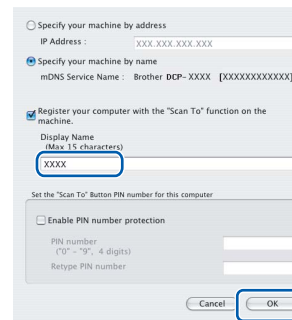

- If you want to use the machine's Scan key to scan over the network you must check the **Register your computer with the "Scan To" function on the machine box**.
- The name you enter will appear on the machine's LCD when you press the **Scan** key and choose a scan option. (For more information, see *Network Scanning in the Software User's Guide on the CD-ROM.*)



- 17** When this screen appears, click **OK**.

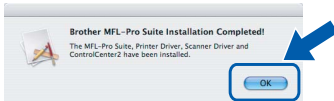

- OK!** For Mac OS® X 10.3.x or greater users: The MFL-Pro Suite, Brother printer driver, scanner driver and Brother ControlCenter2 have been installed and the installation is now complete. Go to step 22.

- 18** For Mac OS® X 10.2.4 to 10.2.8 users: Click **Add**.

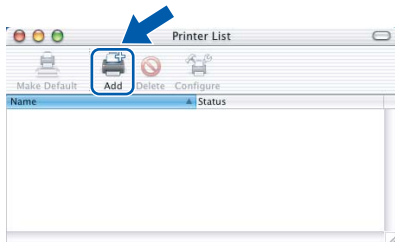

- 19** Make the selection shown below.

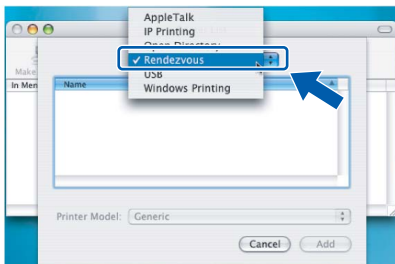

- 20** Choose **DCP-XXXX** (where XXXX is your model name), and then click **Add**.

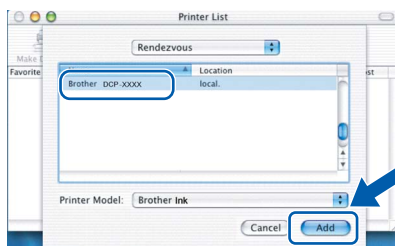

- 21** Click **Print Center**, then **Quit Print Center**.

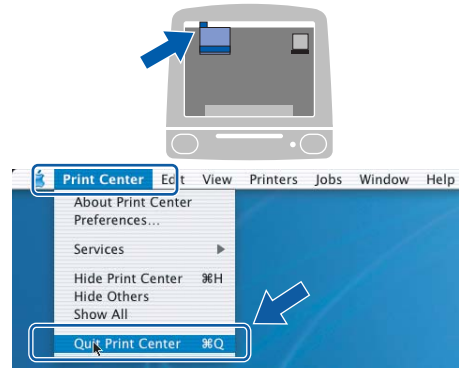

- OK!** The MFL-Pro Suite, Brother printer driver, scanner driver and Brother ControlCenter2 have been installed and the installation is now complete.

- 22** To install Presto!® PageManager®, double-click the **Presto! PageManager** icon and follow the on-screen instructions.



For Mac OS® X 10.2.4 to 10.3.8 users: When this screen appears, click **Go** to download the software from the Brother Solutions Center web site.



Note

When Presto!® PageManager® is installed OCR capability is added to Brother ControlCenter2. You can easily scan, share and organize photos and documents using Presto!® PageManager®.

- OK!** Presto!® PageManager® has been installed and the installation is now complete.

BRAdmin Light utility (For Windows® users)

BRAdmin Light is a utility for initial setup of Brother network connected devices. It also can search for Brother products on your network, view the status and configure basic network settings, such as IP address. For more information on BRAdmin Light, visit us at <http://solutions.brother.com>.



If you require more advanced printer management, use the latest Brother BRAdmin Professional utility version that is available as a download from <http://solutions.brother.com>.

Installing the BRAdmin Light configuration utility

- 1 Click **Install Other Drivers or Utilities** on the menu screen.



- 2 Click **BRAdmin Light** and follow the on-screen instructions.

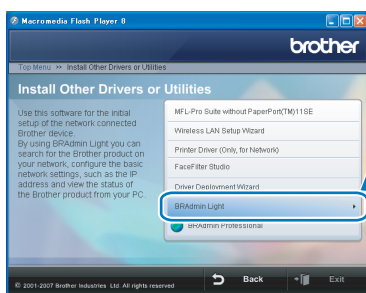

Setting your IP address, Subnet Mask and Gateway using BRAdmin Light



If you have a DHCP/BOOTP/RARP server in your network, you don't have to do the following operation. Because the print server will automatically obtain its IP address.

- 1 Start BRAdmin Light. It will search for new devices automatically.

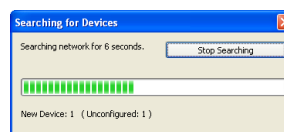

- 2 Double-click the unconfigured device.

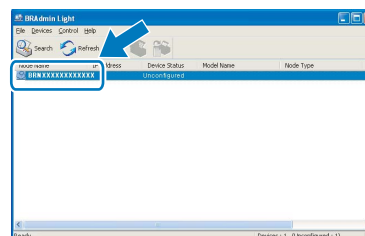

- 3 Choose **STATIC** for the **Boot Method**. Enter the **IP Address**, **Subnet Mask** and **Gateway**, and then click **OK**.

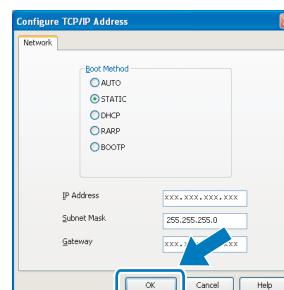

- 4 The address information will be saved to the machine.

BRAdmin Light utility (For Mac OS[®] X users)

BRAdmin Light is a utility for initial setup of Brother network connected devices. It also can search for Brother products on your network, view the status and configure basic network settings, such as IP address from a computer running Mac OS[®] X 10.2.4 or greater. The BRAdmin Light software will be installed automatically when you install the printer driver. If you have already installed the printer driver, you don't have to install it again. For more information on BRAdmin Light, visit us at <http://solutions.brother.com>.

Setting your IP address, Subnet Mask and Gateway using BRAdmin Light



Note

- If you have a DHCP/BOOTP/RARP server in your network, you don't have to do the following operation. The print server will automatically obtain its own IP address.
- Make sure that version 1.4.1_07 or later of Java[™] client software is installed on your computer.

- 1 Double-click the **Macintosh HD** icon on your desktop.

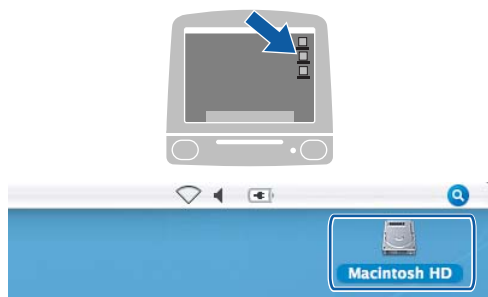

- 2 Choose **Library**, **Printers**, **Brother** and then **Utilities**.

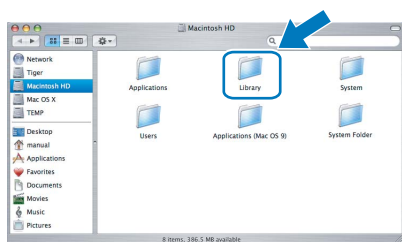

- 3 Double-click the file **BRAdmin Light.jar** and run the software. BRAdmin Light will then search for new devices automatically.

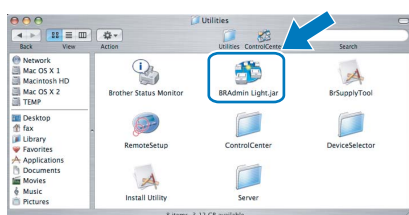

- 4 Double-click the unconfigured device.

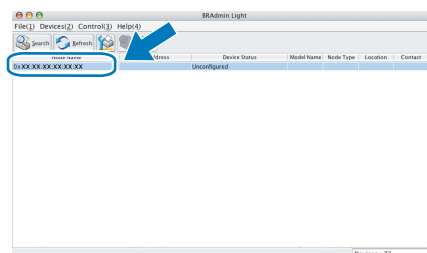

- 5 Choose **STATIC** for the **Boot Method**. Enter the **IP Address**, **Subnet Mask** and **Gateway**, and then click **OK**.

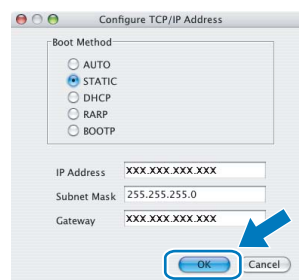

- 6 The address information will be saved to the machine.

Entering Text

Press ▲ or ▼ repeatedly to select a character from the list below:

abcdefghijklmnopqrstuvwxyzABCDEFGHIJKLMN
OPQRSTUVWXYZ0123456789

(space)!"#\$%&'()*+,-./:;<=>?@[\\]^_`{|}~

Press ⬅ or ➡ repeatedly to move the cursor.

Note

Making corrections

If you entered an incorrect letter and want to change it, press ⬅ or ➡ to position the cursor under the incorrect letter.

Use the ▲ and ▼ keys to change to the correct letter, then press ➡ repeatedly to move the cursor back to the end of the text.

Restoring the network settings to factory default

To restore all network settings of the internal Print/Scan server to factory default, please follow the steps below.

- 1** Make sure the machine is not operating, then disconnect all the cables from the machine (except power cable).
- 2** Press **Menu**.
- 3** Press ▲ or ▼ to choose LAN.
Press **OK**.
- 4** Press ▲ or ▼ to choose Factory Reset.
Press **OK**.
- 5** Press **+** to select Yes.
- 6** Press **+** to select Yes.
- 7** The machine will restart, re-connect cables once this is complete.

Instructions on how to install FaceFilter Studio Help (For Windows® users)

To get instructions on how to use FaceFilter Studio, download and install FaceFilter Studio Help. Your computer must be connected to the internet.

Installing FaceFilter Studio Help

- 1** To run FaceFilter Studio, go to **Start/All Programs/FaceFilter Studio/FaceFilter Studio** in the **Start** menu.
- 2** Click the **?** button on the upper right corner of the screen.
- 3** Click **Check for updates** to go to the Reallusion update web page.

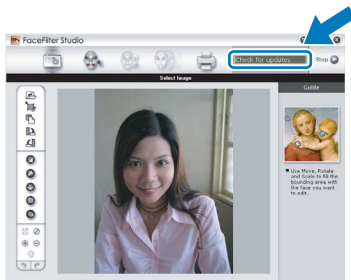

- 4** Click the **Download** button and choose a folder to save the file in.

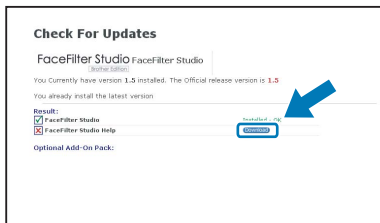

- 5** Close FaceFilter Studio before you start the installer for FaceFilter Studio Help. Double-click the downloaded file from the folder you specified and follow the on-screen instructions for installation.

Note

To view the complete FaceFilter Studio Help, choose **Start/All Programs/FaceFilter Studio/FaceFilter Studio Help** on your computer.

Replacement consumables

When the time comes to replace ink cartridges, an error message will be indicated on the LCD. For more information about the ink cartridges for your machine, visit <http://solutions.brother.com> or contact your local Brother re-seller.

Ink cartridge

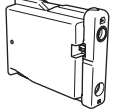
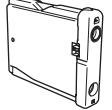
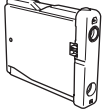
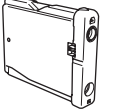
Black	Yellow	Cyan	Magenta
LC1000BK	LC1000Y	LC1000C	LC1000M
			

What is Innobella™?

Innobella™ is a range of genuine consumables offered by Brother. The name "Innobella™" derives from the words "Innovation" and "Bella" (meaning "Beautiful" in Italian) and is a representation of the "innovative" technology providing you with beautiful and long lasting print results.



Trademarks

The Brother logo is a registered trademark of Brother Industries, Ltd.

Brother is a registered trademark of Brother Industries, Ltd.

Multi-Function Link is a registered trademark of Brother International Corporation.

Microsoft and Windows are registered trademarks of Microsoft Corporation in the United States and /or other countries.

Windows Vista is either a registered trademark or trademark of Microsoft Corporation in the United States and /or other countries.

Macintosh and TrueType are registered trademarks of Apple Inc.

Nuance, the Nuance logo, PaperPort and ScanSoft are trademarks or registered trademarks of Nuance Communications, Inc. or its affiliates in the United States and/or other countries.

Presto! PageManager is a registered trademark of NewSoft Technology Corporation.

PictBridge is a trademark.

FaceFilter Studio is a trademark of Reallusion, Inc.

BROADCOM, SecureEasySetup and the SecureEasySetup logo are trademarks or registered trademarks of Broadcom Corporation in the United States and/or other countries.

AOSS is a trademark of Buffalo Inc.

Each company whose software title is mentioned in this manual has a Software License Agreement specific to its proprietary programs.

All other brand and product names mentioned in this manual are trademarks or registered trademarks of their respective companies.

Compilation and Publication

Under the supervision of Brother Industries Ltd., this manual has been compiled and published, covering the latest product descriptions and specifications.

The contents of this manual and the specifications of this product are subject to change without notice.

Brother reserves the right to make changes without notice in the specifications and materials contained herein and shall not be responsible for any damages (including consequential) caused by reliance on the materials presented, including but not limited to typographical and other errors relating to the publication.

Copyright and License

©2007 Brother Industries, Ltd.

This product includes software developed by the following vendors.

©1998-2007 TROY Group, Inc.

©1983-2007 PACIFIC SOFTWARES, INC.

This product includes the "KASAGO TCP/IP" software developed by ELMIC WESCOM, Inc.

©2007 Devicescape Software, Inc.

brother®

UK/IRE/GEN/SAF

Free Manuals Download Website

<http://myh66.com>

<http://usermanuals.us>

<http://www.somanuals.com>

<http://www.4manuals.cc>

<http://www.manual-lib.com>

<http://www.404manual.com>

<http://www.luxmanual.com>

<http://aubethermostatmanual.com>

Golf course search by state

<http://golfingnear.com>

Email search by domain

<http://emailbydomain.com>

Auto manuals search

<http://auto.somanuals.com>

TV manuals search

<http://tv.somanuals.com>