



# **BOWFLEX**

## **XCEED™**



### **The Bowflex Xceed™ Home Gym Owner's Manual and Fitness Guide**

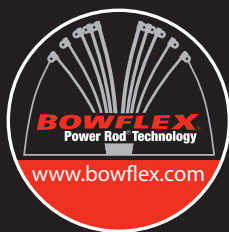



**CONGRATULATIONS** on your commitment to improving your health and fitness! With the Bowflex Xceed™ home gym, you have everything you need to exceed all of your physical fitness, strength, and health expectations!

The Bowflex Xceed™ home gym's exceptional resistance and quality is unmatched by any other single piece of home fitness equipment available. You will not believe the amazing results your body will get with the Bowflex Xceed™ home gym!



Please take your time to read through the entire manual and follow it carefully before attempting to use your Bowflex Xceed™ home gym. Also locate and read all warning labels that are posted on the machine. It's important to understand how to properly perform each exercise before you do so using Power Rod® Resistance.

With all of the fitness choices available today, finding the best workout equipment for your needs can be very confusing. Everyone at Nautilus would like to thank you for selecting the Bowflex Xceed™ home gym.

Bowflex Xceed™ home gym is the finest home fitness product available, and you're just about to prove it to yourself.



# Table of Contents

<b>Specifications / Approvals</b> .....	2	Crossover Narrow Pulldowns w/ Hand Grips .....	35
<b>Important Safety Precautions</b> .....	3	Seated Lat Pulldowns .....	36
<b>Safety Warning Labels</b> .....	4	Seated Wide Lat Pulldowns .....	36
<b>Get To Know Your Home Gym</b> .....	6	<b>Arm Exercises:</b>	
<b>How to Use Your Machine</b> .....	7	Triceps Pushdown w/ Hand Grips .....	37
<b>Define Your Goals</b> .....	11	Triceps Hammer Pushdown .....	37
<b>Workout Guide</b> .....	13	Triceps Pushdown w/ Bent Lat Bar .....	38
<b>The Workouts:</b>		Triceps Extension .....	38
The 20 Minute Better Body Workout .....	14	Hammer Triceps Extension .....	39
Advanced General Conditioning .....	14	Cross Triceps Extension .....	39
20 Minute Upper / Lower Body .....	15	Triceps Kickback .....	40
Body Building .....	16	Hammer Triceps Kickback .....	40
Circuit Training Anaerobic / Cardiovascular .....	17	Resisted Dip .....	41
True Aerobic Circuit Training .....	18	Biceps Curl .....	41
Strength Training .....	19	Concentration Biceps Curl .....	42
<b>Chest Exercises:</b>		Reverse Curl .....	42
Bench Press .....	20	Barbell Biceps Curl .....	43
Chest Fly .....	20	Reverse Barbell Biceps Curl .....	43
Decline Bench Press .....	21	Seated Biceps Curl .....	44
Incline Bench Press .....	21	Seated Biceps Hammer Curl .....	44
<b>Shoulder Exercises:</b>		Wrist Extension .....	45
Reverse Fly .....	22	Wrist Curl .....	45
Crossover Reverse Fly .....	22	<b>Abdominal Exercises:</b>	
Crossover Rear Deltoid Rows .....	23	Trunk Rotation .....	46
Crossover High Rear Deltoid Rows .....	23	Seated (resisted) Oblique Abdominal Crunch .....	46
Lateral Shoulder Raise .....	24	Seated (resisted) Abdominal Crunch .....	47
Forearm Lateral Shoulder Raise .....	24	<b>Leg Exercises:</b>	
Front Shoulder Raise .....	25	Leg Extension .....	48
Seated Shoulder Press .....	25	Squat .....	48
Shoulder Rotator Cuff (internal) .....	26	Standing Hip Extension (knee bent) .....	49
Shoulder Rotator Cuff (external) .....	26	Standing Hip Extension (knee extended) .....	49
Shoulder Extension .....	27	Leg Kickback .....	50
Shoulder Shrug .....	27	Hip Flexion .....	50
Scapular Protraction .....	28	Dead Lift .....	51
Scapular Depression .....	28	Stiff Leg Dead Lift .....	51
Scapular Retraction .....	29	Standing Hip Adduction .....	52
<b>Back Exercises:</b>		Standing Hip Abduction .....	52
Standing Shoulder Pullover w/ Bent Lat Bar .....	30	Calf Raise .....	53
Standing Shoulder Pullover w/ Hand Grips .....	30	<b>Muscle Chart</b> .....	54
Narrow Pulldowns w/ Bent Lat Bar .....	31	<b>Exercise Log</b> .....	55
Narrow Pulldowns w/ Hand Grips .....	31	<b>Fast Fat Loss Now!</b>	
Bent Over Row .....	32	By Ellington Darden, Ph.D. ....	57
Crossover Bent Over Row .....	32	<b>Bowflex Xceed™ Home Gym Warranty Card</b> .....	77
Seated Lat Rows .....	33	<b>Warranty Information</b> .....	79
Crossover Seated Lat Rows .....	33	<b>Important Contact Numbers</b> .....	80
Standing Low Back Extension .....	34		
Reverse Grip Pulldowns .....	34		
Crossover Wide Pulldowns w/ Hand Grips .....	35		



# Specifications / Approvals

## Product Specifications:

<b>Product Weight</b>	157 lbs. (71 kg)
<b>Product Dimensions</b>	53" (135 cm) long x 49" (124 cm) wide x 82" (208 cm) high
<b>Workout Area</b>	96" (244 cm) long x 78" (198 cm) wide
<b>Number of Exercises</b>	Over 60
<b>Power Rod® Resistance</b>	210 lbs. (95 kg)
<b>Power Rod® Upgradability</b>	310 lbs. (141 kg.) 410 lbs. (186 kg.)
<b>User Weight Limit</b>	300 lbs. (136 kg)

## Regulatory Approvals:



Meets:  
 EN957-1 Class H  
 EN957-2 Class H



Meets:  
 ASTM F2276-05  
 ASTM F2216-05





# Important Safety Precautions

## IMPORTANT SAFETY INSTRUCTIONS

The following definition applies to the word “Warning” found throughout this manual:



Used to call attention to POTENTIAL hazards that could result in personal injury or loss of life.

## PRIOR TO USING THIS EQUIPMENT, OBSERVE THE FOLLOWING WARNINGS.



- Read and understand the Owners Manual prior to using this machine.
- Set up and operate this machine on a solid level surface.
- Read and understand all Warning Labels on this machine.
- This machine is for Consumer use only.
- Keep Children away from this machine. Children must be supervised closely if they are near the equipment or are present during the operation of this equipment.
- Do not use additional means to increase the resistance (lifting load) of this machine.
- Consult a physician prior to commencing an exercise program. If, at any time, you feel faint or dizzy, or experience pain, stop and consult your physician.
- Be sure that the Selector Hook is correctly attached to the Rod End.
- Inspect this machine for loose parts or signs of wear. Pay special attention to Cables and Belts and their connections. Do not use if found in this condition; contact Nautilus Customer Service.
- Select a workout area that provides a minimum clearance behind the rod box of 0.5 ft (15 cm) and a total width of 6.5 ft (2.0 m). Allow a minimum of 3.0 ft (0.9 m) free space in front of the machine. Keep third parties out of this area when the machine is in use.
- This machine is designed for a User’s Weight Limit of 300 pounds (136 kg). Do not use if you are over this weight.
- Operate the machine in the manner described in this manual. It can be hazardous to over-exert yourself during exercise.
- This machine contains moving parts. Use Caution. Do not wear loose clothing or jewelry.
- Make sure that all positional adjustment devices are securely engaged.





## Safety Warning Labels

The following safety warnings are located on the Bowflex Xceed™ exercise machine. Please read all safety precautions and warning information prior to using your product. Be sure to replace any warning label if damaged, illegible, or missing. If you need replacement labels, please call a Nautilus Representative at 1-800-NAUTILUS (628-8458).



 **BOWFLEX** Home Gym  
**XCEED**



# Safety Warning Labels

The following safety warnings are located in site specific areas on the unit. Please review and understand the safety warning labels and their locations on the unit prior to use.

If you need to replace a warning label please call 1-800-NAUTILUS (1-800-628-8458) to obtain a new label.

**Label 1:** Please make sure all users read, understand, and follow the warning labels on the home gym. See Figure 1 for general use safety label.

**Location:** The warning label in Figure 1 is located on the back side of the lat tower.

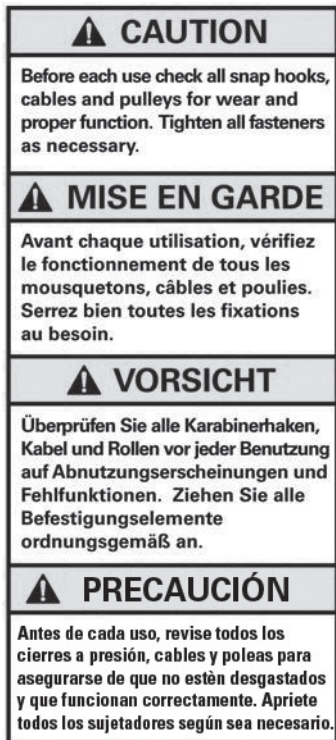

Figure 1

**Label 2:** See figure 2 for “Caution” safety label.

**Location:** Left and right side of rod box.



Figure 2

**Label 3:** See Figure 3 for “Do not hang” notice.

**Location:** Top front of the lat tower.

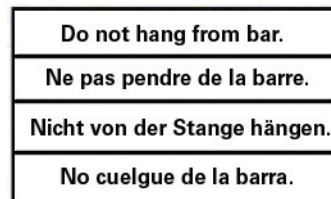

Figure 3





# Get to Know Your Machine







# How to Use Your Machine

## Power Rod® Resistance

Power Rod® resistance rods are made from a special composite material. Your rods are sheathed with a protective black rubber coating. Each rod is marked with its weight rating on the “Rod Cap.”

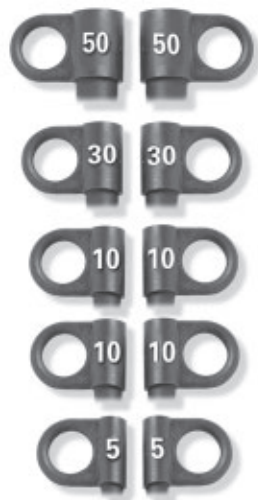

### Adjusting and Understanding the Resistance

The standard Bowflex Xceed™ home gym comes with 210 pounds of resistance (one pair of 5 lb. (2.25 kg) rods, two pairs of 10 lb. (4.5 kg) rods, one pair of 30 lb. (13.5 kg) rods, and one pair of 50 lb. (22.5 kg) rods.

If you upgraded to a 310 (140 kg) or 410 pound (186 kg) capacity you will have an additional one or two pair of 50 lb. (22.5 kg) rods, respectively.

### Hooking Power Rod® Resistance Rods to the Cables

You may use one rod or several rods in combination, to create your desired resistance level.

To hook multiple rods up to one cable, bend the closest rod toward the cable and place the cable hook through that rod cap. You can then hook up the next closest rod through the same cable hook.

Hooking up the closest rod first prevents rods from crossing over the top of one another.



## When You Are Not Using Your Bowflex Xceed™ Home Gym

Disconnect the cables from the Power Rod® resistance rods when you are not using your Bowflex Xceed™ home gym. Use the rod binding strap included with your machine to bind all the rods together at the top. You can also place your cables and grips through the strap to keep them out of the way.



### Safety

When hooking the Power Rod® resistance rods to the cable hooks, do not stand directly over the tops of the rods. Stand off to one side when connecting and disconnecting the Power Rod® resistance rods from the cables.

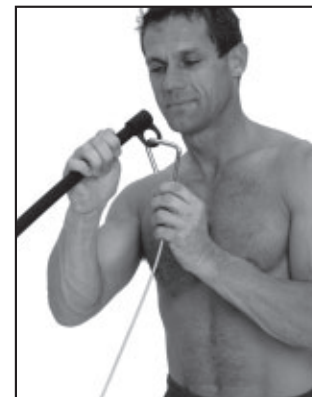

**To Order Additional Sets of 50 lb. (22.5 kg) Power Rod® Resistance Rods, Please Call 1-800-628-8458**





# How to Use Your Machine

## The Bowflex Xceed™ Home Gym Pulley Positions

With the versatility to perform over 65 different exercises, the Bowflex Xceed™ home gym easily transitions from one exercise to another. Below is a guide to the five different pulley positions you will use to optimally perform your workout routine.



**Position One:**  
Standard Position – most common. Active pulleys are on center cross bar.



**Position Two:**  
Lat Pulldown Position. Active pulleys are on lat tower.



**Position Three (optional):**  
Leg Extension Position. Active pulleys are on the squat pulley frame.



**Position Four:**  
Squat position. Active pulleys are on squat pulley frame and on center cross bar.



**Position Five:**  
Rowing position. Active pulleys are on squat pulley frame.

## The Bowflex Xceed® Home Gym Cable Routing

As you use your home gym, you will connect the cables and pulleys in a variety of ways to perform the exercises. Refer to the illustrations below for proper cable routing.

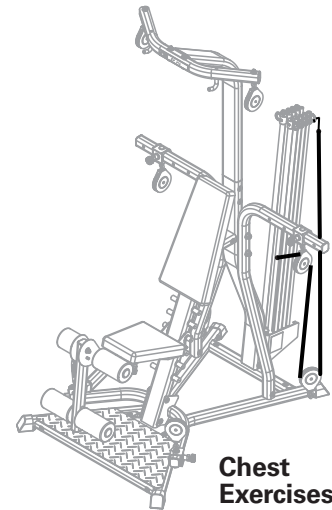

**Chest Exercises**

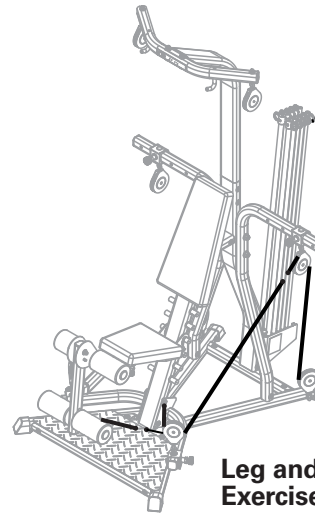

**Leg and Squat Exercises**

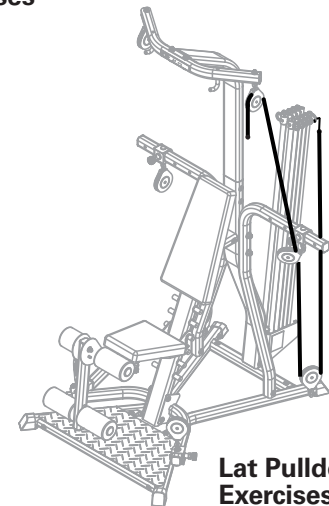

**Lat Pulldown Exercises**



## ***How to Use Your Machine***

---

### **Maintenance and Care of Your Bowflex Xceed® Home Gym**

Inspect your machine for any worn or loose components prior to use. Tighten or replace any worn or loose components prior to use. Pay close attention to cables, straps, or harness and their connections.

Clean the bench with a non-abrasive household cleaner after each use. This will keep it looking new. Do not use automotive cleaner, which can make the bench too “slick.”

Review all warning notices. The safety and integrity designed into a machine can only be maintained when the equipment is regularly examined for damage and repaired. It is the sole responsibility of the owner to ensure that regular maintenance is performed. Worn or damaged components shall be replaced immediately or the equipment removed from service until the repair is made. Only manufacturer supplied components shall be used to maintain/repair the equipment.

If you have any questions regarding your Bowflex Xceed™ home gym, please contact our Customer Service Department at 1-800-605-3369 or by mail to: Customer Service, Nautilus, Inc. World Headquarters, 16400 SE Nautilus Drive, Vancouver, Washington, USA 98683.





# How to Use Your Machine

## Hand Grips and Straps

The hand grips fit snugly around your wrist, ankle, or instep. Attach grips to cables by snapping the cable clip onto the D-ring.

**Standard Grip:** Grasp the handle and cuff together to form a grip without inserting your hand through the cuff portion. Most exercises utilize this grip. The Standard Grip also is used for Hammer Grip exercises, when you need to hold the hand grip vertically for greater wrist support.

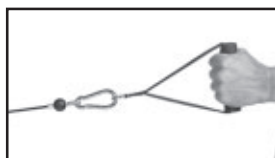

**Hand Cuff Grip:** Slip your hand through the cuff so that the foam pad rests on the back of your hand. Then grasp the remainder of the grip that is sitting in your palm. This method of gripping is great for exercises like front shoulder raises or any exercise where your palm is facing down.



**Ankle Cuff Grip:** The cuff opening can be made larger to accommodate the ankle. Simply insert your hand in the cuff and slide it away from the handle. Insert your foot or ankle and tighten the grip by sliding the handle back toward the cuff.



**Arch Cuff Grip:** The cuff opening can also fit securely over the arch of your foot. For this grip, insert your foot through the cuff until it is around the arch of your instep, and tighten the cuff around your heel to secure the grip.



**Abdominal Crunch Shoulder Harness:** Attach the snap hooks to the D-rings on both ends of the harness. Sit on the bench. Place the harness on your shoulders letting the handles hang to your chest. Cross your arms and grab both handles.

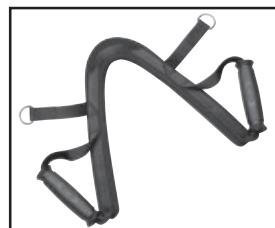

## Lat Pulldown

The Lat Pulldown tower enhances exercises that work back, shoulders and triceps muscles.

### Safety:

- Before using the Lat Pulldown, make sure that all fasteners are in place and tightened.
- Make sure that the Lat Tower's cables are securely fastened to the regular Bowflex Xceed™ home gym cables.
- Always use the bar holders to support the lat bar or remove the bar when not in use.
- Do not hang from the Lat Tower nor attempt to perform "chin ups" from the bar.
- Never pull on the bar unless there is resistance attached to it.

## Leg Extension

Designed to add more effectiveness to all exercises where "leg work" is required.

### Safety:

- Before using the Leg Extension, make sure that all fasteners are in place and tightened.
- Make sure that the Leg Extension's cables are securely fastened to the regular Bowflex Xceed™ home gym cables.
- Always use the Lock Knob to secure the attachment to your Bowflex Xceed™ home gym.



Grips manufactured under license agreement with Hands-On Sports & Gym Accessories, Inc. Patent #4756527







## Define Your Goals

---

Your body will do what you train it to do. That's why it's important to define your goals and focus them. Here are some fitness components that will help you define your goals and choose your fitness program.

**Muscle Strength** is the maximum force that you can exert against resistance at one time. Your muscle strength comes into play when you pick up a heavy bag of groceries or lift a small child. It is developed when a localized muscle is worked both positively (concentric) and negatively (eccentric) at a resistance – great enough so you can perform only five to eight repetitions of the exercise before the muscle fails. Each set of repetitions is followed by a rest interval that typically runs three times longer than the set. Later, between exercise sessions, the muscle overcompensates for the stress and usually increases in both strength and size.

**Muscle Endurance** is the ability to perform repeated contractions. It comes into play when you cross-country ski or work on your feet all day. Endurance training addresses the slow twitch, endurance muscle fibers, which depend on oxygen for energy. To develop muscle endurance, use low resistance and high repetitions – about 15-20 repetitions in each set, three sets to each exercise, working the muscle only to fatigue.

**Muscle Power** is the combination of strength and speed of the muscular contraction. This is often misinterpreted as A) being directly associated with certain skill or sport and/or B) meaning that you must move fast. Load is actually a more important factor than speed when attempting to improve power. When training to achieve muscular power, pick a resistance that fatigues you in the 3-5 repetition range. When performing these reps, it is more important to think of contracting the muscles faster rather than attempting to move faster. Performing sport simulation exercises usually results in a deterioration of the motor pattern or skill. The biomechanically sound method of improving power in your sport is to train for power using the correct joint movements, as described in this manual. Then practice the skill associated with your sport, learning to apply this newly achieved power.

**Body Composition** is the ratio of fat weight (fat) to lean weight (muscles, bones and tissue). As you age, the ratio shifts. The fat weight increases and the lean weight decreases. Training for muscle strength will generally increase muscle size and aerobic conditioning will help burn extra calories. Performing these two forms of exercise, either at different times or together, will create the greatest changes in body fat weight.

**Balanced Strength** and alignment are the result of equal strength developed in all parts of the body. It comes into play in your standing and sitting posture, and in your ability to perform just about any activity safely and effectively. An over-development of the back will round the shoulders; weak or stretched abdominals can cause lower back pain. You want a balance of muscle strength in front and back. In addition, you need a balance of strength between your middle, lower and upper body.

**Flexibility** is the ability of a muscle or group of muscles to move the joint through a full range of motion. Flexibility comes into play when you execute an overhand serve or stretch for the top shelf in the kitchen. It is a cooperative movement of opposite muscle groups. When a muscle contracts, its opposite muscle group must relax for the action to occur. Increased flexibility means an increased range of motion, made possible by this simultaneous contracting and relaxing. Good flexibility is important in protecting the body from injury and can be achieved through the balanced strength training programs that are included in this manual.

**Cardiovascular Endurance** is the ability of the heart and lungs to supply oxygen and nutrients to exercising muscles over an extended period of time. It comes into play when you jog a mile or ride a bike. It is a critical component of overall fitness and health. You may want to design your own personal program specifically geared to your goals and lifestyle. Designing a program is easy, as long as you follow the below guidelines.



# Define Your Goals

---

## Design Your Own Program

### Understand fitness and its components.

Improperly designed programs can be dangerous. Take some time to review this manual as well as other fitness guides.

**Know your current fitness level.** Before you start any fitness program you should consult a physician who will help you determine your current abilities.

**Identify your goals.** Goals are critical to choosing and designing an exercise program that fits and enhances your lifestyle, but so is strategy. It's important not to rush the process and try to accomplish too much too soon. That will lead to setbacks and discouragement. Instead, set a series of smaller achievable goals.

**Select complementary exercises.** Be sure to pair exercises that address compound joint movements and single joint movements. In addition, select exercises that address complementary muscle groups.

**Put first things first.** During each session, first work muscle groups that need the most training.

**Remember your cardiovascular component.** Any fitness program must contain a cardiovascular fitness component to be complete. So complement your resistance training with aerobic exercise such as walking, running, or bicycling.

**Training variables.** When designing your own program there are several variables that, when mixed properly, will equal the right fitness formula for you. In order to find out the best formula, you must experiment with several combinations of variables.

### The variables are as follows:

- **Training Frequency:** The number of times you train per week. We recommend daily activity but not daily training of the same muscle group.
- **Training Intensity:** The amount of resistance used during your repetition.
- **Training Volume:** The number of repetitions and sets performed.
- **Rest Intervals:** The time you rest between sets and the time you rest between workouts.

### Once you've established a base of fitness, follow these basic principles:

- **Isolate Muscle Groups:** Focus work on specific muscle groups.
- **Progressive Loading:** The gradual systematic increase of repetitions, resistance and exercise period.



# Workout Guide

---

## Working Out

A workout begins in your mind's eye. With concentration and visualization you can approach your workout with a positive, constructive attitude. A good pre-workout mental routine is to sit and relax, so that you can focus on what you are about to do and think about achieving your end goal.

## Warming Up

We recommend that you warm up by doing light stretching and performing light exercises on the Bowflex Xceed™ home gym.

## Your Routine

The workout portion of your fitness routine is the series of exercises devoted to your particular goals. Remember, make sure to have fun!

## Cool Down

An essential part of the exercise routine is the cool down. Gradually reduce the level of exercise intensity so that blood does not accumulate in one muscle group, but continues to circulate at a decreasing rate. Remember to gradually move yourself into a relaxed state.

## Breathing

The most important part of breathing during exercise is, quite simply, that you do it. Breathing in or out during the actual performance is not dependent upon the direction of air flow relative to exertion. It is, in fact, a mechanical process that changes the position of your spine as your rib cage moves. Here are some tips for breathing:

- 1) Be cautious when you are concentrating or exerting effort. This is when you will probably hold your breath. **DO NOT** hold your breath. Do not exaggerate breathing. Depth of inhalation and exhalation should be natural for the situation.
- 2) Allow breathing to occur, naturally, don't force it.





# The Workouts

## 20 Minute Better Body Workout

Frequency: 3 Days Per Week (M-W-F) Time: About 20 Minutes

Start by performing one set of each exercise. Warm up with a light resistance that you can perform easily for 5-10 reps without fatiguing. Focus on practicing and learning your technique before increasing the resistance. Then move to a more challenging resistance that you can perform no less than 10 reps and no more than 15 reps without your form deteriorating. As you become stronger, you can advance to two sets for each exercise. Complete all sets of each exercise before moving on to the next one. Rest 30 to 45 seconds between sets. Move slowly on each rep. Use a pace that would allow you to stop the movement instantly at any point in the rep. Count three seconds up and three seconds down and work to fatigue during each set.

Body Part	Exercise	Sets	Reps
Chest	Bench Press	1-2	10-15
Back	Seated Lat Rows	1-2	10-15
Shoulders	Crossover Rear Deltoid Rows	1-2	10-15
Arms	Biceps Curl	1-2	10-15
	Triceps Pushdown	1-2	10-15
Legs	Leg Extension	1-2	10-15
Trunk	Standing Low Back Extension	1-2	10-15
	Seated Abdominal Crunch	1-2	10-15

## Advanced General Conditioning

Frequency: 4 Days Per Week (M-T-TH-F) Time: About 35-45 Minutes

When you are proficient in performing the exercise techniques of the above routine and are no longer realizing results, or have become just plain bored, it is time to change your program. You can increase your training with this "split system" routine that works opposing muscle groups on different days. To do this, you'll increase your resistance when you can perform 12 reps perfectly, and you'll increase your volume by performing more sets and more exercises. Move slowly on each rep. Use a pace that would allow you to stop the movement instantly at any point in the rep. Count three seconds up and three seconds down and work to fatigue during each set.

Day 1 & 3

Body Part	Exercise	Sets	Reps
Chest	Bench Press	1-3	10-12
Shoulders	Seated Shoulder Press	1-3	10-12
Arms	Triceps Pushdown	1-3	10-12
	Biceps Curl	1-3	10-12
Legs	Leg Extension	1-3	10-12

Day 2 & 4

Body Part	Exercise	Sets	Reps
Back	Seated Lat Rows	1-3	10-12
	Seated Lat Pulldowns	1-3	10-12
Shoulders	Crossover Rear Deltoid Row	1-3	10-12
Arms	Biceps Curl	1-3	10-12
	Reverse Curl	1-3	10-12
Trunk	Standing Low Back Extension	1-3	10-12
	Seated Abdominal Crunch	1-3	10-12



# The Workouts

## 20 Minute Upper/Lower Body

Frequency: 4 Days Per Week (M-T-TH-F) Time: About 20 Minutes

This program provides you with a quick and effective workout that combines muscle conditioning with some cardiovascular benefits. Do this routine when you are limited in time or just want a variation to your normal routine. Perform this program training 2 days, resting 1 to 2. Perform all exercises to near failure, stopping at the point that your technique starts to deteriorate. Rest only 20-30 seconds between sets. As you get stronger, increase the number of sets you perform. Move slowly on each rep. Use a pace that would allow you to stop the movement instantly at any point in the rep. Count three seconds up and three seconds down.

### DAY 1 & 3

Body Part	Exercise	Sets	Reps
Chest	Bench Press	1-3	12-15
Back	Seated Lat Rows	1-3	12-15
Shoulders	Crossover Rear Deltoid Rows	1-3	12-15
Arms	Biceps Curl	1-3	12-15
	Triceps Extension	1-3	12-15

### DAY 2 & 4

Body Part	Exercise	Sets	Reps
Legs	Leg Extension	1-3	12-15
	Standing Hip Extension	1-3	12-15
	Standing Hip Abduction	1-3	12-15
	Standing Low Back Extension	1-3	10-12
Trunk	Seated Abdominal Crunch	1-3	10-12



# The Workouts

## Body Building

Frequency: 3 Days On, 1 Day Off Time: About 45-60 Minutes

Body building requires focused concentration and dedication to training, as well as proper eating habits. Train each muscle group to failure before moving on to the next exercise. Do not neglect any muscle group. If needed, include an aerobic activity to increase your caloric expenditure and help to reduce your body fat levels to achieve a defined muscular look. Rest 30-60 seconds between each set and exercise. Focus on proper form. Tighten the muscle before you move, squeeze the muscle as you move, cramp the muscle at the point of full contraction, and resist the movement as you lower the weight. Move slowly on each rep. Use a pace that would allow you to stop the movement instantly at any point in the rep. Count three seconds up and three seconds down and work to fatigue during each set.

### DAY 1

Body Part	Exercise	Sets	Reps
Chest	Bench Press	2-4	8-12
	Chest Fly	2-4	8-12
Shoulders	Seated Shoulder Press	2-4	8-12
	Crossover Rear Deltoid Row	2-4	8-12
	Lateral Shoulder Raise	2-4	8-12
	Shoulder Shrug	2-4	8-12

### DAY 2

Body Part	Exercise	Sets	Reps
Back	Seated Lat Row	2-4	8-12
	Seated Lat Pulldowns	2-4	8-12
Arms	Biceps Curl	2-4	8-12
	Reverse Curl	2-4	8-12
	Triceps Pushdown	2-4	8-12
	Triceps Extension	2-4	8-12

### DAY 3

Body Part	Exercise	Sets	Reps
Legs	Squat	2-4	8-12
	Leg Extension	2-4	8-12
	Standing Hip Extension	2-4	8-12
	Standing Low Back Extension	2-4	8-12
Trunk	Seated Abdominal Crunch	2-4	8-12
	Seated Oblique Abdominal Crunch	2-4	8-12



# The Workouts

## Circuit Training – Anaerobic/Cardiovascular

Frequency: 2-3 Times Per Week    Time: About 20-45 Minutes

Circuit training is a great way to achieve the benefits of strength training and cardiovascular training in one quick, challenging routine. The idea is to move quickly from exercise to exercise, taking only as much rest between sets as it takes to set up the next exercise (less than 20 seconds). One circuit equals one set of each exercise. Initially, start with completing one round of Circuit 1. Then add an additional round of the same circuit. Once you reach three rounds of Circuit 1, add one round of Circuit 2. Add additional rounds of Circuit 2 as your fitness level increases. Repeat process with Circuit 3. Do not let your heart rate exceed 220 minus your resting heart rate. Perform each rep of each exercise slowly and with perfect technique. Count three seconds up and three seconds down.

### Circuit 1

Body Part	Exercise	Reps
Chest	Bench Press	8-12
Legs	Squat	8-12
Back	Seated Lat Row	8-12
Trunk	Seated Abdominal Crunch	8-12

### Circuit 2

Body Part	Exercise	Reps
Shoulders	Seated Shoulder Press	8-12
Legs	Leg Extensions	8-12
Back	Seated Lat Pulldowns	8-12
Trunk	Standing Low Back Extension	8-12
Arms	Biceps Curl	8-12

### Circuit 3

Body Part	Exercise	Reps
Shoulders	Crossover Rear Deltoid Rows	8-12
Arms	Triceps Pushdown	8-12
Trunk	Seated Oblique Crunch	8-12

# The Workouts

## True Aerobic Circuit Training

Frequency: 2-3 Times Per Week    Time: About 20-60 Minutes

Circuit training is a great way to achieve the benefits of strength training and cardiovascular training in one quick, challenging routine. By returning to an aerobic exercise between each set you are increasing your aerobic capacity, endurance and burning fat as energy. The idea is to move quickly from exercise to exercise, taking only as much rest between sets as it takes to set up the next exercise (less than 20 seconds). One circuit equals one set of each exercise. Initially, start with completing one round of Circuit 1. Then add an additional round of the same circuit. Once you reach three rounds of Circuit 1, add one round of Circuit 2. Add additional rounds of Circuit 2 as your fitness level increases. Do not let your heart rate exceed 220 minus your resting heart rate. Perform each rep of each exercise slowly and with perfect technique. Count three seconds up and three seconds down.

Any type of aerobic exercise can be used for this routine. Some examples are: jumping jacks, jogging in place or stair climbing.

### Circuit 1

Body Part	Exercise	Reps
Chest	Bench Press	8-12
Aerobic Exercise	30 – 60 Seconds	
Legs	Squat	8-12
Aerobic Exercise	30 – 60 Seconds	
Back	Seated Lat Rows	8-12
Aerobic Exercise	30 – 60 Seconds	
Trunk	Seated Abdominal Crunch	8-12
Aerobic Exercise	30 – 60 Seconds	

### Circuit 2

Body Part	Exercise	Reps
Shoulders	Seated Shoulder Press	8-12
Aerobic Exercise	30 – 60 Seconds	
Legs	Leg Extension	8-12
Aerobic Exercise	30 – 60 Seconds	
Back	Seated Lat Pulldowns	8-12
Aerobic Exercise	30 – 60 Seconds	
Trunk	Standing Low Back Extension	8-12
Aerobic Exercise	30 – 60 Seconds	
Arms	Biceps Curl	8-12

# The Workouts

## Strength Training

Frequency: 3 Days Per Week (M-W-F)      Time: About 45-60 Minutes

This program is designed to emphasize overall strength development. This is an advanced routine to be used only after you have progressed from the advanced general conditioning routine and only after you have perfected your exercise techniques. Work each set to near exhaustion. If you can perform more than 5 to 8 reps, you should increase your resistance 5 pounds and decrease your reps to 5. Rest 60 – 120 seconds between each set and exercise. Focus on proper form. Tighten the muscle before you move, squeeze the muscle as you move, cramp the muscle at the point of full contraction, and resist the movement as you lower the weight. Move slowly on each rep. Use a pace that would allow you to stop the movement instantly at any point in the rep. Count two seconds up and four seconds down and work to fatigue during each set.

### Day 1

Body Part	Exercise	Sets	Reps
Chest	Bench Press	2-4	5-8
	Chest Fly	2-4	5-8
Shoulders	Seated Shoulder Press	2-4	5-8
	Crossover Rear Deltoid Rows	2-4	5-8
	Shoulder Shrug	2-4	5-8

### Day 2

Body Part	Exercise	Sets	Reps
Back	Seated Lat Row	2-4	5-8
	Seated Lat Pulldowns	2-4	5-8
Arms	Biceps Curl	2-4	5-8
	Reverse Curl	2-4	5-8
	Triceps Pushdown	2-4	5-8
	Triceps Extension	2-4	5-8

### Day 3

Body Part	Exercise	Sets	Reps
Legs	Squat	2-4	5-8
	Leg Extension	2-4	5-8
	Standing Low Back Extension	2-4	8-12
Trunk	Seated Abdominal Crunch	2-4	5-8



## Chest Exercises

### Bench Press – Shoulder Horizontal Adduction (and Elbow Extension)

#### Muscles worked:

Chest muscles (pectoralis major). Also involves front shoulder muscles (anterior deltoid and triceps, located on the back of the upper arm).

#### Position:

Seated – facing outward

#### Accessory:

Hand Grips

#### Pulleys:

Center Cross Bar – wide position

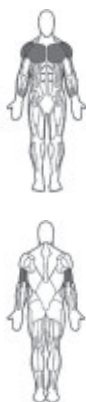

START



FINISH

#### START

- Sit and grasp hand grips.
- Straighten arms to front.
- Be sure arms are directly in line with cables, palms facing down and wrists straight.
- Raise chest and pinch shoulder blades together. Maintain a very slight, comfortable, arch in lower back.

#### ACTION

- Slowly move elbows out, simultaneously bending arms, keeping forearms in line with cables.
- Stop when upper arms are straight out to the sides, level with shoulders.
- Slowly press forward, moving hands toward center. Return to start position with arms straight to front at shoulder width. Keep chest muscles tightened.

#### Before you begin:

Remove Leg Extension and adjust seat height. The pulleys should be in the wide position.

#### Key Points:

- Maintain a 90° angle between upper arms and torso throughout exercise.
- Limit range of motion so elbows do not travel behind shoulders.
- Keep shoulder blades pinched together and maintain good spinal alignment.

### Chest Fly – Shoulder Horizontal Adduction (Elbow Stabilized)

#### Muscles worked:

Emphasizes chest muscles (pectoralis major). Involves front shoulder muscles (anterior deltoid).

#### Position:

Seated – facing outward

#### Accessory:

Hand Grips

#### Pulleys:

Center Cross Bar – wide position



START



FINISH

#### START

- Sit and grasp hand grips.
- Straighten arms to front.
- Be sure arms are directly in line with cables, palms facing in and wrists straight.
- Raise chest and pinch shoulder blades together. Maintain a slight, comfortable, arch in lower back.

#### ACTION

- Slowly move arms inward, maintaining the elbows in a slightly bent position throughout movement.
- Stop when upper arms are straight out in front, level with shoulders.
- Slowly return to start position. Keep chest muscles tightened during motion.

#### Before you begin:

Remove Leg Extension and adjust seat height. The pulleys should be in the wide position.

#### Key Points:

- Maintain 90° angle between upper arms and torso throughout exercise.
- Limit range of motion so elbows do not travel behind shoulders.
- Keep shoulder blades pinched together and maintain good spinal alignment.







## Chest Exercises

### Decline Bench Press – Shoulder Horizontal Adduction (and Elbow Extension)

#### Muscles worked:

Chest muscles (pectoralis major). Also involves front shoulder muscles (anterior deltoid) and triceps.

#### Position:

Seated (seat in lowest position) facing outward

#### Accessory:

Hand Grips

#### Pulleys:

Center Cross Bar – standard position

#### Before You Begin:

Remove Leg Extension and adjust seat to lowest setting.

#### Key Points:

- Maintain 90° angle between upper arms and torso at the bottom of the motion, and slightly less than 90° at the top of the motion.
- Limit range of motion so elbows do not travel behind shoulders.
- Keep shoulder blades pinched together and maintain good spinal alignment.

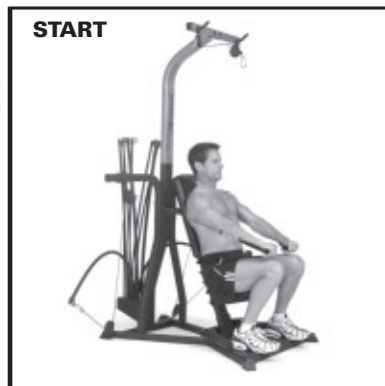
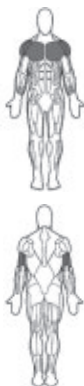

START

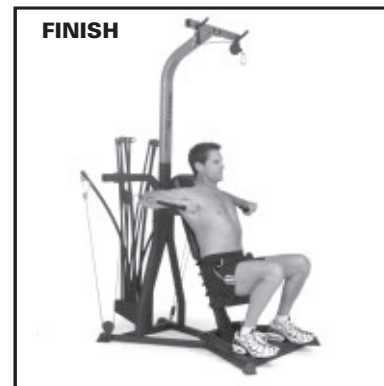

FINISH

#### START

- Sit and grasp hand grips with cable and grip positioned beneath forearm.
- Lower arms 5-6 inches from standard bench press position.
- Straighten arms to front.
- Be sure arms are directly in line with cables, palms facing down and wrists straight.
- Raise chest and pinch shoulder blades together. Keep a gentle arch in lower back.

#### ACTION

- Slowly move elbows outward, simultaneously bending arms, keeping forearms in line with cables at all times.
- Stop when upper arms are straight out to sides, 10° below shoulders.
- Slowly press forward, moving hands toward center. Return to start position, arms straight at shoulder width, hands just above knees in line with cables. Keep chest muscles tightened..

### Incline Bench Press – Shoulder Horizontal Adduction (and Elbow Extension)

#### Muscles worked:

Chest muscles (pectoralis major), especially upper portion. Also involves front shoulder muscles (anterior deltoid) and triceps.

#### Position:

Seated – facing outward

#### Accessory:

Hand Grips

#### Pulleys:

Center Cross Bar – wide position

#### Before You Begin:

Remove Leg Extension and adjust seat height.

#### Key Points:

- Upper arms will be 90° from sides of torso at the bottom of movement and slightly more than 90° from the front of torso at the top.
- Limit range of motion so elbows do not travel behind shoulders.
- Keep shoulder blades pinched together and maintain good spinal alignment.

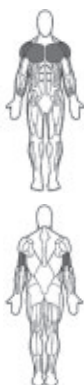

START



FINISH

#### START

- Sit and grasp hand grips.
- Straighten arms to front.
- Raise arms 6-8 inches above regular bench press position.
- Keep arms in line with cables, palms down, wrists straight.
- Raise chest and pinch shoulder blades together. Keep a slight, comfortable, arch in lower back.

#### ACTION

- Slowly move elbows out, simultaneously bending arms. Keep forearms in line with cables.
- Stop when upper arms are out to sides, 10° above shoulders.
- Slowly press forward, moving hands toward center. Return to start position, with arms straight to front at shoulder width and in line with cables.





# Shoulder Exercises

## Reverse Fly – Shoulder Horizontal Abduction (Elbows Stabilized)

### Muscles worked:

Back portion of shoulder muscles (rear deltoids, rear portion of middle deltoids).

### Position:

Standing – facing machine

### Seat:

Removed

### Accessory:

Hand Grips

### Pulleys:

Center Cross Bar – narrow position

### Before You Begin:

Remove Leg Extension. The pulleys should be in the narrow position.

### Key Points:

- Maintain a 90° angle between upper arms and sides of torso throughout exercise.
- Keep shoulder blades pinched together and maintain good spinal alignment.



- Stand on platform.
- Grasp hand grips with palms facing floor, arms nearly straight.
- Stand up straight and bend over slightly from hips until arms are in front of body at a 90° angle to torso.
- Lift chest and pinch shoulder blades together.



- **ACTION**
- Maintaining the same slight bend in arms, move elbows out and back, keeping a 90° angle between upper arms and sides of torso.
- Move until elbows are slightly behind shoulders, then slowly reverse the motion, keeping rear shoulder muscles tightened.

## Crossover Reverse Fly – Shoulder Horizontal Abduction (Elbows Stabilized)

### Muscles worked:

Back portion of shoulder muscles (rear deltoids, rear portion of middle deltoids).

### Position:

Standing – facing machine

### Accessory:

Hand Grips

### Pulleys:

Center Cross Bar – narrow position

### Before You Begin:

- Remove seat and leg extension. The pulleys should be in the narrow position.

### Key Points:

- Maintain 90° angle between upper arms and sides of torso throughout exercise.
- Keep shoulder blades pinched together and maintain good spinal alignment.



- Stand on platform.
- Cross arms in front of body and grasp hand grips (right grip in left hand and vice versa) with palms facing floor and arms nearly straight.
- Stand up straight and bend over slightly from hips until arms are in front of body at a 90° angle to torso.
- Lift chest and pinch shoulder blades together.



- **ACTION**
- Maintaining same slight bend in arms, move elbows out and back, crossing cables as you pull arms back.
- Keep a 90° angle between upper arms and sides of torso.
- Move until elbows are slightly behind shoulders, then slowly reverse motion keeping rear shoulder muscles tightened.



# Shoulder Exercises

## Crossover Rear Deltoid Rows – Elbow Flexion

### Muscles worked:

Back portion of shoulder muscles (rear deltoids, rear portion of middle deltoids).

### Position:

Standing – facing machine

### Accessory:

Hand Grips

### Pulleys:

Center Cross Bar – narrow position

### Before You Begin:

Remove Leg Extension and seat. Center Cross Bar Pulleys should be in narrow position.

### Key Points:

- Maintain a 90° angle between upper arms and sides of torso.
- Keep shoulder blades pinched together and maintain good spinal alignment.
- To work one arm at a time, place non-working hand on top of bench for additional stabilization.



START



FINISH

### START

- Stand on platform.
- Cross arms in front of body and grasp hand grips (right grip in left hand and vice versa) with palms facing down and arms nearly straight.
- Bend over slightly from hips (not spine) and raise arms in front of body, 90° to torso.
- Lift chest, stand up straight with spine in good alignment and tighten trunk muscles.

### ACTION

- Allowing arms to bend as you go, move elbows outward and backward keeping a 90° angle between upper arms and sides of torso.
- Always point forearms in the direction of cables.
- Move until elbows are slightly behind shoulders, then slowly reverse motion. Keep rear shoulder muscles tightened during entire motion.

## Crossover High Rear Deltoid Rows – Elbow Flexion

### Muscles worked:

Back portion of shoulder muscles (rear deltoids, rear portion of middle deltoids).

### Position:

Standing – facing machine

### Accessory:

Hand Grips

### Pulleys:

Lat Tower

### Before You Begin:

Remove Leg Extension and seat.

### Key Points:

- Keep shoulder blades pinched together and maintain good spinal alignment.



START



FINISH

### START

- Stand on platform, with knees slightly bent.
- Cross arms and grab hand grips with palms facing down, arms straight (right hand on left hand grip and vice versa).
- Stand up straight and slightly lean back from hips.
- Lift chest and pinch shoulder blades together.

### ACTION

- Allowing arms to bend as you go, move elbows out and back keeping a 90° angle between upper arms and sides of torso.
- Always point forearms in direction of cables.
- Move until elbows are slightly behind shoulders, then slowly reverse motion. Keep rear shoulder muscles tightened.





# Shoulder Exercises

## Lateral Shoulder Raise – Shoulder Abduction (Elbows Stabilized)

### Muscles worked:

Side shoulder muscles (middle deltoids), top muscle of rotator cuff (supraspinatus) and upper trapezius muscles.

### Position:

Standing – facing outward

### Accessory:

Hand Grips

### Pulleys:

Squat Pulley Frame – use squat straps

### Before You Begin:

Remove Seat and Leg Extension

### Key Points:

- DO NOT swing arms upward or move trunk.



START



FINISH

### START

- Stand on platform facing outward. Grasp hand grips with palms facing each other.
- Attain good spinal posture and bend forward slightly at hip (15 to 20°) by keeping spine straight and sticking rear end out. Do not bend at waist.
- Let arms hang directly in line with cables.
- Elevate shoulders slightly toward back of head.

### ACTION

- Raise arms out to sides to nearly shoulder level.
- Keep side of arm/elbow facing out/up throughout movement.
- Slowly bring arms into start position without relaxing.

## Seated Forearm Lateral Shoulder Raise – Elbows Stabilized

### Muscles worked:

Side shoulder muscles (middle deltoids), top muscle of rotator cuff (supraspinatus) and upper trapezius muscles.

### Position:

Seated – facing outward

### Accessory:

Hand Grips over elbows

### Pulleys:

Squat Pulley Frame – narrow position

### Before You Begin:

Remove Seat and Leg Extension

### Key Points:

- DO NOT swing arms upward or move trunk.

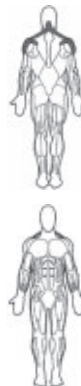

START



FINISH

### START

- Slide hand grips over forearms until grip is cradled in elbow.
- Let upper arms hang in line with cables and bend elbows 90°.
- Elevate shoulders slightly toward the back of your head.
- Raise chest and pinch shoulder blades together.
- Maintain a slight, comfortable, arch in lower back.

### ACTION

- Raise arms out to sides to almost shoulder level.
- Keep side of forearms/elbows facing out/up throughout movement.
- Slowly bring arms to start position without relaxing.







# Shoulder Exercises

## Front Shoulder Raise – Shoulder Flexion (Elbow Stabilized)

### Muscles worked:

Front part of shoulder muscles (front deltoids) and front part of middle deltoids.

### Position:

Standing – facing outward

### Accessory:

Hand Grips

### Pulleys:

Squat Pulley Frame

### Before You Begin:

Remove Leg Extension and seat. Use platform pulleys.

### Key Points:

- Keep chest lifted and abdominals tightened throughout entire motion and maintain good spinal alignment.
- Do not increase arch in lower back while lifting arms.



- START**
- Stand on platform facing outward with knees slightly bent. You may want to lean back against bench.
  - Keep chest up, abs tight and maintain a slight arch in lower back.
  - Grasp hand grips with palms facing machine and arms straight at sides.



- ACTION**
- Arms may be moved alternately or together.
  - Keeping arms straight, move them forward, then up to shoulder height.
  - Slowly return arms beside torso and repeat.

## Seated Shoulder Press – Shoulder Adduction (and Elbow Extension)

### Muscles worked:

Front portion of shoulder muscles (front deltoids and front part of middle deltoids), upper back muscles (upper trapezius), and triceps.

### Position:

Seated – facing outward

### Accessory:

Hand Grips

### Pulleys:

Center Cross Bar – wide position

### Before You Begin:

Remove Leg Extension and adjust seat height.

### Key Points:

- Keep abdominals tight throughout entire motion and maintain good spinal alignment.
- Do not let the arch increase in the lower back while pressing up.



- START**
- Sit facing outward, knees bent and feet flat on floor.
  - Keep chest up, abs tight and maintain a slight arch in lower back.
  - Grasp hand grips with palms facing away from machine.
  - Raise hand grips to just above shoulder level, keeping palms facing forward.



- ACTION**
- Straighten arms overhead, focusing on moving elbows up and in toward head.
  - Slowly return to starting position keeping tension in front shoulder muscles.





# Shoulder Exercises

## Shoulder Rotator Cuff – Internal Rotation

### Muscles worked:

Front rotator cuff muscle (subscapularis).

### Position:

Standing – facing left or right

### Accessory:

Hand Grips

### Pulleys:

Center Cross Bar -wide position

### Before You Begin:

Remove Seat and Leg Extension

### Key Points:

- Motion should be slow and controlled.
- Do not rotate spine to get additional range of motion. Try for pure rotation of shoulder joint. More is not better!
- Use light resistance only. Pick a resistance that you can perform 12-15 perfect reps.

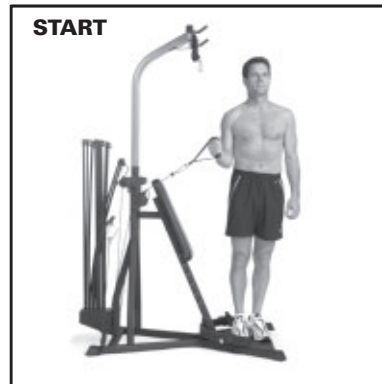

START

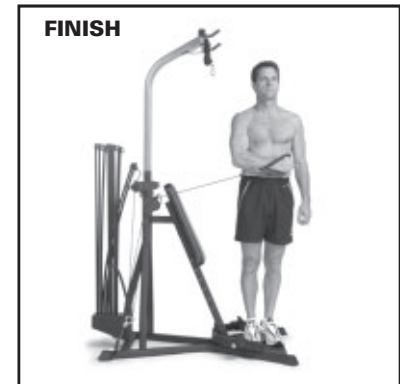

FINISH

### START

- Stand on platform with one side toward machine. Maintain good spinal alignment.
- Grasp hand grip with arm closest to machine and draw upper arm into side, keeping elbow bent 90°.
- Distance yourself from tower to eliminate slack in cable.
- Use very light resistance.

### ACTION

- Rotate forearm toward abdomen, keeping elbow by side.
- Slowly return to start position.

## Shoulder Rotator Cuff – External Rotation

### Muscles worked:

Rear portion of rotator cuff (infraspinatus, teres minor muscles).

### Position:

Standing – facing left or right

### Accessory:

Hand Grips

### Pulleys:

Center Cross Bar – wide position

### Before You Begin:

Remove Leg Extension and seat.

### Key Points:

- Motion should be slow and controlled.
- Do not rotate spine to get additional range of motion. Try for pure external rotation of shoulder joint. More is not better!
- Use light resistance only. Pick a resistance that allows you to perform 12-15 reps.



START



FINISH

### START

- Stand on platform with one side toward machine. Maintain good spinal alignment.
- Using arm furthest from rods, reach across body, grasp hand grip nearest you and draw arm back into side. Keep elbow bent 90°.
- Allow forearm to rest against abdomen and elbow against side, taking out some of the slack or in cables.

### ACTION

- Rotate forearm away from abdomen and out to side, keeping elbow/upper arm by side.
- Slowly return to start position.





# Shoulder Exercises

## Shoulder Extension – Elbows Stabilized

### Muscles worked:

Upper back (latissimus dorsi, teres major, rear deltoid muscles), muscles between shoulder blades (middle trapezius, rhomboid muscles) and triceps.



### Position:

Standing – facing machine

### Accessory:

Hand Grips

### Pulleys:

Center Cross Bar – narrow position

### Before You Begin:

Remove Leg Extension and seat.

### Key Points:

- Do not lose spinal alignment, keep chest lifted.
- Keep lats tightened throughout entire motion.
- Release shoulder blades at end of each rep. Initiate new rep by retracting shoulder blades.



START



FINISH

### START

- Stand on platform, facing machine, knees slightly bent, feet flat on floor.
- Grasp hand grips with palms facing floor.
- Tighten trunk muscles to stabilize spine while maintaining a slight arch in lower back.

### ACTION

- Initiate by pinching shoulder blades together.
- Continue movement by moving hands in an arc, down and back toward hips.
- Slowly return to start position.

## Shoulder Shrug – Scapular Elevation

### Muscles worked:

Upper trapezius and associated smaller muscles of region.



### Position:

Standing – facing machine

### Accessory:

Hand Grips

### Pulleys:

Squat Pulley Frame

### Before You Begin:

Remove Leg Extension and seat.

### Key Points:

- Do not bend neck backward or forward while raising shoulders.
- Do not slouch upon lowering shoulders.
- Keep spine in good alignment through entire motion.
- Make sure both shoulders raise evenly.
- For variation, bend forward slightly from hips, not spine.



START



FINISH

### START

- Stand on platform facing machine.
- Reach down and grasp hand grips with palms facing away.
- Let arms hang, extending toward pulleys.

### ACTION

- Raise shoulders toward back of head, making sure neck/head does not move.
- Slowly reverse motion, keeping upper trapezius muscles tight.







# Shoulder Exercises

## Scapular Protraction – Elbows Stabilized

### Muscles worked:

Serratus anterior muscles, the muscles on the side of the rib cage.

### Position:

Seated – facing outward

### Accessory:

Hand Grips

### Pulleys:

Center Cross Bar – narrow position

### Before You Begin:

Remove Leg Extension and adjust seat height.

### Key Points:

- Maintain a 90° angle between upper arms and torso throughout the exercise.
- Keep elbows straight.
- Do not slouch forward in the upper spine to further the motion. Maintain a very slight arch in lower back at all times.



START



FINISH

### START

- Sit grasp hand grips.
- Lie head back on bench and straighten arms to front.
- Be sure arms are in line with cables, palms facing down and wrists straight.
- Raise chest and pinch shoulder blades. Maintain a slight, comfortable, arch in lower back.

### ACTION

- Keeping arms straight and pointing in the same direction of cables, slowly move shoulder blades forward off bench.
- Slowly return to start position.
- Movement is subtle and only occurs in shoulder.

## Scapular Depression

### Muscles worked:

Develops lower trapezius muscles, which stabilize and move shoulder blades.

### Position:

Seated – facing outward

### Accessory:

50" Bent Lat Bar

### Pulleys:

Lat Tower

### Before You Begin:

Remove Leg Extension and adjust seat height.

### Key Points:

- Do not lose spinal alignment, keep chest lifted.



START



FINISH

### START

- Sit facing outward, knees bent, feet flat on floor.
- Grasp 50" Bent Lat Bar.
- Tighten trunk muscles to stabilize spine while maintaining a slight arch in lower back.

### ACTION

- Keeping arms straight, slide shoulder blades toward hips.
- When shoulder blades are fully depressed, slowly return to start position.
- Movement is subtle and only occurs in shoulder.



# Shoulder Exercises

## Scapular Retraction

### Muscles worked:

Develops muscles between shoulder blades (trapezius and rhomboids).

### Position:

Seated on floor, facing machine

### Accessory:

Hand Grips

### Pulleys:

Squat Pulley Frame

### Before You Begin:

Remove Leg Extension and Seat

### Key Points:

- Do not bend torso forward.
- Do not lose spinal alignment, keep chest lifted.
- Do not pull with arm muscles.



START



FINISH

### START

- Sit on floor facing machine.
- Grab hand grips with palms facing each other.
- Place heels against end of platform, bend hips and knees, arms straight.
- Lift chest, sit up straight with spine in good alignment and tighten trunk muscles.

### ACTION

- Keeping arms straight, slowly pinch shoulder blades together.
- When shoulder blades are fully retracted, slowly return to start position.



## Back Exercises

### Standing Shoulder Pullover – with Bent Lat Bar (Elbows Stabilized)

**Muscles worked:**

Upper back (latissimus dorsi, teres major, rear deltoid muscles). Also involves chest (pectoralis major muscles) and triceps.

**Position:**

Standing – facing machine

**Accessory:**

50" Bent Lat Bar

**Pulleys:**

Lat Tower

**Before You Begin:**

Remove Seat and Leg Extension

**Key Points:**

- Do not lose spinal alignment. Relax neck, keep chest lifted, abs tight and maintain a very slight arch in lower back.
- Keep lats tightened throughout entire motion.
- Release shoulder blades at end of each rep. Initiate new rep by depressing shoulder blades.

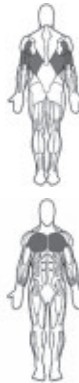
**START**

- Stand on platform.
- Keep knees slightly bent and feet flat on platform.
- Extend arms overhead and grasp 50" Bent Lat Bar, palms facing down.
- Tighten abs to stabilize spine while maintaining a slight arch in lower back.

**ACTION**

- Move hands in an arc down toward legs.
- End with arms by sides, pressing shoulder blades down, completely tightening lats.
- Control the return to start position by slowly moving arms overhead and releasing shoulder blades.

### Standing Shoulder Pullover – with Hand Grips (Elbows Stabilized)

**Muscles worked:**

Upper back (latissimus dorsi, teres major, rear deltoid muscles). Also involves chest (pectoralis major muscles) and triceps.

**Position:**

Standing – facing machine

**Accessory:**

Hand Grips

**Pulleys:**

Lat Tower

**Before You Begin:**

Remove Seat and Leg Extension:

**Key Points:**

- Do not lose spinal alignment. Relax neck, keep chest lifted, abs tight and maintain a very slight arch in lower back.
- Keep lats tightened throughout entire motion.
- Release shoulder blades at end of each rep. Initiate new rep by depressing shoulder blades.

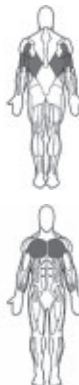
**START**

- Stand on platform.
- Keep knees slightly bent and feet flat on platform.
- Extend arms overhead and grasp Hand Grips, palms facing down.
- Tighten abs to stabilize spine while maintaining a slight arch in lower back.

**ACTION**

- Move hands in an arc down toward legs.
- End with arms by sides, pressing shoulder blades down, completely tightening lats.
- Control the return to start position by slowly moving arms overhead and releasing shoulder blades.





## Back Exercises

### Narrow Pulldowns with Bent Lat Bar – Shoulder Extension (with Elbow Flexion)

#### Muscles worked:

Latissimus dorsi, teres major and rear deltoid, which make up the large pulling muscles of upper back. Also involves biceps group.

#### Position:

Seated – facing machine

#### Accessory:

50" Bent Lat Bar

#### Pulleys:

Lat Tower

#### Before You Begin:

Remove Leg Extension

#### Key Points:

- Do not lose spinal alignment.
- Keep lats tightened throughout entire motion.

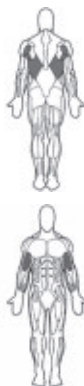

#### START



#### FINISH



#### START

- Grasp 50" Bent Lat Bar, palms facing down, and sit facing machine.
- Position thighs under pulleys. Sit upright with arms extending up. You may position hips under pulleys, but you must lean back slightly from the hips.
- Maintain good spinal alignment, chest lifted, abs tight and slight arch in lower back.

#### ACTION

- Pull shoulder blades down and together while drawing elbows down to front, and then in, toward sides of body.
- At end of motion, arms should be near (not touching) sides, shoulder blades fully depressed toward hips, and forearms in line with cables (not forward).
- Slowly return to start position. Allow arms and shoulder blades to move up, w/o relaxing muscles.

### Narrow Pulldowns with Hand Grips – Shoulder Extension (with Elbow Flexion)

#### Muscles worked:

Latissimus dorsi, teres major and rear deltoid, which make up the large pulling muscles of upper back. Also involves biceps group.

#### Position:

Seated – facing machine

#### Accessory:

Hand Grips

#### Pulleys:

Lat Tower

#### Before You Begin:

Remove Leg Extension

#### Key Points:

- Do not lose spinal alignment.
- Keep lats tightened throughout entire motion.

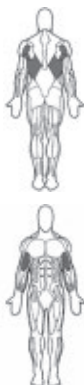

#### START



#### FINISH



#### START

- Grasp Hand Grips, palms facing down, and sit facing machine.
- Position thighs under pulleys and sit upright with arms extending up. You may position hips under pulleys but you must lean back slightly from the hips.
- Maintain good spinal alignment, chest lifted, abs tight and a slight arch in lower back.

#### ACTION

- Pull shoulder blades down and together while drawing elbows down and then in, toward sides of body.
- At end of motion, arms should be near (not touching) sides, shoulder blades fully depressed toward hips and forearms in line with cables (not forward).
- Slowly return to start position. Allow arms and shoulder blades to move up fully, without relaxing muscles.





## Back Exercises

### Bent Over Row

**Muscles worked:**

Latissimus dorsi, teres major and rear deltoid, which make up the large pulling muscles of upper back. Also involves biceps group.

**Position:**

Standing – facing machine

**Accessory:**

Hand Grips

**Pulleys:**

Squat Pulley Frame

**Before You Begin:**

Remove Seat and Leg Extension

**Key Points:**

- Do not bend neck backward or forward while raising bar.
- Do not slouch when lowering hand grips.
- Keep spine in good alignment through entire motion.

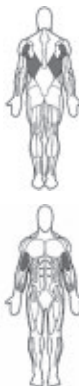

START

**START**

- Stand on platform. Reach down and grasp hand grips, palms facing backward.
- Let arms extend in direction of pulleys.
- Keep back flat and knees bent.



FINISH

**ACTION**

- Move elbows back as you bring hand grips to a point below chest.
- Slowly reverse motion. Keep knees bent and back flat.

### Crossover Bent Over Row

**Muscles worked:**

Back portion of shoulder muscles (rear deltoids, rear part of middle deltoids).

**Position:**

Standing – facing machine

**Accessory:**

Hand Grips

**Pulleys:**

Squat Pulley Frame

**Before You Begin:**

Remove Seat and Leg Extension

**Key Points:**

- Do not bend neck backward or forward while raising bar.
- Do not slouch when lowering hand grips.
- Keep spine in good alignment through entire motion.



START

**START**

- Stand on platform.
- Cross arms and reach down and grasp hand grips, palms facing back.
- Let arms extend in direction of pulleys.
- Keep back flat and knees bent.



FINISH

**ACTION**

- Move elbows back as you bring hand grips to a point below chest.
- Slowly reverse motion. Keep knees bent and back flat.







## Back Exercises

### Seated Lat Rows – Shoulder Extension (and Elbow Flexion)

#### Muscles worked:

Latissimus dorsi, teres major and rear deltoid muscles, which make up the large pulling muscles of upper back. Also involves biceps.

#### Position:

Seated on ground, facing machine

#### Accessory:

Hand Grips

#### Pulleys:

Squat Pulley Frame

#### Before You Begin:

Remove Leg Extension and Seat

#### Key Points:

- Do not bend torso forward at any point.
- Do not lose spinal alignment – keep chest lifted.
- Release shoulder blades at end of each rep and initiate new rep by pinching shoulder blades.

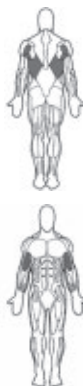

START



FINISH

#### START

- Grab hand grips with palms facing each other.
- Place heels against end of platform, bend knees comfortably.
- Sit up straight with spine in good alignment.

#### ACTION

- Pinch shoulder blades together.
- Pull upper arms down and back, brushing past sides of the body while keeping forearms pointing in direction of cable.
- Slowly return to start position.

### Crossover Seated Lat Rows – Shoulder Extension (and Elbow Flexion)

#### Muscles worked:

Latissimus dorsi, teres major and rear deltoid muscles, which make up large pulling muscles of upper back. Also involves biceps.

#### Position:

Seated on the ground, facing machine

#### Accessory:

Hand Grips

#### Pulleys:

Squat Pulley Frame

#### Before You Begin:

Remove Leg Extension

#### Key Points:

- Do not bend torso forward at any point.
- Do not lose spinal alignment, keep chest lifted.
- Release shoulder blades at end of each rep. Initiate new rep by pinching shoulder blades.

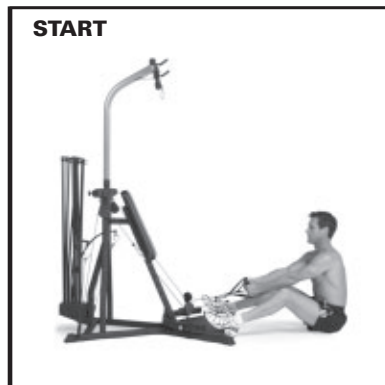
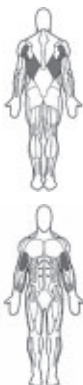

START



FINISH

#### START

- Cross arms and grasp hand grips (right grip in left hand and vice versa) with palms facing each other.
- Place heels against end of platform, bend knees comfortably.
- Sit up straight, spine in good alignment.

#### ACTION

- Pinch shoulder blades together.
- Pull upper arms down and back, brushing past sides of body while keeping forearms pointing in direction of cable.
- Slowly return to start position.





## Back Exercises

### Standing Low Back Extension – with Hip Extension

**Muscles worked:**

Muscles in lower back (erector spinae, deep spinal muscles), lower back muscles, gluteus maximus and hamstrings.

**Position:**

Standing – facing outward

**Accessory:**

Hand Grips

**Pulleys:**

Squat Pulley Frame – standard position

**Before You Begin:**

Remove Seat and Leg Extension

**Key Points:**

- Keep chest lifted and a very slight arch in lower back at all times.
- Move from hips only, not waist. Do not increase or decrease the arch in lower back during the movement.

**START****START**

- Stand facing out.
- Slide hand grips up over forearms to elbows.
- Bend knees comfortably, cross arms in front of chest and pull hand grips tightly to chest.
- Lift chest, tighten trunk muscles and arch lower back slightly. Pinch shoulder blades together slightly.
- Lean forward from hips, slightly letting out tension in the cables.

**FINISH****ACTION**

- Keep chest lifted, move entire torso up as a unit by pivoting at hips.
- Slowly return to start position without slouching or changing spinal alignment.

### Reverse Grip Pulldowns – Lat Tower – Shoulder Extension (with Elbow Flexion)

**Muscles worked:**

Latissimus dorsi, teres major and rear deltoid. Also involves biceps group.

**Position:**

Seated – facing machine

**Accessory:**

Hand Grips

**Pulleys:**

Lat Tower

**Before You Begin:**

Remove Leg Extension

**Key Points:**

- Do not lose spinal alignment.
- Keep lats tightened throughout entire motion.

**START****START**

- Grasp hand grips with an underhand grip, at a comfortable width, then sit on seat.
- Position thighs under pulleys and sit upright with arms extending up. You may position hips under pulleys but you must lean back slightly from the hips (not the waist).
- Maintain good spinal alignment, chest lifted, abs tight, and a slight arch in lower back.

**FINISH****ACTION**

- Pull shoulder blades down and together while drawing elbows down to sides, then in, toward body.
- At end of motion, arms should be drawn near sides (although may not be touching sides), shoulder blades fully depressed towards hips and forearms in line with direction of cables.
- Slowly return to start position allowing arms and shoulder blades to move up, without relaxing muscles.







## Back Exercises

### Crossover Wide Pulldowns – Shoulder Extension (with Elbow Flexion)

#### Muscles worked:

Latissimus dorsi, teres major and rear deltoid. Also involves chest (pectoralis major) muscles and triceps muscles.

#### Position:

Seated – facing machine

#### Accessory:

Hand Grips

#### Pulleys:

Lat Tower

#### Before You Begin:

Remove Leg Extension

#### Key Points:

- Do not lose spinal alignment.
- Keep lats tightened throughout entire motion.
- Do not lean backward as you pull.

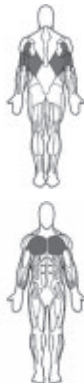

#### START

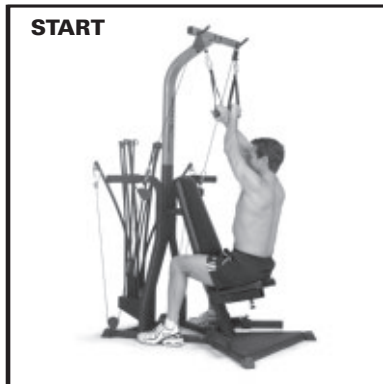

#### FINISH



#### START

- Cross arms, then grasp hand grips with palms facing forward (right grip in left hand and vice versa). Sit on seat.
- Position thighs under pulleys and sit up with arms extending upward. You may position hips under pulleys but you must lean back from hips (not waist).
- Maintain good spinal alignment, chest up, abs tight and a slight arch in lower back.

#### ACTION

- Pull shoulder blades down and together while drawing elbows out, away from sides.
- At end of motion, arms should be drawn away from sides, shoulder blades fully depressed toward hips, and forearms in line with direction of cables.
- Slowly return to start position. Allow arms and shoulder blades to move fully up, without relaxing muscles.

### Crossover Narrow Pulldowns – Shoulder Extension (with Elbow Flexion)

#### Muscles worked:

Latissimus dorsi, teres major and rear deltoid. Also involves biceps group.

#### Position:

Seated – facing machine

#### Accessory:

Hand Grips

#### Pulleys:

Lat Tower

#### Before You Begin:

Remove Leg Extension

#### Key Points:

- Do not lose spinal alignment.
- Keep lats tightened throughout entire motion.

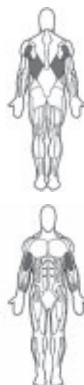

#### START

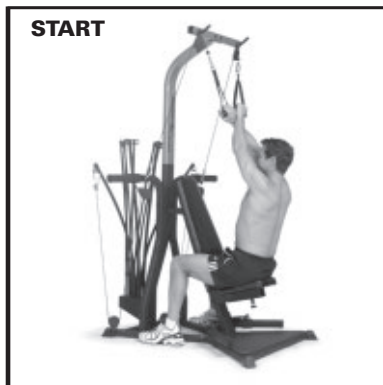

#### FINISH

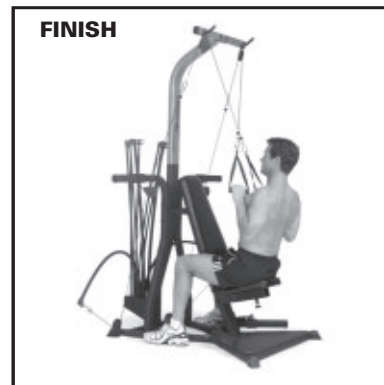

#### START

- Cross arms, then grasp hand grips with palms facing down (left grip in right hand and vice versa). Sit on seat.
- Position thighs under pulleys and sit up with arms extending upward. You may position hips under pulleys but you must lean back from hips (not waist).
- Maintain good spinal alignment, chest lifted, abs tight and a slight arch in lower back.

#### ACTION

- Pull shoulder blades down and together while drawing elbows down to sides, and then in, toward body.
- At end of motion, arms should be drawn near sides (although not touching sides), shoulder blades fully depressed toward hips and forearms up, in line with cables.
- Slowly return to start position allowing arms and shoulder blades to move fully up, without relaxing muscles.





## Back Exercises

### Seated Lat Pulldowns – Shoulder Adduction (with Elbow Flexion)

**Muscles worked:**

Latissimus dorsi, teres major and rear deltoid. Also involves biceps group.

**Position:**

Seated – facing machine

**Accessory:**

Hand Grips

**Pulleys:**

Lat Tower

**Before You Begin:**

Remove Leg Extension

**Key Points:**

- Maintain good spinal alignment, chest lifted, abs tight and a slight arch in lower back.
- Keep lats tightened throughout entire motion.
- Do not let grips touch chest.

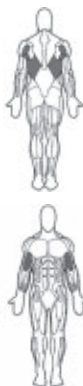

START

**START**

- Hold arms out to sides at shoulder height. Bend elbows 90°, hands slightly less than elbow width.
- Grasp hand grips at same width as above, then sit down with arms extending upward.
- You may position hips under pulleys but only lean back slightly from hips (not the waist).



FINISH

**ACTION**

- Pull shoulder blades down and together while drawing elbows down to sides, then in, toward trunk.
- At end of motion, arms should be drawn near sides (not touching sides), shoulder blades fully depressed toward hips and forearms up in line with cables.
- Slowly return to start position. Allow arms and shoulder blades to move up, w/o relaxing muscles.

### Seated Wide Lat Pulldowns – Shoulder Adduction (with Elbow Flexion)

**Muscles worked:**

Latissimus dorsi, teres major and rear deltoid. Also involves biceps group.

**Position:**

Seated – facing machine

**Accessory:**

50" Bent Lat Bar

**Pulleys:**

Lat Tower

**Before You Begin:**

Remove Leg Extension

**Key Points:**

- Do not lose spinal alignment.
- Keep lats tightened throughout entire motion.
- If you can't complete the exercise with hands in the wide position, bring hands closer together.

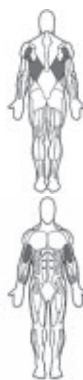

START

**START**

- Grasp 50" Bent Lat Bar at a comfortable, wide grip, then sit with arms extending up.
- You may position hips under pulleys but you must lean back slightly from hips (not the waist).
- Maintain good spinal alignment, chest lifted, abs tight and a slight arch in lower back.

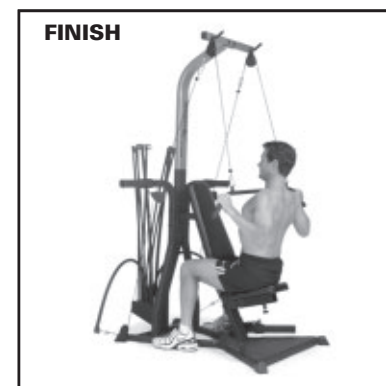

FINISH

**ACTION**

- Pull shoulder blades down and together while drawing elbows down to sides, then in, toward trunk.
- 50" Bent Lat Bar may not touch chest, but, at end of motion, arms should be drawn near sides (not touching sides), shoulder blades fully depressed toward hips and forearms up in line with cables.
- Slowly return to start position, Allow arms and shoulder blades to move fully upward, without relaxing muscles.



# Arm Exercises

## Triceps Pushdown – Elbow Extension

### Muscles worked:

Triceps muscles.

### Position:

Standing – facing machine

### Accessory:

Hand Grips

### Pulleys:

Lat Tower

### Before You Begin:

Remove Seat and Leg Extension

### Key Points:

- Keep upper arms motionless.
- Keep wrists straight.
- Tighten triceps throughout exercise and control motion on the way up.
- Maintain good posture by keeping chest lifted and abs tight. Maintain a very slight arch in the lower back.



START



FINISH

### START

- Stand on platform.
- Grasp hand grips at shoulder width, palms down.
- Bring arms down to sides, elbows straight. This is Start Position.
- Bend over slightly from hips, so shoulders are directly over hands. Lift chest and tighten abs to stabilize spine. Maintain a slight arch in lower back.

### ACTION

- Keep upper arms stationary and elbows next to sides of torso. Slowly allow elbows to bend, moving hands in arcing motion away from legs and up.
- Stop at 90°.
- Think about tightening triceps. Slowly reverse arcing motion and straighten arms fully.

## Triceps Hammer Pushdown – Elbow Extension

### Muscles worked:

Triceps muscles.

### Position:

Standing – facing machine

### Accessory:

Hand Grips in “Hammer Grip”

### Pulleys:

Lat Tower

### Before You Begin:

Remove Seat and Leg Extension

### Key Points:

- Keep upper arms motionless.
- Keep wrists straight.
- Tighten triceps throughout exercise and control motion on the way up.
- Maintain good posture by keeping chest lifted and abs tight. Maintain slight arch in lower back.



START



FINISH

### START

- Stand on platform.
- Grasp hand grips at shoulder width, with grips in vertical hammer position.
- Bring arms down to sides, elbows straight. This is Start Position.
- Bend over slightly from hips, so shoulders are directly over hands. Lift chest and tighten abs to stabilize spine. Maintain a slight arch in lower back.

### ACTION

- Keep upper arms stationary and elbows next to sides of torso. Slowly allow elbows to bend, moving hands in arcing motion away from legs and up.
- Stop at 90°.
- Think about tightening triceps. Slowly reverse arcing motion and straighten arms fully.



# Arm Exercises

## Triceps Pushdown – with Bent Lat Bar (Elbow Extension)

### Muscles worked:

Triceps muscles.

### Position:

Standing – facing machine

### Accessory:

50" Bent Lat Bar

### Pulleys:

Lat Tower

### Before You Begin:

Remove Leg Extension and Seat

### Key Points:

- Keep upper arms motionless.
- Keep wrists straight.
- Tighten triceps throughout exercise and control motion on the way up.
- Maintain good posture by keeping chest lifted, abs tight. Maintain a very slight arch in lower back.



- Stand on platform.
- Grasp 50" Bent Lat Bar at shoulder width, palms down.
- Bring arms down to sides, elbows straight. This is Start Position.
- Bend over from hips, so shoulders are over hands. Lift chest and tighten abs to stabilize spine while maintaining a slight arch in lower back.



- **ACTION**
- Keep upper arms stationary and elbows next to sides of torso. Slowly allow elbows to bend, moving hands in arcing motion away from legs and up.
- Stop at 90°.
- Think about tightening triceps. Slowly reverse arcing motion and straighten arms fully.

## Triceps Extension – Elbow Extension

### Muscles worked:

Triceps muscles.

### Position:

Seated – facing outward

### Accessory:

Hand Grips

### Pulleys:

Center Cross Bar – narrow position

### Before You Begin:

Remove Leg Extension and adjust seat height.

### Key Points:

- Keep upper arms/shoulders motionless.
- Keep wrists straight.
- Tighten triceps throughout exercise and control motion on the way down.



- **START**
- Bend knees and place feet flat on floor.
- Reach behind and grasp one or both of the hand grips, palms facing away.
- Keep elbows above shoulders, directly in line with cables, palms facing out, wrists straight.
- Raise chest and pinch shoulder blades together. Maintain a slight, comfortable, arch in lower back.



- **ACTION**
- Keep upper arm stationary. Slowly straighten elbows allowing hands to move in arcing motion above head.
- Slowly reverse arcing motion until elbows are bent again.





# Arm Exercises

## Hammer Triceps Extension – Elbow Extension

### Muscles worked:

Triceps muscles.

### Position:

Seated – facing outward

### Accessory:

Hand Grips in “Hammer Grip”

### Pulleys:

Center Cross Bar – narrow position

### Before You Begin:

Remove Leg Extension and adjust seat height.

### Key Points:

- Keep upper arms/shoulders motionless.
- Keep wrists straight.
- Tighten triceps throughout exercise and control the motion on the way down.



START

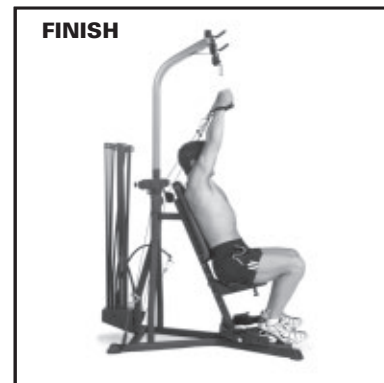

FINISH

### START

- Bend knees. Place feet flat on platform.
- Reach behind and grasp one or both of the hand grips in the vertical hammer grip position.
- Keep elbows above shoulders, directly in line with cables, palms facing down, wrists straight.
- Raise chest and pinch shoulder blades together. Maintain a slight, comfortable, arch in lower back.

### ACTION

- Keep upper arm stationary. Slowly straighten elbows, allowing hands to move in arching motion above head.
- Slowly reverse arching motion until elbows are bent again.

## Cross Triceps Extension

### Muscles worked:

Triceps muscles.

### Position:

Seated – facing outward

### Accessory:

Hand Grips in “Hammer Grip”

### Pulleys:

Center Cross Bar – narrow position

### Before You Begin:

Remove Leg Extension

### Key Points:

- Keep upper arm motionless.
- Keep wrist straight.
- Tighten triceps throughout exercise and control motion on the way down.
- Keep knees bent and feet flat on floor.



START



FINISH

### START

- Reach over shoulder and grasp a hand grip. Using the Hammer Grip, bend elbow until hand is in front of chest, palm down.
- Lay head back against bench and straighten arm to front.
- With free hand, lightly grasp back of arm near elbow, to stabilize working arm.
- Raise chest and pinch shoulder blades together. Maintain a slight arch in lower back.

### ACTION

- Keep upper arm stationary. Bend elbow, moving hand in arching motion across chest.
- Stop motion when arm is straight, then slowly reverse arc motion until elbow is back in start position.



# Arm Exercises

## Triceps Kickback

**Muscles worked:**

Triceps muscles.

**Position:**

Standing – facing machine

**Accessory:**

Hand Grips

**Pulleys:**

Center Cross Bar – narrow position

**Before You Begin:**

Remove Seat and Leg Extension

**Key Points:**

- Maintain spinal alignment.
- Keep arm at side and wrist straight throughout entire motion.
- Tighten triceps throughout exercise and control motion.
- Keep palms facing upward.

**START**

- Stand on platform.
- Keep chest lifted and maintain a slight arch in lower back.
- Support yourself with one arm on the horizontal bar and grasp a hand grip with free hand, palm facing backward.
- Draw elbow back so upper arm is beside body, elbow bent approximately 90°.

**ACTION**

- Straighten elbow while keeping upper arm completely still.
- When arm is straight, slowly return to start position.

## Hammer Triceps Kickback

**Muscles worked:**

Triceps muscles.

**Position:**

Standing – facing machine

**Accessory:**

Hand Grips in “Hammer Grip”

**Pulleys:**

Center Cross Bar – narrow position

**Before You Begin:**

Remove Seat and Leg Extension

**Key Points:**

- Maintain spinal alignment.
- Keep arm at side and wrist straight throughout motion.
- Tighten triceps throughout exercise and control motion.
- Maintain Hammer Grip throughout exercise.

**START**

- Stand on platform.
- Keep chest lifted and maintain a slight arch in lower back.
- Support yourself with one arm on horizontal bar and grasp a hand grip in the vertical hammer grip position with free hand, palm facing in.
- Draw elbow back so upper arm is beside body and elbow bent approximately 90°.

**ACTION**

- Straighten elbow while keeping upper arm completely still.
- When arm is straight, slowly return to start position.



# Arm Exercises

## Resisted Dip – Elbow Extension

### Muscles worked:

Triceps muscles.

### Position:

Standing – facing outward

### Accessory:

Hand Grips

### Pulleys:

Lat Tower

### Before You Begin:

Remove Seat and Leg Extension

### Key Points:

- Keep back straight and knees slightly bent.
- Keep the abdominals tight throughout the entire motion and maintain good spinal alignment.



START



FINISH

### START

- Stand on the platform facing away from machine. Reach back and grab hand grips with thumbs on inside toward body.
- Cable should be between arm and body.
- Upper arms should be at a 90° angle from torso.

### ACTION

- Straighten arms down, focusing on moving elbows down and inward toward hips.
- Slowly return to start position keeping tension in back shoulder muscles.

## Biceps Curl – Elbow Flexion (in Supination)

### Muscles worked:

Biceps muscles.

### Position:

Standing – facing machine

### Accessory:

Hand Grips

### Pulleys:

Squat Pulley Frame

### Before You Begin:

Remove Seat and Leg Extension

### Key Points:

- Keep elbows at sides.
- Keep wrists straight.
- Keep trunk muscles tight and maintain a very slight arch in lower back.



START



FINISH

### START

- Stand on platform.
- Bend down and grasp hand grips with palms forward.
- Stand with upper arms by sides. Lift chest, tighten abs and maintain a slight arch in lower back.

### ACTION

- Curl hand grips forward, then up, and then in toward shoulders while keeping elbows at sides and upper arms completely still.
- Slowly lower to start position by performing the same arcing motion.





## Arm Exercises

### Concentration Biceps Curl – Elbow Flexion (in Supination)

**Muscles worked:**

Biceps muscles.

**Position:**

Standing – right or left side facing machine

**Accessory:**

Hand Grips

**Pulleys:**

Squat Pulley Frame

**Before You Begin:**

Remove Seat and Leg Extension

**Key Points:**

- Keep elbow pointing toward floor at all times.
- Keep wrist straight.
- Bend at hips, not at the waist.
- Keep back straight, chest up and maintain a very slight arch in lower back.



START



FINISH

**START**

- Stand on platform, one side toward machine.
- With hand closest to Power Rod® resistance rods, grasp hand grip.
- Keeping back straight, bend at hips and knees, until trunk is parallel to floor. Place uninjured hand on thigh to help stabilize.

**ACTION**

- Curl hand grip away from cable, then up toward shoulder while keeping upper arm completely motionless and elbow pointing toward the floor at all times.
- Slowly return to start position performing the same arc of motion.

### Reverse Curl – Elbow Flexion (in Pronation)

**Muscles worked:**

Deep arm muscle (brachialis). Also the front forearm muscle (brachioradialis) and biceps.

**Position:**

Standing – facing machine

**Accessory:**

Hand Grips

**Pulleys:**

Squat Pulley Frame – with squat straps

**Before You Begin:**

Remove Seat and Leg Extension

**Key Points:**

- Keep elbows at sides.
- Keep wrists straight.
- Keep trunk muscles tight and maintain a very slight arch in lower back.



START



FINISH

**START**

- Stand on platform.
- Bend down and grasp hand grips with palms facing backward.
- Stand with arms by sides.
- Lift chest, tighten abs and maintain slight arch in lower back.

**ACTION**

- Keeping palms facing down, slowly curl hand grips forward, then up, then in toward shoulders while keeping elbows at sides and upper arms completely still.
- Slowly lower to start position.



# Arm Exercises

## Barbell Biceps Curl – Elbow Extension

### Muscles worked:

Biceps muscles.

### Position:

Standing – facing machine

### Accessory:

Squat Bar – with squat straps

### Pulleys:

Squat Pulley Frame

### Before You Begin:

Remove Seat and Leg Extension

### Key Points:

- Keep elbows at sides.
- Keep wrists straight.
- Keep trunk muscles tight and maintain a very slight arch in lower back.



START

### START

- Stand on platform.
- Bend down and grasp squat bar with palms facing forward.
- Stand with upper arms by sides (although not pressed tightly). Lift chest, tighten abs and maintain a slight arch in lower back.



FINISH

### ACTION

- Curl squat bar forward, then up, and then in toward shoulders while keeping elbows at sides and upper arms completely still.
- Slowly lower to start position by performing same arcing motion.

## Reverse Barbell Biceps Curl – Elbow Extension

### Muscles worked:

Biceps muscles.

### Position:

Standing – facing machine

### Accessory:

Squat Bar – with squat straps

### Pulleys:

Squat Pulley Frame

### Before You Begin:

Remove Seat and Leg Extension

### Key Points:

- Keep elbows at sides.
- Keep wrists straight.
- Keep trunk muscles tight and maintain a very slight arch in lower back.



START

### START

- Stand on platform.
- Bend down and grasp squat bar with palms facing down.
- Stand with upper arms by sides (although not pressed tightly). Lift chest, tighten abs and maintain a very slight arch in lower back.



FINISH

### ACTION

- Curl wrists back to bring squat bar forward, then up, and then in toward shoulders while keeping elbows at sides and upper arms completely still.
- Slowly lower to start position by performing same arcing motion.



# Arm Exercises

## Seated Biceps Curl – Elbow Flexion (in Supination)

### Muscles worked:

Biceps muscles.

### Position:

Seated – facing outward

### Accessory:

Hand Grips

### Pulleys:

Squat Pulley Frame

### Before You Begin:

Remove Leg Extension

### Key Points:

- Do not rock upper body while bending elbow.
- Keep wrists straight.
- Keep chest lifted, trunk muscles tight and maintain a very slight arch in lower back.



### START

- Grasp hand grips, arms at sides with forearms near thighs.
- Maintain correct spinal alignment.

### ACTION

- Curl forearms toward upper arms, keeping upper arms completely still.
- Slowly return to start position without relaxing biceps.

## Seated Biceps Hammer Curl – Elbow Flexion

### Muscles worked:

Biceps muscles and brachioradialis.

### Position:

Seated – facing outward

### Accessory:

Hand Grips in “Hammer Grip”

### Pulleys:

Squat Pulley Frame

### Before You Begin:

Remove Leg Extension

### Key Points:

- Do not rock upper body while bending elbow.
- Keep wrists straight.
- Keep chest lifted, trunk muscles tight and maintain a very slight arch in lower back.



### START

- Grasp hand grips in vertical hammer grip position, arms at sides, forearms near thighs.
- Maintain correct spinal alignment.

### ACTION

- Curl forearms toward upper arms, keeping upper arms completely still.
- Slowly return to start position without relaxing biceps.



# Arm Exercises

## Wrist Extension

### Muscles worked:

Back and top parts of forearms.

### Position:

Standing – facing machine

### Accessory:

Hand Grips

### Pulleys:

Squat Pulley Frame

### Before You Begin:

Remove Seat and Leg Extension

### Key Points:

- Move slowly and keep tension in back of forearms at all times.
- Perform this exercise one arm at a time to make it easier to focus and isolate the back of forearms, or perform it with both arms simultaneously to save time.

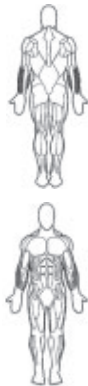

START



FINISH

### START

- Stand on platform, knees slightly bent.
- Grasp hand grips, palms facing down. Rest mid-forearms against sides with elbows flared out.
- Raise chest, tighten trunk muscles and maintain a slight arch in lower back.

### ACTION

- Slowly curl back of fists toward forearms.
- Slowly return to start position.

## Wrist Curl – with Wrist Flexion

### Muscles worked:

Front part of forearms. Also increases the strength of grip and isometrically challenges biceps muscles.

### Position:

Standing – facing machine

### Accessory:

Hand Grips

### Pulleys:

Squat Pulley Frame Removed

### Before You Begin:

Remove Seat and Leg Extension

### Key Points:

- Move slowly and keep tension in front of forearm at all times.
- Do not increase or decrease bend in arms, perform the entire motion at wrist.
- Do not rock body. Keep chest lifted, abs tight and maintain a slight arch in lower back.



START



FINISH

### START

- Stand on platform.
- Bend down and grasp hand grips, palms facing forward, fingertips down.
- Stand with upper arms and elbows by sides.
- Lift chest, tighten trunk muscles and maintain a slight arch in lower back.
- Bend arms 90°, palms up. Hold position throughout entire exercise.

### ACTION

- Slowly curl fists towards front of forearms.
- Keeping forearms still, slowly let fists return to start position.



# Abdominal Exercises

## Trunk Rotation

### Muscles worked:

Most of trunk muscles. Note: rotation is limited in the spine and should be performed with minimal resistance, in proper alignment.

### Position:

Seated, facing outward left or right

### Accessory:

Hand Grips

### Pulleys:

Center Cross Bar – standard position

### Before You Begin:

Remove Leg Extension

### Key Points:

- Keep chest lifted and maintain good spinal alignment with a slight arch in lower back.
- Keep hands centered in front of middle of chest and shoulder blades pinched together. Make sure all of motion occurs in torso.
- Move only as far as muscles will take you and eliminate uncontrolled momentum.
- Caution: Do not use heavy resistance. Pick a weight that allows you to perform 12-15 reps.



START



FINISH

### START

- Sitting sideways on seat with one side facing machine, grasp hand grip closest to you with both hands.
- Raise both arms up to shoulder level, centered in front of middle chest.
- Keep elbows slightly bent.
- Lift chest, pinch shoulder blades together, tighten abs and maintain a slight arch in lower back.

### ACTION

- Tighten entire ab area and slowly rotate rib cage/arms away from cables (30 – 40°), as if rotating with a rod through middle of spine.
- Slowly return to start position.

## Seated (Resisted) Oblique Abdominal Crunch

### Muscles worked:

External obliques on resistance side and internal obliques on opposite side.

### Position:

Seated – facing outward

### Accessory:

Abdominal Crunch Shoulder Harness

### Pulleys:

Center Cross Bar – standard position

### Before You Begin:

Remove Leg Extension

### Key Points:

- Allow exhalation up and inhalation down, don't exaggerate it.
- Do not lift head/chin. head should follow rib motion, not lead, allowing you to maintain normal neck posture.
- Tighten abs throughout range of motion. Do not let abs relax until set is over.
- MOVING SLOWLY to eliminate momentum is critical.

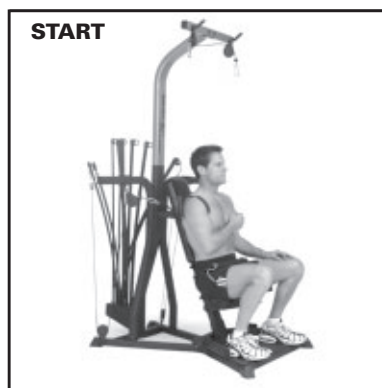
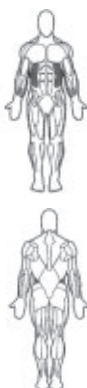

START

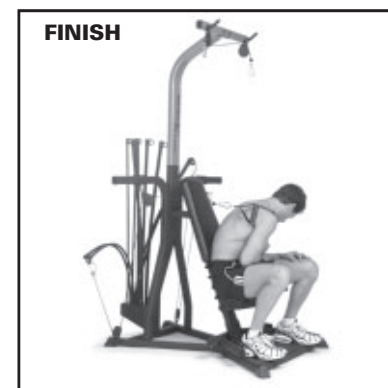

FINISH

### START

- Place seat in lowest position.
- Attach the Abdominal Crunch Shoulder Harness by snapping one hook to each of the D rings. Place the harness on your shoulders letting the handles hang over your chest. Grab opposite handles so that your arms cross your chest.
- Lower back can start flat or in a normal arch, knees and hips bent, feet flat on floor.

### ACTION

- Tighten abs before you move, focusing on area from side of ribs to front of pelvis on the same side.
- Slowly move diagonally, rotating and curling torso, with the side of ribs directed toward front of pelvis.
- Move as far as you can, without moving hips or lower back from bench.
- Slowly reverse motion returning to start position without resting.







# Abdominal Exercises

## Seated (Resisted) Abdominal Crunch – Spinal Flexion

### Muscles worked:

Abdominal area including upper and lower front abs (rectus abdominus) and side abs (obliques)

### Position:

Seated – facing outward

### Accessory:

Abdominal Crunch Shoulder Harness

### Pulleys:

Center Cross Bar – narrow position

### Before You Begin:

Remove Leg Extension

### Key Points:

- Allow exhalation up and inhalation down, but don't exaggerate it.
- Do not lift head/chin. Your head should follow rib motion, not lead, allowing you to maintain normal neck posture.
- Tighten abs throughout range of motion. Do not let abs relax until set is over.
- MOVING SLOWLY to eliminate momentum is critical.

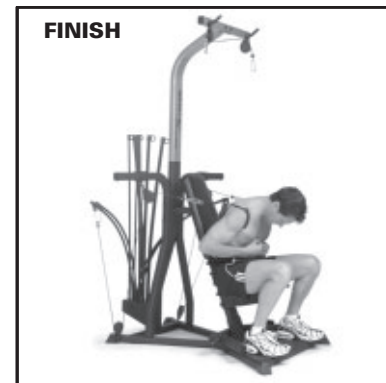

### START

- Attach the Abdominal Crunch Shoulder Harness by snapping one hook to each of the D rings. Place the harness on your shoulders letting the handles hang over your chest. Grab opposite handles so that your arms cross your chest.
- Lower back can start out flat or in normal arch, knees and hips bent and feet flat on floor.

### ACTION

- Tighten abs and curl only torso, slowly moving ribs toward hips. Move as far as you can without moving hips or neck. **LOWER BACK SHOULD NOT LOSE CONTACT WITH BENCH** when fully crunched.
- Slowly reverse motion returning to start position without relaxing.







# Leg Exercises

## Leg Extension

### Muscles worked:

All muscles on front of upper thigh (quadriceps muscle group).

### Position:

Seated – facing outward

### Accessory:

Leg Extension

### Pulleys:

Squat Pulley Frame

### Before You Begin:

Adjust seat height

### Key Points:

- Use slow controlled motion. Do not “kick” into extension.
- Do not let knees rotate out during exercise. Keep kneecaps pointing up and forward.



### START

- Sit on seat facing away from machine with knees near pivot point and lower roller pads on shins.
- Adjust thighs to hip width, pointing knee caps to front.
- Grasp sides of seat.
- Sit up straight with chest lifted, abs tight and a slight arch in lower back.

### ACTION

- Tighten quads and straighten legs by moving feet forward, then upward until legs are completely straight and knee-caps are pointing up toward the ceiling.
- Slowly return to start position keeping tension in quads during movement.

## Squat

### Muscles worked:

All muscles of legs and buttocks (gluteus maximus).

### Position:

Standing – facing outward

### Accessory:

Squat Bar – with squat straps

### Pulleys:

Squat Pulley Frame

### Before You Begin:

Remove Seat and Leg Extension

### Key Points:

- Make sure you do not bend waist or lower back.
- Keep abs tight throughout entire exercise.
- Keep knees pointed straight out in front of you.
- Never step off platform while under resistance.



### START

- Stand on platform, feet shoulder width apart.
- Squat down and place squat bar across shoulders. Adjust strap on bar to make sure you have resistance at start of movement.
- Keep spine in good posture, with chest lifted, abs tight and maintain a very slight arch in lower back.

### ACTION

- Slowly rise to standing position. Keep knees slightly bent.
- Slowly return to start position. Do not allow knees to exceed a 90° angle.





## Leg Exercises

### Standing Hip Extension – Knee Bent

**Muscles worked:**

Buttocks area (gluteus maximus).

**Position:**

Standing – facing machine

**Accessory:**

Hand Grip on arch

**Pulleys:**

Squat Pulley Frame

**Before You Begin:**

Remove Seat and Leg Extension

**Key Points:**

- Make sure all motion occurs at hip, NOT waist or lower back.
- Keep abs tight throughout entire exercise.
- Maintain exactly the same bend in the knee of moving leg throughout entire exercise.

**START**

- Secure hand grip around arch of foot. Keep this leg bent at approximately 90°.
- Hold onto seat back pad to stabilize yourself.
- Keep spine in good posture, chest lifted, abs tight. Maintain a slight arch in lower back.

**ACTION**

- Tighten glutes. Extend hip by moving entire leg backward.
- Slowly move leg as far as you can, without allowing ANY movement to occur at waist.
- Slowly return to start position.

### Standing Hip Extension – Knee Extended

**Muscles worked:**

Buttocks area (gluteus maximus).

**Position:**

Standing – facing machine

**Accessory:**

Hand Grip on arch

**Pulleys:**

Squat Pulley Frame

**Before You Begin:**

Remove Seat and Leg Extension

**Key Points:**

- Make sure all motion occurs at hip, NOT waist or lower back.
- Keep abs tight throughout entire exercise.
- Keep leg in same position – slightly away from body's midline through entire exercise.

**START**

- Secure hand grip around arch of foot. Move leg very slightly away from midline – enough to move leg freely.
- Very slightly bend knee of support leg.
- Hold onto seat back pad to stabilize yourself.
- Keep spine in good posture, chest lifted, abs tight. Maintain a slight arch in lower back.

**ACTION**

- Tighten glutes. Extend hip by moving entire leg backward.
- Slowly move leg as far as you can, without allowing ANY movement to occur at waist.
- Slowly return to start position.





# Leg Exercises

## Leg Kickback – Hip and Knee Extension

### Muscles worked:

Buttocks area (gluteus maximus).

### Position:

Standing – facing machine

### Accessory:

Hand Grip on arch

### Pulleys:

Squat Pulley Frame

### Before You Begin:

Remove Seat and Leg Extension

### Key Points:

- Do not allow waist, lower back or supportive hip to move.
- Keep abs tight throughout entire exercise.



START



FINISH

### START

- Secure cuff around arch of foot. Keep this leg bent at approximately 90°.
- Hold onto seat back pad to stabilize yourself.
- Keep spine in good posture, chest lifted, abs tight. Maintain a slight arch in lower back.

### ACTION

- Extend entire leg backward, straightening knee.
- Slowly move leg as far as you can, without allowing ANY movement to occur at waist.
- Slowly return to start position.

## Hip Flexion – Knee Flexion

### Muscles worked:

Muscles on front of hips (iliopsoas, rectus femoris).

### Position:

Standing to the left or right of machine facing away

### Accessory:

Hand Grip on ankle

### Pulleys:

Squat Pulley Frame

### Before You Begin:

Remove Seat and Leg Extension

### Key Points:

- Make sure all motion occurs at hip, NOT waist or lower back.
- Keep chest lifted and trunk muscles tight throughout entire exercise.
- Allow lower leg to hang in the direction of cable at all times.

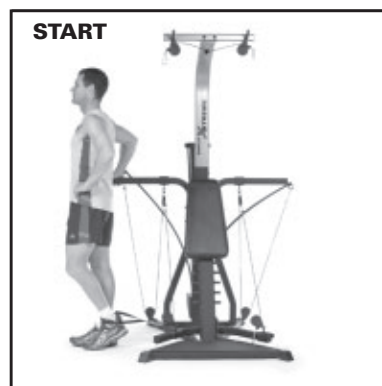

START



FINISH

### START

- Use Center Cross Bar as a stabilizer.
- Secure a hand grip around one of ankles.
- Straighten, but do not lock, knee of support leg.
- Keep spine in good posture, chest lifted, abs tight. Maintain a slight arch in lower back.

### ACTION

- Lift knee up and in toward torso.
- Allowing knee to bend as you move, bring knee up as far as you can, without allowing ANY movement to occur at waist or lower back.
- Slowly return to start position without resting leg muscles.



# Leg Exercises

## Dead Lift

### Muscles worked:

Buttocks area (gluteus maximus).

### Position:

Standing – facing outward

### Accessory:

Squat Bar

### Pulleys:

Squat Pulley Frame

### Before You Begin:

Remove Seat and Leg Extension

### Key Points:

- Make sure to keep back flat – do not arch.
- Lift with legs, not your back or arms.
- Keep knees bent and head up.



START



FINISH

### START

- Facing away from machine, grip squat bar using one hand with an underhand grip and the other hand with an overhand grip.
- Keep legs bent at 90°. Bend over 30-45° from hips (not waist).
- Keep spine in good posture, chest lifted, abs tight. Maintain a slight arch in lower back.

### ACTION

- Push up with legs.
- Slowly move up until you are in the standing position.
- Slowly return to start position.

## Stiff Leg Dead Lift

### Muscles worked:

Buttocks area (gluteus maximus) and hamstrings.

### Position:

Standing – facing outward

### Accessory:

Squat Bar

### Pulleys:

Squat Pulley Frame

### Before You Begin:

Remove Seat and Leg Extension

### Key Points:

- Make sure to keep your back flat – do not arch.
- Your motion is entirely at the hips NOT the waist.
- Keep knees slightly bent and head up.
- Use light weight.

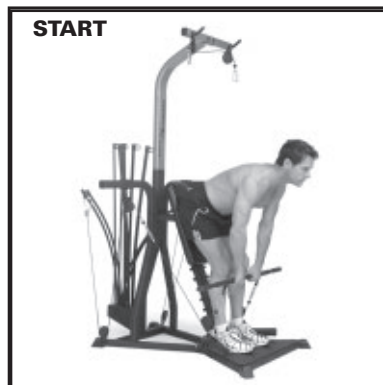

START



FINISH

### START

- Stand on platform. Grasp squat bar with palms facing down.
- Keep legs very slightly bent.
- Bend 90° from hips (not waist).
- Keep spine in good posture, chest lifted and abs tight. Maintain a slight arch in lower back.

### ACTION

- Push hips forward.
- Slowly move trunk up until you are in standing position. Glutes should be tight when reaching standing position.
- Slowly return to start position.



# Leg Exercises

## Standing Hip Adduction

### Muscles worked:

Insides of thighs (adductor muscle groups). Also, the outside of hip (gluteus medius) on support leg.

### Position:

Stand to left or right of machine – facing outward

### Accessory:

Hand Grip over ankle

### Pulleys:

Squat Pulley Frame

### Before You Begin:

Remove Seat and Leg Extension

### Key Points:

- Do not use exercise for losing fat from thighs. Use it to develop hip strength and stability.
- Do not cross attached leg in front of standing/support leg. Use a small range of motion. More is not better.
- Keep spine straight and hips level. Try not to raise hips when raising leg to side or drop the hip when returning to start position.



START



FINISH

### START

- Stand to one side of platform with one side near machine. Slide a hand grip over ankle nearest machine (inside leg).
- Stand straight, lift chest, tighten abs and maintain a slight arch in lower back.
- Adjust position away from machine so there is room to move attached leg toward pulley.

### ACTION

- Slowly allow attached leg to move in toward support leg (30-45°), keeping hips and spine still.
- Slowly draw leg back to start position.

## Standing Hip Abduction

### Muscles worked:

Sides of hips (gluteus medius), especially on the standing/support side.

### Position:

Stand to left or right of machine – facing outward

### Accessory:

Hand Grip over ankle

### Pulleys:

Squat Pulley Frame

### Before You Begin:

Remove Seat and Leg Extension

### Key Points:

- Do not use this exercise for losing fat from hips. It will not make hips smaller. Use it to develop hip strength and stability.
- Use a small range of motion. More is not better.
- Keep spine straight and hips level. Try not to raise hips when raising leg to the side.

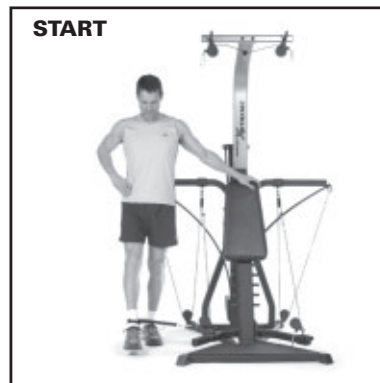

START



FINISH

### START

- Stand to one side of platform with one side near machine. Slide hand grip to ankle furthest from machine (outside leg).
- Stand up straight, lift chest, tighten abs and maintain a slight arch in lower back.
- Adjust position so there is some resistance in cables.

### ACTION

- Slowly move attached leg out to side away from pulley (30-45°), keeping hips and spine still.
- Slowly return to start position without relaxing muscles.







# Leg Exercises

## Calf Raise – Ankle Plantarflexion (Knee Stabilized)

### Muscles worked:

Lower leg or calf (gastrocnemius, soleus).

### Position:

Standing – facing machine

### Accessory:

Hand Grips

### Pulleys:

Squat Pulley Frame

### Before You Begin:

Remove Seat and Leg Extension

### Key Points:

- Do not lose contact between the balls of feet and the frame as you push.
- Do not change hip or knee position, ONLY ankle motion should be allowed.

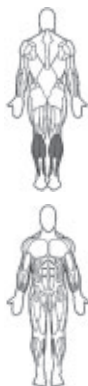

START



FINISH

### START

- Stand with toes on platform and heels hanging over edge.
- Use hand grips in both hands as resistance and a balance stabilizer.
- Lift chest, tighten abs and maintain a slight arch in lower back.

### ACTION

- Slowly press balls of feet into platform and lift heels up.
- Slowly return to start position.







# Muscle Chart

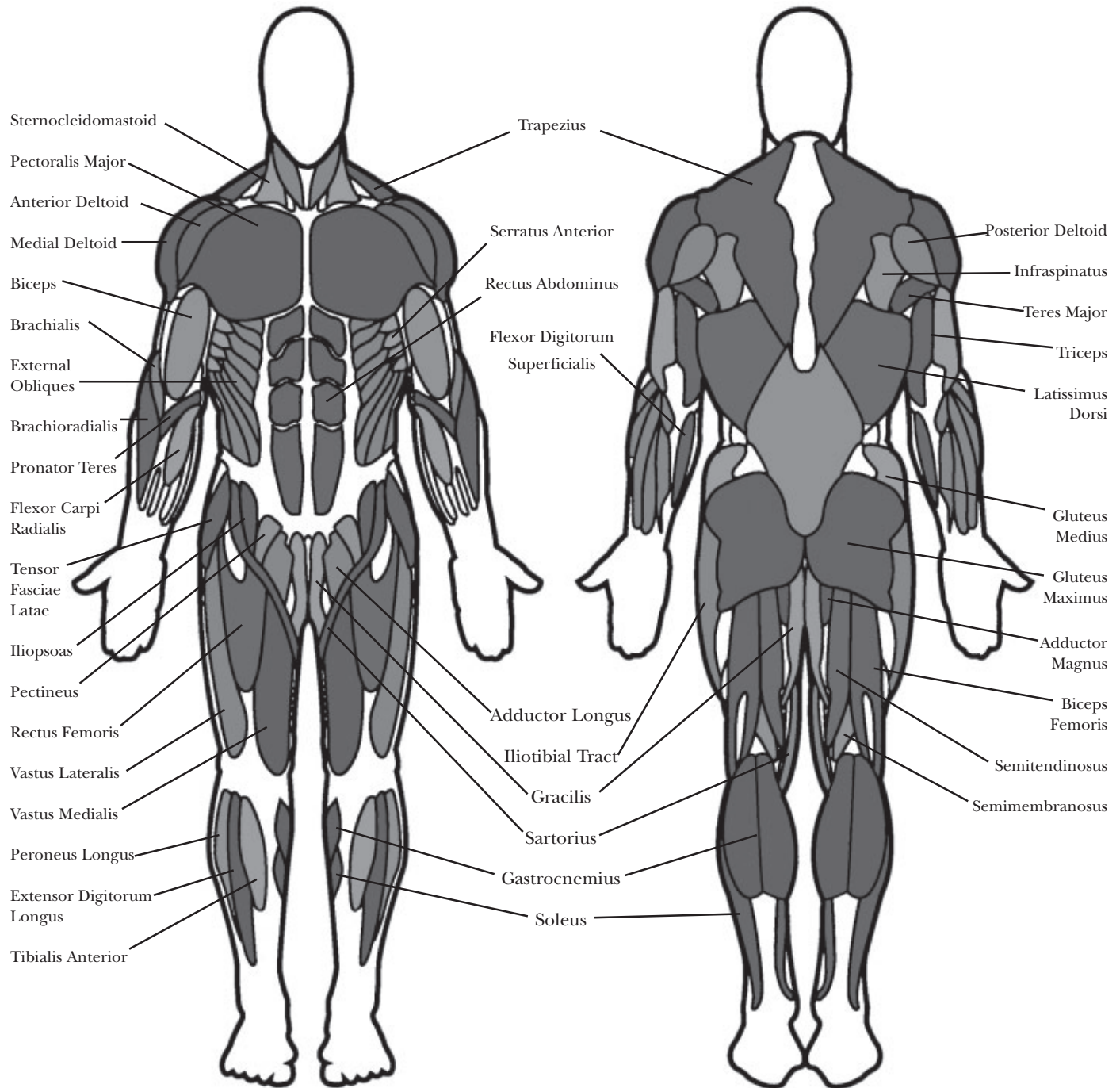



# Exercise Log

Please feel free to make copies of this chart to continue your exercise log.

EXERCISE	SETS	REPS	RESISTANCE	DATE	DATE	DATE	DATE	DATE
<i>Bench Press</i>	Sets	2						
	Reps	10, 9						
	Resistance	120, 130						
	Sets							
	Reps							
	Resistance							
	Sets							
	Reps							
	Resistance							
	Sets							
	Reps							
	Resistance							
	Sets							
	Reps							
	Resistance							
	Sets							
	Reps							
	Resistance							
	Sets							
	Reps							
	Resistance							
	Sets							
	Reps							
	Resistance							
	Sets							
	Reps							
	Resistance							



# *The Bowflex® Body Leanness Program*

By Ellington Darden, Ph.D.

The following program was created by Dr. Ellington Darden. It contains a rigorous fitness and dietary program. Please consult your physician before beginning any fitness or dietary program.

Some of the names of the exercises listed in this program have been changed in order to match the names of the exercises in this manual. The exercises themselves have *not* been changed, in order to preserve the integrity of Dr. Darden's Study.

**FAST FAT LOSS  
NOW!**





# ***A personal guarantee from Dr. Ellington Darden***

Dear Bowflex® Enthusiast,

I'm excited, really excited! I'm elated because I've researched and developed an exercise and eating program that produces fat loss faster than any plan I've ever tested.

For example, the men involved in my research project had an average fat loss of 27.95 pounds (12.68 kg) per man. Women on the same program averaged a reduction of 16.96 pounds (7.69 kg). **Best of all, these dramatic results were achieved – not in six months – but in only six weeks!**

**That's right – just six short weeks.** Similar results can be accomplished by you in six weeks when you follow my fitness and nutrition program.

## **Bowflex® home gyms were a significant part of my research results.**

The exercises in my program, performed on a Bowflex® machine – 18 workouts (3 per week) – allowed the participants to build muscle, which accelerated their metabolisms, and produced faster and greater fat losses. The plan worked so well that it became known as The Bowflex® Body Leanness Program.

Obtaining leanness means to strip away the fat from under the skin as well as at deeper levels. Leanness also implies a pleasing shape and tone to the skeletal muscles. You might say leanness is the opposite of fatness. The people involved in my research certainly got rid of their excessive fatness in record time.

All the guidelines that were applied to my research, including simple exercise instructions and specific menus to use, have been organized in the booklet you are now holding in your hands. It's the next best thing to actually going through one of my research projects. In fact, it's probably better since nothing is experimental. All of the fine points have been tried, tested and proven effective.

If you are overfat, and if you are interested in doing this program, there are several things you need to understand about my experience. Since 1965, I've trained more than 10,000 overfat individuals. After many years of pushing, coaxing, and listening to these trainees, certain traits became evident to me:

- People are not lazy by choice. They are forced into it by the confusion that surrounds the abundance of fitness information that is available. If these individuals are given simple decisive instructions, they will train very intensely.
- People, if they are provided with specific menus, will drastically alter their eating habits.
- Most of these people, however, will do neither of these challenging things for more than a week – unless they quickly see and feel changes in their body.

The Bowflex® Body Leanness Program emerged from these findings.

If you want to get the best-possible results from this program, you must be willing to exercise very intensely on the Bowflex® machine and adhere to a strict eating plan. In return, you'll get my guarantee that if you follow the program exactly as directed, you'll observe the pounds and inches disappear on almost a weekly basis.

Now it's your turn to get excited, and get started!

Sincerely,

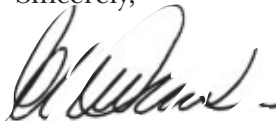

Dr. Ellington Darden





## Introduction

### The Bowflex® Body Leanness Program

This program is scientifically designed for maximal fat loss over a period of six weeks. It is important that you practice every aspect of the plan to achieve optimum results.

The program separates into three two-week stages. During each stage you will exercise, control the number and quality of calories you consume, and drink plenty of ice-cold water.

Before starting the exercise routine you must be familiar with your Bowflex® home gym. You should experiment with finding the proper amount of resistance to use on each exercise. You should be able to perform 8 repetitions, but not more than 12 repetitions, for each exercise. It is essential that you learn how to perform each movement before trying a complete circuit, because part of the effectiveness of the training depends on minimal rest between each exercise.

### **WARNING!**

Before beginning this program consult your physician or healthcare professional. Show this plan and your Bowflex® Owner's Manual to your physician or healthcare professional. Only he or she can determine if this course is appropriate for your particular age and condition. If you experience any light-headedness, dizziness, or shortness of breath while exercising, stop the movement and consult a physician.

***Make sure you read your Bowflex® Owner's Manual BEFORE attempting a workout.***

There are a few people who should not try this program: Children and teenagers; pregnant women; women who are breast feeding; diabetics; individuals with certain types of heart, liver, or kidney disease; and those suffering from certain types of arthritis. This should not be taken as an all inclusive list. Some people should follow the course only with their physician's specific guidance. Play it safe and consult a healthcare professional.



# Measurements

If you would like to measure your personal before-and-after results, there are several steps you need to take. It is important that you accurately perform each task, then at the end of the six-week program, repeat the process in the same manner.

## Body Weight:

Remove clothing and shoes and record your weight to the nearest quarter pound or hundred grams. Be sure to use the same scale when weighing yourself at the end of the six-week program. For the most accurate recordings, weigh yourself nude in the morning.

Since the program is divided into three two-week segments, you may want to weigh yourself at the end of each two-week period. Understand, however that weight loss is not the best way to determine your success. Fat loss is the key component. To determine the amount of fat you've lost, you'll need to follow the instructions in the next section.

Enter your starting weight on the RESULTS SUMMARY SHEET provided.

## Circumference of Body Parts:

For an even better idea of the changes that will occur to your body in the next six weeks, it is necessary to measure the circumference of certain body parts. This will tell you where the fat is shrinking and what areas are toning up.

Use a plastic tape to measure the following:

- 1) Upper arms – hanging and relaxed, midway between the shoulder and elbow.
- 2) 2" (5 cm) above navel – belly relaxed.
- 3) At navel – belly relaxed.
- 4) 2" (5 cm) below navel – belly relaxed.
- 5) Hips – feet together at maximum protrusion of buttocks.
- 6) Thighs – high, just below the buttocks crease with legs apart and weight distributed equally on both feet.

Record each measurement on your RESULTS SUMMARY SHEET.

## Women Measure:

Suprailium, triceps, and thigh.

## Men Measure:

Chest, abdomen, and thigh.

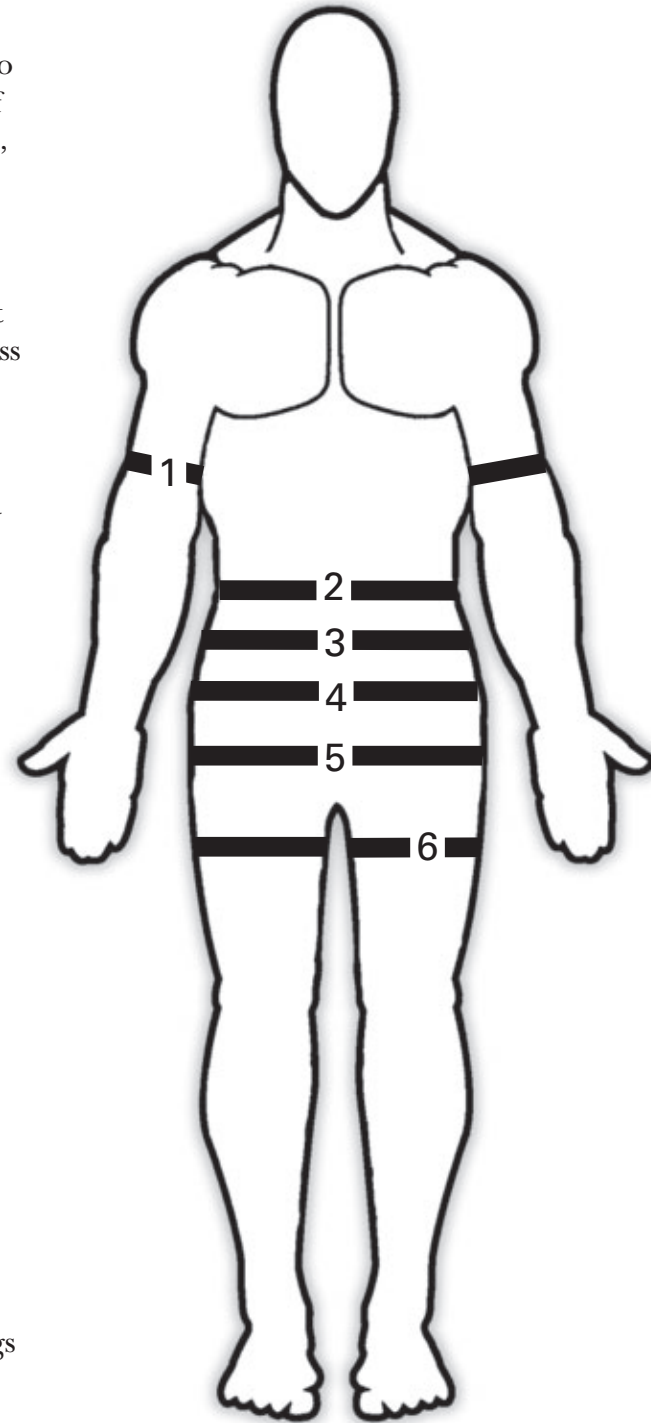



# Measurements

## Skinfold Measurements

To accurately track your progress through this six-week program, it is necessary to take skinfold measurements. By measuring yourself in this way, you will be able to determine your lean-body mass and your body-fat percentage. The goal of this program is to increase your lean-body mass and decrease your body-fat percentage.

Please read this section carefully. Proper measuring techniques are essential to track your success. It is best to have someone measure you. Measuring yourself can lead to inaccurate results.



### Suprailium

Stand relaxed. Pick up a diagonal skinfold just above the crest of the hip bone on the right side of the waist.



### Triceps

Stand with right elbow flexed 90 degrees and locate the center of the back of the upper arm midway between the shoulder and the elbow. Relax arm at your side. Pick up skinfold as pictured.



### Thigh

Stand relaxed with most of the weight on your left leg. Pick up a skinfold in the vertical plane on the front side of the right thigh, midway between the hip and knee joints.

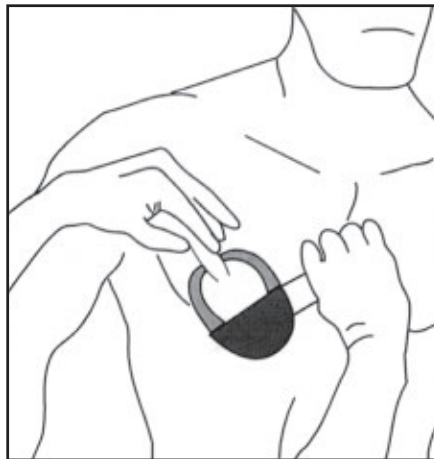

### Chest

Stand relaxed. Pick up a diagonal skinfold over the right pectoralis muscle, midway between the armpit and the nipple.



### Abdomen

Stand relaxed. Pick up a vertical skinfold on the right side of the navel.





# Measurements

## Using Calipers When Measuring Skinfolts

The procedure for measuring skinfold thickness is to grasp firmly with the thumb and forefinger a fold of skin and surface fat and pull it away from the underlying muscle. Take the caliper in your other hand and open the jaws. Clamp the jaws over the pinched skin and fat. The jaws exert constant tension at the point of contact with the skin. The thickness of the double layer of skin and fat can then be read directly from the caliper, which is marked in millimeters.

### Women

Suprailium \_\_\_\_\_

Triceps \_\_\_\_\_

Thigh \_\_\_\_\_

Total \_\_\_\_\_

### Men

Chest \_\_\_\_\_

Abdomen \_\_\_\_\_

Thigh \_\_\_\_\_

Total \_\_\_\_\_

Use these figures on the following chart to determine your body-fat percentage and enter the number on the line below.

Starting body-fat percentage \_\_\_\_\_

## Optional Picture Taking

Pictures can be the most exciting evaluation you can do. The numbers and the tape measurements are great, but actually seeing differences from comparison photographs of yourself is quite satisfying.

Taking full-length photographs is not difficult, but to see the maximum difference between before and after, you should follow these guidelines.

- 1) Keep everything the same. Wear the same outfit, a snug solid color is best, and have the person taking the picture stand in the same place, with the same setting behind you.
- 2) Make sure you stand against an uncluttered, light background.
- 3) Have the person taking the photograph move away from you until he can see your entire body in the viewfinder.
- 4) Stand relaxed for three pictures, front, right side, and back. Do not try to suck in your stomach.
- 5) Interlace your fingers and place them on top of your head, so the contours of your torso will be plainly visible. Keep your feet 8" (20 cm) apart in all three pictures.
- 6) When you get the film developed tell the processors to make your after photos the same size as your previous ones. This way, your height in both sets of photos is equal and more valid comparisons can be made.





# Determining Your Body Fat

## To Use The Nomogram:

- 1) Locate the sum of your three skinfolds in the right column and mark it.
- 2) Locate your age in years on the far left column and mark it.
- 3) Connect the two marks with a straightedge. Where the straightedge intersects the line in the middle column appropriate to you, you will find your body-fat percentage.

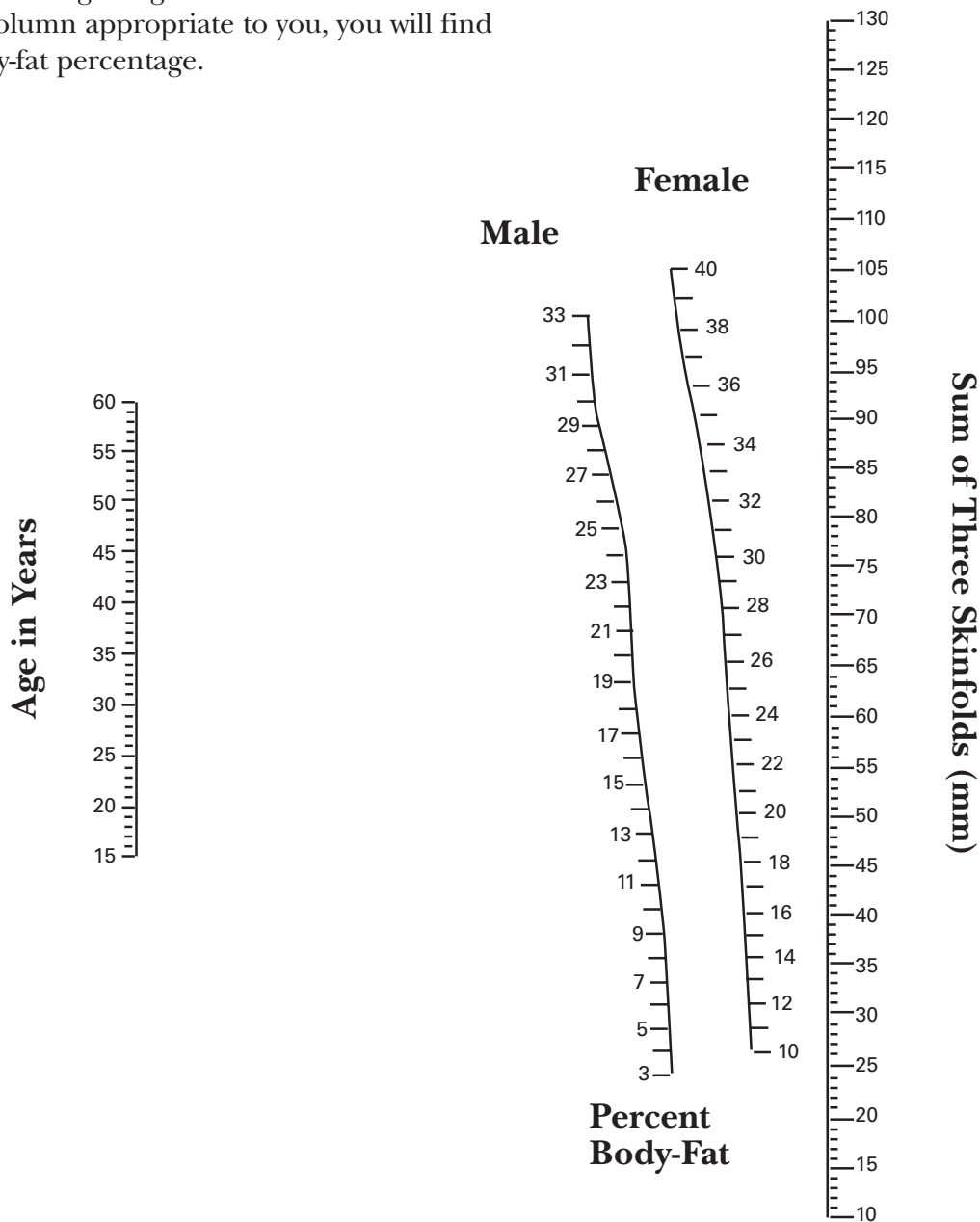

Baun, W.D, Baun, M.R., and Raven, P.B. A nomogram for the estimate of percent body fat from generalized equations. *Research Quarterly for Exercise and Sport*, 52:380-384, 1981.







## **Calculating Lean Body Mass**

Now that you know your body-fat percentage, you can calculate your lean-body percentage. This will eventually show you how many pounds of muscle were added to your body, after completing the program.

### **For Example:**

Before the program, Joe weighs 200 pounds (90.7 kg) and measures 30% fat, which amounts to 60 pounds (27.2 kg). Thus, his lean-body mass is 70%, or 140 pounds (63.5 kg).

After the program, Joe weighs 180 pounds (81.6 kg) and is 20% fat, which equals 36 pounds (16.3 kg). His lean-body mass is 80%, or 144 pounds (65.3 kg).

Simple calculations allow us to find the amount of fat Joe lost, and the amount of muscle Joe gained.

Before fat weight (60 pounds), minus after fat weight (36 pounds) equals 24 pounds (10.8 kg) of fat lost.

After lean-mass weight (144 pounds) minus before lean-mass weight (140 pounds) equals 4 pounds (1.8 kg) of muscle gained.

### **Enter Your Information Here: (Pounds or Kilograms)**

#### **Before**

Body Weight		Fat Percentage		Body Fat Weight
	X		=	
Body Weight		Weight of Body Fat		Lean-Body Weight
	-		=	

*Use the Same Factors to Calculate After Six Weeks.*

#### **After**

Body Weight		Fat Percentage		Body Fat Weight
	X		=	
Body Weight		Weight of Body Fat		Lean-Body Weight
	-		=	

#### **Final Results**

<i>Before</i> Body Fat Weight		<i>After</i> Body Fat Weight		Total Fat Lost
	-		=	
<i>After</i> Lean-Mass Weight		<i>Before</i> Lean-Mass Weight		Total Lean-Mass Gained
	-		=	





## ***Your Results Summary Sheet***

---

Name \_\_\_\_\_ Age \_\_\_\_\_

Height \_\_\_\_\_ Weight Loss \_\_\_\_\_

Weight Before \_\_\_\_\_ Muscle Gain \_\_\_\_\_

Weight After \_\_\_\_\_ Fat Loss \_\_\_\_\_

Please follow the instructions in the “Measurements” section for measuring circumferences.

<b><i>Measurements</i></b>	<b><i>Before</i></b>	<b><i>After</i></b>	<b><i>Difference</i></b>
Right Arm	_____	_____	_____
Left Arm	_____	_____	_____
2" (5 cm) Above Navel	_____	_____	_____
Navel	_____	_____	_____
2" (5 cm) Below Navel	_____	_____	_____
Hips	_____	_____	_____
Right Thigh	_____	_____	_____
Left Thigh	_____	_____	_____
		Total	_____
Percent Body Fat	_____	_____	_____

If you wish to send in your results to Nautilus, Inc., please send to: Bowflex® Results, Nautilus, Inc. World Headquarters, 16400 S.E. Nautilus Drive, Vancouver, WA 98683.

Or you may fax this sheet to Bowflex® Results at 1-360-694-7755. Please include your name, address, and phone number. Submissions may be selected for use in promotional marketing materials.



# The Workouts

## GUIDELINES Week 1&2

All exercises should be practiced with one set of 8 to 12 repetitions. The style of performance is very important. The movement for each repetition should be 4 seconds in the positive phase and 4 seconds in the negative. Keep the motion slow and smooth. When 12 repetitions are accomplished, increase the resistance by approximately 5 percent. Keep the time between exercises to a minimum, no longer than **60** seconds. No workout should take more than 30 minutes to complete. Perform each workout three days a week.

Exercise	Sets	Reps
Leg Curl	1	8-12
Leg Extension	1	8-12
Bench Press	1	8-12
Lying Biceps Curl	1	8-12
Seated Shoulder Press	1	8-12
Seated Abdominal Crunch	1	8-12

## GUIDELINES Week 3&4

All exercises should be practiced with one set of 8 to 12 repetitions. The style of performance is very important. The movement for each repetition should be 4 seconds in the positive phase and 4 seconds in the negative. Keep the motion slow and smooth. When 12 repetitions are accomplished, increase the resistance by approximately 5 percent. Keep the time between exercises to a minimum, no longer than **45** seconds. No workout should take more than 30 minutes to complete. Perform each workout three days a week.

Exercise	Sets	Reps
Leg Curl	1	8-12
Leg Extension	1	8-12
Bench Press	1	8-12
Lying Biceps Curl	1	8-12
Seated Shoulder Press	1	8-12
Rear Deltoid Rows*	1	8-12
Seated Triceps Extension	1	8-12
Seated Abdominal Crunch	1	8-12

## GUIDELINES Week 5&6

All exercises should be practiced with one set of 8 to 12 repetitions. The style of performance is very important. The movement for each repetition should be 4 seconds in the positive phase and 4 seconds in the negative. Keep the motion slow and smooth. When 12 repetitions are accomplished, increase the resistance by approximately 5 percent. Keep the time between exercises to a minimum, no longer than **30** seconds. No workout should take more than 30 minutes to complete. Perform each workout three days a week.

Exercise	Sets	Reps
Leg Curl	1	8-12
Leg Extension	1	8-12
Leg Press	1	8-12
Bench Press	1	8-12
Lying Biceps Curl	1	8-12
Lying Shoulder Pullover	1	8-12
Reverse Fly	1	8-12
Rear Deltoid Rows*	1	8-12
Seated Triceps Extension	1	8-12
Seated Abdominal Crunch	1	8-12

\* The Upright Row exercise was used in Dr. Darden's original study. Although many people have used this exercise for years, recent information in the Physical Therapy field has caused the authors of this manual to caution against performing this exercise because of the unnatural twisting movement created in the shoulder joint. We suggest you substitute Rear Deltoid Rows for the upright Row exercise.

# Eating Guidelines

You will be following a reduced-calorie nutrition program, which is divided into three two-week segments. The program is a proven method for achieving maximal fat loss over a six-week period. It consists of a carbohydrate-rich, descending-calorie eating plan and a superhydration routine.

## Follow a Carbohydrate-Rich, Descending-Calorie Eating Plan:

Approximately 60 percent of the daily calories should be from carbohydrates. The other 40 percent will be equally divided between proteins and fats. The 60:20:20 ratio of carbohydrates, proteins, and fats is ideal for maximum fat loss.

## Keep Menus Simple and Food Substitutions to a Minimum:

Research has established that successful dieters prefer the same foods each day for breakfast and lunch. They like variety, however, for dinner. Detailed menus and food choices are included later in this manual.

If you must vary from the menu items, try to stay within the 60:20:20 ratio of carbohydrates, proteins and fats.

For Example			
Daily Amount	Carbohydrate	Protein	Fat
Calories	60%	20%	20%
2000	1200	400	400
1900	1140	380	380
1800	1080	360	360
1700	1020	340	340
1600	960	320	320
1500	900	300	300
1400	840	280	280
1300	780	260	260
1200	720	240	240
1100	660	220	220
1000	600	200	200

## Avoid Too Much Stress:

Too much stress of any kind can cause the body to actually preserve fat stores. You should relax more. An after-dinner walk at a leisurely pace is helpful. Extra sleep is suggested, since sleep facilitates fat loss and muscle recovery. Furthermore, to keep the body well rested, ***no other exercises or activities are allowed during the six-week program.*** This is a scientifically proven program that works. More is not better. Any additional exercise other than the amount recommended can and will harm your fat loss.



## Superhydrate Your System

Drinking plenty of water is essential to the success of this program. Drinking the recommended amount of water can seem like a challenge at first. Stick with it. Carry a large sports bottle or similar item with you throughout the day. After several weeks, you will find that you actually thirst for more and more water, and the amounts recommended are easily reached.

Superhydration aids fat loss in a number of ways. First, the kidneys are unable to function without adequate water. When they do not work to capacity some of their load is dumped onto the liver.

This diverts the liver from its primary function, which is to metabolize stored fat into usable energy. Because it's performing the chores of the water-depleted kidneys, the liver metabolizes less fat.

Second, overeating can be averted through water intake, as water can keep the stomach feeling full and satisfied between meals.

Third, ice-cold water requires calories to warm it to core body temperature. In fact, **1 US gallon of ice cold water (3.8 l) generates 123 calories of heat energy.**

You'll be drinking from 1 to 1 5/8 US gallons (3.8 - 6.2 l) of water each day on the following superhydration schedule:

**Week 1** = drink four 32-oz. bottles (3.8 l) of ice-cold water per day.

**Week 2** = drink four and a half 32-oz. bottles (4.3 l) of ice-cold water per day.

**Week 3** = drink five 32-oz. bottles (4.6 l) of ice-cold water per day.

**Week 4** = drink five and a half 32-oz. bottles (5.2 l) of ice-cold water per day.

**Week 5** = drink six 32-oz. bottles (5.7 l) of ice-cold water per day.

**Week 6** = drink six and a half 32-oz. bottles (6.2 l) of ice-cold water per day.

Don't be surprised if you have to make more than a dozen trips to the restroom, especially during the first week of the program. Remember, your body is an adaptive system, and it will soon accommodate the increased water consumption.

**Note:** *Although it is doubtful that you could ever drink too much water, a few ailments can be negatively affected by large amounts of fluid. For example, anyone with a kidney disorder, or anyone who takes diuretics, should consult a physician before going on the recommended water-drinking schedule. If you have any doubts about the recommendations, play it safe and check with your doctor.*







## The Eating Plan

The menus in the Bowflex® eating plan are designed for maximum fat-loss effectiveness and nutritional value. For best results, follow them exactly.

Every attempt has been made to utilize current popular brand names and accurate calorie counts, which are listed in the menus. But as you probably realize the products are sometimes changed or discontinued. If a listed item is not available in your area, you'll need to substitute a similar product. Become an informed label reader at your supermarket. Ask questions about any products you don't understand. Supermarket managers are usually helpful. If they don't have an answer to your question, they will get it for you.

Each day you will choose a limited selection of foods for breakfast and lunch. Most people can consume the same basic breakfast and the same basic lunch for months with little modification. Ample variety during your evening meal, however, will make daily eating interesting and enjoyable. Additionally, the eating plan includes a mid-afternoon and late-night snack to keep your energy high and your hunger low.

Begin Week 1 on Monday and continue through Sunday. Week 2 is a repeat of Week 1.

Calories for each food are noted in parentheses. A shopping list follows.

The eating plan for the next six weeks descends:

**Week 1 & 2:**

Men 1500 calories per day.

Women 1200 calories per day.

**Week 3 & 4:**

Men 1400 calories per day.

Women 1100 calories per day.

**Week 5 & 6:**

Men 1300 calories per day.

Women 1000 calories per day.

You'll always have a 300 calorie breakfast, a 300 calorie lunch, and a 300 calorie dinner (women), or 500 calorie dinner (men). With each two-week descend, only your snack calories will change: from 400 to 300 to 200 calories per day (men), or 300 to 200 to 100 calories per day (women). For each of your five daily meals, you'll have at least three choices.

Everything has been simplified so even the most kitchen-inept man or woman can succeed. Very little cooking is required. All you have to do is read the menus, select your food choices, and follow the directions. It's as simple as that.

If you find that you wish to vary from the outline menu items try to stay with in the 60:20:20 ratio of carbohydrates, proteins, and fats.

# The Eating Plan - US Measurements

## Breakfast = 300 calories

### Choice of bagel, cereal or shake.

#### Bagel

1 plain bagel (frozen) (210)  
3/4 oz. light cream cheese (45)  
1/2 C. orange juice, fresh or frozen (55)  
Any beverage without calories, caffeine, or sodium, such as decaffeinated coffee or tea.

#### Cereal

1.5 oz. (42 grams) serving equals approximately 165 calories.  
Choice of one: Kellogg's® Low Fat Granola (without raisins), General Mills® Honey Nut Clusters, General Mills® Basic 4  
1/2 C. skim milk (45)  
3/4 C. orange juice (82)  
Noncaloric beverage

#### Shake (choice of one shake)

Place ingredients in blender. Blend until smooth.

#### Banana-Orange Shake

1 large banana (8 3/4 inches long) (100)  
1/2 C. orange juice (55)  
1/2 C. skim milk (45)  
2 T. wheat germ (66)  
1 t. safflower oil (42)  
2 ice cubes (optional)

#### or Chocolate or Vanilla Shake

1 packet Carnation® Instant Breakfast, Champion UltraMet®, or another diet shake powder that contains the appropriate calories (100)  
1 C. skim milk (90)  
1/2 large banana (8 3/4 inches long) (50)  
1 t. safflower oil (42)  
1 t. Carnation® Malted Milk powder (20)  
2 ice cubes (optional)

## Lunch = 300 calories.

### Choice of sandwich, soup or salad.

#### Sandwich

2 slices whole wheat bread (140)  
2 t. Promise Ultra® Vegetable Oil Spread (24)  
2 oz. white meat (about 8 thin slices), chicken or turkey (80)  
1 oz. fat-free cheese (1 1/2 slices) (50)  
(Opt.: Add to bread 1 t. Dijon mustard (0)  
Noncaloric beverage

#### Soup (choice of one soup)

• Healthy Choice® Hearty Chicken, 15-oz. can (260), or  
• Campbell's® Healthy Request Hearty Vegetable Beef, 16-oz. can (260)  
1/2 slice whole-wheat bread (35)  
Noncaloric beverage

#### Chef Salad

2 C. lettuce, chopped (20)  
2 oz. white meat, chicken or turkey (80)  
2 oz. fat-free cheese (100)  
4 slices tomato, chopped (28)  
1 T. Italian, fat-free dressing (6)  
1 slice whole wheat bread (70)  
Noncaloric beverage

## Mid-Afternoon Snack

**Men**—200 calories for Weeks 1&2;  
150 calories for Weeks 3&4;  
100 calories for Weeks 5&6.

**Women**—150 calories for Weeks 1&2;  
100 calories for Weeks 3&4;  
50 calories for Weeks 5&6.

#### Choose calories from:

1 large banana (8 3/4 inches long) (100)  
1 apple (3-inch diameter) (100)  
1/2 cantaloupe (5-inch diameter) (94)  
5 dried prunes (100)  
1 oz. (2 small 1/2 oz. boxes) raisins (82)  
1 C. light, nonfat, flavored yogurt (100)

## Dinner

**Men**—500 calories, **Women**—300 calories

### Choice of tuna salad dinner, steak dinner or frozen microwave dinner.

#### Tuna Salad Dinner

In a large bowl, mix the following:  
1 6-oz. can chunk light tuna in water (180)  
1 T. Hellmann's® Light, Reduced-Calorie Mayonnaise (50)  
2 T. sweet pickle relish (40)  
1/4 C. whole kernel corn, canned, no salt added (30)  
Noncaloric beverage

#### Men add:

1/2 C. sliced white potatoes, canned (45)  
2 slices whole wheat bread (140)

#### Steak Dinner

3 oz. lean sirloin, broiled (176)  
1/2 C. sweet peas, canned, no salt added (60)  
1/2 C. beets, canned (35)  
1/2 C. skim milk (45)  
Noncaloric beverage

#### Men add:

2 slices whole wheat bread (140)  
1 t. Promise Ultra® Vegetable Oil Spread (12)  
1/2 C. skim milk (45)

#### Frozen Microwave Dinner

##### Choice of one meal:

• Glazed Chicken Dinner, Lean Cuisine® (230)  
2/3 C. skim milk (60)  
Noncaloric beverage  
• Lasagna with Meat Sauce, Lean Cuisine® (240)

1/2 C. skim milk (45)

Noncaloric beverage

• Macaroni and Cheese, Weight Watchers® (260)

1/2 C. skim milk (45)

Noncaloric beverage

• Broccoli & Cheddar Cheese Sauce over Baked Potato, Lean Cuisine® Lunch Express (250)

1/2 C. skim milk (45)

Noncaloric beverage

• Grilled Turkey Breast, Healthy Choice® (260)

1/2 C. skim milk (45)

Noncaloric beverage

#### Men add:

2 slices whole wheat bread (140)

2 t. Promise Ultra® Vegetable Oil Spread (24)

1/2 C. skim milk (45)

## Late-Night Snack

**Men**—200 calories for 1&2; 150 calories for Weeks 3&4; 100 calories for Weeks 5&6.

**Women**—150 calories for Weeks 1&2; 100 calories for Weeks 3&4; 50 calories for Weeks 5&6.

#### Choose calories from afternoon snack selections plus the following:

1/2 C. low-fat frozen yogurt (100)  
2 C. light, microwave popcorn (100)



## The Eating Plan - Metric Measurements\*

**Breakfast = 300 calories**

### Choice of bagel, cereal or shake.

#### Bagel

1 plain bagel (frozen) (210)  
21 g light cream cheese (45)  
120 ml orange juice, fresh or frozen (55)  
Any beverage without calories, caffeine, or sodium, such as decaffeinated coffee or tea.

#### Cereal

42 gram serving equals approximately 165 calories.  
Choice of one: Kellogg's® Low Fat Granola (without raisins), General Mills® Honey Nut Clusters, General Mills® Basic 4  
120 ml skim milk (45)  
177 ml orange juice (82)  
Noncaloric beverage

#### Shake (choice of one shake)

Place ingredients in blender. Blend until smooth.

#### Banana-Orange Shake

1 large banana (22 cm long) (100)  
120 ml orange juice (55)  
120 ml skim milk (45)  
15 ml wheat germ (66)  
5 ml safflower oil (42)  
2 ice cubes (optional)

#### or Chocolate or Vanilla Shake

1 packet Carnation® Instant Breakfast, Champion UltraMet®, or another diet shake powder that contains the appropriate calories (100)  
240 ml skim milk (90)  
1/2 large banana (22 cm long) (50)  
5 ml safflower oil (42)  
5 ml Carnation® Malted Milk powder (20)  
2 ice cubes (optional)

**Lunch = 300 calories.**

### Choice of sandwich, soup or salad.

#### Sandwich

2 slices whole wheat bread (140)  
10 ml Promise Ultra® Vegetable Oil Spread (24)  
57 g white meat (about 8 thin slices), chicken or turkey (80)  
28 g fat-free cheese (1 1/2 slices) (50)  
(Opt.: Add to bread 5 ml Dijon mustard (0)  
Noncaloric beverage

#### Soup (choice of one soup)

- Healthy Choice® Hearty Chicken, 420 g can (260), or
- Campbell's® Healthy Request Hearty Vegetable Beef, 450 g can (260)  
1/2 slice whole-wheat bread (35)  
Noncaloric beverage

#### Chef Salad

480 ml lettuce, chopped (20)  
57 g white meat, chicken or turkey (80)  
57 g fat-free cheese (100)  
4 slices tomato, chopped (28)  
15 ml Italian, fat-free dressing (6)  
1 slice whole wheat bread (70)  
Noncaloric beverage

### Mid-Afternoon Snack

**Men**—200 calories for Weeks 1&2;

150 calories for Weeks 3&4;

100 calories for Weeks 5&6.

**Women**—150 calories for Weeks 1&2;

100 calories for Weeks 3&4;

50 calories for Weeks 5&6.

#### Choose calories from:

1 large banana (22 cm long) (100)  
1 apple (7.6 cm diameter) (100)  
1/2 cantaloupe (12.7 cm diameter) (94)  
5 dried prunes (100)  
28 g (2 small 14 g. boxes) raisins (82)  
240 ml light, nonfat, flavored yogurt (100)

### Dinner

**Men**—500 calories, **Women**—300 calories

### Choice of tuna salad dinner, steak dinner or frozen microwave dinner.

#### Tuna Salad Dinner

In a large bowl, mix the following:  
1 can (170 g) chunk light tuna in water (180)  
15 ml Hellmann's® Light, Reduced-Calorie Mayonnaise (50)  
30 ml sweet pickle relish (40)  
60 ml whole kernel corn, canned, no salt added (30)  
Noncaloric beverage  
**Men add:**  
120 ml sliced white potatoes, canned (45)  
2 slices whole wheat bread (140)

#### Steak Dinner

85 g lean sirloin, broiled (176)  
120 ml sweet peas, canned, no salt added (60)  
120 ml beets, canned (35)  
120 ml skim milk (45)  
Noncaloric beverage

#### Men add:

2 slices whole wheat bread (140)  
5 ml Promise Ultra® Vegetable Oil Spread (12)  
120 ml skim milk (45)

#### Frozen Microwave Dinner

##### Choose one meal:

- Glazed Chicken Dinner, Lean Cuisine® (230)  
160 ml skim milk (60)  
Noncaloric beverage
- Lasagna with Meat Sauce, Lean Cuisine® (240)  
120 ml skim milk (45)  
Noncaloric beverage
- Macaroni and Cheese, Weight Watchers® (260)  
120 ml skim milk (45)  
Noncaloric beverage
- Broccoli & Cheddar Cheese Sauce over Baked Potato, Lean Cuisine® Lunch Express (250)  
120 ml skim milk (45)  
Noncaloric beverage
- Grilled Turkey Breast, Healthy Choice® (260)  
120 ml skim milk (45)  
Noncaloric beverage

#### Men add:

2 slices whole-wheat bread (140)  
10 ml Promise Ultra® Vegetable Oil Spread (24)  
120 ml skim milk (45)

### Late-Night Snack

**Men**—200 calories for 1&2; 150 calories for Weeks 3&4; 100 calories for Weeks 5&6.

**Women**—150 calories for Weeks 1&2; 100 calories for Weeks 3&4; 50 calories for Weeks 5&6.

#### Choose calories from afternoon snack selections plus the following:

120 ml low-fat frozen yogurt (100)  
240 ml light, microwave popcorn (100)

\* Nutritionally equivalent products with similar calorie counts may be substituted if recommended products cannot be found.





# Shopping List

---

Quantities needed for listed items will depend on your specific selections. Review your choices and adjust the shopping list accordingly. It may be helpful for you to photocopy this list each week before doing your shopping.

## Staples

Orange juice, skim milk, whole-wheat bread, Promise Ultra® Vegetable Oil Spread, Italian fat-free dressing, Dijon mustard, safflower oil, noncaloric beverages (tea, decaffeinated coffee, diet soft drinks, water).

## Grains

Bagels, Sarah Lee (frozen)

Cereals – 1.5 oz. (42 g) serving equals approximately 165 calories; Kellogg's® Low-Fat Granola (without raisins), General Mills® Honey Nut Clusters, General Mills® Basic 4.

Wheat germ, malted milk powder, popcorn (microwave light).

## Fruits

Bananas, large (8 3/4 inches [22 cm] long), apples (3-inch [7.6 cm] diameter), cantaloupes (5-inch [12.7 cm] diameter), dried prunes, raisins.

## Vegetables

Lettuce, tomatoes, whole kernel corn (canned no salt added), sweet peas, (canned no salt added), sliced white potatoes (canned), cut beets (canned).

## Dairy

Yogurt (light nonfat), cream cheese (light), cheese (fat-free), low-fat frozen yogurt, Carnation® Instant Breakfast packets, Champion UltraMet® Packets.

## Meat, Poultry, Fish and Entrees

Chicken (thin sliced), turkey (thin sliced), tuna (canned in water), sirloin steak (lean).

## Canned soup

Healthy Choice® Hearty Chicken, Campbell's® Healthy Request Hearty Vegetable Beef.

## Frozen microwave dinners or entrees:

Lean Cuisine® Glazed Chicken Dinner, Lean Cuisine® Lasagna with Meat Sauce, Lean Cuisine® Lunch Express Broccoli & Cheddar Cheese over Potato, Weight Watchers® Macaroni and Cheese, Healthy Choice® Grilled Turkey Breast.



## Q & A

**Q. I often get headaches when I eat only 1000 calories a day. What should I do?**

A. Your headaches may be caused by going longer than three hours between meals or snacks. Try spacing your meals and snacks where there are fewer hours between them.

Some people who are used to drinking regular coffee with caffeine notice headaches when they stop consuming coffee for several days. If this is the case with you, you might want to ease off the coffee more gradually.

**Q. I don't like red meat. I notice that the Lean Cuisine® Lasagna with Meat Sauce contains beef. What can I substitute for it?**

A. Lean Cuisine® has many other frozen dinners that you may substitute for Lasagna with Meat Sauce. Try to find one that contains the same calories, with approximately 15 to 20 percent of the calories coming from fat. Some of the Lean Cuisine® dinners actually have too little fat for my nutritional requirements.

**Q. May I have dinner for lunch and lunch for dinner?**

A. Yes.

**Q. I tend to get a headache when I drink cold water. Can I drink water without it being chilled?**

A. Yes, but you won't get the 123 calories or more thermogenic effect from warming the cold water to core body temperature. Try a more gradual drinking of the cold water. You may have been consuming it too quickly.

**Q. Is it possible to drink too much water?**

A. Certainly. To do so, however, you'd probably have to drink four or five times as much per day as I'm recommending. There are a few ailments that can be negatively affected by large amounts of fluid. If you feel you have a problem, check with your doctor before starting the program.

**Q. Is bottled water better than tap water?**

A. Research shows that bottled water is not always higher quality water than tap water. The decision to drink bottled water or not is usually one of taste. If you dislike the taste of your tap water, then drink your favorite bottled water. But first you might want to try a twist of lemon or lime added to the

water from your tap. Some people say it makes a significant difference in the taste.

**Q. I'm a middle-aged woman who gets black and blue marks on my legs when I diet. Am I doing anything wrong?**

A. I doubt you are doing anything wrong. Such black and blue marks are usually the result of an increased level of estrogen circulating in your body, which weakens the walls of the capillaries and causes them to break under the slightest pressure. When this happens, blood escapes and a bruise occurs. Estrogen is broken down in the liver, and so is fat. When you are dieting, your liver breaks down the fat, leaving a lot more estrogen in the bloodstream.

It may be helpful to supplement your diet with a little extra vitamin C each day to help toughen the walls of the capillaries.

**Q. I'm a 40 year-old woman with a teenage son and daughter. My husband and I both want to lose 10 pounds (4.5 kg) and the children would also like to lose some weight. Can I put the whole family on the program?**

A. It would be great if you could, but you cannot. The number of calories per day is the problem. Teenagers require significantly more calories each day than 1500, which is the highest level. Check with a registered dietician (RD) for appropriate recommendations.

Your teenage son and daughter, however, could follow the Bowflex® exercise routines.

**Q. I'm afraid that I might get large, unfeminine muscles from some of the Bowflex® exercises you recommend in this course. What can I do to prevent this from happening?**

A. You are worrying about large muscles unnecessarily. Building large muscles requires two conditions. First, the individual must have long muscles and short tendons. Second, an abundance of testosterone must be present in the blood stream. Women almost never have either of these conditions.

Under no circumstances could 99.99 percent of American women develop excessively large muscles. Progressive resistance exercise such as using a Bowflex® Xceed™ home gym will make your muscles larger – but not excessively large – and larger muscles will make your body firmer and more shapely.





## Q & A

**Q. Why is it so important I perform the Bowflex® exercises with a 4-second count on the lifting and lowering?**

A. Because a slow, smooth 4-second lifting followed by a 4-second lowering involves more muscle fibers more thoroughly than faster speeds of movement. The more completely each involved muscle fiber works simply means you'll get better muscle-building results.

**Q. I'm confused about how to breathe during each Bowflex® exercise?**

A. Let's say your goal is to do 10 repetitions on a specific Bowflex® exercise that is performed in the recommended 4-second lifting and 4-second lowering style. Here are the proper breathing guidelines to follow:

- Breathe normally during the first five repetitions.
- Take shorter, more shallow breaths during the sixth, seventh, and eighth repetitions.
- Emphasize exhalation more than inhalation, especially during the ninth and tenth repetitions. Focus on good form and slow movement.
- Do not hold your breath on any repetition. Practice relaxing your face and neck. Do not grit your teeth. Keep your eyes open and remain alert.

**Q. I'm not as disciplined and patient as I'd like to be. How can I better stay on track with the program?**

A. One suggestion is to team up with a partner. Most people are more motivated and make better progress if they go through the program with a friend. In selecting a training partner, here are several things to keep in mind:

- Your partner should be similar to you in age and condition.
- Your partner should be serious about getting into shape and making a commitment. That commitment means you'll be exercising together one hour, three times per week. Each of your joint training sessions should take approximately 50 minutes: 25 minutes for your workout and 25 minutes supervising your partner's workout.
- Your partner should be someone with whom you'll share a spirit of cooperation, not competition.
- Your partner should not be your spouse, brother,

sister, or other family member. You do not want normal interpersonal problems to interfere with the training.

**Q. Why won't you allow me to do aerobic dancing on my off-days to speed up the loss of body fat?**

A. Because doing so doesn't speed up fat loss. Aerobic dancing – and other activities such as running, swimming, cycling, stair-stepping, and racquetball – do not contribute significantly to the fat-loss process. In fact, when added to proper strength training they can actually retard the reduction of fat.

Fat loss is retarded in two ways. Too much repetitive activity prevents maximum muscle building by using up your recover ability. A well-rested recover ability is necessary for muscle growth. Too much activity – especially if you are on a reduced-calorie diet – causes you to get the blahs and quickly lose your enthusiasm. If this happens, you're sure to break your diet.

The primary purpose of this program is to lose fat in the most effective and most efficient manner. Fat loss is prioritized and maximized by building muscle at the same time. The muscle-building process is optimized by a well-rested recovery ability, which necessitates keeping your strenuous and moderately strenuous activities to a bare minimum.

Once you get your body fat to a low level, you can add other activities – and I encourage you to do so – to your weekly fitness schedule. For now, follow the plan exactly as directed.

**Q. What happens after six weeks? How do I continue the program if I need to lose more weight?**

A. You should repeat the program for as long as it takes you to reach your goal. For example, it took Barry Ozer three six-week sessions – 18 weeks – to lose all of his excessive fat, which amounted to 75 pounds (34 kg). There are, however, a few guidelines and modifications to apply.

Repeat the eating plan exactly as before: Men, go back to 1500 calories a day for two weeks. Women, go back to 1200 calories a day for two weeks. Then, descend your calories in the same manner.

Keep your superhydration schedule at the highest level. In other words, sip 1 5/8 gallons (6.2 l) of ice-cold water each day.





## Q & A

Continue your Bowflex® exercise routine at the highest level. Perform the same 10 exercises three times per week. Try to get as strong as you can in each exercise, while always focusing on the 4-second count in both lifting and lowering.

### **Q. I'm pleased that I lost the fat I wanted to lose. What do I do to maintain my new body weight?**

A. Once you've lost your excessive fat, your next task is to maintain that status. Here are the adjustments you need to make to your current practices.

#### **Adhere to a carbohydrate-rich, moderate-calorie eating plan.**

Instead of eating from 1000 to 1500 calories a day, you'll be consuming from 1600 to 2400 calories per day. Maybe you can eat even more after your new body weight has stabilized. Trial-and-error experimentation is a must. Women should start with 1600 calories, and men with 2000 calories per day. Note what happens after a week. If your body weight keeps going down, raise the calories by 100 or 200, depending on how much weight you lost during the last week. Soon, you should reach a level where your body weight stabilizes. That level is your daily calorie requirement. Naturally, you'll be able to consume other foods than those listed in the Bowflex® eating plan. By then, however, you should know the value of being a smart shopper and a wise eater. Read labels. Compare nutritional information. Be conscious of the ideal 60:20:20 ratio for carbohydrates, proteins, and fats.

#### **Eat smaller meals more frequently.**

You've been limiting your five meals per day to 300 calories if you're a woman, or 500 calories if you're a man. You may now up the calories by 100. What happens if during a single meal you eat more than 400 calories if you're a woman, or 600 calories if you're a man? Don't panic. Simply understand that you will sometimes backslide. Learn to anticipate these urges and take corrective action.

Drink at least 1 gallon (3.8 l) of cold water each day.

You should realize by now the benefits of consuming plenty of water each day. Make your water bottle a permanent part of your lifestyle.

#### **Train on Bowflex® home gym at least twice a week.**

There are two primary differences between maintenance and strength-building routines. First, for maintenance, you do not have to increase the

resistance each week or so. If you can do 100 pounds for 12 repetitions on the leg extension, then keep it on 100 pounds and do not go up to 105 pounds. You can maintain the 100-pound level much easier than you can increase it. Second, you do not need to train three times a week. You can maintain your strength at twice a week.

#### **Add variety to your Bowflex® routines.**

Now is the time to introduce more variety to your routines by adding some new exercises while removing some old ones. Below are two sample routines.

#### **Maintenance Routine 1**

1. Seated Hip Abduction
2. Seated Hip Adduction
3. Seated Straight Leg Calf Raise
4. Chest Fly
5. Incline Bench Press
6. Shoulder Pullover
7. Shoulder Shrug
8. Standing Biceps Curl
9. Seated Wrist Curl
10. Seated Wrist Extension

#### **Maintenance Routine 2**

1. Leg Curl
2. Leg Extension
3. Standing Lateral Shoulder Raise
4. Seated Shoulder Press
5. Rear Deltoid Row
6. Decline Press
7. Reverse Curl
8. Seated Triceps Extension
9. Low Back Extension
10. Abdominal Crunch

Look in your Bowflex® Owner's Manual for descriptions of the new exercises.

Be consistent with your Bowflex® home gym exercising, healthy eating, and superhydrating – and your accomplishments may well exceed your goals.





### What Is Covered

Nautilus, Inc. warrants to the original purchaser of the Bowflex Xceed™ home gym that the machine is free from defects in materials or workmanship, with the exceptions stated below. This warranty is not transferable or applicable to any person other than the original purchaser and is only applicable for products sold and used in the United States or Canada. Tampering with the unit will void the warranty.

### Bowflex Xceed™ Home Gym XLU/XTLU

- 7 years on machine
- No-Time-Limit Warranty on Power Rod® resistance rods

### Warranties Do Not Cover

- A Bowflex Xceed™ home gym purchased

for commercial or institutional use.

- Damage due to use by persons who weigh more than 300 pounds (136 kg).
- Damage due to abuse, accident, failure to follow instructions or warnings in the Owner's Manual, misuse, mishandling, accident or Acts of God (such as floods or power surges).
- Damage due to normal wear and tear.

### What We Will Do

During your Warranty Coverage Period, Nautilus, Inc. will repair any Bowflex Xceed™ home gym that proves to be defective in materials or workmanship. In the event repair is not possible, Nautilus, Inc. will either replace your Bowflex Xceed™ home gym or refund your purchase price, less shipping and handling.

### How To Get Service

Return the defective part, at your expense, to the address given to you by a Bowflex® Representative at 1-800-605-3369. Include an explanation of the problem. Adequate protective packaging of the defective parts or unit and cost of shipping are your responsibility.

The repaired part or unit will be returned to you at the company's expense.

### How State Law Applies

This warranty gives you specific legal rights, and you may also have other rights which vary from state to state.



**Please fold over and tape before mailing**



**Please fold over and tape before mailing**

**Place  
Stamp  
Here**

**Nautilus, Inc.  
World Headquarters  
16400 S.E. Nautilus Drive  
Vancouver, WA 98683**



# Warranty Information

## (Keep For Your Records)

We want you to know that the Bowflex Xceed™ home gym is a superior product. Your satisfaction is guaranteed.

If, for any reason, you are not 100% satisfied with your Bowflex Xceed™ home gym, please follow the instructions below to return your merchandise and receive a refund of the purchase price, less shipping and handling.

1. Call a Bowflex® Representative at 1-800-605-3369 for a Return Authorization Number. Return Authorization will be granted if:
  - a. You purchased your Bowflex Xceed™ home gym directly from Nautilus, Inc., and
  - b. You are calling within 6 weeks of the delivery date of your merchandise.
2. All returned merchandise must be properly packaged in the original boxes and in good condition. Returns should be shipped to:  
Nautilus, Inc. World Headquarters  
16400 SE Nautilus Drive  
Vancouver, WA 98683.

**NOTE:** You are responsible for return shipping and for any damage or loss to merchandise that occurs during return shipment. We highly recommend that you insure your shipment.

3. Please mark all boxes clearly with:
  - Return Authorization Number
  - Your Name
  - Your Address
  - Your Phone Number

Boxes without this information clearly marked on the outside may be refused.

4. Please make copies of your original invoice and put one in each box of merchandise. Nautilus, Inc. must receive your shipment within two weeks from the date the Bowflex® Representative issued you your Return Authorization Number.

Refunds may be denied or delayed if these instructions are not completely followed.

This Bowflex® Satisfaction Guarantee applies only to merchandise purchased by consumers directly from Nautilus, Inc. This guarantee does not apply to sales made by dealers or distributors.

### What Does This Warranty Cover?

Nautilus, Inc. warrants to the original purchaser of the Bowflex Xceed™ home gym that the machine is free from defects in materials and workmanship, when used for the purpose intended, under normal conditions. This warranty is extended only to the original purchaser and is not transferable or applicable to any other person.

### How Long Does Warranty Coverage Last?

- 7 years on machine
- No-Time-Limit Warranty on Power Rod® resistance rods
- This warranty is void if Bowflex Xceed™ home gym is used in a Commercial Environment

This warranty covers all defects in material or workmanship of the Bowflex Xceed™ home gym. Warranties do not cover commercial or institutional use or misuse and abuse by the consumer.

To make this warranty effective, you must completely fill out the Bowflex Xceed™ home gym Warranty Registration Card within 30 days of the purchase of your Bowflex Xceed™ home gym, and return it to the address on the Warranty Registration Card.

### Warranty Does Not Cover

- A Bowflex Xceed™ home gym purchased for commercial or institutional use.

- Damage due to use by persons who weigh more than 300 pounds (136 kg).
- Damage due to abuse, accident, failure to follow instructions or warnings in the Owner's Manual, misuse, mishandling, accident or Acts of God (such as floods, tornadoes, power surges, etc.).
- Damage due to normal wear and tear.

### What Nautilus, Inc. Will Do

During your Warranty Coverage Period, Nautilus, Inc. will repair any Bowflex Xceed™ home gym that proves to be defective in materials or workmanship. In the event repair is not possible, Nautilus, Inc., will either replace your Bowflex Xceed™ home gym or refund your purchase price, less shipping and handling.

Nautilus, Inc. reserves the right to substitute material of equal or better quality if identical materials are not available at the time of service under this Warranty. The replacement of the product under the terms of the Warranty in no way extends the Warranty period.

### How to Get Service

Return the defective part at your expense to the address given you by a Bowflex Xceed™ home gym Representative at 1-800-605-3369.

Always include an explanation of the problem with service shipments.

For information, contact a Bowflex Xceed™ home gym Representative at 1-800-605-3369. Adequate protective packaging of the defective parts or unit and cost of shipping to the above address are your responsibility.

The repaired part or unit will be returned to you at the company's expense.

### How State Law Applies

This warranty gives you specific legal rights, and you may also have other rights, which vary from state to state.





## **Important Contact Numbers**

If you need assistance, please have both the serial number of your machine and the date of purchase available when you contact the appropriate Nautilus office listed below.

### **OFFICES IN THE UNITED STATES:**

E-mail: [customerservice@nautilus.com](mailto:customerservice@nautilus.com)

- **NAUTILUS INNOVATION CENTER**  
Nautilus, Inc.  
1886 Prairie Way  
Louisville, Colorado, USA 80027  
Vancouver, Washington, USA 98683  
Phone: 800-NAUTILUS (800-628-8458)  
Email: [customerservice@nautilus.com](mailto:customerservice@nautilus.com)  
Fax: 800-898-9410
  
- **TECHNICAL/CUSTOMER SERVICE**  
Nautilus, Inc.  
World Headquarters  
16400 SE Nautilus Drive  
Vancouver, Washington, USA 98683  
Phone: 800-NAUTILUS (800-628-8458)  
Email: [customerservice@nautilus.com](mailto:customerservice@nautilus.com)  
Fax: 877-686-6466
  
- **CORPORATE HEADQUARTERS**  
Nautilus, Inc.  
World Headquarters  
16400 SE Nautilus Drive  
Vancouver, Washington, USA 98683  
Phone: 800-NAUTILUS (800-628-8458)

### **INTERNATIONAL:**

For technical assistance and a list of distributors in your area, please call or fax one of the following numbers.

- **INTERNATIONAL CUSTOMER SERVICE**  
Nautilus International S.A.  
Rue Jean Prouvé 6  
1762 Givisiez / Switzerland  
Tel: + 41-26-460-77-77  
Fax: + 41-26-460-77-70  
Email: [technics@nautilus.com](mailto:technics@nautilus.com)

### **BUSINESS OFFICES:**

- **SWITZERLAND OFFICE**  
Nautilus Switzerland S.A.  
Tel: + 41-26-460-77-66  
Fax: + 41-26-460-77-60
  
- **GERMANY and AUSTRIA OFFICE**  
Nautilus GmbH  
Tel: +49-2204-610-27  
Fax: +49-2204-628-90
  
- **ITALY OFFICE**  
Nautilus Italy s.r.l.  
Tel: +39-031-51-10-86  
Fax: +39-031-34-24-97
  
- **UNITED KINGDOM OFFICE**  
Nautilus UK Ltd.  
Tel: +44-1908-267-345  
Fax: +44-1908-267-346
  
- **CHINA OFFICE**  
Nautilus Representative Office  
Tel: +86-21-523-707-00  
Fax: +86-21-523-707-09



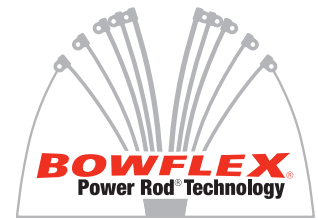

© 2006 Nautilus, Inc. All Rights Reserved.

Nautilus, Inc. World Headquarters, 16400 S.E. Nautilus Drive, Vancouver, Washington, USA 98683 1-800-NAUTILUS  
Nautilus, Bowflex, Bowflex Xceed, Power Rod and the Bowflex and Nautilus logos are either registered trademarks  
or trademarks of Nautilus, Inc. All other trademarks are trademarks of their respective companies.

Printed in China



## Free Manuals Download Website

<http://myh66.com>

<http://usermanuals.us>

<http://www.somanuals.com>

<http://www.4manuals.cc>

<http://www.manual-lib.com>

<http://www.404manual.com>

<http://www.luxmanual.com>

<http://aubethermostatmanual.com>

Golf course search by state

<http://golfingnear.com>

Email search by domain

<http://emailbydomain.com>

Auto manuals search

<http://auto.somanuals.com>

TV manuals search

<http://tv.somanuals.com>