

REDRING

For Questions contact :

BBT NORTH AMERICA
Bosch Group



Bosch Water Heating

340 Mad River Park

Waitsfield, VT 05673

TOLL FREE

866-330-2729

www.boschhotwater.com



Handbook for

PowerStar
electric tankless water heaters

MODELS

AE115

AE125

SINGLE PHASE

IMPORTANT: This booklet should be given to the customer after installation and demonstration.

Important Safety Instructions

When using this electrical equipment, basic safety precautions should always be followed, including the following:

1. READ AND FOLLOW ALL INSTRUCTIONS.

2. This appliance must be grounded.
3. Disconnect this product from the electrical supply before cleaning, servicing or removing the cover.
4. To reduce the risk of injury, close supervision is necessary when the product is used near children or elderly persons.
5. Warning: Do not install the heater in a location where it may be subject to freezing.
6. Warning: Do not install a check valve or any other type of back flow preventer within ten feet of the cold water inlet.
7. The electrical installation must conform to current National Electrical Codes.
8. Warning: Do not switch the heater on if you suspect that it may be frozen. Wait until you are sure that it has completely thawed out.
9. The PowerStar is designed to heat potable cold water for domestic purposes. The **maximum** inlet water temperature it can handle is 86 degrees F. Contact Bosch Water Heating before specifying or installing the appliance in any other application.
10. Additional Canadian safety instructions:
 - a) As per the Canadian Electrical Code, C22.1-02 Section 26-744, an auxiliary terminal block must be fitted to the unit before connecting to the electrical supply (Kit Part N° "AE Canada Kit"). (See Page 6).
 - b) A green terminal (or a wire connector marked "G," "GR," "GROUND" or "GROUNDING") is provided within the control. To reduce the risk of electrical shock, connect this terminal or connector to the grounding terminal of the electrical service of supply panel with a continuous copper wire in accordance with the Canadian Electrical Code, Part I.
 - c) This product shall be protected by a Class A ground fault circuit interrupter.

Contents

Using the PowerStar	3
Installing the PowerStar	3
Spare Parts	7
Starting up the PowerStar	7
How the PowerStar works	8
Specifications	9
If you have a problem	10
Warranty	11

SAVE THESE INSTRUCTIONS

Keep this guide in a safe place once your unit has been installed.
You may need to refer to it for general instructions or future maintenance.

Using the PowerStar

WARNING

Do not use the unit if you think it may be frozen, as this could result in serious damage to the unit. Wait until you are sure that it has completely thawed out before you switch it on.

- Check that the power is switched on at the circuit breaker panel.
- Turn on the hot water faucet FULLY. The hot water temperature can be changed by adjusting the temperature dial on the bottom surface of the unit. (The dial adjusts the temperature typically between 95°F and 131°F. The factory sets the temperature dial at the lowest position.)
- There are internal safety thermal cut-outs which will operate if the unit overheats. If a thermal cut-out trips, then it must be reset by a qualified electrician.
- If the unit has been used recently, run the water through for a few seconds to let the temperature settle down. You may initially get a short burst of very hot water from the unit.
- If a second outlet connected to the unit is also turned on, the hot water will be shared between the two.

Installing the PowerStar

WARNING

Do not install the unit in a room where there is a chance of freezing.

IMPORTANT

Read entire instructions.

Check the pressure of the main water supply. To operate correctly, the unit needs the following running pressures : Minimum: 15 psi (1 Bar) Maximum: 150 psi (10 Bar)

Securing the unit to the wall

Diagram 1

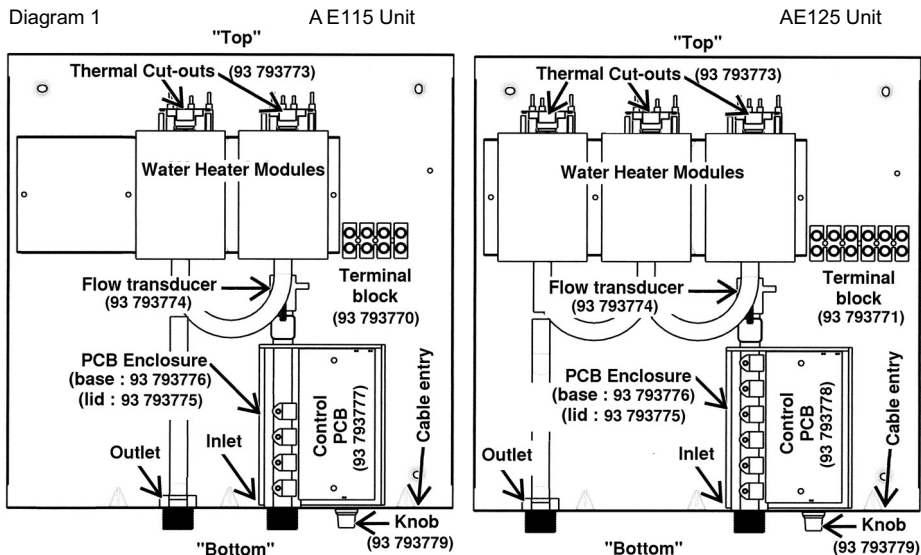

WARNING

*The unit must only be installed in the orientation shown in Diagram 1, i.e., mounted in a vertical position with the water fittings located at the bottom of the unit. **Under no circumstances should the unit be mounted differently.***

- If being used in a public place, position the unit out of easy reach to discourage vandalism.
- Mount the unit onto a flat section of wall, well away from any potential splashes of water or spray.
- Position the unit upright with all plumbing and electrical connections at the bottom of the unit.

Mounting on the wall

- Undo the retaining screws on the front cover and take the cover off the unit. Hold the back plate in position against the wall and mark the four mounting holes.
- Drill the holes and secure the unit using the four wood screws supplied or an appropriate alternative method.

Plumbing the unit

WARNING

*Do not install a non-return check valve within 10 feet of the inlet. **Do not apply heat or solder to connections or pipes if they are already directly connected to the unit.***

Fitting the pipes

- The unit should be connected directly to the main cold water supply and **not to preheated water** (The inlet water temperature must not be greater than 86°F.) The unit should be installed with shut-off valves on both the inlet and outlet connections.
- It is recommended that you use ¾ inch or ½ inch copper or high-pressure flex connections.
- Use Teflon tape for sealing pipe threads. Do NOT use pipe dope.
- Remember to keep the hot water pipe runs as short as possible.
- After the unit has been plumbed, and before you wire it, flush it with water to remove any debris or loose particles. Failure to do so may make the unit inoperable.

Connecting the unit to the pipes

- The inlet and outlet connections are clearly marked on the unit. They each have a ¾ inch NPT connector.
- Install a ball valve in the cold water line. This valve can be used to turn off the water supply to the unit if it needs servicing, or to reduce the water flow if it is too high.

DISCLAIMER

As a condition of installing this product in the Commonwealth of Massachusetts a pressure relief valve shall be installed on the cold water side, by a licensed plumber MGL 142 Section 19 Approval number: P1-09-25

Wiring to the unit in the United States of America

WARNING

The unit must be installed by a qualified electrician, in accordance with the current version of the National Electrical Code. The unit must be grounded.

IMPORTANT

When the PowerStar is not within sight of the electrical circuit breakers, a circuit breaker lockout or additional local means of disconnection for all non-grounded conductors must be provided that is within sight of the appliance. (Ref NEC 422.31.)

The AE115 requires two independent 240V AC circuits protected by two separate and independent double pole breakers (as shown) rated at 40 A each.

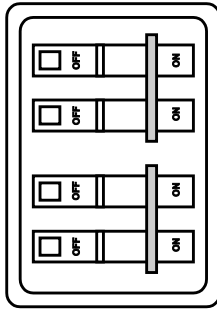

The AE125 requires three independent 240V AC circuits protected by three separate and independent double pole breakers (as shown) rated at 40 A each.

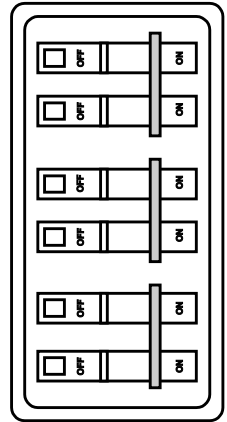

- The minimum recommended wire size is 8 AWG. (The terminal block will accept cables up to 6 AWG size.)
- The cable entry is via the 1 ¼ inch cable entry hole on the bottom right hand edge of the backplate.
- Strip back the insulation on the power wires about ½ inch. Connect the live wires to the terminals marked "L1" and "L2." There are two pairs of live wires in the AE115 and three pairs of live wires in the AE125.
- Any insulation on the ground wire should be stripped back about ¾ inch. The ground lead must be connected to the pillar terminal marked "GR". (See Diagrams 2 and 3 below).
- Make sure the terminal block screws are tightened securely. Loose connections can cause wires to heat up.
- Make sure that the ground wire is wrapped around its terminal stud and into the saddle washer. The nut should be tightened securely.

Diagram 2 (AE115 unit)

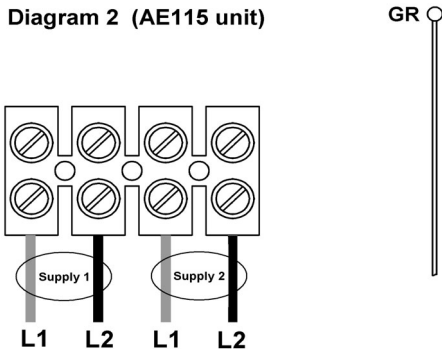
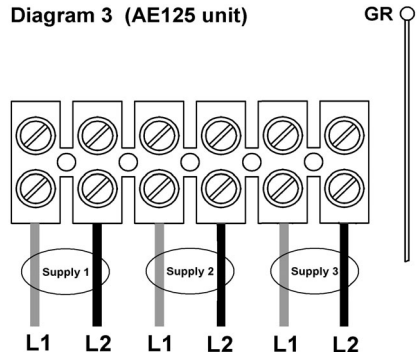

Diagram 3 (AE125 unit)



- Attach the front cover and tighten the retaining screws.

Wiring to the unitn Canada

WARNING

The unit must be installed by a qualified electrician, in accordance with the current version of the Canadian Electrical Code. The unit must be grounded.

IMPORTANT

- When the PowerStar is not within sight of the electrical circuit breakers, a circuit breaker lockout or additional local means of disconnection for all non-grounded conductors must be provided that is within sight of the appliance. (Ref NEC 422.31.)
- As per the Canadian Electrical Code, C22.1-02 Section 26-744, an auxiliary terminal block must be fitted to the unit before connecting to the electrical supply. This is available as a kit from BBT, Part Number "AE Canada Kit". (Contact 866-330-2729).

Fitting the auxiliary terminal block (see diagram below).

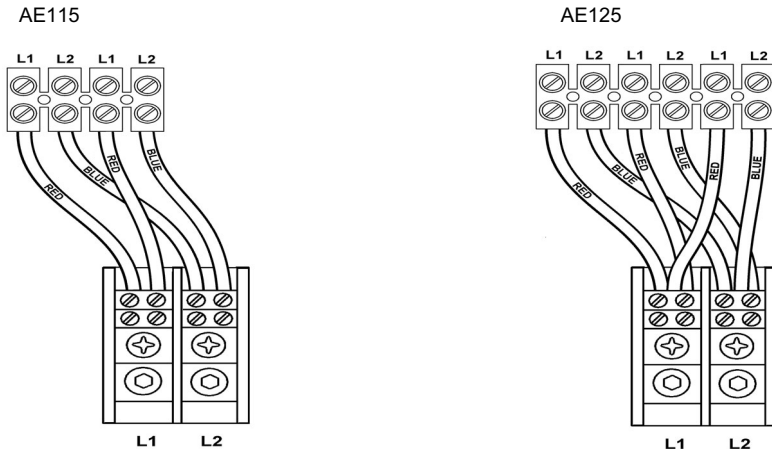

- Connect the red wires from the left hand terminal of the new block to the L1 terminals in the unit. (There are two red wires required in the AE115 and three in the AE125).
- Connect the blue wires from the right hand terminal of the new block to the L2 terminals in the unit. (There are two blue wires required in the AE115 and three in the AE125).
- Push and click the auxiliary terminal block onto the louvered rail in the backplate.

Connecting the supply cable

- The AE115 requires an 80A 240V AC single phase supply protected by an 80A double pole circuit breaker.
- The AE125 requires a 120A 240V AC single phase supply protected by a 120A double pole circuit breaker.
- The power cable size and the installation must be in accordance with the Canadian Electrical Code, C22.1-02.
- The incoming hole diameter on auxiliary terminal block can accept up to 1/0 AWG size cables.
- The cable entry is via the 1 ¼ inch cable entry hole on the bottom right hand edge of the backplate.
- Strip back the insulation on the power wires about ½ inch. Connect the ungrounded conductors to the terminals "L1" and "L2" on the auxiliary terminal block.

- Any insulation on the ground wire should be stripped back about ¾ inch. The ground lead must be connected to the pillar terminal marked “GR.”
- Make sure the terminal block screws are tightened securely. Loose connections can cause wires to heat up.
- Make sure that the ground wire is wrapped around its terminal stud and into the saddle washer. The nut should be tightened securely.
- Attach the front cover and tighten the retaining screws.

Spare Parts

Part Number	Description (Refer to Diagram 1, Page 3)	<p>For further information ask your local dealer.</p> <p>FOR SERVICE AND INSTALLATION QUESTIONS CALL TOLL FREE:</p> <p>866-330-2729 (Toll Free)</p> <p>Fax: 802496-6924</p> <p>BBT NORTH AMERICA Bosch Group</p> <p>www.boschhotwater.com</p>
93 793770	4 way term. block (for AE115)	
93 793771	6 way term. block (for AE 125)	
93 793772	Front cover (white)	
93 793773	Thermal cut-out	
93 793774	Flow transducer	
93 793775	PCB enclosure (lid)	
93 793776	PCB enclosure (base)	
93 793777	Control PCB (for AE115)	
93 793778	Control PCB (for AE125)	
93 793779	Adjustment knob	
93 793784	¾" Inlet filter	

Starting up the PowerStar

Checking for leaks

- Let the water run through the unit for a few seconds. Check that no pipe joints leak.

Adjusting the temperature dial

- The temperature adjustment is made using the dial on the bottom edge of the unit. The adjustment is between approximately 95°F and 135°F. Turning the dial clockwise increases the temperature setting as indicated by the marking on the unit.

Adjusting the flow

- Open fully both inlet and outlet shut-off valves at the heater, then :
- Turn on fully the highest flowing hot water faucet (e.g., bathtub) closest to the outlet connection.
- Adjust the outlet shut-off valve until the water flow rate from the hot faucet corresponds to the value given in Graph 1 on Page 8.

Graph 1

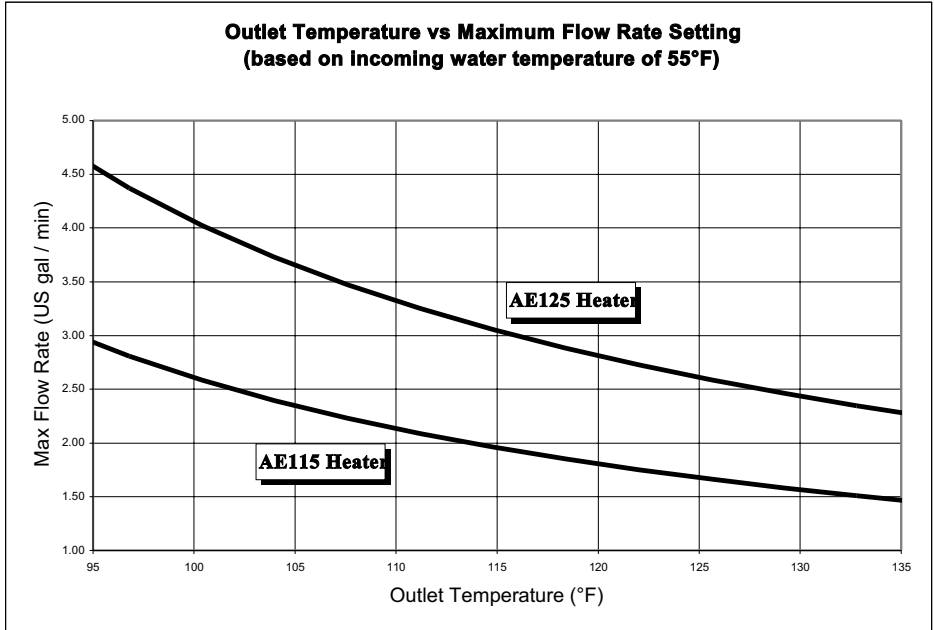

For example:

- For the AE115 unit, using a ball valve, ensure the flow rate does not exceed 2.3 US gallons / minute.
- For the AE125 unit, using a ball valve, ensure the flow rate does not exceed 3.5 US gallons / minute.

Note: These figures are based on an inlet water temperature of 55°F and a supply voltage of 240 volts. If the inlet water temperature is lower than 55°F, or if the supply voltage is less than 240 volts, then the outlet temperature will be lower than what is shown in Graph 1. If a higher outlet water temperature is desired, then reduce the flow rate and/or supply the unit with 240 volts.

IMPORTANT

Before leaving the site, the installer should demonstrate the unit to the user and give them this guide.

How the PowerStar works

- The PowerStar heats water instantaneously as it flows through the heater modules.
- The electronic control monitors the flow rate and the incoming water temperature and then switches on the required number of heater modules to reach the temperature set by the adjustment dial.
- As the flow rate or the incoming water temperature changes, the electronics adjust the number of heater modules used so that the outlet temperature is maintained.
- The outlet water temperature can change slightly as the flow rate changes due to the steps in power as different heater modules are switched on and off.

- The outlet water temperature can also vary if the maximum flow rate is exceeded (see Graph 1) or if the supply voltage changes.
- Each heater module is protected by an electro-mechanical thermal cut-out. If the temperature of any of the heater modules gets too high, then the cut-out will trip and cut the power to that heater module. If the cut-out operates, it must be reset by a qualified service person. This cut-out will only trip in exceptional circumstances.
- The AE115 unit is supplied from two independent voltage supplies and the AE125 unit from three independent voltage supplies. The unit may continue to work if one of these supplies is switched off or fails, but the temperature control will be poor. (In Canada the unit has just one voltage supply).
- Depending on the region of the country, the temperature of the water supply can vary between 40°F in winter to 70°F in summer, with an average of 55°F.

Diagram 4: Internal wiring schematic for single phase AE125 unit. (AE115 has two heater modules and two supplies). (In Canada an auxiliary terminal block is fitted during installation).

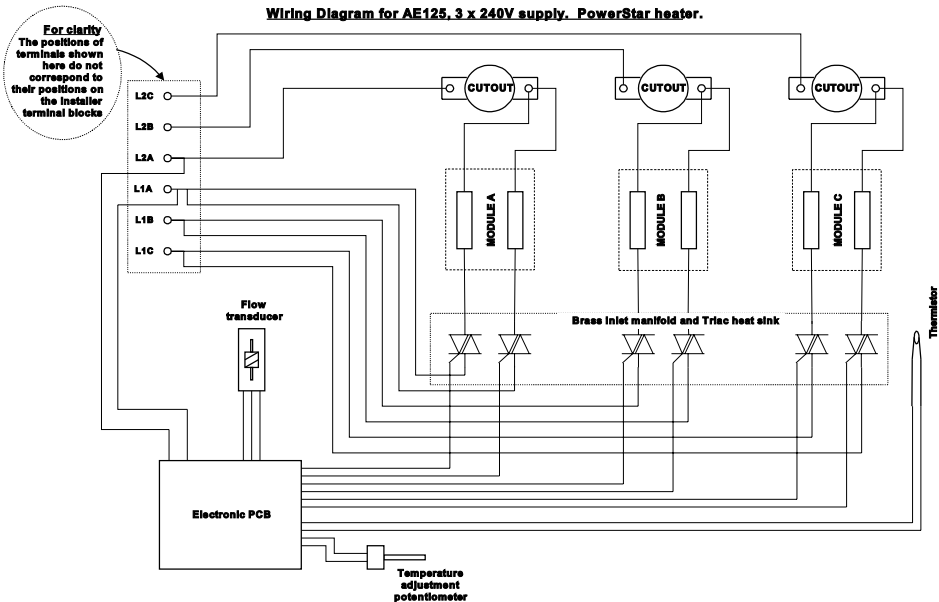

Specifications

	AE115 Unit	AE125 Unit
Voltage supply	2 x 240V AC (Canada 240VAC)	3 x 240V AC (Canada 240VAC)
Amperage	2 x 40 A (Canada 80 A)	3 x 40 A (Canada 120 A)
Maximum output	17.25 kW	26.85kW
Temperature control range	95°F to 131°F	95°F to 131°F
Pressure range	15 psi to 150 psi	15 psi to 150 psi
Minimum flow rate	0.6 US gal / min	0.8 US gal / min
Maximum flow rate	See Graph 1, Page 8	See Graph 1, Page 8
Dimensions (excl. water couplers)	15½" H x 15¼" W x 4½" D	15½" H x 15¼" W x 4½" D
Weight (without water)	20 lbs	22 lbs

Note: The unit will work at lower supply voltages but the following changes apply:

Maximum output	15kW at 220V	22.5kW at 220V
	13kW at 208V	20kW at 208V
Temperature control range	87°F to 116°F at 220V	87°F to 116°F at 220V
	82°F to 108°F at 208V	82°F to 108°F at 208V
Maximum flow rate	84% of maximum at 220V	84% of maximum at 220V
(refer to Graph 1, Page 8)	75% of maximum at 208V	75% of maximum at 208V

WARNING

Always switch off the electricity supply to the unit before you remove the cover.

If you have a problem...

Service should only be performed by qualified personnel		
Symptom	Cause	What to do
Cold water only- neon light off.	Electricity not on or one of the supplies has failed.	Check electricity supply.
	The water supply is connected to the outlet of the unit.	Reconnect the water supply to the inlet of the unit (marked blue).
	One or more of the heater module cut-outs has tripped.	Turn off the power, open the unit and reset by pushing the button(s) on the top of the heater module(s). Establish and fix the cause of the overheating.
	Plumbing crossover.	Test by turning cold water supply off to heater, then open hot water faucet(s). No pressurized water flow should be evident. If it is evident, then that plumbing crossover needs to be corrected for the heater to operate.
	The flow transducer is not working.	Turn off the power, open the unit and observe if the flow transducer "spins" when the water is turned on. If not, contact BBT toll free at 866-330-2729.
Water too cold- neon light on	Water flow is too high.	Adjust the water flow (see Graph 1 on Page 8).
	One of the power supplies is not on.	Check the supply voltages to the heater and rectify if necessary.
	The power supply voltage has dropped.	This is likely an issue with the power supply. Compensate for this by increasing the temperature setting (turn dial clockwise).
	Temperature dial is turned too low.	Turn the temperature control dial clockwise.
	The inlet water temperature has dropped.	Turn temperature knob up or reduce the flow rate according to Graph 1 on Page 8.

Water flow too low	There are restrictions in the plumbing.	Check the plumbing. Use only Teflon tape for sealing pipe joints. Inspect and clean inlet filter screen at heater.
	Water supply pressure too low.	Check that all inlet shut-off valves are fully open.
	Outlet shut-off valves are set too low.	Adjust outlet shut-off valves as described in the section "Adjusting the Flow" (see Page 7).
Water temperature fluctuates	Fluctuating water pressure or changing flow rate.	Avoid several hot water outlets being used at the same time as this causes the temperature to fluctuate.

If the problem persists

The person who initially installed the unit is the best one to contact for help. You can also call BBT toll free at 866-330-2729. Please have this guide with you when you call.

PowerStar LIMITED 10 YEAR WARRANTY

COVERAGE

APPLIED ENERGY PRODUCTS THROUGH ITS U.S. DISTRIBUTOR BOSCH WATER HEATING (herein after BBT) guarantees this water heater to the original owner of the water heater at the original installation location against defects in material and workmanship for the periods specified below.

WARRANTY PERIOD

1. The Heat Exchanger – If the original heat exchanger leaks or fails within ten (10) years from the date of original installation of the water heater because of a defect in material or workmanship, BBT will furnish to such an owner a replacement heater of the then-prevailing comparable model.

However, if the water heater is installed in other than a single family dwelling this heat exchanger warranty is limited to two (2) years from the date of original installation and operation.

Note : Damage caused by exposure to freezing conditions is not covered by the warranty.

Note : Damage caused by scale formation is not covered by the warranty.

2. Any Component Part Other Than the Heat Exchanger – If any other component part (other than the heat exchanger) proves to be defective in material or workmanship within one (1) year from the date of original installation of the water heater, BBT will furnish the owner with a replacement of the defective part(s).

PowerStar

LIMITED 10 YEAR WARRANTY(Continued from Page 11)

3. Verification of Date of Original Installation – When owner cannot verify or document the original date of installation, the warranty period begins on the date of manufacture marked on the tag affixed to the water heater.

EXCLUSIONS

1. THIS LIMITED WARRANTY SHALL BE THE EXCLUSIVE WARRANTY MADE BY THE MANUFACTURER AND IS MADE IN LIEU OF ALL OTHER WARRANTIES, EXPRESSED OR IMPLIED (WHETHER WRITTEN OR ORAL), INCLUDING, BUT NOT LIMITED TO, WARRANTIES OF MERCHANTABILITY AND FITNESS FOR A PARTICULAR PURPOSE.
2. Manufacturer shall not be liable for incidental, consequential, special or contingent damages or expenses arising, directly or indirectly, from any defect in the water heater or the use of the water heater.
3. Manufacturer shall not be liable for any water damage arising, directly or indirectly, from any defect in the water heater component part(s) or from its use.
4. Manufacturer shall not be liable under this warranty if:
 - a) The water heater or any of its component parts has been subject to misuse, alteration, neglect or accident, or;
 - b) The water heater has not been installed in accordance with the applicable local plumbing and/or building code(s) and/or regulation(s), or;
 - c) The water heater has not been installed in accordance with the printed manufacturer's instructions, or;
 - d) The water heater is not continuously supplied with potable water.
5. The owner and not the manufacturer or his representative shall be liable for and shall pay for all field damages for labor or other expenses incurred in the removal and/or repair of the product or any expense incurred by the owner in order to repair the product.

SOME STATES DO NOT ALLOW THE EXCLUSION OR LIMITATION OF INCIDENTAL OR CONSEQUENTIAL DAMAGES, SO THE ABOVE LIMITATION OR EXCLUSION MAY NOT APPLY TO YOU. THIS WARRANTY GIVES YOU SPECIFIC LEGAL RIGHTS AND YOU MAY ALSO HAVE OTHERS.

IMPORTANT: OWNER SHALL KEEP THIS CERTIFICATE

NOTE: A water heater should be installed in such a manner that if it should leak, the resulting flow of water will not cause damage to the area in which it is installed.

The person who initially installed the unit is the best one to contact for help.

You can also call BBT toll free at 866-330-2729. Please have this guide with you when you call.

BBT NORTH AMERICA
Bosch Group

Bosch Water Heating □
340 Mad River Park □
Waitsfield, VT 05673 □
TOLL FREE: 866-330-2729 □
Fax: 802-496-6924
www.boschhotwater.com

12.14.05

© 2005 Bosch Water Heating
Waitsfield, VT all rights reserved

555-2028-04 A

Free Manuals Download Website

<http://myh66.com>

<http://usermanuals.us>

<http://www.somanuals.com>

<http://www.4manuals.cc>

<http://www.manual-lib.com>

<http://www.404manual.com>

<http://www.luxmanual.com>

<http://aubethermostatmanual.com>

Golf course search by state

<http://golfingnear.com>

Email search by domain

<http://emailbydomain.com>

Auto manuals search

<http://auto.somanuals.com>

TV manuals search

<http://tv.somanuals.com>