

Velocity

**Amplifier**

**VA1400**

1 x 100 Wrms

1 Channel Amplifier



1 Channel Audio Amplifier  
1 Führungen Audioverstärker  
Amplificateur Audio 1 Canal  
Amplificatore Audio a 1 Canali  
Amplificador Audio de 1 Canales  
Amplificador de áudio de 1 Canais  
1 Kanal Lågfrekvensförstärkare  
1 Kanaal Audio Versterker

[www.blaupunkt.com](http://www.blaupunkt.com)

**● BLAUPUNKT**

English

Deutsch

Français

Italiano

Español

Português

Svensk

Nederlands

# BLAUPUNKT SPECIFICATIONS - VA1400, 1 CHANNEL AMPLIFIER

All power ratings conform to CEA-2006 standards.

PARAMETER/FEATURE	VA1400
Channels	1
Size ( L x W x D) <i>without trim panels</i>	15.1x9.1x2.4 inches (382x231x60mm)
Weight	14.5 lbs. (6.6 kg)
Spade screw speaker terminals?	YES
Maximum terminal wire size	10 ga.
Subsonic filter	YES (10 Hz)
Separate front/rear or left/right gains?	N/A
Fuse Type	ATC spade -Two 40A
Speaker short, short to +12V, and short to ground protection?	YES
High, low, and reverse voltage protection?	YES
Power output transistors	Low QZ MOSFET
Power supply transistors	MOSFET
Minimum speaker impedance (non-bridged)	2 ohms
(bridged)	N/A
PERFORMANCE DATA	
Rated power output @ 0.1% THD, 14.4V (CEA-2006)	
1 channel into 4 ohms (watts rms)	1 x 100 W
1 channel into 2 ohms (watts rms)	1 x 600 W
Max Dynamic Power (watts rms)	700W
Total Harmonic Distortion @ full power	0.3% THD
Signal/Noise ratio (gain controls in center)	
Measured @ 1 watt / 1 kHz dBA	>80
Measured @ full rated power (0.1% THD) dBA	>100
Damping factor	>100
Frequency response (full-range mode)	50 - 250 Hz
High-pass crossover frequency limits	N/A
Low-pass crossover frequency limits	50 H z - 250 Hz (variable), 12dB/oct
Input impedance	10 kohms
Input signal voltage control range	0.3 - 8.0 vrms
Current Draw @ 13.8 VDC (typical values @ X watts / Efficiency %)	
@ full rated power, unbridged (@ 4 ohms)	50 A (50%)
@ 33% rated power, unbridged (@ 4 ohms)	30 A (35%)
@ idle (@ 4 ohms)	1 A
Minimum battery voltage to maintain rated power	12.6 VDC
Usable battery voltage	10 - 16 VDC
Trigger line voltage range	10 - 16 VDC
Trigger line current draw	< 20 mA
Turn on delay time	@ 2.0 seconds
Thermal shutoff temperature (average heat-sink temp)	@ 85° C (185° F)

*This information is subject to change without notice!*

## ASSEMBLY & MOUNTING



# THANK YOU FOR CHOOSING BLAUPUNKT!

**Congratulations!** You are now the owner of an exceptional car audio amplifier from the audio enthusiasts at Blaupunkt. Our engineering staff has spent considerable time refining our Velocity series amplifiers in order to introduce great sound to the consumer. With these products we focus on sonic performance but balanced with rugged design and flexible installation.

Not only do we offer you a great product but also a supportive owners manual. This manual can be used as a teaching guide due to its brief, but informative, explanations of amplifier and system design. We are also very concerned about the end consumer using proper installation techniques for the highest performance possible from their new audio products. MOST important to us are the concerns with safety and the installation process. Since our Blaupunkt retail dealers have the tools and experience for an optimized and safe installation, we always recommend they do the final vehicle integration. But, should you choose to install these products yourself, please take the time to read this manual completely and abide by all precautions.

## AMPLIFIER BENEFITS & FEATURES

### “THERMAL-THROTTLE” TEMPERATURE PROTECTION

Unlike “dragster” style amplifiers that put out lots of power for a few minutes, our Velocity series amps are engineered for full throttle, everyday driving. With our incredible Blaupunkt “Thermal Throttle”, our amps keep on playing without overheating, the common shut-down mode for most amplifiers.

All amplifiers heat up some over time. Using our moving voltage rail design, once warm, the rails pull back to prevent long term overheating thus preventing full shut off or even possible damage, as most other amps do. Once initiated this temporary system gain pullback lets you know you are really pushing the system hard but it's not letting you down going into full shut down.

### UNIQUE INSTALLATION FLEXIBILITY

Included in your amplifier kit is the very cool looking side rails and end caps. The side rail system allows you to butt amps side-by-side building a multi-channel monster of a system but with everything trimming out beautifully. An added benefit of the side rails and caps is the dressing down and hiding of all cables preventing any kind of snagged wires.

### REMOTE GAIN CONTROL

You will find a very nice remote gain control for the amplifier. This gain control works only in the subwoofer mode (low-pass) providing about 20dB of gain range to dial in accurate bass levels or to simply pound out the tunes if desired.

### NOISE ISOLATION MODE CONTROL

Inside the amplifier are isolation circuits to help prevent the intrusion of noise into the audio path. These circuits are turned on or off via the small switches visible through the bottom plate. Noise currents may enter the system via signal cables should there be small ground voltage differences. These are sometimes heard as a varying pitch with engine speed (alternator whine). The vehicle may also have a poor antenna ground, or overly sensitive AM radio tuner front end, which can result in low level back ground tones (birdies) in some parts of the AM radio band (550kHz-1710kHz).

Should either of these conditions occur, use a small screwdriver to slide the switch to the “ON” position and they should be eliminated. If no problems are detected, leave in the “OFF” position for maximum audio system performance.

### Conventional Amplifier Output

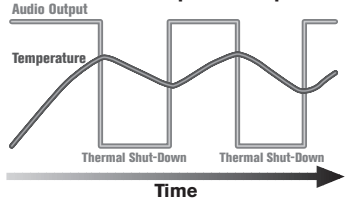

### Blaupunkt ThermalThrottle™ Output

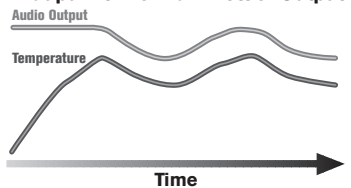

## SAFETY CONCERNS

We always recommend you have your Blaupunkt amplifiers professionally installed but the installation process is often so easy that the average consumer can achieve success with little trouble. Regardless of the person installing, you should be sure to review the following points before proceeding with the installation:

- **READ THE MANUAL!** Understanding the product and installation limitations before lifting a screwdriver.
- **WEAR SAFETY GLASSES AT ALL TIMES** - Flying debris are always dangerous.
- **PROTECT THE VEHICLE** - Always disconnect the negative battery cable before starting any kind of installation work. This prevents a possible high current electrical short (potential fires).
- **HEAT** - Keep all audio components away from nearby hot vehicle components that heat up over time such as hoses, high current wires, and braking system components.
- **GIVE YOURSELF LOTS OF TIME** - Rushing to complete an installation nearly always ends up with problems.
- **DO NOT LISTEN AT HIGH SOUND LEVELS FOR A PROLONGED TIME** - these amplifiers, used with high efficiency speakers from ANY manufacturer, have the potential to cause permanent hearing loss after listening at maximum volume levels for several hours.



## INSTALLATION WARNINGS!

Before disassembling your beautiful new car you need some basic installation knowledge and skill with common hand and power tools. Following such basic installation tips and warnings will prevent possible damage to the vehicle and also prevent possible fires.

- **AGAIN...READ THE MANUAL!** There is a lot of helpful information in this manual that will save time and prevent problems later.
- **COVER THE VEHICLE WORK AREAS** - Use fender covers or blankets to protect the work areas from scratches or dings.
- **DISCONNECT THE (-) LEAD ON THE BATTERY** - No sparks or fires please!
- **"REVIEW" THE INSTALLATION** - Before using any tools or moving vehicle components, take five minutes to review the installation intentions (e.g., verify that an amplifier will fit in an area of a car before tearing out all the interior).
- **"REVIEW" THE VEHICLE** - Before drilling any holes or cutting into any surfaces, make sure there are no fuel or hydraulic lines behind the surfaces. Also make sure there are no wires routed directly behind or near the desired mounting area (remember...screws can often extend 1-2 inches behind the mounting surface).
- **ENSURE PROPER FIT** - Before cutting or drilling, make sure the amplifier will physically fit in its desired location. Check for clearance around rear deck torsion bars or other structural elements.
- **EVERY CAR IS ASSEMBLED DIFFERENT** - Every auto manufacturer uses different assembly techniques. Take care in removing/modifying all trim panels and mounting surfaces since they often use unique screws or snap fasteners that are difficult to replace if they are lost or broken.
- **BE CAREFUL WITH CABLE ROUTING** - When routing audio cables, make sure RCA and speaker wires are routed away from high current power lines for audio amplifiers and vehicle systems lines when possible. This will help prevent noises from creeping into the audio system, plus prevent potential damage to the vehicle wiring itself.
- **BE CAREFUL WITH ALL CONNECTIONS** - When making connections, make sure each connection is clean and properly secured. Observe all polarity markings carefully to ensure proper end performance.
- **CAUTION - FUEL TANKS AND FUEL LINES ARE NOW LOCATED DIRECTLY BENEATH THE REAR DECK IN MANY CARS - CHECK FOR ADEQUATE CLEARANCE BEFORE EVEN CONSIDERING SUCH A MOUNTING LOCATION!**



## SYSTEM PLANNING

Before wiring up an audio system that may not achieve the sound quality you want, be sure to choose a system concept that fits your listening requirements. Basic systems, a receiver with internal 4x20 watts and 4 coax speakers, are adequate for many listeners. But, when you want to really “feel” the music, you will need some kind of subwoofer amplifier/speaker combination. Although many people might jump into an “add-on” amplifier to power to rear coaxial speakers, a better choice is usually a subwoofer amp/speaker system that supplements the existing 4 speaker system as shown in the adjacent drawing. Such a system provides a surprising improvement in sound quality due to the usually dramatic increase in bass response.

The next dramatic step up in performance is with a “multi-channel” system that offers more dynamic range in the mids and highs due to higher power plus more bass response due to multiple woofers and/or more power. But, with such a system, the stereo image and overall listening experience usually becomes much more life-like due to better tonal quality midrange/tweeter speakers and usually better placement.

To build such a system though, complexity goes up due to the addition of passive or active crossovers which take time to install and may inject noise into the system due to potential noise signal pick up. The results though of such a system can be dramatically pleasing.

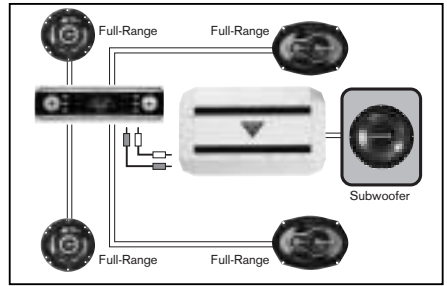

**Supplementary subwoofer system**

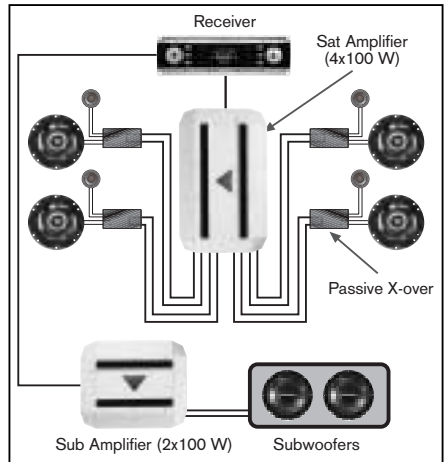

**High performance multi-channel system**

## INSTALLATION TOOLS

For most installations, simple hand tools are adequate to install an aftermarket amplifier. Depending upon the mounting locations used, you will need power tools for drilling and cutting plastics and metal. A good starting list is summarized below:

- Tape measure and ruler
- Marking pen and starting punch
- Phillips and flat blade screwdrivers (small and medium sizes)
- Nylon wire bundle ties
- Pliers: standard vice-grip and needle nose styles
- Light-duty trim pry-bar for removing door trim
- Cutting shears or nibbling tool for cutting thin and medium gauger metal
- Wire cutters, wire strippers, electrical tape, crimping pliers and appropriate crimp-on terminals
- Power drill with appropriate sized drill bits



## VEHICLE FUSING

For safety purposes, a high current fuse (or circuit breaker) **MUST** be installed in line with the amplifier(s) immediately at the battery to prevent vehicle damage should the battery line in advertently shorted to the vehicle chassis. The chart at the right shows the recommended master fuse sizes for an average audio system with noted "rms" output power levels.

SYSTEM FUSE CHART (Fuse size for total amplifier system power in "rms" watts)				
	100 W	200 W	500 W	1000 W
Fuse Size (in amps)	20 A	30 A	50 A	100 A

## POWER WIRING

Most vehicles built since 1990 have adequate current capability for your amplifier. Except for systems above about 500 W rms, the factory charging system and battery should easily support it if properly installed. Proper wire size must be chosen to ensure adequate current delivery to the amp. Wire size (gauge) of the cables need to increase in size for higher power systems. (Wire sizes larger than those noted are usually a waste of time and money since they offer little or no performance improvements.)

SYSTEM POWER AND GROUND WIRE CHART (Wire gauge for total system in "rms" watts)				
WIRE LENGTH	100 W	200 W	500 W	1000 W
5 ft. / 1.5 m	12	10	8	4
10 ft. / 3.0 m	12	10	8	4
15 ft. / 4.5 m	10	8	6	2
20 ft. / 6.0 m	10	8	6	2
25 ft. / 7.5 m	10	8	4	0 or 00

Wire diameter must increase (decreased wire gauge number) for higher power systems. For long wire runs the wire diameter must also increase. The wire sizes noted allow for a maximum 0.5 volts DC drop over the give wire run which results in Sound Pressure Level drops inaudible to the average listener.

## SPEAKER WIRING

As with power wire, speaker wire size (gauge) changes with the power required and the length of the wire run. The speaker wire chart shows the minimum recommended wire size for a single audio output channel driving a loudspeaker at a given distance with a maximum power loss of 0.5 dB, the threshold of audibility. (Wire sizes larger than those noted are usually a waste of time and money since they offer little or no performance improvements.)

LOUDSPEAKER WIRE CHART (Wire gauge per loudspeaker/speaker power in "rms" watts)				
WIRE LENGTH	20 W	50 W	100 W	200 W
5 ft. / 1.5 m	18	16	16	16
10 ft. / 3.0 m	18	16	16	16
15 ft. / 4.5 m	16	16	16	14
20 ft. / 6.0 m	16	16	16	14
25 ft. / 7.5 m	16	16	14	12

## FINAL VEHICLE WIRING

Current requirements for an upgraded audio system dictate a dedicated power line be run from the amplifier directly to the battery of the vehicle. This line should **NOT** be run to the fuse panel of the vehicle but directly to the battery. **DO NOT** run to the alternator either. There **MUST** be a fuse installed at the battery with adequate amperage as shown in the chart above.

As for the final signal wiring, be sure to route the audio cables down the side of the car opposite the power lines to avoid noise pick up from the lines. Also, try to route all audio cables away from noise sources such as engine computers and ABS brake computers.

Proper power grounding is important to insure adequate current flow. Be sure to grind the surface clean of all paint to ensure a solid electrical connection.

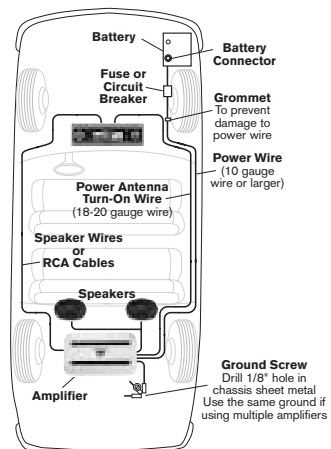

## CONNECTIONS & CONTROLS

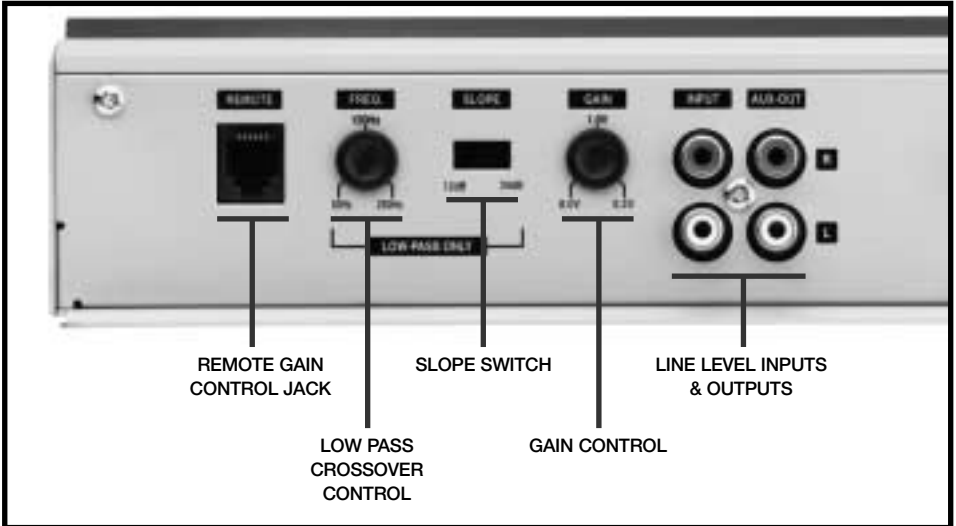

**REMOTE GAIN CONTROL JACK** - For connecting the remote gain control (included). This allows you to adjust the gain while seated in the vehicle with the system operating.

**LOW PASS CROSSOVER CONTROL** - This control sets the upper frequency limit of the amplifier. For most subwoofers a value just below 100 Hz is usually best.

**SLOPE SWITCH** - This allows you to switch between 12 dB and 24 dB per octave roll-off.

**GAIN CONTROL** - The gain control allows for a range of 0.3 - 8 Volts input. This means that if the setting is 0.3V, it only takes 0.3V to drive the amp to full output. (Such a low setting allows for the amp to be easily overdriven, and more susceptible to noise so a mid-position is highly recommended for most radios.)

**LINE LEVEL INPUTS & OUTPUTS** - The most commonly used inputs and outputs in the aftermarket are RCA type line level. These can handle up to about 6 Volts rms without overdriving the amp. Such high voltages are rarely found from car audio head units, so this is a very comfortable value. But should you need to drive the amp directly from speaker level leads, use the supplied "High Level Adapter" to connect to the amp.



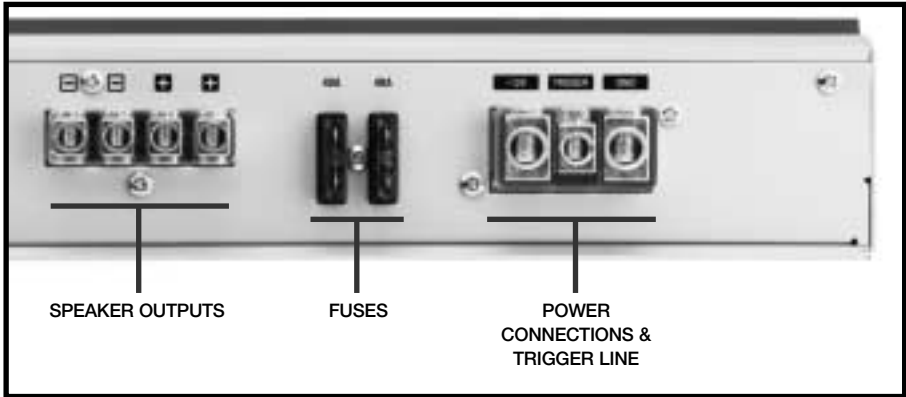

**SPEAKER OUTPUTS** - The amplifier is connected to appropriate impedance speakers via these leads. It is **IMPERATIVE** that these leads NOT be connected or touch the vehicle chassis in any way or the amplifier will be damaged. The (+) and (-) leads of the amp are in no way interconnected to one another. Also, **NONE** of the leads can touch each other, touch ground, or touch +12V or damage may occur to the amp or vehicle.

**FUSES** - These fuses are only for catastrophic situations should the amplifier begin to self-destruct or incur installation situations where gross amounts of current are being required from the amp beyond its design limits. Although another fuse should be installed inline with the high power line at the battery, these amplifier mounted fuses **MUST** remain in the circuit to protect the amplifier.

**POWER CONNECTIONS & TRIGGER LINE**

**+12v** - A high current line run direct from the battery is highly recommended to insure adequate current and voltage. This line **MUST** be run through a dedicated fuse of some kind and this fuse should be located immediately next to the power source. This in-line fuse is used to protect the vehicle should a short to chassis occur.

**TRIGGER** - This line tells the amp to turn on and is remotely switched from the radio which normally provides an amp "trigger" output. This line is required to go "high" (+12V) to turn on the amp. If this line is not available, use the power antenna line trigger which is normally available in most radios.

**GROUND** - This is the high current ground connection to the chassis of the car. It should be fastened to a clean ground connection in the vehicle, capable of handling high current loads. This wire should be no longer than 3 feet (1 meter).

**BLUE DOT LIGHT INDICATOR ON THE TOP OF THE AMPLIFIER (not shown above)**

**POWER ON** - This light will turn on when the amplifier receives a +12V turn-on signal from the radio. If the amp is properly wired, but the light does not turn on, there may be a short circuit condition that the amp is protecting itself from.

**PROTECTION LED** - This light flashes if the amplifier senses a severe problem, such as a speaker short circuit.

**+12V Terminal**

Connect directly to the vehicle battery (+) terminal with 10 gage wire (minimum)

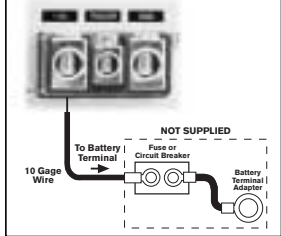

**Ground Terminal**

Connect to a good chassis ground. The ground connection should be clean, unpainted metal to provide a good electrical connection.

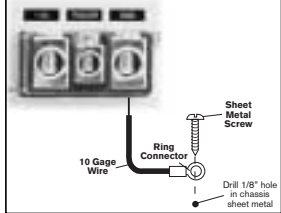

**Trigger Terminal**

Connect the radio power antenna lead from the receiver to the trigger terminal. This turns the amplifier on whenever the receiver is turned on.

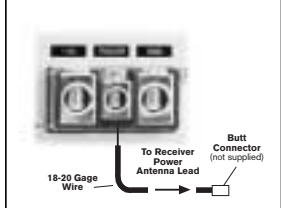

## SYSTEM CONFIGURATION #1

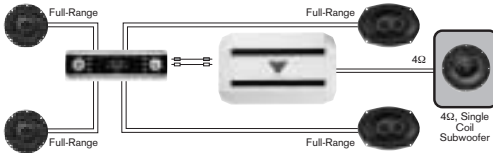

### 1 Channel, Single Coil Subwoofer Mode

This configuration is the most common usage as a straight ahead subwoofer amplifier.

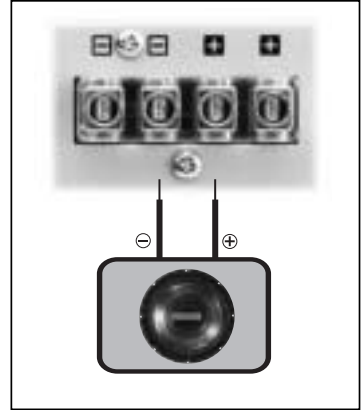

## SYSTEM CONFIGURATION #2

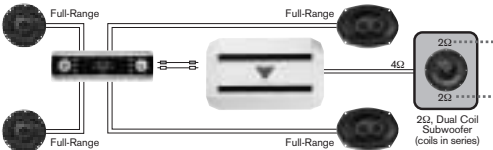

### 1 Channel, Dual Voice Coil Subwoofer Mode

This configuration is able to drive a dual voice coil subwoofer if the coils are dual 8 ohm, thus 4 ohms in parallel. Although the amp is able to run into a 2 ohm load (DVC subwoofer with coils in parallel), we do not recommend it for prolonged times due to potential overheating.

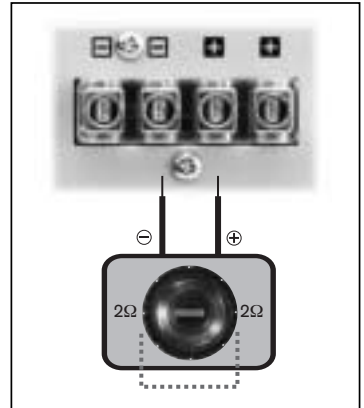

## SYSTEM CONFIGURATION #3

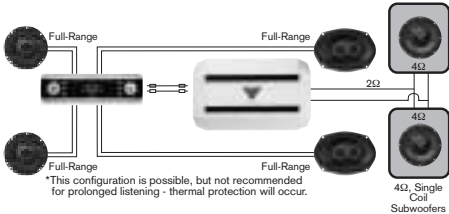

### 1 Channel, Dual, Single Voice Coil Subwoofer Mode

Possibly as popular as the single woofer is a pair of single voice coil subs in a standard "wedge" box for a vehicle trunk. Assuming each coil is 8 ohms, this places a load of 4 ohms on the amp which is fine. If each woofer is 4 ohms, this places a load of 2 ohms total which is possible for short periods but not recommended due to overheating of the amp and possible damage if used long term like this.

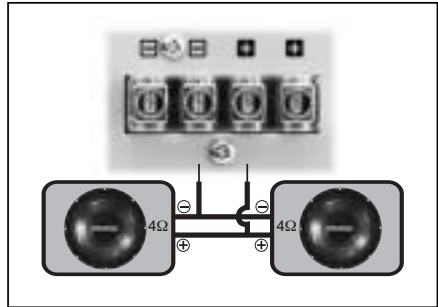

## SYSTEM CONFIGURATION #4

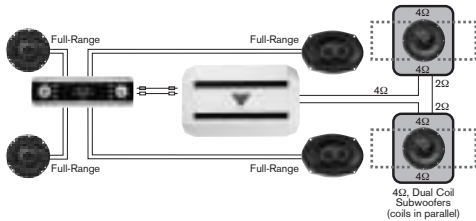

### 1 channel, Dual, Dual Voice Coil Subwoofer Mode

Dual, DVC subwoofers in a common wedge box in a car works great but is often forgotten. For a pair of DVC subwoofers with dual 4 ohm coils, this produces a 2 ohm load. Now, by placing these 2 speakers in series, we achieve a 4 ohm load to the amp which just works great! This can be a real pounder system if wired up right and places only moderate loads on the amp. Highly recommended!

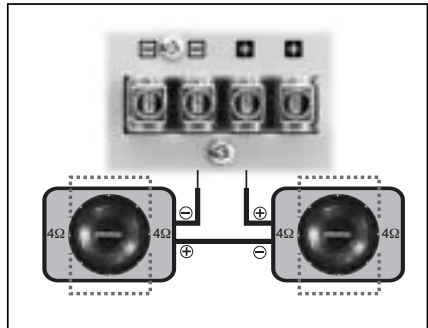

# TROUBLE-SHOOTING GUIDE

Below is a basic trouble-shooting guide to assist in seeking out and correcting a problem that may occur in the installation process. Although lengthy, this chart cannot address every single problem possible but mainly the ones most common.

SYMPTOM	PROBABLE CAUSE OR CORRECTION
No power (power light not on)	<ul style="list-style-type: none"> <li>• Check connections to amps +12 volt, ground, and remote lines.</li> <li>• Use voltmeter to verify voltages are at terminals of amp.</li> <li>• Check main power connection at battery.</li> <li>• Check fuse in power line at battery.</li> <li>• Disconnect all speakers but not power lines - if unit then turns on, a speaker short or speaker line touching vehicle chassis is likely.</li> </ul>
Power but no sound (power light is on)	<ul style="list-style-type: none"> <li>• Check all input cable lines for connection.</li> <li>• Disconnect speakers from amp, test speaker lines with digital voltmeter to verify &gt;2 ohms per channel (non-bridged mode).</li> </ul>
No sound from one channel or entire side	<ul style="list-style-type: none"> <li>• Check radio's balance and fader control positions - verify they are at center.</li> <li>• Check speaker connections at amp and speaker.</li> <li>• Check input leads for connection to amp.</li> </ul>
Very low sound level	<ul style="list-style-type: none"> <li>• Verify radio balance and fader controls are at center positions.</li> <li>• Check amplifier's input gain control setting - adjust for higher output levels if necessary (gain settings closer to 0.3 volts).</li> <li>• Receiver may have very low output voltage levels - a step up "line driver" may have to be used.</li> </ul>
Power amplifier turns on and off repeatedly (motor-boating sound)	<ul style="list-style-type: none"> <li>• Make sure power connections at batter are tight.</li> <li>• Verify battery voltage is &gt;11.5 volts DC (12.5-15V engine on) at amplifier with engine off.</li> <li>• Check all radio and amplifier ground connections.</li> </ul>
Amplifier turns off during loud or distorted passages	<ul style="list-style-type: none"> <li>• Input stage being over-driven - lower input gain (closer to 4 volt setting).</li> <li>• Verify battery voltage is &gt;11.5 volts DC at amplifier with engine off.</li> <li>• Check all radio and amplifier ground connections.</li> <li>• Verify speaker loads &gt;2 ohms on all channels (non-bridged mode).</li> </ul>
Amplifier performs fine but gets very hot to the touch	<ul style="list-style-type: none"> <li>• Input gain control too high - lower accordingly (closer to 4.0 volt setting).</li> <li>• Verify speaker loads &gt;2 ohms on all channels (non-bridged mode).</li> <li>• Verify the mounting location allows for free air movement around the amp. Preferably, the amp should be mounted with fins up and down so rising heat moves quickly away from amp.</li> </ul>
Amplifier turn-on/turn-off pops or noises	<ul style="list-style-type: none"> <li>• "turn on race" - disconnect trigger from radio and turn on/off via a wire jumper to power terminal. If noise goes away, the radio is turning on/off too slowly. This is radio problem and can only be corrected with outboard turn-on delay relay system.</li> <li>• Radio "thump" - disconnect the RCA input lines to the amp and turn on/off via radio trigger. If noise goes away without RCA lines connected, the radio is sending pops out through RCA lines. This is a radio problem and can only be corrected with outboard turn-on delay relay system.</li> </ul>
Cracking noises on AM/FM radio but not on tape or cd.	<ul style="list-style-type: none"> <li>• Ensure the problem is "radiated noise" by placing a portable FM radio near the car engine. If noise is picked up, then it is a vehicle problem and not your system. Research to isolate the source and properly shield or bypass.</li> <li>• Are spark plugs and wires &gt; 3 years old? These can often radiate substantial noise when old.</li> <li>• Verify the engine block has a good ground connection to chassis ground.</li> <li>• Verify the engine compartment hood is grounded to vehicle chassis via a braided grounding strap.</li> </ul>
Whining noise, engine running, varies in pitch or loudness with engine speed, AND varies with radio volume control setting ( <i>this is generally a RADIO installation problem</i> )	<ul style="list-style-type: none"> <li>• Verify all power and ground connections are clean at radio.</li> <li>• Re-route radio power and ground so they are sourced from same connections back at amplifier (this is called a "common" ground).</li> <li>• Check all ground connections to ensure clean surfaces that have all paint removed and also not oxidation buildup over time.</li> <li>• Verify there is some kind of power filtering choke assembly at back of radio. If not, install one.</li> </ul>
Whining noise, engine running, varies in pitch or loudness with engine speed, BUT, DOES NOT vary with radio volume control setting ( <i>this is generally an amplifier installation problem</i> )	<ul style="list-style-type: none"> <li>• Check battery ground connections at chassis are clean and tight, scraped free of oxidation, paint, and grease.</li> <li>• Re-route radio power and ground so they are sourced from same connections back at amplifier (this is called a "common" ground).</li> <li>• Bypass all equipment between radio and amp (e.g., equalizers) directly connecting radio. If noise goes away, signal processor has problem.</li> <li>• Check for signal level "ground loops" - disconnect the outer shield of the RCA cable at one end of the cable (e.g., radio end). If noise goes away, modify cables accordingly. There are voltage differences at the ground connections of the components and these are NOT correctable any other way than such shield cutting or an outboard "ground loop isolator" which is a small transformer.</li> </ul>

## GUARANTEE (EUROPEAN UNION)

We provide a manufacturer guarantee for our products bought within the European Union. You can view the guarantee conditions at [www.blaupunkt.de](http://www.blaupunkt.de) or ask for them directly at:

Blaupunkt GmbH  
Hotline  
Robert Bosch Str. 200  
D-31139 Hildesheim  
Germany

## LIMITED WARRANTY (UNITED STATES ONLY)

Robert Bosch Corporation (for products sold in the United States) warrants new Blaupunkt car audio products distributed in the United States through authorized Blaupunkt dealers, or which are imported as original vehicle equipment by the automobile manufacturer, to be free from defects in material and workmanship, in accordance with the following terms and conditions:

For twelve (12) months after delivery to you, the original consumer purchaser, we will repair or at our option replace at no charge to you any car audio product which, under normal conditions of use and service, proves to be defective in materials or workmanship. However, this warranty does not cover expenses incurred in the removal or reinstallation of any car audio product, whether or not proven defective, and does not cover products not purchased from an authorized Blaupunkt dealer. This warranty is limited to the original consumer purchaser and is not transferable. Repaired and replacement car audio products shall assume the identity of the original for purpose of this warranty and this warranty shall not be extended with respect to such products.

To obtain performance of this warranty, contact the nearest Blaupunkt authorized repair facility or our nearest office. A dated purchase receipt or other proof that the product is within the warranty period will be required in order to honor your claim. Carefully pack the unit and ship prepaid to the servicing location.

For further information: In the United States, write to the Robert Bosch Corporation, 2800 South 25th Avenue, Broadview, Illinois, 60155, attention Blaupunkt Customer Service Department or call 1-800-950-2528.

Specifically excluded from this warranty are failures caused by misuse, neglect, abuse, improper operation or installation, dropping or damaging a radio faceplate, unauthorized service or parts, or failure to follow maintenance instructions or perform normal maintenance activities. Normal maintenance activities for car audio products include but are not limited to cleaning, such as cleaning radio faceplate connectors and tape heads, tape player head demagnetization and tape player lubrication, compact disc and lens cleaning, and other minor maintenance activities and adjustments that are outlined in the owner's manual or that are normally required for continued proper operation. Also excluded from this warranty are the correction of improper installation and the elimination of any external electromagnetic interference.

THIS WARRANTY SETS FORTH YOUR EXCLUSIVE REMEDIES WITH RESPECT TO THE PRODUCTS COVERED BY IT. WE SHALL NOT BE LIABLE FOR ANY INCIDENTAL, CONSEQUENTIAL, SPECIAL OR PUNITIVE DAMAGES ARISING FROM THE SALE OR USE OF ANY BLAUPUNKT CAR AUDIO PRODUCTS, WHETHER SUCH CLAIM IS IN CONTRACT OR TORT. NO ATTEMPT TO ALTER, MODIFY, OR AMEND THIS WARRANTY SHALL BE EFFECTIVE UNLESS AUTHORIZED IN WRITING BY AN OFFICER OF ROBERT BOSCH CORPORATION.

THIS WARRANTY IS IN LIEU OF ALL OTHER WARRANTIES OR REPRESENTATIONS, EXPRESS OR IMPLIED, INCLUDING ANY WARRANTY IMPLIED BY LAW, WHETHER FOR MERCHANTABILITY OR FITNESS FOR A PARTICULAR PURPOSE OR OTHERWISE AND SHALL BE EFFECTIVE ONLY FOR THE PERIOD THAT THIS EXPRESS WARRANTY IS EFFECTIVE.

ANY IMPLIED WARRANTY SHALL BE LIMITED IN DURATION TO ONE YEAR FROM DATE OF PURCHASE. SOME STATES IN THE U.S. DO NOT ALLOW LIMITATIONS ON HOW LONG IMPLIED WARRANTY LASTS. SO THE ABOVE LIMITATIONS MAY NOT APPLY TO YOU.

THIS LIMITED WARRANTY GIVES YOU SPECIFIC LEGAL RIGHTS, AND YOU MAY ALSO HAVE OTHER RIGHTS WHICH VARY FROM STATE TO STATE IN THE U.S.

In the event any provision, or any part or portions of this warranty shall be held invalid, void or otherwise unenforceable, such holding shall not affect the remaining part or portions of that provision or any other provision hereof.

ROBERT BOSCH CORPORATION  
BLAUPUNKT CUSTOMER SERVICE  
2800 SOUTH 25TH AVENUE  
BROADVIEW, IL 60155  
TEL: 1-800-950-2528

## BLAUPUNKT TECHNICAL SUPPORT

Blaupunkt is constantly working on making the operating instructions clearer and easier to understand. However, if you still have questions on how to operate the amplifier, please contact your dealer or the telephone hotline for your country. You will find the hotline telephone numbers printed at the back of this booklet.

**SERVICE NUMBERS • SERVICE-NUMMERN • NUMÉROS DU SERVICE APRÈS-VENTE  
 NUMERI DEL SERVIZIO DI ASSISTENZA • NÚMEROS DE SERVICIO  
 NÚMERO DE SERVIÇO • SERVICENUMMERS • TELEFONNUMMER FÖR SERVICE**

<b>Country:</b>	<b>Phone:</b>	<b>Fax:</b>	<b>WWW:</b>
Germany	(D) 0180-5000225	05121-49 4002	<a href="http://www.blaupunkt.com">http://www.blaupunkt.com</a>
Austria	(A) 01-610 3150	01-610 393 91	
Belgium	(B) 02-525 51004	02-525 5263	
Denmark	(DK) 44 898 360	44-898 644	
Finland	(FIN) 09-435 991	09-435 99236	
France	(F) 01-4010 10007	01-4010 7320	
Great Britain	(GB) 01-89583 8880	01-89583 8394	
Greece	(GR) 0800-550 6550	01-576 9473	
Ireland	(IRL) 01-4149400	01-10098830	
Italy	(I) 02-369 6331	02-369 6464	
Luxembourg	(L) 40 4078	40 2085	
Netherland	(NL) 023-565 6348	023-565 6331	
Norway	(N) 66-817 000	66-817 157	
Portugal	(P) 01-2185 00144	01-2185 11111	
Spain	(E) 1502-120234	916-467952	
Sweden	(S) 08-7501500	08-7501810	
Switzerland	(CH) 01-8471644	01-8471650	
Czech. Rep.	(CZ) 02-6130 0441	02-6130 0514	
Hungary	(H) 01-333 9575	01-324 8756	
Poland	(PL) 0800-118922	022-8771260	
Turkey	(TR) 0212-3400677	0212-3460040	
USA	(USA) 800-950-2528	708-681-7188	<a href="http://www.blaupunktusa.com">http://www.blaupunktusa.com</a>
Brazil			
(Mercosur)	(BR) +55-19 37100 2769	+55-19 37100 2773	
Malaysia			
(Asia Pacific)	(MAL) +604-6382 474	+604-6413	



Robert Bosch Corporation  
 Sales Group - Mobile  
 Communications Division  
 2800 S. 25th Avenue  
 Broadview, IL 60155 U.S.A.

Blaupunkt GmbH  
 Robert Bosch Strasse 200  
 D-31139 Hildesheim  
 Germany

[www.blaupunkt.com](http://www.blaupunkt.com)

[www.blaupunktusa.com](http://www.blaupunktusa.com)

Copyright 2005 by the Robert Bosch Corporation  
 No portion of this work may be reproduced in any form without the written consent of the Robert Bosch Corporation

Printed in China

## Free Manuals Download Website

<http://myh66.com>

<http://usermanuals.us>

<http://www.somanuals.com>

<http://www.4manuals.cc>

<http://www.manual-lib.com>

<http://www.404manual.com>

<http://www.luxmanual.com>

<http://aubethermostatmanual.com>

Golf course search by state

<http://golfingnear.com>

Email search by domain

<http://emailbydomain.com>

Auto manuals search

<http://auto.somanuals.com>

TV manuals search

<http://tv.somanuals.com>