



Radio / CD

Casablanca CD52 Heidelberg CD52

US version

Operating instructions



<http://www.blaupunkt.com>

 **BLAUPUNKT**

Download from www.Somanuals.com. All Manuals Search And Download.

Open here
Ouvrir s.v.p.
Por favor, abrir
Favor abrir

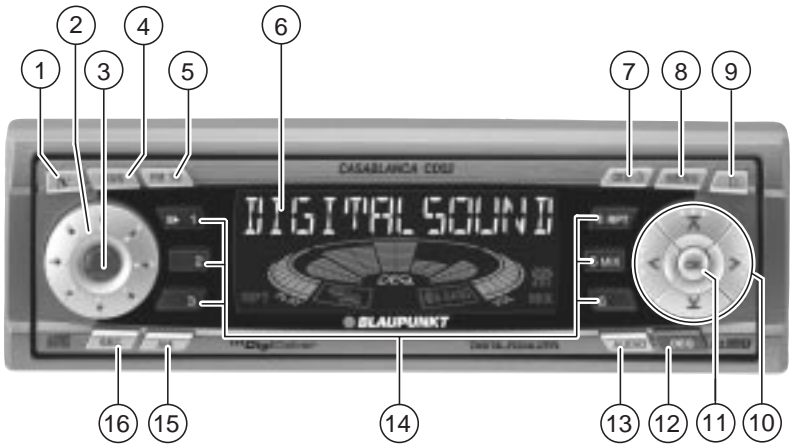

CONTROLS



- ①  button - unlatches the flip/release panel
- ② Volume control
- ③ Button - switches the radio and mute function on/off
- ④ **RDS** button, to switch the RDS function on/off (Radio Data System).
- ⑤ **FM** button, to select the FM radio mode source and select the FM memory banks
TS, to start the Travelstore function
- ⑥ Display (display field)
- ⑦ **DIS**, change display contents
 button - indicates the time on the display
- ⑧ **MENU** button - selects the menu for basic settings
- ⑨  button - opens the flip/release panel
- ⑩ Arrow-key block
- ⑪ **OK** button - confirms menu entries and starts the scan function
- ⑫ **DEQ** button (digital equalizer) - switches the equalizer on/off
- ⑬ **AUDIO** button - adjusts bass, treble, X-BASS, balance and fader
- ⑭ Key block **1 - 6**
- ⑮ **AM** button, to select the AM radio mode source and select the AM memory banks
- ⑯ **SRC** button - selects between CD, CD changer/Compact Drive MP3 (if connected) and AUX sources

TABLE OF CONTENTS

Notes and accessories	6	CD changer mode	18
Flip/release panel	7	Starting CD changer mode	18
Switching on/off	8	Selecting a CD	18
Volume adjustment	9	Selecting a track	18
Radio mode	10	Fast search (audible)	18
Setting the tuner	10	Changing the display	18
Switching to radio mode	11	Repeating individual tracks or whole CDs (REPEAT)	19
Switching the RDS function on/off	11	Random play (MIX)	19
Selecting the waveband / memory bank	11	Scanning all tracks on all CDs (SCAN)	19
Tuning into a station	11	Interrupting Play (PAUSE)	19
Setting the sensitivity of station seek tuning	11	Naming CDs	20
Storing stations	12	CLOCK - Time	21
Storing stations automatically (Travelstore)	12	Tone and volume balance	22
Listening to stored stations	12	Equalizer	23
Scanning receivable stations (SCAN)	12	Notes on adjusting the equalizer	23
Setting the scantime	12	Switching the equalizer on/off	24
Programme type (PTY)	13	Setting the equalizer	24
Optimising radio reception	13	Selecting sound presets	24
Displaying scrolling text	14	Selecting car presets	24
Setting the display	14	Setting the level indicator	25
CD Mode	15	Setting aid for the equalizer	25
Starting CD mode	15	External audio sources	26
Selecting a track	15	Technical data	26
Quick track selection	15	Installation instructions	101
Fast search (audible)	15		
Random play (MIX)	16		
Scanning tracks (SCAN)	16		
Repeating a track (REPEAT)	16		
Interrupting play (PAUSE)	16		
Changing the display	16		
Naming CDs	17		
Displaying CD text	17		
Removing a CD	18		

NOTES AND ACCESSORIES

Notes and accessories

Thank you for deciding to use a Blaupunkt product. We hope you enjoy using this new piece of equipment.

Please read these operating instructions before using the equipment for the first time.

The Blaupunkt editors are constantly working on making the operating instructions clearer and easier to understand. However, if you still have any questions on how to operate the equipment, please contact your dealer or the telephone hotline for your country. You will find the telephone numbers printed at the back of this booklet.

We provide a manufacturer guarantee for our products bought within the European Union. You can view the guarantee conditions at www.blaupunkt.de or ask for them directly at:

Blaupunkt GmbH
Hotline
Robert Bosch Str. 200
D-31139 Hildesheim

Road safety

 Road safety has priority. Only operate your car radio if road and traffic conditions allow. Familiarise yourself with the unit before setting off on your journey.

You should always be able to hear police, fire and ambulance sirens in good time. For this reason, set the volume of your car radio at a suitable level.

Installation

If you would like to install your car radio yourself, please read the installation and connection instructions at the end of the manual.

Accessories

Please use only Blaupunkt-approved accessories.

Remote controls

The most important functions of your car radio can be selected safely and conveniently from the steering wheel using the remote controls RC 08, RC 10 or RC 10H (available as an optional extra).

The radio cannot be switched on/off via remote control.

Amplifiers

All Blaupunkt amplifiers are suitable for use with the radio.

CD changer

The following Blaupunkt CD changers can be connected to the radio:
CDC A 02, CDC A 08 and IDC A 09.

Compact Drive MP3

As an alternative to a CD changer, you can connect a Compact Drive MP3 to access MP3 music tracks. If you connect a Compact Drive MP3, you will first need to use a computer to store the MP3 music tracks on the Microdrive™ hard disk inside the Compact Drive MP3. Then, when the Compact Drive MP3 is connected to the car radio, you can play the tracks like normal CD music tracks. The Compact Drive MP3 is operated in the same way as a CD changer. Most of the CD changer functions can also be used with the Compact Drive MP3.

Amplifier / sub-out (only Casablanca CD52)

The car radio provides connections for connecting external amplifiers and a subwoofer.

We recommend you use well-matched products from the Blaupunkt or Velocity product ranges.

Flip/release panel

Theft protection

Your car radio is fitted with a flip/release panel to guard against theft. Without this panel, the unit is worthless to the thief. Protect your unit from theft by taking the flip/release panel with you every time you leave the car. Do not leave the panel behind in the car, even if it is out of sight. The constructive design of the panel makes for simple handling.

Note:

- Do not drop the flip/release panel.
- Do not expose the flip/release panel to direct sunshine or other sources of heat.
- Keep the flip/release panel in the case provided.
- Avoid direct skin contact with the flip/release panel. Please clean it when necessary with some white spirit on a lint-free cloth.

Removing the flip/release panel

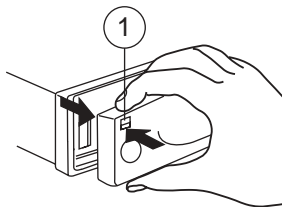

⇨ Press the [V] button ①.

This unlatches the flip/release panel.

- ⇨ First pull the flip/release panel straight and then to the left out of the unit.
- After removing the flip/release panel, the unit switches itself off.
- All the current settings are saved.
- If there is a CD in the unit, it remains there.

Attaching the flip/release panel

- ⇨ Slide the flip/release panel from left to right into the unit guide.
- ⇨ Press the left side of the panel into the unit until it slots into place.

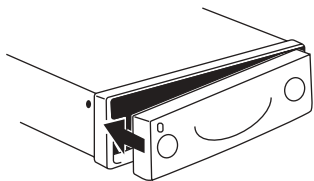

Note:

- Do not press against the display while attaching the flip/release panel.

If the device was still switched on when you removed the control panel, it will automatically switch on again with the last settings activated (i.e. radio, CD, CD changer/Compact Drive MP3 or AUX) when the panel is replaced.

Switching on/off

There are various ways of switching the car radio on and off, as described below.

Switching on/off using the ignition

If the car radio is correctly connected to the ignition and has not been switched off using the button ③, it is switched on/off simultaneously with the ignition.

You can also switch on your car radio when the vehicle ignition is off.

⇨ To do so, press the button ③.

Note:

To protect the vehicle battery, the unit switches off automatically after one hour.

Switching on/off using the flip/release panel

⇨ Remove the flip/release panel.

The unit switches itself off.

⇨ Replace the flip/release panel once more.

The car radio is switched on. The last settings (radio, CD, CD changer/Compact Drive MP3 or AUX) are activated.

Switching on/off using the button

③

⇨ To switch the unit on, press the button ③.

⇨ To switch the unit off, hold the button ③ down for more than two seconds.

The car radio is now switched off.

Volume adjustment

The system volume can be adjusted in steps from 0 (off) to 66 (maximum).

- ⇒ To raise the system volume, turn the volume control (2) to the right.
- ⇒ To lower the system volume, turn the volume control (2) to the left.

Setting the switch-on volume

You can set the volume at which you wish the car radio to play when switched on.

- ⇒ Press the **MENU** button (8).
- ⇒ Press the **∨** or **∧** button (10) repeatedly until "ON VOLUME" appears on the display.
- ⇒ Use the **<>** buttons (10) to set the switch-on volume.

If you select "LAST VOL", the volume played before the unit was last switched off will be reactivated.

Note:

- To protect your hearing, the maximum switch-on volume under the "LAST VOL" setting is "38". If the volume was higher before the unit was switched off and "LAST VOL" has been selected, the volume will be set at "38" the next time the radio is switched on.

When you have completed setting the volume,

- ⇒ press the **MENU** button (8).

Mute setting

This feature enables you to lower the system volume instantaneously (mute).

- ⇒ Briefly press button (3).

"MUTE" appears on the display.

Telephone Audio/Navigation Audio

If your car radio is connected to a mobile telephone or a navigation system, the volume will be muted as soon as you "pick up" the telephone or the radio relays voice output from the navigation system and the conversation or voice output is heard through the radio's loudspeakers. In order for this to work, the mobile telephone or navigation system has to be connected to the car radio as described in the instructions. For this, you need adapter cable Blaupunkt no. 7 607 001 503.

To find out which navigation systems are compatible with your car radio, please consult your Blaupunkt dealer.

The volume at which telephone conversations and voice output from the navigation system are switched on is adjustable.

- ⇒ Press the **MENU** button (8).
- ⇒ Press the **∨** button (10) repeatedly until "TEL/NAVI VOL" appears on the display.
- ⇒ Use the **<>** buttons (10) to set the desired volume.
- ⇒ When you have completed the settings, press either the **MENU** button (8) or **OK** (11).

Note:

You can adjust the volume for telephone conversations and voice output while they are being heard by using the volume control (2).

Automatic Sound**(only Casablanca CD52)**

This function adjusts the volume of your car radio automatically to your driving speed. This requires your device to be connected as described in the installation guide.

The automatic volume booster can be set in six stages (0-5).

- ⇒ Press the **MENU** button (8).
- ⇒ Press the **V** button (10) until "AUTO SOUND" appears in the display.
- ⇒ Set the volume adjustment with the **<>** buttons (10).
- ⇒ When the setting process is complete, press the **MENU** button (8) or **OK** (11).

Note:

The right speed-adjusted volume setting depends on noise levels inside your car. Try various values (0-5) until you find the best setting.

Radio mode

This unit is equipped with an RDS radio receiver. Many of the receivable FM stations transmit a signal that not only carries the programme but also additional information such as the station name and programme type (PTY).

The station name appears in the display as soon as the radio is able to receive it and the RDS function is activated. You can optionally display the programme type. For further details, please read the section entitled "Programme type (PTY)".

Setting the tuner

To ensure that the tuner works properly, the device must be configured for your region. You can choose between Europe (EUROPE) and the USA (N AMERICA). By default, the tuner is set to the region in which the device was sold. If you experience problems with radio reception, please check this setting.

These operating instructions refer to the "N AMERICA" setting.

- ⇒ Press the **MENU** button (8).
- ⇒ Keep pressing the **V** button (10) until "TUNER AREA" appears in the display.
- ⇒ Press the **<** or **>** button (10) for longer than two seconds to switch between "EUROPE" and "N AMERICA".
- ⇒ Press the **MENU** button (8) or **OK** (11).

Switching to radio mode

If you are in CD, CD changer/Compact Drive MP3 or AUX mode,

⇨ press the **FM TS** button (5) for FM radio mode.

or

⇨ press the **AM** button (15) for AM radio mode.

Switching the RDS function on/off

⇨ To use the RDS functions, press the **RDS** button (4).

The RDS function is active when RDS lights up in the display with a symbol.

Selecting the waveband / memory bank

This unit can receive programmes broadcast over the FM and AM wavebands. There are three memory banks (FM1, FM2 and FMT) for the FM waveband and two memory banks (AM and AMT) for the AM waveband.

Six stations can be stored in each memory bank.

To switch between the FM memory banks,

⇨ briefly press the **FM TS** button (5) repeatedly until the required memory bank appears in the display.

To switch between the AM memory banks,

⇨ briefly press the **AM** button (15) repeatedly until the required memory bank appears in the display.

Tuning into a station

There are various ways of tuning into a station.

Automatic seek tuning

⇨ Press the **∨** or **∧** button (10).

The unit tunes into the next receivable station.

Tuning into stations manually

You can also tune into stations manually.

⇨ Press the **<** or **>** button (10).

Note:

You can only tune into stations manually on the FM waveband if the RDS and PTY functions are deactivated.

Setting the sensitivity of station seek tuning

You can choose whether to only tune into stations with a strong reception or to also tune into those with a weak reception.

⇨ Press the **MENU** button (8).

⇨ Keep pressing the **∨** button (10) until "SENS" appears in the display.

⇨ Press the **>** button (10).

The display shows the currently set sensitivity level. "SENS 6" means that the tuner is set to the highest sensitivity setting. "SENS 1" is the lowest setting.

⇨ Set the required sensitivity using the **<** or **>** button (10).

RADIO MODE

When you have finished making your changes,

- ⇒ press the **MENU** button (8) or **OK** (11).

Storing stations

Storing stations manually

- ⇒ Select the required memory bank (FM1, FM2 or FMT) or the AM waveband.
- ⇒ Tune into the required station.
- ⇒ Press one of the station buttons **1 - 6** (14) for longer than two seconds to store the station to that button.

Storing stations automatically (Travelstore)

You can automatically store the six stations with the strongest reception in the region. The stations are stored in the FMT memory bank in FM radio mode or in the AMT memory bank in AM radio mode.

Note:

Any stations that were previously stored in these memory banks are deleted in the process.

- ⇒ Keep the **FM TS** button (5) pressed for longer than two seconds.

The station storing procedure begins. "TRAVEL-STORE" appears in the display. After the process is completed, the station stored in location 1 of the FMT or AMT memory bank will be played.

Listening to stored stations

- ⇒ Select the memory bank or waveband.
- ⇒ Press the station button **1 - 6** (14) that corresponds to the station you want to listen to.

Scanning receivable stations (SCAN)

You can briefly play (scan) all the receivable stations. You can set the scanning time (scantime) to between 5 and 30 seconds in the menu.

Starting SCAN

- ⇒ Keep the **OK** button (11) pressed for longer than two seconds.

Scanning begins. "SCAN" appears briefly in the display followed by a flashing display of the current station name or frequency.

Stopping SCAN and continuing listening to a station

- ⇒ Press the **OK** button (11).

Scanning is stopped and the station that was tuned into last will remain active.

Setting the scantime

- ⇒ Press the **MENU** button (8).
- ⇒ Keep pressing the **∇** button (10) until "SCANTIME" appears in the display.
- ⇒ Set the required scantime using the **<** or **>** buttons (10).
- ⇒ When you have finished making your changes, press the **MENU** button (8) or **OK** (11).

Note:

The set scantime also applies to scanning in CD mode but not to scanning in CD changer mode.

Programme type (PTY)

Besides transmitting the station name, some FM stations also provide information on the type of programme that they are broadcasting. Your radio can receive and display this information.

For example, the programme types can be:

ROCK	CLS_ROCK	TOP_40
ADLT_HIT	COUNTRY	OLDIES
SOFT_RCK	SPORTS	TALK

Using the PTY function, you can directly select stations of a particular programme type.

Switching PTY on/off

- ⇨ Press the **MENU** button (8).
- ⇨ Keep pressing the **↵** or **↶** button (10) until "PTY ON" or "PTY OFF" appears in the display.
- ⇨ Press the **<** or **>** button (10) to switch PTY ON or OFF.

When PTY is switched on, PTY lights up in the display.

- ⇨ Press the **MENU** button (8) or **OK** (11).

Selecting a programme type and starting seek tuning

- ⇨ Press the **<** or **>** button (10).

The current programme type appears in the display.

- ⇨ If you want to select another programme type, you can do so by pressing the **<** or **>** button (10) whilst this display is visible.

Or

- ⇨ Press one of the buttons **1 - 6** (14) to select a programme type that is stored on one of these buttons.

The selected programme type is displayed briefly.

- ⇨ Press the **↵** or **↶** button (10) to start seek tuning.

The next station corresponding to your selected programme type will then be tuned into.

Storing a programme type on a station button

- ⇨ Select a programme type using the **<** or **>** button (10).
- ⇨ Keep the required station button **1 - 6** (14) pressed for longer than two seconds.

The programme type is now stored on the selected button **1 - 6** (14).

Optimising radio reception

Treble reduction feature during interference (HICUT)

The HICUT function improves reception during poor radio reception (only FM). If interference occurs, the treble is automatically reduced thus reducing the interference level.

Switching HICUT on/off

- ⇨ Press the **MENU** button (8).

RADIO MODE

⇨ Keep pressing the **V** button (10) until “HICUT” appears in the display.

⇨ Press the **<** or **>** button (10) to adjust HICUT.

“HICUT 0” means that no reduction will be made, “HICUT 3” means a maximum automatic reduction of the treble and interference level will be applied.

⇨ Press the **MENU** button (8) or **OK** (11).

Switching bandwidth during interference (SHARX)

The SHARX function allows you to largely avoid interference caused by neighbouring radio stations (FM only). Switch on the SHARX function if you experience a high radio station density.

Switching SHARX on/off

⇨ Press the **MENU** button (8).

⇨ Keep pressing the **V** button (10) until “SHARX” appears in the display.

⇨ Press the **<** or **>** button (10) to switch SHARX on/off.

“SHARX OFF” means automatic bandwidth switching is deactivated, “SHARX ON” means it is activated.

⇨ Press the **MENU** button (8) or **OK** (11).

Displaying scrolling text

Some radio stations use the RDS signal to transmit advertising or other information instead of their station name. These scrolling texts appear in the display.

You can deactivate the “scrolling text” display for stations that you have stored on the station buttons.

⇨ Keep the **RDS** button (4) pressed until “NAME FIX” appears in the display.

⇨ To allow scrolling texts to appear in the display again, keep the **RDS** button (4) pressed until “NAME VAR” appears in the display.

Note:

If you tune into an already stored station using a different means (e.g. using SCAN or by searching), the “scrolling texts” will be displayed.

Setting the display

When in radio mode, you have the option of continuously displaying the time or continuously displaying the station name or frequency.

⇨ Keep the **DIS**  button (7) pressed until the required display appears.

CD Mode

You can use this unit to play standard CDs with a diameter of 12 cm.

CD-Rs and CD-RWs (CDs that you have “burned” yourself) can generally also be played. Due to the varying quality of CDs, Blaupunkt cannot guarantee that this will work properly.

To ensure the system functions properly, only use CDs labelled with the compact disc logo. Problems might be experienced when trying to play copy-protected CDs. Blaupunkt cannot guarantee the proper functioning of copy-protected CDs!



Risk of damage to CD drive!
Single CDs with a diameter of 8 cm and CDs which are not circular (“shape CDs”) should not be used. We accept no liability for any damage to the CD drive that may occur as a result of the use of unsuitable CDs.

Starting CD mode

- If there is no CD in the drive,

⇒ Press the **⏏** button (9).

The flip/release panel opens.

⇒ Gently insert the CD into the CD compartment with the printed side uppermost until you feel some resistance.

The CD will be drawn into the drive. Do not hinder or assist the drive as it draws the CD in.

⇒ Close the panel using light pressure until you feel it latch into place.

CD playback begins.

- If there is already a CD in the drive,
 - ⇒ press the **SRC** button (16) repeatedly until “CD” appears on the display.

Playback begins from the point at which it was last interrupted.

Selecting a track

⇒ Press one of the buttons on the arrow block (10) to select the next or previous track.

If the **↵** or **⏮** button (10) is pressed once, the current track is played again from the beginning.

Quick track selection

To quickly select tracks backwards or forwards,

⇒ keep one of the **↵**/**⏮** buttons (10) pressed until fast reverse / forward track selection begins.

Fast search (audible)

For a fast search backwards or forwards

⇒ keep the **⏮**/**⏭** buttons (10) pressed until the fast search backwards or forwards begins.

CD MODE

Random play (MIX)

- ⇨ Press the button **5 MIX** (14).
“MIX CD” appears briefly on the display, the MIX symbol lights up. The next track played will be randomly selected.

Stopping MIX

- ⇨ Press the button **5 MIX** (14) once again.
“MIX OFF” appears briefly on the display, the MIX symbol goes out.

Scanning tracks (SCAN)

You can briefly listen in to all the tracks on a CD.

- ⇨ Hold down the **OK** button (11) for more than two seconds. The next track starts to play.

Note:

The scanning time is adjustable. Read about setting the scanning time in the section “Setting the scanning time” in the chapter “Radio mode”.

Stopping SCAN and continuing playback

- ⇨ Press the **OK** button (11) to end scanning.
The current track will then continue to play.

Repeating a track (REPEAT)

- ⇨ If you would like to repeat a track, press button **4 RPT** (14).
“REPEAT TRCK” appears briefly on the display, the RPT symbol lights up. The track is then repeated until RPT is deactivated.

Stopping REPEAT

- ⇨ If you would like to end repeat, press the button **4 RPT** (14) once again.
“REPEAT OFF” appears briefly on the display, the RPT symbol goes out. Normal playback is resumed.

Interrupting play (PAUSE)

- ⇨ Press the button **1** (14).
“PAUSE” appears on the display.

Ending Pause

- ⇨ Press the button **1** (14) during the pause.
Play then resumes.

Changing the display

- ⇨ To alter the display between track number and time or track number and playing time or track number and CD name, press the **DIS** (7) button once or several times for more than two seconds until the desired elements appear on the display.

Naming CDs

To make it easier for you to recognise your CDs, the car radio offers an individual name option for 30 CDs. The names should have a maximum of eight digits. If you attempt to allocate more than 30 names, "FULL" will appear on the display.

Entering/altering CD names

- ⇒ Listen to the desired CD.
- ⇒ Press the **MENU** button (8).
- ⇒ Use the **↵** buttons (10) to select "CD NAME".
- ⇒ Press the **<** or **>** button (10) twice.

You are now in the edit mode. If the CD you have selected is still unnamed, eight underlines appear on the display.

The current input position flashes.

- ⇒ Use the **↵** buttons (10) to select your characters. If a position is left blank, you have selected the underline.
- ⇒ Use the **<** or **>** button (10) to proceed to your next input position.
- ⇒ Press the **MENU** button (8) or **OK** (11) to save the name entered.

Clearing a CD name

- ⇒ Listen to the CD whose name you wish to clear.
- ⇒ Press the **MENU** button (8).
- ⇒ Use the **↵** buttons (10) to select "CD NAME".
- ⇒ Press the **<** or **>** button (10).

- ⇒ Hold down the **MENU** button (8). A beep sounds at the end of four seconds and "DELETE NAME" appears on the display.

- ⇒ Release the **MENU** button (8).

The CD name is now deleted.

- ⇒ Press the **OK** button (11) to return to the menu.

Displaying CD text

Some CDs feature so-called CD text. The CD text may include the name of the performer, the album and the track name.

You can have the CD text displayed as running text at every change of track. After the CD text has been displayed once, the standard display is used. Please see the section "Changing the display". If the CD in the player contains no CD text, "NO TEXT" will appear on the display when the CD text function is activated.

Switching CD text on/off

- ⇒ Press the **MENU** button (8).
- ⇒ Press the **↵** button (10) repeatedly until "CD TEXT" appears on the display.
- ⇒ Switch on the CD text function by pressing the **<>** buttons (10) ("CD TEXT ON") or off ("CD TEXT OFF").
- ⇒ When you have completed the setting procedure, press the **MENU** button (8) or **OK** (11).

Removing a CD

- ⇨ Press the  button (9).

The flip/release panel opens to the front and the CD is ejected.

- ⇨ Carefully remove the CD and close the flip/release panel.

CD changer mode

Note:

Information on handling CDs, inserting CDs and operating the CD changer can be found in the operating instructions accompanying your CD changer.

Starting CD changer mode

- ⇨ Press the **SRC** button (16) repeatedly until "CHANGER" appears on the display.

Playback begins with the first CD the CD changer recognises.

Selecting a CD

- ⇨ To change up or down to a different CD, press the **↕** or **↔** button (10) once or several times.

Selecting a track

- ⇨ To move up/down from one track to another on the current CD, press the **<** or **>** button (10) once or several times.

Fast search (audible)

For a fast search backwards or forwards

- ⇨ keep the **<>** buttons (10) pressed until the fast search backwards or forwards begins.

Changing the display

- ⇨ To alter the display between track number and playing time or track number and time or track number and CD number or track number and CD name, press the **DIS**  (7) button once or several times for

more than two seconds until the desired elements appear on the display.

Repeating individual tracks or whole CDs (REPEAT)

- ⇨ To repeat the current track, press the button **4 RPT** (14) briefly.

“REPEAT TRCK” appears briefly on the display and RPT lights up.

- ⇨ To repeat play of the entire CD, press the button **4 RPT** (14) once again.

“REPEAT DISC” appears briefly on the display and RPT lights up.

Stopping REPEAT

- ⇨ To stop the repeat function for the current track or CD, press the button **4 RPT** (14) repeatedly until “REPEAT OFF” appears briefly on the display and RPT goes out.

Random play (MIX)

- ⇨ To play the tracks on the current CD in random order, press the button **5 MIX** (14).

“MIX CD” appears briefly on the display and MIX lights up.

- ⇨ To play the tracks of all the inserted CDs in random order, press the button **5 MIX** (14) once again.

“MIX ALL” appears briefly on the display and MIX lights up.

Stopping MIX

- ⇨ Press the button **5 MIX** (14) until “MIX OFF” appears briefly on the display and MIX goes out.

Scanning all tracks on all CDs (SCAN)

- ⇨ To listen in briefly to all the tracks on all inserted CDs in ascending order, hold down the **OK** button (11) for more than two seconds.

“SCAN” appears on the display.

Stopping SCAN

- ⇨ To stop scanning, press the **OK** button (11) briefly.

The track currently being scanned then continues play.

Interrupting Play (PAUSE)

- ⇨ Press the button **1** (14).

“PAUSE” appears on the display.

Ending Pause

- ⇨ Press the button **1** (14) during the pause.

Play then resumes.

CD CHANGER MODE

Naming CDs

To make it easier for you to recognise your CDs, the car radio offers an individual name option for 99 CDs. The names should have a maximum of seven digits.

If you attempt to allocate more than 99 names, "FULL" will appear on the display.

Entering/altering CD names

- ⇒ Press the **MENU** button (8).
- ⇒ Use the **↵** buttons (10) to select "CDC NAME".
- ⇒ Press the **< or >** button (10).

The name of the CD appears on the display.

- ⇒ Press the **< or >** button (10).

You are now in the edit mode. If the CD you have selected is still unnamed, seven underlines appear on the display.

The current input position flashes.

- ⇒ Use the **↵** buttons (10) to select your characters. If a position is left blank, you have selected the underline.
- ⇒ Use the **< or >** button (10) to proceed to your next input position.
- ⇒ Press the **MENU** button (8) or **OK** (11) to save the name entered.

Clearing a CD name

- ⇒ Listen to the CD whose name you wish to clear.
- ⇒ Press the **MENU** button (8).

- ⇒ Use the **↵** buttons (10) to select "CDC NAME".
- ⇒ Press the **< or >** button (10).
- ⇒ Hold down the **MENU** button (8). A beep sounds at the end of four seconds and "DELETE NAME" appears on the display.
- ⇒ Release the **MENU** button (8).

The CD name is now deleted.

- ⇒ Press the **OK** button (11) to return to the menu.

Clearing all CD names

All CD names saved are deleted.

- ⇒ Listen to a CD.
- ⇒ Press the **MENU** button (8).
- ⇒ Use the **↵** buttons (10) to select "CDC NAME".
- ⇒ Press the **< or >** button (10).
- ⇒ Hold down the **MENU** button (8). A beep sounds at the end of four seconds and "DELETE NAME" appears on the display. Continue to hold down the **MENU** button (8) until a second beep sounds and "DELETE ALL" appears on the display.
- ⇒ Release the **MENU** button (8).

All CD names in the CD changer are now deleted.

- ⇒ Press the **OK** button (11) to return to the menu.

CLOCK - Time

Briefly displaying the time

- ⇨ Press the **DIS** (7) button briefly to display the time.

Setting the time

The time can be set automatically using the RDS signal. If you are unable to receive an RDS station or the station you are listening to does not support this function, it is also possible for you to set the clock manually.

Setting the time automatically

- ⇨ To set the time automatically, press the **MENU** button (8).
- ⇨ Press the **√** button (10) repeatedly until "CLK MANUAL" (manual) or "CLK AUTO" (automatic) appears on the display.
- ⇨ Press the **<** button (10) until "CLK AUTO" appears on the display.
- ⇨ Press the **MENU** button (8) or **OK** (11) once you have completed the setting.

As soon as a station with the RDS time function (RDS-CT) is received, the clock is set automatically.

Setting the time manually

- ⇨ To set the time manually, press the **MENU** button (8).
- ⇨ Press the **√** button (10) repeatedly until "CLOCKSET" appears on the display.
- ⇨ Press the **>** button (10).

The time appears on the display. The minutes flash and can now be set.

- ⇨ Set the minutes using the **√** **↔** buttons (10).
- ⇨ Once the minutes have been set, press the **<** button (10). The hours now flash.
- ⇨ Set the hours using the **√** **↔** buttons (10).
- ⇨ Press the **MENU** button (8) or **OK** (11) once you have completed the setting.

Selecting the 12/24-hour clock mode

- ⇨ Press the **MENU** button (8). "MENU" appears on the display.
- ⇨ Press the **√** button (10) repeatedly until "24 H MODE" or "12 H MODE" appears on the display.
- ⇨ Press the **<>** buttons (10) to switch between the 12 and 24-hour mode.
- ⇨ Press the **MENU** button (8) or **OK** (11) once you have completed the setting.

TONE AND VOLUME BALANCE

Tone and volume balance

You can adjust the sound settings for each source separately (radio, CD, CD changer/Compact Drive MP3 and AUX).

Adjusting the bass

- ⇒ Press the **AUDIO** (13) button.
- “BASS” appears on the display.
- ⇒ Press the **∨** or **∧** button (10) to set the bass.
- ⇒ Press the **AUDIO** button (13) or **OK** (11) once you have completed the setting.

Adjusting the treble

- ⇒ Press the **AUDIO** (13) button.
- “BASS” appears on the display.
- ⇒ Press the **>** button (10) repeatedly until “TREBLE” appears on the display.
- ⇒ Press the **∨** or **∧** button (10) to set the treble.
- ⇒ Press the **AUDIO** button (13) or **OK** (11) once you have completed the setting.

Setting the X-BASS

X-BASS means that the bass is raised to a comfortable level at lower volume levels. You can adjust the X-BASS function individually for all audio sources. When X-BASS is activated, the X-BASS symbol lights up on the display.

- ⇒ Press the **AUDIO** button (13).
- “BASS” appears on the display.
- ⇒ Press the **>** button (10) repeatedly until “X-BASS” appears on the display.
- ⇒ Press the **∨** or **∧** button (10) to select X-BASS.
- “XBASS 0” means that X-BASS is switched off.
- ⇒ After completing the setting, press the **AUDIO** button (13) or **OK** (11).

Setting the volume distribution left/right (balance)

- ⇒ To set the volume distribution left/right (balance), press the **AUDIO** (13) button.
- “BASS” appears on the display.
- ⇒ Press the **>** button (10) repeatedly until “BALANCE” appears on the display.
- ⇒ Press the **∨** or **∧** button (10) to set the volume distribution left/right.
- ⇒ Press the **AUDIO** button (13) or **OK** (11) once you have completed the setting.

Setting the volume distribution front/rear (fader)

- ⇒ To set the volume distribution front/rear (fader), press the **AUDIO** (13) button.
- “BASS” appears on the display.
- ⇒ Press the **>** button (10) repeatedly until “FADER” appears on the display.
- ⇒ Press the **V** or **∧** button (10) to set the volume distribution front/rear.
- ⇒ Press the **AUDIO** button (13) or **OK** (11) once you have completed the setting.

Equalizer

This car radio is fitted with five parametric digital equalizers, which can be set individually. This means you have the means to save and request different equalizer settings for different situations (eg only driver, driver and front passenger or vehicle occupants in front and back).

“Parametric” means that for each of the five filters, **one** frequency can be individually raised or lowered (GAIN +8 to -8). The following filters are available:

- SUB LOW EQ 32 - 50 Hz
- LOW EQ 63 - 250 Hz
- MID EQ 315 - 1250 Hz
- MID/HIGH EQ 1600 - 6300 Hz
- HIGH EQ 8000 - 12500 Hz

These filters can be set without measuring equipment. This means that the sound quality inside the vehicle can be greatly influenced.

Presets for different car models (CAR PRESETS) and musical styles (SND PRESETS) can also be selected.

Notes on adjusting the equalizer

We recommend you use a CD you are familiar with when adjusting the equalizer.

Before adjusting the equalizer, set the tone and volume balance to zero. To do this, please see the chapter “Tone and volume balance”.

- ⇒ Listen to the CD.
- ⇒ Evaluate the tone impression according to your taste.
- ⇒ Now consult the chart “An aid to adjusting the equalizer” in the “Sound impression” section.

EQUALIZER

- ⇒ Set the equalizer values as described under “What to do”.

Switching the equalizer on/off

- ⇒ To switch on the equalizer, hold down the **DEQ** button (12) until EQ lights up on the display “EQ ON” is briefly displayed.
- ⇒ To switch on the equalizer, hold down the **DEQ** button (12) until EQ disappears from the display “EQ OFF” is briefly displayed.

Setting the equalizer

- ⇒ Press the **DEQ** button (12).
- ⇒ Select “DIGITAL EQ” using the **↵** or **↶** button (10).
- ⇒ Select the equalizer “USER EQ1”, “USER EQ2” or “USER EQ3”, which you would like to set by pressing the **<** or the **>** button (10).
- ⇒ Select the filter using the **↵** or **↶** button (10).
- ⇒ Press the **<** or **>** button (10).
- ⇒ To select the frequency, press the **↵** or **↶** button (10).
- ⇒ Set the level using the **<** or **>** button (10).
- ⇒ To select the next filter, first press the **OK** button (11), then the **↵** or **↶** button (10).
- ⇒ When all the settings have been selected, press the **DEQ** button (12).

Selecting sound presets

Sound presets can also be selected for the following music styles

- CLASSIC
- POP
- JAZZ
- ROCK
- TECHNO
- SPEECH

Settings for these musical styles have already been programmed.

- ⇒ Press the **DEQ** button (12).
- ⇒ Press the **↵** or **↶** button (10) repeatedly until “SND PRESETS” appears on the display.
- ⇒ Select the desired musical style by pressing the **<** or **>** button (10).
- ⇒ Press the **DEQ** button (12) or **OK** (11).

Selecting car presets

Sound presets can also be selected for the following types of vehicle.

- COMPACT
- LIMOUSINE
- VAN
- ROADSTER
- MINI
- TRUCK

Settings have already been programmed for these types of vehicle.

- ⇒ Press the **DEQ** button (12).
- ⇒ Press the **↵** or **↶** button (10) repeatedly until “CAR PRESETS” appears on the display.
- ⇒ Select the desired sound preset by pressing the **<** or **>** button (10).
- ⇒ Press the **DEQ** button (12) or **OK** (11).

Setting the level indicator

The level indicator (spectrometer) on your display briefly indicates the volume, tone and equalizer settings with symbols on your display as you make the corresponding settings.

When settings are not being made, the spectrometer indicates the original level of the car radio.

You can also set the type of spectrometer on your menu.

There are two types available.

Selecting a spectrometer type

- Press the **MENU** button (8).
“MENU” appears on the display.
- Press the **V** button (10) repeatedly until “EQ DISPLAY” appears on the display.
- Press the **<** or **>** button (10), to select between displaying “SPECTRUM 1” and “SPECTRUM 2” or “EQ DISP OFF”.
- Press the **MENU** button (8) or **OK** (11) once you have completed the setting.

Setting aid for the equalizer

Commence settings at mid and treble section and complete them in the bass section.

Sound impression/problem	What to do
Bass reproduction too weak	Raise bass with frequency: 50 to 100 Hz, level: +4 to +6
Impure bass Booming Disagreeable pressure	Reduce lower mid-section with frequency: 125 to 400 Hz, level: approx. -4
Sound very dominant, aggressive, no stereo effect	Reduce mid-section with frequency: 1,000 to 2,500 Hz, level: -4 to -6
Muffled reproduction Low transparency No instrumental brilliance	Raise tweeter range with frequency: approx. 12,600 Hz, level: +2 up to +4

External audio sources

In **addition** to the CD changer, you can also connect up a different external audio source with a line output. Such sources can be, for example, portable CD players, minidisc players or MP3 players.

If there is no CD changer connected to your unit, two external audio sources can be hooked up.

The AUX output has to be switched on in the install menu.

To connect up an external audio source, you will need an adapter cable, obtainable from any authorised Blaupunkt dealer.

Switching the AUX input on/off

⇒ Press the **MENU** button (8).

“MENU” appears on the display.

⇒ Press the **√** button (10) repeatedly until “AUX-IN-1 OFF” or “AUX-IN-1 ON” appears on the display.

For the second AUX input, a “2” will be displayed instead of a “1”. If a CD changer is connected, only input “2” will be available.

⇒ Press the **<** or **>** button (10) to switch AUX on or off.

⇒ Press the **MENU** button (8) or **OK** (11) once you have completed the setting.

Note:

When the AUX input is switched on, it can be selected using the **SRC** button (16).

Technical data

Amplifier

Output power: 4 x 26 watts sine in accordance with DIN 45 324 at 14.4V,
4 x 50 watts max. power

Tuner

Frequency ranges:

FM : 87.5 - 107,9 MHz

AM : 530 - 1 710 kHz

FM transmission range:

20 - 16 000 Hz

CD

Transmission range:

15 - 20 000 Hz

Pre-amp output

4 channels: 4 V

Input sensitivity:

AUX 1 input : 2 V / 6 kΩ

AUX 2 input : 775 mV / 10 kΩ

Tel/Navi reception : 10 V / 560 Ω

Subject to changes!

Service numbers / Numéros du service après-vente / Números de servicio / Número de serviço

Country:	Phone:	Fax:	WWW:
Germany	(D) 0180-5000225	05121-49 4002	http://www.blaupunkt.com
Austria	(A) 01-610 390	01-610 393 91	
Belgium	(B) 02-525 5454	02-525 5263	
Denmark	(DK) 44 898 360	44-898 644	
Finland	(FIN) 09-435 991	09-435 99236	
France	(F) 01-4010 7007	01-4010 7320	
Great Britain	(GB) 01-89583 8880	01-89583 8394	
Greece	(GR) 0800-550 6550	01-576 9473	
Ireland	(IRL) 01-4149400	01-4598830	
Italy	(I) 02-369 6331	02-369 6464	
Luxembourg	(L) 40 4078	40 2085	
Netherlands	(NL) 023-565 6348	023-565 6331	
Norway	(N) 66-817 000	66-817 157	
Portugal	(P) 01-2185 00144	01-2185 11111	
Spain	(E) 902-120234	916-467952	
Sweden	(S) 08-7501500	08-7501810	
Switzerland	(CH) 01-8471644	01-8471650	
Czech. Rep.	(CZ) 02-6130 0441	02-6130 0514	
Hungary	(H) 01-333 9575	01-324 8756	
Poland	(PL) 0800-118922	022-8771260	
Turkey	(TR) 0212-3350677	0212-3460040	
USA	(USA) 800-2662528	708-6817188	
Brasil (Mercosur)	(BR) +55-19 3745 2769	+55-19 3745 2773	
Malaysia (Asia Pacific)	(MAL) +604-6382 474	+604-6413 640	

Blaupunkt GmbH





Radio / CD

Casablanca CD52 Heidelberg CD52

US version

Installation instructions
Notice de montage
Instrucciones de instalación
Instruções de montagem



<http://www.blaupunkt.com>

 **BLAUPUNKT**

Download from www.Somanuals.com. All Manuals Search And Download.

  **Safety instructions**

When carrying out installation work and making connections please observe the following safety instructions:

- Disconnect the negative terminal of the battery! When doing so, please observe the vehicle manufacturer's safety instructions.
- Make sure you do not damage vehicle components when drilling any holes.
- The cross sections of the positive and negative cables must not be less than 1.5 mm².
- **Do not connect the vehicle's plug connectors to the radio!**
- You can obtain the adapter cable required for your vehicle type from any BLAUPUNKT dealer.
- Depending on the model, your vehicle may differ from the description provided here. We accept no responsibility for any damages due to incorrect installation or connection or for any consequential damages. If the information provided here is not suitable for your specific installation requirements, please contact your Blaupunkt dealer, your vehicle manufacturer or our telephone hotline.

  **Consignes de sécurité**

Respecter les consignes de sécurité suivantes pendant la durée du montage et du branchement.

- Débrancher le pôle (-) de la batterie ! Respecter les consignes de sécurité du constructeur automobile !
- Veiller à n'endommager aucune pièce du véhicule en perçant des trous.
- La section du câble (+) et (-) ne doit pas dépasser 1,5 mm².
- **Ne pas brancher les connecteurs du véhicule sur la radio !**
- Les câbles d'adaptation nécessaires pour le type de véhicule sont disponibles auprès des revendeurs BLAUPUNKT.
- En fonction du modèle, votre véhicule peut différer de cette description. Nous déclinons toute responsabilité en cas de dommages causés par des erreurs de montage ou de connexion et en cas de dommages consécutifs. Si les indications décrites ici ne s'appliquent au montage que vous voulez effectuer, adressez-vous à votre revendeur Blaupunkt, votre constructeur automobile ou notre service d'assistance téléphonique.

Normas de seguridad

Durante el montaje y la conexión es imprescindible observar las siguientes normas de seguridad.

- Desemborne el polo negativo de la batería. Observe las normas de seguridad dadas por el fabricante del vehículo.
- Al perforar agujeros, asegúrese de no dañar ninguna pieza del vehículo.
- La sección transversal del cable positivo y del cable negativo no debe ser menor de 1,5 mm².
- **¡No conecte a la radio los conectores ubicados en el vehículo!**
- Los cables adaptadores necesarios para su vehículo los encontrará en el comercio especializado en artículos de la marca BLAU-PUNKT.
- Dependiendo del modelo, es posible que su vehículo varíe un poco con respecto a la descripción aquí dada. Tenga en cuenta que no asumimos ninguna responsabilidad por los daños debidos a un montaje o conexión incorrectos ni por los daños resultantes.
Si las instrucciones aquí dadas no son aptas para el montaje en su vehículo, póngase en contacto con su proveedor de artículos Blaupunkt o con el fabricante del vehículo, o llame a nuestro teléfono de atención al cliente.

Instruções de segurança

Durante a montagem e a ligação do aparelho, queira respeitar as seguintes instruções de segurança.

- Separar o pólo negativo da bateria ! Respeitar ao mesmo tempo as instruções de segurança do fabricante do automóvel.
- Quando se procede à furagem de buracos, prestar atenção para não serem danificadas quaisquer partes do veículo.
- As secções transversais dos cabos positivo e negativo não devem ser inferiores a 1,5 mm².
- **Não ligar as fichas existentes do lado do automóvel ao auto-rádio!**
- Os cabos adaptadores necessários para o seu automóvel podem ser adquiridos nos revendedores da BLAUPUNKT.
- O seu veículo pode divergir desta descrição em função do modelo. Não assumimos qualquer responsabilidade por erros de montagem ou de ligação nem por danos daí decorrentes.
Caso as presentes instruções não sejam adequadas para a montagem no seu veículo, dirija-se ao revendedor da Blaupunkt, ao fabricante do seu veículo ou à nossa linha verde.

Supplied Mounting Hardware

Materiel de montage fourni

Ferretería de montaje
suministrada

Elementos de fixação fornecidos.

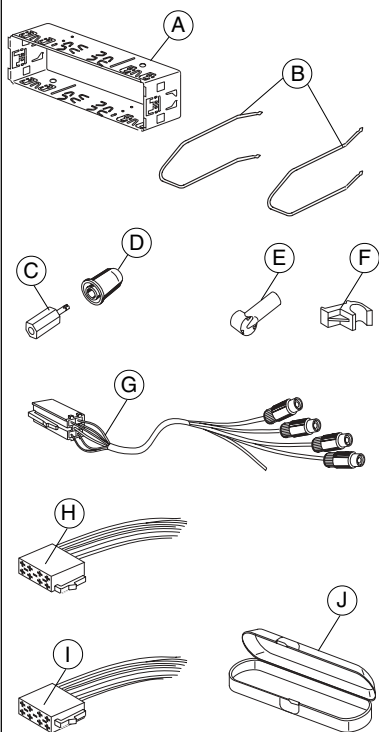

1.

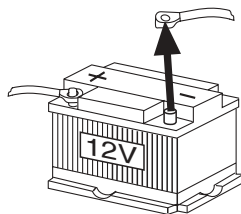

2.

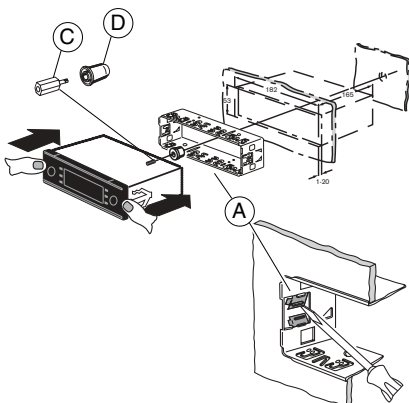

3.

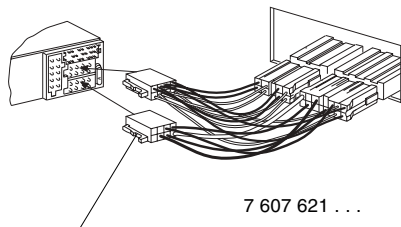

Car-specific adapter cable which is available at your dealer.

Câble adaptateur spécifique au véhicule, disponible dans le commerce.

Adaptador específico del vehículo, el cual se puede adquirir en el comercio especializado.

Cabo de adaptação específico do automóvel que pode ser adquirido no comércio especializado.

Sub out cable
7 607 609 093

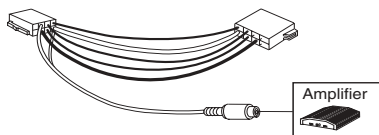

4.

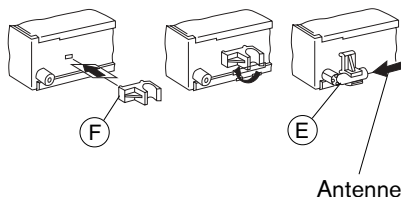

5.

uninstalling,

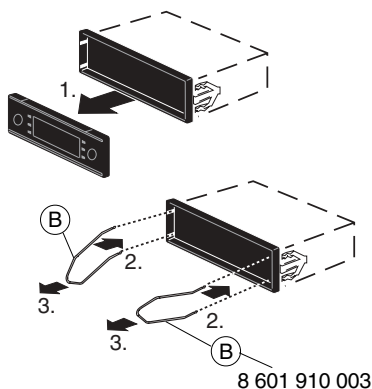

6.

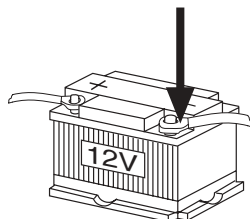

7.

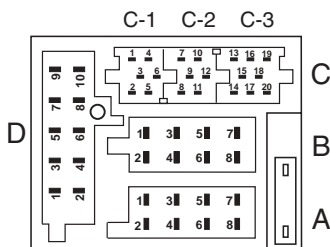

A		B	
1	Automatic Sound	1	Speaker out RR+
2	Radio Mute	2	Speaker out RR-
3	Sub out	3	Speaker out RF+
4	Permanent +12V	4	Speaker out RF-
5	Aut. antenna	5	Speaker out LF+
6	Illumination	6	Speaker out LF-
7	Kl.15/Ignition	7	Speaker out LR+
8	Ground	8	Speaker out LR-

D	
1	AUX 2- NF L
2	AUX 2- NF R
3	AUX 2- REF
4	Ext. Displ. Dat.
5	Ext. Displ. Clock
6	NC
7	NC
8	NC
9	NC

C					
C1		C2		C3	
1	Line Out LR	7	Telefon / Navi NF in +	13	Bus - In
2	Line Out RR	8	Telefon / Navi NF in -	14	Bus - Out
3	Line Out Masse / Ground	9	Radio / Navi Mute	15	Permanent +12V
4	Line Out LF	10	⚡ FB +12V / RC +12V	16	⚡ +12V
5	Line Out RF	11	Fernbedienung / Remote Control	17	Bus - Masse / GND
6	⚡ +12V Amplifier	12	FB - Masse / RC - GND	18	AF - Masse / GND
				19	Line In - L
				20	Line In - R

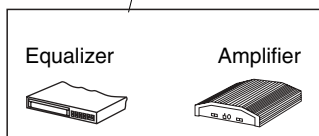

Remote
Control



Telefon NF in



CD-Changer

8.

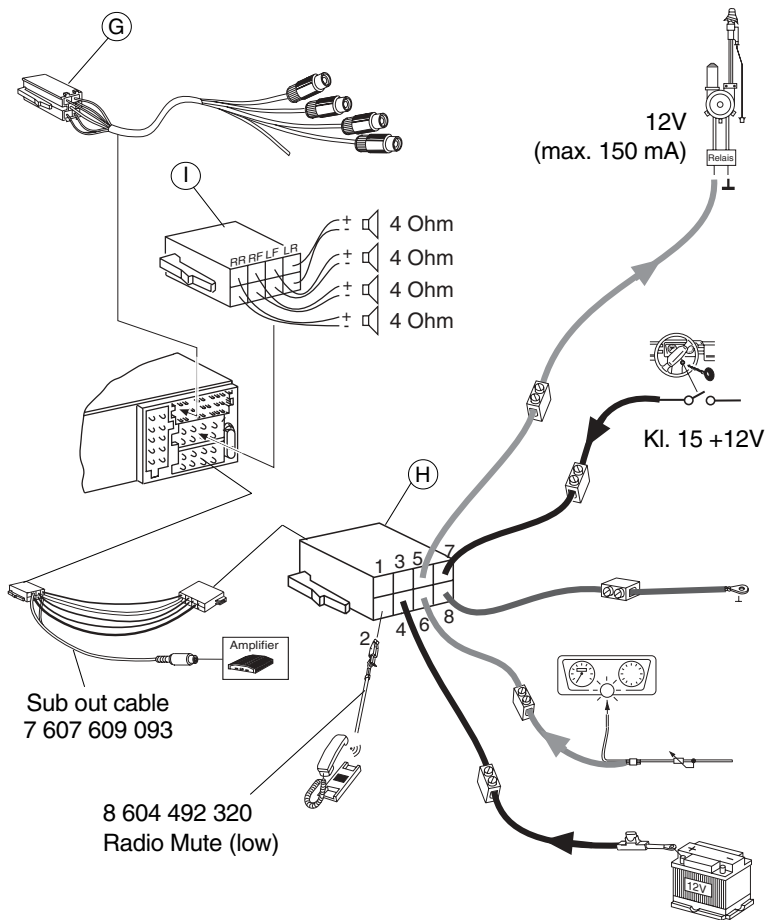

This information is subject to change without notice!

Sous réserve de modifications!

Modificaciones reservadas!

Sob reserva de alterações!

Free Manuals Download Website

<http://myh66.com>

<http://usermanuals.us>

<http://www.somanuals.com>

<http://www.4manuals.cc>

<http://www.manual-lib.com>

<http://www.404manual.com>

<http://www.luxmanual.com>

<http://aubethermostatmanual.com>

Golf course search by state

<http://golfingnear.com>

Email search by domain

<http://emailbydomain.com>

Auto manuals search

<http://auto.somanuals.com>

TV manuals search

<http://tv.somanuals.com>