

BILLY GOAT QL TRUCK LOADER VACUUM Owner's Manual

QL2300KO

Accessories

INTAKE

HOSE REPLACEMENT KIT
<i>Standard on QL units. [12"(305mm) x 10' (3.0m)]</i>
P/N 790211

EXHAUST

EXHAUST HOSE KIT
<i>[8"(203mm) x 5' (1.5m)] Quick release coupler and flexible steel hose increases exhaust distance.</i>
P/N 790114

TRAILER

TRAILER QL
<i>Heavy duty spring axle trailer designed for towing your QL. Allows unit to be mounted for pickup from rear and both sides.</i>
P/N 790112



ABOUT THIS MANUAL

THANK YOU for purchasing a BILLY GOAT® *QL Vacuum*. Your new machine has been carefully designed and manufactured to provide years of reliable and productive service. This manual provides complete operating and maintenance instructions that will help to maintain your machine in top running order. Read this manual carefully before assembling, operating, or servicing your equipment.

CONTENTS

SERIAL PLATE DATA AND SPECIFICATIONS _____	3
GENERAL SAFETY _____	4-5
SOUND AND VIBRATION _____	6
INSTRUCTION LABELS _____	7
PACKING CHECKLIST & ASSEMBLY _____	8-9
OPERATION _____	9-11
MAINTENANCE _____	12
TROUBLESHOOTING AND WARRANTY PROCEDURE _____	13
ILLUSTRATED PARTS & PARTS LISTS _____	14-15
MAINTENANCE RECORD _____	16



SERIAL PLATE DATA

Record the model number, serial number, date of purchase, and where purchased.

Purchase Date: _____

Purchased From: _____

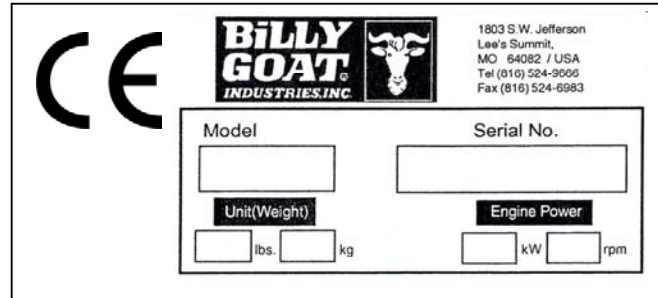

Specifications

QL2300KO

Engine: HP	23 (17.14kW)
Engine: Model	PA-76559
Engine: Type	KOHLER COMMANDER
Engine: Fuel Capacity	8qt. (7.57 L) REMOTE TANK
Engine: Oil Capacity	2.0 qt. (1.9 L), REMOTE OIL FILTER
Total Unit Weight:	399# (181.3 kg)
Max operating slope	25°
Overall Height	74" (1.82m)
Overall Width	32" (0.81m)
Overall Length	58" (1.47m)
In compliance with 2000/14/EEC standards	113 dB(a)
Sound at operators position	93 dB(a)
Vibration at operator position	0.02g

BATTERY NOT INCLUDED: REQUIRES 12 V BATTERY, 40 AH, 240 CCA MIN. U1 SERIES GROUP BATTERY FOR PROPER FIT

GENERAL SAFETY INSTRUCTIONS and SYMBOLS

The safety symbols shown below are used throughout this manual. You should become familiar with them before assembling, operating, or servicing this equipment.



WARNING: This symbol indicates important information that will prevent injury to yourself or others.



This symbol indicates ear protection is recommended when operating this equipment.



This symbol indicates eye protection is recommended when operating this equipment.



This symbol indicates gloves should be worn when servicing this equipment.



This symbol indicates that this manual and the engine manufacturer's manual should be read carefully before assembling, operation, or servicing this equipment.



CAUTION: This symbol indicates important information that will prevent damage to your BILLY GOAT[®] QL VACUUM.



This symbol indicates the engine oil level should be checked before operating this equipment.

Read and make sure you thoroughly understand the following safety precautions before assembling, operating or servicing this equipment:



READ this manual and the engine manufacturer's manual carefully before assembling, operating, or servicing this equipment.



EAR PROTECTION is recommended when operating this equipment.



EYE PROTECTION is recommended when operating this equipment.



BREATHING PROTECTION is recommended when operating this equipment.





















WARNING: **EXHAUST** from this product contains chemicals known to the State of California to cause cancer, birth defects or other reproductive harm.







DO NOT operate this equipment on any unimproved forested, brushy, or grass covered land unless a spark arrester is installed on the muffler as required by Section 4442 of the California Public Resources Code. The arrester must be maintained in good working order. Other states may have similar laws. Federal laws apply on federal lands.

DO NOT run engine in an enclosed area. Exhaust gases contain carbon monoxide, an odorless and possibly fatal poison.

**WARNING:**

-  **DO NOT** run this equipment indoors or in any poorly ventilated area. Refueling outdoors is recommended.
-  **DO NOT** refuel this equipment while the engine is running. Allow engine to cool for at least two minutes before refueling.
-  **DO NOT** store gasoline near an open flame.
-  **DO NOT** remove gas cap while engine is running.
-  **DO NOT** start or operate engine if strong odor of gasoline is present.
-  **DO NOT** start or operate engine if gasoline is spilled. Move equipment away from spill until gasoline has completely evaporated.
-  **DO NOT** smoke while filling the fuel tank.
-  **DO NOT** check for spark with spark plug or spark plug wire removed. Use an approved spark tester.
-  **DO NOT** operate engine without a muffler. Inspect muffler periodically and replace if necessary. If equipped with muffler deflector, inspect deflector periodically and replace if necessary.
-  **DO NOT** operate engine with grass, leaves or other combustible material near the muffler.
-  **DO NOT** touch muffler, cylinder, or cooling fins when hot. Contact with hot surfaces may cause severe burns.
-  **DO NOT** leave equipment unattended while in operation.
-  **DO NOT** park equipment on a steep grade or slope.
-  **DO NOT** operate equipment with bystanders in or near the work area.
-  **DO NOT** allow children to operate this equipment.
-  **DO NOT** operate equipment with guards removed.
-  **DO NOT** operate equipment near or pick up hot or burning debris or any toxic or explosive materials.
-  **DO NOT** operate equipment on slopes greater than specified in Specifications section of this manual.
-  **DO NOT** place hands or feet inside nozzle intake, near debris outlet, or near any moving parts.

**WARNING: Important**

-  **DO NOT** use this machine for vacuuming **exclusively** sand, dust, fine dirt, rock, glass, string like material, grain, rags, cans, metal, bark or water.
-  **DO NOT** start engine without hose and exhaust elbow connected firmly in place to housing and outlet.
-  **DO NOT** operate without discharging exhaust into enclosed container.
-  **DO NOT** operate with hose or exhaust elbow removed
-  **DO NOT** remove hose until engine has been turned off and has come to a complete stop.
-  **DO NOT** transport unit without elbow retention cable (item 87) assembled.
-  **DO NOT** operate this unit freestanding. Unit must be secured in place during any operation.

ALWAYS remove spark plug wire when servicing equipment to prevent accidental starting.

ALWAYS check fuel lines and fittings frequently for cracks or leaks. Replace if necessary.

ALWAYS keep hands and feet away from moving or rotating parts.

ALWAYS store fuel in approved safety containers.



SOUND

L_{wA} SOUND LEVEL 93 dB(a) at Operator Position
113 dB

Sound tests were conducted in accordance with 2000/14/EEC, and were performed on 2-14-2002 under the conditions listed below.

⚠ Sound power level listed is the highest value for any model covered in this manual. Please refer to serial plate on the unit for the sound power level for your model.

General Conditions:	Sunny
Temperature:	50°F (10°C)
Wind Speed:	15 mph (24.1 kmh)
Wind Direction:	North
Humidity:	32%
Barometric Pressure:	30.06Hg (764 mm Hg)

VIBRATION DATA

VIBRATION LEVEL 0.02g

Vibration levels at the operator's handles were measured in the vertical, lateral and longitudinal directions using calibrated vibration test equipment. Tests were performed on 5-7-98 under the conditions listed below.

General Conditions:	Sunny
Temperature:	69°F (20.6°C)
Wind Speed:	8 mph (12.8 kmh)
Wind Direction:	North
Humidity:	76%
Barometric Pressure:	29.71"Hg (755mm Hg)

INTENDED USE

INTENDED USE: This machine is designed for vacuuming leaves, grass clippings and other types of organic litter. Debris mixed with cans, bottles and small amounts of sand can be vacuumed; however, it is not this machine's primary purpose. Vacuuming cans, bottles and sand will affect the longevity of your machine.

Do not operate if excessive vibration occurs. If excessive vibration occurs, shut engine off immediately and check for damaged or worn impeller, loose impeller bolt, loose impeller key, loose engine or lodged foreign objects. Note: See parts list for proper impeller bolt torque specifications. (See trouble shooting section on page 13).

INSTRUCTION LABELS

The labels shown below were installed on your BILLY GOAT® QL Vacuum. If any labels are damaged or missing, replace them before operating this equipment. Item numbers from the Illustrated Parts List and part numbers are provided for convenience in ordering replacement labels. The correct position for each label may be determined by referring to the Figure and Item numbers shown.



LABEL DANGER KEEP HANDS AND FEET AWAY
ITEM #3 P/N 400424

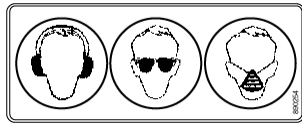

LABEL EAR EYE BREATHING
ITEM# 49 P/N 890254



LABEL WARNING SECURE
ITEM#72 P/N 790232



DANGER FLYING DEBRIS
ITEM #43 P/N 810736



LABEL READ OWNERS MANUAL
ITEM #50 P/N 830301



LABEL EXPLOSIVE FUEL
ITEM # 1 P/N 400268

LABEL QL INSTRUCT/WARN
ITEM #18 P/N 790142



LABEL SECURE NOZZLE
ITEM #42 P/N 790301



ENGINE LABELS

IMPORTANT ENGINE INFORMATION
 THIS ENGINE MEETS U.S. EPA 2004 AND CALIFORNIA 2006 AND LATER EMISSION CONTROL REGULATIONS FOR S1 SOR2
 FAMILY 1KHXS.7252GC
 DISPLAY (CC) 674
 MODEL NO. CH23S
 SPEC NO. 76559
 SERIAL NO. 3133205181
 EMISSION COMPLIANCE PERIOD:
 EPA CATEGORY A CARB: EXTENDED
 THIS ENGINE IS CERTIFIED TO OPERATE ON UNLEADED GASOLINE
 REFER TO OWNER'S MANUAL FOR SAFETY, MAINTENANCE SPECS AND ADJUSTMENTS
 FOR SALES/SERVICE IN US/CANADA, CALL:
 1-800-544-2444
 www.kohlerengines.com
KOHLER engines
 KOHLER CO. KOHLER WISCONSIN USA

KOHLER

OIL COOLER MAINTENANCE
 Oil cooler must be kept free of debris.
 Inspect and clean every 25 hours, more frequently under severe conditions.



THROTTLE CONTROLS

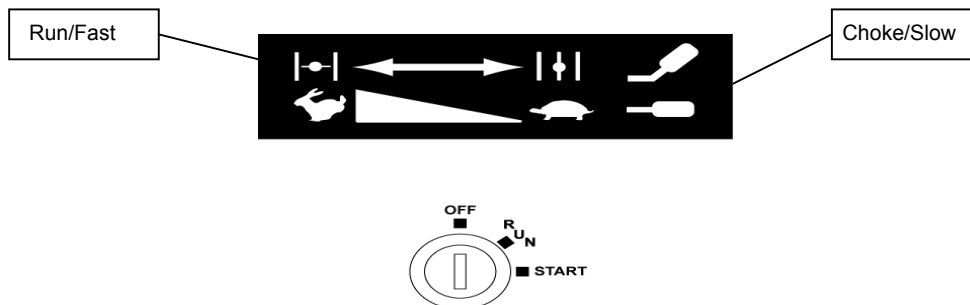



PACKING CHECKLIST

Your Billy Goat is shipped from the factory in one carton and is completely assembled except for the exhaust elbow, nozzle, handle loop for nozzle, hose booms, hose bands, hose coupler, hose clamps and related hardware.



READ all safety instructions before assembling unit.
TAKE CAUTION when removing the unit from the box.



PUT OIL IN ENGINE BEFORE STARTING

PARTS BAG & LITERATURE ASSY

Warranty card P/N- 400972, Owner's Manual P/N-790294, Declaration of Conformity P/N-790162.

Boxing Parts Checklist

- Exhaust Elbow
- Nozzle Tray Assembly
- Handle Loop Nozzle 811019
- Handle Nozzle 811020
- Hose Boom Assembly
- Nozzle QL 7901492
- Hose Clamps 12" (305mm) 790150 Qty. 2
- Band Hose Boom 12" (305mm) 790153 Qty. 2
- Hose Coupler Assy
- Hose 12"x 10' QL 791034
- Kohler command pro 23 HP
- Parts Bag & Literature Assy P/N 790297

Handle Adj. W/Grip 811019 qty. 1

Washer 5/16 Fender 8172020 qty. 4

Washer 5/16 SAE 8172008 qty. 2

Nut Lock 1/4-20 8160001 qty. 4

Nut Lock 5/16-18 8160002 qty. 4

Washer 1/4 SAE 8172007 qty. 6

Screwcap 5/16-18x 1 1/2 8041030 qty. 4

Screwcap 1/4-20x 1 1/2 8041008 qty. 2

Rod Battery Hold Down 790231 qty. 2

Bracket Battery QL 790230 qty. 1

For Mounting to a trailer

Screwcap 3/8-16x2 3/4 8041057 qty. 4

Nut Lock 3/8-16 8160003 qty. 4

Washer 3/8 FC 8171004 qty. 8



NOTE: BATTERY IS NOT INCLUDED. REQUIRES 12 V BATTERY, 40 AH, 240 CCA MIN. U1 SERIES GROUP BATTERY FOR PROPER FIT

Parts Bag Hardware

ASSEMBLY

1. **SECURELY ATTACH** unit to the bed of a truck or to a trailer, so that the exhaust discharges into an enclosed container. **NOTE:** This unit must be securely mounted to the bed of a truck or to a trailer before operating.
2. **ATTACH** hose to hose coupler, using hose clamp (item 26)
3. **ATTACH** hose coupler w/hose to housing intake, which is preassembled to housing front plate, and rotate to lock it in place.
4. **ASSEMBLE** handle loop nozzle (item 45), to nozzle handle (item 44) using capscrew (item 53), and lock nut (item 60). Adjust handle loop to desired height and angle and securely tighten in place.
5. **ASSEMBLE** nozzle handle (item 44), to nozzle (item 25), using screws (item 52), washers (item 66), washers (item 68) and lock nuts (item 60).
8. **ATTACH** assembled nozzle to hose using hose clamp (item 26). Before tightening hose clamp, position nozzle handle upward when hose is stretched to prevent twisting load on hose assembly during operation.
9. **ATTACH** preassembled hose boom on top of housing using a hitch pin (item 10).
10. **ASSEMBLE** hose band (item 29) around hose and secure chain between flanges of the hose band using capscrew (item 53) and lock nut (item 60) Repeat same steps on the other chain. (See ADJUSTING HOSE BOOM on page 11).
11. **SECURELY ATTACH** exhaust elbow (item 21) capturing both flanges inside the clamp, then firmly tighten the clamp, securing the elbow to the housing (see MOUNTING on page 10).
12. **INSTALL** a standard 12 volt lawn and garden battery "U1" series (**not included**) with at least 240 cold cranking amps and a 40 amp hour rating by using battery bracket QL (item no. 70, hold down rods (item 71), washers (item 70), and lock nuts (item 59).
13. **ATTACH** red battery cable to + terminal and black battery cable to - terminal.

OPERATION

 Like all mechanical tools, reasonable care must be used when operating machine.
Inspect machine work area and machine before operating. Make sure that all operators of this equipment are trained in general machine use and safety.
 **PUT OIL IN ENGINE BEFORE STARTING**

STARTING

SECURE LOADER OR MOUNT BEFORE STARTING

 **ENGINE:** See engine manufacturer's instructions for type and amount of oil and gasoline used. Engine must be level when checking and filling oil and gasoline.

ENGINE SPEED: Controlled by throttle lever on the vac housing. Under normal conditions, operate at minimum throttle to accomplish your current cleaning task.

INTAKE HOSE: Hose mounting assembly must be properly attached to vac housing and safety switch must be engaged before engine will start. Note: Any damage to the switch or wiring harness will prevent engine from starting.

THROTTLE: Move throttle control to fast position.

KEY SWITCH: Turn to start position until engine begins to fire, immediately release the key to the run position.



Note: Do not hold key in start position more than 10 seconds per attempt.

IF YOUR UNIT FAILS TO START: See Troubleshooting on page 13. Also see engine owner's manual.

HANDLING & TRANSPORTING:

 The unit is equipped with small front wheels to allow for easier transportation to storage. With unit removed from its mounting, tilt unit forward toward the ground and use wheels to maneuver it into storage area.

HOSE: DO NOT drag the hose with vehicle.

  Never lift the machine while the engine is running.

 **ALWAYS ATTACH NOZZLE TO THE TRAY BEFORE TRANSPORTING UNIT**

MOUNTING: Main unit

GENERAL: Unit must be securely mounted to a trailer, truck bed, or other similar surface before use. Do not use this unit in a freestanding position. Unit is not stable until it has been secured in place.

Secure unit by bolting through the base of the unit and through the mounting surface using 3/8" dia. bolts, with washers and locking nuts (see fig. 1)

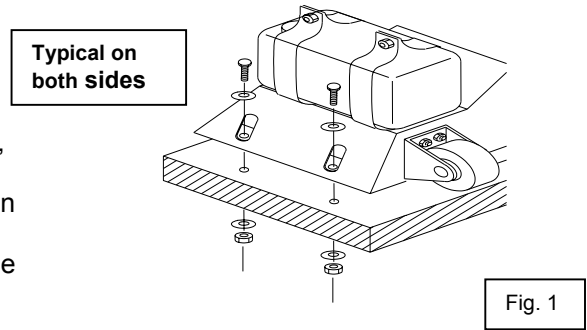

MOUNTING: Unit can be mounted in various positions. Figure 2 illustrates the mounting options available when using the optional trailer (Billy Goat Part no. 790112) available from your Billy Goat dealer. The unit can be mounted to allow vacuuming from either side as well as from the rear.

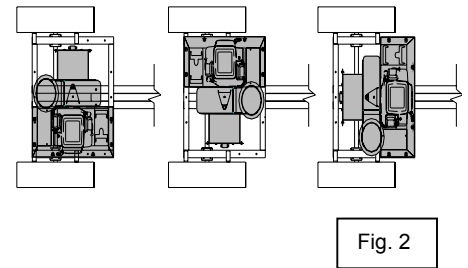

MOUNTING: Exhaust elbow

- 1) Remove the loose hardware from the clamp assembly so that there are 4 separate pieces (remaining clamp assembly, two half plates, and a plate split).
- 2) Slide the assembled plates over the housing flange. The flange should rest between the bottom plate and the plate split.
- 3) Slide the elbow over the plate spacer and center it in the clamp. The elbow flange should now be resting on the housing flange between the plate split and the top plate.
- 4) Insert the other plate split beneath the plate spacer so the holes align and the plate overlaps the flange on the elbow.
- 5) Secure the assembly with a plate half on top of the elbow flange and a plate half on bottom of the housing flange using 3, 1" carriage bolts and 3 lock nuts (removed hardware in step 1).
- 6) Tighten down the clamp with 2, 1 3/4" carriage bolts, 2 knobs, and 2 lock nuts (removed hardware in step 1).

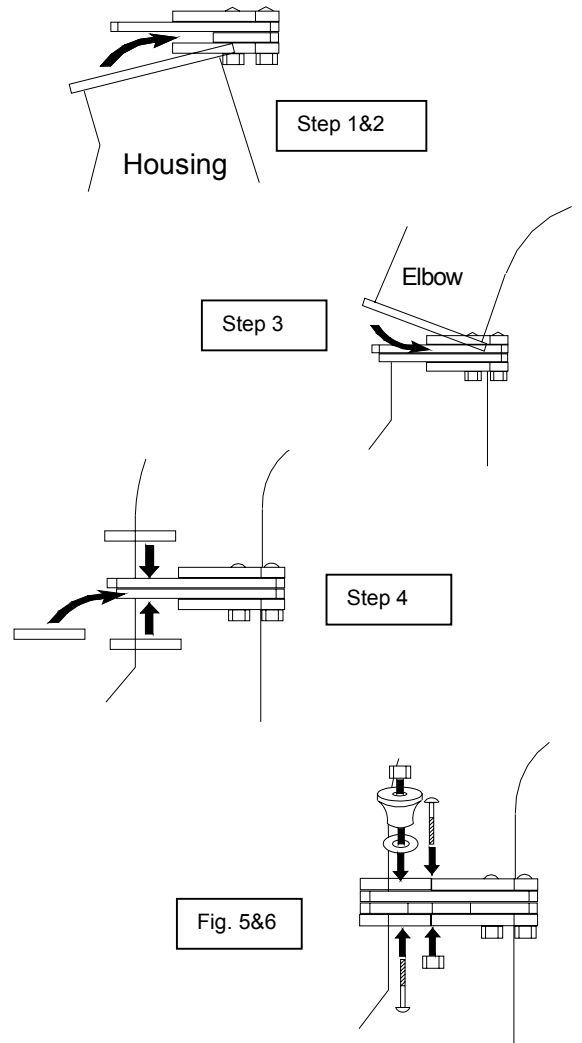

VACUUMING OPERATION

EXHAUST DIRECTION & DISTANCE: Exhaust direction and distance are controlled by the angle of the exhaust deflector and by rotation of the exhaust elbow. Adjust the angle of the exhaust deflector to control the distance that debris is discharged. Typically debris is aimed to discharge to the rear of the container. The direction of discharge is adjusted by loosening the knobs on the exhaust elbow clamp and rotating the elbow to the desired direction.

NOTE: Elbow is heavy. Use caution when adjusting. Never stand directly under the elbow while adjusting direction of exhaust.

Never adjust exhaust deflector angle or direction of discharge while unit is running. Never direct exhaust into an area where bystanders may cross the path of the debris.

INTAKE OPERATION: With machine running and fully assembled, move the nozzle in sweeping motions over debris. Always allow air to flow into the nozzle along with the debris. Do not completely block the nozzle when vacuuming, it will reduce performance, and increase clogging (See figure 3).

For removal of heavier debris, or debris that is stuck to the ground, rock nozzle forward to concentrate suction power around the debris (See figure 4).

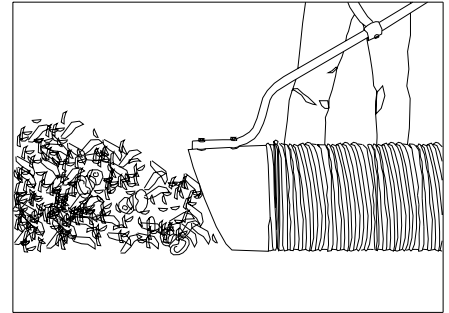

Fig. 3

ADJUSTING HOSE BOOM

Properly adjusting the boom will prevent most hose clogs from occurring and will maximize vacuum performance by keeping the hose straight and perpendicular to the housing (see fig. 5).

UNCLOGGING A CLOGGED HOSE

With engine running and unit secured to a trailer, truck bed, or other similar surface, fully stretch hose in a straight line to dislodge the clog. If the clog will not clear, turn unit off, and allow engine to come to a complete stop. Remove hose and manually clear hose clog. **NOTE:** The clogged debris may be sharp. Always wear durable gloves when removing clog.

UNCLOGGING A CLOGGED HOUSING OR EXHAUST ELBOW

Turn engine off and wait for impeller to come to a complete stop. Disconnect spark plug wires and battery cables. Remove the hose coupler from the housing and determine where the clog is located. If possible clear the clog through the intake opening. It may require removal of the intake adaptor (item 33) to allow access to clear the housing. If clog is in the elbow, carefully remove the elbow. Remove elbow by removing the knobs on the elbow clamp. Then remove 3 bolts so that the split plate can be taken out. Finally, the elbow can be removed by sliding it past the remaining attached clamp.

NOTE: Elbow is very heavy. Do not stand directly under elbow during removal.

Danger, the clog may contain sharp materials. Wearing durable gloves, clear the clog. Reconnect spark plug wire.

HOSE CARE AND TIPS

To increase hose life, periodically rotate hose and reposition nozzle and coupler on front plate of unit. This increases hose life by keeping hose from wearing only on one side.

Keep hose as straight as possible and avoid sharp bends during operation for best pick-up and to avoid clogs.

Never drag hose. Always remove and store hose before transporting unit.

Store hose straight and flat to maintain flexibility for next use.

THE HOSE IS A REPLACEABLE WEAR ITEM.

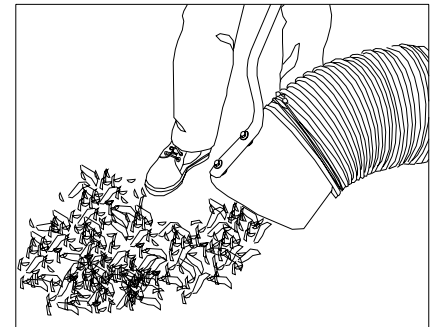

Fig. 4

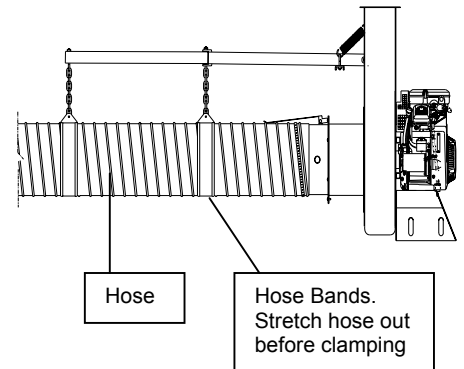

Fig. 5

STORAGE

Turn fuel supply off when unit is not in use. Never store engine indoors or in enclosed poorly ventilated areas with fuel in tank, where fuel fumes may reach an open flame, spark or pilot light, as on a furnace, water heater, clothes dryer or other gas appliance.

If engine is to be unused for 30 days or more, prepare as follows:

Be sure engine is cool. Do not smoke. Remove all gasoline from carburetor and fuel tank to prevent gum deposits from forming on these parts and causing possible malfunction of engine. Drain fuel outdoors, into an approved container, away from open flame. Run engine until fuel tank is empty and engine runs out of gasoline. **NOTE:** Fuel stabilizer (such as Sta-Bil) is an acceptable alternative in minimizing the formation of fuel gum deposits during storage. Add stabilizer to gasoline in fuel tank or storage container. Always follow mix ratio found on stabilizer container. Run engine at least 10 min. after adding stabilizer to allow it to reach the carburetor.

HOSE STORAGE: Storing hose in a covered area, out of sunlight and heat will prolong hose life. Do not store hose where it could be stepped on or where other objects could crush or damage hose.

MAINTENANCE

PERIODIC MAINTENANCE

Periodic maintenance should be performed at the following intervals:

Maintenance Operation	Every use	Every 5 hours (daily)	Every 10 Hours	Every 25 Hours
Inspect for loose, worn or damaged parts.		•		
Check engine oil and air filter	•			
Clean hose	•			
Engine (See Engine Manual)				
Inspect battery for damage or leak			•	
Keep engine free of debris	•			
Check battery terminal for corrosion				•
Check for excessive vibration		•		

IMPELLER REMOVAL

1. Wait for engine to cool and disconnect spark plugs from the both sides of the engine.
 2. Disconnect the negative battery cable (black) (item 12) from the battery.
 3. Remove the hose coupler assy from the unit (item 36).
 4. Remove the hose boom assembly.
 5. Remove the intake housing assembly (item 33) using 1/2" socket and socket wrench to remove (12) locknuts and washers (item 60 & 63). Be careful to place intake assembly to the side without putting excess strain on safety switch wire harness
 6. Remove impeller bolt and lock washer using 5/8" socket and impact wrench (see fig. 6).
 7. Once bolt is removed impeller should slide out freely. If impeller will not slide free on crankshaft, obtain a 3/4"-10 x 3" bolt and thread it into the nut that is welded onto the center of the impeller and tighten slowly to push the impeller off the crankshaft.
- Note:** 3/4"-10 x 3" bolt is included in each impeller replacement kit or the bolt can be ordered from your local Billy Goat Dealer (part no. 790214).
8. When impeller is free of the engine shaft, align impeller with the opening and pull it straight out of the housing.
 9. Using a new impeller bolt, washer, and lockwasher, reinstall new or repaired impeller in reverse order.
- Note:** Be sure spacer is in place behind impeller before tightening.
10. Tighten impeller bolt. Torque impeller bolt to [60 Ft. Lbs. (81.4 N.m)].
 11. Repeat steps 2 through 5 in reverse order.
 12. Reinstall spark plug wires.

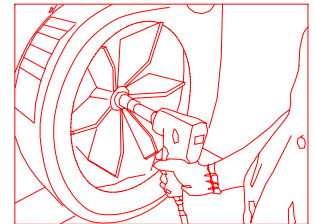

Fig. 6

INTERLOCK SYSTEM

With hose coupler installed (as shown in Fig. 8) the switch is open & engine is not grounded out, allowing engine to run.

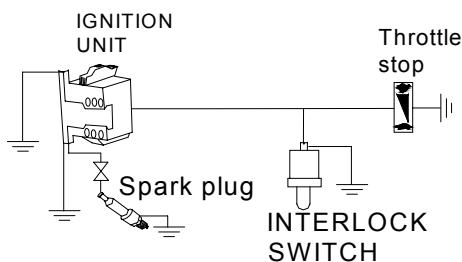
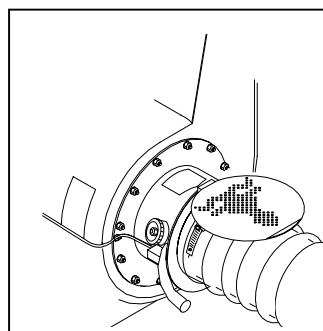

Fig. 8



Hose must be installed and switch lever must engage switch for engine to start.



Troubleshooting

Problem	Possible Cause	Solution
Abnormal vibration.	Loose or out of balance impeller or loose engine	Check impeller and replace if necessary. Check engine.
Will not vacuum or has poor vacuum performance	· Nozzle buried in debris. Clogged hose or exhaust. Excessive quantity of debris.	· Withdraw nozzle from debris pile. Unclog hose or exhaust (see pg. 11) Allow air to feed debris.
Engine will not start. (Starter does not turn)	Battery is low or dead. Battery Cable is disconnected or battery terminal is corroded. Harness wire is bad or disconnected from interlock switch. Hose not installed, allowing interlock wire to ground.	Charge battery or replace if the battery does not hold charge. Clean battery terminal and cable then reconnect. Install hose coupler securely to the unit and check whether interlock switch is engaged by lever. Check harness wire connection and replace if necessary.
Engine will not start. (Starter turns)	· Throttle & / or stop switch in off position. Out of gasoline. Bad or old gasoline. Spark plug wire disconnected. Dirty air cleaner.	· Check stop switches, throttle, and gasoline. Connect spark plug wire. Clean or replace air cleaner. Or contact a qualified service person.
Engine is locked, will not pull over.	· Debris locked against impeller. Engine problem.	· See pg.11, Clearing a clogged impeller housing. Contact an engine servicing dealer for engine problems.

When servicing engine refer to specific manufacturers engine owner's manual. Engine warranty is covered by the specific engine manufacturer. If your engine requires warranty or other repair work contact your local servicing engine dealer. When contacting a dealer for service it is a good idea to have your engine model number available for reference (See table page 3). If you cannot locate a servicing dealer in your area you can contact the manufacturers national service organization.

To reach:

KOHLER ENGINES: 800-544-2444 www.kohlerengines.com

WARRANTY CLAIM PROCEDURE

Should a BILLY GOAT[®] machine fail due to a defect in material and/or workmanship, the owner should make a warranty claim as follows:

- The machine must be taken to the dealer from whom it was purchased or to an authorized Servicing BILLY GOAT Dealer.
- The owner must present the remaining half of the Warranty Registration Card, or, if this is not available, the invoice or receipt.
- The Warranty Claim will be completed by the authorized BILLY GOAT Dealer and submitted to their respective BILLY GOAT Distributor for their territory Attention: Service Manager. Any parts replaced under warranty must be tagged and retained for 90 days. The model number and serial number of the unit must be stated in the Warranty Claim.
- The distributor service manager will sign off on the claim and submit it to BILLY GOAT for consideration.
- The Technical Service Department at BILLY GOAT will study the claim and may request parts to be returned for examination. BILLY GOAT will notify their conclusions to the distributor service manager from whom the claim was received.
- The decision by the Technical Service Department at BILLY GOAT to approve or reject a Warranty Claim is final and binding.

For online product registration go to www.billygoat.com

PARTS DRAWING QL2300KO

NOTE:
 1. BATTERY IS NOT INCLUDED.
 REQUIRES 12 V BATTERY, 40 AH,
 240 CCA MIN. U1 SERIES GROUP
 BATTERY FOR PROPER FIT
 2. BATTERY MOUNTS UNDER
 ENGINE BASE.

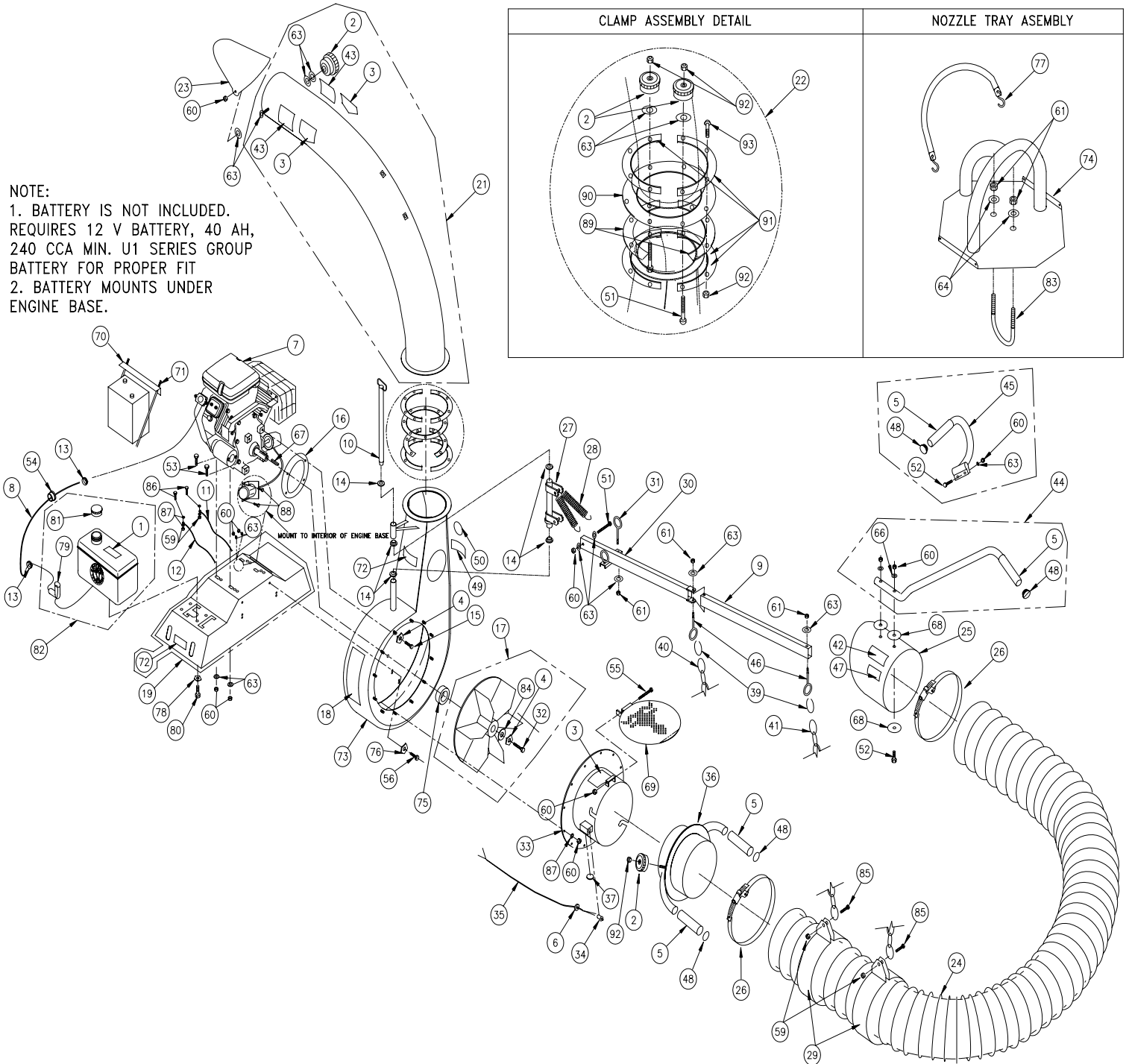



PARTS LIST

ITEM NO.	PART NO.	DESCRIPTION	QTY	ITEM NO.	PART NO.	DESCRIPTION	QTY
1	400268	LABEL HOT ENGINE	1	51	*8024044	BOLT CARRAIGE 5/16-18 x 2	2
2	400339	KNOB	4	52	*8041030	SCREWCAP 5/16-18 x 1 1/2	4
3	400424	LABEL OPEI WARNING	3	53	*8041031	SCREWCAP 5/16-18 x 1 3/4	4
4	850132	WASHER TWISTED LOCK 7/16"	5	54	790310	GROMNET 1" x 3/4" I.D.	4
5	500267	GRIP HANDLE	4	55	*8024050	BOLT CARR. 5/16 - 18 x 3 1/2	1
6	500282	STRAIN RELIEF HEYCO 1244	1	56	*8041051	SCREW CAP 3/8 - 16x 1 1/4	4
7	790275	ENGINE 23 HP HORIZ. KOHLER COMMAND PRO	1	57			
8	790129	LINE FUEL QL	1	58	*8122082	SCREW SM 1/4 x 3/4	5
9	790263	TUBE BOOM ARM QL	1	59	*8160001	NUT LOCK 1/4"-20 HEX Z/P	8
10	790271	PIN 5/8 X 15.5 QL	1	60	*8160002	NUT LOCK 5/16-18	21
11	790132	CABLE BATTERY RED 26"	1	61	*8160003	NUT LOCK 3/8	10
12	790133	CABLE BATTERY BLACK 10"	1	62			
13	790134	CLAMP FUEL LINE	2	63	*8171003	WASHER 5/16 FLAT CUT	22
14	510185	BUSHING NYLON 0.625	5	64	*8171004	WASHER FLAT 3/8	10
15	790307	SCREWCAP 7/16-14 x 2" GR. 5	4	65	*8172007	WASHER 1/4 SAE	6
16	790293	PLATE RING SPACER QL KOHLER	1	66	*8172008	WASHER 5/16 SAE	2
17	790103-S	IMPELLER 16" x 1.12" ASSY QL (INCL. 4,32,84)	1	67	*9201125	KEY 1/4 x 2 3/4	1
18	790142	LABEL QL INSTRUCT/WARN	1	68	*8172020	WASHER 5/16 FENDER	4
19	790143-S	BASE ENGINE ASSY QL(INCLUDES 72)	1	69	790298	DOOR FLAPPER INTAKE QL23	1
20				70	790230	BRACKET BATTERY QL	1
21	790145-S	ELBOW 8" ASSY QL(INCLUDES 2,3,43)	1	71	790231	ROD BATTERY HOLD DOWN	2
22	790255-S	CLAMP ASSEMBLY	1	72	790232	LABEL WARNING SECURE	3
23	790147	DEFLECTOR EXHAUST QL	1	73	790105	HOUSING ASSY QL	1
24	791034	HOSE 12" x 10'	1	74	790285	TRAY NOZZLE WA QL23KO	2
25	790149	NOZZLE INTAKE 12" FORMED	1	75	790311	SPACER - ENGINE	1
26	790150	CLAMP HOSE 12"	2	76	400502	WASHER LOCK TWISTED TOOTH	4
27	790270	BOOM HINGE WA QL	1	77	790303	BUNGEE CORD BLACK 14"	1
28	790152	SPRING BOOM QL	2	78	8177011	WASHER LOCK TWISTED TOOTH	4
29	790153	BAND HOSE BOOM 12" FORMED	2	79	790240	90 DEGREE ELBOW 1/8" NPT MALE X 1/4"	1
30	790267	ARM BOOM WA QL	1	80	*8041026	SCREWCAP 5/16-18 X 3/4 HCS ZP	4
31	790291	BOLT EYE 3/8" x 2.5"	2	81	790258	CAP TANK FUEL 3 GAL	1
32	500188	SCREWCAP 7/16-20X2" GR.8 [TORQUE 60 ft.lb. (81.4Nm)]	1	82	790259	TANK FUEL 3 GAL ASSY	1
33	790288	INTAKE HOUSING ASSY (INCL. 3,6,34,35,37,55,60,63,69)	1	83	790204	U-BOLT 3/8" -16 - X 3	1
34	890440	PLUNGE SWITCH	1	84	850443	WASHER PLATE IMPELLER	1
35	790305	HARNESS WIRE ASSY QL23 KO	1	85	8041008	SCREWCAP 1/4-20 x 1 1/2	1
36	790289	HOSE INTAKE ASSY QL (INCL. 2,38,48,92)	1	86	8041004	SCREWCAP 1/4-20 X 3/4" HCS ZP	2
37	811123	PLUG 3/4"	1	87	8171002	WASHER 1/4	14
38				88	8024040	CARRIAGE BOLT 5/16x18x1	2
39	811160	LINKGAGE 1/4" CHAIN	2	89	790254	PLATE CLAMP SPLIT	2
40	790306	CHAIN 5 LINKS	1	90	790253	PLATE CLAMP SPACER	1
41	790189	CHAIN HANG HOSE QL	1	91	790252	PLATE CLAMP HALF	4
42	790301	LABEL WARNING NOZZLE	1	92	8161041	LOCK NUT 5/16-18 THIN ZP	11
43	810736	LABEL FLYING DEBRIS	2	93	8024040	BOLT CARRIAGE 5/16-1" ZP	6
44	811020	HANDLE NOZZLE W/ GRIP	1				
45	811019	HANDLE ADJ. NOZZLE W/ GRIP	1				
46	790290	BOLT EYE 3/8" X 5"	2				
47	811215	LABEL SECURE NOZZLE	1				
48	890132	PLUG RD 1"	4				
49	890254	LABEL EAR EYE BREATHE	1				
50	890301	LABEL READ	1				

Free Manuals Download Website

<http://myh66.com>

<http://usermanuals.us>

<http://www.somanuals.com>

<http://www.4manuals.cc>

<http://www.manual-lib.com>

<http://www.404manual.com>

<http://www.luxmanual.com>

<http://aubethermostatmanual.com>

Golf course search by state

<http://golfingnear.com>

Email search by domain

<http://emailbydomain.com>

Auto manuals search

<http://auto.somanuals.com>

TV manuals search

<http://tv.somanuals.com>